



2019 SIERRA MARINE PARTS CATALOG

ENGINE & DRIVE PARTS • INSTRUMENTATION
SWITCHES • ENGINE DIAGNOSTICS
SHIELDS HOSE • OILS & LUBRICANTS
TOOLS & ACCESSORIES



THE VERY BEST PARTS OF BOATING

NO. 8033

SIERRA MARINE SERVICE TOOLS

High quality innovative tools for the marine industry that help boats spend less time in the shop and more time out on the water. Fix your next job and fix it right with solutions for engine, ignition, electrical, drive, fuel and hose. Make necessary repairs and perform crucial maintenance to your boat using the right tools...SIERRA MARINE SERVICE TOOLS.



Sierra
Marine Engine and Drive Parts

The Very Best Parts of Boating
www.sierramarine.com



Part Number	Description	OEM	OEM Part Number
18-0260	Bolt, With Washer	Yamaha	90119-08M33
18-0261	Bolt	Yamaha	97080-06045
18-0408	Plate, Outer Wear	Yamaha	65N-44323-00
18-0409	Plate, Outer Wear	Yamaha	69M-G4323-00
18-0421	Plate, Outer Wear	Yamaha	6AW-44323-00
18-0448	Gasket, Water Pump	Yamaha	6CJ-44315-00
18-0449	Gasket, Water Pump	Yamaha	6CJ-44316-00
18-0450	Gasket, Water Pump	Yamaha	6CJ-44324-00
18-0451	Gasket, Water Pump	Yamaha	6CV-44315-00
18-0452	Gasket, Water Pump	Yamaha	6AW-44315-00
18-0453	Gasket, Water Pump	Yamaha	65N-44315-A0
18-0481	Gasket, Water Pump	Honda	19234-ZW1-B00
18-0482	Gasket, Water Pump	Honda	19242-ZW1-B00
18-15139	Timing Belt, Yamaha	Yamaha	6AW-W4624-00-00
18-15140	Timing Belt, Yamaha	Yamaha	63P-46241-00-00
18-15141	Timing Belt, Yamaha	Yamaha	69J-46241-00-00
18-15142	Timing Belt, Yamaha	Yamaha	6DA-W4624-00-00
18-15143	Drive Belt, Fuel Pump	Yamaha	60V-46241-00-00
18-15144	Timing Belt, Yamaha	Yamaha	62Y-46241-00-00
18-15145	Drive Belt, Fuel Pump	Yamaha	68F-46241-10-00
18-15146	Timing Belt, Mercury	Mercury	8M0072670
18-15147	Timing Belt, Mercury	Mercury	835392Q
18-15148	Timing Belt, Mercury	Mercury	8M0065179
18-15149	Timing Belt, Mercury	Mercury	57-895120
18-15150	Timing Belt, Mercury	Mercury	57-895120002
18-1522	Relay, Trim Assembly	Yamaha	63P-81950-00
18-1523	Relay, Trim Assembly	Yamaha	61A-81950-01
18-1595	Screw M6X25	Johnson/Evinrude	353590
18-1596	Screw	Johnson/Evinrude	328725
18-1597	Screw, Housing	Johnson/Evinrude	302325
18-1800	Oil Reservoir Float Switch	Mercury	12886A6
18-1820	Seal, Water Pump	Honda	91251-ZW1-B04
18-1821	Grommet, Pump to Exhaust Housing	Johnson/Evinrude	353690
18-1822	Sleeve, Extension 25" Models	Johnson/Evinrude	354580
18-1823	Seal and Pin Assembly	Johnson/Evinrude	5007770
18-1824	Grommet, Sleeve, 20" Models	Johnson/Evinrude	349354
18-1825	Grommet	Johnson/Evinrude	340811
18-1826	Grommet, Sleeve, 25" and 30"	Johnson/Evinrude	338601
18-1827	Grommet	Johnson/Evinrude	321129
18-1828	Seal, Water Damper	Yamaha	663-44366-00
18-1836	Seal, Water Damper	Yamaha	6L2-44367-00
18-1837	Seal, Water Damper	Yamaha	6L2-44367-10
18-1838	Seal, Short 1 3/4"	Mercury	43023
18-1839	Seal, Long 2 1/4"	Mercury	8235471
18-1840	Seal, Water Damper	Yamaha	6EE-G4366-00
18-2147	Bushing, Shift Rod	Johnson/Evinrude	328754
18-2455	Assortment, Drain Plug Gasket	N/A	N/A
18-3022	Key, Impeller	Honda	90752-ZW9-A30
18-3025	Key, Impeller	Honda	90752-ZW9-A30
18-3026	Drive Key	Johnson/Evinrude	331130

Part Number	Description	OEM	OEM Part Number
18-3028	Key, Woodruff	Yamaha	6AW-44336-00
18-3472	Water Pump Repair Kit without Housing	Johnson/Evinrude	5007972
18-3473	Water Pump Repair Kit with Housing	Yamaha	6EE-W0078-00-00
18-3474	Water Pump Repair Kit without Housing	Yamaha	6CB-W0078-00-00
18-3475	Water Pump Repair Kit without Housing	Yamaha	69G-W0078-00
18-3476	Water Pump Repair Kit without Housing	Johnson/Evinrude	5007556
18-3477	Water Pump Repair Kit without Housing	Yamaha	6AW-W0078-00-00
18-3478	Water Pump Repair Kit without Housing	Honda	06192-ZW9-A30
18-3479	Water Pump Repair Kit with Housing	Yamaha	6AH-W0078-00
18-3483	Housing, Water Pump	Yamaha	6AW-44311-01-00
18-3484	Housing, Water Pump	Yamaha	6AH-44311-00-00
18-3485	Housing, Water Pump	Yamaha	6CJ-44311-00-00
18-3486	Housing, Water Pump	Yamaha	6L2-44311-01-00
18-3489	Water Pump Repair Kit without Housing	Honda	06192-ZX2-C00
18-3490	Water Pump Repair Kit without Housing	Yamaha	6BG-W0078-00-00
18-3491	Water Pump Repair Kit without Housing	Johnson/Evinrude	437907
18-3492	Water Pump Repair Kit without Housing	Honda	06192-ZW1-B01
18-3493	Water Pump Repair Kit without Housing	Honda	06192-ZW9-000
18-3494	Water Pump Repair Kit without Housing	Yamaha	6CJ-W0078-00-00
18-3633	Thermostat	Mercury	8M0090819
18-3634	Thermostat	Yamaha	6AW-12411-00-00
18-3635	Thermostat	Mercury	892864T06
18-3636	Thermostat	Yamaha	6DA-12411-01-00
18-3637	Thermostat (Pack of 2)	Yamaha	6CB-12411-10-00
18-3638	Thermostat	Mercury	804540
18-3639	Thermostat	Yamaha	6EK-12411-00-00
18-3640	Thermostat	Mercury	8M0117413
18-3641	Thermostat	Yamaha	6FP-12411-00-00
18-3642	Thermostat Kit	Mercury	855676A1
18-3643	Thermostat	Johnson/Evinrude	433379
18-43717	Dowel Pin	Yamaha	93604-10M03-00
18-4527	Water Pump Repair Kit with Housing	Yamaha	6FM-W0078-00-00
18-4529	Water Pump Repair Kit without Housing	Johnson/Evinrude	396644
18-4531	Water Pump Repair Kit without Housing	Mercury	821354A2
18-4532	Water Pump Repair Kit without Housing	Yamaha	6EG-W0078-00-00
18-4533	Water Pump Repair Kit without Housing	Yamaha	65N-W0078-A0-00
18-4534	Water Pump Repair Kit without Housing	Yamaha	69M-WG078-00-00
18-4536	Water Pump Repair Kit without Housing	Honda	06192-ZV4-A00
18-4537	Water Pump Repair Kit without Housing	Evinrude	5008972
18-4539	Impeller	Johnson/Evinrude	5008967
18-4546	Cup, Insert	Yamaha	6EE-G4322-00
18-4547	Cup, Insert	Yamaha	6EG-G4322-00
18-4548	Cup, Insert	Yamaha	6L2-44322-00
18-4549	Cup, Insert	Johnson/Evinrude	338486
18-4551	Impeller Housing Cup	Johnson/Evinrude	324641
18-4567	Housing, Water Pump	Yamaha	6EE-G4311-00
18-4568	Housing, Impeller	Johnson/Evinrude	5007554
18-4569	Housing, Impeller	Johnson/Evinrude	339720
18-4571	Housing, Impeller	Johnson/Evinrude	360347
18-4572	Plate, Outer Wear	Yamaha	6CV-44323-00

Part Number	Description	OEM	OEM Part Number
18-4573	Plate, Outer Wear	Yamaha	6EE-G4323-00
18-4574	Plate, Outer Wear	Yamaha	6EG-G4323-00
18-4576	Plate, Outer Wear	Yamaha	6FM-44323-01
18-4577	Plate, Wear	Mercury	8213542
18-4578	Impeller Hsg Plate	Johnson/Evinrude	324640
18-4579	Plate, Outer Wear	Johnson/Evinrude	338485
18-5154	Coil, Pencil	Mercury	339-880615T01
18-5701	Spring, Pressure Relief	Johnson/Evinrude	355169
18-5703	Spring, Thermostat	Johnson/Evinrude	355209
18-6742	Trim Motor	Honda	36120-ZY3-023
18-6743	Trim Motor	Honda	36120-ZY9-003
18-6744	Trim Motor	Evinrude Etec	5006319
18-6745	Trim Motor	Honda	36120-ZY6-013
18-71330	O-Ring	Yamaha	93210-05001
18-71331	O-Ring (55X)	Yamaha	93210-44704
18-71332	O-Ring	Yamaha	93210-45161
18-71333	O-Ring (620)	Yamaha	93210-49046
18-71334	O-Ring	Yamaha	93210-59MG7
18-71335	O-Ring	Honda	91301-ZG3-000
18-71336	O-ring, Impeller to Plate	Johnson/Evinrude	302035
18-71338	O-Ring, Water Tube	Johnson/Evinrude	346865
18-71340	Seal	Johnson/Evinrude	342370
18-7715	Fuel Filter	Mercury	35-892665
18-8127	Fuel Filter	PCM	RP080026
18-8406	Bolt, With Washer	Yamaha	97595-06535
18-8407	Bolt, With Washer	Yamaha	97595-06540
18-8608	E-Go Flexible Nozzle Support	All	NA
18-8609	E-Go Adapter(Throttle Body)	All	NA
18-8610	E-Go Adapter	Yamaha	0
18-8611	O2 Sensor Socket	Universal	88-823
18-8612	O2 Sensor Socket	Universal	88-836
18-8613	O2 Sensor Wrench Shielded	Universal	88-831
18-8614	O2 Sensor Wrench	Universal	88-834
18-8615	O2 Sensor Wrench	Universal	88-829
18-8616	O2 Sensor Wrench 2 1/8" Offset	Universal	88-830
18-8617	O2 Sensor wrench	Universal	88-835
18-8623	Oil Filter	Indmar	501022S
18-8779	Oil Filter	Indmar	872025
18-8904	Impeller	Johnson/Evinrude	5031417
18-8905	Kit, Impeller Repair	Evinrude	5008968
18-8906	Impeller	Johnson/Evinrude	436137
18-8907	Impeller	Johnson/Evinrude	5033542
18-9083	Cover, Water Pump Housing	Yamaha	63D-44312-00
18-9084	Cover, Impeller Housing	Johnson/Evinrude	354578
18-9089	Plate	Yamaha	6EG-G4328-00
18-9090	Plate	Yamaha	63V-44328-01
18-9091	Plate	Yamaha	69M-G4328-00
18-9092	Plate	Yamaha	6L2-44328-00
18-9554-2	15W-40 Multi-Vehicle (Qt)	Indmar	872005
18-9554-4	15W-40 Multi-Vehicle (5 Qt)	Indmar	872006

Part Number	Description	OEM	OEM Part Number
18-9554-5	15W-40 Multi-Vehicle (55 GAL)	Indmar	N/A
18-9554-7	15W-40 Multi-Vehicle (5 GAL)	Indmar	N/A
18-9555-2	5W-30 Semi-Synthetic FC-WCAT (QT)	Indmar	872003
18-9555-4	5W-30 Semi-Synthetic FC-WCAT (5QT)	Indmar	872004 (7QT)
18-9555-7	5W-30 Semi-Synthetic FC-WCAT (55 GAL)	Indmar	N/A
18-9558-2	5W-30 Full Synthetic FC-WCAT (QT)	Ilmor/MasterCraft	550022689
18-9558-4	5W-30 Full Synthetic FC-WCAT (5 QT)	Ilmor/MasterCraft	550046126
18-9558-7	5W-30 Full Synthetic FC-WCAT (55 GAL)	Ilmor/MasterCraft	N/A
18-9779	Gear Lube Pump	NA	NA
18-99127	Gasket, Thermostat	Yamaha	63P-12414-00-00
18-99153	Gasket, Water Pump	Honda	19232-ZW9-000
18-99154	Gasket, Water Pump	Honda	19234-ZX2-C00
18-99155	Gasket, Lower Water Pump	Mercury	27-822217
18-99156	Impeller Hsg Gasket	Johnson/Evinrude	325040
18-99157	Gasket, Water Pump	Yamaha	6EG-G4315-00
72-5100-2	10W-40 Full Synthetic High Performance Engine Oil - QT	Arctic Cat, Honda, Yamaha	0436-880, HP4, Yamalube Performance All Purpose 10W40
72-5100-3	10W-40 Full Synthetic High Performance Engine Oil - GAL	Arctic Cat	0436-879
72-5100-7	10W-40 Full Synthetic High Performance Engine Oil 55 - GAL		
72-5101-2	0W-40 Full Synthetic High Performance Engine Oil - QT	Arctic Cat, Can-Am	1436-434, XPS #779139
72-5101-3	0W-40 Full Synthetic High Performance Engine Oil - GAL	Arctic Cat, Can-Am	1436-435, XPS #779140
72-5101-7	0W-40 Full Synthetic High Performance Engine Oil - 55 GAL		
72-5102-2	80W-90 Semi Synthetic High Performance Hypoid Gear Oil - QT	Arctic Cat, Honda, Polaris	1436-159, 08208-0080, Angle Drive Fluid
72-5102-4	80W-90 Semi Synthetic High Performance Hypoid Gear Oil - 5 GAL	Arctic Cat, Polaris	0436-901, Angle Drive Fluid
72-5102-5	80W-90 Semi Synthetic High Performance Hypoid Gear Oil - 16 GAL	Polaris	Angle Drive Fluid
72-5102-7	80W-90 Semi Synthetic High Performance Hypoid Gear Oil - 55 GAL	Polaris	Angle Drive Fluid
72-5103-2	2 Stroke Full Synthetic High Performance Engine Oil - QT	Arctic Cat, Honda, Yamaha, Ski-Doo, Polaris, Kawasaki	4639-349, HP2, Yamalube All Performance Two Stroke, XPS 779126, VES, K61021-208A
72-5103-3	2 Stroke Full Synthetic High Performance Engine Oil - GAL	Arctic Cat, Honda, Yamaha, Ski-Doo, Polaris	5639-469, HP2, Yamalube All Performance Two Stroke, XPS 779127, VES
72-5103-4	2 Stroke Full Synthetic High Performance Engine Oil - 5 GAL	Honda, Yamaha, Polaris	HP2, Yamalube All Performance Two Stroke, VES
72-5103-5	2 Stroke Full Synthetic High Performance Engine Oil - 16 GAL	Honda, Polaris	HP2, VES
72-5103-7	2 Stroke Full Synthetic High Performance Engine Oil - 55 GAL	Honda, Polaris	HP2, VES
72-5104-2	5W-50 Full Synthetic High Performance Engine Oil - QT	Polaris	PS-4
72-5104-3	5W-50 Full Synthetic High Performance Engine Oil - GAL	Polaris	PS-4
72-5104-7	5W-50 Full Synthetic High Performance Engine Oil - 55 GAL	Polaris	PS-4
72-5105-2	Foam Filter Oil - QT		
72-5105-3	Foam Filter Oil - GAL		
72-5105-7	Foam Filter Oil - 55 GAL		

NOW AVAILABLE FROM SIERRA HIGH PERFORMANCE ATV/UTV OILS & LUBRICANTS



10W-40

FULL SYNTHETIC OIL

0W-40

FULL SYNTHETIC OIL

80W-90

SEMI-SYNTHETIC HYPOID OIL

2-STROKE

FULL SYNTHETIC OIL

5W-50

FULL SYNTHETIC OIL

FOAM FILTER OIL

**PRIME
LINE**

Powersports Service Parts

SEE PAGES 193-194 FOR COMPLETE
PRODUCT INFORMATION!



All references to Original Equipment Manufacturers, their trade names, or their part numbers are for replacement part identification only. All Sierra Marine Products are designed to meet or exceed the OEM part they are intended to replace and are backed by the best warranty in the business.

TABLE OF CONTENTS

GAUGE SECTION

Ordering Information.....	2-3	Argent Pro	8	Arctic.....	16
Eyebrow Bezels	20	Driftwood	11	Eclipse	17
GPS Speedometers.....	5	Lido Pro/Lido	9-10	Heavy Duty	18
Multi Gauges	14	Sahara	12	Senders	19
Matrix Gauges	4	Sterling	13	Sender Codes/Accessories	20-22
Premier Pro	6	Black Sterling.....	14		
White Premier Pro	7	Ameqa	15		

SIERRA SWITCH & ELECTRICAL PRODUCTS (MARINE WORKS SECTION)

Audible Engine Warning System	53	Indicator Lights	42-43	Waterproof Terminals and	
Battery Cables	57	Junction Blocks.....	51	Connectors	59
Battery Isolators	58	Lanyards	30	Solenoid Switches	57
Battery Switches.....	57	Lever Switches	57	Test Clips	60
Battery Accessories.....	57	Push Button Switches.....	44-46	Testers	54
Bus Bars/Covers.....	48-51	Push Pull Switches	43-44	Toggle Switches.....	39-42
Circuit Breakers	53	Replacement Knobs	31	Trailer Bearing Kits/Sets	58
Compartment Locks		Rocker Switches.....	32-38	Trailer Connectors	54-57
and Latches	61-62	Rotary Switches (Roto Switch®)		Adapters.....	55
Contura® Switches.....	32-35	& Accessories	31	Converters and Isolators.....	55
Cotter Pins.....	58	Solderless Terminals and		Universal (Splice-In Style)	
Docking Lights	62	Connectors.....	59-60	Trailer Connectors.....	54-57
Electrical Tools and Testers	61	Electrical Accessories.....	59-60	Heavy Duty Connectors	55
Emergency Engine		Quick Disconnects,		Polarized Connectors.....	55
Cutoff Switches	30	Butt Connectors &		Trailer Seals.....	58
Face and Boot Nuts	30, 42, 46, 53	Bullet Terminals.....	59-60	Transom Plates.....	58
Fuse Blocks	47-49	Ring, Spade and Hook		Trim Motors.....	62
Fuse Holders	51-52	Terminals.....	59-60	Trolling Motor Plugs	56
Fuse Kits.....	46-47	Terminal and Wiring			
Fuses.....	46-47	Accessory Kits	60-61		
Ignition Switches.....	23-29				
Illumination Modules.....	31				

SHIELDS MARINE HOSE SECTION

Air Conditioner.....	94-95	Exhaust Hose	72-77	Oil Hose.....	82
Bilge Hose	67-70	Exhaust Protector Valves.....	106	Potable Hose	78-81
Brass Connectors	88	Fuel Hose	82-89	Product Application Guide.....	64-66
Conduit	107-108	Gasket Material	109	Sanitation Hose	90-93
Coolant/Engine		Hose Clamps.....	106	Speedometer Pitot Tubing	109
Intake Hose.....	71-72	Hump Couplers.....	102, 104	Ventilation Hose.....	94-95
Drain Hose.....	67-70	Livewell Hose.....	67-70	Wet Exhaust Hose.....	96-105

Some of the exploded views contained in this catalog are courtesy of Seloc Publishing.

GENERATOR PARTS SECTION

FUEL 110-111 Air Filters 110 Carb Kits 110 Fuel Filters 110-111 Senders..... 111 COOLING..... 111-117 Impellers 112 Impeller Kits 112-113 Thermostats..... 114-115	Cooling (Cont.)..... Thermostat Gaskets..... 115-116 Thermostat Kits..... 116-117 IGNITION..... 117-118 Distributor Caps 117 Plug Wire Sets 118 Rotors 118 INTERNAL ENGINE.. 118-119 Oil Filters..... 118-119	OIL & LUBE 119 Oil 119 ELECTRICAL..... 119-120 Alternators/Alternator Belts..... 120 Anodes..... 120 Hourmeters 119 Solenoid 120 Starters 120 APPLICATION GUIDE .122-135
--	--	---

SIERRA MARINE SECTION

ACCESSORIES/MISCELLANEOUS 136-220

FUEL 136-161 Bowl Wrench 139-140 Carburetor to Carburetor Kit Interchange..... 157-161 Carburetors 152-156 Drain Bowls/O-Rings..... 137-139 Fuel Connectors..... 145 Fuel Filters 136-140 Fuel Hose..... 145-146, 154 Fuel Line Assemblies 141-144, 146-148 Fuel Pumps..... 149-151 Fuel Water Separators/Brackets..... 136-140 Intake Manifolds 152 International Fuel Products... 146-148 Primer Bulbs 140,146 Gas Filled Lift Supports and Accessories (Nautalift™) 203-204	IGNITION..... 162-181 Distributors 162-165 Distributor Parts 165-166 Spark Plug Wire Sets..... 171-181 OIL FILTERS 182-184 Quick-Reference Guide ..1147-1170 Alpha Cross Reference 1171-1173 OIL & LUBE 185-200 Engine Care Products..... 196-202 Engine Oil 186-194 Fluid Dispensers 200 Fuel Injection Cleaning 199 Gear Lube 196 Gear Lube Capacity Charts1174-1179 Oil Change Kits 197-198 Oil Cross Ref. Charts 192 Oil Display Rack..... 185 Oil Drain Kits 197 Hydro Defense Marine Grease .. 197	TOOLS & SHOP SUPPLIES 197-220 Clamp Assortments 202 Degreasers 199 Engine Flushers 202 Fuel Tester 198 Fuel Inj. Cleaners/Boosters..... 199 Fuel Injector Cleaning Kit..... 199 Gear Lube Adapters..... 200 Grease Guns..... 200-201 Loctite® Products..... 201-202 Manuals, Seloc 213-215 Oil Extractors 200 Oil Filter Wrenches..... 200 Oil Pads..... 200 STATS 216-220 Sanitation System Cleaner 199 Safe-Skeg 213 Testers 210-212 Tools..... 199-203, 205-212
--	---	---

CHRIS-CRAFT® 560-571

COOLING 569-571 Manifolds & Related Product 569-571 ELECTRICAL..... 565-566 Battery Cables 565 Solenoids 565 Starters 565 Voltage Regulators..... 565 FUEL 566-568 Carburetor Kits..... 566-567 Exhaust Protector Valves 568	Fuel (Cont.) Floats 566 Freeze Plugs 568 Fuel Hose..... 567 Fuel Pumps..... 567 Fuel Water Separators/Brackets136-140, 568 IGNITION..... 560-565 Contact Sets 560-561 Coils 564 Condensers..... 561 Conversion Kits..... 562-563	Ignition (Cont.)..... Distributor Caps 561 Distributors..... 563-564 Ignition Module..... 564 Multi Meter/DVA Tester..... 563 Rotors 561 Spark Plug Wire/Sets..... 562 Tune-Up Kits 560, 562 INTERNAL ENGINE..... 571 Gaskets..... 571 Head Gaskets 571 Oil Filters..... 571
---	---	---

CHRYSLER/FORCE® 221-239

COOLING 229-232

Impellers/Repair Kits 229-230
 Thermostats 229

DRIVE..... 236-239

Gear Bearings 239
 O-Rings 239
 Oil Seals 239
 Prop Nut Kits 238
 Seal Kits 236-237
 Trailing Sticks 239

ELECTRICAL..... 224-225

Starters 224
 Trim & Tilt Motors 224
 Voltage Regulators 224

FUEL 225-229

Carburetor Kits and
 Related Products 225
 Fuel Connectors 229
 Fuel Line Assemblies 229
 Fuel Pump Kits 225
 Fuel Water
 Separators/Brackets. 136-140, 228
 Primer Bulbs 229

IGNITION..... 221-223

Battery Cables 223
 Coils 221
 Condensers 221
 Contact Sets 221
 Ignition Wire 223

Ignition (Cont.)

Solenoids 221
 Spark Plug Boots 223
 Spark Plug Wires/Sets 223
 Strators/Kits 221
 Switch Boxes 221
 Tune-Up Kits 221

INTERNAL ENGINE.. 233-236

Bearing Carriers 236
 Gaskets/Sets 233-236
 Head Gaskets 234-235
 Pistons/Rings 233

CHRYSLER INBOARD® 572-588

COOLING 578-588

Exhaust Protector Valves 579
 Exploded Views 580-585
 Impellers/Kits 579
 Manifolds &
 Related Product 586-588
 Thermostats 578
 Water Pumps 579

ELECTRICAL..... 576-577

Alternators 577
 Battery Cables 576
 Solenoids 576
 Starters 577
 Voltage Regulators 576-577

FUEL 577-578

Carburetor Kits and
 Related Products 577
 Flame Arrestors 578
 Fuel Hose 578
 Fuel Pumps 578
 Fuel Water
 Separators/Brackets 136-140, 578

IGNITION..... 572-576

Coils 574
 Condensers 572
 Contact Sets 572
 Conversion Kits 573-574
 Distributor Caps 572

Ignition (Cont.)

Distributors 573
 Rotors 572
 Spark Plug Wires/Kits 573
 Tune-Up Kits 572-573

INTERNAL ENGINE..... 579

Gaskets 579
 Oil Filters 579

CRUSADER® 589-612

COOLING 600-611

Exhaust Protector Valves 601
 Exploded Views 602-606
 Impellers/Repair Kits 600-601
 Manifolds &
 Related Product 607-611
 Senders 601
 Thermostats/Kits 601
 Water Pumps 601

ELECTRICAL..... 597-598

Solenoids 597
 Starter Brush Set 597
 Starters 597
 Voltage Regulators 598

FUEL 598-600

Carburetor Kits and
 Related Products 598-599
 Carburetors 598
 Flame Arrestors 599
 Fuel Hose 599
 Fuel Pumps 599-600
 Fuel Water
 Separators/Brackets..136-140, 600

IGNITION..... 589-597

Coils 596
 Condensers 591
 Contact Sets 591
 Conversion Kits 593-594
 Distributor Caps 592-593

Ignition (Cont.)

Ignition Modules 596
 Distributors/Parts 595-596
 Rotors 591-592
 Spark Plug Wires/Kits 594-595
 Tune-Up Kits 589-590

INTERNAL ENGINE..... 612

Gasket Sets/Gaskets 612
 Head Gaskets 612
 Oil Filters 612

MODEL IDENTIFICATION CHART 589

DIESEL 661-673

HIGH PERFORMANCE PRODUCTS 644-648

HONDA® 240-250

COOLING..... 243-248 Gaskets..... 247-248 Impellers/Repair Kits..... 244-245 Thermostats..... 243-244	ELECTRICAL..... 240-241 Starters..... 240-241 Tilt/Trim Motors..... 241 Wiring Harness..... 241	IGNITION..... 240 Camshaft Sensors..... 243 Coils..... 240 Spark Plug Wire/Kits/Boots..... 240
DRIVE..... 249-250 Anodes..... 249-250 Oil Seals..... 250 Seal Kits..... 250 Prop Nut Kits..... 250	FUEL..... 241-242 Fuel Connectors..... 242 Fuel Filters/Kits..... 136-140, 242 Fuel Line Assemblies..... 242 Primer Bulbs..... 242	INTERNAL ENGINE.. 248-249 Bearings..... 249 Oil Filters..... 249
		MODEL IDENTIFICATION CHART..... 240

INBOARD ACCESSORIES 555-559

Anodes..... 559 Flywheel Bell Housing..... 558 Impellers/Kits..... 555-558	Packing..... 559 Seals & Seats..... 558 Transmission Oil Coolers..... 558	Transmission Repair Kits..... 559 Water Pumps..... 557 Water Pump Gaskets..... 558
--	---	--

INDMAR® 613-616

INTERNAL ENGINE COMPONENTS 649-660

JABSCO® 555-556

JOHNSON/EVINRUDE® 251-353

COOLING..... 276-291 Exploded Views..... 290 Impellers/Kits..... 276-277, 279-280 Thermostats/Kits..... 289 Water Pump Housings/Kits..... 279-285	ELECTRICAL..... 260-267 Rectifiers/Regulators..... 263 Solenoids..... 261 Starters..... 265-266 Stators..... 260 Tilt/Trim Motors..... 260-261	Ignition (Cont.) Coils..... 253 Power Packs..... 255-257 Spark Plug Wires/Kits..... 258-259 Switches..... 259-260 Tune-Up Kits..... 252
DRIVE..... 318-343 Anodes..... 343 Bearings..... 331-332 Drive Shafts..... 334 Exploded Views..... 318-327 Gears/Sets..... 336-337 Lower Gearcase Assemblies... 328 Oil Seals..... 347 O-Rings..... 350 Prop Nuts/Kits..... 329 Prop Shafts..... 335 Seal Kits..... 343-346 Shims..... 341 Spacers/Washers..... 329-331 Throttle Cables..... 341 Trailing Sticks..... 337	FUEL..... 267-276 Carburetor Kits and Related Products..... 267-272 Clamp Assortment..... 276 Fuel Connectors..... 275 Fuel Filters..... 274 Fuel Hose..... 275 Fuel Line Assemblies..... 275 Fuel Pumps/Kits..... 270-272 Fuel Water Separators/ Brackets..... 272-273 Primer Bulbs..... 275	INTERNAL ENGINE.. 292-300 Bearings/Kits..... 295-296 Connecting Rods..... 295 Crankshaft Seal Kits..... 300 Gaskets/Sets..... 301-316 Head Gaskets..... 306-307 Hose..... 301 Oil Filters..... 301 Pistons/Rings..... 292-294 Stainless Steel Bolts..... 309
		MODEL IDENTIFICATION CHART..... 251-252
		STARTER SYSTEM..... 316 Rewind Springs..... 316 Starter Pawls..... 316 Starter Rope..... 316

JOHNSON PUMP® 556-557

Some of the exploded views contained in this catalog are courtesy of Seloc Publishing.

MALLORY® 996-997

MARINE POWER® 617-618

MCCULLOCH/SCOTT-ATWATER® 354

MERCUISER® 674-861

COOLING.....734-789

- Exploded Views.. **738-739, 763-775**
- Impellers/Kits **734, 736**
- Manifolds and
Related Products **776-789**
- Molded Hose..... **752-755**
- Oil/Temperature Senders **751**
- Pulleys **734**
- Serpentine Belts **762**
- Thermostat Housings..... **741**
- Thermostats/Kits..... **740-741**
- V-Belts..... **756-761**
- Water Pumps/Kits **736-737**
- Water Circulating Pumps **734**

DRIVE.....814-861

- Anodes..... **853-854**
- Bearings/Kits..... **840-846**
- Bellows..... **834**
- Carrier Bearings..... **842-843**
- Drive Shafts **832, 842**
- Engine Couplers **837**
- Exhaust Protector Valves **856**
- Exploded Views..... **816-825**
- Gear Housing Assemblies.. **826-827**
- Gears/Sets..... **828-830, 840-841**
- Gimbal Bearings **831**
- Lower Gear Cases **826-827**
- O-Rings..... **858**
- Oil Seals..... **857**
- Outdrive Gasket Sets..... **814**
- Pivot Pins **852**

Drive (Cont.).....

- Power Trim Cylinders/Kits .. **850-851**
- Power Trim Hoses **847-849**
- Prop Nuts/Kits **847**
- Prop Shafts **841**
- Seal Kits..... **854-855**
- Shift Cables/Kits..... **835-836**
- Shift Spool Assemblies **842**
- Shims/Kits **826**
- Transom Seal/Kits **833-834**
- U-Joints..... **830**
- Upper Gear Cases **827**
- Upper Units/Kits **827-830**
- Yokes/Yoke Assemblies..... **830**

ELECTRICAL.....696-708

- Alternators **702-704**
- Solenoids **700-701**
- Starters **696-699**
- Trim/Tilt Motors **701-702**
- Voltage Regulators..... **704**

FUEL709-733

- Carburetor Kits and
Related Product **719-721**
- Carburetors **714-715**
- Electrical Fuel Pumps **724-725**
- Flame Arrestors **724**
- Fuel Filters **733**
- Fuel Hose..... **719**
- Fuel Water Separators/
Brackets **730-732**

Fuel (Cont.)

- Fuel Injection Components.. **709-713**
- Mechanical Fuel Pumps.... **724-730**

IGNITION.....676-696

- Coils **679-680**
- Condensers..... **678**
- Contact Sets **677**
- Conversion Kits..... **681**
- Distributor Caps **678-679**
- Distributors **682-685**
- Ignition Modules..... **680**
- Rotors **678**
- Spark Plug Wires/Kits **693-696**
- Tune-Up Kits **676-677**

INTERNAL ENGINE..790-813

- Bearings..... **795-800**
- Crankshaft/Timing
Cover Seals..... **800**
- Cylinder Head Assemblies..... **790**
- Gaskets/Sets..... **802-812**
- Head Gaskets **807**
- Hydraulic Lifters **791**
- Modular Gasket Sets **653-660**
- Oil Filters..... **790**
- Oil Pans..... **790**
- Pistons/Rings..... **791-795**
- Valve Stem Seals **800**

**MODEL IDENTIFICATION
CHART674-675**

MERCURY/MARINER® 355-454

COOLING.....390-402

- Impellers/Repair Kits..... **392-395**
- Thermostats/Kits..... **390-391**
- Water Pump
Housings/Kits..... **393-398**

DRIVE.....426-454

- Anodes..... **440-441**
- Bearings/Kits..... **432-435**
- Clutches **436-437**
- Drive Shafts **436**
- Exploded Views..... **426-431**
- Gearcases/Housings..... **437**
- Gears/Sets **436-437**
- Manual Release Valve..... **363**
- Oil Seals..... **446**
- O-Rings..... **449**
- Power Trim Hoses **439**
- Prop Nuts/Kits **439**
- Prop Shafts **436**
- Seal Kits..... **441-444**
- Spanner Nuts/Washers **438**

ELECTRICAL.....363-376

- Alternators **372**
- Relays **369**
- Serpentine Belts **372**
- Solenoids **368-369**
- Starters **372-374**
- Stators..... **365-366**
- Tilt/Trim Motors **364-365**
- Trigger Assemblies..... **366**
- Voltage Regulators..... **368**

FUEL377-390

- Air Filters..... **390**
- Carburetor Kits and
Related Products **377-378**
- Fuel Connectors..... **385-386**
- Fuel Filters **389-390**
- Fuel Line Assemblies..... **384-385**
- Fuel Pumps/Kits..... **382**
- Fuel Water Separators/
Brackets **387-389**
- Primer Bulbs **385-386**

IGNITION.....355-363

- Condensers..... **357**
- Contact Sets **356-357**
- Coils..... **358**
- Spark Plug Wires/Kits **362-363**
- Switch Boxes..... **358-359**
- Switches..... **363**
- Tune-Up Kits **356**

INTERNAL ENGINE..403-425

- Bearings..... **406-407**
- Gasket/Sets **412-425**
- Motor Mounts..... **411**
- Oil Filters..... **411**
- Pistons/Rings..... **403-406**
- Timing Belts **411**

**MODEL IDENTIFICATION
CHART355-356**

STARTER SYSTEM376

- Rewind Springs/Rope **376**

NISSAN/TOHATSU® 455-459

OBERDORFER® 557-558

OMC STERNDRIVE/COBRA® 862-935

COOLING.....887-901
 Exploded Views..... **894-896**
 Impellers/Kits **888, 891**
 Manifolds and
 Related Products **897-901**
 Molded Hose..... **892**
 Temperature Senders **891**
 Thermostats/Kits **891-892**
 V-Belts..... **893**
 Water Circulating Pumps **887**
 Water Pump Housings/Kits .. **890-891**

DRIVE.....912-935
 Anodes..... **926-927**
 Bearing Housings..... **924**
 Bearings..... **920**
 Bellows /Kits..... **918-919**
 Carrier Bearings..... **920, 923**
 Drive Shafts **921-922**
 Engine Couplers **919**
 Exploded Views..... **912-913**
 Gear Housings..... **914**
 Gears/Sets **922**
 Gimbal Bearings **914**
 Oil Seals..... **931**
 O-Rings..... **933**
 Prop Nuts/Kits **925**
 Prop Shafts **922**
 Seal Kits..... **926, 928-930**

Drive (Cont.).....
 Shafts..... **925**
 Shims **914**
 Shift Rods **924**
 Trailing Clips **925**
 Transom Seals/Kits ... **918-919, 930**
 U-Joints..... **915**
 Yoke Assemblies **915**

ELECTRICAL.....873-878
 Alternators/Rebuild Kits **877**
 Relays **878**
 Solenoids **875**
 Starters **873-874**
 Tilt/Trim Motors **878**
 Voltage Regulators..... **877**

ENGINE MANAGEMENT .887
 Oil Pressure Light Switch..... **887**

FUEL878-887
 Carburetor Kits and
 Related Products **880-882**
 Carburetors **879**
 Flame Arrestors **884**
 Fuel Filters **886-886**
 Fuel Hose..... **883**
 Fuel Injection Components **878**
 Fuel Pumps..... **883-884**
 Fuel Water Separators/
 Brackets **884-886**

Fuel (Cont.)
 Hose Barbs **887**

IGNITION.....862-873
 Coils..... **865**
 Condensers..... **863**
 Contact Sets **863**
 Conversion Kits **866-867**
 Distributor Caps **864**
 Distributors **867-869**
 Ignition Modules..... **864**
 Rotors **863-864**
 Spark Plug Wires/Kits **872-873**
 Tune-Up Kits **862-863**

INTERNAL ENGINE..902-911
 Bearings..... **904**
 Crankshaft/Timing
 Cover Seals..... **904**
 Cylinder Head Assemblies..... **902**
 Drain Screws..... **911**
 Gaskets/Sets..... **905-911**
 Head Gaskets **907**
 Hydraulic Lifters **903**
 Modular Gasket Sets **653-660**
 Oil Filters..... **902**
 Pistons/Rings **903**
 Valve Stem Seals..... **911**

PERSONAL WATER CRAFT® 551-554

PLEASURECRAFT® 619-632

COOLING.....628-632
 Exploded Views..... **629**
 Impellers/Kits **628**
 Manifolds and
 Related Products **630-631**
 Thermostats/Kits **628**
 Water Pumps **628**

DRIVE.....632
 Power Trim Hoses **632**
 Prop Nuts/Kits **632**

ELECTRICAL.....625-626
 Alternators **626**
 Solenoids **626**
 Starters **625-626**

FUEL626-628
 Carburetor Kits and
 Related Products **627**
 Float..... **626**
 Fuel Filters **628**
 Fuel Pumps..... **628**
 Fuel Water
 Separators/Brackets..... **627**
 Sensors..... **627**

IGNITION.....619-625
 Coils..... **624-625**
 Condensers..... **620**
 Contact Sets **620**
 Conversion Kits **621-622**
 Distributor Caps **620-621**

Ignition (Cont.)
 Distributors..... **622-623**
 Rotors **620**
 Spark Plug Wires/Kits **623-624**
 Tune-Up Kits **619-620**

INTERNAL ENGINE..631-632
 Gaskets/Sets..... **631**
 Head Gaskets **632**
 Oil Filters..... **632**
 Pipe Plugs..... **631**

**MODEL IDENTIFICATION
 CHART619**

PRESTOLITE® 998

SHERWOOD PUMP® 557-558

SUZUKI® 460-472

COOLING..... 464-467

- Impellers/Kits 464-466
- Thermostat Gaskets..... 467
- Water Pump Gaskets/Kits . 466-467

DRIVE..... 470-472

- Anodes..... 470
- Lower Unit Seal Kits..... 470-472
- O-Rings..... 472
- Oil Seals..... 472
- Prop Nuts/Kits 470

ELECTRICAL..... 461-462

- Starters 461
- Tilt/Trim Motors 462

FUEL 462-464

- Carburetor Kits 462-463
- Fuel Connectors..... 464
- Fuel Water
Separators/Brackets..... 463
- Oxygen Sensor 463
- Primer Bulbs 464

IGNITION..... 460

- Spark Plug Wires/Kits 460

INTERNAL ENGINE.. 468-469

- Bearings..... 468
- Connecting Rods/Kits 468
- Gaskets 468-469
- Head Gaskets 468-469
- Oil Filters..... 469
- Pistons/Rings 468

**MODEL IDENTIFICATION
CHART 460**

UNIVERSAL 633-643

COOLING..... 636-643

- Exploded Views..... 636-641
- Manifolds and
Related Products 642-643

ELECTRICAL..... 634-635

- Alternators 634
- Solenoids 634

FUEL 635

- Carburetor Kits..... 635
- Fuel Water Separators 635
- Fuel Hose..... 635

IGNITION..... 633-634

- Coils/Leads 634
- Condensers..... 633

Ignition (Cont.).....

- Contact Sets 633
- Distributor Caps 633
- Rotors 633-633
- Tune-Up Kits 633

VOLVO-PENTA® 936-993

COOLING..... 963-975

- Exploded Views..... 967-968
- Gaskets/Sets..... 970-972
- Hose..... 966
- Impellers/Kits 964-965
- Manifolds and
Related Products 969-972
- Molded Hose..... 973
- Thermostats/Kits..... 973-974
- V-Belts..... 966
- Water Pump Kits 964-965
- Water Pumps 963

DRIVE..... 987-993

- Anodes..... 991-992
- Bellows/Kits..... 988, 992
- Engine Couplers 987
- Exhaust Hose..... 988
- Gimbal Bearings 989
- O-Rings..... 993
- Oil Seals..... 993
- Power Trim Hoses 987
- Prop Nuts/Kits 990
- Seal Kits..... 992-993
- Trailer Clips 988
- U-Joints..... 989
- Yokes..... 989

ELECTRICAL..... 951-956

- Alternators 952-953
- Relays 955
- Solenoids 954
- Starters 951-952
- Tilt/Trim Motors 955-956

**ENGINE APPLICATION
GUIDE 936-938**

ENGINE MANAGEMENT . 962

- Oil Pressure Light Switch..... 962

FUEL 956-963

- Air Filters..... 962
- Carburetor Kits and
Related Product 956-957
- Carburetors 956
- Electrical Fuel Pumps 958
- Fuel Filters 960-962
- Fuel Hose..... 957
- Fuel Water Separators/
Brackets 959-960
- Mechanical Fuel Pumps..... 958
- Sensors..... 962

IGNITION..... 936-951

- Camshaft Sensor 941

Ignition (Cont.).....

- Coils 941
- Condensers..... 939
- Contact Sets 939
- Conversion Kits 942-943
- Crankshaft Sensor 941
- Distributor Caps 940-941
- Distributors..... 942-943
- Rotors 939-940
- Spark Plug Wires/Kits 944-946
- Tune-Up Kits 939

INTERNAL ENGINE.. 976-987

- Air Filters..... 977
- Bearings..... 980
- Belts 976
- Camshafts/Kits..... 976
- Cylinder Head Assemblies..... 978
- Expansion Plugs 977
- Gaskets/Sets..... 981-987
- Head Gaskets 981-983
- Hydraulic Lifters 979
- Modular Gasket Sets 653-660
- Oil Filters..... 977
- Pistons/Rings 979
- Power Steering Pump Pulley ... 976
- Valves..... 976
- Valve Lifters..... 976
- Valve Stem Seals..... 980

YAMAHA® 473-550

COOLING.....495-514
 Impellers/Kits 495-496
 Thermostats/Kits..... 510-511
 Water Pump Housing/Kits.. 496-505

ELECTRICAL..... 477-482
 Brush Holder Assemblies..... 481
 Starters 477-478
 Tilt/Trim Motors 481-482

IGNITION.....473-477
 CDIs/Assemblies..... 473-474
 Coils..... 473-474
 Ignition Switches..... 475
 Spark Plug Wires/Kits 474

DRIVE.....532-550
 Anodes..... 533
 Carrier Bearings..... 532
 Exploded Views..... 536-545
 O-Rings..... 550
 Oil Seals..... 550
 Prop Nuts/Kits 533-534
 Prop Shafts 532
 Seal Kits..... 546-549

FUEL482-495
 Carburetor Kits and
 Related Products 482-484
 Fuel Connectors..... 494-495
 Fuel Filters 490-493
 Fuel Line Assemblies..... 494
 Fuel Pump Diaphragms/Kits... 487-488
 Fuel Pumps..... 487
 Fuel Water Separators/
 Brackets 489-490
 Primer Bulbs 494

INTERNAL ENGINE.. 515-532
 Bearings/Kits..... 516
 Connecting Rods/Kits 516
 Gaskets/Sets..... 518-532
 Head Gaskets 521
 Oil Filters..... 516-517
 Timing Belts 517
 Pistons/Rings..... 515-516
**MODEL IDENTIFICATION
 CHART 473**

YAMAHA STERNDRIVE® 994-995

INTERCHANGE SECTION

Gear Lube Capacity Charts. 1174-1179
 Oil Filter Quick-Reference ... 1147-1170
 Carburetor to Carburetor Kit
 Interchange..... 157-161
 Competitive Interchange.... 1011-1029
 Mallory Distributor Parts
 Guide 996-997

Original Equipment Part No.
 Interchange Guide..... 1030-1075
 Outboard Model to Year to
 Horsepower Guide..... 999-1010
 Part Number to Page Number Guide
 Electrical Products..... 1077-1079
 Gauges 1076

Part Number to Page Number Guide (Cont.)
 Generator Parts 1080
 Shields 1079
 Sierra 1080-1145
 Prestolite Distributor Parts Guide.... 998
 Sierra Oil Cross-Reference..... 192





	Premier Pro	White Premier Pro	Driftwood	Lido	Lido Pro	Argent Pro
Fuel Gauge	2" 62718P	2" 62551P	2" 61549P	2" 65496P	2" 59655P	2" 65524P
Hourmeter 10,000 hrs (non-Illuminated)	2" 62719P	2" 62538P	2" 62952P	2" 65497P	2" 59416P	
Oil Pressure Gauge (SW) 0-80 PSI	2" 62720P	2" 62542P	2" 61550P	2" 65501P	2" 59653P	2" 65526P
Oil Pressure Gauge (SW) 0-100 PSI		2" 62543P		2" 65498P		2" 65525P
Water Pressure Kit (Outboard) 30 PSI	2" 62721P		2" 62960P	2" 65507P	2" 63523P	2" 65551P
Water Pressure Kit (Outboard) 40 PSI		2" 67657P				
GPS Speedo 35 MPH	3" 781-627-035P	3" 781-625-035P			3" 781-310-035P	
GPS Speedo 60 MPH	3" 781-627-060P	3" 781-625-060P			3" 781-310-060P	3" 781-294-060P
GPS Speedo 80 MPH	3" 781-627-080P	3" 781-625-080P				
GPS Speedo 120 MPH	3" 781-627-120P	3" 781-625-120P				
Speedo Kit 35 MPH (Pitot Type)				3" 61751P	3" 61751P	
Speedo Kit 50 MPH (Pitot Type)			3" 61547P	3" 61752P	3" 61752FP	3" 65529P, 5" 65530P
Speedo Kit 60 MPH (Pitot Type)						
Speedo Kit 65 MPH (Pitot Type)	3" 62722P	3" 62546P		3" 65510P	3" 59713P	
Speedo Kit 70 MPH (Pitot Type)						3" 65531P
Speedo Kit 80 MPH (Pitot Type)				3" 65670P		
Tachometer, 0-6000 RPM O/B & 4 Cycle Gas	3" 62724P					
Tachometer, 0-7000 RPM O/B & 4 Cycle Gas		3" 62561P	3" 61546P	3" 65693P	3" 59737P	3" 65535P, 5" 65536P
Tachometer, 0-8000 RPM O/B & 4 Cycle Gas	3" 62725P					
Tachometer 0-4000 RPM Diesel Alt		3" 62547P		3" 65671P		3" 65537P
Diesel Magnetic Pickup, 90-180 Teeth		3" 62548P		3" 65692P		
Tach/Hour 0-7000 RPM O/B & 4 Cycle Gas		3" 62565P		3" 65129P		3" 65545P
Tachometer - System check gauge				3" 64477FP		
Water Temp (SW) 120-240°F	2" 62729P	2" 62540P	2" 61552P*	2" 65509P	2" 59654P	2" 65553P
Water Temperature Kit (Outboards)	2" 62748P			2" 65508P		
Trim Gauge Evinrude/Johnson	2" 62726P	2" 62550P		2" 65502P		2" 65547P
Trim Gauge Honda			2" 62375P	2" 65503P		
Trim Gauge Mercury OB & IO, Mariner, Force, Cobra, Volvo DP & SX, Yamaha 2001 & Up	2" 62727P	2" 62549P	2" 61551P	2" 65504P	2" 59657P	2" 65548P
Trim Gauge 2002 and newer Suzuki 4-Stroke	2" 62726P	2" 62550P		2" 65502P		2" 65547P
Trim Gauge pre 2001 Yamaha outboards	2" 62728P			2" 65505P		
Voltmeter 12v	2" 62730P †	2" 62555P	2" 61548P	2" 65506P	2" 59656P	2" 65550P
Voltmeter 24v						
12V Battery Condition Indicator						
Engine Synchronizer Gauge				2" 65495P		
System Check Gauge - Evinrude/Johnson				2" 65206SSP		
Systems Monitor - Suzuki						
Ammeter 60-0-60						

* **Twin Engine Outboard Add On Kit - Tachometer, Voltmeter**

* **Twin Engine Inboard/Stern Drive Kit - Tachometer, Water Temperature, Oil Pressure, Voltmeter**

* **Outboard Kit - Tachometer, Speedometer (65 MPH with pitot tube), Fuel Gauge (compatible with common marine senders), and Voltmeter. Matching Trim Gauges, Hourmeters and Water Pressure or Temperature Kits are available separately. (Not for diesels.)**

* **Stern Drive Kit - Tachometer, Speedometer (65 MPH with pitot tube), Fuel Gauge, Water Temperature Gauge, Oil Pressure Gauge (all compatible with common marine senders), and Voltmeter. Matching Trim Gauges and Hourmeters are available separately for stern drive applications. (Not for diesels.)**

* (100-220°F) range.

* 0-3500 RPM.



Sahara	Sterling	Black Sterling	Omega	Arctic	Eclipse	Heavy Duty
2" 59707P	2" 63477P	2" 67021P	2" 57902P	2" 68365P	2" 68390P	2" 80150P
			2" 84760P	2" 68366P	2" 68391P	2" 82760P
2" 59705P	2" 63479P	2" 67022P	2" 57903P	2" 68367P	2" 68392P	2" 80180P
			2" 57929P		2" 68393P	2" 80181P
2" 69870P	2" 63481P		2" 61238P			
		2" 67382P	2" 68357P	2" 68369P	2" 68394P	
			3" 781-579-035P	3" 781-683-035P	3" 781-684-035P	
			3" 781-579-060P	3" 781-683-060P	3" 781-684-060P	
			3" 781-579-080P	3" 781-683-080P	3" 781-684-080P	
3" 61826P			3" 58342P	3" 68370P	3" 68395P	
3" 61163P		3" 68960P	3" 57898P			3" 80514P
3" 59704P	3" 63475P		3" 57900P	3" 68371P	3" 68396P	
		3" 67285P				
3" 63076P	3" 63476P		3" 57899P	3" 68372P	3" 68397P	
						3" 82288P
3" 59703P	3" 63473P	3" 67363P	3" 58255P	3" 68374P	3" 68399P	
			3" 68358P	3" 68373P	3" 68398P	3" 82302P*
						3" 82303P
3" 69743P	3" 63474P	3" 67364P	3" 68443P	3" 68375P	3" 68400P	
3" 61901P			3" 58935P			
2" 59706P	2" 63480P	2" 67020P	2" 57904P	2" 68376P	2" 68401P	2" 80590P
			2" 58862P*	2" 68377P	2" 68402P	
2" 61908P	2" 63483P	2" 67365P	2" 58431P	2" 68378P	2" 68403P	
2" 62369P	2" 64475P	2" 67855P	2" 68359P	2" 68379P	2" 68404P	
2" 59709P	2" 63482P	2" 67023P	2" 57905P	2" 68380P	2" 68405P	
2" 61908P	2" 63483P	2" 67365P	2" 58431P	2" 68378P	2" 68403P	
			2" 61748P	2" 68381P	2" 68406P	
2" 59708P	2" 63478P	2" 67019P	2" 57901P	2" 68383P	2" 68408P	2" 80134P †
						2" 80131P
			2" 68361P	2" 68384P	2" 68409P	
						2" 80730P
2" 66956P	2" 63585P		2" 65205P	2" 68385P	2" 68410P	
			2" 68356P	2" 68364P	2" 68389P	2" 80710P

* **Outboard Kit w/Tach/Hr** - Tachometer/Hourmeter, Speedometer (65 MPH w/ Pitot Tube, Fuel Gauge (compatible with common marine senders), and Voltmeter.

* **Inboard/Sterndrive Kit** - Tachometer/Hourmeter, Speedometer (65 MPH w/ Pitot Tube, fuel Gauge, Water Temperature Gauge, Oil Pressure Gauge (all compatible with common marine senders), and Voltmeter.

* Matching Trim Gauges are available separately. Not for diesels.

† 8-16 VDC



MATRIX GAUGES - The Matrix gauge set is intended to operate on Mercury SmartCraft engines (max 4 engines/2 stations) utilizing the SmartCraft® protocol. The gauges operate on 12 volt systems and support single, dual, triple or quad engine applications. In a Matrix gauge set, the 3" tachometer is the master and connects directly to the SmartCraft data bus. All other gauges are slaves and connect to the tachometer RS-485 private bus (immune to electrical noise, more robust and reliable). The tachometer reads SmartCraft engine parameters and forwards them on the private bus for the slave gauges.



FEATURES:

- Smart Tachometer CANbus driven
- All 2" gauges receive data from tachometers
- LCD on Tachometer and Speedo displays all available data and alarms
- IP67 waterproof/ submersible housings (with Connector fitted)
- Dry Nitrogen filled to minimize fogging
- LED dimmable, automotive style backlighting (red)
- CANbus connectivity

SELECTION GUIDE:

GAUGE DESCRIPTION	SIZE	PART NO.
Speedometer w/ LCD US 90 MPH	3"	70002D
Fuel Primary	2"	70003D
Fuel Secondary	2"	69992D
Voltmeter 10 - 16 VDC	2"	70004D
Temperature 240F	2"	70006D
Water pressure 40 PSI	2"	69994D
Oil Pressure 80 PSI	2"	70005D
Trim	2"	69993D
Tachometer - Smartcraft	3"	70000D
Tachometer - NEMA 2000	3"	70001D

PART NO.	DESCRIPTION
69995K	Harness - Tachometer to Smartcraft, 30"
69996K	Harness - Tachometer to NMEA 2000, 30"
69997K	Harness - Tachometer to Speedometer, 48"
69998K	Terminator - Needed when no speedo is used
69999K	Harness - Any 2" gauge to another, 8"

PARAMETERS SUPPORTED			
• Engine RPM	• Reserve Oil Level	• Throttle Position	• Tank 2
• Coolant Temperature	• Water Pressure	• Load Percent	• RPM Synch
• Engine Oil Pressure	• Coolant Pressure	• Oil Level	• Trim Synch
• Engine Hours	• Oil Temperature	• Boost Pressure	
• Fuel Low	• Fuel Pressure	• Tank 1	



GPS SPEEDOMETERS - These GPS speedometers provide accurate speed over ground readings and heading information all in one attractive package. Available in various speed ranges to meet your application, the GPS speedometer is offered in a number of popular styles to match the colors in your boat like Premier Pro, White Premier Pro, Amega, Arctic, Eclipse, Lido Pro and Argent Pro instrument lines.



FEATURES:

- Available in speed ranges of 35 MPH, 60 MPH, 80 MPH and 120 MPH.
- Included LCD heading display to show course over ground.
- Use our GPS antenna (sold separately) or connect to an existing NMEA 0183 GPS device – connectors included.
- Speed accuracy of +/-1 MPH (once moving).
- Heading accuracy of +/-1 degree (once moving).
- Ideal for slow speed applications like pontoon boats and for high speed performance boats where pitot tubes do not perform well.

SELECTION GUIDE:

PART NUMBER	GAUGE DESCRIPTION	SIZE	DIAL RANGE	SENDER CODE
Premier Pro:				
781-627-035P	35 MPH	3"	0-35 MPH	GPS RECEIVER
781-627-060P	60 MPH	3"	0-60 MPH	GPS RECEIVER
781-627-080P •	80 MPH	3"	0-80 MPH	GPS RECEIVER
781-627-120P	120 MPH	3"	0-120 MPH	GPS RECEIVER
White Premier Pro:				
781-625-035P	35 MPH	3"	0-35 MPH	GPS RECEIVER
781-625-060P	60 MPH	3"	0-60 MPH	GPS RECEIVER
781-625-080P •	80 MPH	3"	0-80 MPH	GPS RECEIVER
781-625-120P	120 MPH	3"	0-120 MPH	GPS RECEIVER
Amega:				
781-579-035P	35 MPH	3"	0-35 MPH	GPS RECEIVER
781-579-060P	60 MPH	3"	0-60 MPH	GPS RECEIVER
781-579-080P •	80 MPH	3"	0-80 MPH	GPS RECEIVER
Arctic:				
781-683-035P	35 MPH	3"	0-35 MPH	GPS RECEIVER
781-683-060P	60 MPH	3"	0-60 MPH	GPS RECEIVER
781-683-080P •	80 MPH	3"	0-80 MPH	GPS RECEIVER
Eclipse:				
781-684-035P	35 MPH	3"	0-35 MPH	GPS RECEIVER
781-684-060P	60 MPH	3"	0-60 MPH	GPS RECEIVER
781-684-080P •	80 MPH	3"	0-80 MPH	GPS RECEIVER
Lido Pro:				
781-310-035P	35 MPH	3"	0-35 MPH	GPS RECEIVER
781-310-060P	60 MPH	3"	0-60 MPH	GPS RECEIVER
Argent Pro:				
781-294-060P	60 MPH	3"	0-35 MPH	GPS RECEIVER

• Display Packaged Item

GPS RECEIVERS

- Highly sensitive receiver
- Precise information output even when mounted under a fiberglass console or bimini top
- Durable exterior
- Updates once every second to output accurate NMEA 0183 information (*Updates 10 times per second.)



68982P
GPS RECEIVER
4 ft. long

69053P*
GPS RECEIVER (HIGH SPEED)
4 ft. long



68755P
GPS RECEIVER
25 ft. long

PREMIER PRO - A very popular OEM line, Premier features black dials with modern white and blue graphics. When lighted, white dial grads become red and pointer lights white. These instruments feature automotive type light-piping and a fog-resistant design for outstanding readability.



FEATURES:

- Full automotive type lighting, no “halo” around dial edges. When lit, white dial grads become red, pointer lights white.
- Black dial, white graduations/numerals (metrics in blue), white pointer staff.
- Scratch resistant curved glass lenses, with black, near-flush bezels.
- U.S. and metric scales, with ISO symbols, where appropriate.
- Optional add-on eyebrow or square bezels available (See Gauge Accessories for details).
- Line includes standard ignition engine synchronizer kits including module.
- Fog-Resistant Design! Complies with SAE J-1810.

SELECTION GUIDE:

GAUGE DESCRIPTION	SIZE	DIAL RANGE	SENDER CODE	PART NUMBER
Fuel Gauge:	2"	E-1/2-F	REQUIRES "F"	62718P •
Hourmeter:	2"	10,000 Hrs.	NONE REQUIRED	62719P •
Oil Pressure Gauge (Electric): Oil Pressure 80 PSI	2"	0-80 PSI	REQUIRES "C"	62720P •
GPS Speedometer:				
35 MPH	3"	0-35 MPH	GPS RECEIVER	781-627-035P
60 MPH	3"	0-60 MPH	GPS RECEIVER	781-627-060P
80 MPH	3"	0-80 MPH	GPS RECEIVER	781-627-080P •
120 MPH	3"	0-120 MPH	GPS RECEIVER	781-627-120P
Speedometer Kits:				
65 MPH (Pitot type)	3"	10-65 MPH	INCLUDES "G"	62722P •
80 MPH (Pitot type) Head Only	3"	20-80 MPH		62723PH
Tachometers (Electric):				
O/B & 4-Stroke Gas Engines*	3"	0-6000 RPM	O/B ALT./COIL	62724P •
O/B & 4-Stroke Gas Engines*	3"	0-8000 RPM	O/B ALT./COIL	62725P •
Trim Gauges (Outboard, I/O): Johnson/Evinrude (All) & Suzuki 4-stroke 2002 & Up	2"	UP-DOWN	BY ENG. MFR	62726P •
Mercury O/B & I/O, Mariner, Force, Cobra, Volvo DP & SX, Yamaha 2001 & Up	2"	UP-DOWN	BY ENG. MFR	62727P •
Yamaha Outboards pre-2001	2"	UP-DOWN	BY ENG. MFR	62728P •
Voltmeter-12 Volt:	2"	8-16 VDC	NONE REQUIRED	62730P •
Water Pressure Kit (Outboard):** (Each kit includes fittings and 20 feet of tubing)	2"	30 PSI	INCLUDES "WP"	62721P •
Water Temp. Kit (Outboard):** (For all electric-start outboards)	2"	COLD-HOT	INCLUDES "J"	62748P •
Water Temp. Gauge (I/O, I/B):	2"	120-240°F	REQUIRES "D"	62729P •
Instrument Set "OUTBOARD"	Contains: 62725P, 62722P, 62718P, 62730P			62714P •
Instrument Set "INBOARD/STERNDRIVE"	Contains: 62724P, 62722P, 62718P, 62730P, 62729P, 62720P			62715P •

• Display Packaged Item

* Not tested for complete aftermarket ignition systems, will work with aftermarket replacement parts.

** Adapter (P/N 61886P) is required for Yamaha.
Use 4000 RPM tachometer or lower for diesel applications.

WHITE PREMIER PRO — Ideal for inboards, including diesels, Premier White features polished stainless steel bezels and clean white dials with modern black and blue graphics. When illuminated, black dial grads become red and pointer lights red. Automotive type light-piping and fog-resistant design combine for outstanding readability.



FEATURES:

- Full automotive type lighting, no “halo” around dial edges. When illuminated, black dial grads become red, pointer lights red.
- White dial, black graduations/numerals (metrics in blue), red pointer staff.
- Scratch resistant curved glass lenses, with polished stainless steel near-flush bezels.
- U.S. and metric scales, with ISO symbols, where appropriate.
- Optional add-on eyebrow or square bezels available (See Gauge Accessories for details).
- Fog-Resistant Design! Complies with SAE J-1810.

SELECTION GUIDE:

GAUGE DESCRIPTION	SIZE	DIAL RANGE	SENDER CODE	PART NUMBER
Fuel Gauge:	2"	E-1/2-F	REQUIRES "F"	62551P •
Hourmeter:	2"	10,000 Hrs.	NONE REQUIRED	62538P •
Oil Pressure Gauges (Electric):				
Oil Pressure 80 PSI	2"	0-80 PSI	REQUIRES "C"	62542P •
Oil Pressure 100 PSI	2"	0-100 PSI	REQUIRES "C"	62543P •
GPS Speedometer:				
35 MPH	3"	0-35 MPH	GPS RECEIVER	781-625-035P
60 MPH	3"	0-60 MPH	GPS RECEIVER	781-625-060P
80 MPH	3"	0-80 MPH	GPS RECEIVER	781-625-080P •
120 MPH	3"	0-120 MPH	GPS RECEIVER	781-625-120P
Speedometer Kits:				
65 MPH (Pitot type)	3"	10-65 MPH	INCLUDES "G"	62546P •
65 MPH (Pitot type) Head Only	3"	10-65 MPH		62546PH
Tachometer (Electric):				
O/B & 4-Stroke Gas Engines*	3"	0-7000 RPM	O/B ALT./COIL	62561P •
Tachometer/Hourmeter (Electric):				
O/B & 4-Stroke Gas Engines*	3"	0-7000 RPM	O/B ALT./COIL	62565P •
Tachometers (Electric):				
Diesel Alternator**	3"	0-4000 RPM	SEE "T"	62547P •
Diesel Magnetic Pickup, 90-180 Teeth	3"	0-4000 RPM	REQUIRES "B"	62548P
Trim Gauges (Outboard, I/O):				
Johnson/Evinrude (All) & Suzuki 4-Stroke 2002 & Up	2"	UP-DOWN	BY ENG. MFR	62550P •
Mercury O/B & I/O, Mariner, Force, Cobra, Volvo DP & SX, Yamaha 2001 & Up	2"	UP-DOWN	BY ENG. MFR	62549P •
Voltmeters-12 & 24 Volt:				
12 Volt System	2"	8-18 VDC	NONE REQ'D	62555P •
Water Temp. Gauge (I/O, I/B):	2"	120-240°F	REQUIRES "D"	62540P •
Water Pressure Kit, O/B	2"	40 PSI	INCLUDES "WP"	67657P •
Instrument Set "INBOARD/STERNDRIVE"	Contains: 62561P, 62546P, 62551P, 62555P, 62540P, 62542P			67654P •

• Display Packaged Item

* Not tested for complete aftermarket ignition systems, will work with aftermarket replacement parts.

** May require alternator tap.

Use 4000 RPM tachometer or lower for diesel applications.

ARGENT PRO - Black graphics on a silver background, pointer has black hub with fade resistant acrylic orange staff. Pointer is internally illuminated for excellent night visibility. Dial graphics light red when illuminated and scratch resistant glass lens with fog-resistant design and polished stainless steel bezel.



FEATURES:

- Translucent dial as well as internally illuminated pointer staff, provides the best in night visibility.
- Easy to read black graphics on a silver dial background.
- Domed glass lenses are scratch resistant.
- Low profile bezels follow the curvature of the lens, with no 'lip' to trap and hold water.
- Optional add-on eyebrow or Square bezels available (See gauge accessories for details)

FOG RESISTANT GAUGE FEATURES:

- Fog-Resistant Design! Complies with SAE J-1810.

SELECTION GUIDE:

GAUGE DESCRIPTION	SIZE	DIAL RANGE	SENDER CODE	PART NUMBER
Fuel Gauge:	2"	E-1/2-F	REQUIRES "F"	65524P •
Oil Pressure Gauge (Electric):				
Oil Pressure 80 PSI	2"	0-80 PSI	REQUIRES "C"	65526P •
Oil Pressure 100 PSI	2"	0-80 PSI	REQUIRES "C"	65525P •
GPS Speedometer:				
60 MPH (Head Only)	3"	0-60 MPH	GPS RECEIVER	781-294-060P
Speedometer Kits:				
50 MPH (Pitot type)	3"	5-50 MPH	INCLUDES "G"	65529P •
50 MPH (Pitot type)	5"	5-50 MPH	INCLUDES "G"	65530P
70 MPH (Pitot type)	3"	20-70 MPH	INCLUDES "G"	65531P •
Tachometers (Electric):				
O/B & 4-Stroke Gas Engines*	3"	0-7000 RPM	O/B ALT./COIL	65535P •
O/B & 4-Stroke Gas Engines*	5"	0-7000 RPM	O/B ALT./COIL	65536P
Diesel Alternator*	3"	0-4000 RPM	O/B ALT./COIL	65537P •
Tachometer/Hourmeter (Electric):				
O/B & 4-Stroke Gas Engines*	3"	0-7000 RPM	O/B ALT./COIL	65545P •
Trim Gauges (Outboard, I/O):				
Johnson/Evinrude (All) & Suzuki 4-stroke 2002 & Up	2"	UP-DOWN	BY ENG. MFR	65547P •
Mercury O/B & I/O, Mariner, Force, Cobra, Volvo DP & SX, Yamaha 2001 & Up	2"	UP-DOWN	BY ENG. MFR	65548P •
Voltmeter-12 Volt:	2"	10-16 VDC	NONE REQUIRED	65550P •
Water Pressure Kit (Outboard):***				
Each kit includes fittings & 20 feet of tubing)	2"	30 PSI	INCLUDES "WP"	65551P •
Water Temp. Gauge (I/O) (Electric):	2"	120-240°F	REQUIRES "D"	65553P •

• Display Packaged Item

* Not tested for non-original-equipment (aftermarket) ignition systems.
 *** Adapter (P/N 61886P) is required for Yamaha.
 Use 4000 RPM tachometer or lower for diesel applications.



LIDO PRO - We have added a selection of fog resistant gauges to our hottest white dial line. Lido Pro features a crisp, white dial with a fire orange pointer tip. Red through-dial and white perimeter lighting provide great night readability. Coverage for popular OB and I/O applications - complete gauge kits available **.



FEATURES:

- White dial, black numerals, black pointer with fire-orange tip.
- Scratch resistant curved glass lenses, with polished stainless steel, near-flush bezels.
- U.S. and metric scales, with ISO symbols.
- Optional add-on eyebrow or square bezels available (See Gauge Accessories for details).
- White perimeter and red thru-dial lighting.

FOG RESISTANT GAUGE FEATURES:

- Fog-Resistant Design! Complies with SAE J-1810.

SELECTION GUIDE:

GAUGE DESCRIPTION	SIZE	DIAL RANGE	SENDER CODE	FOG RESISTANT
Fuel Gauge:	2"	E-1/2-F	REQUIRES "F"	59655P •
Hourmeter:	2"	10,000 Hrs.	NONE REQ'D	59416P •
Oil Pressure Gauges (Electric):				
Oil Pressure 80 PSI	2"	0-80 PSI	REQUIRES "C"	59653P •
GPS Speedometer:				
35 MPH	3"	0-35 MPH	GPS RECEIVER	781-310-035P
60 MPH	3"	0-60 MPH	GPS RECEIVER	781-310-060P
Speedometer Kits:				
50 MPH (Pitot type)	3"	10-50 MPH	INCLUDES "G"	61752FP •
65 MPH (Pitot type)	3"	10-65 MPH	INCLUDES "G"	59713P •
Tachometer (Electric):				
O/B & 4-Stroke Gas Engines*	3"	0-7000 RPM	O/B ALT./COIL	59737P •
Trim Gauges (Outboard, I/O):				
Mercury O/B & I/O, Mariner, Force, Cobra, Volvo DP & SX, Yamaha 2001 & Up	2"	UP-DOWN	BY ENG. MFR.	59657P •
Voltmeter-12 Volt:	2"	8-18 VDC	NONE REQ'D	59656P •
Water Pressure Kit (Outboard):***				
Each kit includes fittings and 20 feet of tubing	2"	30 PSI	INCLUDES "WP"	63523P •
Water Temp. Gauge (I/O, I/B):	2"	120-240°F	REQUIRES "D"	59654P •
Instrument Set "OUTBOARD"	Contains: 59737P, 59713P, 59655P, 59656P			67669P •
Instrument Set "INBOARD/STERNDRIIVE"	Contains: 59737P, 59713P, 59655P, 59656P, 59654P, 59653P			67653P •

• Display Packaged Item

* Not tested for complete aftermarket ignition systems, will work with aftermarket replacement parts.

*** Adapter (P/N 61886P) is required for Yamaha.

Use 4000 RPM tachometer or lower for diesel applications.



LIDO - Hottest selling white dial line! A comprehensive family of instruments for most engine types, Lido features crisp white dials and fire-orange pointer tips. Red through-dial and white perimeter lighting provide great night readability. Excellent inboard coverage with engine sync gauges* and diesel alternator and magnetic pickup tachometers**.

*Module required, not included with gauge. **Magnetic Pickup sender available separately.

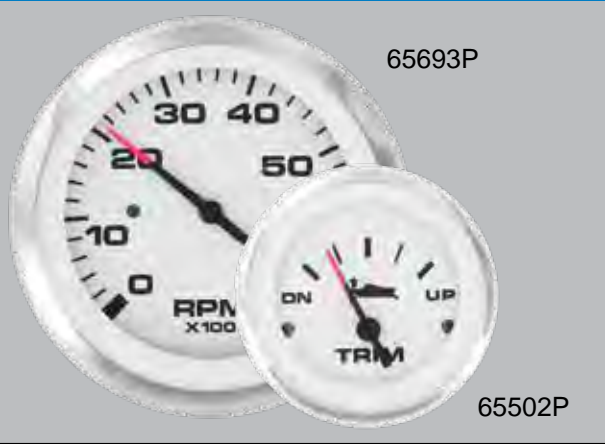

FEATURES:

- White dial, black numerals, black pointer with fire-orange tip.
- Scratch resistant curved glass lenses, with polished stainless steel, near-flush bezels.
- U.S. and metric scales, with ISO symbols.
- Optional add-on eyebrow or square bezels available (See Gauge Accessories for details).
- White perimeter and red thru-dial lighting.
- Comprehensive line includes tachometers for diesel alternator and magnetic pickup PLUS synchronizer gauge (Suitable for gas or diesel engines with appropriate module. Module required, not included with gauge).

SELECTION GUIDE:

GAUGE DESCRIPTION	SIZE	DIAL RANGE	SENDER CODE	PART NUMBER
Engine Sync (gauge only)	2"	PORT-STBD.	REQUIRES "L"	65495P •
Fuel Gauge:	2"	E-1/2-F	REQUIRES "F"	65496P •
Hourmeter:	2"	10,000 Hrs.	NONE REQ'D	65497P •
Oil Pressure Gauges (Electric):				
Oil Pressure 80 PSI	2"	0-80 PSI	REQUIRES "C"	65501P •
Oil Pressure 100 PSI	2"	0-100 PSI	REQUIRES "C"	65498P •
Speedometer Kits:				
35 MPH (Pitot type)	3"	5-35 MPH	INCLUDES "G"	61751P
35 MPH (Pitot type) Head Only	3"	5-35 MPH		61751PH
50 MPH (Pitot type)	3"	10-50 MPH	INCLUDES "G"	61752P •
50 MPH (Pitot type) Head Only	3"	10-50 MPH		61752PH
65 MPH (Pitot type)	3"	10-65 MPH	INCLUDES "G"	65510P •
80 MPH (Pitot type)	3"	20-80 MPH	INCLUDES "G"	65670P •
80 MPH (Pitot type) Head Only	3"	20-80 MPH		65670PH
Systems Check-Evinrude/Johnson:	2"	SYSTEM DATA	BY ENG. MFR.	65206SSP
Tachometer (Electric):				
O/B & 4-Stroke Gas Engines*	3"	0-7000 RPM	O/B ALT./COIL	65693P •
Systems Check – Evinrude/Johnson	3"	0-7000 RPM	O/B ALT./COIL	64477FP •
Tachometer/Hourmeters (Electric):				
O/B & 4-Stroke Gas Engines*	3"	0-7000 RPM	O/B ALT./COIL	65129P •
Diesel Alternator**	3"	0-4000 RPM	SEE "T"	65671P •
Diesel Magnetic Pickup, 90-180 Teeth	3"	0-4000 RPM	REQUIRES "B"	65692P •
Trim Gauges (Outboard, I/O):				
Johnson/Evinrude (All) & Suzuki				
4-stroke 2002 & Up	2"	UP-DOWN	BY ENG. MFR.	65502P •
Honda	2"	UP-DOWN	BY ENG. MFR.	65503P
Mercury O/B & I/O, Mariner, Force, Cobra,				
Volvo DP & SX, Yamaha 2001 & Up	2"	UP-DOWN	BY ENG. MFR.	65504P •
Yamaha Outboards pre-2001	2"	UP-DOWN	BY ENG. MFR.	65505P •
Voltmeter-12 Volt:	2"	8-18 VDC	NONE REQ'D	65506P •
Water Pressure Kit (Outboard):***				
Each kit includes fittings and 20 feet of tubing)	2"	30 PSI	INCLUDES "WP"	65507P •
Water Temp. Kit (Outboard):***				
(For all electric-start outboards)	2"	COLD-HOT	INCLUDES "J"	65508P •
Water Temp. Gauge (I/O, I/B):	2"	120-240°F	REQUIRES "D"	65509P •

• Display Packaged Item

* Not tested for complete aftermarket ignition systems, will work with aftermarket replacement parts.
 ** May require alternator tap. *** Adapter (P/N 61886P) is required for Yamaha.
 Use 4000 RPM tachometer or lower for diesel applications.

DRIFTWOOD - Features light gray dials, clean black numerals and a black pointer hub with white staff. These instruments lend a sophisticated look to any dash. Combination blue through-dial and white perimeter lighting are included for excellent readability at night.



FEATURES:

- Light gray dial, black graduations/numerals, white pointer staff.
- Scratch resistant curved glass lenses, with black, near-flush bezels.
- White perimeter and blue thru-dial lighting.
- U.S. and metric scales, with ISO symbols, where appropriate.
- Optional add-on eyebrow or square bezels available (See Gauge Accessories for details).

SELECTION GUIDE:

GAUGE DESCRIPTION	SIZE	DIAL RANGE	SENDER CODE	PART NUMBER
Fuel Gauge:	2"	E-1/2-F	REQUIRES "F"	61549P •
Hourmeter:	2"	10,000 Hrs.	NONE REQ'D	62952P •
Oil Pressure Gauge (Electric):	2"	0-80 PSI	REQUIRES "C"	61550P •
Speedometer Kits:				
50 MPH (Pitot type)	3"	10-50 MPH	INCLUDES "G"	61547P •
Tachometer (Electric):				
O/B & 4-Stroke Gas Engines*	3"	0-7000 RPM	O/B ALT./COIL	61546P •
Trim Gauges (Outboard, I/O):				
Honda	2"	UP-DOWN	BY ENG. MFR.	62375P
Mercury O/B & I/O, Mariner, Force, Cobra, Volvo DP & SX, Yamaha 2001 & Up	2"	UP-DOWN	BY ENG. MFR.	61551P •
Voltmeter-12 Volt:	2"	8-18 VDC	NONE REQ'D	61548P •
Water Pressure Kit (Outboard):** (Kit includes fittings/20 feet of tubing)	2"	30 PSI	INCLUDES "WP"	62960P •
Water Temp. Gauge (I/O, I/B):	2"	100-220°F	REQUIRES "D"	61552P •

• Display Packaged Item

* Not tested for complete aftermarket ignition systems, will work with aftermarket replacement parts.

** Adapter (P/N 61886P) is required for Yamaha.

Use 4000 RPM tachometer or lower for diesel applications.



SAHARA - With crisp tan dials and fire-orange pointer tip, Sahara gives any dash the elegant OEM look. Combined red through-dial and white perimeter lighting provide great night readability. These aren't merely "close enough" — they're the real thing!



FEATURES:

- Tan dial and retainer, black graduations and numerals, black pointer with fire-orange tip.
- Scratch resistant curved glass lenses, with black matte, near-flush bezels.
- White perimeter and red thru-dial lighting.
- U.S. and metric scales, with ISO symbols, where appropriate.
- Optional add-on eyebrow or square bezels available (See Gauge Accessories for details).

SELECTION GUIDE:

GAUGE DESCRIPTION	SIZE	DIAL RANGE	SENDER CODE	PART NUMBER
Fuel Gauge:	2"	E-1/2-F	REQUIRES "F"	59707P •
Oil Pressure Gauge (Electric):	2"	0-80 PSI	REQUIRES "C"	59705P •
Speedometer Kits:				
35 MPH (Pitot type)	3"	5-35 MPH	INCLUDES "G"	61826P •
35 MPH (Pitot type) Head Only	3"	5-35 MPH		61826PH
50 MPH (Pitot type)	3"	10-50 MPH	INCLUDES "G"	61163P •
65 MPH (Pitot type)	3"	10-65 MPH	INCLUDES "G"	59704P •
65 MPH (Pitot type) Head Only	3"	10-65 MPH		59704PH
80 MPH (Pitot type)	3"	20-80 MPH	INCLUDES "G"	63076P •
80 MPH (Pitot type) Head Only	3"	20-80 MPH		63076PH
Systems Check – Evinrude/Johnson:	2"	SYSTEM DATA	BY ENG. MFR.	66956P
Tachometer (Electric):				
O/B & 4-Stroke Gas Engines*	3"	0-7000 RPM	O/B ALT./COIL	59703P •
Systems Check – Evinrude/Johnson	3"	0-7000 RPM	O/B ALT./COIL	61901P •
Tach/Hourmeter 0-7000 RPM	3"	0-7000 RPM	O/B ALT./Coil	69743P •
Trim Gauges (Outboard, I/O):				
Johnson/Evinrude (All) & Suzuki 4-stroke 2002 & Up	2"	UP-DOWN	BY ENG. MFR.	61908P •
Honda	2"	UP-DOWN	BY ENG. MFR.	62369P
Mercury O/B & I/O, Mariner, Force, Cobra, Volvo DP & SX, Yamaha 2001 & Up	2"	UP-DOWN	BY ENG. MFR.	59709P •
Voltmeter-12 Volt:	2"	8-18 VDC	NONE REQ'D	59708P •
Water Pressure Kits (Outboard):** (Each kit includes fittings and 20 feet of tubing)	2"	40 PSI	INCLUDES "WP"	69870P •
Water Temp. Gauge (I/O, I/B):	2"	120-240°F	REQUIRES "D"	59706P •
Instrument Set "OUTBOARD"	Contains: 59703P, 59704P, 59707P, 59708P			65481P •
Instrument Set "INBOARD/STERNDRIVE"	Contains: 59703P, 59704P, 59707P, 59708P, 59706P, 59705P			65485P •
Twin Engine Add On IB/IOGauge Kit	Contains: 59703P, 59708P, 59706P, 59705P			69717P
Twin Engine Add On OBGauge Kit	Contains: 59703P, 59708P			69716P
Instrument Set OB w/Tach/Hr	Contains: 69743P, 59704P, 59707P, 59708P			69703P •
Instrument Set IB/IO w/Tach/Hr	Contains: 69743P, 59704P, 59707P, 59708P, 59706P, 59705P			69704P •

• Display Packaged Item

* Not tested for complete aftermarket ignition systems, will work with aftermarket replacement parts.

** Adapter (P/N 61886P) is required for Yamaha.
Use 4000 RPM tachometer or lower for diesel applications.

STERLING - Ideal for outboards and stern drives! With stainless steel bezels, brushed aluminum dials and black pointers, Sterling instruments give a bright, gleaming look to any dash. Perimeter lighting provided for night operation.

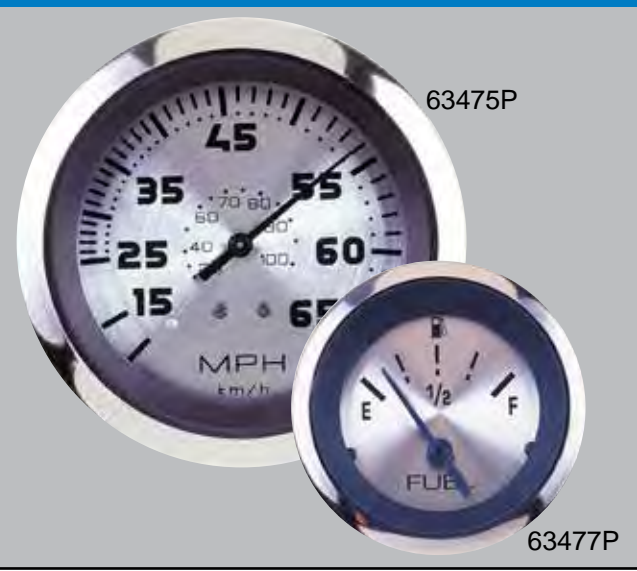

FEATURES:

- Brushed aluminum dial, black graduations/ numerals, black pointer.
- Scratch resistant curved glass lenses, with polished stainless steel, near-flush bezels.
- Perimeter lighting.
- U.S. and metric scales, with ISO symbols, where appropriate.
- Optional add-on eyebrow or square bezels available (See Gauge Accessories for details).

SELECTION GUIDE:

GAUGE DESCRIPTION	SIZE	DIAL RANGE	SENDER CODE	PART NUMBER
Fuel Gauge:	2"	E-1/2-F	REQUIRES "F"	63477P •
Oil Pressure Gauge (Electric):	2"	0-80 PSI	REQUIRES "C"	63479P •
Speedometer Kits:				
65 MPH (Pitot type)	3"	10-65 MPH	INCLUDES "G"	63475P •
65 MPH (Pitot type) Head Only	3"	10-65 MPH		63475PH
80 MPH (Pitot type)	3"	20-80 MPH	INCLUDES "G"	63476P •
80 MPH (Pitot type) Head Only	3"	20-80 MPH		63476PH
Systems Check – Evinrude/Johnson:	2"	SYSTEM DATA	BY ENG. MFR.	63585P •
Tachometer (Electric):				
O/B & 4-Stroke Gas Engines*	3"	0-7000 RPM	O/B ALT./COIL	63473P •
Tachometer/Hourmeter (Electric):				
O/B & 4-Stroke Gas Engines*	3"	0-7000 RPM	O/B ALT./COIL	63474P •
Trim Gauges (Outboard, I/O):				
Honda	2"	UP-DOWN	BY ENG. MFR.	64475P
Johnson/Evinrude (All) & Suzuki 4-stroke 2002 & Up	2"	UP-DOWN	BY ENG. MFR.	63483P •
Mercury O/B & I/O, Mariner, Force, Cobra, Volvo DP & SX, Yamaha 2001 & Up	2"	UP-DOWN	BY ENG. MFR.	63482P •
Voltmeter-12 Volt:	2"	8-18 VDC	NONE REQ'D	63478P •
Water Pressure Kit (Outboard):** (Kit includes fittings/20 feet of tubing)	2"	30 PSI	INCLUDES "WP"	63481P •
Water Temp. Gauge (I/O, I/B):	2"	120-240°F	REQUIRES "D"	63480P •

• Display Packaged Item

* Not tested for complete aftermarket ignition systems, will work with aftermarket replacement parts.

** Adapter (P/N 61886P) is required for Yamaha.
Use 4000 RPM tachometer or lower for diesel applications.

BLACK STERLING - With its rich luster and polish, Black Sterling instruments convey a look of utmost sophistication and add elegance to any dash. These instruments have fire-orange pointer tips and stainless graphics for a contemporary, ultra stylish look. Black Sterling instruments have clean, crisp black dials which highlight the stainless accents.



FEATURES:

- Scratch-resistant domed glass lens.
- Perimeter lit dial.
- Elite stainless steel bezel.
- Black pointer with fire orange tip.
- White graphics and black background on spun aluminum dial.
- Optional add-on eyebrow or square bezels available (See Gauge Accessories for details).
- Fits most stern drive and outboard applications.
- US and Metric scales where appropriate.

MULTI-GAUGE FEATURES:

- Combines 2 gauges in one.
- Saves dash space.
- Fog-Resistant Design! Complies with SAE J-1810.

SELECTION GUIDE:

GAUGE DESCRIPTION	SIZE	DIAL RANGE	SENDER CODE	PART NUMBER
Fuel Gauge	2"	E-1/2-F	REQUIRES "F"	67021P •
Voltmeter	2"	8-18 VDC	NONE REQ'D	67019P •
Water Temperature (Electric)	2"	100-240°F	REQUIRES "D"	67020P •
Oil Pressure (Electric)	2"	0-80 PSI	REQUIRES "C"	67022P •
50 MPH Speedometer	3"	0-50 MPH	INCLUDES "G"	68960P •
50 MPH Speedometer (Head Only)	3"	0-50 MPH		68960PH
70 MPH Speedometer Kit	3"	0-70 MPH	INCLUDES "G"	67285P •
Tachometer: O/B & 4 Cycle Gas	3"	0-7000 RPM	O/B ALT./COIL	67363P •
Tach/LCD Hr, O/B & 4 Cycle Gas	3"	0-7000 RPM	O/B ALT./COIL	67364P •
Trim: Honda	2"	UP-DOWN	BY ENG. MFR.	67855P
Trim: Mercury O/B & I/O, Mariner, Force, Cobra, Volvo DP & SX, Yamaha 2001 & Up	2"	UP-DOWN	BY ENG. MFR.	67023P •
Trim: Johnson/Evinrude (All) & Suzuki 4-stroke 2002 & Up	2"	UP-DOWN	BY ENG. MFR.	67365P •
O/B Water Pressure Kit	2"	0-40 PSI	INCLUDES "WP"	67382P •
MULTI-GAUGE DESCRIPTION	SIZE	DIAL RANGE	SENDER CODE	PART NUMBER
Speedo/Fuel	3"	0-50 MPH E-1/2-F	REQUIRES "G" REQUIRES "F"	69073FP •
Tach/Volt	3"	0-7000 RMP 8-18 VDC	O/B ALT./COIL NONE REQ'D	69074FP •

• Display Packaged Item

* Not tested for complete aftermarket ignition systems, will work with aftermarket replacement parts.
 ** Adapter (P/N 61886P) is required for Yamaha.
 Use 4000 RPM tachometer or lower for diesel applications.

AMEGA - Hottest selling black dial line! Amega® Domed has clean-looking black dials with white and red graphics plus through-dial and perimeter lighting for great readability. Amega has been very popular, available in several styles since its debut in 1986.



FEATURES:

- Black dial, red graduations, white numerals, vivid white pointer staff.
- Scratch resistant curved glass lenses, with black, near-flush bezels.
- U.S. and metric scales, with ISO symbols, where appropriate.
- Perimeter and thru-dial lighting.
- A comprehensive array of outboard water pressure instrument kits.
- Optional add-on eyebrow or square bezels available (See Gauge Accessories for details).

SELECTION GUIDE:

GAUGE DESCRIPTION	SIZE	DIAL RANGE	SENDER CODE	PART NUMBER
Fuel Gauge:	2"	E-1/2-F	REQUIRES "F"	57902P •
Hourmeter:	2"	10,000 Hrs.	NONE REQ'D	84760P •
Oil Pressure Gauges (Electric):				
Oil Pressure 80 PSI	2"	0-80 PSI	REQUIRES "C"	57903P •
Oil Pressure 100 PSI	2"	0-100 PSI	REQUIRES "C"	57929P •
GPS Speedometer:				
35 MPH	3"	0-35 MPH	GPS RECEIVER	781-579-035P
60 MPH	3"	0-60 MPH	GPS RECEIVER	781-579-060P
80 MPH	3"	0-80 MPH	GPS RECEIVER	781-579-080P •
Speedometer Kits:				
35 MPH (Pitot type)	3"	5-35 MPH	INCLUDES "G"	58342P •
35 MPH (Pitot type) Head Only	3"	5-35 MPH		58342PH •
50 MPH (Pitot type)	3"	10-50 MPH	INCLUDES "G"	57898P •
50 MPH (Pitot type) Head Only	3"	10-50 MPH		57898PH •
65 MPH (Pitot type)	3"	10-65 MPH	INCLUDES "G"	57900P •
65 MPH (Pitot type) Head Only	3"	10-65 MPH		57900PH •
80 MPH (Pitot type)	3"	20-80 MPH	INCLUDES "G"	57899P •
80 MPH (Pitot type) Head Only	3"	20-80 MPH		57899PH •
Systems Check – Evinrude/Johnson:	2"	SYSTEM DATA	BY ENG. MFR.	65205P •
Tachometer (Electric):				
O/B & 4-Stroke Gas Engines*	3"	0-7000 RPM	O/B ALT./COIL	58255P •
Systems Check – Evinrude/Johnson	3"	0-7000 RPM	O/B ALT./COIL	58935P •
Diesel Alt	3"	0-4000 RPM	ALTERNATOR	68358P •
Force	3"	0-7000 RPM		69044P •
Tachometer/Hourmeter (Electric):				
O/B & 4-Stroke Gas Engines*	3"	0-6000 RPM	O/B ALT./COIL	57897P •
Tach/Hourmeter	3"	0-7000		68443P •
Trim Gauges (Outboard, I/O):				
Johnson/Evinrude (All) & Suzuki	2"	UP-DOWN	BY ENG. MFR.	58431P •
4-stroke 2002 & Up				
Honda	2"	UP-DOWN	BY ENG. MFR.	68359P
Mercury O/B & I/O, Mariner, Force, Cobra, Volvo DP & SX, Yamaha 2001 & Up	2"	UP-DOWN	BY ENG. MFR.	57905P •
Yamaha Outboards pre-2001	2"	UP-DOWN	BY ENG. MFR.	61748P •
Voltmeter-12 Volt:	2"	8-18 VDC	NONE REQ'D	57901P •
Water Pressure Kits (Outboard):**	2"	40 PSI	INCLUDES "WP"	68357P •
(Each kit includes fittings and 20 feet of tubing)	2"	30 PSI	INCLUDES "WP"	61238P •
Water Temp. Kit (Outboard):**				
(For all electric-start outboards)	2"	100-220°F	INCLUDES "J"	58862P •
Water Temp. Gauge (I/O, I/B):	2"	120-240°F	REQUIRES "D"	57904P •
Ammeter, Amega 60-0-60	2"	60-0-60	NONE REQ'D	68356P •
Battery Condition Indicator, 12 VDC			NONE REQ'D	68361P •
Instrument Set "OUTBOARD"	Contains: 58255P, 57900P, 57902P, 57901P			68362P •
Instrument Set "INBOARD/STERNDRIVE"	Contains: 58255P, 57900P, 57902P, 57901P, 57904P, 57903P			68363P •
Twin Engine Add On IB/IO Gauge Kit	Contains: 58255P, 57901P, 57904P, 57903P			69722P •
Twin Engine Add On OB Gauge Kit	Contains: 58255P, 57901P			69721P •
Instrument Set OB w/Tach/Hr	Contains: 68443P, 57900P, 57902P, 57901P			69708P •
Instrument Set IB/IO w/Tach/Hr	Contains: 68443P, 57900P, 57902P, 57901P, 57904P, 57903P			69709P •

• Display Packaged Item

* Not tested for complete aftermarket ignition systems, will work with aftermarket replacement parts.

** Adapter (P/N 61886P) is required for Yamaha.

Use 4000 RPM tachometer or lower for diesel applications.

ARCTIC - Stylish white bezel design, black on white graphics, accurate and reliable, these tough instruments look good on all types of boats. Domed glass sheds water and resists scratching.



FEATURES:

- Instruments available for most outboards, stern drives and gasoline-powered inboards.
- Scratch-resistant domed glass lenses.
- Enhanced illumination: through-dial and perimeter lighting for excellent readability at night.
- Low-range speedometers.
- U.S. and metric scales, with ISO symbols, where appropriate.
- Optional add-on eyebrow or square bezels available (See Gauge Accessories for details).

SELECTION GUIDE:

GAUGE DESCRIPTION	SIZE	DIAL RANGE	SENDER CODE	PART NUMBER
Ammeter	2"	60-0-60	NONE REQ'D	68364P •
Fuel Gauge	2"	(E-F)	REQUIRES "F"	68365P •
Hourmeter	2"	10,000 hrs		68366P •
Eng Oil Pressure gauge 0-80 PSI	2"	0-80 PSI	REQUIRES "C"	68367P •
Water Pressure Kits (Outboard): (Each kit includes fittings and 20 feet of tubing).	2"	0-40 PSI	INCLUDES "WP"	68369P •
GPS Speedometer:				
35 MPH	3"	0-35 MPH	GPS RECEIVER	781-683-035P
60 MPH	3"	0-60 MPH	GPS RECEIVER	781-683-060P
80 MPH	3"	0-80 MPH	GPS RECEIVER	781-683-080P •
Speedo Kit 0-35 mph (inc Pitot and Hose)	3"	5-35 MPH	INCLUDES "G"	68370P •
Speedo Kit 0-65 mph (inc Pitot and Hose)	3"	10-65 MPH	INCLUDES "G"	68371P •
Speedo Kit 0-80 mph (inc Pitot and Hose)	3"	20-80 MPH	INCLUDES "G"	68372P •
Tachometer 0-4000 RPM Diesel Alt	3"	0-4000 RPM	ALTERNATOR	68373P •
Tachometer 0-7000 RPM	3"	0-7000 RPM	O/B ALT./COIL	68374P •
Tach/Hourmeter 0-7000 RPM Petrol/Gas	3"	0-7000 RPM	O/B ALT./COIL	68375P •
I/O, I/B Water Temp Gauge	2"	120-240°F	REQUIRES "D"	68376P •
Outboard Water Temp Kit (Cold-Hot)	2"	100-220°F	INCLUDES "J"	68377P •
Trim, Johnson/Evinrude (All) & Suzuki 4-stroke 2002 & Up	2"	UP-DOWN	BY ENG. MFR.	68378P •
Trim, Honda	2"	UP-DOWN	BY ENG. MFR.	68379P
Trim, Mercury O/B & I/O, Mariner, Force, Cobra, Volvo DP & SX, Yamaha 2001 & Up	2"	UP-DOWN	BY ENG. MFR.	68380P •
Trim, Yamaha Outboards pre-2001	2"	UP-DOWN	BY ENG. MFR.	68381P •
12v Voltmeter, 8-18 Volts	2"	8-18 VDC	NONE REQ'D	68383P •
12 Battery Condition Indicator	2"		NONE REQ'D	68384P •
System Check - Evinrude/Johnson	2"		BY ENG. MFR.	68385P •
Instrument Set "OUTBOARD"	Contains: 68374P, 68371P, 68365P, 68383P			68387P •
Instrument Set "INBOARD/STERNDRIVE"	Contains: 68374P, 68371P, 68365P, 68383P, 68376P, 68367P			68388P •
Instrument Set OB w/Tach/Hr	Contains: 68375P, 68371P, 68365P, 68383P			69710P •
Instrument Set IB/IO w/Tach/Hr	Contains: 68375P, 68371P, 68365P, 68383P, 68376P, 68367P			69711P •
Twin Engine Add On IB/IO Gauge Kit	Contains: 68374P, 68383P, 68376P, 68367P			69724P
Twin Engine Add On OB Gauge Kit	Contains: 68374P, 68383P			69723P

• Display Packaged Item

* Not tested for complete aftermarket ignition systems, will work with aftermarket replacement parts.

** Adapter (P/N 61886P) is required for Yamaha.

Use 4000 RPM tachometer or lower for diesel applications.

ECLIPSE - Smart white and blue graphics on a black dial background, these very low profile bezels follow the curve of the lense to eliminate water trapping. Design with domed glass sheds water and resists scratching.



FEATURES:

- Instruments available for most outboards, stern drives and gasoline-powered inboards.
- Scratch-resistant domed glass lenses.
- Perimeter lighting for excellent readability at night.
- U.S. and metric scales, with ISO symbols, where appropriate.
- Optional add-on eyebrow or square bezels available (See Gauge Accessories for details).

SELECTION GUIDE:

GAUGE DESCRIPTION	SIZE	DIAL RANGE	SENDER CODE	PART NUMBER
Ammeter	2"	60-0-60	NONE REQ'D	68389P •
Fuel Gauge	2"	(E-F)	REQUIRES "F"	68390P •
Hourmeter	2"	10,000 hrs		68391P •
Eng Oil Pressure gauge 0-80 PSI	2"	0-80 PSI	REQUIRES "C"	68392P •
Eng Oil Pressure gauge 0-100 PSI	2"	0-100 PSI	REQUIRES "C"	68393P •
Water Pressure Kits (Outboard): (Each kit includes fittings and 20 feet of tubing).	2"	0-40 PSI	INCLUDES "WP"	68394P •
GPS Speedometer:				
35 MPH	3"	0-35 MPH	GPS RECEIVER	781-684-035P
60 MPH	3"	0-60 MPH	GPS RECEIVER	781-684-060P
80 MPH	3"	0-80 MPH	GPS RECEIVER	781-684-080P •
Speedo Kit 0-35 mph (inc Pitot and Hose)	3"	5-35 MPH	INCLUDES "G"	68395P •
Speedo Kit 0-65 mph (inc Pitot and Hose)	3"	10-65 MPH	INCLUDES "G"	68396P •
Speedo Kit 0-80 mph (inc Pitot and Hose)	3"	20-80 MPH	INCLUDES "G"	68397P •
Tachometer 0-4000 RPM Diesel Alt	3"	0-4000 RPM	ALTERNATOR	68398P •
Tachometer 0-7000 RPM	3"	0-7000 RPM	O/B ALT./COIL	68399P •
Tach/Hourmeter 0-7000 RPM Petrol/Gas	3"	0-7000 RPM	O/B ALT./COIL	68400P •
I/O, I/B Water Temp Gauge	2"	120-240°F	REQUIRES "D"	68401P •
Outboard Water Temp Kit (Cold-Hot) - includes "J"	2"	100-220°F	INCLUDES "J"	68402P •
Trim, Johnson/Evinrude (All) & Suzuki 4-stroke 2002 & Up	2"	UP-DOWN	BY ENG. MFR.	68403P •
Trim, Honda	2"	UP-DOWN	BY ENG. MFR.	68404P
Trim, Mercury O/B & I/O, Mariner, Force, Cobra, Volvo DP & SX, Yamaha 2001 & Up	2"	UP-DOWN	BY ENG. MFR.	68405P •
Trim, Yamaha Outboards pre-2001	2"	UP-DOWN	BY ENG. MFR.	68406P •
12v Voltmeter, 8-18 Volts	2"	8-18 VDC	NONE REQ'D.	68408P •
12v Battery Condition Indicator	2"		NONE REQ'D.	68409P •
System Check - Evinrude/Johnson	2"		BY ENG. MFR.	68410P •
Instrument Set "OUTBOARD"	Contains: 68399P, 68396P, 68390P, 68408P			68412P •
Instrument Set "INBOARD/STERNDRIVE"	Contains: 68399P, 68396P, 68390P, 68408P, 68401P, 68392P			68413P •
Twin Engine Add On IB/IO Gauge Kit	Contains: 68399P, 68408P, 68401P, 68392P			69726P
Twin Engine Add On OB Gauge Kit	Contains: 68399P, 68408P			69725P
Instrument Set OB w/Tach/Hr	Contains: 68400P, 68396P, 68390P, 68408P			69712P •
Instrument Set IB/IO w/Tach/Hr	Contains: 68400P, 68396P, 68390P, 68408P, 68401P, 68392P			69713P •

• Display Packaged Item

* Not tested for complete aftermarket ignition systems, will work with aftermarket replacement parts.

** Adapter (P/N 61886P) is required for Yamaha.

Use 4000 RPM tachometer or lower for diesel applications.

HEAVY DUTY - A classic line for inboards including diesels, Heavy Duty includes mechanical water temperature and oil pressure gauges, ammeters, engine sync gauges* and a range of diesel tachometers, including a programmable tach/hourmeter.

*Module required, not included with gauge.



FEATURES:

- Classic white graphics and pointer on deep black faces.
- Low-profile polished stainless steel bezels.
- Perimeter lighting and scratch resistant glass lenses.
- Tachometers for diesels available.
- Several temperature and mechanical oil pressure gauges available.
- Programmable tach/hourmeter offered.
- Ideal replacement for Stewart-Warner® "Deluxe" instruments.
- Optional add-on eyebrow or square bezels available (See Gauge Accessories for details).

SELECTION GUIDE:

GAUGE DESCRIPTION	SIZE	DIAL RANGE	SENDER CODE	PART NUMBER
Ammeters:				
Direct Reading 40 Amp Range	2"	40-0-40A	NONE REQ'D.	80712P
Direct Reading 60 Amp Range	2"	60-0-60A	NONE REQ'D.	80710P •
Engine Synchronizer Gauge:	2"	Port-Starboard	REQUIRES "L"	80730P •
Fuel Gauge:	2"	E-1/2-F	REQUIRES "F"	80150P •
Hourmeter:	2"	10,000 Hrs.	NONE REQ'D.	82760P •
Oil Pressure Gauges (Electric):				
Oil Pressure 80 PSI	2"	0-80 PSI	REQUIRES "C"	80180P •
Oil Pressure 100 PSI	2"	0-100 PSI	REQUIRES "C"	80181P •
Oil Temperature Gauge (Electric):				
Oil Temperature 320°F	2"	140-320°F	REQUIRES "E"	80596P
Speedometer Kits:				
60 MPH (Pitot Type)	3"	10-60 MPH	INCLUDES "G"	80514P •
60 MPH (Pitot Type) Head Only	3"	10-60 MPH		80514PH
Tachometers (Electric):				
Diesel Alternator**	3"	0-3500 RPM	SEE "T"	82302P •
Diesel Magnetic Pickup, 90-180 Teeth	3"	0-3500 RPM	REQUIRES "B"	82303P •
Diesel Signaflex ***	3"	0-3500 RPM	SIGNAFLEX	82301P
O/B & 4-Stroke Gas Engines*	3"	0-6000 RPM	O/B ALT./COIL	82288P •
Water Temp. Gauges (Electric):				
Water Temp 240°F	2"	120-240°F	REQUIRES "D"	80590P •
Water Temp 280°F, Nylon	2"	100-280°F	REQUIRES "P"	80593P
Voltmeters - 12 & 24 Volt:				
12 Volt System	2"	10-16 VDC	NONE REQ'D.	80134P •
24 Volt System	2"	20-32 VDC	NONE REQ'D.	80131P •

• Display Packaged Item

* Not tested for complete aftermarket ignition systems, will work with aftermarket replacement parts.

** May require alternator tap.

*** Signaflex senders and drive tips are for domestic diesel engines only (not for Lehman, Renault, Volvo, Yanmar, etc.)

Use 4000 RPM tachometer or lower for diesel applications.



MARINE OIL PRESSURE AND TEMPERATURE SENDER INTERCHANGE



Illustration A
Oil Pressure Switch



Illustration B
Oil Pressure Sender



Illustration C
Temperature Sender



Illustration D
Temperature Switch



Illustration E
Safety Shut-Off Switch

PART NO.	Stewart Warner Part No.	Faria Part No.	Medallion Part No.	Datcon Part No.	VDO Part No.	Crusader Part No.	Mer cruiser Part No.	Volvo Part No.	BRP Part No.	VeeThree Part No.	Range	N.P.T. Thread Size	Terminal Type
OIL PRESSURE SWITCHES (ILLUSTRATION A)													
OP22900	364L-F										6 psi Trip	1/8-27	10-32 stud
OP22891	364K-F										15 psi Trip	1/8-27	10-32 stud
18-5894								3852215	0379948		9 psi Trip	1/8-27	Spade
OIL PRESSURE SENDERS (ILLUSTRATION B) - Code C													
18-5899	279-A	90512	A-2547	02504-00	360 801	700425	815425T	3857532	982650	IA15001	80 psi	1/8-27	10-32 stud
OP24301	279B-F	90519	A-2547-1	02505-00	360 811		850362			IA15016	100 psi	1/8-27	10-32 stud
OP24891	82514	90511	A-2622	02504-01				872064		IA15003	80 psi DS	1/8-27	10-32 stud
TEMPERATURE SWITCHES (ILLUSTRATION D)													
TS25101	83304				232011017088						200 Trip	3/8-18	1/4" blade
TEMPERATURE SENDERS (ILLUSTRATION C) - Code D													
18-5896	362CZ-D	90401	B-936							52320S010	240°	1/8-27	10-32 stud
TS26611	362AN-D	90402	B-936-1							52320S004	240°	1/4-18	10-32 stud
TS26621	362AJ-D	90403	B-936-2				97257A 1			52320S009	240°	3/8-18	10-32 stud
TS26631	362AH-D	90404	B-936-3			700427	97258A 1		171960	52320S003	240°	1/2-14	10-32 stud
TS26641		90406	B-936	02017	323094						240° DS	1/8-27	10-32 stud
TS26651	362BD-D		A-2618-2								240° DS	1/4-18	10-32 stud
18-5897	352BC-D		A-2618-3					872068		52320S018	240° DS	3/8-18	10-32 stud
18-5898	362BB-D		A-2618-4							52320S017	240° DS	1/2-14	10-32 stud
18-7513								3862500			239°	1/8-27	
OIL PRESSURE SAFETY SHUT-OFF SWITCH (ILLUSTRATION E)													
*OP72533												1/4-18	1/4" spade

• Retail Packaged Item

***Note: DS specifies Dual Station sender**

***3-wire hookup to starter, pump and ignition. I/O and inboard units require a method to shut off the electronic fuel pump when the engine fails or is shut down. This switch senses low oil pressure and shuts the fuel pump off.**

HOURMETERS



56966P
HOURMETER, ROUND
(2")



56967P
HOURMETER, RECT.
(Hole Size: 1.5" x 1")
Outside dimensions: 2.1" x 1.2"



56968P
SMALL ENGINE HOURMETER (W/ 5' SENSOR WIRE)
Replaces: Yamaha ENG-METER-2C-01
2 or 4 Stroke Gasoline
• No power or ground required



56969P
SMALL ENGINE TACH/HOURMETER (W/ 5' SENSOR WIRE)
Fits: 2 or 4 stroke, 2 Cylinders or Less
• No power or ground required



GAUGE ACCESSORIES

BEZELS

EYEBROW BEZELS - Our Eyebrow Bezels give any boat that sporty race boat look. Durable and corrosion proof, these chrome plated bezels attach directly to the gauge. The bezels can be rotated to any angle allowing you to customize the look of your dash.



FEATURES:

- Directly attach to the gauge
- No extra holes to drill
- Can be set at any angle
- Corrosion proof ABC/PVC construction
- Buy individually or in 4 or 6 gauge sets.

69380P
BEZEL KIT
For: 4 Gauge Kit
Contains:
69268P (x2) and 69269P (x2)



69381P
BEZEL KIT
For: 6 Gauge Kit
Contains:
69268P (x4) and 69269P (x2)



69268P
EYEBROW BEZEL
(2")



69269P
EYEBROW BEZEL (3")
3 3/8" I.D.



69270P
EYEBROW BEZEL
(5")



IA65476
ACCESSORY, AIRCRAFT BEZEL
(2")



IA65477
ACCESSORY, AIRCRAFT BEZEL (3")
3 3/8" I.D.

FUEL SENDERS (CODE F): 240-33 OHM RANGE



56948P
FUEL SENDER KIT (W/GAUGE)
 4-24" Tank



90424P
FUEL SENDER
 4-24" tank depth



64082
FUEL SENDER GASKET

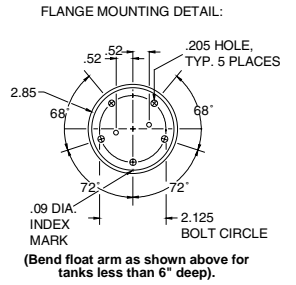
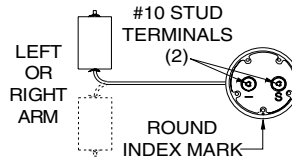
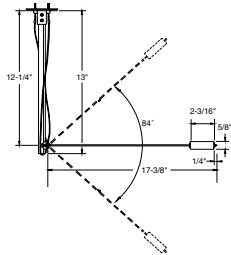

TACHOMETER ACCESSORIES (CODE B)



IH14767
TACH HARNESS
 For: Evinrude/Johnson



IH15105
TACH HARNESS
 For: Mariner/Merc O/B

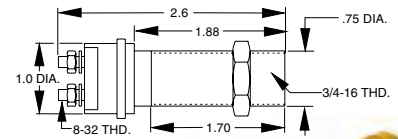

1507678P
MAGNETIC PROXIMITY SENDER

SPEEDOMETER SENDERS AND ACCESSORIES (CODE G)



56973P
PITOT
 For: 30-80 mph Speedometers



59677P
PACK O'PITOTS
 (Package of 12)



67437P
PITOT HOSE KIT (W/ HARDWARE)
 • 25' of hose
 0.150" I.D. • 0.250" O.D.



56353P
PITOT TUBING
 For: 30-80 mph, 100'
 0.150" I.D. • 0.250" O.D.



67457P
PITOT TUBING
 25'
 0.150" I.D. • 0.250" O.D.

ENGINE SYNCHRONIZER MODULE (CODE L)

1508370P
ENG SYNCH MODULE
 4-Cycle Gas



CODE T

Diesel Alternator Tachometers alternator

NOTE: Alternator must have an AC tap, usually marked "AC", "R" or "W". If such a tap is not present, a local alternator repair shop can usually add one.

You will need to know the number of magnetic poles in your alternator.

Consult the alternator maker or local alternator repair shop if you do not know this.

Also, you will have to calculate the pulley ratio from crankshaft to alternator.

Tachometers are factory calibrated for several combinations of poles and pulley ratios, but in almost all cases you will need a Portable Master Shop Tachometer for initial calibration.

DIESEL ALTERNATOR EXAMPLES

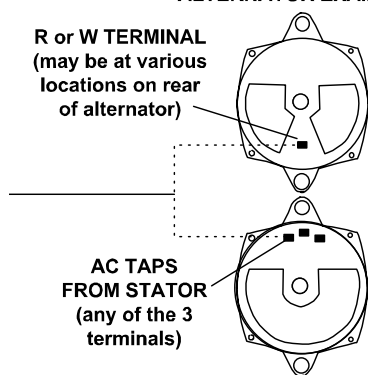







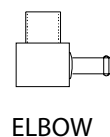
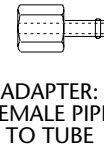
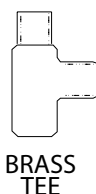
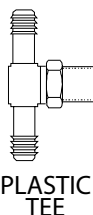

CODE WP

Water Pressure (0-15/0-30/0-40/0-60 PSI):
 (Included with water pressure gauge kits, which contain the instrument, 20 feet of pitot tubing and the parts shown at right.)

NOTE: For Yamaha, also order adapter **61886P**



MISCELLANEOUS ACCESSORIES

 61886P YAMAHA ADAPTER FOR WP KIT/TEMP SENDER I.D. 1/8" NPT	 6219371P DROPPING RESISTOR 24-12V, 2" Gauges	 1827871P BULB & SOCKET KIT	 10860 BLANK GAUGE INSERT (2")
 IA62995 LIGHT KIT, WEDGE BASE 12VDC	 FS45430 FUSE HOLDER, PANEL MOUNT	 IA55009 Z BRACKET O/B Temp. Sender	 1502778 RUDDER ANGLE IND. SENDER, SINGLE STATION

IGNITION SWITCHES FOR WORLD OUTBOARD MOTORS

- Exact OEM replacement installation
- Ideal for DFI, EFI and MPI engines
- Heavy duty potted construction
- Minimal bleed per circuit
- Molded umbrella type key



MP51090**
MP51092 – BULK 100 PCS/CTN
 IGNITION SWITCH
 3 Position Magneto – OFF- RUN-START
 PUSH to Choke
 Replaces: Mercury 87-17009A5



MP52000**
MP52002 – BULK 100 PCS/CTN
 IGNITION SWITCH
 3 Position Magneto – OFF- RUN-START
 PUSH to Choke
 Replaces: Mercury 87-88107A5



MP51010**
MP51012 – BULK 100 PCS/CTN
 IGNITION SWITCH
 Suzuki 2 & 4 stroke Outboards
 Replaces: 37110-99E00
 Colors on wires match factory color codes



MP51020**
MP51022 – BULK 100 PCS/CTN
 IGNITION SWITCH
 Yamaha Control Box 2 & 4 stroke
 Replaces: 703-82510-12-00
 Colors on wires match factory color codes



MP51030**
MP51032 – BULK 100 PCS/CTN
 IGNITION SWITCH
 Yamaha Dash Mount 2 & 4 stroke
 Dual Engine Application
 Replaces: 61B-82510-01-00,
 61B-82510-00-00
 Colors on wires match factory color codes



MP51040**
MP51042 – BULK 100 PCS/CTN
 IGNITION SWITCH
 Yamaha Control Box 2 & 4 stroke
 Push to Choke
 Replaces: 703-82510-43-00
 Colors on wires match factory color codes



MP51050**
MP51052 – BULK 100 PCS/CTN
 IGNITION SWITCH
 Yamaha Dash Mount 2 & 4 stroke
 Dual Engine Application, Push to Choke
 Replaces: 6K1-82510-06-00
 Colors on wires match factory color codes

** Display Packaged

Sierra offers the most complete selection of high quality polyester and brass ignition switches for the marine industry.

Marine grade glass-filled polyester switches

- Maximum corrosion protection – eliminates oxidation
- Inner seal between cylinder lock and contact plate
- Non-conductive housing eliminates potential shorts
- 20 Amp rating
- 2, 3 and 4 position switches
- Switches for magneto and conventional ignitions

Brass ignition switches

- Corrosion resistant construction
- Up to 15 Amp rating
- 2, 3 and 4 position switches
- Switches for magneto and conventional ignitions

** Display Packaged

4 POSITION CONVENTIONAL - ACCESSORY - OFF - RUN - START



MP39800**
MP39802 – BULK 100 PCS/CTN

DESCRIPTION	
Material	Polyester
Length	Long: 1 1/8" maximum panel thickness
Terminal Type	4 Blade
Back Up Nut	Brass
Face Nut	Hex black plastic face nut
Hole Size	7/8"
Rated:	
Ignition	15 Amp @ 12v DC
Solenoid	30 Amp @ 12v DC
Accessory	15 Amp @ 12v DC

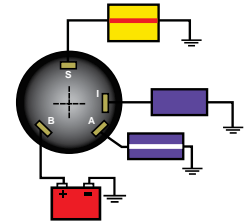

MP41040**
MP41042 – BULK 100 PCS/CTN

DESCRIPTION	
Material	Polyester
Length	Long: 1 1/8" maximum panel thickness
Terminal Type	4 Screw Tab
Back Up Nut	Brass
Face Nut	Knurled black plastic w/rubber cap
Hole Size	7/8"
Rated:	
Ignition	15 Amp @ 12v DC
Solenoid	30 Amp @ 12v DC
Accessory	15 Amp @ 12v DC

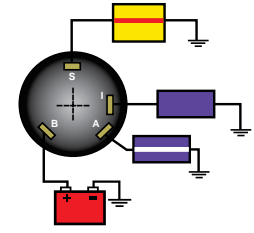

MP39070**
MP39072 – BULK 100 PCS/CTN

DESCRIPTION	
Material	Brass
Length	Long: 1" maximum panel thickness
Terminal Type	4 Screw Tab
Back Up Nut	Brass
Face Nut	Knurled black chrome w/rubber cap
Hole Size	7/8"
Rated:	
Ignition	15 Amp @ 12v DC
Solenoid	30 Amp @ 12v DC
Accessory	15 Amp @ 12 VDC

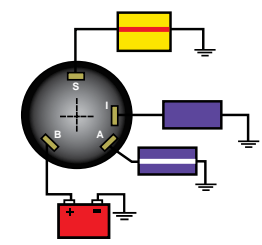

MP39700-1**
MP39702-1 – BULK 100 PCS

DESCRIPTION	
Material	Polyester
Length	Long: 1 1/8" maximum panel thickness
Terminal Type	4 Color Code Wires
Back Up Nut	Brass
Face Nut	Knurled black plastic w/rubber cap
Hole Size	7/8"
Rated:	
Ignition	15 Amp @ 12 VDV
Solenoid	30 Amp @ 12 VDC
Accessory	15 Amp @ 12 VDC

WIRE & DIAGRAM COLOR CODES

- Red - Battery
- Yellow w/ Red Stripe - Solenoid
- Purple - Ignition
- Purple w/ White Stripe - Accessory
- Black - Magneto Ground
- Black w/ Yellow Stripe - Magneto
- Yellow w/ Black Stripe - Choke

4 POSITION CONVENTIONAL - ACCESSORY - OFF - RUN - START



MP41020**
MP41022 – BULK 100 PCS/CTN

DESCRIPTION	
Material	Brass
Length	Long: 1" maximum panel thickness
Terminal Type	4 Screw Tab
Back Up Nut	Brass
Face Nut	Hex Chrome Face Nut
Hole Size	7/8"
Rated:	
Ignition	15 Amp @ 12v DC
Solenoid	30 Amp @ 12v DC
Accessory	15 Amp @ 12 VDC

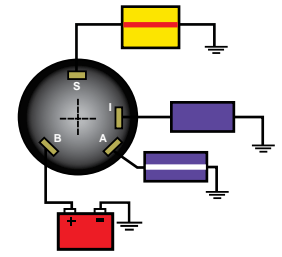

UN12140**
UN12142 – BULK 100 PCS/CTN

DESCRIPTION	
Material	Die Cast Zinc
Length	Short: 5/8" maximum panel thickness
Terminal Type	4-Threaded Stud
Back Up Nut	Die Cast Zinc
Face Nut	Knurled Chrome Face Nut
Hole Size	9/16"
Rated:	
Ignition	15 Amp @ 12v DC
Solenoid	30 Amp @ 12v DC
Accessory	15 Amp @ 12v DC

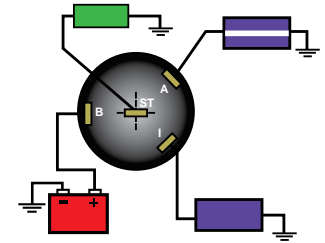

3 POSITION CONVENTIONAL - OFF - RUN - START



MP39060-1**
MP39062-1 – BULK 100 PCS/CTN

DESCRIPTION	
Material	Brass
Length	Long: 1 1/8" maximum panel thickness
Terminal Type	3 Screw Tab
Back Up Nut	Brass
Face Nut	Hex Chrome Face Nut
Hole Size	7/8"
Rated:	
Ignition	15 Amp @ 12v DC
Solenoid	30 Amp @ 12v DC

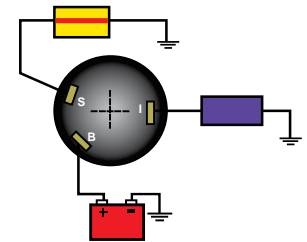

MP39080-1**
MP39082-1 – BULK 100 PCS/CTN

DESCRIPTION	
Material	Brass
Length	Long: 1 1/8" maximum panel thickness
Terminal Type	3 Screw Tab
Back Up Nut	Brass
Face Nut	Knurled black plastic w/rubber cap
Hole Size	7/8"
Rated:	
Ignition	15 Amp @ 12v DC
Solenoid	30 Amp @ 12v DC

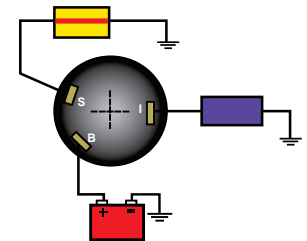

MP39120**
MP39122 – BULK 100 PCS/CTN

DESCRIPTION	
Material	Polyester
Length	Long: 1 1/8" maximum panel thickness
Terminal Type	3 Screw Tab
Back Up Nut	Brass
Face Nut	Hex black plastic face nut
Hole Size	7/8"
Rated:	
Ignition	15 Amp @ 12v DC
Solenoid	30 Amp @ 12v DC

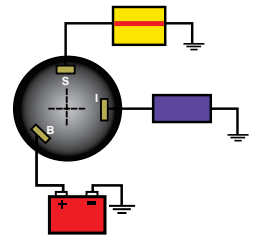

MP39780**
MP39782 – BULK 100 PCS/CTN

DESCRIPTION	
Material	Polyester
Length	Short: 5/8" maximum panel thickness
Terminal Type	3 Screw Tab
Back Up Nut	Brass
Face Nut	Hex black plastic face nut
Hole Size	7/8"
Rated:	
Ignition	15 Amp @ 12v DC
Solenoid	30 Amp @ 12v DC

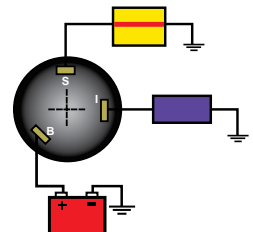

** Display Packaged

3 POSITION CONVENTIONAL - OFF - RUN - START



MP39200**
MP39202 – BULK 100 PCS/CTN

DESCRIPTION	
Material	Polyester
Length	Long: 1 1/8" maximum panel thickness
Terminal Type	3 Screw Tab
Back Up Nut	Brass
Face Nut	Knurled black plastic w/rubber cap
Hole Size	7/8"
Rated:	
Ignition	15 Amp @ 12v DC
Solenoid	30 Amp @ 12v DC

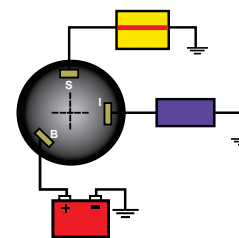

MP39770**
MP39772 – BULK 100 PCS/CTN

DESCRIPTION	
Material	Polyester
Length	Long: 1 1/8" maximum panel thickness
Terminal Type	3 Blade
Back Up Nut	Brass
Face Nut	Knurled black plastic w/rubber cap
Hole Size	7/8"
Rated:	
Ignition	15 Amp @ 12v DC
Solenoid	30 Amp @ 12v DC

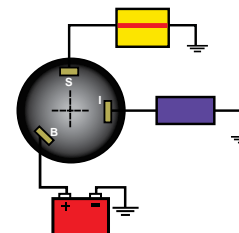

MP41030**
MP41032 – BULK 100 PCS/CTN

DESCRIPTION	
Material	Polyester
Length	Short: 5/8" maximum panel thickness
Terminal Type	3 Screw Tab
Back Up Nut	Brass
Face Nut	Knurled black plastic w/rubber cap
Hole Size	7/8"
Rated:	
Ignition	15 Amp @ 12v DC
Solenoid	30 Amp @ 12v DC

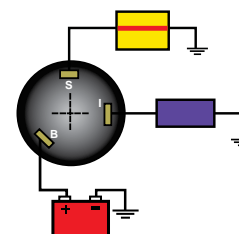

2 POSITION CONVENTIONAL - OFF - RUN USE WITH SEPARATE STARTER BUTTON



MP39010
MP39012 – BULK 100 PCS/CTN

DESCRIPTION	
Material	Brass
Length	Short: 5/8" maximum panel thickness
Terminal Type	2 Screw Tab
Back Up Nut	Brass
Face Nut	Hex Chrome Face Nut
Hole Size	3/4"
Rated:	
Ignition	5 Amp @ 12 VDV

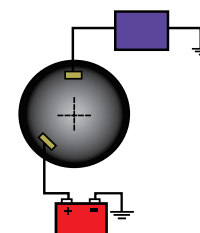

MP39020**
MP39022 – BULK 100 PCS/CTN

DESCRIPTION	
Material	Brass
Length	Long: 1 1/8" maximum panel thickness
Terminal Type	2 Screw Terminal
Back Up Nut	Brass
Face Nut	Hex Chrome Face Nut
Hole Size	7/8"
Rated:	
Ignition	15 Amp @ 12v DC

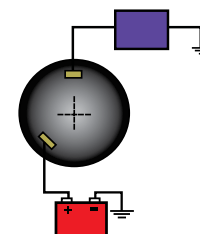

MP39820-1 – INDIVIDUAL BOX
MP39822-1 – BULK 100 PCS/CTN

DESCRIPTION	
Material	Brass
Length	Long: 1 1/8" maximum panel thickness
Terminal Type	2 Screw Terminal
Back Up Nut	Brass
Face Nut	Knurled Chrome Plated w/rubber cap
Hole Size	7/8"
Rated:	
Ignition	15 Amp @ 12v DC

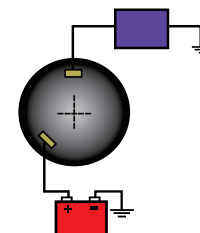

WIRE & DIAGRAM COLOR CODES

Red - Battery
Black - Magneto Ground

Yellow w/ Red Stripe - Solenoid
Black w/ Yellow Stripe - Magneto

Purple - Ignition
Yellow w/ Black Stripe - Choke

Purple w/ White Stripe - Accessory

** Display Packaged



MP39710-1**
MP39712-1 - BULK 100 PCS
PUSH TO CHOKE

DESCRIPTION	
Material	Polyester
Length	Short: 5/8" maximum panel thickness
Terminal Type	7 Color Code Wires
Back Up Nut	Brass
Face Nut	Knurled black plastic w/rubber cap
Hole Size	7/8"
Rated:	
Ignition	15 Amp @ 12 VDV
Solenoid	30 Amp @ 12 VDC
Accessory	15 Amp @ 12 VDC
Choke	7 Amp @ 12 VDC



For Outboard engines without choke circuit

MP39720-1**
MP39722-1 - BULK 100 PCS

DESCRIPTION	
Material	Polyester
Length	Short: 5/8" maximum panel thickness
Terminal Type	6 Color Code Wires
Back Up Nut	Brass
Face Nut	Knurled black plastic w/rubber cap
Hole Size	7/8"
Rated:	
Ignition	15 Amp @ 12 VDV
Solenoid	30 Amp @ 12 VDC
Accessory	15 Amp @ 12 VDC



MP41010**
MP41012 - BULK 100 PCS/CTN
PUSH TO CHOKE

DESCRIPTION	
Material	Polyester
Length	Short: 5/8" maximum panel thickness
Terminal Type	7 Screw Tab
Back Up Nut	Brass
Face Nut	Hex black plastic face nut
Hole Size	7/8"
Rated:	
Ignition	15 Amp @ 12v DC
Solenoid	30 Amp @ 12v DC
Choke	7 Amp @ 12v DC
Accessory	15 Amp @ 12v DC

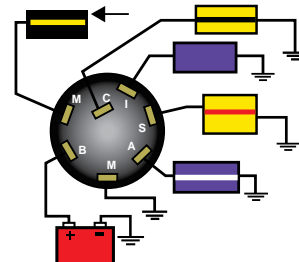

MP41080**
MP41082 - BULK 100 PCS/CTN
PUSH TO CHOKE

DESCRIPTION	
Material	Polyester
Length	Short: 5/8" maximum panel thickness
Terminal Type	6 Screw Tab, 1 Boss Screw
Back Up Nut	Plastic
Face Nut	Hex black plastic face nut
Hole Size	7/8"
Rated:	
Ignition	15 Amp @ 12v DC
Solenoid	30 Amp @ 12v DC
Choke	7 Amp @ 12v DC
Accessory	15 Amp @ 12v DC

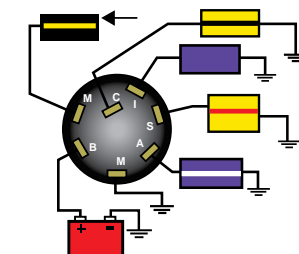

MP39730**
MP39732 - BULK 100 PCS

For Outboard engines without choke circuit

DESCRIPTION	
Material	Polyester
Length	Short: 5/8" maximum panel thickness
Terminal Type	6 Screw Tab
Back Up Nut	Brass
Face Nut	Hex black plastic face nut
Hole Size	7/8"
Rated:	
Ignition	15 Amp @ 12v DC
Solenoid	30 Amp @ 12v DC
Accessory	15 Amp @ 12v DC

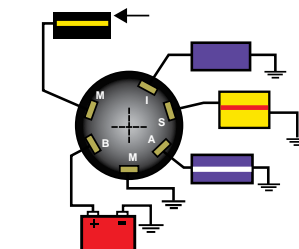

3 POSITION MAGNETO - OFF - RUN - START



MP39760**
MP39762 - BULK 100 PCS/CTN
PUSH TO CHOKE

DESCRIPTION	
Material	Polyester
Length	Short: 5/8" maximum panel thickness
Terminal Type	5 Screw Tab, 1 Boss Screw
Back Up Nut	Plastic
Face Nut	Hex black plastic face nut
Hole Size	7/8"
Rated;	
Ignition	15 Amp @ 12v DC
Solenoid	30 Amp @ 12v DC
Choke	7 Amp @ 12v DC

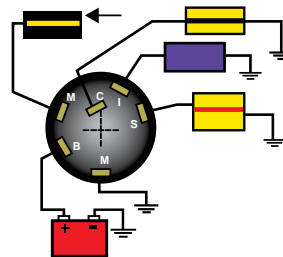

MP41000**
MP41002 - BULK 100 PCS/CTN
PUSH TO CHOKE

DESCRIPTION	
Material	Polyester
Length	Short: 5/8" maximum panel thickness
Terminal Type	6 Screw Tab
Back Up Nut	Brass
Face Nut	Hex black plastic face nut
Hole Size	7/8"
Rated;	
Ignition	15 Amp @ 12v DC
Solenoid	30 Amp @ 12v DC
Choke	7 Amp @ 12v DC

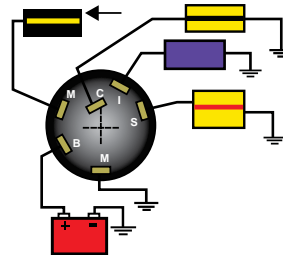

For Outboard engines without choke circuit

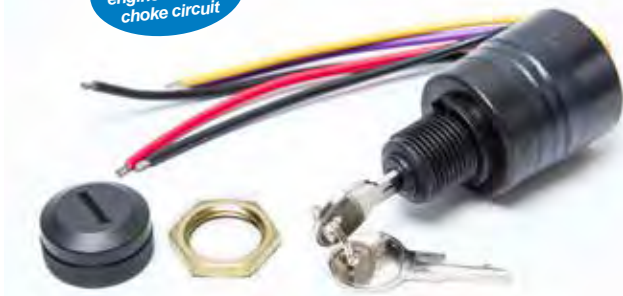

MP39740-1**
MP39742-1 - BULK 100 PCS

DESCRIPTION	
Material	Polyester
Length	Short: 5/8" maximum panel thickness
Terminal Type	5 Color Code Wires
Back Up Nut	Plastic
Face Nut	Knurled black plastic w/rubber cap
Hole Size	7/8"
Rated;	
Ignition	15 Amp @ 12 VDV
Solenoid	30 Amp @ 12 VDC
Accessory	15 Amp @ 12 VDC



MP41090-1**
MP41092-1 - BULK 100 PCS
PUSH TO CHOKE

(Colors on switch wires match factory color codes.)

DESCRIPTION	
Material	Polyester
Length	Short: 5/8" maximum panel thickness
Terminal Type	6 Color Coded Wires
Back Up Nut	Brass
Face Nut	Knurled black plastic w/rubber cap
Hole Size	7/8"
Rated;	
Ignition	15 Amp @ 12v DC
Solenoid	30 Amp @ 12v DC
Choke	7 Amp @ 12v DC



MP41070-2**
MP41072-2 - BULK 100 PCS/CTN
PUSH TO CHOKE / MERCURY CONTROL BOX APPLICATIONS

(Colors on switch wires match factory color codes.)

DESCRIPTION	
Material	Polyester
Length	Short: 5/8" maximum panel thickness
Terminal Type	6 Color Coded Wire Leads/Potted
Back Up Nut	Not Required
Face Nut	Hex black plastic face nut
Hole Size	7/8"
Rated;	
Ignition	15 Amp @ 12v DC
Solenoid	30 Amp @ 12v DC
Choke	7 Amp @ 12v DC

WIRE & DIAGRAM COLOR CODES

- Red - Battery
- Yellow w/ Red Stripe - Solenoid
- Purple - Ignition
- Purple w/ White Stripe - Accessory
- Black - Magneto Ground
- Black w/ Yellow Stripe - Magneto
- Yellow w/ Black Stripe - Choke

** Display Packaged

3 POSITION MAGNETO - OFF - RUN - START

MP52000**
MP52002 - BULK 100 PCS
PUSH TO CHOKE

DESCRIPTION	
Material	Polyester
Length	Short: 5/8" maximum panel thickness
Terminal Type	6 Color Coded Wire Leads/Potted
Back Up Nut	Plastic
Face Nut	Hex black plastic face nut
Hole Size	7/8"
Rated;	
Ignition	15 Amp @ 12v DC
Solenoid	30 Amp @ 12v DC
Choke	7 Amp @ 12v DC



MP51090**
MP51092 - BULK 100 PCS
PUSH TO CHOKE

DESCRIPTION	
Material	Polyester
Length	Short: 5/8" maximum panel thickness
Terminal Type	6 Color Coded Wire Leads/Potted
Back Up Nut	Not Required
Face Nut	Hex black plastic face nut
Hole Size	7/8"
Rated;	
Ignition	15 Amp @ 12v DC
Solenoid	30 Amp @ 12v DC
Choke	7 Amp @ 12v DC



MP39090**
MP39092 - BULK 100 PCS/CTN
PUSH TO CHOKE

DESCRIPTION	
Material	Polyester
Length	Long: 1 1/8" maximum panel thickness
Terminal Type	6 Screw Tab
Back Up Nut	Anodized steel
Face Nut	Hex plastic face nut w/snap on rubber cap
Hole Size	7/8"
Rated;	
Ignition	15 Amp @ 12v DC
Solenoid	30 Amp @ 12v DC
Choke	7 Amp @ 12v DC

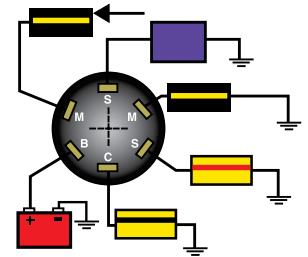

MP39040**
MP39042 - BULK 100 PCS/CTN

DESCRIPTION	
Material	Brass
Length	Long: 1 1/8" maximum panel thickness
Terminal Type	5 Screw Tab
Back Up Nut	Brass
Face Nut	Hex Chrome Face Nut
Hole Size	7/8"
Rated;	
Ignition	10 Amp @ 12v DC
Solenoid	30 Amp @ 12v DC

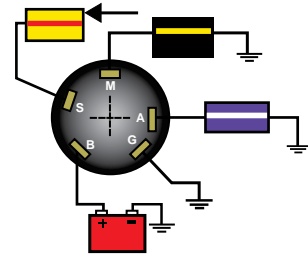

MP39100**
MP39102 - BULK 100 PCS/CTN

DESCRIPTION	
Material	Polyester
Length	Long: 1 1/8" maximum panel thickness
Terminal Type	5 Screw Tab
Back Up Nut	Brass
Face Nut	Hex black plastic face nut
Hole Size	7/8"
Rated;	
Ignition	15 Amp @ 12v DC
Solenoid	30 Amp @ 12v DC

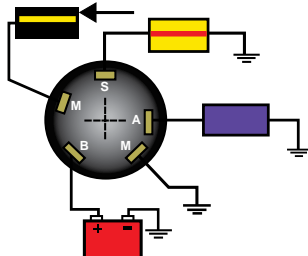

MP39830**
MP39832 - BULK 100 PCS/CTN

DESCRIPTION	
Material	Polyester
Length	Long: 1 1/8" maximum panel thickness
Terminal Type	6 Screw Tab
Back Up Nut	Brass
Face Nut	Hex black plastic face nut
Hole Size	7/8"
Rated;	
Ignition	15 Amp @ 12v DC
Solenoid	30 Amp @ 12v DC

*Terminal to power separately controlled choke circuit

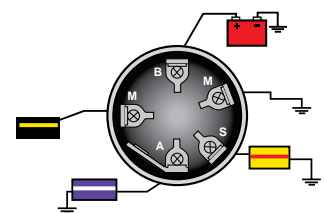

EMERGENCY ENGINE CUT-OFF SWITCHES

- Kills ignition when lanyard is pulled
- For use with conventional or magneto ignitions
- Unique design of MP40960 and MP40970 keeps plunger down when lanyard connected
- Seals out moisture
- Makes reconnection easier
- Panel thickness up to 1/4"



18-65450
EMERGENCY CUT-OFF SWITCH
 Replaces: Yamaha 6E9-82575-02-00
 Push button kill feature
 Circuit closed with lanyard off.
 Use **MP28860** replacement lanyard.



MP28870**
EMERGENCY CUT-OFF SWITCH
 Replaces: OMC 585134
 Circuit closed with lanyard off.
 Use **MP28900** replacement lanyard.
MP28872-1
 "Bulk" - 100 pieces per carton



MP40950**
EMERGENCY CUT-OFF SWITCH
 4 terminals allow selection of normally open or normally closed circuit.
 Use **MP40990** replacement lanyard.



MP40960**
EMERGENCY CUT-OFF SWITCH
 4 terminals allow selection of normally open or normally closed circuit.
 Use **MP40980** replacement lanyard.
MP40962
 "Bulk" - 100 pieces per carton



MP40970-1**
EMERGENCY CUT-OFF SWITCH
 4 terminals allow selection of normally open or normally closed circuit.
 Use **MP40990** replacement lanyard.
MP40972-1
 "Bulk" - 100 pieces per carton.

REPLACEMENT LANYARDS



18-1282
LANYARD
 Replaces: OMC 398602
 Tiller Steer Models - ALL



18-1294
DESS PROGRAMMABLE SAFETY LANYARD
 Replaces: Sea-Doo/BRP 278-002-199, 1
 Fits: All BRP crafts equipped with DESS.
 Programmable with STATS



MP28850**
LANYARD
 Replaces: Honda, Mercury, Mariner, BRP, Yamaha, Suzuki, OMC



MP28860**
LANYARD
 Replaces: Yamaha 682-82556-00-00



MP28880**
LANYARD
 Replaces: OMC 432230
 1995-Older



MP28890**
LANYARD
 Replaces: OMC 176288
 1996 and Newer



MP28900**
LANYARD
 Replaces: OMC 432230
 1995-Older
MP28902-1 "Bulk"- 100 pieces per carton



MP40980**
LANYARD
MP40982
 "Bulk"- 100 pieces per carton



MP40990**
LANYARD
MP40992
 "Bulk"- 100 pieces per carton

FACE AND BOOT NUTS



MP39190**
WEATHER PROOF BOOT NUT
 Fits: All Sierra polyester ignition switches, 1996 & later. 13/16"-16 Thread. Rotating rubber seal. Seals out moisture and dust from lock cylinder



MP39270**
FACENUT
 For polyester ignition switches MP39100 thru MP39120. Nut has extra long threads for positive engagement on mounting bushing for early (Pre-1995) style with 13/16"-20 thread ONLY!

** Display Packaged

ROTSWITCH® ROTARY SWITCHES

- Unique ergonomic design, styling and performance
- 20 AMP @ 12 Volts DC
- Durable cam design for long life
- UV stabilized thermoplastic housing
- Knob acts as umbrella - Silicone lip seal mates with stalk
- Separate light modules optional
- Replaces toggle or rocker switches with minimal panel alterations
- 1/2" hole size

** Display Packaged



RotoSwitch® provides illumination with different colors providing immediate visual information of switch position.

	BULK ^① NUMBER	PART NUMBER	NUMBER OF BATTERY FEEDS	CIRCUITS "ON"			
				45° COUNTER CLOCKWISE	12 O'CLOCK	45° CLOCKWISE	90° CLOCKWISE
	MP78712 *MP59012	MP78710**	1	—	OFF	#1	—
	MP78722	MP78720	1	—	OFF	#1 (M)	—
	*MP59032	MP78730**	1	#1	OFF	#2	—
	MP59042	MP78740	1	#1 (M)	OFF	#2 (M)	—
	MP78802 *MP59102	MP78800**	2	#1	OFF	#2	—
	MP78822 *MP59122	MP78820	1	#2	OFF	#1&2	—
	*MP59132	MP78830	1	—	OFF	#2	#1&2
	*MP59162	MP78860**	1	OFF	#1	#2	#1&2

①Bulk - 100 pieces per carton. * Switch Only - No Knob (M)=MOMENTARY

REPLACEMENT KNOBS

All include rubber umbrella seal. Original Ergotech design knob.



MP79740
MP79742 (BULK 100 PCS/CTN)
Black knob with black indicator.



MP79760**
MP79762 (BULK 100 PCS/CTN)
Black knob with light tube. Use with illumination module.



MP78372
Black knob with light tube for use with light module.

Mounting Accessories for RotoSwitch®.



MP78960
MP78962 (BULK 100 PCS/CTN)
Anti-rotation collar. Use when installing non-illuminated RotoSwitches in very thin dash panels. This adapter prevents the switch from "slipping" if excessive force is used to actuate the switch.

ILLUMINATION MODULES

Add flexibility and function to any installation of RotoSwitch® rotary switches. By using a variety of colored lenses, the status of each switch – "Off", "On-1", "On-2" – can instantly be determined.



MP78870**
MP78872 (BULK 100 PCS/CTN)



MP78910**
MP78912 (BULK 100 PCS/CTN)



MP78942 ①



MP78950
MP78952

C = Clear R = Red G = Green B = Black

** Display Packaged

STANDARD WEATHER RESISTANT CONTURA® V ROCKER SWITCHES

- Non-corrosive plastic construction
- Protects against dust and prolonged spray to IP66 and IP68 standards
- Meets UL 1500, ISO 8846 ignition protection requirements
- Supplied with neoprene mounting gasket
- Removable actuators
- Brass blade terminals, silver contacts - Rated: 20 amps @ 12 VDC



RK22180
ACTUATOR
BLACK CONTURA V
(2EA)

Diagram	Part Number	Switch Function
	RK19210**	ON-OFF SPST
	RK19220**	ON-OFF-ON SPDT
	RK19230**	MOM ON-OFF SPST
	RK19240**	MOM ON-OFF-MOM ON DPDT

** Display Packaged

ILLUMINATED WEATHER RESISTANT CONTURA® V ROCKER SWITCHES

- Non-corrosive plastic construction
- Protects against dust and prolonged spray to IP66 and IP68 standards
- Meets UL 1500, ISO 8846 ignition protection requirements
- Supplied with neoprene mounting gasket
- Illuminates red in "ON" position
- Removable actuators
- Brass blade terminals, silver contacts - Rated: 20 amps @ 12 VDC



DIAGRAM	PART NUMBER	SWITCH FUNCTION
	RK19310**	ON-OFF SPST
	RK19320**	ON-OFF-ON SPDT



RK22190**
ACTUATOR
BLACK CONTURA V
WITH LENS (2EA)



RK22200**
ACTUATOR
BLACK CONTURA V
WITH 2 LENS (2EA)



RK22290**
ACTUATOR
REMOVAL TOOL

** Display Packaged

STANDARD WEATHER RESISTANT CONTURA® III ROCKER SWITCHES



- Non-corrosive plastic construction
- Protects against dust and prolonged spray to IP66 and IP68 standards
- Meets UL 1500, ISO 8846 ignition protection requirements
- Supplied with neoprene mounting gasket
- Removable actuators
- Brass blade terminals, silver contacts - Rated: 20 amps @12 VDC

DIAGRAM	ONE PADDLE PART #	TWO PADDLES (GREY & BLACK) PART #	SWITCH FUNCTION
	BLACK RK19680**	RK19680TP**	ON-OFF SPST
	BLACK RK19690**	RK19690TP**	ON-OFF-ON SPDT
	BLACK RK19720**	RK19710TP**	MOM ON-OFF SPST
	BLACK RK19760**	RK19750TP**	MOM ON-OFF-MOM ON SPDT
	BLACK RK19860**	RK19850TP**	MOM ON-OFF-MOM ON DPDT
	BLACK RK19880**	RK19870TP**	MOM ON-OFF DPST



****RK22100**
ACTUATOR
BLACK CONTURA III
(2EA)



****RK22110**
ACTUATOR
GRAY CONTURA III
(2EA)

** Display Packaged

ILLUMINATED WEATHER RESISTANT CONTURA® III ROCKER SWITCHES



- Non-corrosive plastic construction
- Protects against dust and prolonged spray to IP66 and IP68 standards
- Meets UL 1500, ISO 8846 ignition protection requirements
- Supplied with neoprene mounting gasket
- Illuminates red in "ON" position - 12V LED bulb
- Removable actuators
- Brass blade terminals, silver contacts - Rated: 20 amps @12 VDC

DIAGRAM	ONE PADDLE PART #	TWO PADDLES (GREY & BLACK) PART #	SWITCH FUNCTION
	BLACK RK19700**	RK19700TP**	OFF-ON SPST
	BLACK RK19780**	RK19770TP**	MOM ON-OFF-ON SPDT
	BLACK RK19820	RK19810TP**	MOM ON-OFF-ON DPDT
	BLACK RK19910**	RK19890TP**	OFF-ON DPST
	BLACK RK19740**	RK19730TP**	ON-OFF-ON SPDT
	BLACK RK19840**	RK19830TP**	ON-OFF-ON DPDT



RK22120**
ACTUATOR
BLACK CONTURA III
WITH LENS (2EA)



RK22130**
ACTUATOR
GRAY CONTURA III
WITH LENS (2EA)



RK22140**
ACTUATOR
BLACK CONTURA III
WITH 2 LENSES (2EA)



RK22150**
ACTUATOR
GRAY CONTURA III
WITH 2 LENSES (2EA)

** Display Packaged

STANDARD WEATHER RESISTANT CONTURA® II ROCKER SWITCHES



- Protects against dust and prolonged spray to IP66 and IP68 standards
- Supplied with neoprene mounting gasket
- Removable actuators
- Brass blade terminals, silver contacts - Rated: 20 amps @12 VDC

DIAGRAM	PART NUMBER	SWITCH FUNCTION
	RK19400-1**	OFF-ON SPST
	RK19410-1**	OFF-MOM ON SPST
	RK19410-RED**	OFF-MOM ON SPST Red actuator - for horn
	RK19420-1**	ON-OFF-ON SPDT

DIAGRAM	PART NUMBER	SWITCH FUNCTION
	RK19920-1**	MOM ON-OFF-ON SPDT
	RK19930-1**	MOM ON-OFF-ON DPDT
	RK19430-1**	MOM ON-OFF-MOM ON SPDT
	RK19940-1**	OFF-MOM ON DPST
	RK19480-1**	MOM ON-OFF-MOM ON DPDT
	RK19490-1**	ON-OFF-ON DPDT



RK22160**
ACTUATOR
BLACK CONTURA II
(2EA)



RK22170**
ACTUATOR
RED CONTURA II
(2EA)

ILLUMINATED WEATHER RESISTANT CONTURA® II ROCKER SWITCHES



- Non-corrosive plastic construction
- Removable actuators
- Brass blade terminals, silver contacts
- Rated: 20 amps @12 VDC

DIAGRAM	PART NUMBER	SWITCH FUNCTION
	RK19440-1**	OFF-ON SPST
	RK19450-1**	MOM ON - OFF SPST
	RK19460-1**	ON-OFF-ON SPDT
	RK19540-1**	ON-OFF-ON DPDT
	RK19550-1**	MOM ON-OFF-MOM ON DPDT

** Display Packaged

STANDARD ROCKER SWITCHES - WITH BLACK ACTUATORS



- Non-corrosive plastic construction
- Black actuators w/ black face plate
- Silver contacts
- Brass blade terminals
- Rated: 20 amps @ 12 VDC

DIAGRAM	BULK #	PART NUMBER	SWITCH FUNCTION
	RK40142	RK40140**	ON-OFF SPST
	RK40152	RK40150**	MOM ON - OFF SPST
	RK40172	RK40170**	ON-OFF-ON SPDT
	RK40352	RK40350**	MOM ON-OFF-MOM ON SPDT
	RK40472	RK40470**	MOM ON-OFF-MOM ON DPDT
	RK40482	RK40480**	ON-OFF-ON DPDT
	RK40362	RK40360**	ON-OFF-MOM ON SPDT
	RK19572	RK19570	ON(1)-OFF-ON(1&2) DPDT



ILLUMINATED ROCKER SWITCHES

- Dependent pilot light - illuminates in "on" position
- Non-corrosive plastic construction
- Silver contacts
- Brass blade terminals
- Rated: 20 amps @ 12 VDC



DIAGRAM	BULK #	PART NUMBER	SWITCH FUNCTION
	RK40102	RK40100**	ON-OFF SPST
	RK40112	RK40110**	ON-OFF-ON SPDT
	RK40122	RK40120**	MOM ON - OFF SPST
	RK40132	RK40130**	MOM ON-OFF-MOM ON SPDT

** Display Packaged

ILLUMINATED ROCKER SWITCHES - SOFT SPOT LIGHT



- Independent pilot light - illuminates when panel lights ON
- Illuminates white when panel lights are ON, changes to red when switch is ON
- Soft spotlight helps preserve night vision • Non-corrosive plastic construction
- Silver contacts • Brass blade terminals • Rated: 20 amps @ 12 VDC

DIAGRAM	BULK #	PART NUMBER	SWITCH FUNCTION
	RK40372	RK40370**	ON-OFF SPST
	RK40382	RK40380**	MOM ON - OFF SPST
	RK40392	RK40390**	ON-OFF-ON SPDT
	RK40402	RK40400**	MOM ON-OFF-MOM ON SPDT



WEATHER RESISTANT ILLUMINATED ROCKER SWITCHES



- Certified to IP 66 and IP 68 - protected against dust, prolonged spray and submersion
- Supplied with neoprene mounting gasket
- Removable actuators
- Brass blade terminals, silver contacts
- Snap in lens of choice (Amber, Clear, Green, Red)
- Rated: 20 amps @12 VDC

DIAGRAM	PART NUMBER	SWITCH FUNCTION	KIT DETAILS
	RK19500K	OFF-ON SPST	Dependent pilot light - illuminates in "on" position Includes 1 lens of each color
	RK19510K	OFF-ON SPST	Independent pilot light - illuminates when panel light is turned "on" Includes 1 lens of each color
	RK19520K	ON-OFF-ON SPDT	Dependent pilot lights - each light illuminates in "on" position Includes 2 lenses of each color
	RK19530K	OFF-ON SPST	One dependent pilot light - illuminates in "on" position. One independent pilot light - illuminates when panel lights "on" Includes 2 lenses of each color

** Display Packaged

ROCKER SWITCH MOUNTING BRACKETS FOR INSTALLING TWO OR MORE ROCKER SWITCHES

- Fits Sierra Standard and Contura® Rocker Switches
- Sections snap together without tools
- Mounting hole for 2 end unit set - 2.02" (51.31 mm) wide x 1.90" (48.26 mm) high add 1.03" (26.16 mm) for additional sections



UN19700
BLANK COVER



UN19710**
1 CENTER SECTION



UN19720
TWO END SECTIONS



UN19730**
2 CENTER SECTIONS



UN19740**
1 END SECTION



UN19750**
KIT CONTAINS:
2 - **UN19740 END SECTIONS
1 - **UN19710 - CENTER SECTION
1 - **UN19700 - BLANK COVER

INTERIOR & RV STYLE SWITCHES

NARROW BODY ROCKER SWITCHES ON - OFF SPST



- RK21880**** Non Illuminated
- RK21890**** Glows Red in ON position
- For use in RK22070 panel
- Fits 7/16" X 1 1/4" cut out
- Blade Terminals
- 20 Amp @ 12 VDC

NARROW BODY ROCKER SWITCH ON - OFF SPST



- RK19640****
- RK19642 (Bulk - 100pcs./carton)**
- Fits .550" X 1.125" cut out
- Blade Terminals
- 10 Amp @ 12 VDC

NARROW BODY ROCKER SWITCH ON - OFF SPST



- RK19630****
- RK19632 (Bulk - 100pcs./carton)**
- Fits .550" x 1.125" cut out
- Blade Terminals
- 10 Amp @ 12 VDC
- Glows red in ON position

SURFACE MOUNT ILLUMINATED ROCKER SWITCHES OFF-ON SPST



- RK21420**** Red
- RK21430** Green
- Illuminates in ON position
- Mount in 1/2" round holes
- Brass blade terminals
- 16 Amp @ 12 VDC

** Display Packaged

STANDARD TOGGLE SWITCHES



- Non-corrosive plastic construction
- Brass blade terminals, silver contacts
- 15/32" L x 15/32"-32 mounting stem
- Rated: 20 amps @ 12 VDC or 25 amp @ 12 VDC

*Rated 25 amp @ 12 VDC

DIAGRAM	BULK #	PART NUMBER	SWITCH FUNCTION
	TG4002252*	TG40020-1***	ON-OFF SPST
	TG4003252*	TG40030-1***	MOM ON-OFF SPST
	TG4004252*	TG40040-1***	ON-OFF-ON SPDT
	TG4005252*	TG40050-1***	MOM ON-OFF-MOM ON SPDT
	TG4016252*	TG40160-1***	ON-OFF-MOM ON SPDT
	TG4045252*	TG40450-1***	ON-OFF-ON DPDT
	TG4046252*	TG40460-1***	MOM ON-OFF-MOM ON DPDT
	TG40492	TG40490**	ON(1)-OFF-ON(1&2) DPDT

ILLUMINATED TOGGLE SWITCHES



- Non-corrosive plastic construction
- Illuminates white when panel lights are ON, changes to red when switch is ON
- Brass blade terminals, silver contacts
- 15/32" L x 15/32"-32 mounting stem
- Rated: 20 amps @ 12 VDC

DIAGRAM	BULK #	PART NUMBER	SWITCH FUNCTION
	TG40062	TG40060**	ON-OFF SPST
	TG40072	TG40070**	ON-OFF-ON SPDT
	TG40082	TG40080	MOM ON-OFF SPST
	TG40092	TG40090	MOM ON-OFF-MOM ON SPDT

TIP LIT TOGGLE SWITCHES



- Lights through tip of handle
- Non-corrosive plastic construction
- Illuminates white when panel lights are ON, changes to red when switch is ON
- Brass blade terminals, silver contacts
- 15/32" L x 15/32"-32 mounting stem
- Rated: 20 amps @ 12 VDC

** Display Packaged

DIAGRAM	BULK #	PART NUMBER	SWITCH FUNCTION
	TG40302	TG40300**	ON-OFF SPST
	TG40312	TG40310**	MOM ON-OFF SPST
	TG40322	TG40320**	ON-OFF-ON SPDT
	TG40332	TG40330**	MOM ON-OFF-MOM ON SPDT
	TG40342	TG40340	ON-OFF-MOM ON SPDT
	TG19522	TG19520**	ON-OFF-ON DPDT
	TG19532	TG19530**	MOM ON-OFF-MOM ON DPDT

WEATHER RESISTANT TOGGLE SWITCH ON-OFF-ON SPDT



- Illuminates red in "on 1" position
- Illuminated white in "off" or "on 2" position
- O-ring seal in bushing seals out moisture and dirt
- Can be wired for independent or dependent illumination
- Rated: 20 amps @ 12 VDC

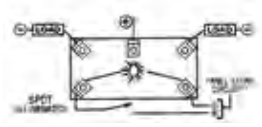

TG40010
TG40012 (Bulk - 100pcs./carton)

SATIN CHROME TIP TOGGLE SWITCHES



- Satin Chrome Handle with matching retaining ring
- Lights through tip of handle
- Non-corrosive plastic construction
- Illuminates white when panel lights are ON, changes to red when switch is ON
- Brass blade terminals, silver contacts
- 15/32" L X 13/32"-32 mounting stem
- Rated: 20 Amp @ 12 VDC



TG23010**
TG23012 (Bulk 100pcs./carton)
TOGGLE SWITCH
ON-OFF-ON SPDT

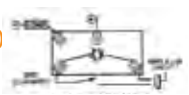

TG23030**
TG23032 (Bulk 100pcs./carton)
TOGGLE SWITCH
(ON)-OFF SPST

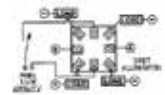

TG23050**
TG23052 (Bulk 100pcs./carton)
TOGGLE SWITCH
(ON)-OFF (ON) DPDT

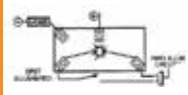

TG23000**
TG23002 (Bulk 100pcs./carton)
TOGGLE SWITCH
ON-OFF SPST

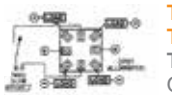

TG23020**
TG23022 (Bulk 100pcs./carton)
TOGGLE SWITCH
ON-OFF-ON DPDT



TG23040**
TG23042 (Bulk 100pcs./carton)
TOGGLE SWITCH
(ON)-OFF-(ON) SPDT

HEAVY DUTY 25 AMP TOGGLE SWITCHES



- Nickel Plated Brass Mounting Stem and Hardware
- Handle 11/16" (17.46mm) long
- Mounting Stem 15/32"-32 thread, 15/32" (11.81mm) long
- Fits panels up to 1/4" (6.35 mm) thick
- Rated : 25 Amp @ 12 VDC



TG22000**
TG22002 (Bulk 100pcs./carton)
ON-OFF SPST



TG22010**
TG22012 (Bulk 100pcs./carton)
ON-OFF-ON SPDT



TG22020**
TG22022 (Bulk 100pcs./carton)
ON-OFF-ON DPDT



TG22030**
TG22032 (Bulk 100pcs./carton)
MOM ON-OFF SPST



TG22040**
TG22042 (Bulk 100pcs./carton)
MOM ON-OFF-MOM
ON SPDT

** Display Packaged

HEAVY DUTY 50 AMP TOGGLE SWITCHES



- Super tough zinc die cast
- Heavy copper screw terminals
- Chrome plated plastic handle w/ metal core
- 15/32" L x 15/32"-32 mounting stem
- Rated: 50 Amp @ 12 VDC

TG21500**
TG21502 (Bulk - 100pcs./carton)
 ON-OFF SPST

TG21590
TG21592 (Bulk - 100pcs./carton)
 ON-OFF-ON SPST

TG21600**
TG21602 (Bulk - 100pcs./carton)
 MOM ON-OFF-MOM ON SPDT

WEATHER RESISTANT TOGGLE SWITCHES



- Plasticized coating seals out moisture and dirt
- Nickel plated brass handle, mounting stem and hardware
- 10" L 16 gauge wire leads
- Handle 11/16" (17.46 mm) long
- Mounting stem 15/32"-32, 13/32" (10.31mm) long
- Fits panel up to 3/16" (4.76 mm) thick
- Includes MP39030 weather proof boot nut
- Rated: 15 amps @ 12 VDC

TG19560-1
TG19562-1 (Bulk - 100pcs./carton)
 OFF-ON SPST

TG19540-1
TG19542-1 (Bulk - 100pcs./carton)
 OFF-MOM ON SPST



TG40000**
TG40002 (Bulk - 100pcs./carton)
 ON-OFF SPST

- Heavy duty all brass construction
- Chrome plated bat handle
- 3/8" L x 7/16"-28 mounting stem
- 2 screw terminals
- Rated: 20 Amps @ 12 VDC



TG21050-1**
TG21052-1 (Bulk - 100pcs./carton)
 ON-OFF SPST

- Heavy duty toggle switch
- Chrome plated bat handle
- 15/32" L x 15/32"-32 mounting stem
- Two 6" wire leads
- Rated: 35 Amps @ 12 VDC
- Rated: 6 Amps @ 125 VAC



TG21040**
TG21042 (Bulk - 100pcs./carton)
 ON-OFF SPST

- Heavy duty toggle switch
- Chrome plated brass bat handle
- 3/8" L x 15/32"-32 mounting stem
- 2 screw terminals
- Rated: 35 Amps @ 12 VDC
- Rated: 20 Amps @ 125 VAC



****TG21020-2****
***TG21022-2 (Bulk - 100pcs./carton)**
 ON-OFF SPST

- Heavy duty die cast toggle switch
- Chrome plated brass bat handle
- 15/32" L x 15/32"-32 mounting stem
- Sealed bushing
- 2 screw terminals
- Rated: 35 Amps @ 12 VDC
- Rated: 20 Amps @ 125 VAC



TG21070**
TG21072 (Bulk - 100pcs./carton)
 ON-OFF SPST

- Heavy duty toggle switch
- Chrome plated brass bat handle
- 15/32" L x 15/32"-32 mounting stem
- 2 screw terminals
- Rated: 35 Amps @ 12 VDC
- Rated: 20 Amps @ 125 VAC



TG21080
TG21082 (Bulk - 100pcs./carton)
 ON-OFF-ON SPDT

- Heavy duty toggle switch
- Chrome plated brass bat handle
- 3/8" L x 15/32"-32 mounting stem
- 3 screw terminals
- Rated: 35 Amps @ 12 VDC
- Rated: 20 Amps @ 125 VAC

** Display Packaged

DUCKBILL TOGGLE SWITCHES



- Non-corrosive plastic construction
- Brass blade terminals
- 1/2" mounting hole
- Supplied with bezel nut and spacer ring
- Rated: 15 Amps @ 12 VDC



TG21360**
TG21362 (Bulk 100pcs/carton)
 ON-OFF SPST
 Glows Red in ON position

1" translucent plastic handle

TG21390
TG21392 (Bulk 100pcs/carton)
 ON-OFF SPST
 Glows Green in ON position

TG21130**
TG21132 (Bulk 100pcs/carton)
 ON-OFF SPST

1" black plastic handle

TG21140
TG21142 (Bulk 100pcs/carton)
 ON-OFF-ON SPDT



MP39220**
MP39222 (Bulk 100pcs/carton)
WEATHER PROOF BOOT NUT

- For illuminated toggle switches (except Duckbill)
- 1/2" boot seals out moisture yet allows illumination to show



MP39030**
MP39032 (Bulk 100pcs/carton)
WEATHER PROOF BOOT NUT (GRAY)

- For standard toggles w/ 15/32" mounting stem
- Completely covers toggle handle
- Seals out moisture & dirt
- Nickel plated brass nut



MP39240-1**
MP39242 (Bulk 100pcs/carton)
WEATHER PROOF BOOT NUT (BLACK)

- For standard toggles w/ 15/32" mounting stem
- Completely covers toggle handle
- Seals out moisture & dirt



MP39280**
MP39282 (Bulk 100pcs/carton)
WEATHER PROOF BOOT NUT (BLACK)

- For standard toggles w/ 15/32" mounting stem
- Completely covers toggle handle
- Seals out moisture & dirt
- 2 piece construction chrome ring retains switch

INDICATOR LIGHTS

UN22100**
UN22102 (Bulk 100pcs/carton)
 RED



UN22110**
UN22112 (Bulk 100pcs/carton)
 GREEN

UN22120**
UN22122 (Bulk 100pcs/carton)
 AMBER

SMALL INDICATOR LIGHTS
 12 VDC use only

- 5/16" mounting hole
- 5" tinned copper wire leads



UN22150**
UN22152 (Bulk 100pcs/carton)
 RED

UN22160
UN22162 (Bulk 100pcs/carton)
 GREEN

SMALL INDICATOR LIGHTS
 125 VAC use only

- 5/16" mounting hole
- 5" tinned copper wire leads

** Display Packaged

INDICATOR LIGHTS

LARGE INDICATOR LIGHTS

- 12 VDC use only
- 1/2" mounting hole
- 4" tinned copper wire leads



UN21280**
UN21282 (Bulk 100pcs/carton)
RED



UN21290**
UN21292 (Bulk 100pcs/carton)
GREEN



UN21320
UN21322 (Bulk 100pcs/carton)
AMBER

WEATHER-RESISTANT PUSH PULL SWITCHES



MP39380**
MP39382 (Bulk 100pcs/carton)
OFF-ON SPST

- Solid brass construction
- Gasket sealed case
- 3/8" mounting bushing
- 2 screw terminals
- 3/4" chrome plated brass knob
- For panels up to 1" thick
- Rated: 15 amp @ 12 VDC



MP39390**
MP39392 (Bulk 100pcs/carton)
OFF-ON SPST
with chrome plated plastic knob

MP39390B**
MP39392B (Bulk 100pcs/carton)
OFF-ON SPST
with chrome plated brass knob

- Solid brass construction
- Vinyl coated body to resist moisture
- Two 18 gauge x 12" wire leads
- 3/8" mounting bushing
- For panels up to 1" thick
- Rated: 15 amp @ 12 VDC

HEAVY DUTY MARINE PUSH PULL SWITCHES



MP39510
MP39512 (Bulk 100pcs/carton)
OFF-ON SPST

- Pull for ON
- Solid brass construction
- 3/8" mounting bushing
- 2 screw terminals
- For panels up to 1" thick
- Cream plastic knob
- Rated: 15 amp @ 12 VDC



MP39520**
MP39522 (Bulk 100pcs/carton)
OFF-ON SPST

- Pull for ON
- Solid brass construction
- 3/8" mounting bushing
- 2 screw terminals
- For panels up to 1" thick
- Chrome plated plastic knob
- Rated: 15 amp @ 12 VDC



MP39530**
MP39532 (Bulk 100pcs/carton)
OFF-ON SPST

- Pull for ON
- Solid brass construction
- 3/8" mounting bushing
- 2 screw terminals
- For panels up to 1" thick
- Chrome plated solid brass knob
- Rated: 15 amp @ 12 VDC



MP39540**
MP39542 (Bulk 100pcs/carton)
OFF-ON SPST

- Pull for ON
- Solid brass construction
- 3/8" mounting bushing
- 2 blade terminals
- For panels up to 1" thick
- Chrome finish plastic knob
- Rated: 15 amp @ 12 VDC



MP39570**
MP39572 (Bulk 100pcs/carton)
OFF-ON(1)-ON(1&2) SPDT

- First pull energizes #1
- Second pull energizes both circuits
- Solid brass construction
- 3/8" mounting bushing
- 3 screw terminals
- For panels up to 1" thick
- Chrome finish plastic knob
- Rated: 15 amp @ 12 VDC



MP39610**
MP39612 (Bulk 100pcs/carton)
OFF-ON(1)-ON(2&3) SPDT

- First pull energizes #1
- Second pull energizes two separate circuits
- For anchor/running lights or similar function
- Solid brass construction
- 3/8" mounting bushing
- 4 screw terminals
- For panels up to 1" thick
- Chrome finish plastic knob
- Rated: 15 amp @ 12 VDC

** Display Packaged

HEAVY DUTY MARINE PUSH PULL SWITCHES



- MP39600**
MP39602 (Bulk 100pcs./carton)
 OFF-ON (1 & 2) SPST
- Pull for ON - turns on two separate circuits
 - Solid brass construction
 - 3/8" mounting bushing
 - 3 screw terminals
 - For panels up to 1" thick
 - Chrome plated solid brass knob
 - Rated: 15 amp @ 12 VDC



- MP39580****
MP39582 (Bulk 100pcs./carton)
 OFF-ON(1)-ON(1&2) SPDT
- First pull energizes #1
 - Second pull energizes both circuits
 - Solid brass construction
 - 3/8" mounting bushing
 - 3 screw terminals
 - For panels up to 1" thick
 - Chrome plated solid brass knob
 - Rated: 15 amp @ 12 VDC



- MP39590****
MP39592 (Bulk 100pcs./carton)
 OFF-ON(1)-ON(1&2) SPDT
- First pull energizes #1
 - Second pull energizes both circuits
 - Solid brass construction
 - 3/8" mounting bushing
 - 3 blade terminals
 - For panels up to 1" thick
 - Chrome finish plastic knob
 - Rated: 15 amp @ 12 VDC



- MP39620**
MP39622 (Bulk 100pcs./carton)
 OFF-ON(1)-ON(2&3) SPDT
- First pull energizes #1
 - Second pull energizes two separate circuits
 - For anchor/running lights or similar function
 - Solid brass construction
 - 3/8" mounting bushing
 - 4 screw terminals
 - For panels up to 1" thick
 - Chrome plated solid brass knob
 - Rated: 15 amp @ 12 VDC



- MP39640**
MP39642 (Bulk 100pcs./carton)
 OFF-ON(1)-ON(2) SPDT
- First pull energizes #1
 - Second pull energizes circuit 2
 - Solid brass construction
 - 3/8" mounting bushing
 - 3 screw terminals
 - For panels up to 1" thick
 - Chrome plated solid brass knob
 - Rated: 15 amp @ 12 VDC

HEAVY DUTY PUSH BUTTON SWITCHES

MOMENTARY ON-OFF SPST

- Corrosion resistant plastic construction
- 1 7/16"L x 5/8" mounting stem
- 2 boss screw terminals
- Rated: 30 Amp @ 12 VDC

MP39160**
MP39162 (Bulk 100pcs./carton)
 with rubber boot nut

MP39180**
MP39182 (Bulk 100pcs./carton)
 with std. chrome face nut



- MP21460**
MP21462 (Bulk 100pcs./carton)
 PUSH ON - PUSH OFF
- Two 5" wire leads for easy connection
 - 3/8"L x 15/32" mounting stem
 - Rated: 3 amps @ 125 VAC



HEAVY DUTY BRASS PUSH BUTTON SWITCHES MOMENTARY ON-OFF SPST

- Solid brass construction
- For starter, horn or other functions
- 1 3/8" L x 5/8"-32 mounting stem
- 2 boss screw terminals
- Rated: 35 amp @ 12 VDC



MP39360
MP39362 (Bulk 100pcs/carton)
 with recessed plunger button
 prevents accidental actuation



MP39410
MP39412 (Bulk 100pcs/carton)
 with large 15/16" anodized
 face nut and button

MP39420
MP39422 (Bulk 100pcs/carton)
 with chrome plated brass face
 nut and button

BRASS PUSH BUTTON SWITCHES MOMENTARY ON-OFF SPST

- Solid brass construction
- For starter, horn or other functions
- 1 1/4" L x 5/8" mounting stem
- 2 screw terminals (except MP39340)
- Rated: 20 amp @ 12 VDC



MP39310**
MP39312 (Bulk 100pcs/carton)
 with chrome plated brass
 face nut and button



MP39320**
MP39322 (Bulk 100pcs/carton)
 with rubber boot nut



MP39340**
MP39342 (Bulk 100pcs/carton)
 with rubber boot nut
 blade terminals

COMPACT PUSH BUTTON SWITCHES MOMENTARY ON-OFF SPST

- Contoured plastic button
- Chrome plated brass mounting stem
- 1/2" Mounting hole
- 2 brass blade terminals
- Rated 15 amp @ 12 VDC
- MP39690 commonly used as Horn Switch



MP39680**
MP39682 (Bulk 100pcs/carton)
 Black Button

MP39690**
MP39692 (Bulk 100pcs/carton)
 Red Button

MP39670
MP39672 (Bulk 100pcs/carton)
 White Button



MP39300**
MP39302 (Bulk 100pcs/carton)
 MOM ON-OFF SPST
 • Large black plastic button
 • Chrome plated brass housing
 • For fog horns or sirens
 • Overall width 2 5/8"

** Display Packaged

EMERGENCY ENGINE CUT-OFF SWITCHES

MOMENTARY ON-OFF SPST



MP39350**
MP39352 (Bulk 100pcs./carton)
PUSH BUTTON SWITCH
 MOM ON - OFF SPST

- Solid brass construction
- Weather resistant plasticized coating
- Rubber boot nut
- Two 12" L 18 gauge wire leads
- Mounting bushing 15/16" L X 5/8"-32
- Rated: 10 amps @ 12 VDC



MP39260**
MP39262 (Bulk 100pcs./carton)
WEATHER PROOF BOOT NUT
 (BLACK)

- For push button switches
- Chrome face nut
- Seals out moisture & dirt
- Tapered design



UN42000**
UN42002 (Bulk 100pcs./carton)
MOM ON - OFF SPST

- Extra heavy duty die cast construction
- Silver contacts
- 2 boss screw terminals
- Rubber boot nut
- Rated: 60 amp @ 12 VDC



MP39140
MP39142 (Bulk 100pcs./carton)
PUSH BUTTON SWITCH
COVER (BLACK)

FUSES



AGA GLASS TUBE FUSES
1/4" X 5/8"

PART #	RATING	PER PACK
FS79060**	20 AMP	5
FS79070	30 AMP	5



SFE GLASS TUBE FUSES

PART #	RATING	SIZE	PER PACK
FS79270	14 AMP	1/4" X 1"	5
FS79280	20 AMP	1/4" X 1 1/4"	5



AGU GLASS TUBE FUSES
13/32" X 1 1/2"

PART #	RATING	PER PACK
FS79820	20 AMP	2
FS79870**	50 AMP	2

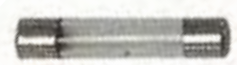

AGC GLASS TUBE FUSES
1/4" X 1 1/4"

PART #	RATING	PER PACK
FS79090	1 AMP	5
FS79100	1.5 AMP	5
FS79110**	2 AMP	5
FS79470	2.5 AMP	5
FS79120**	3 AMP	5
FS79130**	4 AMP	5
FS79140**	5 AMP	5
FS79150**	6 AMP	5
FS79160**	7.5 AMP	5
FS79170**	10 AMP	5
FS79180**	15 AMP	5
FS79190**	20 AMP	5
FS79200**	25 AMP	5
FS79210**	30 AMP	5
FS79220	35 AMP	5



FS79600**
EMERGENCY FUSE KIT
 Contains SIX fuses (1 each)
 SFE 9, 14, 20 and AGC 10, 15, 30.



FS79630**
BILGE PUMP & ACCESSORY FUSE KIT
 Contains FIVE fuses (1 each)
 AGC 5, 10, 15, 30 amp, and 1 SFE 20 amp.

** Display Packaged

ATM & ATO STYLE FUSES



ATO® STYLE FUSES
0.207" W X 0.752" H X 0.76" L

PART #	RATING	COLOR	PER PACK
FS79480**	1 AMP	BLACK	5
FS79490**	2 AMP	GRAY	5
FS79500**	3 AMP	VIOLET	5
FS79510**	4 AMP	PINK	5
FS79520**	5 AMP	TAN	5
FS79530**	7.5 AMP	BROWN	5
FS79540**	10 AMP	RED	5
FS79550**	15 AMP	BLUE	5
FS79560**	20 AMP	YELLOW	5
FS79570**	25 AMP	CREAM	5
FS79580**	30 AMP	GREEN	5
FS79590**	40 AMP	ORANGE	5



FS79690**
ATO® FUSE KIT ASSORTMENT



ATM STYLE FUSES
0.15" W x 0.429" H x 0.76" L

PART #	RATING	COLOR	PER PACK
FS80000**	2 AMP	GRAY	5
FS80010**	3 AMP	VIOLET	5
FS80030**	5 AMP	TAN	5
FS80040**	7.5 AMP	BROWN	5
FS80050**	10 AMP	RED	5
FS80060**	15 AMP	BLUE	5
FS80070**	20 AMP	YELLOW	5
FS80080**	25 AMP	CLEAR	5
FS80090**	30 AMP	GREEN	5



FS79680**
ATM FUSE KIT ASSORTMENT

MAXI™ FUSES

PART #	RATING	COLOR	PER PACK
FS81000	20 AMP	YELLOW	1
FS81010	30 AMP	GREEN	1
FS81020	40 AMP	ORANGE	1
FS81030	50 AMP	RED	1
FS81040	60 AMP	BLUE	1
FS81050	70 AMP	AMBER	1
FS81060	80 AMP	CLEAR	1



- Tin plated copper blades for corrosion protection
- Visible indication of blown condition
- Maximum voltage - 32 VDC

MAXI™ FUSE BLOCK



FS81080

FS81082
(Bulk 100pcs/carton)

- Black Reinforced Polycarbonate
- For Maxi™ fuses 30-80 A
- Snap-on cover insulates conductive parts - meets ABYC & USCG requirements
- Accepts 18-4 AWG wire from sides or bottom
- Maximum voltage - 32 VDC
- Meets SAE J1171

** Display Packaged

ATO/ATC STYLE FUSE BLOCKS



- For ATO/ATC fuses
- Interlocking modules snap together
- 1/4" tin plated copper tab terminals
- Flame resistant reinforced polyester base
- Rated 30 Amps per circuit, 160 Amp total for block

WITH GROUND BUS BAR

PART #	# OF GANGS
FS40420**	6
FS40422*	6
FS40430**	4
FS40432*	4
FS40440**	14
FS40442*	14
FS40450**	8
FS40452*	8
FS40740**	10
FS40742*	10

* Bulk 100pcs./carton



WITHOUT GROUND BUS BAR

PART #	# OF GANGS
FS40410**	14
FS40412*	14
FS56242*	4
FS56232*	6
FS56252*	10

* Bulk 100pcs./carton

GROUND BUS BAR FOR ATO/ATC FUSE BLOCKS



FS40730**
FS40732 (Bulk 100pcs./carton)

- Replacement bus bar for Sierra ATO/ATC fuse blocks
- 14 - 1/4" tin plated copper tab terminals

FUSE BLOCK FOR GLASS TUBE FUSES STANDARD FUSE BLOCKS



- Use with SFE, AGC, or MDL fuses up to 20 Amp
- Heavy duty black molded base
- 8-32 terminal screws
- Tin plated brass fuse clips

PART #	# OF GANGS
FS40500-1	2
FS40502-1*	2
FS40510-1**	4
FS40512-1*	4
FS40520-1**	6
FS40522-1*	6
FS40530-1	8

* Bulk 100pcs./carton

HOT FEED FUSE BLOCKS



- Use with SFE, AGC, or MDL fuses up to 20 Amp
- Common bus bar connects hot side of fuses for power feed
- Heavy duty black molded base
- 8-32 terminal screws and stud terminal for power connection
- Tin plated brass fuse clips

PART #	# OF GANGS
FS40590-1**	4
FS40592-1*	4
FS40600-1	6
FS40602-1*	6
FS40610-1	8
FS40612-1*	8

* Bulk 100pcs./carton

** Display Packaged

HOT FEED/COMMON GROUND FUSE BLOCKS



- Use with SFE, AGC, or MDL fuses up to 20 Amp
- Common bus bar connects hot side of fuses for power feed
- Separate bus bar for ground or unfused common hot feed
- Heavy duty black molded base
- 8-32 stud terminals for power/ground connection
- 1/4" Q.D. terminals for circuit hookup
- Tin plated brass fuse clips

PART #	# OF GANGS
FS40630-1	4
FS40632-1*	4
FS40640-1	6
FS40642-1*	6
FS40650-1	8
FS40652-1*	8

* Bulk 100pcs./carton

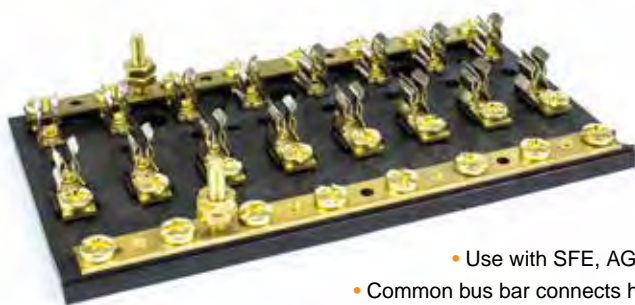

- Use with SFE, AGC, or MDL fuses up to 20 Amp
- Common bus bar connects hot side of fuses for power feed
- Separate bus bar for ground or unfused common hot feed
 - Heavy duty black molded base
- 8-32 terminal screws and stud terminals for power/ground connection
 - Tin plated brass fuse clips

PART #	# OF GANGS
FS40540-1	2
FS40542-1*	2
FS40550-1**	4
FS40552-1*	4
FS40560-1**	6
FS40562-1*	6
FS40570-1**	8
FS40572-1*	8

* Bulk 100pcs./carton

CORROSION RESISTANT COMMON BUS BARS



- Use as common hot feed or common ground block
- Tin plated copper bus
- Stainless steel studs & screws
- Large diameter nuts provide large electrical contact area
- Stainless steel screws with lock washers

150 AMP COMMON BUS



FS46100**
FS46102 (Bulk 100pcs./carton)

- 5 - 8-32 Screw Terminals
- 2 - 10-24 Stud Terminals
- Over all size - 4.13"L x.75"W x1.44"H



FS46150**
FS46152 (Bulk 100pcs./carton)

- 4 -10-24 Stud Terminals
- Over all size - 4.13"L x. 75"W x 1.44"H



FS46200**
FS46202 (Bulk 100pcs./carton)

- 10 - 8-32 Screw Terminals
- 2 - 1/4"-20 Stud Terminals
- Over all size - 6"L x 1.25"W x 1.44"H



FS46250**
FS46252 (Bulk 100pcs./carton)

- 4 - 1/4"-20 Stud Terminals
- Over all size - 6"L x 1.25"W x 1.44"H



FS46400
FS46402 (Bulk 100pcs./carton)

- 20 - 8-32 Screw Terminals
- 2 - 1/4"-20 Stud Terminals
- Over all size - 9 1/4"L x 1.25"W x 1.44"H



FS46450
FS46452 (Bulk 100pcs./carton)

- 6 - 1/4"-20 Stud Terminals
- Over all size - 9 1/4"L x 1.25"W x 1.44"H

** Display Packaged

CORROSION RESISTANT COMMON BUS BARS

250 AMP COMMON BUS



FS46300
FS46302 (Bulk 100pcs./carton)

- 12 - 8-32 Screw Terminals
 - 2 - 1/4"-20 Stud Terminals
- Over all size - 7.88"L x 1.5"W x 1.75"H**



FS46350
FS46352 (Bulk 100pcs./carton)

- 4 - 1/4"-20 Stud Terminals
- Over all size - 7.88"L x 1.5"W x 1.75"H**

600 AMP COMMON BUS



FS46551
FS46552 (Bulk 100pcs./carton)

- 4 x 3/8-16 Stud Terminals
- Over all size - 7.00"L x 2"W x 2"H**



FS46561
FS46562 (Bulk 100pcs./carton)

- 8 x 3/8-16 Stud Terminals
- Over all size - 11.375"L x 2"W x 2"H**

BUS BARS INSULATING COVERS



- ABS cover designed to prevent accidental shorting



FSC46100
 Fits FS46100, FS46150



FSC46200
 Fits FS46200, FS46250



FSC46300
 Fits FS46300, FS46350



FSC46400
 Fits FS46400, FS46450



FSC46550
 Fits FS46551



FSC46560
 Fits FS46561

BRASS BUS BARS

- Use as common hot feed or common ground block
- Brass terminal bar
- 150 AMP



FS40720**
FS40722 (Bulk 100pcs./carton)

- 4 - 8-32 Screw Terminals
- Overall size - 4.5"L x .5" W x 1"H**



FS40750
FS40752 (Bulk 100pcs./carton)

- 10 - 10-32 Screw Terminals
 - 2 - 1/4"-20 Stud Terminals
- Overall size - 5.75"L x 1.25 W x 1.19"H**

** Display Packaged

DUAL BRASS BUS BARS



FS40660**
FS40662 (Bulk 100pcs./carton)

- 4 - 8-32 Screw Terminals
- Overall size - 1.5"L x 1.5"W x .44"H**



FS40670**
FS40672 (Bulk 100pcs./carton)

- 8 - 8-32 Screw Terminals
- Overall size - 3"L x 1.5"W x .44"H**



- Combines negative and positive buses in one block
- Brass terminal bar
- 150 AMP

FS40680**
FS40682 (Bulk 100pcs./carton)

- 12 - 8-32 Screw Terminals
- Overall size - 4.5"L x 1.5"W x .44"H**



FS40690**
FS40692 (Bulk 100pcs./carton)

- 16 - 8-32 Screw Terminals
- Overall size - 6"L x 1.5"W x .44"H**



FS56152 (Bulk 100pcs./carton)

- 20 - 8-32 Screw Terminals
- Overall size - 7.5"L x 1.5"W x .44"H**



BARRIER TYPE JUNCTION BLOCKS



FS45620**
FS45622 (Bulk 100pcs./carton)

- 4 Gang Block
- 8 - 10-32 Screw Terminals
- Overall size - 3.94"L x 1.312"W x 0.812"H**



FS45630
FS45632 (Bulk 100pcs./carton)

- 6 Gang Block
- 12 - 10-32 Screw Terminals
- Overall size - 4.36"L x 1.312"W x 0.812"H**



FS45640
FS45642 (Bulk 100pcs./carton)

- 8 Gang Block
- 16 10-32 Screw Terminals
- Overall size - 5.33"L x 1.312"W x 0.812"H**



FS45650
FS45652 (Bulk 100pcs./carton)

- 10 Gang Block
- 20 10-32 Screw Terminals
- Overall size - 6.31"L x 1.312"W x 0.812"H**



ATO/ATC STYLE FUSE HOLDERS



- FS35870****
FS35872 (Bulk 100pcs./carton)
FUSE HOLDER
- Weather proof sealed case
 - 5" - 12 gauge wire leads
 - For ATO/ATC style fuses up to 30 amps



- FS69130****
N-186913 (Bulk 100pcs./carton)
FUSE HOLDER
- 5" - 12 gauge wire leads
 - For ATO/ATC style fuses up to 30 amps
 - Includes 30 amp fuse



- FS45410****
FS45412 (Bulk 100pcs./carton)
FUSE HOLDER
- 8" - 14 gauge wire loop
 - For ATO/ATC style fuses up to 20 amps

** Display Packaged

WEATHER RESISTANT GLASS TUBE STYLE FUSE HOLDERS



WEATHER RESISTANT FUSE HOLDER WITH SPARE FUSE COMPARTMENT

PART #	DETAILS
FS69150**	10 GA 8" wire loop w/ two 30 Amp fuses
FS69160**	12 GA 8" wire loop w/ two 20 Amp fuses
FS69170**	14 GA 8" wire loop w/ two 15 Amp fuses
FS69180**	16 GA 8" wire loop w/ two 10 Amp fuses



FS69140**
HEAVY DUTY FUSE HOLDER

- Weather resistant
- 5" - 8 gauge wire leads
- For 30 to 50 Amp AGC fuses



FS45440**
FS45442 (Bulk 100pcs./carton)
FUSE HOLDER

- Weather proof sealed case
- 15" - 14 gauge wire loop
- For up to 20 amp SFE, AGC, MDL fuses



FS45470**
FS45472 (Bulk 100pcs./carton)
FUSE HOLDER

- Weather proof sealed case
- 15" - 10 gauge wire loop
- Includes 30 amp SFE fuse



FS45460**
FS45462 (Bulk 100pcs./carton)
FUSE HOLDER

- Weather proof sealed case
- 15" - 14 gauge wire loop
- Includes 20 amp SFE fuse

IN-LINE GLASS TUBE STYLE FUSE HOLDERS



FS45350**
FS45352 (Bulk 100pcs./carton)
FUSE HOLDER

- Black plastic twist lock case
- 8" - 14 gauge wire loop
- Includes 20 amp SFE fuse



FS45400**
FS45402 (Bulk 100pcs./carton)
FUSE HOLDER

- White plastic twist lock case
- 7" 16 gauge wire loop
- For glass fuses up to 10 amp



FS45360**
FS45362 (Bulk 100pcs./carton)
FUSE HOLDER

- Red plastic twist lock case
- 8" - 14 gauge wire loop
- Includes 14 amp SFE fuse



FS69100**
FUSE HOLDER

- Black plastic twist lock case
- 7" - 14 gauge wire loop
- Includes 15 amp fuse



FS45380**
FS45382 (Bulk 100pcs./carton)
FUSE HOLDER

- Black plastic threaded case
- 7" - 12 gauge wire loop
- Includes 30 amp SFE fuse



FS69110**
FUSE HOLDER

- Black plastic twist lock case
- 7" - 14 gauge wire loop
- Includes 20 amp fuse



FS45390**
FS45392 (Bulk 100pcs./carton)
FUSE HOLDER

- Black plastic threaded case
- 7" - 12 gauge wire loop
- Includes 20 amp SFE fuse



FS69120**
FUSE HOLDER

- Heavy Duty
- 12 gauge tinned copperwire
- Includes 30 amp fuse

PANEL MOUNT GLASS TUBE STYLE FUSE HOLDERS

FS22080**
FS22082 (Bulk 100pcs./carton)
FUSE HOLDER

- Panel mount with red fuse label
- For glass fuses up to 20 amp
- For panels up to 5/16" thick



FS45430**
FS45432 (Bulk 100pcs./carton)
FUSE HOLDER

- Panel mount
- Weather resistant gasket sealed
- For AGC, MDL fuses
- For panels up to 5/16" thick



HIGH AMPERAGE CIRCUIT BREAKERS

* Perfect for rigging trolling motors, windless, and other high amp electrical equipment

AUTO RESET

* INCLUDES STUD MOUNTING PLATE



CB42240**
40 Amp • 12V

CB42250-1**
50 Amp • 12V

MANUAL RESET

* INCLUDES STUD MOUNTING PLATE



CB43240** **CB43250****
40 Amp • 12V 50 Amp • 12V

CB45240 **CB45250**
40 Amp • 24V 50 Amp • 24V



CB60000-1**

CB60002-1 (std. pk of 25)

- Ignition Protected
- Waterproof
- Can be used as switch and circuit breaker
- Replaces Minnkota MKR-19
- Rated - 60 A
- Maximum voltage 42 VDC
- Stainless steel hardware

CB60010**

CB60012 (std. pk of 25)

- Ignition Protected
- Waterproof
- Can be used as switch and circuit breaker
- Rated - 50A
- Maximum voltage 24 VDC
- Stainless steel hardware

TOGGLE TYPE CIRCUIT BREAKERS

- High quality exact replacement on many top brands
- Color coded handles for quick identification of AC/DC
- White handles for DC, black handles for AC
- Clamshell packaging

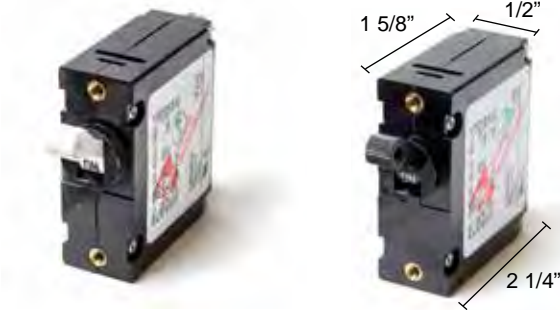

PART #	AMP RATING	COLOR
CB40200	5	WHITE
CB40220	10	WHITE
CB40230	15	WHITE
CB40240	20	WHITE
CB40250	35	WHITE
CB40190	50	WHITE
CB41240	40	WHITE
CB40260	15	BLACK
CB40270	20	BLACK
CB40280	30	BLACK

PUSH BUTTON RESETTABLE CIRCUIT BREAKERS

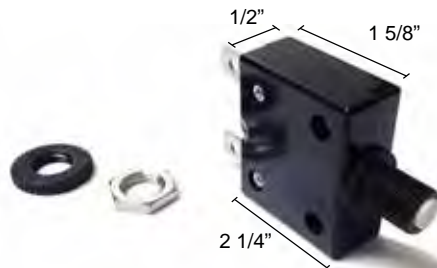

- Replacement for popular panel mounted breakers
- Mounts in 3/8" hole
- White buttons for DC, black buttons for AC
- Use MP39210 for weatherproof boot nut

PART #	AMP RATING	COLOR
CB41100	3	WHITE
CB41200**	5	WHITE
CB41210	10	WHITE
CB41220**	15	WHITE
CB41230**	20	WHITE
CB41210B**	10	BLACK

MP41400**

COMPLETE AUDIBLE WARNING KIT

Contains:

OP22900** Oil pressure switch 6 PSI (1/8" - 27) normal closed

TS25101 Temperature switch (3/8" - 18)

MC33502 Buzzer switch

OP22891 Optional oil pressure switch 15 PSI (1/8" - 27) normal closed

Buzzer alerts operator of high engine temperatures or low engine oil pressure. Kit includes instructions, oil pressure switch (set at 6 PSI) and temperature switch (set at 200° F).



MP39210**

WEATHER PROOF BOOT NUT

- Seals out dirt and moisture
- For use with push button resettable circuit breakers

** Display Packaged

4 POLE FLAT CONNECTORS

Shrouded connectors provide better protection against weather dirt and moisture. Unshrouded connectors are found on most OEM trailers. The plugs are interchangeable and can connect together.



White Ground
Brown Tail, License, Marker Lamps
Yellow Left Turn Signal/Stop Lamp
Green Right Turn Signal/Stop Lamp

** Display Packaged

UNSHROUDED

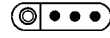

Trailer Side



Tow Vehicle Side



SHROUDED



Trailer Side

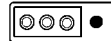

Tow Vehicle Side



DESCRIPTION	SET OF BOTH HALVES PART #	TOW VEHICLE SIDE PART #	WIRE LENGTH	TRAILER SIDE PART NUMBER	WIRE LENGTH
4 Pole Flat - Unshrouded	TC43654**	NSS	4-12"	TC44054**	4-12"
4 Pole Flat - Unshrouded		TC44094	3-48", 1-18"	TC44054**	4-12"
4 Pole Flat - Shrouded			4-12"	TC44254	4-12"
4 Pole Flat - Shrouded w/ splicers					
4 Pole Flat - Shrouded		TC44224	3-48", 1-18"	TC44254	4-12"
4 Pole Flat - Shrouded rewire kit	TC43754	TC44224	3-48", 1-18"	NSS	4-20'
4 Pole Flat - Shrouded rewire kit w/ Splicers	TC43744	TC44224	3-48", 1-18"	NSS	4-20'
4 Pole Flat - Shrouded 5' Extension Harness	WH10350				
4 Pole Flat - Shrouded 25' rewire kit				WH10003	4-25'



TC52000
TESTER



TC42884
TESTER

Allows for quick and easy diagnosis of trailer/tow vehicle lighting problems; simply plug into vehicle trailer connector. LED lighting allows for each circuit to be quickly tested and evaluated.

5 POLE FLAT CONNECTORS

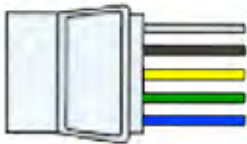

White Ground
Brown Tail, License, Marker Lamps
Yellow Left Turn Signal/Stop Lamp
Green Right Turn Signal/Stop Lamp
Blue Trailer Brake Solenoid

** Display Packaged



DESCRIPTION	SET OF BOTH HALVES PART #	TOW VEHICLE SIDE PART #	WIRE LENGTH	TRAILER SIDE PART NUMBER	WIRE LENGTH
5 Pole Flat - Unshrouded 18" Extension Harness	TC51000**				
5 Pole Flat - Unshrouded		TC51100	5-48"	TC51200	5-70"

6 POLE SQUARE CONNECTORS

Similar to above except with 6 color coded wires to provide for 5 circuits PLUS ground. Color codes are as follows:

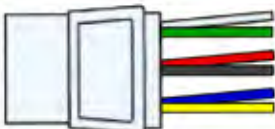

White Ground
Green Right Turn Signal
Red Stop Lamps
Brown Tail & License Lamps
Blue Auxiliary
Yellow Left Turn Lamp

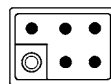

Trailer Side

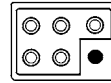

Tow Vehicle Side



PART #	DESCRIPTION	TOW VEHICLE SIDE REPLACEMENT	WIRE LENGTH	TRAILER SIDE REPLACEMENT	WIRE LENGTH
TC43924	Shrouded set of both halves.	Not sold separately	48"	Not sold separately	12"

POLARIZED CONNECTORS

These polarized connector sets plug together only one way to prevent cross connections. Constructed of rugged plastic with molded-in terminals for durability. Wire connections are easy and fast with just a screwdriver. Soft, pliable rubber caps protect the rear of each connector. Dozens of uses. Sold only in mating pairs.



TC43604**
2 Pole Polarized Round

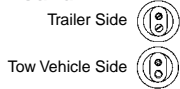

TC43614
3 Pole Polarized Round

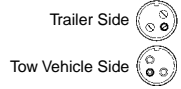

TC43624
4 Pole Polarized Round

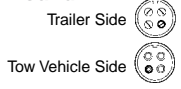

TC43634**
2 Pole Polarized - Flat with 12" wires on each half.

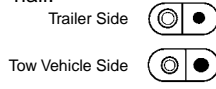

2-WIRE FLAT CONNECTOR
WH10300**
12", 16 GA, 2 Plugs Ready Wired #E301120
WH10310
60", 16 GA, 2 Plugs Ready-Wired #E302120

HEAVY DUTY CONNECTORS



TC44984**
7 Pole (Blade) RV Style Thermoplastic Converter Kit
This kit is used on tow vehicle to convert any Sierra standard 4 pole flat connector to a 7 pole blade connector used on RV's.



TC43904
Non-Strip Splicers
Four blue non-strip splice connectors for making secure, permanent splices without stripping wires manually. Crimp with pliers and metal insert makes connection. Plastic top folds over to insulate connection.

ELECTRONIC TAILLIGHT CONVERTERS

These reliable electronic devices enable tow vehicles and trailers with mismatched light systems to work together.



TC43944
7 Pole RV Style Connector

Trailer Side



TC43504
Amber/Red to Red Taillight Converter
Universal SPLICE-IN trailer converter for cars and trucks with separate stop and turn signals. Electronic taillight module converts tow vehicle's amber turn signal and red brake light into one combined red brake/turn signal on your trailer.



ADAPTERS

These adapters allow a tow vehicle with a 4, 6 or 7 pole socket to tow a trailer with a different configuration plug. Quality molded plastic connector stores in glove box when not in use.

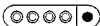

TC50000**
7 Pole RV Style Blade 
to 5 pole flat - 18" extension harness 



TC51300**
7 Pole RV Style Blade 
to 5 pole flat 





TC42834
7 POLE RV STYLE BLADE 
to 6 Pole Pin 



TC42894
4 POLE ROUND 
to 4 Pole Flat 



TC42904
6 POLE ROUND 
to 4 Pole Flat 



TC42914**
7 POLE RV STYLE BLADE 
to 4 Pole Flat 

** Display Packaged

TROLLING MOTOR PLUGS



WH10600-1**
WH10602-1 (PKG OF 100)
 V-GROOVE FEMALE MOTOR SIDE TROLLING MOTOR SOCKET
 12 Volt
 6" - 8 gauge w/ butt connectors
 Use with WH10610-1



WH10610-1**
WH10612-1 (PKG OF 100)
 V-GROOVE MALE BOAT SIDE TROLLING MOTOR PLUG
 12 Volt
 6" - 8 gauge w/ butt connectors
 Use with WH10600-1



WH10520-1**
WH10522 (PKG OF 100)
 MALE BOAT SIDE TROLLING MOTOR PLUG
 12 Volt
 6" - 8 gauge w/ butt connectors
 Use with WH10530-1



WH10530-1**
WH10532 (PKG OF 100)
 FEMALE MOTOR SIDE TROLLING MOTOR SOCKET
 12 Volt
 6" - 8 gauge w/ butt connectors
 Use with WH10520-1



WH10540-1**
WH10542 (PKG OF 100)
 MALE BOAT SIDE TROLLING MOTOR PLUG
 24 Volt
 6" - 8 gauge w/ butt connectors
 Use with WH10550-1



WH10550-1**
WH10552 (PKG OF 100)
 FEMALE MOTOR SIDE TROLLING MOTOR SOCKET
 24 Volt
 6" - 8 gauge w/ butt connectors
 Use with WH10540-1



WH10470-1**
WH10472 (PKG OF 100)
 FEMALE BOAT SIDE TROLLING MOTOR SOCKET
 12 Volt
 6" - 10 gauge w/ butt connectors
 Use with WH10480-1



WH10480-1**
WH10482 (PKG OF 100)
 MALE MOTOR SIDE TROLLING MOTOR PLUG
 12 Volt
 6" - 10 gauge w/ butt connectors
 Use With WH10470-1



WH10490-1**
WH10492 (PKG OF 100)
 FEMALE BOAT SIDE TROLLING MOTOR SOCKET
 24 Volt
 6" - 10 gauge w/ butt connectors
 Use with WH10500-1



WH10500-1**
WH10502 (PKG OF 100)
 MALE MOTOR SIDE TROLLING MOTOR PLUG
 24 Volt
 6" - 10 gauge w/ butt connectors
 Use with WH10490-1



WH10560**
 FEMALE BOAT SIDE TROLLING MOTOR SOCKET
 12 Volt • 3 Slots
 10" - 10 gauge w/ butt connectors
 Use with WH10570



WH10570**
 MALE MOTOR SIDE TROLLING MOTOR PLUG
 12 Volt • 3 Plugs
 10" - 10 gauge w/ butt connectors
 Use with WH10560



WH10640**
 MALE BOAT SIDE TROLLING MOTOR PLUG
 24 Volt • 60 AMP
 Use with WH10650



WH10650**
 FEMALE MOTOR SIDE TROLLING MOTOR SOCKET
 24 Volt • 60 AMP
 Use with WH10640

TRAILER ACCESSORIES



CARSIDE CONNECTORS

WH10040
 48", 16 GA 4/Pole
 Ready-Wired #B240010

WH10230**
 48", 16GA 5/Pole
 Ready-Wired #M242010

TRAILER ACCESSORIES



WH10220
TRAILER SIDE CONNECTOR
 24", 16 GA, 4/Pole
 Ready-Wired #M241120



WH10240**
TRAILER SIDE CONNECTOR
 24", 16 GA 5/Pole
 Ready-Wired #M243120
 Use with WH10230



WH10320
3- WIRE FLAT CONNECTOR
 12", 16 GA, 2 Plugs
 Ready Wired #E303120

SOLENOIDS



BA58050
 • Steel housing copper contacts
 • 12 Volts insulated
 • Intermittent rating:
 750 amp make
 100 amp break
 10 seconds ON
 20 minutes OFF



18-5840
 • Steel housing copper contacts
 • 12 Volts grounded
 • Continuous rating:
 85 amp @ 12 VDC



BA58003
 • Use as battery isolation switch
 • Steel housing copper contacts
 • 12 Volts insulated
 • Continuous rating:
 80 amp @ 12 VDC
 • Intermittent rating:
 750 amp make
 100 amp break
 10 seconds ON
 30 minutes OFF



BA58010
SOLENOID SWITCH
 • Weather resistant plastic coating
 • Composite mounting bracket
 • 12 V insulated
 • Rated 85 A continuous duty



BA58020
 • Motor reversing
 • Dynamic braking when both
 coils are in same electrical state
 • 12/24V DC
 • Intermittent rating: 150A
 • Continuous rating: 75 amp (5 min.)

LEVER SWITCHES



MP38910
**LEVER OPERATED
 BATTERY DISCONNECT SWITCH**
 Rated 175 A continuous, 800 A intermittent
 • 3/8" brass terminals
 • Chrome Plated Brass Lever
 • Includes faceplate



UN77310**
BATTERY SWITCH
 Polyester housing is rust and corrosion proof. Removable plastic key for security. Two position switch "Off-On". Two 10MM X 1.5MM stud terminals. For panels up to 1.25 thick. Four mounting holes in a rectangle 1.3" and .8" on centers. 350 amp continuous rating. 500 amp intermittent rating.

BATTERY ACCESSORIES



BATTERY CABLES
 Gauge cable with soldered lug terminals on each end to accept a 3/8" stud.

PART #	SIZE	COLOR	GAUGE
BC88523	2'	RED	4
BC88533	2'	BLACK	4
BC88543	4'	RED	2
BC88553	4'	BLACK	2

PART #	SIZE	COLOR	GAUGE
BC88563	6'	RED	2
BC88573	6'	BLACK	2
BC88583	8'	RED	1
BC88593	8'	BLACK	1



BT44430
**LEAD UNIVERSAL
 BATTERY TERMINAL**

** Display Packaged

BATTERY ISOLATORS

Sierra battery isolators allow for worry free protection against discharging you start battery along with you house battery. Insures battery isolation without needing to check a switch. Allows two or three batteries to be charged at once. All are negative ground.



18-6851



18-6852



18-6853

Part No.	Dimensions	Batteries	Alternators	Terminals	Max. Output
18-6851 ♦	6 1/2" w x 4 1/2" d x 3 1/2" h	3	1	4 - 3/8-16	120 Amp
18-6852 ♦	8" w x 4 1/2" d x 3 1/2" h	2	1	3 - 3/8-16	165 Amp
18-6853 ♦	11" w x 4 1/2" d x 3 1/2" h	3	1	4 - 3/8-16	200 Amp
18-6854 ♦	8" w x 4 1/2" d x 3 1/2" h	3	1	4 - 3/8-16	160 Amp
18-6855 ♠	3 1/4" w x 4 1/2" d x 3 1/2" h	2	1	4-1/4"-18	75 Amp
18-6856 ♠	15" w x 4 1/2" d x 3 1/2" h	2	1	3 - 3/8-16 • 1-1/4"-28	270 Amp

♦ Will not work with Delco CS series alternators

♠ Will work with Delco CS series alternators



18-6854



18-6855



18-6856

TRAILER BEARINGS



18-1100
STANDARD TRAILER BEARING DUST COVER
For Trailer Bearings
1.980 Dia.



TRAILER BEARING KITS

FOR STRAIGHT SPINDLES

18-1105	1" Bearing Kit (BRG #L44643-L44610)
18-1106	1 1/16" Bearing Kit (BRG #L44649-L44610)
18-1107	1 1/4" Bearing Kit (BRG # LM67048-LM67010)

FOR STEP SPINDLES

18-1109	1 1/4" & 3/4" Bearing Kit (BRG #LM67048-LM67010, LM11949-LM11910)
18-1110	1 3/8" & 11/16" Bearing Kit (BRG #L68149-L68111, L44649-L44610)



18-79987
TRANSOM PLATE (SMALL)
Size: 2" x 15"
Universal fit plate designed to add transom support.



18-79988
TRANSOM PLATE (LARGE)
Size: 4" x 17"
Oversized universal fit plate designed to add transom support.



TRAILER BEARING SEALS

PART #	O.D	DIMENSIONS	
		SHAFT SIZE	WIDTH
18-1175	1.985	1.125	.467
18-1176	1.985	1.250	.257
18-1177	2.330	1.500	.408
18-1178	2.566	1.750	.500



COTTER PINS (PKG. OF 10)

PART #	DIMENSIONS	STD. PKG.
18-1199 ①	1/8" x 2"	10
18-3748 ①	7/64" x 1 1/2"	5
18-3746 ①	1/8" x 1"	10
18-3747 ①	5/32" x 1 1/2"	10

WATERPROOF TERMINALS



16-14 GAUGE RING TERMINALS

STUD SIZE	WIRE GAUGE	INSUL COLOR	PKG. OF 10
8	16-14	Blue	EC63120
10	16-14	Blue	EC63130
1/4"	16-14	Blue	EC63140
5/16"	16-14	Blue	EC63190
3/8"	16-14	Blue	EC63200

12-10 GAUGE RING TERMINALS

STUD SIZE	WIRE GAUGE	INSUL COLOR	PKG. OF 10
8	12-10	Yellow	EC63720
10	12-10	Yellow	EC63240
1/4"	12-10	Yellow	EC63250
5/16"	12-10	Yellow	EC63260
3/8"	12-10	Yellow	EC63300

WATERPROOF CONNECTORS

22-10 GAUGE BUTT CONNECTORS

WIRE GAUGE	INSUL COLOR	PKG. OF 10	100 PACK BOX
22-18	Red	EC64000	EC4000-100
16-14	Blue	EC64110	EC64110-100
12-10	Yellow	EC64230	EC64230-100



RING TERMINALS

22-18 GAUGE RING TERMINALS

STUD SIZE	WIRE GAUGE	INSUL COLOR	PKG. OF 10	100 PACK BOX PART #
6	22-18	Red	EC04010	EC04010-100
8	22-18	Red	EC04020	EC04020-100
10	22-18	Red	N/A	EC04030-100
1/4"	22-18	Red	N/A	EC04040-100



16-14 GAUGE RING TERMINALS

STUD SIZE	WIRE GAUGE	INSUL COLOR	PKG. OF 10	100 PACK BOX PART #
8	16-14	Blue	EC04120	EC04120-100
10	16-14	Blue	EC04130	EC04130-100
1/4"	16-14	Blue	EC04140	EC04140-100
5/16"	16-14	Blue	EC04190	EC04190-100
3/8"	16-14	Blue	EC04200	EC04200-100



12-10 GAUGE RING TERMINALS

STUD SIZE	WIRE GAUGE	INSUL COLOR	PKG. OF 10	100 PACK BOX PART #
6	12-10	Yellow	N/A	EC04710-100
8	12-10	Yellow	N/A	EC04720-100
10	12-10	Yellow	EC04240	EC04240-100
1/4"	12-10	Yellow	EC04250	EC04250-100
5/16"	12-10	Yellow	EC04260	EC04260-100
3/8"	12-10	Yellow	EC04300	EC04300-100



QUICK DISCONNECTS, BULLET, BUTT & SPADE TERMINALS

.157 BULLET TERMINALS

WIRE TYPE	WIRE GAUGE	INSUL COLOR	VISUAL PART # / QTY.	PKG. OF 10	100 PACK BOX PART #
FEMALE	22-18	Red	N/A	EC04080	EC04080-100
MALE	22-18	Red	N/A	N/A	EC04070-100
FEMALE	16-14	Blue	N/A	EC04180**	EC04180-100
MALE	16-14	Blue	N/A	EC04170**	EC04170-100
SET	16-14	Blue	EC01570** / 3 SETS	N/A	N/A



SET

SPADE LUG TERMINALS

STUD SIZE	WIRE GAUGE	INSUL COLOR	PKG. OF 10	100 PACK BOX PART #
8	22-18	Red	EC04090	EC04090-100
10	22-18	Red	EC04100	EC04100-100
8	16-14	Blue	EC04210	EC04210-100
10	16-14	Blue	EC04220	EC04220-100



.250 QUICK DISCONNECTS

Wire Type	Gauge	Insul. Color	Pkg. of 10	100 Pack Box Part #
Female	22-18	Red	EC04050	EC04050-100
Female	16-14	Blue	EC04150	EC04150-100
Male	16-14	Blue	N/A	EC04160-100
Female	12-10	Yellow	EC04280	EC04280-100
Fully Insul. Female	16-14	Blue	EC04500	EC04500-100
Fully Insul. Male	16-14	Blue	EC04490	EC04490-100

BUTT CONNECTORS

Wire Gauge	Insul. Color	Pkg. of 10	100 Pack Box Part #
22-18	Red	EC04000**	EC04000-100
16-14	Blue	EC04110**	EC04110-100
12-10	Yellow	EC04230	EC04230-100

SHRINK/PROTECTIVE FLEX TUBING



TYPE	DIA.	VISUAL PACK PART #	QTY	LENGTH
FLEX TUBING	3/8"	EC01620	1	3'
FLEX TUBING	1/2"	EC01630	1	3'
SHRINK TUBE	ASSORT.	EC01750**	7	ASSORT.

NYLON CABLE CLAMPS



DIA.	VISUAL PACK PART #	QTY
5/16"	EC01440	7
3/8"	EC01450	6
1/2"	EC01460	5



EC06230**
CHARGING CLIP
Rating: 30 AMP
PKG OF 2



EC10290
DURA-TUBE
HEAT-SHRINK TUBING
1 1/4" Long • For 10-20 GA. Wire
PKG OF 25

CLIPS & LEADS



EC01380



EC01370



EC01360



EC01760

ALLIGATOR CLIPS/TEST LEADS

TYPE/SIZE	PKG OF 2	TYPE/SIZE	PKG OF 2
CLIP	EC01360**	CLIP 1-1/4" INSULATED	EC01380**
CLIP 2" w/SCREW TERM	EC01370**	LEADS 30" LONG	EC01760**

EC10250**
3/4" TEST CLIPS
50 AMP
Replaces: OMC 390926
(One Pair)



** Display Packaged



EC09090
DIGITAL MINI MULTIMETER

Compact design and the functions you need for overall convenience. Its low price will surprise you!

- 3 1/2 digit LCD display • 16 test ranges, 6 functions
- Battery & protective holster included • Fuse protected, removable safety leads and jacks

DC Volts: 0-200mV, 2000mV 20V, 200V, 500V
 AC Volts: 0-200V, 500V
 DC Amps: 0-2mA, 20mA, 200mA
 Ohms: 0-200W, 2000W, 20KW, 200KW, 2000KW
 Diode Test: 0-2000W
 Battery Test: 0-9v



EC09040
DUAL VOLTAGE CIRCUIT TESTER

Dual bulb tester for testing both 6 and 12 volt circuits. Also can be used to check spark plug wires. This is the most commonly used tester for troubleshooting auto, truck, van and boat wiring. Supplied with ground wire and clip. Packed one per card.



EC01310
TERMINALS & CONNECTORS

175 of the most popular terminals in a shatterproof nylon box.



EC01350
TERMINALS & CONNECTORS W/CRIMP TOOL

30 pc. terminal assortment packed with crimp tool/wire cutter. Attractive 5 compartment clamshell fits neatly in tool box or glove compartment.

Handy for emergencies. Perfect for the do-it-yourselfers.

LOCKS & LATCHES



MP49410**
MP49412 (Bulk 100pcs./carton)

- Turn to open mechanism – no finger pull
- Can be locked or left in latch only position
- Totally corrosion resistant
- Black glass reinforced polyester
- Supplied with 2 keys
- 1" hole size - 1" depth
- 3/4" panel thickness



MP49430**
MP49432 (Bulk 100pcs./carton)

- Turn to open mechanism – no finger pull
- Non-Locking version
- Totally corrosion resistant
- Black glass reinforced polyester
- 1" hole size - 1" depth
- 3/4" panel thickness



MP50560**
MP50562 (Bulk 100pcs./carton)

- Black sculped knob
- Turn to open mechanism – no finger pull
- Can be locked or left in latch only position
- Totally corrosion resistant
- Black glass reinforced polyester
- Supplied with 2 keys
- 1" hole size - 1" depth
- 3/4" panel thickness

** Display Packaged

LOCKS & LATCHES

CAM LOCKS



Secure lockers, hatches, compartments and drawers. 1001 uses. 5 sizes available.

- 3/4" hole size
- +/- 1/4" offset
- 1 1/4" grip length from center of hole.

SIZE	PART #
3/8" DEPTH	CL49300**
5/8" DEPTH	CL49310 **
7/8" DEPTH	CL49320**
1-1/8" DEPTH	CL49330**
1-1/8" DEPTH	CL52422 (Bulk - 100 pcs.)
1-1/8" DEPTH	CL49330KA**
1-3/8" DEPTH	CL49332 (Bulk - 100pcs)

LIFT LATCH

Dozens of applications: bait lockers, fish wells, equipment lockers, hatches, storage compartments. Locking and non-locking styles available. Plate/ring are stainless steel. Holes for #8 mounting screws are 1.5" (w) and 1.312" (h) on center. 3/4" hole size.



MP49500 Non-locking hatch lift only. Measures 2.16" x 1.90" x.25"(h)

HEAVY DUTY DOCKING LIGHTS



10 1/8"

7 1/8"

Recess 5 1/8"

Protect your boat from damage while docking at night!

- ✗ 30,000 cp. bulb illuminates below the deckline. Makes nighttime docking **SAFE & EASY!**
- ✗ Newly-designed housing is **FULLY** sealed! Water cannot enter hull through Docking Light! Old-style O-ring no longer needed to seal hull.
- ✗ **ALIGN & CHANGE** Eyeball from **EXTERIOR** of the hull. Just loosen set screw to align or change Eyeball.
- ✗ **ELIMINATES** the need for access to the rear of the installed Docking Light!
- ✗ New Eyeball **WILL** fit into "old-style" Docking Light housing!
- ✗ New-style housing will fit existing cut-out with only slight modification.
- ✗ Mil-Spec sealed **Waterproof/Dustproof** rocker switch panel included.
- ✗ US Patent #5672004
- ✗ **Intended for Docking Only, Not for Continuous Use.**

DOCKING LIGHTS

PART #	DESCRIPTION	COLOR	WATTS
95001	12v Marine Docking Light Set - Incandescent Bulb (Set of 2)	White	100
95002	12v Marine Replacement Light for 95001 (bulb w/ eyeball)		
95013	28v Marine Docking Light Set - Incandescent Bulb (Set of 2)	White	50
95004	28v Marine Replacement Light for 95013 (bulb w/ eyeball)		
95016	12v Marine Replacement Light for 95021 (bulb w/ eyeball)	--	100
AUXILIARY LIGHTS			
95011	12v Single Light Kit - Halogen Bulb (Set of 1)	White	100
95026	12v Marine Docking Light Set - Halogen Bulb (bulb w/ eyeball)		
PARTS			
95005	Housing	White	---
95006	Hardware Kit	--	---

POWER POLE REPLACEMENT PUMPS



18-6818
TRIM MOTOR
Replaces:
Power Pole PUMP SPN-F
Fits: Power Pole Sportsman Models



18-6819
TRIM MOTOR
Replaces:
Power Pole PUMP PRO-F
Fits: Power Pole Pro Models

** Display Packaged



HOSE SYSTEMS

INSTALLATION, INSPECTION & MAINTENANCE

Don't Neglect This Critically Important System On Your Boat

Shields Marine manufactures a wide variety of hoses for applications onboard pleasure craft. Serving as conduits for fluids, air or exhaust, each Shields hose is designed for a specific application and meets strict standards set by the USCG, ABYC and other regulatory agencies. Hoses also serve as vibration absorbers, isolating components such as exhaust manifolds from the hull of the vessel.

Installers should be mindful of using the right hose for the job. Correct hose and coupling methods should be carried out as outlined by EPA, ABYC, USCG, SAE and the NMMA. Any questions regarding application, replacement or installation should be referred to the Shields technical service department at 217-324-9400.

Inspection

Hose applications aboard any vessel are likely to be mission-critical. Therefore, failure to inspect and replace worn or aged hose can result in the loss of property or possibly, the loss of life. All mission-critical hose – fuel, wet exhaust, bilge pump, bilge vent and hoses connected below the water line – should be inspected prior to each use of the vessel. All fittings and clamps should be secure and properly attached. All hoses and connections should be inspected annually by a qualified marine mechanic.

Maintenance and Replacement

If inspection reveals hose damage, those hoses should be replaced consistent with industry standards. Replace hose that exhibits any of the following signs:

- Cuts, gouges, cracks
- Exposed fabric or wire reinforcement
- Soft spots or bulges
- Loose covers or kinks
- Stiffness or inflexibility

Installation

Hoses shall be secured by corrosion resistant clamps equal to or greater than 300 grade stainless steel. Clamps shall not depend solely on spring tension. Clamps should not be over-tightened, as this may damage the hose or fitting. Fittings must be the proper size for the hose. Forcing a hose over an oversized fitting or clamping down the hose on an undersized fitting may damage the hose and cause failure.



Product Application Guide

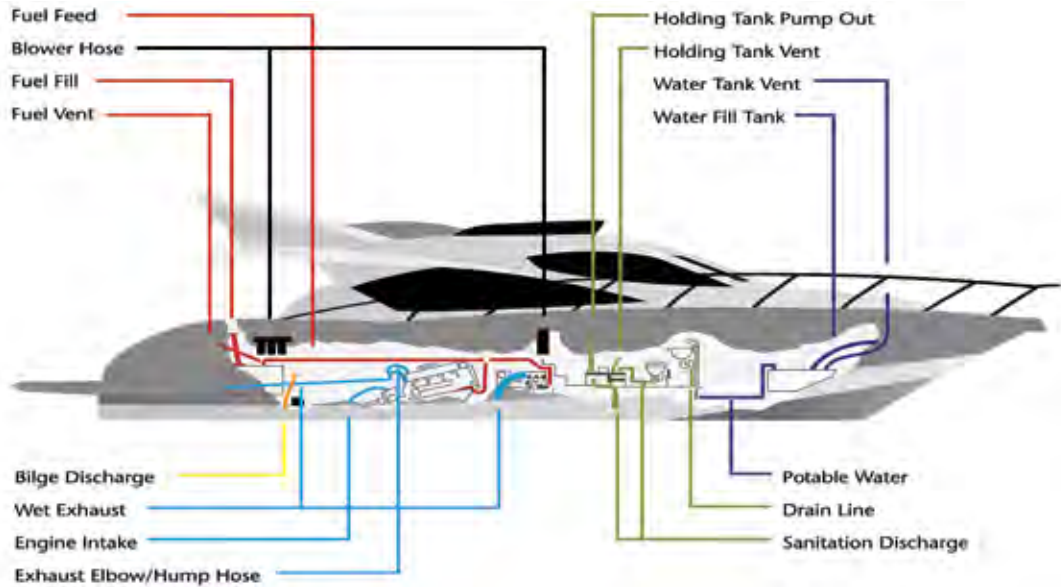

PRODUCT APPLICATION GUIDE KEY

- | | |
|---|---|
| EX — Designed to give excellent service | NA — Not available in size range |
| G — Designed to give good service in normal applications | 1 — Can easily be bent into tight radius |
| C — Product can give good service with proper installation, may not be suitable in all applications. | 2 — Can be bent into gradual radius |
| X — Not recommended | 3 — May kink in applications requiring bend radius |

SERIES NO.	NAME	PG. NO.	SIZE RANGE	APPLICATION						
				Submersible Bilge Pump	Remote Bilge Pump	Hand Bilge Pump	Livewell Inlet	Livewell Drain Above Water Line	Livewell Drain Below Water Line	Flexibility
	BILGE/LIVEWELL									
Series 120	Shields Bilgeflex	67	5/8" - 1 1/2"	G	X	C	X	X	X	1
Series 123	Shields Bilgevac	67	3/4" - 1 1/8"	EX	G	EX	X	C	X	1
Series 140	Shields Vac Std.	68	1 1/4" - 1 1/2"	EX	EX	EX	G	G	C	1
Series 141	Shields Multiflex	69	5/8" - 3"	EX	G	EX	X	G	X	1
Series 142	Shields Vac Cuffs	68	1 1/4" - 1 1/2"							
Series 146	Shields Vac Extra Heavy Duty/Commercial Grade	69	5/8" - 3"	EX	EX	EX	EX	EX	EX	2
Series 147	Shields Vac H.D. Cuffs	68	1 1/2"							
Series 148	Shields Vac Extra Heavy Duty	70	5/8" - 1 1/2"	EX	EX	EX	EX	EX	EX	2
Series 149	Shields Livewell Hose	70	5/8" - 1 1/2"	EX	EX	EX	EX	EX	EX	1

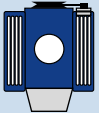
SERIES NO.	NAME	PG. NO.	SIZE RANGE	APPLICATION					Flexibility
				Engine Intake	Generator Intake	Engine Coolant Hose Straight or Limited Bend	Engine Coolant Hose Severe Bend	Exhaust Water Injection	
	ENGINE HOSE								
Series 130	Shields #1300 Heater Hose	71	1/2" - 3/4"	X	X	G	X	X	3
Series 135	Shields #1350 H.D. Water Hose	71	1/2" - 1"	X	C	G	X	G	3
Series 160	Shields #1600 Water Hose	71	3/8" - 1 1/4"	X	G	EX	X	G	2
Series 200	Shields Marine Exhaust	72	1/2" - 14"	X	C	EX	X	G	3
Series 202	Shields Nautiflex Silicone Exhaust Hose	73	1" - 14"	X	X	EX	X	C	3
Series 250	Shieldsflex II	74	1/2" - 8"	EX	EX	EX	EX	EX	2
Series 252	Shieldsaust - C	75	3/4" - 8"	EX	EX	EX	EX	EX	1
Series 262	Shields Corrugated Nautiflex Silicone Exhaust Hose	76	3/4" - 10"	EX	EX	EX	EX	EX	1
Series 321	Shields Complex All in One Hose	77	5/8" - 2"	EX	EX	EX	EX	EX	2

Product Application Guide (Cont.)

SERIES NO.	NAME	PG. NO.	SIZE RANGE	APPLICATION								
				Non-Pressurized Supply	Pressurized Supply		Water Tank Fill	Drain Lines Below Water Line	Drain Lines To Sump or Above Water Line	Water Tank Vent	Flexibility	
					Hot	Cold						
	FRESH WATER SYSTEM/POTABLE											
Series 141	Shields Multiflex	78	5/8" - 3"	C	X	X	EX	X	EX	C	1	
Series 148	Shields Vac Extra Heavy Duty	78	5/8" - 1 1/2"	N/A	X	X	EX	EX	EX	EX	2	
Series 149	Shields Livewell Hose	79	5/8" - 1 1/2"	X	X	X	X	EX	EX	C	2	
Series 150	Shields PVC Tubing — Clear	79	3/16" - 1 1/2"	G	X	X	C	X	G	G	3	
Series 162	Shields All Clear Reinforced PVC — Red Tracer	80	3/8" - 1 1/2"	EX	EX	EX	G	G	G	G	2	
Series 163	Shields Braided Wash Down Hose	80	5/8"									
Series 164	Shields Clear White Reinforced PVC — Blue Tracer	81	1/2" - 3/4"	EX	G	EX	N/A	G	G	G	3	
Series 168	Shields Heavy Duty Reinforced PVC Tubing	81	1/4" - 1 1/2"	EX	EX	EX	G	EX	EX	EX	2	

SERIES NO.	NAME	PG. NO.	SIZE RANGE	APPLICATION						
				Oil Tank Fill	Fuel Tank Fill	Fuel Feed Inboard/Outdrive	Fuel Feed Outboard	Fuel Tank Vent Inboard	Fuel Tank Vent Outboard	Flexibility
	FUEL SYSTEM									
Series 309	Shields Oil Tank Fill Hose	82	1 1/2"	EX	X	N/A	N/A	N/A	N/A	1
Series 315	Shields 315 - Silverado 2000	82	3/8" - 5/8"	N/A	N/A	X	EX	C	EX	2
Series 337	Shields Silverado 4000	83	5/16" - 3/8"	N/A	N/A	X	EX	N/A	N/A	1
Series 350	Shields FIRE-ACOL	84	1 5/8" - 2 3/8"	EX	EX	N/A	N/A	N/A	N/A	1
Series 351	Shields FIRE-ACOL-C	84	1 1/2"	EX	EX	N/A	N/A	N/A	N/A	1
Series 355	Shields Fuel Fill	85	1 1/2" - 2"	EX	EX	N/A	N/A	N/A	N/A	1
Series 365	Shields FIRE-ACOL-15	85	3/8" - 1/2"	N/A	N/A	EX	EX	N/A	N/A	1
Series 368	Shields Low Permeation Marine Fuel Hose	86	1/4" - 1/2"	N/A	N/A	EX	EX	N/A	N/A	1
Series 369	Shields FIRE-ACOL Fuel Vent Hose	86	5/8"	N/A	N/A	X	X	EX	EX	1
Series 321	Shields Complex All in One Hose	87	5/8" - 2"	EX	EX	C	X	EX	X	1
Fuel Accessories	Ferrule Vise / Dies	88	1/4" - 1/2"	For making fuel line assemblies without clamps						
Fuel Accessories	Shields Brackets / Filters / Fuel Line Assemblies	89	-	-	-	-	-	-	-	-

SERIES NO.	NAME	PG. NO.	SIZE RANGE	APPLICATION					
				Toilet to Holding Tank	Holding Tank Pump Out	Holding Tank to Overboard Discharge	Toilet Water Inlet	Holding Tank Vent	Flexibility
	SANITATION SYSTEM								
Series 101	Shields Sanitation Hose	90	1" & 1 1/2"	EX	EX	EX	N/A	N/A	1
Series 105	Shields Poly X Sanitation Hose	90	1" & 1 1/2"	EX	EX	EX	N/A	N/A	1
Fittings	Shields For Series: 101, 105, 144, 148	90	3/4" - 1 1/2"						
Series 144	Shields Super PVC Sanitation	91	1" & 1 1/2"	EX	EX	EX	N/A	N/A	2
Series 146	Shields Vac Extra Heavy Duty/Industrial	91	5/8" - 3"	G	EX	G	EX	EX	2
Series 148	Shields Vac Extra Heavy Duty	92	5/8" - 1 1/2"	G/EX	EX	EX	EX	EX	2
Series 250	Shieldsflex II	93	1/2" - 8"	EX	EX	EX	EX	EX	2
	Shields Sanitation System Cleaners	92	1 Gallon	Cleans contaminants that restrict system performance					

SERIES NO.	NAME	PG. NO.	SIZE RANGE	APPLICATION		
				Blower Hose	A/C Duct	Exhaust Vent Stove Head
	VENTILATION/ AC DUCT					
Series 400	Shields Vinylvent	94	3" - 4"	EX	X	X
Series 402	Shields Vinylvent	94	3" - 4"	EX	X	X
Series 420	Shields Extra Heavy Duty Vinylvent	94	3" - 4"	EX	X	G
Series 450	Shields Fibervent	95	3" - 6"	EX	G	EX
Series 460	Shields AC Ducting Hose	95	3" - 7"	EX	EX	EX

Product Application Guide (Cont.)

SERIES NO.	NAME	PG. NO.	SIZE RANGE	APPLICATION				
				Straight Pipe Connector Less than 4 x I.D. of Hose	Straight Pipe Connector More than 4 x I.D. of Hose	Require Moderate Bend	Severe Bend	Flexibility
	 WET EXHAUST SYSTEM							
Series 200	Shields Marine Exhaust	96	1/2" - 14"	EX	C	X	X	3
Series 202	Nautiflex Silicone Exhaust Hose	97	1" - 14"	EX	C	X	X	3
Series 250	Shieldsflex II	98	1/2" - 8"	EX	EX	EX	C	2
Series 252	Shieldsaust - C	99	3/4" - 8"	EX	EX	EX	EX	1
Series 262	Corrugated Nautiflex							
	Silicone Exhaust Hose	100	3/4" - 16"	EX	EX	EX	EX	1
Series 321	Shields Comflex All in One Hose	101	5/8" - 2"	EX	EX	EX	C	2
Various	Hump Hose & Elbows	102-105	2" - 10"	See our selection for straight or angled connections				

SERIES NO.	NAME	PG. NO.	SIZE RANGE	APPLICATION
	MISCELLANEOUS			
	Exhaust Protector Valves	106	4" - 6"	Prevents water from entering exhaust system
	Hose Clamps	106	5/16" - 7"	Marine grade 316 stainless steel
	Exhaust Hose Clamps - T-Bolt Band Clamps	106	1" - 14"	Designed to fit Shields Series: 200, 201, 210, 250, 252
Series 128	Flame Retardant Split Wire Conduit	107	1/4" - 2"	Provides chafing protection for wiring systems
Series 129	Expandable Braided Sleeving (Scissor Cut)	107	1/2" - 2"	Conduit designed to be cut with scissors
Series 126	Shields Sternflex	108	2"	Provides protection for outboard rigging cables & hose
	Neoprene Sheet Rubber	109	1/8" - 1/4"	Used under fuel tanks to comply with USCG requirements
Series 151	Speedometer Pitot Tubing	109	1/8" - 4mm	Connection from pitot to speedometer



SHIELDS CODE NUMBERS

All Shields Marine Hoses are identified by a 9 digit code number.

Example:

16-120-0580

The first two digits identify the product as a Shields hose:
16 = Shields Hose

The third three digits identify the size of the hose:
058 = 5/8"

The second three digits identify the type of hose:
120 = Bilgefex

The last digit identifies the package quantity as follows:

1	6' or 6 1/4' Length
2	9' Length
3	10' Length
4	12 1/2' Length
5	25' Length
6	50' Length
7	100' Length
8	75' Length
0	Standard Bulk Pack
0-xx	Special Bulk Length (Example: 0-36 = 3')

SHIELDS BILGEFLEX



Shields Bilgeflex Hose is a single layer corrugated polyethylene hose. It is resistant to mild chemicals and salt water and there is a clamping cuff every foot. It is available in black or white (add B or W to suffix to specify color). This hose is primarily used for bilge pump discharge.

Do not attach to thru hull fitting below the water line.



I.D.	mm	Bend Radius	mm	Vac Rating	Wt. "C"	Code # *	Bulk Pack	m	50' (15.2m) R/O Ctn. Code #	Dist. Pkg. 9' (2.7M) Polypac Code #	6' (1.8M) Polypac Code #	25' (7.6M) R/O Ctn.
5/8"	15.9	1/2"	12.7	20	5	16-120-0580	600'	182.9	16-120-0586	16-120-0582	16-120-0581	—
3/4"	19.1	3/4"	19.1	20	6	16-120-0340	500'	152.4	16-120-0346	16-120-0342	16-120-0341	—
1 1/8"	28.6	1"	25.4	20	7	16-120-1180	300'	91.4	16-120-1186	16-120-1182	16-120-1181	—
1 1/4"	31.8	1 1/2"	38.1	20	10	16-120-1140	200'	61.0	16-120-1146	—	—	—
1 1/2"	38.1	2"	50.8	20	13	16-120-1120	150'	45.7	16-120-1126	—	—	16-120-1125

* Add B or W suffix to specify black or white

SHIELDS BILGEVAC



Shields Bilgevac Hose is a black PVC hose with a flexible vinyl helix. It is very flexible, abrasion resistant and is resistant to mild chemicals and saltwater. This hose is primarily used for bilge pump discharge and drains (sinks, shower, scupper, and livewell). **Do not attach to thru hull fitting below the water line.**

I.D.	mm	Bend Radius	mm	Wt. "C"	Bulk Pack 100' (30.5m) Coil Code #	Dist. Pkg. 50' (15.2m) R/O Ctn. Code #
3/4"	19.1	3/4"	50.8	8	16-123-0340	16-123-0346
1 1/8"	28.6	1"	76.2	16	16-123-1180	16-123-1186



SHIELDS VAC STANDARD

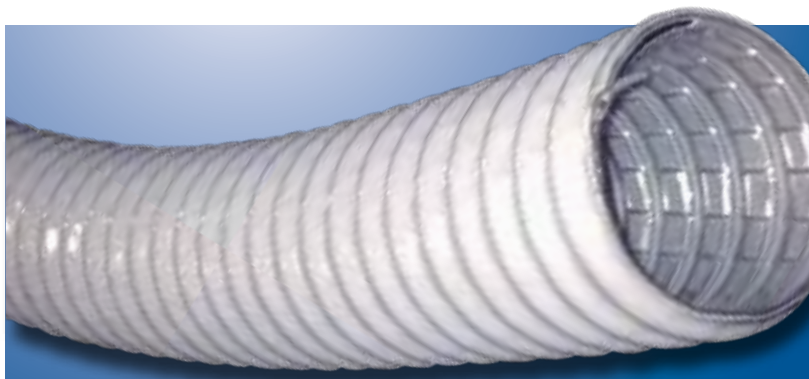

Shields Vac Standard Hose is PVC supported by vinyl covered steel wire and is very flexible. It is Nylon reinforced and is resistant to mild chemicals and saltwater. This hose is primarily used for bilge pump intake and discharge, diaphragm style hand operated bilge pump intake and discharge and drains (sinks, shower, and scupper). This hose uses 142 left hand thread cuffs. **Do not attach to thru hull fitting below the water line.**

I.D.	mm	Bend Radius	mm	Vac Rating	Wt. "C"	Bulk Pack Code #	Dist. Pkg. 50' (15.2m) R/O Ctn. Code #
1 1/4"	31.8	3/4"	19.1	28	19	16-140-1140①	16-140-1146
1 1/2"	38.1	3/4"	19.1	28	23	16-140-1120①	16-140-1126

① 2 x 50' per box



SHIELDS VAC CUFFS

Shields Vac Cuffs provide added clamping protection for Shields Vac Hose. For watertight seal apply with sealing compound. Use with Series 140 & 141. Glue using PVC cement.

Size	mm	Wt. "C"	Code No.	For:	Thread
1 1/4"	31.8	12.5	16-142-1140	Series 140	Left Hand
1 1/2"	38.1	13.0	16-142-1120	Series 140	Left Hand
1 1/2"	38.1	13.0	16-147-1120	Series 141	Right Hand

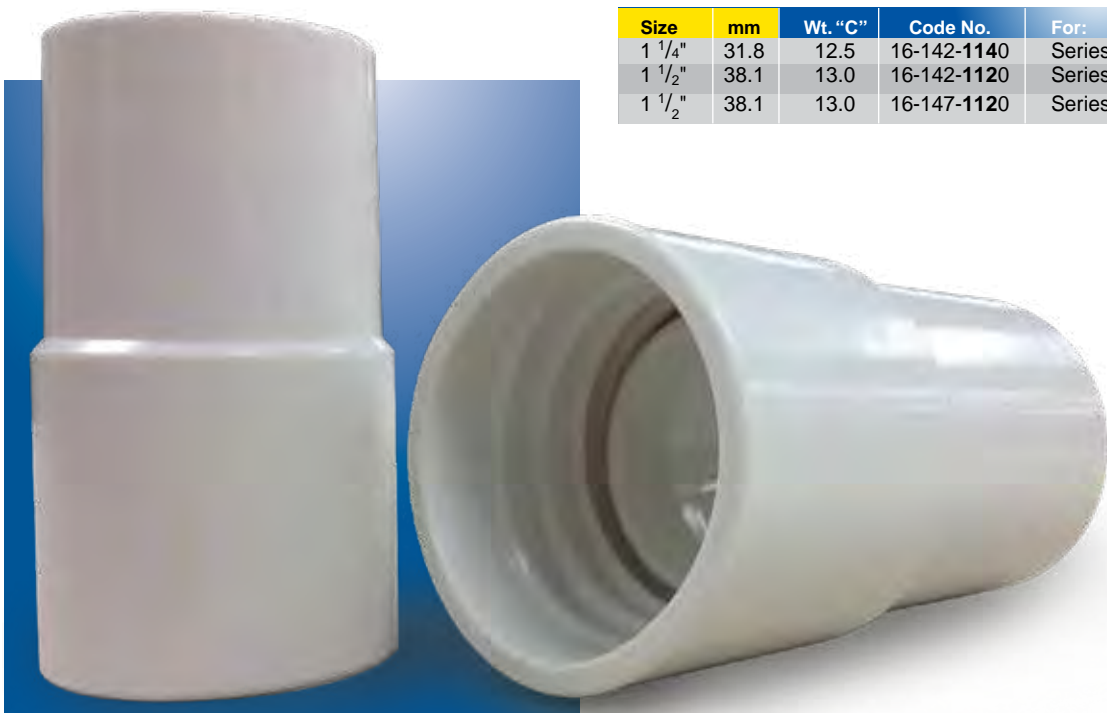

SHIELDS MULTIFLEX



Shields Multiflex Hose has a clear FDA formula PVC with black vinyl helix. It is abrasion resistant, flexible and is resistant to mild chemicals and saltwater. This hose is primarily used for bilge pump discharge, potable water tank fill and drains (sinks, shower, livewell and scupper). This hose uses 147 right hand thread cuffs. **Do not attach to thru hull fitting below the water line. Do not use ethylene glycol based antifreeze in hose.**

I.D.	mm	Bend Radius	mm	Wt. "C"	Bulk Pack 100' (30.5m) Coil Code #	Dist. Pkg. 50' (15.2m) R/O Ctn. Code #	10' (3.1m) Length Code #
5/8"	15.9	1/2"	12.7	8	16-141-0580B	16-141-0586B	—
3/4"	19.1	3/4"	19.1	10	16-141-0340B	16-141-0346B	—
1"	25.4	7/8"	22.2	13	16-141-1000B	16-141-1006B	—
1 1/8"	28.6	1"	25.4	16	16-141-1180B	16-141-1186B	—
1 1/4"	31.8	1 1/2"	38.1	19	16-141-1140B	16-141-1146B	—
1 1/2"	38.1	2"	50.8	24	16-141-1120B	16-141-1126B	—
2"	50.8	5"	127.0	34	16-141-2000B	—	16-141-2003B
1 1/2"	38.1	2"	50.8	24	16-141-1120W	—	16-141-1123W

SHIELDS VAC EXTRA HEAVY DUTY - INDUSTRIAL GRADE



Shields Vac Extra Heavy Duty/Commercial Grade Hose has a smooth cover and clear FDA formula PVC with a white vinyl helix. It is rated for full vacuum and is resistant to mild chemicals and saltwater. This hose is primarily used for bilge pump intake and discharge, potable water tank fill, drains (sinks, shower, and scupper), livewell intake and drain, and sanitation (intake, vent and pump out). This hose is utilized for below the waterline connections. **Do not use ethylene glycol based antifreeze in hose. Do not use in pressurized water systems.**

I.D.	mm	Bend Radius	mm	Vac Rating	Wt. "C"	Bulk Pack 100' (30.5m) Coil Code #	50' (15.2m) R/O Ctn. Code #	Dist. Pkg. 10' (3.1m) Length Code #
5/8"	15.9	3	76.2	28	15	16-146-0580	16-146-0586	—
3/4"	19.1	3	76.2	28	16	16-146-0340	16-146-0346	—
1"	25.4	3	76.2	28	27	16-146-1000	16-146-1006	—
1 1/8"	28.6	4	101.6	28	25	16-146-1180	16-146-1186	—
1 1/4"	31.8	3	76.2	28	30	16-146-1140	16-146-1146	—
1 1/2"	38.1	4	101.6	28	40	16-146-1120	16-146-1126	—
2"	50.8	5	127.0	28	57	16-146-2000	—	16-146-2003
2 1/2"	63.5	7	177.8	28	74	16-146-2120	—	16-146-2123
3"	76.2	9	228.6	28	94	16-146-3000	—	16-146-3003

SHIELDS VAC EXTRA HEAVY DUTY/FDA

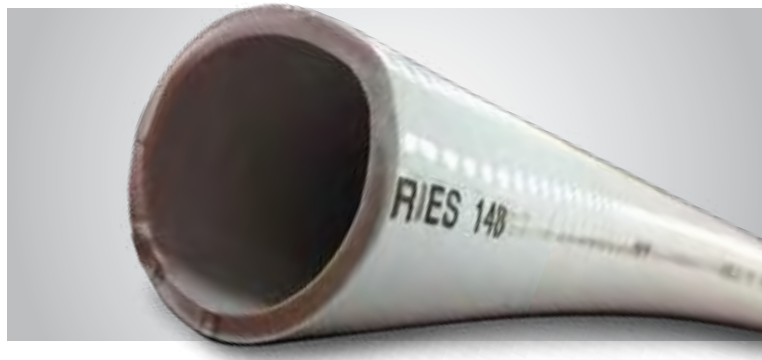

Shields Vac Extra Heavy Duty/FDA Hose has a smooth white FDA grade PVC with vinyl helix. It is rated for full vacuum and is resistant to mild chemicals, permeation, and saltwater. This hose is primarily used for bilge pump intake and discharge, drains (sinks, shower, and scupper), livewell intake and drain, potable water tank fill, and sanitation (toilet to holding tank, intake, self draining lines vent and pump out). This hose is resistant to odor permeation. **Do not use ethylene glycol based antifreeze in hose. Do not use in pressurized water systems.**

I.D.	mm	Bend Radius	mm	Vac Rating	Wt. "C"	Bulk Pack 100' (30.5m) Coil Code #	Dist. Pkg. 50' (15.2m) R/O Ctn. Code #	25' (7.6m) R/O Ctn. Code #
5/8"	15.9	3	76.2	28	15	16-148-0580W	16-148-0586W	—
3/4"	19.1	3	76.2	28	20	16-148-0340W	16-148-0346W	—
1"	25.4	3	76.2	28	27	16-148-1000W	16-148-1006W ①	—
1 1/8"	28.6	4	101.6	28	29	16-148-1180W	16-148-1186W	—
1 1/4"	31.8	4	101.6	28	31	16-148-1140W	16-148-1146W	—
1 1/2"	38.1	5	127.0	28	40	16-148-1120W	16-148-1126W ①	16-148-1125W

① **WARNING:** Lines containing raw sewage should be plumbed to be self-draining.

SHIELDS LIVEWELL HOSE



Shields Livewell Hose has a black smooth cover with vinyl helix. It is rated for full vacuum and is resistant to mild chemicals and saltwater. This hose is primarily used for bilge pump intake and discharge, drains (sinks, shower, and scupper), livewell intake and drain, and sanitation (intake and vent). This hose is utilized for below the waterline connections. **Do not use ethylene glycol based antifreeze in hose.**

I.D.	mm	Bend Radius	mm	Vac Rating	Wt. "C"	Bulk Pack 100' (30.5m) Coil Code #	Dist. Pkg. 50' (15.2m) R/O Ctn. Code #
5/8"	15.9	3	76.2	28	15	16-149-0580	16-149-0586
3/4"	19.1	3	76.2	28	16	16-149-0340	16-149-0346
1"	25.4	3	76.2	28	24	16-149-1000	16-149-1006
1 1/8"	28.6	4	101.6	28	25	16-149-1180	16-149-1186
1 1/4"	31.8	4	101.6	28	28	16-149-1140	16-149-1146
1 1/2"	38.1	5	127.0	28	39	16-149-1120	16-149-1126

SHIELDS 1300/1350 WATER/HEATER HOSE



Shields 1300/1350 Water/Heater Hose is fabric reinforced and has an EPDM tube and cover. This hose is primarily used for engine heater hose, heat exchanger, A/C circulation, and drain lines (sink, icebox, shower and livewell). It is resistant to mild chemicals, heat, cold, ozone and saltwater. The temperature ranges from -40°F – +212°F.

SHIELDS 1300 Water/Heater Hose

I.D.	mm	O.D.	mm	Working Pressure	Wt. "C"	Bulk Pack Code #	m	Bulk Pack 50' (15.2m) R/O Ctn. Code #	Dist. Pkg. 25' (7.6m) R/O Ctn. Code #
1/2"	12.7	3/4"	18.69	62 PSI	17	16-130-0120 (500' reel)	152.4	16-130-0126	—
5/8"	15.9	7/8"	22.3	62 PSI	21	16-130-0580 (500' reel)	152.4	16-130-0586	16-130-0585
3/4"	19.1	1"	25.48	50 PSI	26	16-130-0340 (500' reel)	152.4	16-130-0346	16-130-0345

SHIELDS 1350 HEAVY DUTY Water/Heater Hose

I.D.	mm	O.D.	mm	Working Pressure	Wt. "C"	Bulk Pack Code #	m	Dist. Pkg. 50' (15.2m) R/O Ctn. Code #
1/2"	12.7	13/16"	20.6	200 PSI	19	16-135-0120 (550' reel)	167.6	16-135-0126
5/8"	15.9	31/32"	24.59	200 PSI	26	16-135-0580 (450' reel)	137.2	16-135-0586
3/4"	19.1	1 1/64"	28.4	200 PSI	33	16-135-0340 (400' reel)	121.9	16-135-0346
1"	25.4	1 3/64"	36.6	150 PSI	52	16-135-1000 (300' reel)	91.4	16-135-1006

SHIELDS 1600 WATER/HEATER HOSE

Shields 1600 Water/Heater Hose has a good bend radius, is fabric reinforced, and has an EPDM tube and cover. This hose is primarily used for critical water connections, heat exchanger, toilet intake, small engine intake, bilge pump intake/discharge, and below water line drains and scuppers. It is resistant to mild chemicals, heat, cold, ozone and saltwater. The temperature ranges from -40°F – +190°F



I.D.	mm	O.D.	mm	Working Pressure	Wt. "C"	Bulk Pack Code #	m	Dist. Pkg. 50' (15.2m) R/O Ctn. Code #
3/8"	9.5	45/64"	17.8	250 PSI	17	16-160-0380B (500' reel)	152.4	16-160-0386B
1/2"	12.7	27/32"	21.3	250 PSI	22	16-160-0120B (450' reel)	137.2	16-160-0126B
5/8"	15.9	1"	25.4	250 PSI	28	16-160-0580B (400' reel)	121.9	16-160-0586B
3/4"	19.1	1 9/64"	28.8	250 PSI	34	16-160-0340B (300' reel)	91.4	16-160-0346B
1"	25.4	1 29/64"	36.8	200 PSI	52	16-160-1000B (250' reel)	76.2	16-160-1006B
1 1/4"	31.8	1 3/4"	44.5	200 PSI	62	16-160-1140B (200' reel)	61.0	16-160-1146B

SHIELDS MARINE EXHAUST/WATER HOSE (No Wire)



Shields Marine Exhaust / Water Hose is reinforced with 2 or 4 plies of synthetic cord and is made of black, heavy-walled synthetic rubber. This hose is primarily used for straight connections in wet exhaust systems and engine water circulation lines. It is resistant to engine heat, exhaust fumes, ozone, mild chemicals, antifreeze and saltwater. This hose also has double the ozone resistance required by SAEJ2006. The temperature ranges from -20°F – + 200°F continuous, +250°F intermittent. The hose meets SAE J2006 Type R1 standards.



This certification provides unbiased, third party confirmation worldwide that these Shields hoses meet the highest standards of production quality. Certification ensures the proper level of product safety and inspires user confidence.

Now double the ozone resistance required by SAEJ2006

I.D.	mm	O.D.	Ply	Wt. "C"	50' Coil Code #	12 1/2' Length Code #	6 1/4' Length Code #
1/2"	13	7/8"	2	24	16-200-0120	16-200-0124	16-200-0121
5/8"	16	1 1/32"	2	33	16-200-0580	16-200-0584	16-200-0581
3/4"	19	1 9/64"	2	37	16-200-0340	16-200-0344	16-200-0341
7/8"	22	1 17/64"	2	42	16-200-0780	16-200-0784	16-200-0781
1"	25	1 3/8"	2	48	16-200-1000	16-200-1004	16-200-1001
1 1/8"	28	1 1/2"	2	52	16-200-1180	16-200-1184	16-200-1181
1 1/4"	32	1 45/64"	2	60	16-200-1140	16-200-1144	16-200-1141
1 5/16"	33	1 47/64"	2	62	—	—	—
1 3/8"	35	1 13/16"	2	66	16-200-1380	16-200-1384	16-200-1381
1 1/2"	38	1 15/16"	2	70	16-200-1120	16-200-1124	16-200-1121
1 5/8"	42	2 3/32"	2	77	16-200-1580	16-200-1584	16-200-1581
1 3/4"	45	2 13/64"	2	82	16-200-1340	16-200-1344	16-200-1341
1 7/8"	48	2 23/64"	2	96	16-200-1780	16-200-1784	16-200-1781
2"	51	2 31/64"	2	102	16-200-2000	16-200-2004	16-200-2001
2 1/8"	54	2 19/32"	2	107	16-200-2180	16-200-2184	16-200-2181
2 1/4"	58	2 3/4"	2	114	16-200-2140	16-200-2144	16-200-2141
2 3/8"	60	2 7/8"	2	132	16-200-2380	16-200-2384	—
2 1/2"	63	3"	2	136	16-200-2120	16-200-2124	16-200-2121
2 5/8"	67	3 3/32"	2	147	—	16-200-2584	16-200-2581
2 3/4"	70	3 17/64"	2	152	—	16-200-2344	16-200-2341
2 7/8"	73	3 7/16"	2	174	—	16-200-2784	16-200-2781
3"	76	3 9/16"	2	182	16-200-3000	16-200-3004	16-200-3001
3 1/8"	80	3 45/64"	2	190	—	16-200-3184	16-200-3181
3 1/2"	90	4 3/32"	2	198	—	16-200-3124	16-200-3121
3 3/4"	95	4 9/32"	2	221	—	16-200-3344	16-200-3341
4"	102	4 17/32"	4	229	—	16-200-4004	16-200-4001
4 1/2"	114	5 1/8"	2	300	—	16-200-4124	16-200-4121
5"	127	5 5/8"	2	332	—	16-200-5004	16-200-5001
5 1/2"	140	6 3/16"	2	396	—	—	—
6"	152	6 11/16"	2	427	—	16-200-6004	16-200-6001
8"	203	8 25/32"	4	670	—	16-200-8004	—
10"	254	10 7/8"	4	934	—	16-200-10004	16-200-10001
12"	305	12 7/8"	4	1095	—	16-200-12004	16-200-12001
14"	350	14 7/8"	4	1430	—	—	—

* Special Order

SHIELDS NAUTIFLEX SILICONE EXHAUST HOSE



Shields Nautiflex Silicone Exhaust Hose has a blue silicone cover with a smooth finish for easy clean up. This hose is flexible, easy to install and has four plies of synthetic fabric. It also remains stable at elevated temperatures. This hose is primarily used for straight connections in the wet exhaust system and engine water circulation lines. The temperature ranges from -20°F – $+350^{\circ}\text{F}$. The hose meets SAE J2006 Type R1 and ISO 13363:2004 – Type 2 – Class B standards.

I.D.	mm	O.D.	Wt. "C"	3' (.9m) Length Code No.	6' (1.8m) Length Code No.	12' (3.7m) Length Code No.
1"	25	1 $\frac{3}{8}$ "	33.1	16-202-1000-36	16-202-1001	16-202-1004
1 $\frac{1}{8}$ "	28	1 $\frac{1}{2}$ "	37.2	—	—	—
1 $\frac{1}{4}$ "	32	1 $\frac{5}{8}$ "	41.3	16-202-1140-36	16-202-1141	16-202-1144
1 $\frac{3}{8}$ "	35	1 $\frac{3}{4}$ "	45.4	—	—	—
1 $\frac{1}{2}$ "	38	1 $\frac{7}{8}$ "	49.6	16-202-1120-36	16-202-1121	16-202-1124
1 $\frac{3}{4}$ "	45	2 $\frac{1}{8}$ "	57.8	—	—	—
2"	51	2 $\frac{3}{8}$ "	66.1	16-202-2000-36	16-202-2001	16-202-2004
2 $\frac{3}{8}$ "	60	2 $\frac{3}{4}$ "	78.5	16-202-2380-36	16-202-2381	16-202-2384
2 $\frac{1}{2}$ "	63	2 $\frac{7}{8}$ "	82.6	16-202-2120-36	16-202-2121	16-202-2124
2 $\frac{5}{8}$ "	67	2 $\frac{63}{64}$ "	86.8	16-202-2580-36	16-202-2581	16-202-2584
2 $\frac{3}{4}$ "	70	3 $\frac{1}{8}$ "	90.9	—	—	—
2 $\frac{7}{8}$ "	73	3 $\frac{1}{4}$ "	94.1	—	—	—
3"	76	3 $\frac{3}{8}$ "	99.2	16-202-3000-36	16-202-3001	16-202-3004
3 $\frac{1}{4}$ "	82	3 $\frac{1}{2}$ "	103.4	16-202-3140-36	16-202-3141	16-202-3144
3 $\frac{1}{2}$ "	90	3 $\frac{7}{8}$ "	115.7	16-202-3120-36	16-202-3121	16-202-3124
4"	102	4 $\frac{3}{8}$ "	132	16-202-4000-36	16-202-4001	16-202-4004
5"	127	5 $\frac{3}{8}$ "	165	16-202-5000-36	16-202-5001	16-202-5004
5 $\frac{1}{2}$ "	140	5 $\frac{7}{8}$ "	181.5	—	—	—
6"	152	6 $\frac{3}{8}$ "	198	16-202-6000-36	16-202-6001	16-202-6004
8"	203	8 $\frac{3}{8}$ "	264	16-202-8000-36	16-202-8001	16-202-8004
10"	254	10 $\frac{3}{8}$ "	330	16-202-1000036	16-202-10001	16-202-10004
12"	305	12 $\frac{3}{8}$ "	396	16-202-1200036	16-202-12001	16-202-12004
14"	350	14 $\frac{5}{8}$ "	462	16-202-1400036	—	—



SHIELDSFLEX II MARINE WATER/EXHAUST HOSE (w/ Wire)

Shieldsflex II Marine Water/Exhaust Hose has a black synthetic rubber tube and cover. It is reinforced with wire helix imbedded between plies of HD synthetic cord. It is resistant to exhaust fumes, ozone, mild chemicals, antifreeze and saltwater. This hose is abrasion and odor permeation resistant. It now has double the ozone resistance required by the SAEJ2006. Shieldsflex II is primarily used for engine intake, wet exhaust connections (use where bends or long lengths are required), bilge pump intake/discharge, scupper lines, toilet intake/discharge, and holding tank vent/pump out. The temperature ranges from -20° F – +200°F continuous, +250°F intermittent. The hose meets SAE J2006 Type R2 standards. Bend Radius = 5 x I.D.

I.D.	mm	O.D.	Ply	Wt. "C"	50' (15.2m) Coil Code #	25' (7.6m) Cartons	12 1/2' (3.8m) Length Code #	6 1/4' (1.9m) Length Code #
1/2"	13	27/32"	2	24	16-250-0120	16-250-0125	16-250-0124	16-250-0121
5/8"	16	61/64"	2	28	16-250-0580	16-250-0585	16-250-0584	16-250-0581
3/4"	19	1 1/16"	2	32	16-250-0340	16-250-0345	16-250-0344	16-250-0341
7/8"	22	1 3/16"	2	36	16-250-0780	16-250-0785	16-250-0784	16-250-0781
1"	25	1 5/16"	2	40	16-250-1000	16-250-1005	16-250-1004	16-250-1001
1 1/8"	28	1 7/16"	2	44	16-250-1180	16-250-1185	16-250-1184	16-250-1181
1 1/4"	32	1 19/32"	2	50	16-250-1140	16-250-1145	16-250-1144	16-250-1141
1 5/16"	33	1 5/8"	2	51	16-250-1560	—	16-250-1564	16-250-1561
1 3/8"	35	1 23/32"	2	58	16-250-1380	16-250-1385	16-250-1384	16-250-1381
1 1/2"	38	1 53/64"	2	62	16-250-1120	16-250-1125	16-250-1124	16-250-1121
1 5/8"	42	2"	2	80	16-250-1580	—	16-250-1584	16-250-1581
1 3/4"	45	2 1/8"	2	88	16-250-1340	—	16-250-1344	16-250-1341
1 7/8"	48	2 19/64"	2	93	16-250-1780	—	16-250-1784	16-250-1781
2"	51	2 13/32"	2	99	16-250-2000	—	16-250-2004	16-250-2001
2 1/8"	54	2 17/32"	2	107	16-250-2180	—	16-250-2184	16-250-2181
2 1/4"	58	2 11/16"	2	127	16-250-2140	—	16-250-2144	16-250-2141
2 3/8"	60	2 3/4"	2	132	16-250-2380	—	16-250-2384	16-250-2381
2 1/2"	63	2 7/8"	2	137	16-250-2120	—	16-250-2124	16-250-2121
2 5/8"	67	3 1/16"	2	147	—	—	16-250-2584	16-250-2581
2 3/4"	70	3 3/16"	2	164	16-250-2340	—	16-250-2344	16-250-2341
2 7/8"	73	3 5/16"	2	170	16-250-2780	—	16-250-2784	16-250-2781
3"	76	3 7/16"	2	177	16-250-3000	—	16-250-3004	16-250-3001
3 1/8"	80	3 5/8"	2	200	16-250-3180	—	16-250-3184	16-250-3181
3 1/2"	90	4"	2	223	16-250-3120	—	16-250-3124	16-250-3121
4"	102	4 5/8"	2	269	16-250-4000	—	16-250-4004	16-250-4001
4 1/8"	105	4 47/64"	2	276	—	—	—	—
4 1/2"	114	5 3/32"	2	319	16-250-4120	—	16-250-4124	16-250-4121
5"	127	5 5/8"	2	398	16-250-5000	—	16-250-5004	16-250-5001
5 1/8"	130	5 3/4"	2	417	—	—	—	—
5 1/2"	140	6 3/16"	2	443	—	—	—	—
6"	152	6 21/32"	2	482	—	—	16-250-6004	16-250-6001
8"	203	8 25/32"	2	780	—	—	16-250-8004	—



Now double the ozone resistance required by SAEJ2006



This certification provides unbiased, third party confirmation worldwide that these Shields hoses meet the highest standards of production quality. Certification ensures the proper level of product safety and inspires user confidence.

SHIELDSAUST-C



Now double the ozone resistance required by SAEJ2006

Shieldsaust – C Hose has a black synthetic rubber tube and cover. It is reinforced with double wire helix imbedded between plies of synthetic cord and is abrasion resistant. It is resistant to exhaust fumes, ozone, mild chemicals, antifreeze, and saltwater. This hose is primarily used for wet exhaust connections with significant bends, engine intake and scupper lines. The temperature ranges from -20°F to + 200°F continuous, +250°F intermittent. The hose now has double the ozone resistance required by SAEJ2006. This hose meets SAE J2006 Type R2 standards. Bend Radius = 4 x I.D.

I.D.	mm	O.D.	Ply	Wt. "C"	50' (15.2m) Coil Code #	12 1/2' (3.8m) Length Code #	6 1/4' (1.9m) Length Code #
3/4"	19	1 1/8"	2	27	16-252-0340	16-252-0344	16-252-0341
1"	25	1 11/32"	2	33	16-252-1000	16-252-1004	16-252-1001
1 1/4"	32	1 39/64"	2	45	16-252-1140	16-252-1144	16-252-1141
1 1/2"	38	1 15/16"	2	70	16-252-1120	16-252-1124	16-252-1121
1 5/8"	42	2 3/32"	2	80	16-252-1580	16-252-1584	16-252-1581
1 3/4"	45	2 7/32"	2	85	16-252-1340	16-252-1344	16-252-1341
1 7/8"	48	2 21/64"	2	91	16-252-1780	16-252-1784	16-252-1781
2"	51	2 7/16"	2	95	16-252-2000	16-252-2004	16-252-2001
2 1/8"	54	2 9/16"	2	100	—	16-252-2184	16-252-2181
2 1/4"	58	2 23/32"	2	107	—	16-252-2144	16-252-2141
2 3/8"	60	2 51/64"	2	110	16-252-2380	16-252-2384	16-252-2381
2 1/2"	63	2 59/64"	2	115	16-252-2120	16-252-2124	16-252-2121
2 3/4"	70	3 3/16"	2	126	—	16-252-2344	16-252-2341
2 7/8"	73	3 5/16"	2	137	16-252-2780	16-252-2784	16-252-2781
3"	76	3 7/16"	2	143	16-252-3000	16-252-3004	16-252-3001
3 1/8"	80	3 19/32"	2	150	16-252-3180	16-252-3184	16-252-3181
3 1/2"	90	4 1/16"	2	200	16-252-3120	16-252-3124	16-252-3121
4"	102	4 9/16"	2	231	16-252-4000	16-252-4004	16-252-4001
4 1/8"	105	4 11/16"	2	238	—	16-252-4184	16-252-4181
4 1/2"	114	5 1/8"	2	278	—	16-252-4124	16-252-4121
5"	127	5 9/16"	2	300	—	16-252-5004	16-252-5001
6"	152	6 9/16"	2	394	16-252-6000	16-252-6004	16-252-6001
8"	203	8 11/16"	2	607	—	16-252-8004	16-252-8001



This certification provides unbiased, third party confirmation worldwide that these Shields hoses meet the highest standards of production quality. Certification ensures the proper level of product safety and inspires user confidence.

SHIELDS NAUTIFLEX CORRUGATED SILICONE EXHAUST HOSE



Shields Nautiflex Corrugated Silicone

Exhaust Hose has a blue silicone tube and cover with a smooth finish for easy cleaning. The hose is wire reinforced and will not collapse under suction or in a bend. The corrugated cover allows the hose to bend for easy installation. The Nautiflex, two ply construction, has wire captured between fabric plies. This hose is primarily used for main engine exhaust, generator exhaust, engine coolant circulation, engine intake and generator intake. It is resistant to exhaust fumes, ozone, mild chemicals, antifreeze and saltwater. The hose remains stable at elevated temperatures. The temperature ranges from -20°F – +350°F. This hose meets SAEJ2006 Type R2 and ISO 13362:2004 – Type 1 – Class B standards. Bend Radius = 4 x I.D.

ID	mm	OD	WT "C"	10' (3.1m) length Code No.	12 1/2' (3.8m) Length Code No.	50' (15.2m) coil Code No.	6 1/4' (3.8m) Length Code No.
3/4"	19	1 3/8"	34	—	16-262-0344	16-262-0340	—
1"	25	1 27/64"	42	16-262-1003	16-262-1004	16-262-1000	—
1 1/8"	28	1 1/2"	46	16-262-1183	16-262-1184	16-262-1180	—
1 1/4"	32	1 45/64"	52	16-262-1143	16-262-1144	16-262-1140	—
1 3/8"	35	1 55/64"	60	16-262-1383	16-262-1384	16-262-1380	—
1 1/2"	38	2"	71	16-262-1123	16-262-1124	16-262-1120	—
1 5/8"	42	2 11/64"	74	16-262-1583	16-262-1584	16-262-1580	—
1 3/4"	45	2 19/64"	78	16-262-1343	16-262-1344	16-262-1340	—
1 7/8"	48	2 13/32"	82	16-262-1783	16-262-1784	16-262-1780	—
2"	51	2 17/32"	87	16-262-2003	16-262-2004	16-262-2000	—
2 1/8"	54	2 5/8"	94	—	—	—	—
2 3/8"	60	2 7/8"	101	16-262-2383	16-262-2384	16-262-2380	—
2 1/2"	63	3 3/64"	113	16-262-2123	16-262-2124	16-262-2120	—
2 3/4"	70	3.312"	125	16-262-2343	16-262-2344	16-262-2340	—
2 7/8"	73	3 7/16"	134	16-262-2783	16-262-2784	16-262-2780	—
3"	76	3 35/64"	139	16-262-3003	16-262-3004	16-262-3000	—
3 1/2"	90	4 19/64"	227	16-262-3123	16-262-3124	16-262-3120	—
4"	102	4 49/64"	255	16-262-4003	16-262-4004	16-262-4000	—
5"	127	5 3/4"	310	16-262-5003	—	16-262-5000	—
6"	152	6 15/16"	484	16-262-6003	—	—	16-262-6001
8"	203	9 7/64"	768	16-262-8003	—	—	—
10"	254	11 17/64"	1136	16-262-10003	—	—	—
12"	305	13.359"	1518	16-262-12003	—	—	—
14"	350	15.281"	1812	16-262-14003	—	—	—
16"	404	17.562"	2277	16-262-16003	—	—	—

* Special Order

SHIELDS COMPLEX - ALL IN ONE HOSE FOR INSPECTED VESSELS

Shields Complex is a versatile wire reinforced hose specially designed for inspected vessels. Complex is rated for fuel, vital water and non-vital water systems on boats requiring SAE J1942 hoses. Applications include bilge, coolant, oil and fuel systems using gasoline, gasohol, diesel, bio-diesel, wet exhaust systems, non-potable water systems, engine intake, toilet and holding tank connections.



Tube: Black Nitrile

Reinforcement: 2 textile plies w/ dual wire helix

Cover: Black Chlorprene

Temp. Range: -20F to +212F

Specifications - SAE J1942 Code F, VW, NVW; SAE J1527 A1; SAE J2006 R2; SAE 20R2 B; SAE J20R4 B; SAE 20R5 B, SAE 30R5, ISO 7840 A1

Additional sizes available. 150' minimum order.

I.D.	mm	O.D.	PLY	Wt. "C"	Bend Radius	WP	50' Coil Code #	12 1/2' (3.8m) Length Code #	10' (3.1m) Length Code #	6 1/4' (3.8m) Length Code #
5/8"	15.9	1"	2	33	1.5	75	16-321-0580	16-321-0584	16-321-0583	16-321-0581
3/4"	19.1	1.19"	2	39	1.5	75	16-321-0340	16-321-0344	16-321-0343	16-321-0341
1"	25.4	1.41"	2	53	2	75	16-321-1000	16-321-1004	16-321-1003	16-321-1001
1 1/8"	28.6	1.56"	2	62	3	75	16-321-1180	16-321-1184	16-321-1183	16-321-1181
1 1/4"	31.8	1.66"	2	64	3	75	16-321-1140	16-321-1144	16-321-1143	16-321-1141
1 1/2"	38.1	1.91"	2	78	3	50	16-321-1120	16-321-1124	16-321-1123	16-321-1121
2"	50.8	2.48"	2	118	5	50	16-321-2000	16-321-2004	16-321-2003	16-321-2001

SHIELDS MULTIFLEX



Shields Multiflex Hose has a clear FDA formula PVC with black vinyl helix. It is abrasion resistant, flexible and is resistant to mild chemicals and saltwater. This hose is primarily used for bilge pump discharge, potable water tank fill and drains (sinks, shower, livewell and scupper). This hose uses 147 right hand thread cuffs. **Do not attach to thru hull fitting below the water line. Do not use ethylene glycol based antifreeze in hose.**

I.D.	mm	Bend Radius	mm	Wt. "C"	Bulk Pack 100' (30.5m) Coil Code #	Dist. Pkg. 50' (15.2m) R/O Ctn. Code #	10' (3.1m) Length Code #
5/8"	15.9	1/2"	12.7	8	16-141-0580B	16-141-0586B	
3/4"	19.1	3/4"	19.1	10	16-141-0340B	16-141-0346B	
1"	25.4	7/8"	22.2	13	16-141-1000B	16-141-1006B	
1 1/8"	28.6	1"	25.4	16	16-141-1180B	16-141-1186B	
1 1/4"	31.8	1 1/2"	38.1	19	16-141-1140B	16-141-1146B	
1 1/2"	38.1	2"	50.8	24	16-141-1120B	16-141-1126B	
2"	50.8	5"	127.0	34	16-141-2000B	-	16-141-2003B
1 1/2"	38.1	2"	50.8	24	16-141-1120W	-	16-141-1123W

SHIELDS VAC EXTRA HEAVY DUTY/FDA

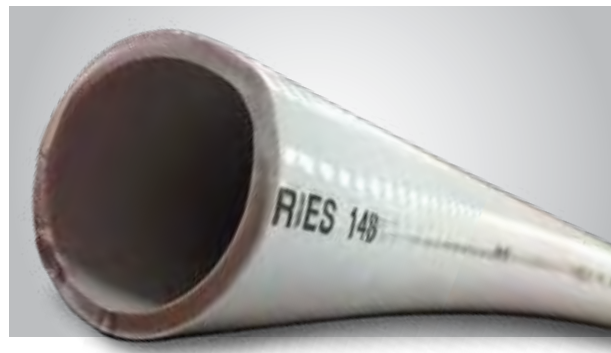

Shields Vac Extra Heavy Duty/FDA Hose has a smooth white FDA grade PVC with vinyl helix. It is rated for full vacuum and is resistant to mild chemicals, permeation, and saltwater. This hose is primarily used for bilge pump intake and discharge, drains (sinks, shower, and scupper), livewell intake and drain, potable water tank fill, and sanitation (toilet to holding tank, intake, self draining lines vent and pump out). This hose is resistant to odor permeation. **Do not use ethylene glycol based antifreeze in hose. Do not use in pressurized water systems.**

I.D.	mm	Bend Radius	mm	Vac Rating	Wt. "C"	Bulk Pack 100' (30.5m) Coil Code #	Dist. Pkg. 50' (15.2m) R/O Ctn. Code #	25' (7.6m) R/O Ctn. Code #
5/8"	15.9	3	76.2	28	15	16-148-0580W	16-148-0586W	—
3/4"	19.1	3	76.2	28	20	16-148-0340W	16-148-0346W	—
1"	25.4	3	76.2	28	27	16-148-1000W	16-148-1006W ①	—
1 1/8"	28.6	4	101.6	28	29	16-148-1180W	16-148-1186W	—
1 1/4"	31.8	4	101.6	28	31	16-148-1140W	16-148-1146W	—
1 1/2"	38.1	5	127.0	28	40	16-148-1120W	16-148-1126W ①	16-148-1125W

① **WARNING:** Lines containing raw sewage should be plumbed to be self-draining.

SHIELDS LIVEWELL HOSE



Shields Livewell Hose has a black smooth cover with vinyl helix. It is rated for full vacuum and is resistant to mild chemicals and saltwater. This hose is primarily used for bilge pump intake and discharge, drains (sinks, shower, and scupper), livewell intake and drain, and sanitation (intake and vent). This hose is utilized for below the waterline connections. **Do not use ethylene glycol based antifreeze in hose. Not for potable water.**

I.D.	mm	Bend Radius	mm	Vac Rating	Wt. "C"	Bulk Pack 100' (30.5m) Coil Code #	Dist. Pkg. 50' (15.2m) R/O Ctn. Code #
5/8"	15.9	3	76.2	28	15	16-149-0580	16-149-0586
3/4"	19.1	3	76.2	28	16	16-149-0340	16-149-0346
1"	25.4	3	76.2	28	24	16-149-1000	16-149-1006
1 1/8"	28.6	4	101.6	28	25	16-149-1180	16-149-1186
1 1/4"	31.8	4	101.6	28	28	16-149-1140	16-149-1146
1 1/2"	38.1	5	127.0	28	39	16-149-1120	16-149-1126

SHIELDS PVC TUBING - CLEAR

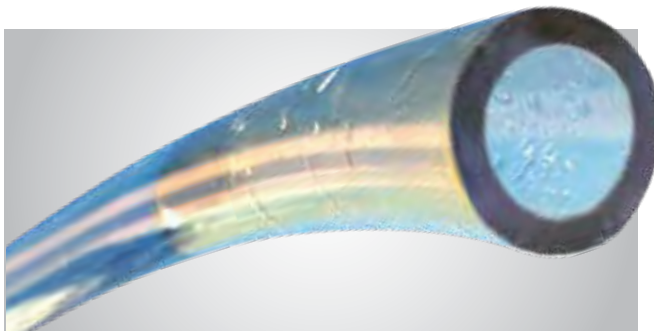

Shields Clear PVC Tubing has a single layer FDA formula vinyl. This hose is primarily used for non-pressurized potable water system supply and drain lines (sink, shower, icebox). This hose is NOT for use in hot water or pressurized water systems.

I.D.	mm	Wall	mm	Burst Pressure 70°	Wt. "C"	Code #	Bulk Pack	mm	100' (30.5m) R/O Ctn. Code #	Dist. Pkg. 50' (15.2m) R/O Ctn. Code #	25' (7.6m) Polypac Code #
3/16"	4.8	.062	1.6	65#	3	16-150-0360	750'	228.6	16-150-0367	16-150-0366	16-150-0365
1/4"	6.4	.078	2.0	60#	4	16-150-0140	500'	152.4	16-150-0147	16-150-0146	16-150-0145
5/16"	7.9	.093	2.4	55#	5	16-150-0560	200'	61.0	16-150-0567	16-150-0566	16-150-0565
3/8"	9.5	.094	2.4	55#	6	16-150-0380	200'	61.0	—	16-150-0386	16-150-0385
1/2"	12.7	.11	2.8	45#	12	16-150-0120	200'	61.0	16-150-0127	16-150-0126	16-150-0125
5/8"	15.9	.11	2.8	40#	15	16-150-0580	200'	61.0	16-150-0587	16-150-0586	16-150-0585
3/4"	19.1	.11	2.8	35#	19	16-150-0340	200'	61.0	16-150-0347	16-150-0346	16-150-0345
1"	25.4	.125	3.2	20#	27	16-150-1000	100'	30.5	16-150-1007	16-150-1006	16-150-1005
1 1/8"	28.6	.125	3.2	20#	29	16-150-1180	100'	30.5	—	16-150-1186	—
1 1/4"	31.8	.125	3.2	20#	31	16-150-1140	100'	30.5	—	16-150-1146	16-150-1145
1 1/2"	38.1	.125	3.2	20#	34	16-150-1120	50'	15.2	—	16-150-1126	16-150-1125

SHIELDS ALL CLEAR PVC TUBING POLYESTER REINFORCED (Red-Tracer)

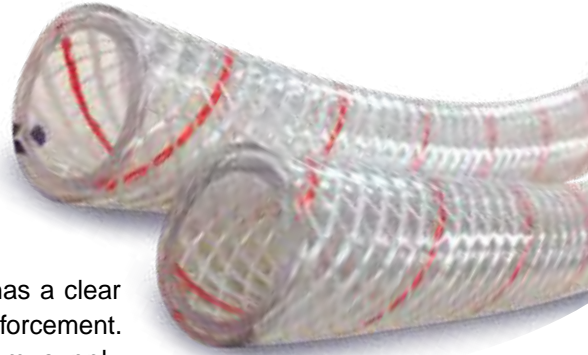

Shields Clear Polyester Reinforced Red Tracer PVC Tubing has a clear heavy wall FDA formula vinyl. It has a polyester braid reinforcement. This hose is primarily used for pressurized water system supply (hot or cold), drain lines (sink, shower, icebox), wash down pump connections and head intake.

I.D.	mm	O.D.	mm	Burst Pressure	Wt. "C"	Bulk Pack 250' (76.2m) Coil Code #	Dist. Pkg. 50' (15.2m) R/O Ctn. Code #	25' (7.6m) Polypac Code #	10' (3.1m) Polypac Code #
3/8"	9.5	9/16"	14.3	500#	7	16-162-0380	16-162-0386	16-162-0385	16-162-0383
1/2"	12.7	23/32"	18.3	500#	11	16-162-0120	16-162-0126	16-162-0125	16-162-0123
5/8"	15.9	27/32"	21.4	400#	14	16-162-0580	16-162-0586	16-162-0585	16-162-0583
3/4"	19.1	31/32"	24.6	325#	17	16-162-0340	16-162-0346	16-162-0345	16-162-0343
1"	25.4	1 5/16"	33.3	325#	24	16-162-1000	16-162-1006	16-162-1005	16-162-1003
1 1/8"	28.6	1 3/8"	34.9	375#	32	16-162-1180 ①	16-162-1186	—	—
1 1/4"	31.8	1 5/8"	41.3	325#	44	16-162-1140 ①	16-162-1146	—	—
1 1/2"	38.1	1 15/16"	49.2	300#	67	16-162-1120 ①	16-162-1126	—	—

① 100' roll

SHIELDS BRAIDED WASH DOWN HOSE



Shields Braided Wash Down Hose has a white FDA formula vinyl tube and clear vinyl cover. It has a polyester braid reinforcement and a 250 PSI burst pressure. This hose has brass ends, is lightweight and easy to handle. This hose is primarily used for dockside wash down and is safe for potable water.

I.D.	mm	Length	mm	Bulk Pack	Wt.	Code No.
5/8"	15.9	25'	7.6	5	3.25	16-163-0585
5/8"	15.9	50'	15.2	5	6.50	16-163-0586
5/8"	15.9	75'	22.9	5	9.75	16-163-0588
5/8"	15.9	100'	30.5	5	13.00	16-163-0587

SHIELDS CLEAR WHITE PVC TUBING POLYESTER REINFORCED (Blue-Tracer)

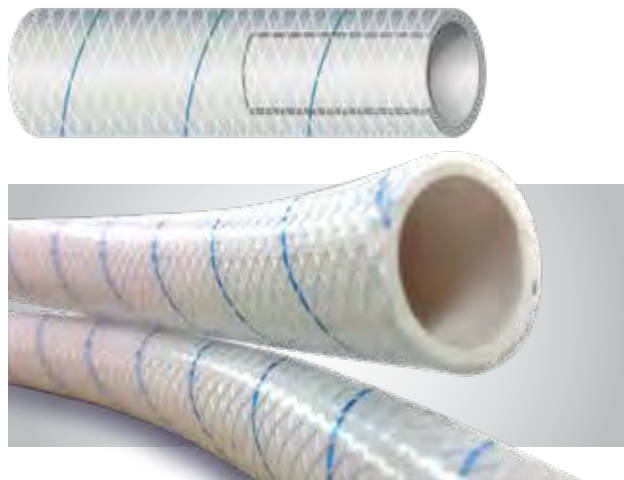

Clear White Blue Tracer PVC Tubing has a white FDA formula vinyl tube. It has a clear vinyl cover, polyester braid reinforcement. This hose is primarily used for pressurized water system supply (hot or cold), drain lines (sink, shower, icebox), wash down pump connections and head intake.



I.D.	mm	O.D.	mm	Burst Pressure	Wt. "C"	Bulk Pack 250' (76.2m) Coil Code #	50' (15.2m) R/O Ctn. Code #	Dist. Pkg. 25' (7.6m) Polypac Code #	10' (3.1m) Polypac Code #
1/2"	12.7	1 1/16"	17.5	500#	10	16-164-0120	16-164-0126	16-164-0125	16-164-0123
5/8"	15.9	1 3/16"	20.6	400#	13	16-164-0580	16-164-0586	16-164-0585	16-164-0583
3/4"	19.1	1 5/16"	23.8	325#	17	16-164-0340	16-164-0346	16-164-0345	16-164-0343

SHIELDS HEAVY DUTY POLYESTER REINFORCED PVC TUBING

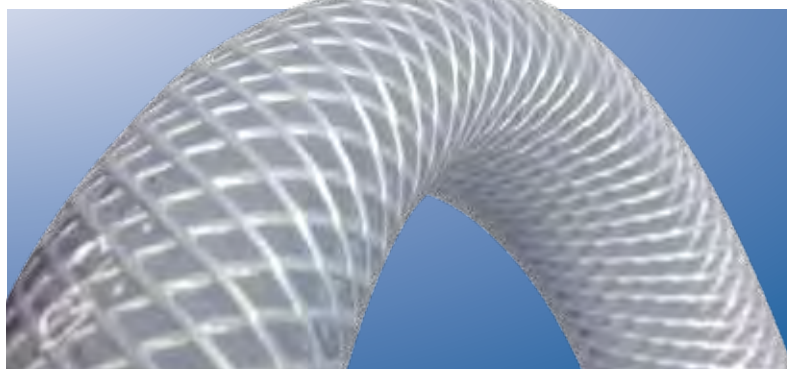
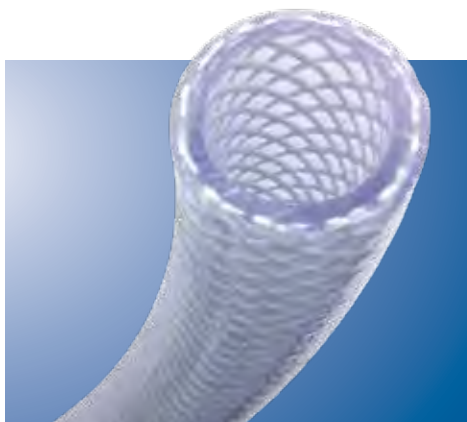

Shields Heavy-Duty Polyester Reinforced PVC Tubing has a clear extra heavy wall FDA formula vinyl. It has superior kink resistance and a polyester braid reinforcement. This hose is primarily used for pressurized water system supply (hot or cold), wash down pump connections and head intake.

I.D.	mm	O.D.	mm	Burst Pressure	Wt. "C"	Code #	Bulk Pack	Dist. Pkg. 50' (15.2m) R/O Ctn. Code #
1/4"	6.4	.438"	11.1	250#	5.6	16-168-0140	300'	16-168-0146
3/8"	9.5	.594"	15.1	225#	9.2	16-168-0380	300'	16-168-0386
1/2"	12.7	.750"	19.1	200#	13.5	16-168-0120	300'	16-168-0126
5/8"	15.9	.875"	22.2	200#	16.2	16-168-0580	300'	16-168-0586
3/4"	19.1	1.025"	26.0	150#	21.1	16-168-0340	300'	16-168-0346
1"	25.4	1.312"	33.3	125#	31.2	16-168-1000	200'	16-168-1006
1 1/4"	31.8	1.656"	42.1	100#	51	16-168-1140	100'	16-168-1146
1 1/2"	38.1	1.937"	49.2	100#	65	16-168-1120	100'	16-168-1126

SHIELDS OIL TANK FILL HOSE

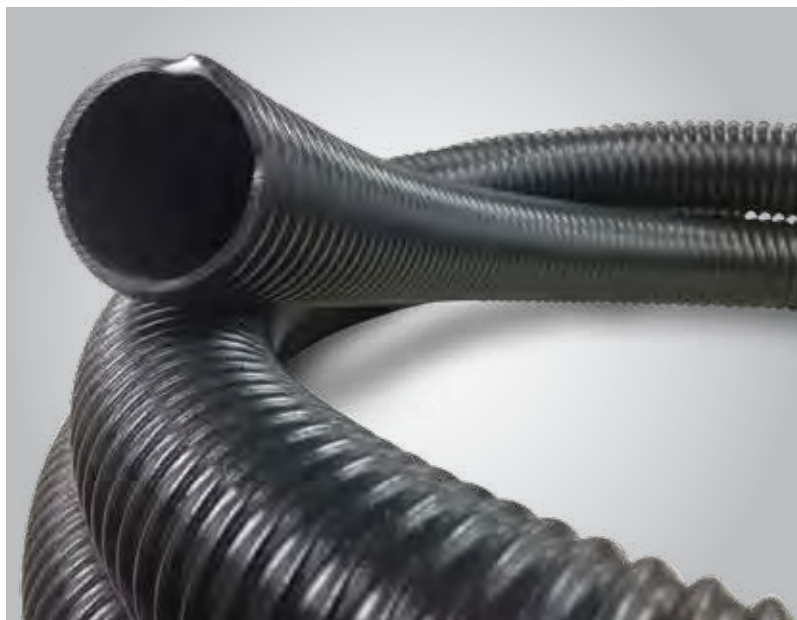

Shields Oil Tank Fill Hose has a nitrile/PVC blend for excellent oil resistance. It has a flexible corrugated design, smooth bore and a vinyl helix to prevent collapse. It also resists ozone and cold temperature cracking. This hose is primarily used for 2-cycle oil tank fill.

I.D.	mm	Bend Radius	mm	Wt "C"	Bulk Pack 100' (30.5m) Coils Code #	Dist. Pkg. 50' (15.2m) R/O Ctn. Code #	10' (3.1m) Ctn Code #
1 1/2"	38.1	4"	101.6	22	16-309-1120	16-309-1126	16-309-1123

SHIELDS SILVERADO 2000 FUEL VENT LINE



Silverado 2000 Fuel Vent Line is primarily used for fuel tank vent (outside the engine compartment) and is for pleasure boats only. The Temperature range is -5 F to +180 F. It meets SAE J1527 Type B2 standards.



I.D.	mm	O.D.	mm	Ply	Burst Pressure	Wt. "C"	Bulk Pack Code #	50' (15.2m) R/O Ctn. Code #	Dist. Pkg. 25' (7.6m) R/O Ctn. Code #	10' (3.1m) Polypac Code #	Bulk Pack 100' (30.5m) Coil Code #
5/8"	15.9	29/32"	23.0	2	175#	24.0	16-315-0580 (250' reel)	16-315-0586	16-315-0585	16-315-0583	16-315-0587

SHIELDS SILVERADO 4000 OUTBOARD FUEL LINE

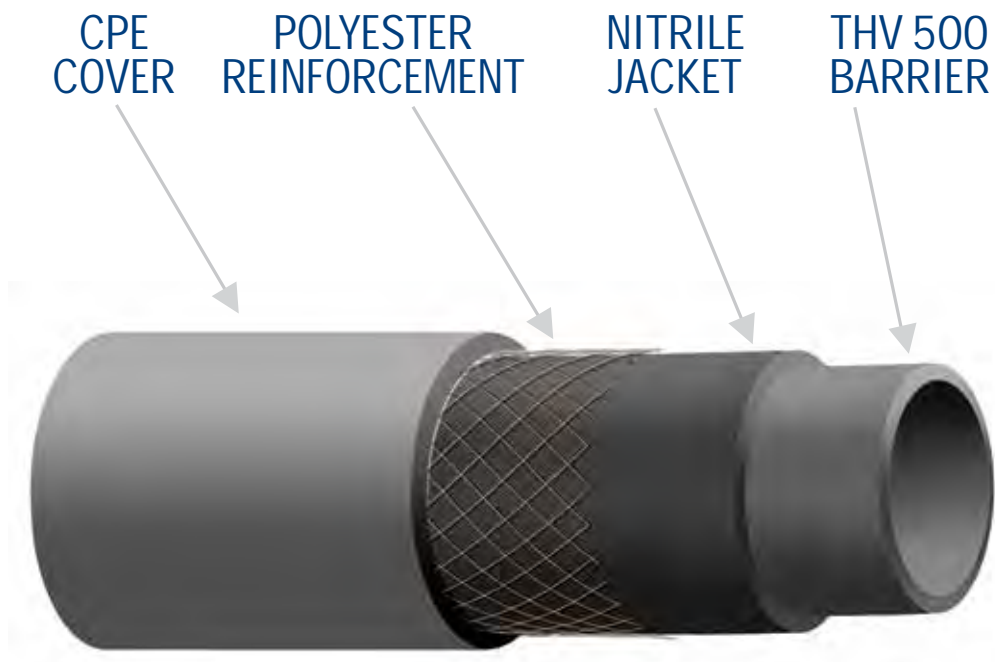

CONSTRUCTION

The series 337 fuel lines (Silverado 4000) is the best B1 fuel line in the market place. Utilizing a complex construction technique involving a THV500 barrier layer, a Nitrile jacket, Polyester reinforcement and a CPE cover; we are able to offer a hose that outperforms all competitors. The Silverado 4000 hose has a small O.D., is extremely flexible and easy to clamp. Not only does the Silverado 4000 meet all requirements it has become the only fuel line worthy to be utilized in Sierra's fuel line assemblies.



Silverado 4000 Outboard Fuel Line is resistant to ethanol blended fuels. This hose is EPA and CARB compliant. Silverado 4000 has a THV barrier layer to prevent permeation, polyester reinforcement for strength and a weather and UV resistant CPE cover. The gray color keeps hose cooler and helps prevent vapor lock. This hose is for above deck primer bulb applications, and is not fire retardant.



Meets SAE J1527 Type B1-15
Meets ISO 8469 B1

I.D.	mm	O.D.	mm	Wt. "C"	Bulk Pack Code #	50' (15.2m) R/O Ctn. Code #	Dist. Pkg. 25' (7.6m) R/O Ctn. Code #	10' (3.1m) Polypac Code #
1/4"	6.4	7/16"	10.90	6	16-337-0140	16-337-0146	16-337-0145	16-337-0143
5/16"	7.9	1/2"	12.75	7	16-337-0560	16-337-0566	16-337-0565	16-337-0563
3/8"	9.5	35/64"	13.72	7.65	16-337-0380	16-337-0386	16-337-0385	16-337-0383

SHIELDS FIRE-ACOL FUEL FILL HOSE

Shields Fire – Acol – Fuel Fill Hose resists gasoline/alcohol blends and is compounded for low permeation. Special compound resists cover deterioration due to alcohol fuel resting in hose. It is abrasion resistant and it is reinforced with wire helix imbedded between plies of HD synthetic cord. This imported hose is primarily used for fuel fill (gas or diesel) and is for pleasure boats only. The temperature range is -5°F to 180°F. It meets SAE J1527 Type A2 and ISO 7840 Type A2 NMMA/CE Type Accepted standards.

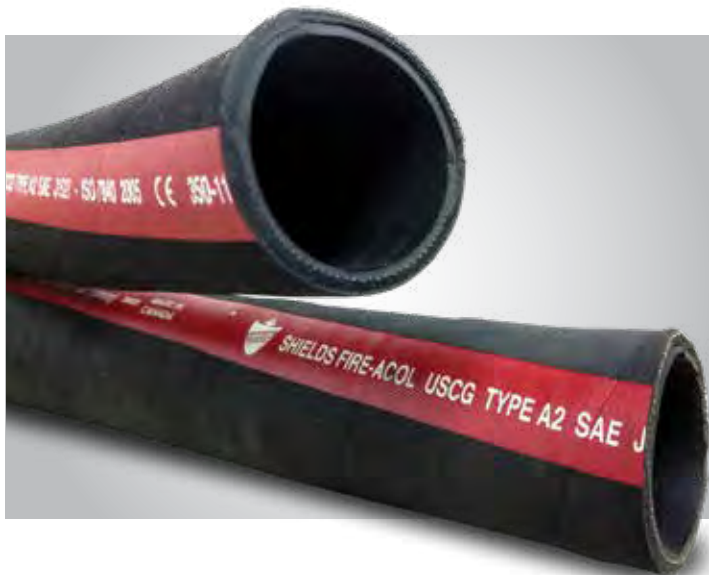

I.D.	mm	O.D.	mm	Ply	Burst Pressure	Wt. "C"	50' (15.2m) Coils Code #	12 1/2' (3.8m) Length Code #	12 1/2' (3.8m) Carton Code #	10' (3.1m) Length Code #	10' (3.1m) Carton Code #
1 1/2"	38	1 57/64"	48	2	90	77	16-350-1120	16-350-1124		16-350-1123	
1 5/8"	41.3	2 3/64"	52.0	2	90#	89	16-350-1580	16-350-1584	16-350-1584BX	16-350-1583	—
1 7/8"	47.6	2 9/32"	58.0	2	90#	114	16-350-1780	16-350-1784	16-350-1784BX	16-350-1783	16-350-1783BX
2"	50.8	2 31/64"	63.1	2	90#	121	16-350-2000	16-350-2004	16-350-2004BX	16-350-2003	16-350-2003BX
2 3/8"	60.3	2 27/32"	72.2	2	90#	137	16-350-2380	16-350-2384	—	16-350-2383	—

SHIELDS FIRE-ACOL "C" FUEL FILL HOSE



Shields Fire – Acol – "C" Fuel Fill Hose resists gasoline/alcohol blends and has a corrugated cover for extra flexibility. This hose is compounded for low permeation and is reinforced with a wire helix imbedded between plies of HD synthetic cord. It is also abrasion resistant. This hose is primarily used for extra flexible fuel fill (gas or diesel) and is for pleasure boats only. The temperature range is -5°F to 180°F. It meets SAE J1527 type A2 and NMMA Type Accepted standards.



I.D.	mm	O.D.	mm	Ply	Burst Pressure	Wt. "C"	Bulk Pack 50' (15.2m) Coils	Dist. Pkg.	
								12 1/2' (3.8m) Length	10' (3.1m) Length
1 1/2"	38.1	1 57/64"	48.0	2	90#	77	16-351-1120	16-351-1124	16-351-1123

SHIELDS FUEL FILL HOSE



Shields Fire – Acol – Fuel Fill Hose resists gasoline/alcohol blends and is compounded for low permeation. It is abrasion resistant and it is reinforced with wire helix imbedded between piles of HD synthetic cord. This imported hose is primarily used for fuel fill (gas or diesel) and is for pleasure boats only. It meets SAE J1527 Type A2 and ISO 7840 Type A2 NMMA/CE Type Accepted standards.



I.D.	mm	O.D.	mm	Ply	Burst Pressure	Wt. "C"	50' (15.2m) Coils Code #	12 1/2' (3.8m) Length Code #	12 1/2' (3.8m) Carton Code #	10' (3.1m) Length Code #	10' (3.1m) Carton Code #	25' (7.6m) Length Code #
1 1/2"	38.1	1 57/64"	48.0	2	90#	77	16-355-1120	16-355-1124	16-355-1124BX	16-355-1123	16-355-1123BX	16-355-1125
2"	51	2 31/64"	63.1	2	90#	111	16-355-2000	16-355-2004	—	16-355-2003	—	—

SHIELDS FIRE-ACOL 15 LOW PERMEATION FUEL HOSE

Shields Fire-Acol 15 – Low Permeation Fuel Hose has a special design NBR tube with an embedded plastic barrier layer to prevent permeation. The design of this hose provides easy coupling insertion and the NBR/PVC cover is weather and UV resistant. The hose is also polyester reinforced and fire-resistant. This hose is primarily used for fuel feed (gasoline up to 85% ethanol blended fuels/diesel/bio-diesel all blends). The temperature range is -20°F to 212°F.

*Meets new CARB 10 g/M2/24 hrs. standard

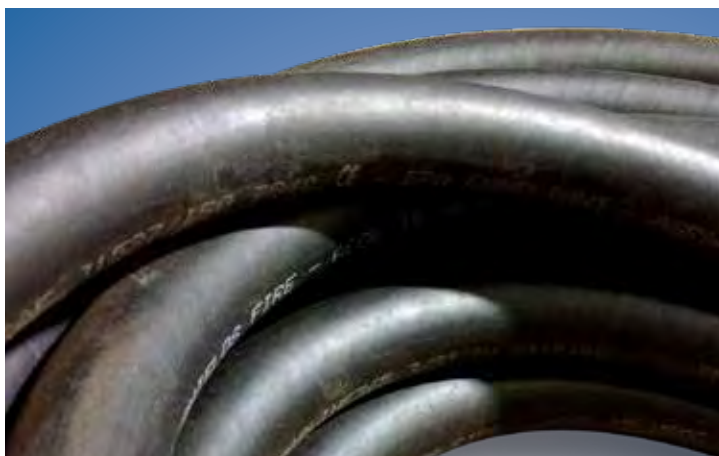

I.D.	mm	O.D.	mm	Max WP	Wt. C	Bulk Pack 250' reel Code #	50' R/O Ctn. Code #	10' Polypac Code #
3/8"	9.5	49/64"	19.3	100	22	16-365-0380	16-365-0386	—
1/2"	12.7	29/32"	22.86	100	27	16-365-0120	16-365-0126	—

This hose complies with EPA and CARB very low permeation requirements. It meets USCG Type A1-15 requirements for pleasure boats, SAE J1527 Type A1-15, ISO 7840 Type A1, and NMMA/CE Type accepted standards

SHIELDS LOW PERMEATION MARINE FUEL HOSE



Shields Low Permeation Marine Fuel Hose has a plastic barrier veneer with an NBR outer layer tube to prevent permeation. This polyester reinforced hose complies with EPA and CARB very low permeation requirements and is weather/UV resistant. This hose is primarily used for fuel feed (gasoline up to 85% ethanol blended fuels/diesel/all bio-diesel blends). It meets USCG Type A1 – 15 requirements for pleasure boats and meets SAE J1527 Type A1-15, ISO 7840 Type A1, and NMMA/CE type accepted standards. The temperature ranges from -20°F to 212°F.



*Meets new CARB 10 g/M2/24 hrs. standard

I.D.	mm	O.D.	mm	Max WP	Wt. C	Bulk Pack 250' reel Code #	50' R/O Ctn. Code #	25' R/O Ctn Code #	10' Polypac Code #
1/4"	6.4	35/64"	13.72	100	11	16-368-0140	16-368-0146	16-368-0145	16-368-0143
5/16"	7.9	5/8"	15.49	100	13	16-368-0560	16-368-0566	16-368-0565	16-368-0563
3/8"	9.5	11/16"	17.27	100	16	16-368-0380	16-368-0386	16-368-0385	16-368-0383
1/2"	12.7	13/16"	20.83	100	20	16-368-0120	16-368-0126	16-368-0125	16-368-0123

SHIELDS FIRE-ACOL FUEL VENT



Shields Fire-Acol Fuel Vent hose resists gasoline/alcohol blended fuel and is fire resistant. It features a weather/UV resistant NBR/PVC cover. This hose is primarily used for fuel vent lines (gasoline up to 85% ethanol blended fuels/diesel fuels). It meets USCG Type A2 requirements for pleasure boats and meets SAE J1527 Type A2, ISO 7840 Type A2 and NMMA/CE Type accepted standards. The temperature ranges from -20°F to 160°F.



I.D.	mm	O.D.	mm	Max WP	Wt. C	Bulk Pack 250' reel Code #	50' R/O Ctn. Code #	25' R/O Ctn Code #	10' Polypac Code #
5/8"	15.9	31/32"	24.6	50	25	16-369-0580	16-369-0586	16-369-0585	16-369-0583

SHIELDS COMFLEX - ALL IN ONE HOSE FOR INSPECTED VESSELS

Shields Complex is a versatile wire reinforced hose specially designed for inspected vessels. Complex is rated for fuel, vital water and non-vital water systems on boats requiring SAE J1942 hoses. Applications include bilge, coolant, oil and fuel systems using gasoline, gasohol, diesel, bio-diesel, wet exhaust systems, non-potable water systems, engine intake, toilet and holding tank connections.



Tube: Black Nitrile

Reinforcement: 2 textile plies w/ dual wire helix

Cover: Black Chlorprene

Temp. Range: -20F to +212F

Specifications - SAE J1942 Code F, VW, NVW; SAE J1527 A1; SAE J2006 R2; SAE 20R2 B; SAE J20R4 B; SAE 20R5 B, SAE 30R5, ISO 7840 A1

Additional sizes available. 150' minimum order.

I.D.	mm	O.D.	PLY	Wt. "C"	Bend Radius	WP	50' Coil Code #	12 1/2' (3.8m) Length Code #	10' (3.1m) Length Code #	6 1/4' (3.8m) Length Code #
5/8"	15.9	1"	2	33	1.5	75	16-321-0580	16-321-0584	16-321-0583	16-321-0581
3/4"	19.1	1.19"	2	39	1.5	75	16-321-0340	16-321-0344	16-321-0343	16-321-0341
1"	25.4	1.41"	2	53	2	75	16-321-1000	16-321-1004	16-321-1003	16-321-1001
1 1/8"	28.6	1.56"	2	62	3	75	16-321-1180	16-321-1184	16-321-1183	16-321-1181
1 1/4"	31.8	1.66"	2	64	3	75	16-321-1140	16-321-1144	16-321-1143	16-321-1141
1 1/2"	38.1	1.91"	2	78	3	50	16-321-1120	16-321-1124	16-321-1123	16-321-1121
2"	50.8	2.48"	2	118	5	50	16-321-2000	16-321-2004	16-321-2003	16-321-2001



FERRULE VISE/DIES

Hand operated vise for making fuel line assemblies without clamps. Vise uses ordinary barbed fittings with series 700 solid brass ferrules. Makes professional looking leak proof fuel lines. Furnished with removable handle. Dies must be ordered separately. When ordering dies, please consult chart under brass ferrules to determine proper size.

Part #	Description
No. 18-J662-xxx	Dies give longitudinal crimp.
No. 18-J664-xxx	Dies give circular and longitudinal crimp.
No. 18-J-VISE	Vise (w/o dies)

* Special Order Only

45° SAE FEMALE SWIVEL



Code No.	Hose I.D.	Tube	Thread
18-502-1476	1/4"	1/4"	7/16-20
18-502-5612	5/16"	5/16"	1/2-20
18-502-5658	5/16"	3/8"	5/8-18
18-502-3858	3/8"	3/8"	5/8-18
18-502-3834	3/8"	1/2"	3/4-16
18-502-1234	1/2"	1/2"	3/4-16
18-502-1278	1/2"	5/8"	7/8-14

Standard Package: 100 pieces

ADAPTER — MALE PIPE TO SAE 45° FLARE



Code No.	Tube	Pipe
18-600-1418	1/4"	1/8"
18-600-1414	1/4"	1/4"
18-600-5618	5/16"	1/8"
18-600-3818	3/8"	1/8"
18-600-3814	3/8"	1/4"
18-600-3838	3/8"	3/8"
18-600-1212	1/2"	1/2"
18-600-5812	5/8"	1/2"

Standard Package: 100 pieces

ADAPTER — MALE PIPE TO SAE 45° FLARE 90°



Code No.	Tube	Pipe
18-601-3814	3/8"	1/4"

MALE PIPE



Bulk Pack Code No.	Hose Barb Sierra No.	Hose I.D.	Thread
18-500-1418	18-8043	1/4"	1/8"
18-500-1414	18-8042	1/4"	1/4"
18-500-5618	18-8054	5/16"	1/8"
18-500-5614	18-8055	5/16"	1/4"
18-500-3818	18-8073	3/8"	1/8"
18-500-3814	18-8074	3/8"	1/4"
18-500-3838	18-8108	3/8"	3/8"
18-500-1238	—	1/2"	3/8"
18-500-1212	—	1/2"	1/2"
18-500-5838	18-8041	5/8"	3/8"
STD. PKG. 100	STD. CTN. 12 (1 PER CARD)		

SOLID BRASS FERRULES



Code No.	Hose Type	Die Set
18-700-5500	16-368-0140	18-J662-550
18-700-6250	16-368-0560	18-J662-625
18-700-6500		
18-700-6750	16-368-0140	18-J662-675
18-700-7000	16-368-0380	18-J662-700
18-700-7250	16-368-0560	18-J662-725
18-700-7500		
18-700-7750	16-365-0380	18-J662-775
18-700-8000	16-368-0380	18-J662-775
18-700-8250	16-368-0120	18-J662-825
18-700-8500		
18-700-9000		
18-700-9000A		
18-700-9250	16-368-0120	18-J662-900
18-700-9500		
18-700-1025	16-369-0580	18-J662-1025

FUEL WATER SEPARATORS



Compact

30 GPH for up to 115 HP motors
(Use with N-187774S head.)



Standard



Extra Capacity



Drain Bowl

AquaVue™ drain bowl style filters with see through plastic bowl or fire resistant metal bowl for below deck installation.

Part #	Description	Rating
18-7928-1	Filter w/ AquaVue™ bowl	10 Micron
18-7929	Filter w/ Metal bowl	10 Micron
18-7866	Extra Capacity - 6"	10 Micron
18-7944	Short - 3.88"	10 Micron
18-7945	Long - 4.35"	10 Micron
18-7844	Short - 3.88"	21 Micron
18-7845	Long - 4.35"	21 Micron
18-7865	Compact Filter	10 Micron

Available in standard packs of 12.

FEATURES

Ethanol blended fuel absorbs more water and loosens more particulates than regular fuels. Proper filtration is required for every horsepower engine. Sierra fuel water separators remove over 99.8% of emulsified water from your gasoline. Sierra's 10 micron filters are over 90% efficient at removing particles as small as 10 micron. All filters flow at 90 GPH to feed even the hungriest motor. Sierra 10 micron filters are recommended to prevent damage to sensitive inboard and outboard fuel injection systems.

PRIMER BULBS

Sierra is a leading supplier of primer bulbs to the marine aftermarket. Our bulbs are molded in house. We use double check valves with viton balls and stainless steel springs.



Part #	Description
18-8002EP-1	Primer bulb for 1/4" hose
18-8004EP-1	Primer bulb for 5/16" hose
18-8005EP-1	Primer bulb for 3/8" hose

CUSTOM FUEL LINE ASSEMBLIES

- Sierra can fabricate custom assemblies for OEM applications.
- Any combination of hose and fittings is possible.
- Use type A hose to the splash well and type B hose to the engine.
- Customizable length.
- Inlet can be 3/8" with 5/16" outlet.
- Numerous OEM connectors available.



BRACKETS

Sierra brackets are precision machined powder coated aluminum or marine grade stainless steel. They are available with 3/8" or 1/4" inlets.



Part # Boxed	Description	Bulk Standard Pack
18-7776	3/8" Thread Stainless Steel	14
18-7777	1/4" Thread Stainless Steel	14
18-7775	3/8" Thread Aluminum	48
18-7853-1	1/4" Thread Aluminum	48
18-7774	1/4" Thread Aluminum (Compact)	60
18-4264	3/8" Pipe Plugs	—
18-4256	1/4" Pipe Plugs	—

SHIELDS SANITATION HOSE

Shields Sanitation Hose is kink resistant and flexible. It has an EPDM tube and cover, it is wire reinforced and has two fabric plies. This sanitation hose is resistant to toilet chemicals, odor permeation, ozone, salt water and heat. This hose is primarily used for toilet to holding tank, holding tank pump out, and maximum resistance to odor permeation.

Bend Radius = 5 x I.D.



I.D.	mm	O.D.	Ply	Burst Pressure	Wt. "C"	Bulk Pack 50' (15.2m) Coil Code #	Dist. Pkg. 12 1/2' (3.8m) Length Code #	25" (7.6mm) Coil Code #	10' (3.1m) Code #
1"	25	1 5/16"	2	200#	38	16-101-1000	16-101-1004	—	16-101-1003
1 1/2"	38	1 55/64"	2	150#	55	16-101-1120	16-101-1124	16-101-1125	16-101-1123

SHIELDS POLY X SANITATION HOSE



Shields Poly X Sanitation Hose has a lifetime warranty against odor permeation. This ultimate sanitation hose combines the flexibility of a rubber hose with the permeation resistance of polyurethane. Poly X can easily be slipped over most fittings and the polyurethane cover is extremely abrasion resistant. This hose has a glossy cover for easy clean up. This hose is primarily used for head to holding tank and holding tank pump out.

The tube is made of smooth, white NBR and is chemical and detergent resistant. The cover is comprised of smooth polyurethane and has a glossy cover. It is heat, weather, ozone and abrasion resistant. Bend Radius = 5 x I.D.

I.D.	mm	O.D.	mm	Ply	Vac Rating	Wt "C"	50' (15.2m) Code #	12 1/2' (3.8m) Code #	10' (3.1m) Code #
3/4"	19	1 7/16"	36.5	2	28	38	16-105-0340	16-105-0344	16-105-0343
1"	25	1 21/64"	33.7	2	28	46	16-105-1000	16-105-1004	16-105-1003
1 1/2"	38	1 27/32"	46.8	2	28	66	16-105-1120	16-105-1124	16-105-1123

SHIELDS SANITATION HOSE FITTINGS

Fiberglass reinforced nylon fittings designed to fit Series 101, Series 105 and Series 144 and 148 hoses without heating or special tools. For use in sanitation systems, deck drain systems and water tank fill. Fittings are durable, chemical and fuel resistant, will not rust or cause electrolysis.

Style	Bulk Code #	Blister Pack Code #	Hose I.D.	mm	Thread
Straight Male	N800-0340	—	3/4"	19.1	3/4" MP
Straight Male	N800-1000	—	1"	25.4	1" MP
Straight Male	N800-1180	—	1 1/2"	28.6	1" MP
Straight Male	N800-1140	—	1 1/4"	31.8	1 1/4" MP
Straight Male	N800-1120B	18-800-1120	1 1/4"	38.1	1 1/2" MP
Straight Female	N801-1120	18-801-1120	1 1/2"	38.1	1 1/2" FP
90 Degree Male	N802-1120	18-802-1120	1 1/2"	38.1	1 1/2" MP
90 Degree Female	N803-1120	18-803-1120	1 1/2"	38.1	1 1/2" FP
Hose Tee	N806-1120	18-806-1120	1 1/2"	38.1	N/A



SHIELDS SUPER PVC SANITATION HOSE

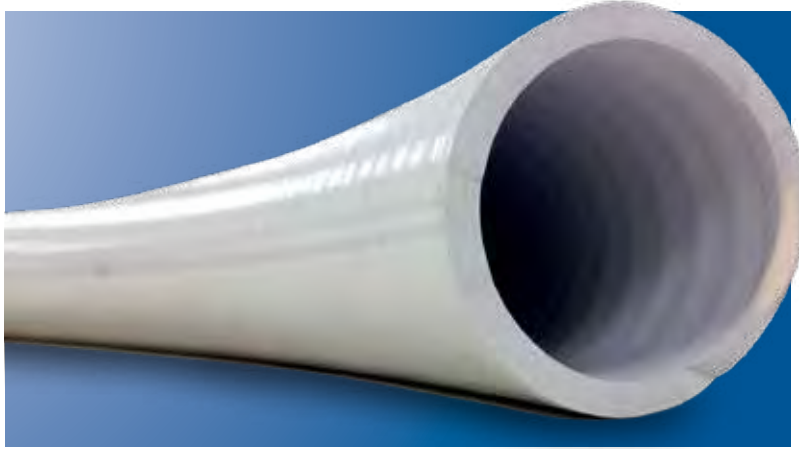

Shields Super PVC Sanitation Hose is smooth off white PVC with a vinyl helix. It contains an anti-fungus /bacterial agent to inhibit odor causing growth. It is resistant to mild chemicals, saltwater, and permeation. This hose is primarily used for toilet to holding tank (self draining lines) and holding tank pump out. It has a five year limited warranty.

Do not use ethylene glycol based anti-freeze in hose. CAUTION - Do not use for potable water.

I.D.	mm	Bend Radius	mm	Vac Rating	Wt. "C"	Bulk Pack 100' (30.5m) Coil Code #	Dist. Pkg. 50' (15.2m) R/O Ctn. Code #
1"	25.4	3	76.2	28	27	16-144-1000	16-144-1006①
1 1/2"	38.1	5	127.3	28	40	16-144-1120	16-144-1126①

① **WARNING:** Lines containing raw sewage should be plumbed to be self-draining.

SHIELDS VAC EXTRA HEAVY DUTY - INDUSTRIAL GRADE



Shields Vac Extra Heavy Duty/Commercial Grade Hose has a smooth cover and clear FDA formula PVC with a white vinyl helix. It is rated for full vacuum and is resistant to mild chemicals and saltwater. This hose is primarily used for bilge pump intake and discharge, potable water tank fill, drains (sinks, shower, and scupper), livewell intake and drain, and sanitation (intake, vent and pump out). This hose is utilized for below the waterline connections. **Do not use ethylene glycol based antifreeze in hose. Do not use in pressurized water systems.**

I.D.	mm	Bend Radius	mm	Vac Rating	Wt. "C"	Bulk Pack 100' (30.5m) Coil Code #	50' (15.2m) R/O Ctn. Code #	Dist. Pkg. 10' (3.1m) Length Code #
5/8"	15.9	3	76.2	28	15	16-146-0580	16-146-0586	—
3/4"	19.1	3	76.2	28	16	16-146-0340	16-146-0346	—
1"	25.4	3	76.2	28	27	16-146-1000	16-146-1006	—
1 1/8"	28.6	4	101.6	28	25	16-146-1180	16-146-1186	—
1 1/4"	31.8	3	76.2	28	30	16-146-1140	16-146-1146	—
1 1/2"	38.1	4	101.6	28	40	16-146-1120	16-146-1126	—
2"	50.8	5	127.0	28	57	16-146-2000	—	16-146-2003
2 1/2"	63.5	7	177.8	28	74	16-146-2120	—	16-146-2123
3"	76.2	9	228.6	28	94	16-146-3000	—	16-146-3003

SHIELDS VAC EXTRA HEAVY DUTY/FDA

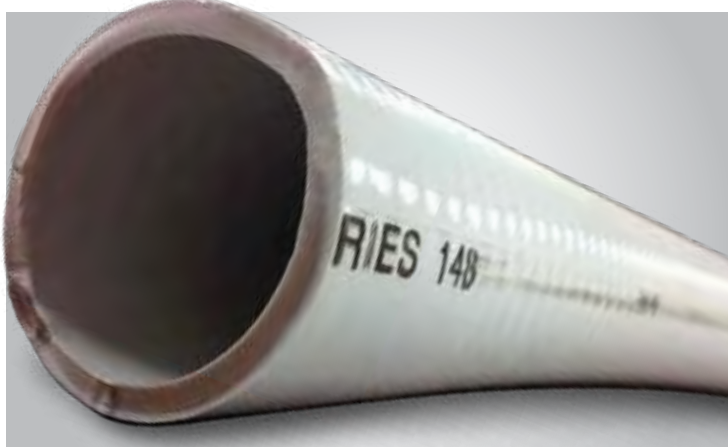

Shields Vac Extra Heavy Duty/FDA Hose has a smooth white FDA grade PVC with vinyl helix. It is rated for full vacuum and is resistant to mild chemicals, permeation, and saltwater. This hose is primarily used for bilge pump intake and discharge, drains (sinks, shower, and scupper), livewell intake and drain, potable water tank fill, and sanitation (toilet to holding tank, intake, self draining lines vent and pump out). This hose is resistant to odor permeation. **Do not use ethylene glycol based antifreeze in hose. Do not use in pressurized water systems.**

I.D.	mm	Bend Radius	mm	Vac Rating	Wt. "C"	Bulk Pack 100' (30.5m) Coil Code #	Dist. Pkg. 50' (15.2m) R/O Ctn. Code #	25' (7.6m) R/O Ctn. Code #
5/8"	15.9	3	76.2	28	15	16-148-0580W	16-148-0586W	—
3/4"	19.1	3	76.2	28	20	16-148-0340W	16-148-0346W	—
1"	25.4	3	76.2	28	27	16-148-1000W	16-148-1006W ①	—
1 1/8"	28.6	4	101.6	28	29	16-148-1180W	16-148-1186W	—
1 1/4"	31.8	4	101.6	28	31	16-148-1140W	16-148-1146W	—
1 1/2"	38.1	5	127.0	28	40	16-148-1120W	16-148-1126W ①	16-148-1125W

① **WARNING:** Lines containing raw sewage should be plumbed to be self-draining.

SHIELDS SANITATION SYSTEM CLEANER

Shields Sanitation Hose Cleaner is a USDA certified bio-based product safe for all sanitation system components. This powerful cleaner removes uric scale, calcium carbonate and other solids to help keep sanitation systems working at their best. Available in concentrate and ready to use.



Part No.	Size	Description
18-9093	1 Gallon	Ready to Use
18-9095	1 Gallon	Concentrate



SHIELDSFLEX II MARINE WATER/EXHAUST HOSE (w/ Wire)

Shieldsflex II Marine Water/Exhaust Hose has a black synthetic rubber tube and cover. It is reinforced with wire helix imbedded between plies of HD synthetic cord. It is resistant to exhaust fumes, ozone, mild chemicals, antifreeze and saltwater. This hose is abrasion and odor permeation resistant. It now has double the ozone resistance required by the SAEJ2006. Shieldsflex II is primarily used for engine intake, wet exhaust connections (use where bends or long lengths are required), bilge pump intake/discharge, scupper lines, toilet intake/discharge, and holding tank vent/pump out. The temperature ranges from -20° F – +200°F continuous, +250°F intermittent. The hose meets SAE J2006 Type R2 standards.



I.D.	mm	O.D.	Ply	Wt. "C"	50' (15.2m) Coil Code #	25' (7.6m) Cartons	12 1/2' (3.8m) Length Code #	6 1/4' (1.9m) Length Code #	10' (3.1m) Length Code #
1/2"	13	27/32"	2	24	-0120	16-250-0125	16-250-0124	16-250-0121	16-250-0123
5/8"	16	61/64"	2	28	16-250-0580	16-250-0585	16-250-0584	16-250-0581	16-250-0583
3/4"	19	1 1/16"	2	32	16-250-0340	16-250-0345	16-250-0344	16-250-0341	16-250-0343
7/8"	22	1 3/16"	2	36	16-250-0780	16-250-0785	16-250-0784	16-250-0781	16-250-0783
1"	25	1 5/16"	2	40	16-250-1000	16-250-1005	16-250-1004	16-250-1001	16-250-1003
1 1/8"	28	1 7/16"	2	44	16-250-1180	16-250-1185	16-250-1184	16-250-1181	16-250-1183
1 1/4"	32	1 19/32"	2	50	16-250-1140	16-250-1145	16-250-1144	16-250-1141	16-250-1143
1 5/16"	33	1 5/8"	2	51	16-250-1560	—	16-250-1564	16-250-1561	16-250-1563
1 3/8"	35	1 23/32"	2	58	16-250-1380	16-250-1385	16-250-1384	16-250-1381	16-250-1383
1 1/2"	38	1 53/64"	2	62	16-250-1120	16-250-1125	16-250-1124	16-250-1121	16-250-1123
1 5/8"	42	2"	2	80	16-250-1580	—	16-250-1584	16-250-1581	16-250-1583
1 3/4"	45	2 1/8"	2	88	16-250-1340	—	16-250-1344	16-250-1341	16-250-1343
1 7/8"	48	2 19/64"	2	93	16-250-1780	—	16-250-1784	16-250-1781	16-250-1783
2"	51	2 13/32"	2	99	16-250-2000	—	16-250-2004	16-250-2001	16-250-2003
2 1/8"	54	2 17/32"	2	107	16-250-2180	—	16-250-2184	16-250-2181	16-250-2183
2 1/4"	58	2 11/16"	2	127	16-250-2140	—	16-250-2144	16-250-2141	16-250-2143
2 3/8"	60	2 3/4"	2	132	16-250-2380	—	16-250-2384	16-250-2381	16-250-2383
2 1/2"	63	2 7/8"	2	137	16-250-2120	—	16-250-2124	16-250-2121	16-250-2123
2 5/8"	67	3 1/16"	2	147	—	—	16-250-2584	16-250-2581	—
2 3/4"	70	3 3/16"	2	164	16-250-2340	—	16-250-2344	16-250-2341	16-250-2343
2 7/8"	73	3 5/16"	2	170	16-250-2780	—	16-250-2784	16-250-2781	16-250-2783
3"	76	3 7/16"	2	177	16-250-3000	—	16-250-3004	16-250-3001	16-250-3003
3 1/8"	80	3 5/8"	2	200	16-250-3180	—	16-250-3184	16-250-3181	16-250-3183
3 1/2"	90	4"	2	223	16-250-3120	—	16-250-3124	16-250-3121	16-250-3123
4"	102	4 5/8"	2	269	16-250-4000	—	16-250-4004	16-250-4001	16-250-4003
4 1/8"	105	4 47/64"	2	276	—	—	—	—	—
4 1/2"	114	5 3/32"	2	319	16-250-4120	—	16-250-4124	16-250-4121	—
5"	127	5 5/8"	2	398	16-250-5000	—	16-250-5004	16-250-5001	16-250-5003
5 1/8"	130	5 3/4"	2	417	—	—	—	—	—
5 1/2"	140	6 3/16"	2	443	—	—	—	—	—
6"	152	6 21/32"	2	482	—	—	16-250-6004	16-250-6001	—
8"	203	8 25/32"	2	780	—	—	16-250-8004	—	—



Now double the ozone resistance required by SAEJ2006



This certification provides unbiased, third party confirmation worldwide that these Shields hoses meet the highest standards of production quality. Certification ensures the proper level of product safety and inspires user confidence.

SHIELDS 400/402 VINYLVENT



Shields Vinylvent Ducting Hose is PVC supported by anodized wire helix. It is resistant to UV and the ozone. This hose is primarily used for venting of bilge fumes.

I.D.	mm	O.D.	mm	Wt/ "C"	Bulk Pack 50' (76.2m) Length Code # White	Dist. Pkg. 10' (3.1m) Polypac Code # White
3"	76.2	3 1/8"	79.4	8	16-400-3000W	16-400-3003-1
4"	101.6	4 1/8"	104.8	10	16-400-4000W	16-400-4003-1
3"	76.2	3 1/8"	79.4	8	16-402-3000	16-402-3003-1
4"	101.6	4 1/8"	104.8	10	16-402-4000	16-402-4003-1

SHIELDS EXTRA HEAVY DUTY VINYLVENT



Shields Extra Heavy Duty Vinylvent has an extra heavy PVC wall. It is supported by vinyl coated helical wire and is resistant to ozone, UV, and corrosion. It is flame resistant and meets the UL 94V standard. This hose is primarily used for venting of bilge fumes.



I.D.	mm	O.D.	mm	Wt. "C"	Code No.
3"	76	3 1/8"	79.4	17	16-420-3000
4"	102	4 1/8"	104.8	25	16-420-4000

Bulk Pack: 3" 6 x 50 4" 4 x 50

SHIELDS FIBERVENT



Shields Fibervent is vinyl coated, woven fiberglass hose. It is supported by vinyl coated helical wire and is resistant to ozone, UV, and corrosion. The hose is flame resistant and meets the UL 181 Class 1 standard. This hose is primarily used for venting of bilge fumes and A/C ducting hose. The temperature ranges from -20° F to +250° F.



Bulk	m	I.D.	mm	O.D.	mm	Rating	Vac Wt. "C"	Code No.
6 x 25'	1.8x7.6	3"	76.2	3 1/4"	82.6	20	13	16-450-3000
8 x 25'	2.4x7.6	4"	101.6	4 1/4"	108	20	15	16-450-4000
8 x 25'	2.4x7.6	5"	127	5 1/4"	133.4	20	17	16-450-5000
4 x 25'	1.2x7.6	6"	152.4	6 1/4"	158.8	20	19	16-450-6000

SHIELDS AIR CONDITIONER DUCTING HOSE



Shields Air Conditioner Ducting Hose has a smooth tube for maximum airflow. This is a vinyl coated, woven fiberglass hose and is supported by vinyl coated helical wire. It is resistant to ozone, UV, and corrosion. The hose is flame resistant and meets the UL 94-V-0 standard. This hose is primarily used for venting of bilge fumes and A/C ducting hose. The temperature ranges from -20° – +200°F



Bulk	m	I.D.	mm	O.D.	mm	Wt. "C"	Code No.
5 x 25'	1.5x7.6	3"	76	3 1/4"	82.5	22	—
6 x 25'	1.8x7.6	4"	102	4 1/4"	108	24	16-460-4000
5 x 25'	1.5x7.6	5"	127	5 1/4"	133.4	32	16-460-5000
4 x 25'	1.2x7.6	6"	152	6 1/4"	158.8	36	—
2 x 25'	.6x7.6	7"	178	7 1/4"	184.2	44	16-460-7000

SHIELDS MARINE EXHAUST/WATER HOSE (No Wire)



Shields Marine Exhaust / Water Hose is reinforced with 2 or 4 plies of synthetic cord and is made of black, heavy-walled synthetic rubber. This hose is primarily used for straight connections in wet exhaust systems and engine water circulation lines. It is resistant to engine heat, exhaust fumes, ozone, mild chemicals, antifreeze and saltwater. This hose also has double the ozone resistance required by SAEJ2006. The temperature ranges from -20°F – + 200°F continuous, +250°F intermittent. The hose meets SAE J2006 Type R1 standards.



This certification provides unbiased, third party confirmation worldwide that these Shields hoses meet the highest standards of production quality. Certification ensures the proper level of product safety and inspires user confidence.

Now double the ozone resistance required by SAEJ2006

I.D.	mm	O.D.	Ply	Wt. "C"	50' Coil Code #	12 1/2' Length Code #	6 1/4' Length Code #	10' Length Code #
1/2"	13	7/8"	2	24	16-200-0120	16-200-0124	16-200-0121	16-200-0123
5/8"	16	1 1/32"	2	33	16-200-0580	16-200-0584	16-200-0581	16-200-0583
3/4"	19	1 9/64"	2	37	16-200-0340	16-200-0344	16-200-0341	16-200-0343
7/8"	22	1 17/64"	2	42	16-200-0780	16-200-0784	16-200-0781	16-200-0783
1"	25	1 3/8"	2	48	16-200-1000	16-200-1004	16-200-1001	16-200-1003
1 1/8"	28	1 1/2"	2	52	16-200-1180	16-200-1184	16-200-1181	—
1 1/4"	32	1 45/64"	2	60	16-200-1140	16-200-1144	16-200-1141	—
1 5/16"	33	1 47/64"	2	62	—	—	—	—
1 3/8"	35	1 13/16"	2	66	16-200-1380	16-200-1384	16-200-1381	—
1 1/2"	38	1 15/16"	2	70	16-200-1120	16-200-1124	16-200-1121	16-200-1123
1 5/8"	42	2 3/32"	2	77	16-200-1580	16-200-1584	16-200-1581	—
1 3/4"	45	2 13/64"	2	82	16-200-1340	16-200-1344	16-200-1341	16-200-1343
1 7/8"	48	2 23/64"	2	96	16-200-1780	16-200-1784	16-200-1781	—
2"	51	2 31/64"	2	102	16-200-2000	16-200-2004	16-200-2001	16-200-2003
2 1/8"	54	2 19/32"	2	107	16-200-2180	16-200-2184	16-200-2181	—
2 1/4"	58	2 3/4"	2	114	16-200-2140	16-200-2144	16-200-2141	—
2 3/8"	60	2 7/8"	2	132	16-200-2380	16-200-2384	—	16-200-2383
2 1/2"	63	3"	2	136	16-200-2120	16-200-2124	16-200-2121	16-200-2123
2 5/8"	67	3 3/32"	2	147	—	16-200-2584	16-200-2581	—
2 3/4"	70	3 17/64"	2	152	—	16-200-2344	16-200-2341	—
2 7/8"	73	3 1/16"	2	174	—	16-200-2784	16-200-2781	—
3"	76	3 9/16"	2	182	16-200-3000	16-200-3004	16-200-3001	16-200-3003
3 1/8"	80	3 45/64"	2	190	—	16-200-3184	16-200-3181	—
3 1/2"	90	4 3/32"	2	198	—	16-200-3124	16-200-3121	16-200-3123
3 3/4"	95	4 9/32"	2	221	—	16-200-3344	16-200-3341	—
4"	102	4 17/32"	4	229	—	16-200-4004	16-200-4001	16-200-4003
4 1/2"	114	5 1/8"	2	300	—	16-200-4124	16-200-4121	—
5"	127	5 5/8"	2	332	—	16-200-5004	16-200-5001	16-200-5003
5 1/2"	140	6 3/16"	2	396	—	—	—	—
6"	152	6 11/16"	2	427	—	16-200-6004	16-200-6001	16-200-6003
8"	203	8 25/32"	4	670	—	16-200-8004	—	16-200-8003
10"	254	10 7/8"	4	934	—	16-200-10004	16-200-10001	—
12"	305	12 7/8"	4	1095	—	16-200-12004	16-200-12001	—
14"	350	14 7/8"	4	1430	—	—	—	—

* Special Order

SHIELDS NAUTIFLEX SILICONE EXHAUST HOSE



Shields Nautiflex Silicone Exhaust Hose has a blue silicone cover with a smooth finish for easy clean up. This hose is flexible, easy to install and has four plies of synthetic fabric. It also remains stable at elevated temperatures. This hose is primarily used for straight connections in the wet exhaust system and engine water circulation lines. The temperature ranges from -20°F – $+350^{\circ}\text{F}$. The hose meets SAE J2006 Type R1 and ISO 13363:2004 – Type 2 – Class B standards.

I.D.	mm	O.D.	Wt. "C"	3' (.9m) Length Code No.	6' (1.8m) Length Code No.	12' (3.7m) Length Code No.
1"	25	1 $\frac{3}{8}$ "	33.1	16-202-1000-36	16-202-1001	16-202-1004
1 $\frac{1}{8}$ "	28	1 $\frac{1}{2}$ "	37.2	—	—	—
1 $\frac{1}{4}$ "	32	1 $\frac{5}{8}$ "	41.3	16-202-1140-36	16-202-1141	16-202-1144
1 $\frac{3}{8}$ "	35	1 $\frac{3}{4}$ "	45.4	—	—	—
1 $\frac{1}{2}$ "	38	1 $\frac{7}{8}$ "	49.6	16-202-1120-36	16-202-1121	16-202-1124
1 $\frac{3}{4}$ "	45	2 $\frac{1}{8}$ "	57.8	—	—	—
2"	51	2 $\frac{3}{8}$ "	66.1	16-202-2000-36	16-202-2001	16-202-2004
2 $\frac{3}{8}$ "	60	2 $\frac{3}{4}$ "	78.5	16-202-2380-36	16-202-2381	16-202-2384
2 $\frac{1}{2}$ "	63	2 $\frac{7}{8}$ "	82.6	16-202-2120-36	16-202-2121	16-202-2124
2 $\frac{5}{8}$ "	67	2 $\frac{63}{64}$ "	86.8	16-202-2580-36	16-202-2581	16-202-2584
2 $\frac{3}{4}$ "	70	3 $\frac{1}{8}$ "	90.9	—	—	—
2 $\frac{7}{8}$ "	73	3 $\frac{1}{4}$ "	94.1	—	—	—
3"	76	3 $\frac{3}{8}$ "	99.2	16-202-3000-36	16-202-3001	16-202-3004
3 $\frac{1}{4}$ "	82	3 $\frac{1}{2}$ "	103.4	16-202-3140-36	16-202-3141	16-202-3144
3 $\frac{1}{2}$ "	90	3 $\frac{7}{8}$ "	115.7	16-202-3120-36	16-202-3121	16-202-3124
4"	102	4 $\frac{3}{8}$ "	132	16-202-4000-36	16-202-4001	16-202-4004
5"	127	5 $\frac{3}{8}$ "	165	16-202-5000-36	16-202-5001	16-202-5004
5 $\frac{1}{2}$ "	140	5 $\frac{7}{8}$ "	181.5	—	—	—
6"	152	6 $\frac{3}{8}$ "	198	16-202-6000-36	16-202-6001	16-202-6004
8"	203	8 $\frac{3}{8}$ "	264	16-202-8000-36	16-202-8001	16-202-8004
10"	254	10 $\frac{3}{8}$ "	330	16-202-1000036	16-202-10001	16-202-10004
12"	305	12 $\frac{3}{8}$ "	396	16-202-1200036	16-202-12001	16-202-12004
14"	350	14 $\frac{5}{8}$ "	462	16-202-1400036	—	—



SHIELDSFLEX II MARINE WATER/EXHAUST HOSE (w/ Wire)

Shieldsflex II Marine Water/Exhaust Hose has a black synthetic rubber tube and cover. It is reinforced with wire helix imbedded between plies of HD synthetic cord. It is resistant to exhaust fumes, ozone, mild chemicals, antifreeze and saltwater. This hose is abrasion and odor permeation resistant. It now has double the ozone resistance required by the SAEJ2006. Shieldsflex II is primarily used for engine intake, wet exhaust connections (use where bends or long lengths are required), bilge pump intake/discharge, scupper lines, toilet intake/discharge, and holding tank vent/pump out. The temperature ranges from -20° F – +200°F continuous, +250°F intermittent. The hose meets SAE J2006 Type R2 standards.



I.D.	mm	O.D.	Ply	Wt. "C"	50' (15.2m) Coil Code #	25' (7.6m) Cartons	12 1/2' (3.8m) Length Code #	6 1/4' (1.9m) Length Code #	10' (3.1m) Length Code #
1/2"	13	27/32"	2	24	16-250-0120	16-250-0125	16-250-0124	16-250-0121	16-250-0123
5/8"	16	61/64"	2	28	16-250-0580	16-250-0585	16-250-0584	16-250-0581	16-250-0583
3/4"	19	1 1/16"	2	32	16-250-0340	16-250-0345	16-250-0344	16-250-0341	16-250-0343
7/8"	22	1 3/16"	2	36	16-250-0780	16-250-0785	16-250-0784	16-250-0781	16-250-0783
1"	25	1 5/16"	2	40	16-250-1000	16-250-1005	16-250-1004	16-250-1001	16-250-1003
1 1/8"	28	1 7/16"	2	44	16-250-1180	16-250-1185	16-250-1184	16-250-1181	16-250-1183
1 1/4"	32	1 19/32"	2	50	16-250-1140	16-250-1145	16-250-1144	16-250-1141	16-250-1143
1 5/16"	33	1 5/8"	2	51	16-250-1560	—	16-250-1564	16-250-1561	16-250-1563
1 3/8"	35	1 23/32"	2	58	16-250-1380	16-250-1385	16-250-1384	16-250-1381	16-250-1383
1 1/2"	38	1 53/64"	2	62	16-250-1120	16-250-1125	16-250-1124	16-250-1121	16-250-1123
1 5/8"	42	2"	2	80	16-250-1580	—	16-250-1584	16-250-1581	16-250-1583
1 3/4"	45	2 1/8"	2	88	16-250-1340	—	16-250-1344	16-250-1341	16-250-1343
1 7/8"	48	2 19/64"	2	93	16-250-1780	—	16-250-1784	16-250-1781	16-250-1783
2"	51	2 13/32"	2	99	16-250-2000	—	16-250-2004	16-250-2001	16-250-2003
2 1/8"	54	2 17/32"	2	107	16-250-2180	—	16-250-2184	16-250-2181	16-250-2183
2 1/4"	58	2 11/16"	2	127	16-250-2140	—	16-250-2144	16-250-2141	16-250-2143
2 3/8"	60	2 3/4"	2	132	16-250-2380	—	16-250-2384	16-250-2381	16-250-2383
2 1/2"	63	2 7/8"	2	137	16-250-2120	—	16-250-2124	16-250-2121	16-250-2123
2 5/8"	67	3 1/16"	2	147	—	—	16-250-2584	16-250-2581	—
2 3/4"	70	3 3/16"	2	164	16-250-2340	—	16-250-2344	16-250-2341	16-250-2343
2 7/8"	73	3 5/16"	2	170	16-250-2780	—	16-250-2784	16-250-2781	16-250-2783
3"	76	3 7/16"	2	177	16-250-3000	—	16-250-3004	16-250-3001	16-250-3003
3 1/8"	80	3 5/8"	2	200	16-250-3180	—	16-250-3184	16-250-3181	16-250-3183
3 1/2"	90	4"	2	223	16-250-3120	—	16-250-3124	16-250-3121	16-250-3123
4"	102	4 5/8"	2	269	16-250-4000	—	16-250-4004	16-250-4001	16-250-4003
4 1/8"	105	4 47/64"	2	276	—	—	—	—	—
4 1/2"	114	5 3/32"	2	319	16-250-4120	—	16-250-4124	16-250-4121	—
5"	127	5 5/8"	2	398	16-250-5000	—	16-250-5004	16-250-5001	16-250-5003
5 1/8"	130	5 3/4"	2	417	—	—	—	—	—
5 1/2"	140	6 3/16"	2	443	—	—	—	—	—
6"	152	6 21/32"	2	482	—	—	16-250-6004	16-250-6001	—
8"	203	8 25/32"	2	780	—	—	16-250-8004	—	—



Now double the ozone resistance required by SAEJ2006



This certification provides unbiased, third party confirmation worldwide that these Shields hoses meet the highest standards of production quality. Certification ensures the proper level of product safety and inspires user confidence.

SHIELDSAUST-C

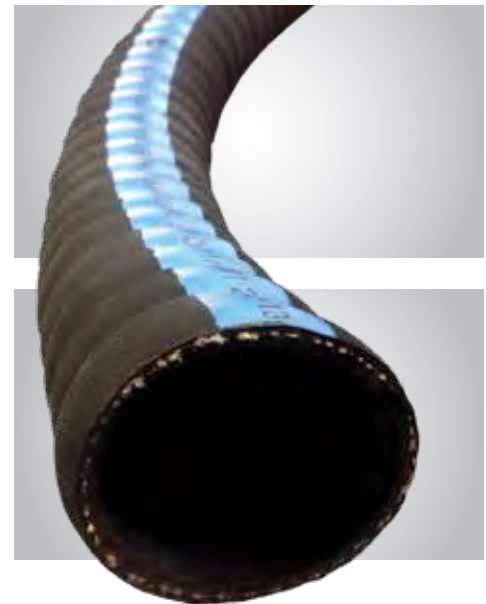
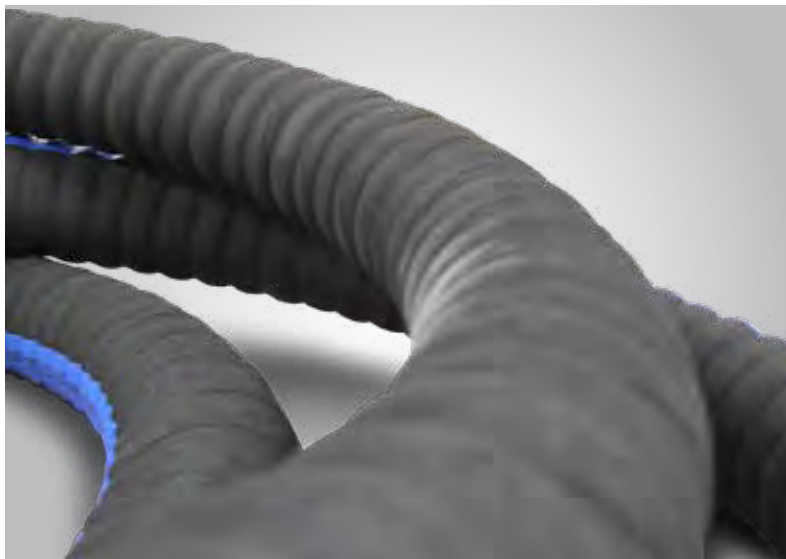

Now double the ozone resistance required by SAEJ2006

Shieldsaust – C Hose has a black synthetic rubber tube and cover. It is reinforced with double wire helix imbedded between plies of synthetic cord and is abrasion resistant. It is resistant to exhaust fumes, ozone, mild chemicals, antifreeze, and saltwater. This hose is primarily used for wet exhaust connections with significant bends, engine intake and scupper lines. The temperature ranges from -20°F to +200°F continuous, +250°F intermittent. The hose now has double the ozone resistance required by SAEJ2006. This hose meets SAE J2006 Type R2 standards.

I.D.	mm	O.D.	Ply	Wt. "C"	50' (15.2m) Coil Code #	12 1/2' (3.8m) Length Code #	6 1/4' (1.9m) Length Code #	10' (3.1m) Length Code #
3/4"	19	1 1/8"	2	27	16-252-0340	16-252-0344	16-252-0341	16-252-0343
1"	25	1 11/32"	2	33	16-252-1000	16-252-1004	16-252-1001	16-252-1003
1 1/4"	32	1 39/64"	2	45	16-252-1140	16-252-1144	16-252-1141	16-252-1143
1 1/2"	38	1 15/16"	2	70	16-252-1120	16-252-1124	16-252-1121	16-252-1123
1 5/8"	42	2 3/32"	2	80	16-252-1580	16-252-1584	16-252-1581	16-252-1583
1 3/4"	45	2 7/32"	2	85	16-252-1340	16-252-1344	16-252-1341	16-252-1343
1 7/8"	48	2 21/64"	2	91	16-252-1780	16-252-1784	16-252-1781	16-252-1783
2"	51	2 7/16"	2	95	16-252-2000	16-252-2004	16-252-2001	16-252-2003
2 1/8"	54	2 9/16"	2	100	—	16-252-2184	—	—
2 1/4"	58	2 23/32"	2	107	—	16-252-2144	16-252-2141	—
2 3/8"	60	2 51/64"	2	110	16-252-2380	16-252-2384	16-252-2381	16-252-2383
2 1/2"	63	2 59/64"	2	115	16-252-2120	16-252-2124	16-252-2121	16-252-2123
2 3/4"	70	3 3/16"	2	126	—	16-252-2344	16-252-2341	—
2 7/8"	73	3 5/16"	2	137	16-252-2780	16-252-2784	16-252-2781	16-252-2783
3"	76	3 7/16"	2	143	16-252-3000	16-252-3004	16-252-3001	16-252-3003
3 1/8"	80	3 19/32"	2	150	16-252-3180	16-252-3184	16-252-3181	16-252-3183
3 1/2"	90	4 1/16"	2	200	16-252-3120	16-252-3124	16-252-3121	16-252-3123
4"	102	4 9/16"	2	231	16-252-4000	16-252-4004	16-252-4001	16-252-4003
4 1/8"	105	4 11/16"	2	238	—	16-252-4184	16-252-4181	—
4 1/2"	114	5 1/8"	2	278	—	16-252-4124	16-252-4121	—
5"	127	5 9/16"	2	300	—	16-252-5004	16-252-5001	—
6"	152	6 9/16"	2	394	16-252-6000	16-252-6004	16-252-6001	16-252-6003
8"	203	8 11/16"	2	607	—	16-252-8004	16-252-8001	—



This certification provides unbiased, third party confirmation worldwide that these Shields hoses meet the highest standards of production quality. Certification ensures the proper level of product safety and inspires user confidence.

SHIELDS NAUTIFLEX CORRUGATED SILICONE EXHAUST HOSE



Shields Nautiflex Corrugated Silicone

Exhaust Hose has a blue silicone tube and cover with a smooth finish for easy cleaning. The hose is wire reinforced and will not collapse under suction or in a bend. The corrugated cover allows the hose to bend for easy installation. The Nautiflex, two ply construction, has wire captured between fabric plies. This hose is primarily used for main engine exhaust, generator exhaust, engine coolant circulation, engine intake and generator intake. It is resistant to exhaust fumes, ozone, mild chemicals, antifreeze and saltwater. The hose remains stable at elevated temperatures. The temperatures ranges from -20°F – +350°F. This hose meets SAEJ2006 Type R2 and ISO 13362:2004 – Type 1 – Class B standards.

ID	mm	OD	WT "C"	10' (3.1m) length Code No.	12 1/2' (3.8m) Length Code No.	50' (15.2m) coil Code No.	6 1/4' (3.8m) Length Code No.
3/4"	19	1 3/8"	34	—	16-262-0344	16-262-0340	—
1"	25	1 27/64"	42	16-262-1003	16-262-1004	16-262-1000	—
1 1/8"	28	1 1/2"	46	16-262-1183	16-262-1184	16-262-1180	—
1 1/4"	32	1 45/64"	52	16-262-1143	16-262-1144	16-262-1140	—
1 3/8"	35	1 55/64"	60	16-262-1383	16-262-1384	16-262-1380	—
1 1/2"	38	2"	71	16-262-1123	16-262-1124	16-262-1120	—
1 5/8"	42	2 11/64"	74	16-262-1583	16-262-1584	16-262-1580	—
1 3/4"	45	2 19/64"	78	16-262-1343	16-262-1344	16-262-1340	—
1 7/8"	48	2 13/32"	82	16-262-1783	16-262-1784	16-262-1780	—
2"	51	2 17/32"	87	16-262-2003	16-262-2004	16-262-2000	—
2 1/8"	54	2 5/8"	94	—	—	—	—
2 3/8"	60	2 7/8"	101	16-262-2383	16-262-2384	16-262-2380	—
2 1/2"	63	3 3/64"	113	16-262-2123	16-262-2124	16-262-2120	—
2 3/4"	70	3.312"	125	16-262-2343	16-262-2344	16-262-2340	—
2 7/8"	73	3 7/16"	134	16-262-2783	16-262-2784	16-262-2780	—
3"	76	3 35/64"	139	16-262-3003	16-262-3004	16-262-3000	—
3 1/2"	90	4 19/64"	227	16-262-3123	16-262-3124	16-262-3120	—
4"	102	4 49/64"	255	16-262-4003	16-262-4004	16-262-4000	—
5"	127	5 3/4"	310	16-262-5003	—	16-262-5000	—
6"	152	6 15/16"	484	16-262-6003	—	—	16-262-6001
8"	203	9 7/64"	768	16-262-8003	—	—	—
10"	254	11 17/64"	1136	16-262-10003	—	—	—
12"	305	13.359"	1518	16-262-12003	—	—	—
14"	350	15.281"	1812	16-262-14003	—	—	—
16"	404	17.562"	2277	16-262-16003	—	—	—

* Special Order

SHIELDS COMPLEX - ALL IN ONE HOSE FOR INSPECTED VESSELS

Shields Complex is a versatile wire reinforced hose specially designed for inspected vessels. Complex is rated for fuel, vital water and non-vital water systems on boats requiring SAE J1942 hoses. Applications include bilge, coolant, oil and fuel systems using gasoline, gasohol, diesel, bio-diesel, wet exhaust systems, non-potable water systems, engine intake, toilet and holding tank connections.



Tube: Black Nitrile

Reinforcement: 2 textile plies w/ dual wire helix

Cover: Black Chlorprene

Temp. Range: -20F to +212F

Specifications - SAE J1942 Code F, VW, NVW;

SAE J1527 A1; SAE J2006 R2; SAE 20R2 B;

SAE J20R4 B; SAE 20R5 B, SAE 30R5,

ISO 7840 A1

Additional sizes available. 150' minimum order.

I.D.	mm	O.D.	PLY	Wt. "C"	Bend Radius	WP	50' Coil Code #	12 1/2' (3.8m) Length Code #	10' (3.1m) Length Code #	6 1/4' (3.8m) Length Code #
5/8"	15.9	1"	2	33	1.5	75	16-321-0580	16-321-0584	16-321-0583	16-321-0581
3/4"	19.1	1.19"	2	39	1.5	75	16-321-0340	16-321-0344	16-321-0343	16-321-0341
1"	25.4	1.41"	2	53	2	75	16-321-1000	16-321-1004	16-321-1003	16-321-1001
1 1/8"	28.6	1.56"	2	62	3	75	16-321-1180	16-321-1184	16-321-1183	16-321-1181
1 1/4"	31.8	1.66"	2	64	3	75	16-321-1140	16-321-1144	16-321-1143	16-321-1141
1 1/2"	38.1	1.91"	2	78	3	50	16-321-1120	16-321-1124	16-321-1123	16-321-1121
2"	50.8	2.48"	2	118	5	50	16-321-2000	16-321-2004	16-321-2003	16-321-2001

SHIELDS SILICONE COUPLERS

- SINGLE & DOUBLE HUMP W/ Reinforced Fabric



SINGLE HUMP

DOUBLE HUMP

Shields Single and Double Hump Couplers have a blue silicone cover with a smooth finish for easy clean up and are fabric reinforced. The couplers remain stable at elevated temperatures and provide angular and longitudinal vibration absorption in wet exhaust systems. Shields couplers correct slight offsets in pipes. They are resistant to exhaust fumes, ozone, mild chemicals, antifreeze and saltwater. The temperature range is -20°F to +350°F. It meets SAE J2006 Type R1 standards.

	I.D.	mm	Length	mm	Wt. Ea. (lbs)	Code No.
SINGLE	4"	102	6"	152	2	16-272-4000
	5"	127	6"	152	2	16-272-5000
	6"	152	8"	203	2	16-272-6000
	8"	203	8"	203	3	16-272-8000
	10"	254	12"	305	4	16-272-10000
DOUBLE	6"	152.4	14"	356	3	16-274-6000
	8"	203.2	14"	356	3	16-274-8000
	10"	254	14"	356	4	16-274-10000

SHIELDS SILICONE COUPLERS

- SINGLE HUMP

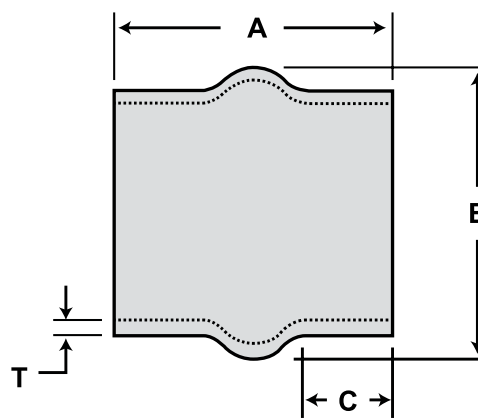

Hump Hose

Shields Silicone Single and Double Hump Couplers are very high temperature silicone exhaust connectors. The maximum operating temperature is 450°F (232°C). It meets SAE J2006 Type R1 standards.

Part Number	ID	mm	A	mm	B	mm	C	mm	T	mm
16-220S4000	4.0	101.6	5.25	133	5.50	140	2.00	51	.25	6
16-220S5000	5.0	127	6.00	152	6.50	165	2.25	57	.25	6
16-220S6000	6.0	152.4	7.00	178	7.50	190	2.75	70	.25	6

SHIELDS SILICONE ELBOWS - 45°

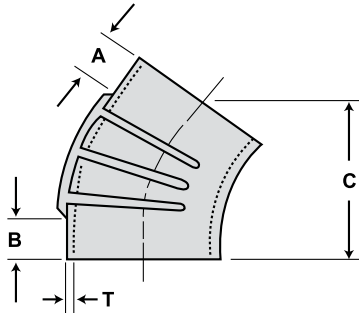

45° Elbow



Part Number	ID	mm	A	mm	B	mm	C	mm	T	mm
16-245S3000	3.0	76.2	1.50	38	1.50	38	5.50	140	.25	6
16-245S4000	4.0	101.6	1.50	38	1.50	38	5.50	140	.25	6
16-245S5000	5.0	127	1.62	41	1.62	41	5.25	133	.25	6
16-245S6000*	6.0	152.4	2.00	51	2.00	51	6.50	165	.25	6

* Asterisk indicates ribbed elbow

SHIELDS SILICONE ELBOWS - 90°

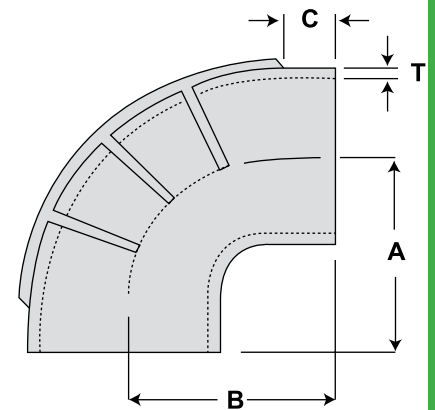

90° Elbow

Part Number	ID	mm	A	mm	B	mm	C	mm	T	mm
16-290S2000	2.0	50.8	4.25	108	5.25	133	2.75	70	.20	5
16-290S3000	3.0	76.2	5.25	133	5.25	133	1.50	38	.25	6
16-290S4000	4.0	101.6	5.75	146	5.75	146	1.50	38	.25	6
16-290S5000	5.0	127	6.00	152	6.00	152	1.62	41	.25	6
16-290S6000*	6.0	152.4	7.00	178	7.00	178	2.25	57	.25	6
16-290S8000*	8.0	203.2	8.50	216	8.50	216	2.00	51	.37	9

*Asterisk indicates ribbed elbow 90S6000

SHIELDS EPDM COUPLERS - SINGLE HUMP

100% High temperature EPDM rubber. Maximum operating temperature 250° F (120° C).

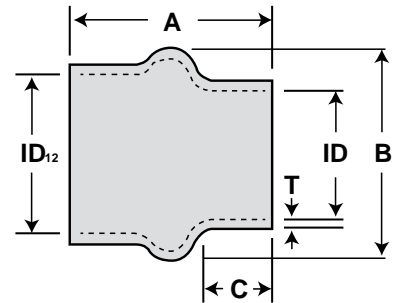

Reducing Hump Hose

Hump Hoses

Part Number	ID	mm	A	mm	B	mm	C	mm	T	mm
16-220-3000-1	3.00	76.2	5.25	133.35	4.50	114.3	2.00	50.8	0.25	6.35
16-220-3120-1	3.50	88.9	5.25	133.35	5.00	127	2.00	50.8	0.25	6.35
16-220-4000-1	4.00	101.6	5.25	133.35	5.50	139.7	2.00	50.8	0.25	6.35
16-220-4120-1	4.50	114.3	5.25	133.35	6.00	152.4	1.75	44.45	0.25	6.35
16-220-5000-1	5.00	127	6.00	152.4	6.50	165.1	2.25	57.15	0.25	6.35
16-220-6000-1	6.00	152.4	7.00	177.8	7.50	190.5	2.75	69.85	0.25	6.35
16-220-8000-1	8.00	203.2	5.00	127	9.50	241.3	1.50	38.1	0.25	6.35
16-220-10000-1	10.00	254	6.00	152.4	11.50	292.1	2.00	50.8	0.25	6.35

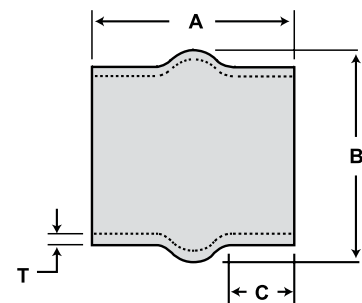

Hump Hose

Reducing Hump Hoses

Part Number	ID1	mm	ID2	mm	A	mm	B	mm	C	mm	T	mm
16-221-4X3	4.00	101.6	3.00	76.2	5.25	133.6	5.50	139.7	1.50	38.1	0.25	6.35
16-221-5X4	5.00	127	4.00	101.6	5.50	139.7	6.50	165.1	1.50	38.1	0.25	6.35
16-221-6X5	6.00	152.4	5.00	127	6.00	152.4	7.50	190.5	2.12	53.85	0.25	6.35
16-221-8X6	8.00	203.2	6.00	152.4	6.00	152.4	9.50	241.3	1.38	35.05	0.25	6.35
16-221-10X8	10.00	254	8.00	203.2	6.00	152.4	11.50	292.1	1.75	44.45	0.25	6.35

SHIELDS EPDM ELBOWS - 45°

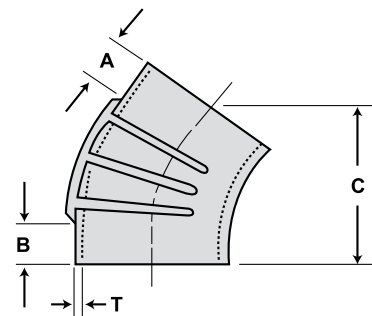

45° Elbow

*Asterisk indicates ribbed elbow

Part Number	ID	mm	A	mm	B	mm	C	mm	T	mm
16-245-3000-1	3.00	76.2	1.50	38.1	1.50	38.1	5.50	139.7	0.25	6.35
16-245-3120-1	3.50	88.9	1.50	38.1	1.50	38.1	5.50	139.7	0.25	6.35
16-245-4000-1	4.00	101.6	1.50	38.1	1.50	38.1	5.50	139.7	0.25	6.35
16-245-4120-1	4.50	144.3	1.50	38.1	1.50	38.1	5.75	146.1	.25	6.35
16-245-5000-1	5.00	127	1.62	41.15	1.62	41.15	5.25	133.35	0.25	6.35
16-245-6000-1*	6.00	152.4	2.00	50.8	2.00	50.8	6.50	165.1	0.25	6.35
16-245-8000-1*	8.00	203.2	2.25	57.15	2.25	57.15	8.25	209.6	0.37	9.40
16-245-10000-1*	10.00	254	2.25	57.15	2.25	57.15	10.50	266.7	0.37	9.40

SHIELDS EPDM ELBOWS - 90°

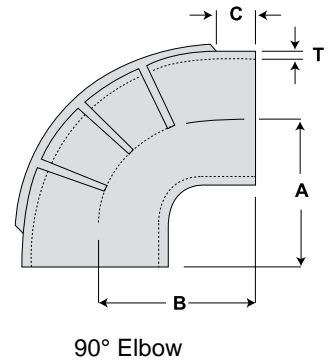

*Asterisk indicates ribbed elbow

Part Number	ID	mm	A	mm	B	mm	C	mm	T	mm
16-290-2000-1	2.00	50.8	4.25	107.95	5.25	133.35	2.75	69.85	0.20	5.08
16-290-2120-1	2.50	63.5	4.25	107.95	4.25	107.95	1.50	38.1	0.20	5.08
16-290-3000-1	3.00	76.2	5.25	133.35	5.25	133.35	1.50	38.1	0.25	6.35
16-290-3120-1	3.50	88.9	5.50	139.7	5.50	139.7	1.75	44.45	0.25	6.35
16-290-4000-1	4.00	101.6	5.75	146.05	5.75	146.05	1.50	38.1	0.25	6.35
16-290-4120-1	4.50	114.3	6.00	152.4	6.00	152.4	1.50	38.1	0.25	6.35
16-290-5000-1	5.00	127	6.00	152.4	6.00	152.4	1.62	41.15	0.25	6.35
16-290-6000-1*	6.00	152.4	7.00	177.8	7.00	177.8	2.25	57.15	0.25	6.35
16-290-8000-1*	8.00	203.2	8.50	215.9	8.50	215.9	2.00	50.8	0.37	9.40

SHIELDS EPDM ELBOWS - 90° REDUCING ELBOW

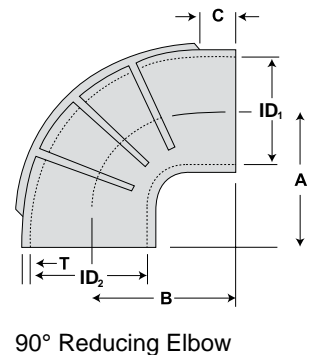

Part Number	ID1	mm	ID2	mm	A	mm	B	mm	C	mm	T	mm
16-291-5004001	4.00	101.6	5.00	127	5.75	146	6.00	152.4	1.75	44.45	0.25	6.35

Also available with series 720 T-bolt clamps. Order part number with "Kit" Suffix.



SHIELDS EXHAUST PROTECTOR VALVES

Specially compounded rubber flapper valves designed to prevent water from entering the exhaust system in following seas or when backing down. Made with weather resistant EPDM with U/V stabilizer.

Code #	Pipe Size	mm	O.E.M.	O.E. #
18-4456*	3"	76.2	Mercury	34765A1
18-4457*	4"	101.6	Mercury	12644A1
18-4458*	5" or 6"	127 or 152.4	—	—

* Display Packaged

Must be cut to fit 5" pipe (two 45° cuts required)

18-#'s include stainless steel hose clamp.



SHIELDS EXHAUST HOSE CLAMPS T-BOLT BAND CLAMPS

Diameter Range	mm	Hose I.D.	mm	Wt. "C"	Code No.
1.18 - 1.47	30.0 - 37.3	1"	25.4	9.4	18-720-1000 ②
1.70 - 2.03	43.2 - 51.6	1 1/2"	38.1	12.5	18-720-1120 ②
1.48 - 1.62	37.59 - 41.15	1 1/4"	31.75	11	18-720-1140 ②
2.27 - 2.67	57.7 - 67.8	2"	50.8	12.8	18-720-2000
2.68 - 3.34	68.1 - 84.8	2 1/2"	63.5	15.6	18-720-2120
3.10 - 3.76	78.7 - 95.5	3"	76.2	15.8	18-720-3000
3.59 - 4.25	91.2 - 108	3 1/2"	88.9	17.2	18-720-3120
4.18 - 4.84	106.2 - 122.9	4"	101.6	18.8	18-720-4000
4.25 - 4.91	108.0 - 124.7	4 1/8"	104.8	18.9	18-720-4180
4.75 - 5.41	120.7 - 137.4	4 1/2"	114.3	20	18-720-4120
4.68 - 5.34	118.9 - 135.6	4 1/2"	114.3	20	18-720-4120S *
5.30 - 5.96	134.6 - 151.4	5"	127.0	22	18-720-5000
5.18 - 5.84	131.6 - 148.3	5"	127.0	22	18-720-5000S *
5.75 - 6.41	146.1 - 162.8	5 1/2"	139.7	25	18-720-5120
5.68 - 6.34	144.3 - 161.0	5 1/2"	139.7	25	18-720-5120S *
6.38 - 7.04	162.1 - 178.8	6"	152.4	27	18-720-6000
6.18 - 6.84	157.0 - 173.7	6"	152.4	27	18-720-6000S *
8.42 - 9.08	213.9 - 230.6	8"	203.2	29	18-720-8000
8.18 - 8.84	207.8 - 224.5	8"	203.2	29	18-720-8000S *
10.45 - 11.11	265.4 - 282.2	10"	254.0	31	18-720-10000
10.18 - 10.84	258.6 - 275.3	10"	254.0	31	18-720-10000S *
12.38 - 13.04	314.5 - 331.2	12"	304.8	33	18-720-12000
12.18 - 12.84	309.4 - 326.1	12"	304.8	33	18-720-12000S *
14.50 - 15.16	368.3 - 385.1	14"	355.6	41.1	18-720-14000
14.30 - 14.96	363.2 - 380.0	14"	355.6	41.1	18-720-14000S *

② Clamps for 1" and 1 1/2" are 5/8" wide

* Designed to fit Series 202 silicone exhaust hose

These exhaust hose clamps are designed to fit Shields series 200, 250, and are perfect for any application below the water line. The band is 316 stainless steel and is .025 thick by .75 wide. Other hardware includes an extra long 1/4" bolt and a nylon inset locknut. The bolt, nut and trunion are 18-8 (304) stainless steel. Maximum torque of 75 inch pounds.

SHIELDS HOSE CLAMPS

All components are manufactured from marine grade 316 stainless steel. These clamps are designed to fit many applications from 5/16" to 7" diameter hoses.



Sierra No.	Bulk No.	Diameter Size	Std. No.
18-710-06-2	18-710-06	7/16" to 3/4"	006
18-710-08-2	18-710-08	1/2" to 7/8"	008
18-710-10-2	18-710-10	9/16" to 1 1/16"	010
18-710-12-2	18-710-12	1 1/16" to 1 1/4"	012
18-710-16-2	18-710-16	1 1/16" to 1 1/2"	016
18-710-20-2	18-710-20	1 3/16" to 1 3/4"	020
18-710-24-2	18-710-24	1 1/16" to 2"	024
18-710-28-2	18-710-28	1 5/16" to 2 1/4"	028
18-710-32-2	18-710-32	1 9/16" to 2 1/2"	032
18-710-36-2	18-710-36	1 13/16" to 2 3/4"	036
18-710-40-2	18-710-40	2 1/16" to 3"	040
18-710-44-2	18-710-44	2 5/16" to 3 1/4"	044
18-710-48-2	18-710-48	2 9/16" to 3 1/2"	048
18-710-52-2	18-710-52	2 13/16" to 3 3/4"	052
18-710-56-2	18-710-56	3 1/16" to 4"	056
18-710-60-2	18-710-60	3 5/16" to 4 1/4"	060
18-710-64-2	18-710-64	3 9/16" to 4 1/2"	064
18-710-72-2	18-710-72	4 1/16" to 5"	072
18-710-80-2	18-710-80	4 9/16" to 5 1/2"	080
18-710-88-2	18-710-88	5 1/16" to 6"	088
18-710-96-2	18-710-96	5 5/8" to 6 1/2"	096
18-710-104-2	18-710-104	5" to 7"	104

SHIELDS CONSTANT TENSION CLAMPS

Diameter Range (in.)	Sierra No.	Fits Series 202 Sizes
1.75 - 2.625	18-725-2000	1 3/4", 1 7/8", 2"
4.25 - 5.125	18-725-4000	4", 4 1/2"

• Clamping Silicone Heater/Exhaust Hose

SHIELDS EXPANDABLE BRAIDED SLEEVING (Scissor Cut)

Shields Expandable Conduit is designed to be cut with a scissors making it ideal for field installation where a hot knife required by other conduit is not practical. Conduit features a dense braid for excellent coverage and high abrasion resistance. Temperature range -94°F to 257°F, melt temperature 482°F. Meets RoHS, ABYC & UL 94 V2 standards.



Part Number	Description	Expansion Range		Shop Spool Ft.	Wt./Spool lbs.
		Min.	Max.		
16-129-0147	1/4" Expandable Braided Sleeving	5/32"	7/16"	100	0.46
16-129-0127	1/2" Expandable Braided Sleeving	1/4"	3/4"	100	0.82
16-129-0348	3/4" Expandable Braided Sleeving	5/8"	1"	75	0.84
16-129-1006	1" Expandable Braided Sleeving	3/4"	1 3/16"	50	0.62
16-129-1126	1 1/2" Expandable Braided Sleeving	1 1/4"	2"	50	0.93
16-129-2006	2" Expandable Braided Sleeving	1 3/4"	2 1/2"	50	1.75



SHIELDS FLAME RETARDANT SPLIT WIRE CONDUIT

Flame retardant polypropylene is black with a blue stripe. It provides chafing protection for wiring systems and is split longitudinally for easy access to harness. It has a temperature range of +275°F. It meets ABYC standard 8.15.19. and UL 94 V2.



I.D.	mm	Wt. "C"	Code #	Pack	m	Dist. Pkg.		
						100' (30.1m) R/O Ctn. Code #	50' (15.2m) R/O Ctn. Code #	50' (15.2m) Box Code #
1/4"	6.4	1.26	16-128-0140B	3200'	975	16-128-0147B	16-128-0146B	16-128-0146B-1
3/8"	9.5	1.58	16-128-0380B	1800'	549	16-128-0387B	16-128-0386B	16-128-0386B-1
1/2"	12.7	2.31	16-128-0120B	1100'	335	16-128-0127B	16-128-0126B	16-128-0126B-1
5/8"	15.9	2.94	16-128-0580B	750'	229	16-128-0587B	16-128-0586B	16-128-0586B-1
3/4"	19.1	3.47	16-128-0340B	450'	137	16-128-0347B	16-128-0346B	16-128-0346B-1
1"	25.4	5.78	16-128-1000B	300'	91	16-128-1007B	16-128-1006B	16-128-1006B-1
1 1/4"	31.8	9.24	16-128-1140B	200'	61	16-128-1147B	16-128-1146B	—
1 1/2"	38.1	15.23	16-128-1120B	100'	31	—	16-128-1126B	—
2"	50.8	21.00	16-128-2000B	100'	31	—	—	—

SHIELDS STERNFLEX



Shields Sternflex has a polyethylene co-polymer wall with an integral polyethylene helix. It is resistant to abrasion, crushing and UV. This hose is primarily used as a cover for the harness and for the hoses on the bracket mounted on outboard engines.



I.D.	mm	Bend Radius	mm	Wt. "C"	Bulk Pack 50' (15.2m) Length Code No.	Dist. Pkg. 10' (3.1m) Box Code No.
2"	50.8	3	76.2	39	16-126-2000B	16-126-2003B

RIGGING FLANGE



18-9761 - Part No.

- U/V stabilized black plastic flange
- Use with Shields
2" Sternflex P/N 16-126-2000B

RIGGING HOSE KIT



18-9883 - Part No.

- Hides all engine cables and hoses
- Can be added to any style outboard
- Contains:
 - (1) U/V stabilized flange
 - 5' 2" Black Sternflex

SHIELDS NEOPRENE SHEET RUBBER

Solid Neoprene sheet rubber is designed for use under fuel tanks to comply with USCG requirements for air space. Also for gaskets, component padding and under wire straps. It can be custom cut to a variety of strips and shapes. It is offered in bulk rolls 36" wide x 10' long.

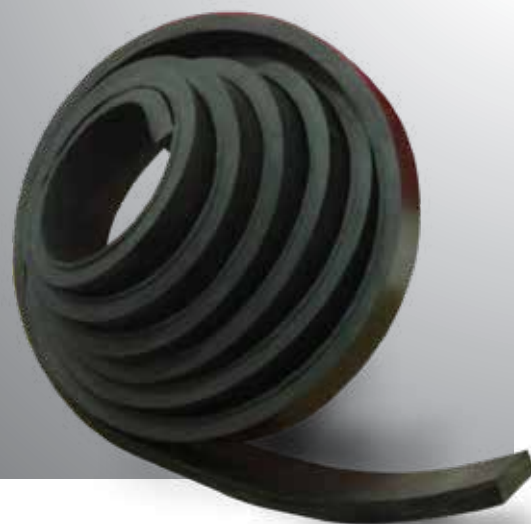

BULK SHEET

Thickness	mm	Width	mm	Length	mm	Code No.
1/8"	3.2	36"	914.4	10'	3.1	N18NEO60
3/16"	4.8	36"	914.4	10'	3.1	N316NEO60
1/4"	6.4	36"	914.4	10'	3.1	N14NEO60
3/8"	9.5	36"	914.4	10'	3.1	N38NEO60

DISTRIBUTOR BOXES

Thickness	mm	Width	mm	Length	mm	Code No.
1/8"	3.2	2"	50.8	10'	3.1	16-18X2X10
1/4"	6.4	2"	50.8	10'	3.1	16-14X2X10
3/8"	9.5	2"	50.8	10'	3.1	16-38X2X10
1/8"	3.3	1"	25.4	10'	3.1	16-18X1X10
1/4"	6.4	1"	25.4	10'	3.1	16-14X1X10
3/8"	9.7	1"	25.4	10'	3.1	16-38X1X10

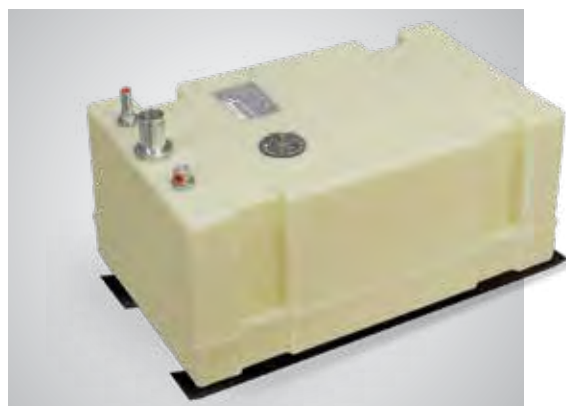

SHIELDS SPEEDOMETER PITOT TUBING

This black vinyl tubing is HW reinforced with a polyester braid and provides a tight connection between your speedometer pickup (Pitot) and your speedometer.

Nominal I.D.	mm	Braid	Wt. "C"	Code #	Bulk Pack	mm	Dist. Pkg. 25' (7.6m) Polypac Code #
1/8" (.125")	3.2	0	2.2	16-151-0180	1500'	457.2	16-151-0185
4 mm (.157")	4.0	1	4.3	16-151-0180H.W.	300'	91.4	16-151-0185 H.W.





23-1100
AIR FILTER
Replaces: Kohler 267709
Fits: 3.5 CFZ, 4 CZ, 5 CFZ, 6.5 CZ



23-1101
AIR FILTER
Replaces: Westerbeke 39705
Fits: 8.0 BTDA(60Hz) / 6.0 BTDA(50Hz), 10.0 BTDA(60Hz) / 7.5 BTDA(50Hz), 12.5 BTDB(60Hz) / 9.4 BTDB(50Hz), 15.0 BTDC(60Hz) / 12.0 BTDC(50Hz)



23-1104
AIR FILTER
Replaces: Fischer Panda IC78.460.000B
Fits: PMS 4200, PMS04, PMS15, PMS 16 DP, PMS 20, PMS 22



23-1105
AIR FILTER
Replaces: Fischer Panda IC78.460.000A
Fits: PMS 8 Mini, PMS 8 DP, PMS 6500, PMS 12 DP, PMS 12 Mini



23-1102
AIR FILTER ELEMENT
Replaces: Northern Lights 24-22009
Fits: M843NW3: 12/10Kw, M844W3: 16/12KW, M844LW3: 20/16Kw



23-1103
AIR FILTER ELEMENT
Replaces: Northern Lights 24-28003
Fits: M673LD3: 5 / 4.5Kw, M673L3: 6/5Kw



23-1130
AIR FILTER
Replaces: Kohler 278857
Fits: 4 CCFZ(variation 4), 4EFOZ(variation 4), 5 CCOZ(variation 4), 5EOZ(variation 4), 6.5 EFOZ(variation 4), 8EOZ(variation 4), 8EFOZ, 9 CCOZ, 9EOZ, 9EFOZ, 10EOZ, 6.5EFOZD, 7 EFOZD, 8EOZD, 8.5 EFOZD, 9 EOZD, 9EFOZD, 10EOZD



23-7200
CARB KIT
Replaces: Westerbeke 36450
Fits: 6.5 TWG(60Hz)/4.9 TWG(50Hz), 8.0 TWG(60Hz)/6.4 TWG(50Hz), 8.5 BTG(60Hz)/6.5 BTG(50Hz), 12.5 BTG(60Hz)/10.0 BTG(50Hz), 15.0 BTG/A(60Hz)/12.0 BTG/A(50Hz), 20.0 BEG(60Hz)/16.0 BEG(50Hz), 25.0 BEG(60Hz)/20.0 BEG(50Hz)



23-7201
CARB KIT
Replaces: Westerbeke 38100
Fits: 4.0 BCG(60Hz)/3.0 BCG(50Hz), 4.5 BCG(60Hz)/3.75 BCG(50Hz), 4.5 BCGB(60Hz)/3.75 BCGB(50Hz), 4.5 BCGTC(60Hz)/3.75 BCGTC(50Hz), 5.0 BCG(60Hz)/4.2 BCG(50Hz), 6.5 BCG(60Hz)/4.8 BCG(50Hz), 7.0 BCG(60Hz)/5.0 BCG(50Hz), 7.0 BCGA(60Hz)/5.0 BCGA(50Hz), 7.0 BCGB(60Hz)/6.0 BCGB(50Hz), 7.2 BCGTC(60Hz)/6.0 BCGTC(50Hz), 8.0 BEG(60Hz)/6.4 BEG(50Hz), 9.6 BCGTC(60Hz)/8.0 BCGTC(50Hz), 10.0 BEG(60Hz)/8.0 BEG(50Hz), 12.5 BEG(60Hz)/10.0 BEG(50Hz), 15.0 BEG(60Hz)/12.0 BEG(50Hz)



23-7202
CARB KIT
Replaces: Kohler GM24510
Fits: 4EF, 5E, 6EF, 7.3E, 5ECD, 4EFCD, 6EFCD and 7.3 ECD



23-7740
FUEL FILTER
Replaces: Kohler 252898
Fits: 11 CCFZ (variation 2), 11.5 CCFZ (variation 2), 11EFOZ (variation 2), 11.5EFOZ (variation 2), 13EOZ (variation 2), 13EFOZ (variation 2), 13.5 CCOZ (variation 2), 14 CCOZ (variation 2), 14EOZ (variation 2), 15 CCFZ (variation 3), 15.5EOZ (variation 2), 16EFOZ (variation 3), 17.5EFOZ (variation 3), 18.5 CCOZ (variation 3), 19EFOZ (variation 3), 20 CCFZ (variation 3), 20EOZ (variation 3), 20EFOZ (variation 3), 23EOZ (variation 3), 24 CCOZ (variation 3), 24EOZ (variation 3), 17EFOZD (variation 3), 17.5EFOZD (variation 3), 19EFOZD (variation 3), 20EOZD (variation 3), 20EFOZD (variation 3), 23EOZD (variation 3), 24EOZD (variation 3)



23-7751
FUEL FILTER
Replaces: Kohler 229715
Fits: 4 CCFZ, 4EFOZ, 5 CCOZ, 5EOZ, 6.5 EFOZ, 8EOZ, 6.5EFOZD, 8EOZD



23-7760

FUEL FILTER

Replaces: Onan A026K278, 149-2106
Fits: MDKAU, MDKAV, MDKKBG, MDKAW (Spacesaver), MDKAZ, MDKBD, MDKBE, MDKBF, MDKBD (w/ Isolated Ground), MDKBE (w/ Isolated Ground), MDKBF (w/ Isolated Ground), MDKAD/E/F



23-7761

FUEL FILTER

Replaces: Kohler GM32359
Fits: 7 EFOZD(variation 1), 8.5 EFOZD(variation 1), 9 EOZD(variation 1), 9EFOZD(variation 1), 10EOZD(variation 1), 11EFOZD(variation 3), 11.5EFOZD(variation 3), 13EOZD(variation 3), 13EFOZD(variation 3), 14 EOZD(variation 3), 15.5 EOZD(variation 3), 17 EFOZD(variation 1), 17.5EFOZD(variation 1), 19EFOZD(variation 1), 20EOZD(variation 1), 20EFOZD(variation 1), 23EOZD(variation 1), 24EOZD(variation 1), 23EFOZD, 27EFOZD, 28EOZD, 32EOZD



23-7762

FUEL FILTER

Replaces: Kohler 267987
Fits: 4EF, 5E, 6EF, 7.3E, 8E (GR4 Version), 10E (GR4 Version), 12.5E (GR4 Version)



23-7764

FUEL FILTER

Replaces: Westerbeke 24363
Fits: 15.0 BTD(60Hz) / 12.0 BTD(50Hz), 15.0 BTDA(60Hz) / 12.0 BTDA(50Hz), 15.0 BTDB(60Hz) / 12.0 BTDB(50Hz), 15.0 WTA(60Hz) / 12.0 WTA(50Hz), 20.0 BED(60Hz) / 16.0 BED(50Hz), 20.0 BEDA(60Hz) / 16.0 BEDA(50Hz), 20.0 WTA(60Hz) / 16.0 WTA(50Hz), 25.0 BED(60Hz) / 20.0 BED(50Hz), 25.0 WTA(60Hz) / 20.0 WTA(50Hz), 32.0 BED(60Hz) / 25.0 BED(50Hz), 32.0 BEDB(60Hz) / 25.0 BEDB(50Hz), 32.0 WTF(60Hz) / 25.0 WTF(50Hz)



23-7780

FUEL FILTER

Replaces: Kohler GM34570
Fits: 9 EFGD, 10 EG, 10 EGD, 13 EG, 13 EGD, 13 EGZ, 15 EG, 15 EGD, 15 EGZ



23-7750

FUEL FILTER ELEMENT

Replaces: Onan 149-0428
Fits: MDJA (Spec A-R), MDJB (Spec A-R), MDJC (Spec A-R), MDJE (Spec A), MDJF (Spec A)



23-7720

FUEL FILTER KIT

Replaces: Westerbeke 35920
Onan 149-1445
Fits: Westerbeke: 4.0 BCG(60Hz)/3.0 BCG(50Hz), 6.5 BCG(60Hz)/4.8 BCG(50Hz), 6.5 TWG(60Hz)/4.9 TWG(50Hz), 8.0 TWG(60Hz)/6.4 TWG(50Hz), 9.0 BTG(60Hz)/7.0 BTG(50Hz), 11.0 TWG(60Hz)/8.5 TWG(50Hz)



23-7770

FUEL FILTER KIT

Replaces: Westerbeke 47006, 30200
Fits several models. See application chart on pages 120-131



23-7771

FUEL FILTER KIT

Replaces: Kohler 249433
Fits: 3.5 CFZ(Variation 2), 4 CZ(Variation 2), 5 CFZ(Variation 2), 6.5 CZ(Variation 2), 8E(Variation 2), 10E(Variation 2), 12.5E(Variation 2)



23-1000

GLOW PLUG (12 Volt)

Replaces: Westerbeke 24353
Fits: 4.4 BCD(60Hz), 4.4 WMD(60Hz) / 3.3 WMD(50Hz), 6.0 BCD(60Hz) / 4.5 BCD(50Hz), 7.7 WMD(60Hz) / 5.8 WMD(50Hz), 8.0 BTD(60Hz) / 6.0 BTD(50Hz), 8.0 BTDA(60Hz) / 6.0 BTDA(50Hz), 8.0 WMD(60Hz) / 6.0 WMD(50Hz), 10.0 BTD(60Hz) / 7.5 BTD(50Hz), 10.0 BTDA(60Hz) / 7.5 BTDA(50Hz), 11.0 BTD(60Hz) / 8.3 BTD(50Hz), 11.0 WMD(60Hz) / 8.3 WMD(50Hz), 12.5 BTD(60Hz) / 9.4 BTD(50Hz), 12.5 BTDA(60Hz) / 9.4 BTDA(50Hz), 12.5 BTDB(60Hz) / 9.4 BTDB(50Hz), 12.5 WMD(60Hz) / 9.4 WMD(50Hz), 15.0 BTD(60Hz) / 12.0 BTD(50Hz), 15.0 BTDA(60Hz) / 12.0 BTDA(50Hz), 15.0 BTDB(60Hz) / 12.0 BTDB(50Hz), 15.0 BTDC(60Hz) / 12.0 BTDC(50Hz), 15.0 WTA(60Hz) / 12.0 WTA(50Hz), 20.0 BED(60Hz) / 16.0 BED(50Hz), 20.0 BEDA(60Hz) / 16.0 BEDA(50Hz), 20.0 WTA(60Hz) / 16.0 WTA(50Hz), 25.0 BED(60Hz) / 20.0 BED(50Hz), 25.0 WTA(60Hz) / 20.0 WTA(50Hz), 32.0 BED(60Hz) / 25.0 BED(50Hz), 32.0 BEDB(60Hz) / 25.0 BEDB(50Hz), 32.0 WTF(60Hz) / 25.0 WTF(50Hz)



23-5840

TEMPERATURE SENDER

Replaces: Westerbeke 35109
Fits several models. See application chart on pages 120-131



23-5880

OIL PRESSURE SENDER

Replaces: Westerbeke 24132
Fits several models. See application chart on pages 120-131



**23-2000
IMPELLER**

Replaces: **Westerbeke** 33112
(Impeller Only)
Fits: 6.5 TWG(60Hz)/4.9 TWG(50Hz), 8.0 TWG(60Hz)/6.4 TWG(50Hz), 8.5 BTG(60Hz)/6.5 BTG(50Hz), 11.0 TWG(60Hz)/8.5 TWG(50Hz), 12.5 BTG(60Hz)/10.0 BTG(50Hz), 15.0 BTG(60Hz)/12.0 BTG(50Hz), 15.0 BTGA(60Hz)/12.0 BTGA(50Hz), 20.0 WTA(60Hz)/16.0 WTA(50Hz)



**23-2001
IMPELLER**

Replaces: **Westerbeke** 32620
(Impeller Only)
Fits: 4.0 BCG(60Hz)/3.0 BCG(50Hz), 4.5 BCG(60Hz)/3.75 BCG(50Hz), 4.5 BCGB(60Hz)/3.75 BCGB(50Hz), 4.5 BCGTC(60Hz)/3.75 BCGTC(50Hz), 6.5 BCG(60Hz)/4.8 BCG(50Hz), 7.0 BCG(60Hz)/5.0 BCG(50Hz), 7.0 BCGA(60Hz)/5.0 BCGA(50Hz), 7.0 BCGB(60Hz)/6.0 BCGB(50Hz), 7.2 BCGTC(60Hz)/6.0 BCGTC(50Hz), 9.0 BTG(60Hz)/7.0 BTG(50Hz), 9.6 BCGTC(60Hz)/8.0 BCGTC(50Hz), 3.0 WMD(60Hz)/2.4 WMD(50Hz), 3.8/4.2 BCDT(60Hz) / 3.5 BCDT(50Hz), 5.0 BCG(60Hz)/4.2 BCG(50Hz), 5.0 BCGA(60Hz)/5.2 BCGA(50Hz), 7.0 BCGC(60Hz)/5.9 BCGC(50Hz), 8.0 BEG(60Hz)/6.4 BEG(50Hz), 10.0 BEG(60Hz)/8.0 BEG(50Hz), 12.5 BEG(60Hz)/10.0 BEG(50Hz), 15.0 BEG(60Hz)/12.0 BEG(50Hz)



**23-2002
IMPELLER**

Replaces: **Kohler** 229826
Fits: 8E (SN 296899 and Up), 10E (SN 296899 and Up), 12.5E (SN 296899 and Up), 12.5CF (SN 296899 and Up), 15C, 16CF, 20C



**23-2003
IMPELLER**

Replaces: **Kohler** 250872, **Jabsco** 22799-0001
Fits: 8E (SN 296898 and Below), 10E (SN 296898 and Below), 12.5E (SN 296898 and Below), 12.5CF (SN 296898 and Below)



**23-2004
IMPELLER KIT**

Replaces: **Kohler** 359978
(Impeller only)
Fits: Kohler Pump GM28487; Fits Models 4EF, 5E, 6EF, 7.3E, 4 EFCD, 5 ECD, 6 EFCD, 7.3 ECD,



**23-2005
IMPELLER KIT**

Replaces: **Northern Lights** 25-12009
(Impeller only)



**23-3300
IMPELLER KIT**

Replaces: **Onan** 132-0349
Fits: MDKAV, MDKBB, MDKAW (Spacesaver), MDKAZ, MDKBD, MDKBE, MDKBF, MDKBD (w/ Isolated Ground), MDKBE (w/ Isolated Ground), MDKBF (w/ Isolated Ground)



**23-3301
IMPELLER KIT**

Replaces: **Westerbeke** 11907
Fits: 20.0 BEG(60Hz)/16.0 BEG(50Hz), 25.0 BEG(60Hz)/20.0 BEG(50Hz), 20.0 SBEG(60Hz)/16.0 SBEG(50Hz), 20.0 SBEGA(60Hz)/16.0 SBEGA(50Hz), 22.5 SBEG(60Hz)/18.7 SBEG(50Hz), 22.5 SBEGA(60Hz)/18.7 SBEGA(50Hz), 20.0 BED(60Hz)/16.0 BED(50Hz), 20.0 BEDA(60Hz)/16.0 BEDA(50Hz), 25.0 BED(60Hz)/20.0 BED(50Hz), 25.0 WTA(60Hz)/20.0 WTA(50Hz), 32.0 BED(60Hz)/25.0 BED(50Hz), 32.0 BEDA(60Hz)/25.0 BEDA(50Hz), 32.0 BEDB(60Hz)/25.0 BEDB(50Hz), 32.0 WTF(60Hz)/25.0 WTF(50Hz)



**23-3302
IMPELLER KIT**

Replaces: **Westerbeke** 33112
Fits: 6.5 TWG(60Hz)/4.9 TWG(50Hz), 8.0 TWG(60Hz)/6.4 TWG(50Hz), 8.5 BTG(60Hz)/6.5 BTG(50Hz), 11.0 TWG(60Hz)/8.5 TWG(50Hz), 12.5 BTG(60Hz)/10.0 BTG(50Hz), 15.0 BTG(60Hz)/12.0 BTG(50Hz), 15.0 BTGA(60Hz)/12.0 BTGA(50Hz), 20.0 WTA(60Hz)/16.0 WTA(50Hz)
Includes **23-2000** Impeller



**23-3303
IMPELLER KIT**

Replaces: **Kohler** 229826
Fits: Kohler Pump GM46962; Fits: Models 8E (SN 296899 and Up), 10E (SN 296899 and Up), 12.5E (SN 296899 and Up), 12.5CF (SN 296899 and Up), 15C, 16CF, 20C



**23-3304
IMPELLER KIT**

Replaces: **Kohler** 229955
Fits: 8E (SN 296898 and Below), 10E (SN 296898 and Below), 12.5E (SN 296898 and Below), 12.5CF (SN 296898 and Below)



**23-3305
IMPELLER KIT**

Replaces: **Westerbeke** 32620
Fits: 4.0 BCG(60Hz)/3.0 BCG(50Hz), 4.5CG(60Hz)/3.75 BCG(50Hz), 4.5 BCGB(60Hz)/3.75 BCGB(50Hz), 4.5 BCGTC(60Hz)/3.75 BCGTC(50Hz), 6.5 BCG(60Hz)/4.8 BCG(50Hz), 7.0 BCG(60Hz)/5.0 BCG(50Hz), 7.0 BCGA(60Hz)/5.0 BCGA(50Hz), 7.0 BCGB(60Hz)/6.0 BCGB(50Hz), 7.2 BCGTC(60Hz)/6.0 BCGTC(50Hz), 9.0 BTG(60Hz)/7.0 BTG(50Hz), 9.6 BCGTC(60Hz)/8.0 BCGTC(50Hz), 3.0 WMD(60Hz)/2.4 WMD(50Hz), 3.8/4.2 BCDT(60Hz) / 3.5 BCDT(50Hz)



**23-3306
IMPELLER KIT**
Replaces: **Westerbeke** 46622
Fits: 5.0 BCG(60Hz)/4.2 BCG(50Hz), 5.0 BCGA(60Hz)/5.2 BCGA(50Hz), 7.0 BCGC(60Hz)/5.9 BCGC(50Hz), 8.0 BEG(60Hz)/6.4 BEG(50Hz), 10.0 BEG(60Hz)/8.0 BEG(50Hz), 12.5 BEG(60Hz)/10.0 BEG(50Hz), 15.0 BEG(60Hz)/12.0 BEG(50Hz)



**23-3307
IMPELLER KIT**
Replaces: **Westerbeke** 34440
Fits: 4.0 BCD(60Hz), 4.4 BCD(60Hz), 4.4 WMD(60Hz)/3.3 WMD(50Hz), 5.0 BCD(60Hz)/4.0 BCD(50Hz), 5.0 BCDA(60Hz)/4.0 BCDA(50Hz), 5.0 BCDB(60Hz)/4.0 BCDB(50Hz), 6.0 BCD(60Hz)/4.5 BCD(50Hz), 7.6 BTD(60Hz)/5.7 BTD(50Hz), 7.7 WMD(60Hz)/5.8 WMD(50Hz), 8.0 BTD(60Hz)/6.0 BTD(50Hz), 8.0 BTDA(60Hz)/6.0 BTDA(50Hz)(Before March 2004), 8.0 WMD(60Hz)/6.0 WMD(50Hz), 10.0 BTD(60Hz)/7.5 BTD(50Hz), 10.0 BTDA(60Hz)/7.5 BTDA(50Hz), 11.0 BTD(60Hz)/8.3 BTD(50Hz), 11.0 WMD(60Hz)/8.3 WMD(50Hz), 12.5 BTD(60Hz)/9.4 BTD(50Hz), 12.5 BTDA(60Hz)/9.4 BTDA(50Hz), 12.5 BTDB(60Hz)/9.4 BTDB(50Hz), 12.5 WMD(60Hz)/9.4 WMD(50Hz), 15.0 BTDC(60Hz)/12.0 BTDC(50Hz)



**23-3308
IMPELLER KIT**
Replaces: **Kohler** 352122
Fits: 33EFOZ, 33 CFOZ, 40 CFOZ, 40EOZ, 40EFOZ, 50 COZ, 50 CFOZ, 50EOZ, 55EFOZ, 65 COZ, 65EOZ, 70EFOZ, 80EOZ, 80EFOZ, 99EOZ



**23-3309
IMPELLER KIT**
Replaces: **Onan** 132-0436
Fits: MDDCA, MDDCB, MDCC, MDDCF, MDDCG, MDDCD, MDDCE, MDDCH, MDCCJ



**23-3310
IMPELLER KIT**
Replaces: **Onan** 541-1519
Fits: MDKKB, MDKBL, MDKBM, MDKBN, MDKAL/A/B



**23-3311
IMPELLER KIT**
Replaces: **Fischer Panda** J009-46840
Mase 80161
Fits: AGTPM 4, PMS 4, IS 2.5, IS 4.0, IS 4.7, IS 7.1



**23-3312
IMPELLER KIT**
Replaces: **Fischer Panda** J009-1027B-1
Mase 92911
Fits: IS 13.2, IS 10.2, IS 14.0, IS 19.0, IS 23.1T, PMS 15, PMS 16 DP, PMS 20, PMS 22, PMS 25, PMS 30, PMS 40, PMS 50



**23-3313
IMPELLER KIT**
Replaces: **Westerbeke** 33104
Fits: 15.0 BTD(60Hz) / 12.0 BTD(50Hz), 15.0 BTDA(60Hz) / 12.0 BTDA(50Hz), 15.0 BTDB(60Hz) / 12.0 BTDB(50Hz), 15.0 WTA(60Hz) / 12.0 WTA(50Hz)



**23-3314
IMPELLER KIT**
Replaces: **Kohler** 359978
Fits: Kohler Pump GM28487; Fits Models 4EF, 5E, 6EF, 7.3E, 4 EFCD, 5 ECD, 6 EFCD, 7.3 ECD



**23-3315
IMPELLER KIT**
Replaces: **Northern Lights** 25-12009
Fits: M673LD3, M673L3, M673LD2, M673L2



**23-0400
QUAD RING**
Replaces: **Northern Lights** 25-12031



**23-4005
SEA WATER PUMP BELT**
Replaces: **Westerbeke** 13810
Fits: 32.0 BED(60Hz) / 25.0 BED(50Hz), 32.0 BEDA(60Hz) / 25.0 BEDA(50Hz), 32.0 BEDB(60Hz) / 25.0 BEDB(50Hz)



**23-4006
SEA WATER PUMP BELT**

Replaces: *Westerbeke* 31152
Fits: 20.0 BED(60Hz) / 16.0 BED(50Hz), 20.0 BEDA(60Hz) / 16.0 BEDA(50Hz), 20.0 WTA(60Hz) / 16.0 WTA(50Hz), 25.0 BED(60Hz) / 20.0 BED(50Hz)



**23-4007
SEA WATER PUMP BELT**

Replaces: *Westerbeke* 30376
Fits: 4.0 BCD(60Hz), 4.4 BCD(60Hz), 4.4 WMD(60Hz) / 3.3 WMD(50Hz), 5.0 BCD/BCDA/BCDB(60Hz) / 4.0 BCD/BCDA/BCDB(50Hz)



**23-3600
THERMOSTAT**

Replaces: *Westerbeke* 24688
Temperature Rating: 180°
Fits: 3.0 WMD(60Hz)/2.4 WMD(50Hz), 4.4 BCD(60Hz), 4.4 WMD(60Hz) / 3.3 WMD(50Hz), 7.7 WMD(60Hz) / 5.8 WMD(50Hz), 8.0 BTD(60Hz) / 6.0 BTD(50Hz), 8.0 BTDA(60Hz) / 6.0 BTDA(50Hz), 8.0 WMD(60Hz) / 6.0 WMD(50Hz), 10.0 BTD(60Hz) / 7.5 BTD(50Hz), 10.0 BTDA(60Hz) / 7.5 BTDA(50Hz), 11.0 BTD(60Hz) / 8.3 BTD(50Hz), 11.0 WMD(60Hz) / 8.3 WMD(50Hz), 12.5 BTD(60Hz) / 9.4 BTD(50Hz), 12.5 BTDA(60Hz) / 9.4 BTDA(50Hz), 12.5 BTDB(60Hz) / 9.4 BTDB(50Hz), 12.5 WMD(60Hz) / 9.4 WMD(50Hz), 12.6 BTD(60Hz) / 10.4 BTD(50Hz), 15.0 BTD(60Hz) / 12.0 BTD(50Hz), 15.0 BTDC(60Hz) / 12.0 BTDC(50Hz), 20.0 SBEG(60Hz) / 16.0 SBEG(50Hz), 20.0 SBEGA(60Hz) / 16.0 SBEGA(50Hz), 22.5 SBEG(60Hz) / 18.7 SBEG(50Hz), 22.5 SBEGA(60Hz) / 18.7 SBEGA(50Hz)



**23-3601
THERMOSTAT**

Replaces: *Westerbeke* 35736
Temperature Rating: 140°
Fits: 6.5 BCG(60Hz)/4.8 BCG(50Hz), 6.5 TWG(60Hz)/4.9 TWG(50Hz), 8.0 TWG(60Hz)/6.4 TWG(50Hz), 8.5 BTG(60Hz)/6.5 BTG(50Hz), 9.0 BTG(60Hz)/7.0 BTG(50Hz), 11.0 TWG(60Hz)/8.5 TWG(50Hz), 12.5 BTG(60Hz)/10.0 BTG(50Hz), 15.0 BTG/A(60Hz)/12.0 BTG/A(50Hz), 20.0 BEG(60Hz)/16.0 BEG(50Hz), 25.0 BEG(60Hz)/20.0 BEG(50Hz)



**23-3602
THERMOSTAT**

Replaces: *Westerbeke* 37387
Temperature Rating: 140°
Fits: 4.5 BCG(60Hz)/3.75 BCG(50Hz), 7.0 BCG(60Hz)/5.0 BCG(50Hz), 7.0 BCGA(60Hz)/5.0 BCGA(50Hz)



**23-3603
THERMOSTAT**

Replaces: *Westerbeke* 39378
Temperature Rating: 160°
Fits: 4.5 BCGB(60Hz)/3.75 BCGB(50Hz), 4.5 BCGTC(60Hz)/3.75 BCGTC(50Hz), 5.0 BCG(60Hz)/4.2 BCG(50Hz), 5.0 BCGA(60Hz)/ 5.2 BCGA(50Hz), 7.0 BCGB(60Hz)/6.0 BCGB(50Hz), 7.0 BCGC(60Hz)/ 5.9 BCGC(50Hz), 7.2 BCGTC(60Hz)/6.0 BCGTC(50Hz), 5.0 SBCG(60Hz)/ 4.0 SBEG(50Hz), 6.5 SBCG(60Hz) / 5.4 SBCG(50Hz)



**23-3604
THERMOSTAT**

Replaces: *Westerbeke* 46097
Temperature Rating: 140°
Fits: 8.0 BEG(60Hz)/6.4 BEG(50Hz), 10.0 BEG(60Hz)/8.0 BEG(50Hz), 12.5 BEG(60Hz)/10.0 BEG(50Hz), 15.0 BEG(60Hz)/12.0 BEG(50Hz)



**23-3605
THERMOSTAT**

Replaces: *Westerbeke* 24690
Temperature Rating: 180°
Fits: 8.0 SBEG(60Hz) / 6.4 SBEG(50Hz), 10.0 SBEG(60Hz) / 8.0 SBEG(50Hz), 12.5 SBEG(60Hz) / 10.0 SBEG(50Hz), 14.0 SBEG(60Hz) / 11.6 SBEG(50Hz), 15.0 BTDA(60Hz) / 12.0 BTDA(50Hz), 15.0 BTDB(60Hz) / 12.0 BTDB(50Hz), 20.0 BED(60Hz) / 16.0 BED(50Hz), 20.0 BEDA(60Hz) / 16.0 BEDA(50Hz), 20.0 WTA(60Hz) / 16.0 WTA(50Hz), 25.0 BED(60Hz) / 20.0 BED(50Hz)



**23-3606
THERMOSTAT**

Replaces: *Onan* 309-0130
Temperature Rating: 143°
Fits: MDJA, MDJB, MDJC, MDJE, MDJF, MJA, MJB, MJC



**23-3607
THERMOSTAT**

Replaces: *Kohler* 352018
Temperature Rating: 195°
Fits: 33EFOZ(Variation 1), 33 CFOZ(Variation 1), 40 CFOZ(Variation 1), 40EOZ(Variation 1), 40EFOZ(Variation 1), 50 COZ(Variation 1), 50 CFOZ(Variation 1), 50EOZ(Variation 1), 55EFOZ(Variation 1), 65 COZ(Variation 1), 65EOZ(Variation 1), 70EFOZ(Variation 1), 80EOZ(Variation 1), 80EFOZ(Variation 1), 99EOZ(Variation 1), 100EFOZ(Variation 1), 125EOZ(Variation 1), 125EFOZ(Variation 1), 150EOZ(Variation 1)



**23-3608
THERMOSTAT**

Replaces: *Kohler* 249930
Temperature Rating: 190°
Fits: 4EF, 5E, 6EF, 7.3E, 8E, 10E, 12.5E, 12.5CF, 15C, 16CF, 20C



**23-3609
THERMOSTAT**

Replaces: *Kohler* 252896
Temperature Rating: 170°
Fits: 11 CCFZ, 11.5 CCFZ, 11EFOZ, 11.5EFOZ, 13EOZ, 13EFOZ, 13.5 CCOZ, 14 CCOZ, 14 EOZ, 15.5EOZ, 16EFOZ, 17.5EFOZ, 18.5 CCOZ, 19EFOZ, 20 CCFZ, 20EOZ, 20EFOZ, 23EOZ, 24 CCOZ, 24EOZ



23-3610
THERMOSTAT
Replaces: Kohler 267717
Temperature Rating: 180°
Fits: 3.5 CFZ, 3.5 EFZ, 4 CZ, 4 ESZ, 5 CFZ, 5 EFZ, 6.5 CZ, 6.5 ESZ



23-0800
THERMOSTAT GASKET
Replaces: Westerbeke 42260
Fits: 4.5 BCG(60Hz)/3.75 BCG(50Hz), 4.5 BCGTC(60Hz)/3.75 BCGTC(50Hz), 7.0 BCGB(60Hz)/6.0 BCGB(50Hz), 7.2 BCGTC(60Hz)/ 6.0 BCGTC(50Hz), 9.6 BCGTC(60Hz)/8.0 BCGTC(50Hz)



23-0801
THERMOSTAT GASKET
Replaces: Westerbeke 46124
Fits: 5.0 BCG(60Hz)/4.2 BCG(50Hz), 5.0 BCGA(60Hz)/5.2 BCGA(50Hz), 7.0 BCGC(60Hz)/5.9 BCGC(50Hz), 5.0 SBGC(60Hz) / 4.2 SBGC(50Hz), 6.5 SBGC(60Hz) / 5.4 SBGC(50Hz)



23-0802
THERMOSTAT GASKET
Replaces: Westerbeke 34196
Fits: 4.0 BCG(60Hz)/3.0 BCG(50Hz), 6.5 BCG(60Hz)/4.8 BCG(50Hz), 8.0 TWG(60Hz)/6.4 TWG(50Hz), 9.0 BTG(60Hz)/7.0 BTG(50Hz), 11.0 TWG(60Hz)/8.5 TWG(50Hz), 6.0 BCD(60Hz) / 4.5 BCD(50Hz), 8.0 BTD(60Hz) / 6.0 BTD(50Hz), 10.0 BTD(60Hz) / 7.5 BTD(50Hz), 11.0 BTD(60Hz) / 8.3 BTD(50Hz), 12.5 BTD(60Hz) / 9.4 BTD(50Hz), 12.5 BTDA(60Hz) / 9.4 BTDA(50Hz), 12.6 BTD(60Hz) / 10.4 BTD(50Hz)



23-0803
THERMOSTAT GASKET
Replaces: Westerbeke 33417
Fits: 6.5 TWG(60Hz)/4.9 TWG(50Hz), 8.0 BEG(60Hz)/6.4 BEG(50Hz), 8.5 BTG(60Hz)/6.5 BTG(50Hz), 10.0 BEG(60Hz)/8.0 BEG(50Hz), 12.5 BEG(60Hz)/10.0 BEG(50Hz), 12.5 BTG(60Hz)/10.0 BTG(50Hz), 15.0 BEG(60Hz)/12.0 BEG(50Hz), 15.0 BTG/A(60Hz)/12.0 BTG/A(50Hz), 8.0 SBEG(60Hz) / 6.4 SBEG(50Hz), 10.0 SBEG(60Hz) / 8.0 SBEG(50Hz), 12.5 SBEG(60Hz) / 10.0 SBEG(50Hz), 14.0 SBEG(60Hz) / 11.6 SBEG(50Hz)



23-0804
THERMOSTAT GASKET
Replaces: Westerbeke 33373
Fits: 15.0 BTDA(60Hz) / 12.0 BTDA(50Hz), 15.0 BTDB(60Hz) / 12.0 BTDB(50Hz), 15.0 WTA(60Hz) / 12.0 WTA(50Hz), 20.0 BED(60Hz) / 16.0 BED(50Hz), 20.0 BEDA(60Hz) / 16.0 BEDA(50Hz), 20.0 WTA(60Hz) / 16.0 WTA(50Hz), 25.0 BED(60Hz) / 20.0 BED(50Hz), 25.0 WTA(60Hz) / 20.0 WTA(50Hz)



23-0805
THERMOSTAT GASKET
Replaces: Westerbeke 40434
Fits: 20.0 BEG(60Hz)/16.0 BEG(50Hz), 25.0 BEG(60Hz)/20.0 BEG(50Hz), 20.0 SBEG(60Hz) / 16.0 SBEG(50Hz), 20.0 SBEGA(60Hz) / 16.0 SBEG(50Hz), 22.5 SBEG(60Hz) / 18.7 SBEG(50Hz), 22.5 SBEGA(60Hz) / 18.7 SBEGA(50Hz)



23-0806
THERMOSTAT GASKET
Replaces: Westerbeke 24323
Fits: 4.4 BCD(60Hz), 4.4 WMD(60Hz) / 3.3 WMD(50Hz), 7.7 WMD(60Hz) / 5.8 WMD(50Hz), 8.0 WMD(60Hz) / 6.0 WMD(50Hz), 11.0 WMD(60Hz) / 8.3 WMD(50Hz), 12.5 WMD(60Hz) / 9.4 WMD(50Hz)



23-0807
THERMOSTAT GASKET
Replaces: Westerbeke 33966
Fits: 15.0 BTD(60Hz) / 12.0 BTD(50Hz)



23-0808
THERMOSTAT GASKET
Replaces: Westerbeke 37922
Fits: 4.5 BCG(60Hz)/3.75 BCG(50Hz), 7.0 BCG(60Hz)/5.0 BCG(50Hz), 7.0 BCGA(60Hz)/5.0 BCGA(50Hz)



23-0809
THERMOSTAT GASKET
Replaces: Kohler 267718
Fits: 3.5CFZ, 4CZ, 5CFZ, 6.5CZ



23-0810
THERMOSTAT GASKET
Replaces: Kohler 229432
Fits: 11CCFOZ(variation 1,6), 11.5CCFOZ(variation 1,6), 11EFOZ(variation 1,6), 11.5EFOZ(variation 1,6), 13EOZ(variation 1,6), 13EFOZ(variation 1,6), 13.5CCOZ(variation 1,6), 14CCOZ(variation 1,6), 14EOZ(variation 1,6), 15CCFOZ, 15.5EOZ(variation 1,6), 16EFOZ, 17.5EFOZ, 18.5CCOZ, 19EFOZ, 20CCFOZ, 20EOZ, 20EFOZ, 23EOZ, 24CCOZ, 24EOZ



23-0811
THERMOSTAT GASKET
Replaces: Kohler 249865
Fits: 11CCFOZ(variation 2,3,4,5), 11.5CCFOZ(variation 2,3,4,5), 11EFOZ(variation 2,3,4,5), 11.5EFOZ(variation 2,3,4,5), 13EOZ(variation 2,3,4,5), 13EFOZ(variation 2,3,4,5), 13.5CCOZ(variation 2,3,4,5), 14CCOZ(variation 2,3,4,5), 14EOZ(variation 2,3,4,5), 15.5EOZ(variation 2,3,4,5), 11EFOZD, 11.5EFOZD, 13EOZD, 13EFOZD, 14EOZD, 15.5EOZD, 17EFOZD, 17.5EFOZD, 19EFOZD, 20EOZD, 20EFOZD, 23EOZD, 24EOZD



23-0812
THERMOSTAT GASKET

Replaces: Kohler 229433
Fits: 11 CCF0Z, 11.5 CCF0Z, 11EFOZ, 11.5EFOZ, 13EOZ, 13EFOZ, 13.5 CCOZ, 14 CCOZ, 14 EOZ, 15 CCF0Z, 15.5EOZ, 16EFOZ, 17.5EFOZ, 18.5 CCOZ, 19EFOZ, 20 CCF0Z, 20EOZ, 20EFOZ, 23EOZ, 24 CCOZ, 24EOZ, 11EFOZD, 11.5EFOZD, 13EFOZD, 14 EOZD, 15.5 EOZD, 17 EFOZD, 17.5EFOZD, 19EFOZD, 20EOZD, 20EFOZD, 23EOZD, 24EOZD



23-0813
THERMOSTAT GASKET

Replaces: Kohler 229963
Fits: 8E, 10E, 12.5E, 12.5CF, 15C, 16CF, 20C, 10EG, 13EG, 13EGZ, 15EG, 15EGZ, 4CCFOZ, 4EFOZ, 5CCOZ, 5EOZ, 6.5EFOZ, 8CCFOZ, 8EOZ, 8EFOZ, 9CCOZ, 9EOZ, 9EFOZ, 10EOZ, 23EFOZ, 27EFOZ, 28EOZ, 32EOZ, 6.5EFOZD, 7EFOZD, 8EOZD, 8.5EFOZD, 9EOZD, 9EFOZD, 10EOZD



23-0814
THERMOSTAT GASKET

Replaces: Kohler 352031
Fits: 33EFOZ(variation 1,2,3), 33CF0Z(variation 1,2,3), 40CF0Z(variation 1,2,3), 40EOZ(variation 1,2,3), 40EFOZ(variation 1,2,3), 50COZ(variation 1,2,3), 50CF0Z(variation 1,2,3), 50EOZ(variation 1,2,3), 55EFOZ(variation 1,2,3), 65COZ(variation 1,2,3), 65EOZ(variation 1,2,3), 70EFOZ(variation 1,2,3), 80EOZ(variation 1,2,3), 80EFOZ(variation 1,2,3), 99EOZ(variation 1,2,3), 100EFOZ(variation 1,2,3), 125EOZ(variation 1,2,3), 125EFOZ(variation 1,2,3), 150EOZ(variation 1,2,3)



23-0830
THERMOSTAT GASKET

Replaces: Northern Lights 11-10015
Fits: Used with 35-12500 and 35-11000 thermostats



23-3650
THERMOSTAT KIT

Replaces: Westerbeke 24688, 24323
Temperature Rating: 180°
Fits: 4.4 BCD(60Hz), 4.4 WMD(60Hz) / 3.3 WMD(50Hz), 7.7 WMD(60Hz) / 5.8 WMD(50Hz), 8.0 WMD(60Hz) / 6.0 WMD(50Hz), 11.0 WMD(60Hz) / 8.3 WMD(50Hz), 12.5 WMD(60Hz) / 9.4 WMD(50Hz)



23-3651
THERMOSTAT KIT

Replaces: Westerbeke 35736, 34196
Temperature Rating: 140°
Fits: 4.0 BCG(60Hz)/3.0 BCG(50Hz), 6.5 BCG(60Hz)/4.8 BCG(50Hz), 8.0 TWG(60Hz)/6.4 TWG(50Hz), 9.0 BTG(60Hz)/7.0 BTG(50Hz), 11.0 TWG(60Hz)/8.5 TWG(50Hz)



23-3652
THERMOSTAT KIT

Replaces: Westerbeke 35736, 33417
Temperature Rating: 140°
Fits: 6.5 TWG(60Hz)/4.9 TWG(50Hz), 8.5 BTG(60Hz)/6.5 BTG(50Hz), 12.5 BTG(60Hz)/10.0 BTG(50Hz), 15.0 BTG/A(60Hz)/12.0 BTG/A(50Hz)



23-3653
THERMOSTAT KIT

Replaces: Westerbeke 24688, 34196
Temperature Rating: 180°
Fits: 8.0 BTD(60Hz) / 6.0 BTD(50Hz), 10.0 BTD(60Hz) / 7.5 BTD(50Hz), 11.0 BTD(60Hz) / 8.3 BTD(50Hz), 12.5 BTD(60Hz) / 9.4 BTD(50Hz), 12.5 BTDA(60Hz) / 9.4 BTDA(50Hz), 12.6 BTD(60Hz) / 10.4 BTD(50Hz)



23-3654
THERMOSTAT KIT

Replaces: Westerbeke 39378, 42260
Temperature Rating: 160°
Fits: 4.5 BCGB(60Hz)/3.75 BCGB(50Hz), 4.5 BCGTC(60Hz)/3.75 BCGTC(50Hz), 7.0 BCGB(60Hz)/6.0 BCGB(50Hz), 7.2 BCGTC(60Hz)/6.0 BCGTC(50Hz), 9.6 BCGTC(60Hz)/8.0 BCGTC(50Hz)



23-3655
THERMOSTAT KIT

Replaces: Westerbeke 39378, 46124
Temperature Rating: 160°
Fits: 5.0 BCG(60Hz)/4.2 BCG(50Hz), 5.0 BCGA(60Hz)/5.2 BCGA(50Hz), 7.0 BCGC(60Hz)/5.9 BCGC(50Hz), 5.0 SBGC(60Hz) / 4.0 SBEG(50Hz), 6.5 SBGC(60Hz) / 5.4 SBGC(50Hz)



23-3656
THERMOSTAT KIT

Replaces: Westerbeke 46097, 33417
Temperature Rating: 140°
Fits: 8.0 BEG(60Hz)/6.4 BEG(50Hz), 10.0 BEG(60Hz)/8.0 BEG(50Hz), 12.5 BEG(60Hz)/10.0 BEG(50Hz), 15.0 BEG(60Hz)/12.0 BEG(50Hz)



23-3657
THERMOSTAT KIT

Replaces: Westerbeke 24690, 33417
Temperature Rating: 180°
Fits: 8.0 SBEG(60Hz) / 6.4 SBEG(50Hz), 10.0 SBEG(60Hz) / 8.0 SBEG(50Hz), 12.5 SBEG(60Hz) / 10.0 SBEG(50Hz), 14.0 SBEG(60Hz) / 11.6 SBEG(50Hz)



23-3658
THERMOSTAT KIT
Replaces: **Westerbeke** 24688, 33966
Temperature Rating: **180°**
Fits: 15.0 BTD(60Hz) / 12.0 BTD(50Hz)



23-3659
THERMOSTAT KIT
Replaces: **Westerbeke** 37387, 37922
Temperature Rating: **140°**
Fits: 4.5 BCG(60Hz)/3.75 BCG(50Hz), 7.0 BCG(60Hz)/5.0 BCG(50Hz), 7.0 BCGA(60Hz)/5.0 BCGA(50Hz)



23-3660
THERMOSTAT KIT
Replaces: **Westerbeke** 24690, 33373
Temperature Rating: **180°**
Fits: 15.0 BTDA(60Hz) / 12.0 BTDA(50Hz), 15.0 BTDB(60Hz) / 12.0 BTDB(50Hz), 15.0 WTA(60Hz) / 12.0 WTA(50Hz), 20.0 BED(60Hz) / 16.0 BED(50Hz), 20.0 BEDA(60Hz) / 16.0 BEDA(50Hz), 20.0 WTA(60Hz) / 16.0 WTA(50Hz), 25.0 BED(60Hz) / 20.0 BED(50Hz), 25.0 WTA(60Hz) / 20.0 WTA(50Hz)



23-3661
THERMOSTAT KIT
Replaces: **Westerbeke** 35736, 40434
Temperature Rating: **140°**
Fits: 20.0 BEG(60Hz)/16.0 BEG(50Hz), 25.0 BEG(60Hz)/20.0 BEG(50Hz)



23-3662
THERMOSTAT KIT
Replaces: **Westerbeke** 24688, 40434
Temperature Rating: **180°**
Fits: 20.0 SBEG(60Hz) / 16.0 SBEG(50Hz), 20.0 SBEGA(60Hz) / 16.0 SBEG(50Hz), 22.5 SBEG(60Hz) / 18.7 SBEG(50Hz), 22.5 SBEGA(60Hz) / 18.7 SBEGA(50Hz)



23-3663
THERMOSTAT KIT
Replaces: **Kohler** 267717, 267718
Temperature Rating: **180°**
Fits: 3.5 CFZ, 4 CZ, 5 CFZ, 6.5 CZ



23-3664
THERMOSTAT KIT
Replaces: **Kohler** 249930, 29963
Temperature Rating: **190°**
Fits: 8E, 10E, 12.5E, 12.5CF, 15C, 16CF, 20C, 10 EG, 13 EG, 13 EGZ, 15 EG, 15 EGZ



23-3665
THERMOSTAT KIT
Replaces: **Kohler** 252896, 229432
Temperature Rating: **170°**
Fits: 11 CCFOZ(Variation 1,6), 11.5 CCFOZ(Variation 1, 6), 11EFOZ(Variation 1, 6), 11.5EFOZ(Variation 1, 6), 13EEOZ(Variation 1, 6), 13EFOZ(Variation 1, 6), 13.5 CCOZ(Variation 1, 6), 14 CCOZ(Variation 1, 6), 14 EOZ(Variation 1, 6), 15.5EOZ(Variation 1, 6), 16EFOZ, 17.5EFOZ, 18.5 CCOZ, 19EFOZ, 20 CCFOZ, 20EOZ, 20EFOZ, 23EOZ, 24 CCOZ, 24EOZ



23-3666
THERMOSTAT KIT
Replaces: **Kohler** 352018, 352031
Temperature Rating: **195°**
Fits: 33EFOZ(Variation 1), 33 CFOZ(Variation 1), 40 CFOZ(Variation 1), 40EOZ(Variation 1), 40EFOZ(Variation 1), 50 COZ(Variation 1), 50 CFOZ(Variation 1), 50EOZ(Variation 1), 55EFOZ(Variation 1), 65 COZ(Variation 1), 65EOZ(Variation 1), 70EFOZ(Variation 1), 80EOZ(Variation 1), 80EFOZ(Variation 1), 99EOZ(Variation 1), 100EFOZ(Variation 1), 125EOZ(Variation 1), 125EFOZ(Variation 1), 150EOZ(Variation 1)



23-2700
DISTRIBUTOR CAP
Replaces: **Westerbeke** 40859
Fits: 20.0 BEG(60Hz)/16.0 BEG(50Hz), 25.0 BEG(60Hz)/20.0 BEG(50Hz), 20.0 SBEG(60Hz) / 16.0 SBEG(50Hz), 20.0 SBEGA(60Hz) / 16.0 SBEG(50Hz), 22.5 SBEG(60Hz) / 18.7 SBEG(50Hz), 22.5 SBEGA(60Hz) / 18.7 SBEGA(50Hz)



23-2701
DISTRIBUTOR CAP
Replaces: **Westerbeke** 34113
Fits: 6.5 TWG(60Hz)/4.9 TWG(50Hz), 8.0 TWG(60Hz)/6.4 TWG(50Hz), 11.0 TWG(60Hz)/8.5 TWG(50Hz), 8.5 BTG(60Hz)/6.5 BTG(50Hz), 12.5 BTG(60Hz)/10.0 BTG(50Hz), 15.0 BTG/A(60Hz)/12.0 BTG/A(50Hz)



23-2702
DISTRIBUTOR CAP
Replaces: **Westerbeke** 35608
Fits: 6.5 BCG(60Hz)/4.8 BCG(50Hz), 9.0 BTG(60Hz)/7.0 BTG(50Hz)



23-2703
DISTRIBUTOR CAP
Replaces: **Westerbeke** 46592
Fits: 8.0 BEG(60Hz)/6.4 BEG(50Hz), 10.0 BEG(60Hz)/8.0 BEG(50Hz), 12.5 BEG(60Hz)/10.0 BEG(50Hz), 15.0 BEG(60Hz)/12.0 BEG(50Hz), 8.0 SBEG(60Hz) / 6.4 SBEG(50Hz), 10.0 SBEG(60Hz) / 8.0 SBEG(50Hz), 12.5 SBEG(60Hz) / 10.0 SBEG(50Hz), 14.0 SBEG(60Hz) / 11.6 SBEG(50Hz)



**23-4500
PLUG WIRE SET**

Replaces: *Westerbeke* 43060
Fits: 4.5 BCGB(60Hz)/3.75 BCGB(50Hz), 4.5 BCGTC(60Hz)/3.75 BCGTC(50Hz), 4.5 BCGTE(60Hz)/3.75 BCGTE(50Hz), 5.0 BCG(60Hz)/4.2 BCG(50Hz), 5.0 BCGA(60Hz)/5.2 BCGA(50Hz), 7.0 BCGB(60Hz)/6.0 BCGB(50Hz), 7.0 BCGC(60Hz)/5.9 BCGC(50Hz), 7.0 BCGD(60Hz)/5.8 BCGD(50Hz), 7.2 BCGTC(60Hz)/6.0 BCGTC(50Hz), 9.6 BCGTC(60Hz)/8.0 BCGTC(50Hz), 9.6 BCGTE(60Hz)/8.0 BCGTE(50Hz)



**23-4501
PLUG WIRE SET**

Replaces: *Westerbeke* 46596
Fits: 8.0 BEG(60Hz)/6.4 BEG(50Hz), 10.0 BEG(60Hz)/8.0 BEG(50Hz), 12.5 BEG(60Hz)/10.0 BEG(50Hz), 15.0 BEG(60Hz)/12.0 BEG(50Hz), 8.0 SBEG(60Hz) / 6.4 SBEG(50Hz), 10.0 SBEG(60Hz) / 8.0 SBEG(50Hz), 12.5 SBEG(60Hz) / 10.0 SBEG(50Hz), 14.0 SBEG(60Hz) / 11.6 SBEG(50Hz)



**23-2800
ROTOR**

Replaces: *Westerbeke* 34093
Fits: 6.5 TWG(60Hz)/4.9 TWG(50Hz), 8.0 TWG(60Hz)/6.4 TWG(50Hz), 8.5 BTG(60Hz)/6.5 BTG(50Hz), 11.0 TWG(60Hz)/8.5 TWG(50Hz), 12.5 BTG(60Hz)/10.0 BTG(50Hz), 15.0 BTG/A(60Hz)/12.0 BTG/A(50Hz)



**23-2801
ROTOR**

Replaces: *Westerbeke* 35610
Fits: 4.0 BCG(60Hz)/3.0 BCG(50Hz)



**23-2802
ROTOR**

Replaces: *Westerbeke* 40860
Fits: 20.0 BEG(60Hz)/16.0 BEG(50Hz), 25.0 BEG(60Hz)/20.0 BEG(50Hz), 20.0 SBEG(60Hz) / 16.0 SBEG(50Hz), 20.0 SBEGA(60Hz) / 16.0 SBEGA(50Hz), 22.5 SBEG(60Hz) / 18.7 SBEG(50Hz), 22.5 SBEGA(60Hz) / 18.7 SBEGA(50Hz)



**23-2803
ROTOR**

Replaces: *Westerbeke* 43050
Fits: 4.5 BCGB(60Hz)/3.75 BCGB(50Hz), 4.5 BCGTC(60Hz)/3.75 BCGTC(50Hz), 5.0 BCG(60Hz)/4.2 BCG(50Hz), 5.0 BCGA(60Hz)/5.2 BCGA(50Hz), 7.0 BCGB(60Hz)/6.0 BCGB(50Hz), 7.0 BCGC(60Hz)/5.9 BCGC(50Hz), 7.2 BCGTC(60Hz)/6.0 BCGTC(50Hz), 8.0 BEG(60Hz)/6.4 BEG(50Hz), 9.6 BCGTC(60Hz)/8.0 BCGTC(50Hz), 10.0 BEG(60Hz)/8.0 BEG(50Hz), 12.5 BEG(60Hz)/10.0 BEG(50Hz), 15.0 BEG(60Hz)/12.0 BEG(50Hz), 5.0 SBCG(60Hz) / 4.0 SBEG(50Hz), 6.5 SBCG(60Hz) / 5.4 SBCG(50Hz), 8.0 SBEG(60Hz) / 6.4 SBEG(50Hz), 10.0 SBEG(60Hz) / 8.0 SBEG(50Hz), 12.5 SBEG(60Hz) / 10.0 SBEG(50Hz), 14.0 SBEG(60Hz) / 11.6 SBEG(50Hz)



**23-2804
ROTOR**

Replaces: *Westerbeke* 42201
Fits: 4.5 BCG(60Hz)/3.75 BCG(50Hz), 7.0 BCG(60Hz)/5.0 BCG(50Hz), 7.0 BCGA(60Hz)/5.0 BCGA(50Hz), 9.0 BTG(60Hz)/7.0 BTG(50Hz), 6.5 BCG(60Hz)/4.8 BCG(50Hz)



**23-7800
OIL FILTER**

Replaces: *Westerbeke* 36918
Fits: several models. See application chart on page 120-131



**23-7801
OIL FILTER**

Replaces: *Westerbeke* 35595
Nothern Lights 24-0200
Fits: 4.0 BCG(60Hz)/3.0 BCG(50Hz), 6.5 BCG(60Hz)/4.8 BCG(50Hz), 9.0 BTG(60Hz)/7.0 BTG(50Hz), M753, M753G, M753K, M753W, M753W2, M773, LW2



**23-7802
OIL FILTER**

Replaces: *Westerbeke* 48078
Fits: 3.0 BPMG (60Hz)



**23-7803
OIL FILTER**

Replaces: *Kohler* 326817
Fits: 8E, 10E, 12.5E



**23-7804
OIL FILTER**

Replaces: *Onan* 185-7444
(Fits: MDKAU, MDKBH)
Fischer Panda 15853-99170
Fits: PMS 8 MINI, PMS 8 DP, PMS 4200, PMS 6500, PMS 12 DP, PMS 12 Mini



**23-7820
OIL FILTER**

Replaces: *Kohler* 279449
Fits: 12.5CF, 15C, 16CF, 20C



23-7821
OIL FILTER
Replaces: Kohler 359771
Fits: 4EF, 5E, 6EF, 7.3E



23-7822
OIL FILTER
Replaces: Kohler 229678
Fits: 4 CCOFZ, 4 EFOZ, 5 CCOZ, 5 EOZ, 6.5 EFOZ, 8 EOZ



23-7823
OIL FILTER
Replaces: Kohler 267714
Fits: 3.5 CFZ, 3.5 EFZ, 4 CZ, 4 ESZ, 5 CFZ, 5 EFZ, 6.5 CZ, 6.5 ESZ



23-7824
OIL FILTER
Replaces: Kohler GM47465
Fits: 7 EFOZD(Var 1), 8.5 EFOZD(Var 1), 9 EOZD(Var 1), 9 EFOZD (Var 1), 10 EOZD(Var 1), 11 EFOZD, 11.5 EFOZD, 13 EOZD, 13 EFOZD, 14 EOZD, 15.5 EOZD, 17 EFOZD, 17.5 EFOZD, 19 EFOZD, 20 EOZD, 20 EFOZD, 23 EOZD, 24 EOZD



23-7825
OIL FILTER
Replaces: Westerbeke 35828
Fits: 11.0 BTD(60Hz) / 8.3 BTD(50Hz), 12.5 BTD(60Hz) / 9.4 BTD(50Hz), 12.5 BTDA(60Hz) / 9.4 BTDA(50Hz), 12.5 WMD(60Hz) / 9.4 WMD(50Hz), 15.0 BTD(60Hz) / 12.0 BTD(50Hz), 15.0 BTDA(60Hz) / 12.0 BTDA(50Hz), 15.0 BTDB(60Hz) / 12.0 BTDB(50Hz)



23-7826
OIL FILTER
Replaces: Westerbeke 40154
Fits: 20.0 BED(60Hz) / 16.0 BED(50Hz), 20.0 BEDA(60Hz) / 16.0 BEDA(50Hz), 25.0 BED(60Hz) / 20.0 BED(50Hz), 25.0 WTA(60Hz) / 20.0 WTA(50Hz), 32.0 BED(60Hz) / 25.0 BED(50Hz), 32.0 BEDA(60Hz) / 25.0 BEDA(50Hz)



23-7840
OIL FILTER
Replaces: Onan 122-0810
Fits: MDKBD, MDKBE, MDKBF, MDKBD (w/ Isolated Ground), MDKBE (w/ Isolated Ground), MDKBF (w/ Isolated Ground), MDKAD/E/F



23-7841
OIL FILTER
Replaces: Onan 122-0185
Fits: MDJB, MDJC, MDJE, MDJF, MJA, MJB, MJC



23-7842
OIL FILTER
Replaces: Onan 185-5835
Fits: MDKAV, MDKBG, MDKAW (Spacesaver), MDKAZ, MDKAL/A/B, MDKKB, MDKBL, MDKBM, MDKBN

As with Marine Engines, Generators require routine maintenance and changing of engine oil is critical to maintaining and extending their useful life. With the addition of many oil filters for the Marine Generator market, Sierra offers several grades of oil for the gasoline and diesel Generator applications. These oils are specifically formulated for the Marine Industry to provide excellent lubrication and corrosion protection. All of these oils are backed by Sierra's **Industry Leading Warranty**.

Part#	Description	Qty	Case Qty
18-9420-2	10W30 4-Stroke	Qt.	12
18-9400-2	25W40 4-Stroke	Qt.	12
18-9553-2	15W40 Diesel Oil	Qt.	12
18-9410-2	SAE 30 Full Syn.	Qt.	12



56966P
HOURLMETER
Round



56967P
HOURLMETER
Rectangular





23-6400

ANODE

Replaces:

Westerbeke 11885, Kohler 260085
Fits several models. See application chart on page 120-131



23-6401

ANODE

Replaces: Onan 130-4434

Fits: MDKAV, MDKBG, MDKAW (Spacesaver), MDKAZ, MDKBD, MDKBE, MDKBF, MDKBD (w/ Isolated Ground), MDKBE (w/ Isolated Ground), MDKBF (w/ Isolated Ground), MDKBH, MDKBK, MDKBL, MDKBM, MDKBN, MDKBP, MDKBR, MDKBS, MDKBV, MDKBT, MDKBU



23-6402

ANODE

Replaces: Onan 130-6228

Fits: MDDCA, MDDCB, MDDCC, MDDCF, MDDCG, MDDCD, MDDCE, MDDCH, MDDCJ

23-5800

SOLENOID

Replaces: Westerbeke 24639

Fits: 3.0 WMD(60Hz)/2.4 WMD(50Hz), 4.0 BCD(60Hz), 4.4 BCD(60Hz), 4.4 WMD(60Hz) / 3.3 WMD(50Hz), 5.0 BCD/BCDA/BCDB(60Hz) / 4.0 BCD/BCDA/BCDB(50Hz), 6.0 BCD(60Hz) / 4.5 BCD(50Hz), 7.6 BTD(60Hz) / 5.7 BTD(50Hz), 7.7 WMD(60Hz) / 5.8 WMD(50Hz), 8.0 BTD(60Hz) / 6.0 BTD(50Hz), 8.0 BTDA(60Hz) / 6.0 BTDA(50Hz), 8.0 WMD(60Hz) / 6.0 WMD(50Hz), 10.0 BTD(60Hz) / 7.5 BTD(50Hz), 10.0 BTDA(60Hz) / 7.5 BTDA(50Hz), 11.0 BTD(60Hz) / 8.3 BTD(50Hz), 11.0 WMD(60Hz) / 8.3 WMD(50Hz), 12.5 BTD(60Hz) / 9.4 BTD(50Hz), 12.5 BTDA(60Hz) / 9.4 BTDA(50Hz), 12.5 BTDB(60Hz) / 9.4 BTDB(50Hz), 12.5 WMD(60Hz) / 9.4 WMD(50Hz), 15.0 BTD(60Hz) / 12.0 BTD(50Hz), 15.0 BTDA(60Hz) / 12.0 BTDA(50Hz), 15.0 BTDB(60Hz) / 12.0 BTDB(50Hz), 15.0 BTDC(60Hz) / 12.0 BTDC(50Hz), 15.0 WTA(60Hz) / 12.0 WTA(50Hz), 20.0 BED(60Hz) / 16.0 BED(50Hz), 20.0 BEDA(60Hz) / 16.0 BEDA(50Hz), 20.0 WTA(60Hz) / 16.0 WTA(50Hz), 25.0 BED(60Hz) / 20.0 BED(50Hz), 25.0 WTA(60Hz) / 20.0 WTA(50Hz), 32.0 BED(60Hz) / 25.0 BED(50Hz), 32.0 BEDA(60Hz) / 25.0 BEDA(50Hz), 32.0 BEDB(60Hz) / 25.0 BEDB(50Hz), 32.0 WTF(60Hz) / 25.0 WTF(50Hz)



23-5900

ALTERNATOR (50 AMP)

Replaces: Westerbeke 30594

Fits: 4.4 BCD(60Hz), 4.4 WMD(60Hz)/3.3 WMD(50Hz), 6.0 BCD(60Hz)/4.5 BCD(50Hz), 7.7 WMD(60Hz)/5.8 WMD(50Hz), 8.0 BTD(60Hz)/6.0 BTD(50Hz), 8.0 WMD(60Hz)/6.0 WMD(50Hz), 10.0 BTD(60Hz)/7.5 BTD(50Hz), 11.0 BTD(60Hz)/8.3 BTD(50Hz), 12.5 BTD(60Hz)/9.4 BTD(50Hz), 12.5 BTDA(60Hz)/9.4 BTDA(50Hz), 12.5 WMD(60Hz)/9.4 WMD(50Hz), 15.0 BTD(60Hz)/12.0 BTD(50Hz)

23-4000

ALTERNATOR BELT

Replaces: Westerbeke 39181

Fits: 20.0 BED(60Hz) / 16.0 BED(50Hz), 20.0 BEDA(60Hz) / 16.0 BEDA(50Hz), 25.0 BED(60Hz) / 20.0 BED(50Hz)



23-4001

ALTERNATOR BELT

Replaces: Westerbeke 11672

Fits: 15.0 BTDA(60Hz) / 12.0 BTDA(50Hz), 15.0 BTDB(60Hz) / 12.0 BTDB(50Hz), 20.0 WTA(60Hz) / 16.0 WTA(50Hz)



23-4002

ALTERNATOR BELT

Replaces: Westerbeke 30592

Fits: 6.5 TWG(60Hz)/4.9 TWG(50Hz), 8.0 TWG(60Hz)/6.4 TWG(50Hz), 11.0 TWG(60Hz)/8.5 TWG(50Hz), 6.0 BCD(60Hz) / 4.5 BCD(50Hz), 7.7 WMD(60Hz) / 5.8 WMD(50Hz), 8.0 WMD(60Hz) / 6.0 WMD(50Hz), 11.0 BTD(60Hz) / 8.3 BTD(50Hz)



23-4003

ALTERNATOR BELT

Replaces: Westerbeke 45232

Fits: 7.6 BTD(60Hz) / 5.7 BTD(50Hz), 8.0 BTDA(60Hz) / 6.0 BTDA(50Hz), 10.0 BTDA(60Hz) / 7.5 BTDA(50Hz), 12.5 BTDB(60Hz) / 9.4 BTDB(50Hz), 15.0 BTDC(60Hz) / 12.0 BTDC(50Hz)



23-4004

ALTERNATOR BELT

Replaces: Westerbeke 30475

Fits: 12.5 BTG(60Hz)/10.0 BTG(50Hz), 15.0 BTG/A(60Hz)/12.0 BTG/A(50Hz), 8.0 BTD(60Hz) / 6.0 BTD(50Hz), 10.0 BTD(60Hz) / 7.5 BTD(50Hz), 12.5 BTD(60Hz) / 9.4 BTD(50Hz), 12.5 BTDA(60Hz) / 9.4 BTDA(50Hz), 12.5 WMD(60Hz) / 9.4 WMD(50Hz), 15.0 BTD(60Hz) / 12.0 BTD(50Hz)



23-5600

STARTER

Replaces: Westerbeke 30593

Fits: 4.4 WMD(60Hz)/3.3 WMD(50Hz), 7.7 WMD(60Hz)/5.8 WMD(50Hz), 8.0 BTDA(60Hz)/6.0 BTDA(50Hz), 8.0 WMD(60Hz)/6.0 WMD(50Hz), 10.0 BTDA(60Hz)/7.5 BTDA(50Hz), 11.0 BTD(60Hz)/8.3 BTD(50Hz), 11.0 WMD(60Hz)/8.3 WMD(50Hz), 12.5 BTD(60Hz)/9.4 BTD(50Hz), 12.5 BTDA(60Hz)/9.4 BTDA(50Hz), 12.5 BTDB(60Hz)/9.4 BTDB(50Hz), 12.5 WMD(60Hz)/9.4 WMD(50Hz), 12.6 BTD(60Hz)/10.4 BTD(50Hz), 15.0 BTD(60Hz)/12.0 BTD(50Hz), 15.0 BTDA(60Hz)/12.0 BTDA(50Hz), 15.0 BTDB(60Hz) / 12.0 BTDB(50Hz), 15.0 BTDC(60Hz)/12.0 BTDC(50Hz)





Sierra
Marine Engine and Drive Parts

GENERATOR PARTS

Sierra offers over 100 products focused entirely on servicing the generator market. Applications cover all applicable product categories with a focus on Kohler®, Onan® & Westerbeke® Generator Sets.

Like all Sierra products, quality is insured by our industry leading Limited Lifetime Warranty.



THE VERY BEST PARTS OF BOATING

Model	OEM	Starter	Alternator	Fuel Filter	Impeller	Impeller Kit	Thermostat
3.0 WMD(60Hz)/2.4 WMD(50Hz)	Westerbeke	—	—	23-7770	23-2001	23-3305	23-3600
3.8/4.2 BCDT(60Hz) / 3.5 BCDT(50Hz)	Westerbeke	—	—	—	23-2001	23-3305	—
4.0 BCD(60Hz)	Westerbeke	—	—	23-7770	—	23-3307	—
4.4 BCD(60Hz)	Westerbeke	—	23-5900	—	23-2001	23-3307	23-3600
4.4 WMD(60Hz) / 3.3 WMD(50Hz)	Westerbeke	23-5600	23-5900	23-7770	—	23-3307	23-3600
5.0 BCD/BCDA/BCDB(60Hz) / 4.0 BCD/BCDA/BCDB(50Hz)	Westerbeke	—	—	23-7770	—	23-3307	—
5.0 BCDR(60Hz) / 4.0 BCDR(50Hz)	Westerbeke	—	—	—	—	—	—
6.0 BCD(60Hz) / 4.5 BCD(50Hz)	Westerbeke	—	23-5900	23-7770	—	23-3307	23-3600
7.6 BTD(60Hz) / 5.7 BTD(50Hz)	Westerbeke	—	—	23-7770	—	23-3307	—
7.7 WMD(60Hz) / 5.8 WMD(50Hz)	Westerbeke	23-5600	23-5900	23-7770	—	23-3307	23-3600
8.0 BTD(60Hz) / 6.0 BTD(50Hz)	Westerbeke	—	23-5900	23-7770	—	23-3307	23-3600
8.0 BTDA(60Hz) / 6.0 BTDA(50Hz)	Westerbeke	23-5600	—	23-7770	23-3307 (Before March 2004)	23-3307	23-3600
8.0 BCDT(60Hz) / 7.0 BCDT(50Hz)	Westerbeke	—	—	23-7770	—	—	—
8.0 WMD(60Hz) / 6.0 WMD(50Hz)	Westerbeke	23-5600	23-5900	23-7770	—	23-3307	23-3600
10.0 BTD(60Hz) / 7.5 BTD(50Hz)	Westerbeke	—	23-5900	23-7770	—	23-3307	23-3600
10.0 BTDA(60Hz) / 7.5 BTDA(50Hz)	Westerbeke	23-5600	—	23-7770	—	23-3307	23-3600
11.0 BTD(60Hz) / 8.3 BTD(50Hz)	Westerbeke	23-5600	23-5900	23-7770	—	23-3307	23-3600
11.0 WMD(60Hz) / 8.3 WMD(50Hz)	Westerbeke	23-5600	—	23-7770	—	23-3307	23-3600
12.5 BTD(60Hz) / 9.4 BTD(50Hz)	Westerbeke	23-5600	23-5900	23-7770	—	23-3307	23-3600
12.5 BTDA(60Hz) / 9.4 BTDA(50Hz)	Westerbeke	23-5600	23-5900	23-7770	—	23-3307	23-3600
12.5 BTDB(60Hz) / 9.4 BTDB(50Hz)	Westerbeke	23-5600	—	23-7770	—	23-3307	23-3600
12.5 WMD(60Hz) / 9.4 WMD(50Hz)	Westerbeke	23-5600	23-5900	23-7770	—	23-3307	23-3600
12.6 BTD(60Hz) / 10.4 BTD(50Hz)	Westerbeke	23-5600	—	23-7770	—	—	23-3600
15.0 BTD(60Hz) / 12.0 BTD(50Hz)	Westerbeke	23-5600	23-5900	23-7764	—	23-3313	23-3600
15.0 BTDA(60Hz) / 12.0 BTDA(50Hz)	Westerbeke	23-5600	—	23-7764	—	23-3313	23-3605
15.0 BTDB(60Hz) / 12.0 BTDB(50Hz)	Westerbeke	23-5600	—	23-7764	—	23-3313	23-3605
15.0 BTDC(60Hz) / 12.0 BTDC(50Hz)	Westerbeke	23-5600	—	23-7770	—	23-3307	23-3600
15.0 WTA(60Hz) / 12.0 WTA(50Hz)	Westerbeke	—	—	23-7764	—	23-3313	23-3605
20.0 BED(60Hz) / 16.0 BED(50Hz)	Westerbeke	—	—	23-7764	—	23-3301	23-3605
20.0 BEDA(60Hz) / 16.0 BEDA(50Hz)	Westerbeke	—	—	23-7764	—	23-3301	23-3605
20.0 WTA(60Hz) / 16.0 WTA(50Hz)	Westerbeke	—	—	23-7764	23-2000	23-3302	23-3605
25.0 BED(60Hz) / 20.0 BED(50Hz)	Westerbeke	—	—	23-7764	—	23-3301	23-3605
25.0 WTA(60Hz) / 20.0 WTA(50Hz)	Westerbeke	—	—	23-7764	—	23-3301	23-3605
32.0 BED(60Hz) / 25.0 BED(50Hz)	Westerbeke	—	—	23-7764	—	23-3301	—
32.0 BEDA(60Hz) / 25.0 BEDA(50Hz)	Westerbeke	—	—	23-7764	—	23-3301	23-3605
32.0 BEDB(60Hz) / 25.0 BEDB(50Hz)	Westerbeke	—	—	—	—	23-3301	—
32.0 WTF(60Hz) / 25.0 WTF(50Hz)	Westerbeke	—	—	23-7764	—	23-3301	—
3.0 BPMG (60Hz)	Westerbeke	—	—	23-7770	—	—	—
4.0 BCG(60Hz)/3.0 BCG(50Hz)	Westerbeke	—	—	23-7720	23-2001	23-3305	23-3601
4.5 BCG(60Hz)/3.75 BCG(50Hz)	Westerbeke	—	—	—	23-2001	23-3305	23-3602

Thermostat Kit	Oil Filter	Air Filter	Thermostat Gasket	Anode	Carburetor Kit	Glow Plug	Temperature Sender	Oil Pressure Sender	Solenoid
—	23-7800	—	—	23-6400	—	—	23-5840	23-5880	23-5800
—	—	—	—	—	—	—	—	—	—
—	23-7800	—	—	—	—	—	23-5840	23-5880	23-5800
23-3650	23-7800	—	23-0806	23-6400	—	23-1000	23-5840	23-5880	23-5800
23-3650	23-7800	—	23-0806	23-6400	—	23-1000	23-5840	23-5880	23-5800
—	23-7800	—	—	23-6400	—	—	23-5840	23-5880	23-5800
—	23-7800	—	—	—	—	—	—	—	—
—	23-7800	—	23-0802	23-6400	—	23-1000	23-5840	23-5880	23-5800
—	23-7800	—	—	—	—	—	—	23-5880	23-5800
23-3650	23-7800	—	23-0806	—	—	23-1000	23-5840	23-5880	23-5800
23-3653	23-7800	—	23-0802	—	—	23-1000	23-5840	23-5880	23-5800
—	23-7800	23-1101	—	—	—	23-1000	23-5840	23-5880	23-5800
—	23-7800	—	—	23-6400	—	—	—	—	—
23-3650	23-7800	—	23-0806	—	—	23-1000	23-5840	23-5880	23-5800
23-3653	23-7800	—	23-0802	23-6400	—	23-1000	23-5840	23-5880	23-5800
—	23-7800	23-1101	—	—	—	23-1000	23-5840	23-5880	23-5800
23-3653	23-7825	—	23-0802	—	—	23-1000	23-5840	23-5880	23-5800
23-3650	23-7800	—	23-0806	23-6400	—	23-1000	23-5840	23-5880	23-5800
23-3653	23-7825	—	23-0802	—	—	23-1000	23-5840	23-5880	23-5800
23-3653	23-7825	—	23-0802	—	—	23-1000	23-5840	23-5880	23-5800
—	23-7800	23-1101	—	—	—	23-1000	23-5840	23-5880	23-5800
23-3650	23-7825	—	23-0806	—	—	23-1000	23-5840	23-5880	23-5800
23-3653	23-7800	23-1101	23-0802	23-6400	—	—	—	—	—
23-3658	23-7825	—	23-0807	—	—	23-1000	23-5840	—	23-5800
23-3660	23-7825	—	23-0804	—	—	23-1000	23-5840	—	23-5800
23-3660	23-7825	—	23-0804	—	—	23-1000	23-5840	—	23-5800
—	23-7800	23-1101	—	—	—	23-1000	23-5840	—	23-5800
23-3660	—	—	23-0804	—	—	23-1000	23-5840	—	23-5800
23-3660	23-7826	—	23-0804	—	—	23-1000	23-5840	—	23-5800
23-3660	23-7826	—	23-0804	—	—	23-1000	23-5840	—	23-5800
23-3660	—	—	23-0804	—	—	23-1000	23-5840	—	23-5800
23-3660	23-7826	—	23-0804	—	—	23-1000	23-5840	—	23-5800
23-3660	23-7826	—	23-0804	—	—	23-1000	23-5840	—	23-5800
—	23-7826	—	—	—	—	23-1000	23-5840	—	23-5800
—	23-7826	—	—	—	—	—	23-5840	—	23-5800
—	23-7826	—	—	—	—	23-1000	23-5840	—	23-5800
—	23-7826	—	—	—	—	23-1000	23-5840	—	23-5800
—	23-7802	—	—	—	—	—	—	—	—
23-3651	23-7801	—	23-0802	23-6400	23-7201	—	23-5840	—	—
23-3659	23-7800	—	23-0808	23-6400	23-7201	—	23-5840	—	—

Model	OEM	Starter	Alternator	Fuel Filter	Impeller	Impeller Kit	Thermostat
4.5 BCGB(60Hz)/3.75 BCGB(50Hz)	Westerbeke	—	—	—	23-2001	23-3305	23-3603
4.5 BCGTC(60Hz)/3.75 BCGTC(50Hz)	Westerbeke	—	—	—	23-2001	23-3305	23-3603
4.5 BCGTE(60Hz) / 3.75 BCGTE(50Hz)	Westerbeke						
5.0 BCG(60Hz)/4.2 BCG(50Hz)	Westerbeke	—	—	23-7770	23-2001	23-3306	23-3603
5.0 BCGA(60Hz)/5.2 BCGA(50Hz)	Westerbeke	—	—	23-7770	23-2001	23-3306	23-3603
6.5 BCG(60Hz)/4.8 BCG(50Hz)	Westerbeke	—	—	23-7720	23-2001	23-3305	23-3601
6.5 TWG(60Hz)/4.9 TWG(50Hz)	Westerbeke	—	—	23-7720	23-2000	23-3302	23-3601
7.0 BCG(60Hz)/5.0 BCG(50Hz)	Westerbeke	—	—	—	23-2001	23-3305	23-3602
7.0 BCGA(60Hz)/5.0 BCGA(50Hz)	Westerbeke	—	—	—	23-2001	23-3305	23-3602
7.0 BCGB(60Hz)/6.0 BCGB(50Hz)	Westerbeke	—	—	—	23-2001	23-3305	23-3603
7.0 BCGC(60Hz)/5.9 BCGC(50Hz)	Westerbeke	—	—	23-7770	23-2001	23-3306	23-3603
7.0 BCGD(60Hz) / 5.8 BCGD(50Hz)	Westerbeke			23-7770	23-2001	23-3306	—
7.2 BCGTC(60Hz)/6.0 BCGTC(50Hz)	Westerbeke	—	—	23-7770	23-2001	23-3305	23-3603
8.0 BEG(60Hz)/6.4 BEG(50Hz)	Westerbeke	—	—	23-7770	23-2001	23-3306	23-3605
8.0 TWG(60Hz)/6.4 TWG(50Hz)	Westerbeke	—	—	23-7720	23-2000	23-3302	23-3601
8.5 BTG(60Hz)/6.5 BTG(50Hz)	Westerbeke	—	—	—	23-2000	23-3302	23-3601
8.5 BTGA(60Hz) / 6.8 BTGA(50Hz)	Westerbeke				23-2000	23-3302	23-3601
9.0 BTG(60Hz)/7.0 BTG(50Hz)	Westerbeke	—	—	23-7720	23-2001	23-3305	23-3601
9.6 BCGTC(60Hz)/8.0 BCGTC(50Hz)	Westerbeke	—	—	—	23-2001	23-3305	23-3603
10.0 BEG(60Hz)/8.0 BEG(50Hz)	Westerbeke	—	—	23-7770	23-2001	23-3306	23-3605
11.0 TWG(60Hz)/8.5 TWG(50Hz)	Westerbeke	—	—	23-7720	23-2000	23-3302	23-3601
12.5 BEG(60Hz)/10.0 BEG(50Hz)	Westerbeke	—	—	23-7770	23-2001	23-3306	23-3605
12.5 BTG(60Hz)/10.0 BTG(50Hz)	Westerbeke	—	—	—	23-2000	23-3302	23-3601
15.0 BEG(60Hz)/12.0 BEG(50Hz)	Westerbeke	—	—	23-7770	23-2001	23-3306	23-3605
15.0 BTG/A(60Hz)/12.0 BTG/A(50Hz)	Westerbeke	—	—	—	23-2000	23-3302	23-3601
20.0 BEG(60Hz)/16.0 BEG(50Hz)	Westerbeke	—	—	—	—	23-3301	23-3601
25.0 BEG(60Hz)/20.0 BEG(50Hz)	Westerbeke	—	—	—	—	23-3301	23-3601
5.0 SBCG(60Hz) / 4.0 SBCG(50Hz)	Westerbeke	—	—	23-7770	23-2001	23-3306	23-3603
6.5 SBCG(60Hz) / 5.4 SBCG(50Hz)	Westerbeke	—	—	23-7770	23-2001	23-3306	23-3603
8.0 SBEG(60Hz) / 6.4 SBEG(50Hz)	Westerbeke	—	—	23-7770	23-2001	23-3306	23-3605
10.0 SBEG(60Hz) / 8.0 SBEG(50Hz)	Westerbeke	—	—	23-7770	23-2001	23-3306	23-3605
12.5 SBEG(60Hz) / 10.0 SBEG(50Hz)	Westerbeke	—	—	23-7770	23-2001	23-3306	23-3605
14.0 SBEG(60Hz) / 11.6 SBEG(50Hz)	Westerbeke	—	—	23-7770	23-2001	23-3306	23-3605
18.0 SBEG	Westerbeke						
18.0 SBEGA	Westerbeke						
20.0 SBEG(60Hz) / 16.0 SBEG(50Hz)	Westerbeke	—	—	23-7770	—	23-3301	23-3600
20.0 SBEGA(60Hz) / 16.0 SBEGA(50Hz)	Westerbeke	—	—	23-7770	—	23-3301	23-3600
22.5 SBEG(60Hz) / 18.7 SBEG(50Hz)	Westerbeke	—	—	23-7770	—	23-3301	23-3600
22.5 SBEGA(60Hz) / 18.7 SBEGA(50Hz)	Westerbeke	—	—	23-7770	—	23-3301	23-3600
5.5 EDC(60Hz) / 5.0 EDC(50Hz)	Westerbeke	—	—	23-7770	—	—	—

Thermostat Kit	Oil Filter	Air Filter	Thermostat Gasket	Anode	Carburetor Kit	Glow Plug	Temperature Sender	Oil Pressure Sender	Solenoid
23-3654	23-7800	—	23-0800	23-6400	23-7201	—	—	—	—
23-3654	23-7800	—	23-0800	23-6400	23-7201	—	—	—	—
	23-7800								
23-3655	23-7800	—	23-0801	23-6400	23-7201	—	—	—	—
23-3655	23-7800	—	23-0801	23-6400	—	—	—	—	—
23-3651	23-7801	—	23-0802	23-6400	23-7201	—	23-5840	—	—
23-3652	23-7800	—	23-0803	23-6400	23-7200	—	23-5840	—	—
23-3659	23-7800	—	23-0808	23-6400	23-7201	—	23-5840	—	—
23-3659	23-7800	—	23-0808	23-6400	23-7201	—	23-5840	—	—
23-3654	23-7800	—	23-0800	23-6400	23-7201	—	—	—	—
23-3655	23-7800	—	23-0801	23-6400	—	—	—	—	—
—	23-7800	—	—	23-6400	—	—	—	—	—
23-3654	23-7800	—	23-0800	23-6400	23-7201	—	—	—	—
23-3656	23-7800	—	23-0803	23-6400	23-7201	—	23-5840	23-5880	—
23-3651	23-7800	—	23-0802	23-6400	23-7200	—	23-5840	—	—
23-3652	23-7800	—	23-0803	23-6400	23-7200	—	23-5840	23-5880	—
—	23-7800	—	—	23-6400	23-7200	—	—	—	—
23-3651	23-7801	—	23-0802	23-6400	—	—	23-5840	—	—
23-3654	23-7800	—	23-0800	23-6400	23-7201	—	—	—	—
23-3656	23-7800	—	23-0803	23-6400	23-7201	—	23-5840	23-5880	—
23-3651	23-7800	—	23-0802	23-6400	—	—	23-5840	—	—
23-3656	23-7800	—	23-0803	23-6400	23-7201	—	23-5840	23-5880	—
23-3652	23-7800	—	23-0803	23-6400	23-7200	—	23-5840	23-5880	—
23-3656	23-7800	—	23-0803	23-6400	23-7201	—	23-5840	23-5880	—
23-3652	23-7800	—	23-0803	23-6400	23-7200	—	23-5840	23-5880	—
23-3661	23-7800	—	23-0805	23-6400	23-7200	—	23-5840	23-5880	—
23-3661	23-7800	—	23-0805	23-6400	23-7200	—	23-5840	23-5880	—
23-3655	23-7800	—	23-0801	23-6400	—	—	—	—	—
23-3655	23-7800	—	23-0801	23-6400	—	—	—	—	—
23-3657	23-7800	—	23-0803	23-6400	—	—	—	—	—
23-3657	23-7800	—	23-0803	23-6400	—	—	—	—	—
23-3657	23-7800	—	23-0803	23-6400	—	—	—	—	—
23-3657	23-7800	—	23-0803	23-6400	—	—	—	—	—
	23-7800								
	23-7800								
23-3662	23-7800	—	23-0805	23-6400	—	—	—	—	—
23-3662	23-7800	—	23-0805	23-6400	—	—	—	—	—
23-3662	23-7800	—	23-0805	23-6400	—	—	—	—	—
23-3662	23-7800	—	23-0805	23-6400	—	—	—	—	—
—	23-7800	—	—	23-6400	—	—	—	—	—

Model	OEM	Starter	Alternator	Fuel Filter	Impeller	Impeller Kit	Thermostat
7.6 EDT(60Hz) / 5.7 EDT(50Hz)	Westerbeke	—	—	23-7770	—	—	—
8.0 EDT(60Hz) / 6.0 EDT(50Hz)	Westerbeke	—	—	23-7770	—	—	—
10.0 EDT(60Hz) / 7.5 EDT(50Hz)	Westerbeke	—	—	23-7770	—	—	—
11.5 EDT(60Hz) / 9.2 EDT(50Hz)	Westerbeke	—	—	23-7770	—	—	—
12.5 EDT(60Hz) / 9.4 EDT(50Hz)	Westerbeke	—	—	23-7770	—	—	—
12.6 EDT(60Hz) / 10.4 EDT(50Hz)	Westerbeke	—	—	23-7770	—	—	—
15.0 EDT(60Hz) / 12.0 EDT(50Hz)	Westerbeke	—	—	23-7770	—	—	—
4 CCFOZ	Kohler	—	—	23-7751	23-2002(SN 296899 & Up) 23-2003(SN 296898 & below)	23-3303(SN 296899 & Up) 23-3304(SN 296898 & below)	—
4EFOZ	Kohler	—	—	23-7751	23-2002(SN 296899 & Up) 23-2003(SN 296898 & below)	23-3303(SN 296899 & Up) 23-3304(SN 296898 & below)	—
5 CCOZ	Kohler	—	—	23-7751	23-2002(SN 296899 & Up) 23-2003(SN 296898 & below)	23-3303(SN 296899 & Up) 23-3304(SN 296898 & below)	—
5EOZ	Kohler	—	—	23-7751	23-2002(SN 296899 & Up) 23-2003(SN 296898 & below)	23-3303(SN 296899 & Up) 23-3304(SN 296898 & below)	—
6.5 EFOZ	Kohler	—	—	23-7751	23-2002(SN 296899 & Up) 23-2003(SN 296898 & below)	23-3303(SN 296899 & Up) 23-3304(SN 296898 & below)	—
8EOZ	Kohler	—	—	23-7751	23-2002(SN 296899 & Up) 23-2003(SN 296898 & below)	23-3303(SN 296899 & Up) 23-3304(SN 296898 & below)	—
8EFOZ	Kohler	—	—	—	23-2002(SN 296899 & Up) 23-2003(SN 296898 & below)	23-3303(SN 296899 & Up) 23-3304(SN 296898 & below)	—
8CCFOZ	Kohler	—	—	—	23-2002(SN 296899 & Up) 23-2003(SN 296898 & below)	23-3303(SN 296899 & Up) 23-3304(SN 296898 & below)	—
9CCOZ	Kohler	—	—	—	23-2002(SN 296899 & Up) 23-2003(SN 296898 & below)	23-3303(SN 296899 & Up) 23-3304(SN 296898 & below)	—
9EOZ	Kohler	—	—	—	23-2002(SN 296899 & Up) 23-2003(SN 296898 & below)	23-3303(SN 296899 & Up) 23-3304(SN 296898 & below)	—
9EFOZ	Kohler	—	—	—	23-2002(SN 296899 & Up) 23-2003(SN 296898 & below)	23-3303(SN 296899 & Up) 23-3304(SN 296898 & below)	—
10EOZ	Kohler	—	—	—	23-2002(SN 296899 & Up) 23-2003(SN 296898 & below)	23-3303(SN 296899 & Up) 23-3304(SN 296898 & below)	—
11 CCFOZ	Kohler	—	—	23-7740(Var 2)	23-2003	23-3304	23-3609
11.5 CCFOZ	Kohler	—	—	23-7740(Var 2)	23-2003	23-3304	23-3609
11EFOZ	Kohler	—	—	23-7740(Var 2)	23-2003	23-3304	23-3609
11.5EFOZ	Kohler	—	—	23-7740(Var 2)	23-2003	23-3304	23-3609
13EOZ	Kohler	—	—	23-7740(Var 2)	23-2003	23-3304	23-3609
13EFOZ	Kohler	—	—	23-7740(Var 2)	23-2003	23-3304	23-3609
13.5 CCOZ	Kohler	—	—	23-7740(Var 2)	23-2003	23-3304	23-3609
14 CCOZ	Kohler	—	—	23-7740(Var 2)	23-2003	23-3304	23-3609
14 EOZ	Kohler	—	—	23-7740(Var 2)	23-2003	23-3304	23-3609
15 CCFOZ	Kohler	—	—	23-7740(Var 3)	23-2003	23-3304	23-3609
15.5EOZ	Kohler	—	—	23-7740(Var 2)	23-2003	23-3304	23-3609
16EFOZ	Kohler	—	—	23-7740(Var 3)	23-2003	23-3304	23-3609
17.5EFOZ	Kohler	—	—	23-7740(Var 3)	23-2003	23-3304	23-3609
18.5 CCOZ	Kohler	—	—	23-7740(Var 3)	23-2003	23-3304	23-3609
19EFOZ	Kohler	—	—	23-7740(Var 3)	23-2003	23-3304	23-3609
20 CCFOZ	Kohler	—	—	23-7740(Var 3)	23-2003	23-3304	23-3609

Model	OEM	Starter	Alternator	Fuel Filter	Impeller	Impeller Kit	Thermostat
20EOZ	Kohler	—	—	23-7740(Var 3)	23-2003	23-3304	23-3609
20EFOZ	Kohler	—	—	23-7740(Var 3)	23-2003	23-3304	23-3609
23EOZ	Kohler	—	—	23-7740(Var 3)	23-2003	23-3304	23-3609
24 CCOZ	Kohler	—	—	23-7740(Var 3)	23-2003	23-3304	23-3609
24EOZ	Kohler	—	—	23-7740(Var 3)	23-2003	23-3304	23-3609
6.5EFOZD	Kohler	—	—	23-7751	23-2002	23-3303	
7 EFOZD	Kohler	—	—	23-7761(Var 1)	23-2002	23-3303	—
8EOZD	Kohler	—	—	23-7751	23-2002	23-3303	—
8.5 EFOZD	Kohler	—	—	23-7761(Var 1)	23-2002	23-3303	—
9 EOZD	Kohler	—	—	23-7761(Var 1)	23-2002	23-3303	—
9EFOZD	Kohler	—	—	23-7761(Var 1)	23-2002	23-3303	—
10EOZD	Kohler	—	—	23-7761(Var 1)	23-2002	23-3303	—
11EFOZD	Kohler	—	—	23-7761(Var 1)	23-2003	23-3304	—
11.5EFOZD	Kohler	—	—	23-7761(Var 1)	23-2003	23-3304	—
13EOZD	Kohler	—	—	23-7761(Var 1)	23-2003	23-3304	—
13EFOZD	Kohler	—	—	23-7761(Var 1)	23-2003	23-3304	—
14 EOZD	Kohler	—	—	23-7761(Var 1)	23-2003	23-3304	—
15.5 EOZD	Kohler	—	—	23-7761(Var 1)	23-2003	23-3304	—
17 EFOZD	Kohler	—	—	23-7740(Var 3), 23-7761(Var 1)	23-2003	23-3304	—
17.5EFOZD	Kohler	—	—	23-7740(Var 3), 23-7761(Var 1)	23-2003	23-3304	—
19EFOZD	Kohler	—	—	23-7740(Var 3), 23-7761(Var 1)	23-2003	23-3304	—
20EOZD	Kohler	—	—	23-7740(Var 3), 23-7761(Var 1)	23-2003	23-3304	—
20EFOZD	Kohler	—	—	23-7740(Var 3), 23-7761(Var 1)	23-2003	23-3304	—
23EFOZ		—	—	—	23-2002	23-3303	—
23EOZD	Kohler	—	—	23-7740(Var 3), 23-7761(Var 1)	23-2003	23-3304	—
23EFOZD	Kohler	—	—	23-7761	23-2002	23-3303	—
24EOZD	Kohler	—	—	23-7740(Var 3), 23-7761(Var 1)	23-2003	23-3304	—
27EFOZ		—	—	—	23-2002	23-3303	—
27EFOZD	Kohler	—	—	23-7761	23-2002	23-3303	—
28EOZ		—	—	—	23-2002	23-3303	—
28EOZD	Kohler	—	—	23-7761	23-2002	23-3303	—
32EOZ		—	—	—	23-2002	23-3303	—
32EOZD	Kohler	—	—	23-7761	23-2002	23-3303	—
33EFOZ	Kohler	—	—	—	—	23-3308	—
33 CFOZ	Kohler	—	—	—	—	23-3308	23-3607
40 CFOZ	Kohler	—	—	—	—	23-3308	23-3607
40EOZ	Kohler	—	—	—	—	23-3308	—
40EFOZ	Kohler	—	—	—	—	23-3308	—
50 COZ	Kohler	—	—	—	—	23-3308	23-3607
50 CFOZ	Kohler	—	—	—	—	23-3308	23-3607
50EOZ	Kohler	—	—	—	—	23-3308	—
55EFOZ	Kohler	—	—	—	—	23-3308	—
65 COZ	Kohler	—	—	—	—	23-3308	23-3607
65EOZ	Kohler	—	—	—	—	23-3308	—
70EFOZ	Kohler	—	—	—	—	23-3308	—
80EOZ	Kohler	—	—	—	—	23-3308	—
80EFOZ	Kohler	—	—	—	—	23-3308	—
99EOZ	Kohler	—	—	—	—	23-3308	—
100EFOZ	Kohler	—	—	—	—	—	—
125EOZ	Kohler	—	—	—	—	—	—
125EFOZ	Kohler	—	—	—	—	—	—

Model	OEM	Starter	Alternator	Fuel Filter	Impeller	Impeller Kit	Thermostat
150EOZ	Kohler	—	—	—	—	—	—
3.5 CFZ	Kohler	—	—	23-7771(Var 2)	23-2003(SN 296898 & below)	—	23-3610
3.5 EFZ	Kohler	—	—	—	—	—	23-3610
4 CZ	Kohler	—	—	23-7771(Var 2)	23-2003(SN 296898 & below)	—	23-3610
4EF	Kohler	—	—	23-7762	23-2004	23-3314	23-3608
4EFCD	Kohler	—	—	—	—	—	—
4EFKD	Kohler	—	—	—	—	—	—
4 ESZ	Kohler	—	—	—	—	—	23-3610
5 CFZ	Kohler	—	—	23-7771(Var 2)	23-2003(SN 296898 & below)	—	23-3610
5ECD	Kohler	—	—	—	23-2004	23-3314	—
5 EFZ	Kohler	—	—	23-7762	—	—	23-3610
5EKD	Kohler	—	—	—	—	—	—
5E	Kohler	—	—	23-7762	23-2004	23-3314	23-3608
6EF	Kohler	—	—	23-7762	23-2004	23-3314	23-3608
6EFCD	Kohler	—	—	—	23-2004	23-3314	—
6EFKD	Kohler	—	—	—	—	—	—
6.5 CZ	Kohler	—	—	23-7771(Var 2)	23-2003(SN 296898 & below)	—	23-3610
6.5 ESZ	Kohler	—	—	23-7762	—	—	23-3610
7.3E	Kohler	—	—	23-7762	23-2004	23-3314	23-3608
7.3ECD	Kohler	—	—	—	23-2004	23-3314	—
7.3EKD	Kohler	—	—	—	—	—	—
8E	Kohler	—	—	23-7762(GR4 Ver), 23-7771(Var 2) Inline	23-2002 (296899 & Up), 23-2003 (296898 & below)	23-3303 (SN 296899 & Up), 23-3304 (SN 296898 & below)	23-3608
8EFKD	Kohler	—	—	—	—	—	—
9EFGD	Kohler	—	—	23-7780	—	—	—
10E	Kohler	—	—	23-7762(GR4 Ver), 23-7771(Var 2) Inline	23-2002 (296899 & Up), 23-2003 (296898 & below)	23-3303 (SN 296899 & Up), 23-3304 (SN 296898 & below)	23-3608
10EG	Kohler	—	—	23-7780	—	—	—
10EGD	Kohler	—	—	23-7780	—	—	—
10EKD	Kohler	—	—	—	—	—	—
11EFGD	Kohler	—	—	—	—	—	—
12.5E	Kohler	—	—	23-7762(GR4 Ver), 23-7771(Var 2) Inline	23-2002 (296899 & Up), 23-2003 (296898 & below)	23-3303 (SN 296899 & Up), 23-3304 (SN 296898 & below)	23-3608
12.5CF	Kohler	—	—	—	23-2002 (296899 & Up), 23-2003 (296898 & below)	23-3303 (SN 296899 & Up), 23-3304 (SN 296898 & below)	23-3608
13EG	Kohler	—	—	23-7780	—	—	—
13EGZ	Kohler	—	—	23-7780	—	—	—
13EGD	Kohler	—	—	—	—	—	—
15C	Kohler	—	—	—	23-2002	23-3303	23-3608
15EG	Kohler	—	—	23-7780	—	—	—
15EGD	Kohler	—	—	23-7780	—	—	—
15EGZ	Kohler	—	—	23-7780	—	—	—
16CF	Kohler	—	—	—	23-2002	23-3303	23-3608
17.5CF	Kohler	—	—	—	—	—	—
20C	Kohler	—	—	—	23-2002	23-3303	23-3608
MDKAU	Onan	—	—	23-7760	—	—	—
MDKAV	Onan	—	—	23-7760	—	23-3300	—
MDKBG	Onan	—	—	23-7760	—	23-3300	—
MDKAW (Spacesaver)	Onan	—	—	23-7760	—	23-3300	—
MDKAZ	Onan	—	—	23-7760	—	23-3300	—
MDKBD	Onan	—	—	23-7760	—	23-3300	—
MDKBE	Onan	—	—	23-7760	—	23-3300	—
MDKBF	Onan	—	—	23-7760	—	23-3300	—
MDKBD (w/ Isolated Ground)	Onan	—	—	23-7760	—	23-3300	—
MDKBE (w/ Isolated Ground)	Onan	—	—	23-7760	—	23-3300	—
MDKBF (w/ Isolated Ground)	Onan	—	—	23-7760	—	23-3300	—

Thermostat Kit	Oil Filter	Air Filter	Thermostat Gasket	Anode	Carburetor Kit	Glow Plug	Temperature Sender	Oil Pressure Sender	Solenoid
—	—	—	—	—	—	—	—	—	—
23-3663	23-7823	23-1101	23-0809	—	—	—	—	—	—
—	23-7823	—	—	—	—	—	—	—	—
23-3663	23-7823	23-1101	23-0809	—	—	—	—	—	—
—	23-7821	—	—	23-6400	23-7202	—	—	—	—
—	—	—	—	—	—	—	—	—	—
—	—	—	—	—	—	—	—	—	—
—	23-7823	—	—	—	—	—	—	—	—
23-3663	23-7823	23-1101	23-0809	—	—	—	—	—	—
—	—	—	—	—	—	—	—	—	—
—	23-7823	—	—	—	—	—	—	—	—
—	—	—	—	—	—	—	—	—	—
—	23-7821	—	—	23-6400	23-7202	—	—	—	—
—	23-7821	—	—	23-6400	23-7202	—	—	—	—
—	—	—	—	—	—	—	—	—	—
—	—	—	—	—	—	—	—	—	—
23-3663	23-7823	23-1101	23-0809	—	—	—	—	—	—
—	23-7823	—	—	—	—	—	—	—	—
—	23-7821	—	—	23-6400	23-7202	—	—	—	—
—	—	—	—	—	—	—	—	—	—
—	—	—	—	—	—	—	—	—	—
23-3664	23-7803	—	23-0813	—	—	—	—	—	—
—	—	—	—	—	—	—	—	—	—
—	—	—	—	—	—	—	—	—	—
23-3664	23-7803	—	23-0813	—	—	—	—	—	—
23-3664	—	—	23-0813	—	—	—	—	—	—
—	—	—	—	—	—	—	—	—	—
—	—	—	—	—	—	—	—	—	—
—	—	—	—	—	—	—	—	—	—
23-3664	23-7803	—	23-0813	—	—	—	—	—	—
23-3664	23-7820	—	23-0813	—	—	—	—	—	—
23-3664	—	—	23-0813	—	—	—	—	—	—
23-3664	—	—	23-0813	—	—	—	—	—	—
—	—	—	—	—	—	—	—	—	—
23-3664	23-7820	—	23-0813	—	—	—	—	—	—
23-3664	—	—	23-0813	—	—	—	—	—	—
—	—	—	—	—	—	—	—	—	—
23-3664	—	—	23-0813	—	—	—	—	—	—
23-3664	23-7820	—	23-0813	—	—	—	—	—	—
—	—	—	—	—	—	—	—	—	—
23-3664	23-7820	—	23-0813	—	—	—	—	—	—
—	23-7804	—	—	—	—	—	—	—	—
—	23-7842	—	—	23-6401	—	—	—	—	—
—	23-7842	—	—	23-6401	—	—	—	—	—
—	23-7842	—	—	23-6401	—	—	—	—	—
—	23-7842	—	—	23-6401	—	—	—	—	—
—	23-7840	—	—	23-6401	—	—	—	—	—
—	23-7840	—	—	23-6401	—	—	—	—	—
—	23-7840	—	—	23-6401	—	—	—	—	—
—	23-7840	—	—	23-6401	—	—	—	—	—
—	23-7840	—	—	23-6401	—	—	—	—	—
—	23-7840	—	—	23-6401	—	—	—	—	—
—	23-7840	—	—	23-6401	—	—	—	—	—
—	23-7840	—	—	23-6401	—	—	—	—	—

Model	OEM	Starter	Alternator	Fuel Filter	Impeller	Impeller Kit	Thermostat
MDKBH	Onan	—	—	—	—	—	—
MDKBK	Onan	—	—	—	23-2000	23-3310	—
MDKBL	Onan	—	—	—	23-2000	23-3310	—
MDKBM	Onan	—	—	—	23-2000	23-3310	—
MDKBN	Onan	—	—	—	23-2000	23-3310	—
MDKBP	Onan	—	—	—	—	—	—
MDKBR	Onan	—	—	—	—	—	—
MDKBS	Onan	—	—	—	—	—	—
MDKBV	Onan	—	—	—	—	—	—
MDKBT	Onan	—	—	—	—	—	—
MDKBU	Onan	—	—	—	—	—	—
MDDCA	Onan	—	—	—	—	23-3309	—
MDDCB	Onan	—	—	—	—	23-3309	—
MDDCC	Onan	—	—	—	—	23-3309	—
MDDCF	Onan	—	—	—	—	23-3309	—
MDDCG	Onan	—	—	—	—	23-3309	—
MDDCD	Onan	—	—	—	—	23-3309	—
MDDCE	Onan	—	—	—	—	23-3309	—
MDDCH	Onan	—	—	—	—	23-3309	—
MDDCJ	Onan	—	—	—	—	23-3309	—
MDJA	Onan	—	—	23-7750 (Spec A-R)	—	—	23-3606
MDJB	Onan	—	—	23-7750 (Spec A-R)	—	—	23-3606
MDJC	Onan	—	—	23-7750 (Spec A-R)	—	—	23-3606
MDJE	Onan	—	—	23-7750 (Spec A)	—	—	23-3606
MDJF	Onan	—	—	23-7750 (Spec A)	—	—	23-3606
MJA	Onan	—	—	—	—	—	23-3606
MJB	Onan	—	—	—	—	—	23-3606
MJC	Onan	—	—	—	—	—	23-3606
MDKAD/E/F	Onan	—	—	23-7760	—	—	—
MDKAL/A/B	Onan	—	—	—	23-2000	23-3310	—
AGTPM 4	Fischer Panda	—	—	—	23-2001	23-3311	—
PMS 4	Fischer Panda	—	—	—	23-2001	23-3311	—
PMS 8 Mini	Fischer Panda	—	—	—	23-2001	23-3305	—
PMS 8 DP	Fischer Panda	—	—	—	23-2001	23-3305	—
PMS 4200	Fischer Panda	—	—	—	23-2001	23-3305	—
PMS 6500	Fischer Panda	—	—	—	23-2001	23-3305	—
PMS 12 DP	Fischer Panda	—	—	—	23-2001	23-3305	—
PMS 12 Mini	Fischer Panda	—	—	—	23-2001	23-3305	—
PMS 15	Fischer Panda	—	—	—	—	23-3312	—
PMS 16 DP	Fischer Panda	—	—	—	—	23-3312	—
PMS 20	Fischer Panda	—	—	—	—	23-3312	—
PMS 22	Fischer Panda	—	—	—	—	23-3312	—
PMS 25	Fischer Panda	—	—	—	—	23-3312	—
PMS 30	Fischer Panda	—	—	—	—	23-3312	—
PMS 40	Fischer Panda	—	—	—	—	23-3312	—
PMS 50	Fischer Panda	—	—	—	—	23-3312	—
M673LD3	Northern Lights	—	—	—	23-2005	23-3315	—
M673L3	Northern Lights	—	—	—	23-2005	23-3315	—
M673LD2	Northern Lights	—	—	—	23-2005	23-3315	—
M673L2	Northern Lights	—	—	—	23-2005	23-3315	—
M753	Northern Lights	—	—	—	—	—	—
M753G	Northern Lights	—	—	—	—	—	—
M753K	Northern Lights	—	—	—	—	—	—
M753W	Northern Lights	—	—	—	—	—	—
M753w2	Northern Lights	—	—	—	—	—	—
M773L	Northern Lights	—	—	—	—	—	—
M773LW2	Northern Lights	—	—	—	—	—	—
M773LW3: 9/7Kw	Northern Lights	—	—	—	—	—	—
M843	Northern Lights	—	—	—	—	—	—

Model	OEM	Starter	Alternator	Fuel Filter	Impeller	Impeller Kit	Thermostat
M843N	Northern Lights	—	—	—	—	—	—
M843NK	Northern Lights	—	—	—	—	—	—
M843NK2	Northern Lights	—	—	—	—	—	—
M843NW	Northern Lights	—	—	—	—	—	—
M843NW2	Northern Lights	—	—	—	—	—	—
M843NW3	Northern Lights	—	—	—	—	—	—
M844	Northern Lights	—	—	—	—	—	—
M844K	Northern Lights	—	—	—	—	—	—
M844L	Northern Lights	—	—	—	—	—	—
M844LK	Northern Lights	—	—	—	—	—	—
M844LW	Northern Lights	—	—	—	—	—	—
M844LW2	Northern Lights	—	—	—	—	—	—
M844W	Northern Lights	—	—	—	—	—	—
M844W2	Northern Lights	—	—	—	—	—	—
M844W3: 16/12KW	Northern Lights	—	—	—	—	—	—
M844LW3: 20/16Kw	Northern Lights	—	—	—	—	—	—
M844NK2	Northern Lights	—	—	—	—	—	—
M844LK2	Northern Lights	—	—	—	—	—	—
M844NW2	Northern Lights	—	—	—	—	—	—
M844NW3	Northern Lights	—	—	—	—	—	—
ML844	Northern Lights	—	—	—	—	—	—
ML844K	Northern Lights	—	—	—	—	—	—
ML844L	Northern Lights	—	—	—	—	—	—
ML844LK	Northern Lights	—	—	—	—	—	—
M864K	Northern Lights	—	—	—	—	—	—
M864W	Northern Lights	—	—	—	—	—	—
M864W3: 25/20Kw	Northern Lights	—	—	—	—	—	—
M16C	Northern Lights	—	—	—	—	—	—
M20CL	Northern Lights	—	—	—	—	—	—
M20CR	Northern Lights	—	—	—	—	—	—
IS 2.5	Mase					23-3311	
IS 4.0	Mase					23-3311	
IS 4.7	Mase					23-3311	
IS 7.1	Mase					23-3311	
IS 13.2	Mase						
IS 8.1	Mase			23-7751			
IS 10.2	Mase					23-3312	
IS 14.0	Mase					23-3312	
IS 15.6T	Mase						
IS 19.0	Mase					23-3312	
IS 23.1T	Mase					23-3312	
IS 28.0	Mase						
IS 31.0	Mase						
IS 42.0	Mase						



FUEL WATER SEPARATORS

Sierra fuel water separators remove over 99.8% of emulsified water from your gasoline. Sierra's 10 micron filters are over 90% efficient at removing particles as small as 10 micron. All filters flow @ 90 GPH to feed even the hungriest motor. Sierra 10 micron filters are recommended to prevent damage to sensitive inboard, sterndrive and outboard fuel injection systems.



11/16" - 16 thread size



Includes Bracket, Filter & 2 pipe plugs*

3/8" Pipe Plugs - 18-4264
1/4" Pipe Plugs - 18-4256

* Display Packaged

- UNIVERSAL DESIGN -

FUEL WATER SEPARATOR BRACKETS

Part No.	Thread	Material	Replaces
18-7777	1/4"	Stainless Steel	Yamaha MAR-FLTHD-SS-12
18-7776	3/8"	Stainless Steel	
18-7853-1	1/4"	Aluminum	Mercury 89876A3, 89876, 55481 Yamaha MAR-FLTHD-AL-12
18-7775	3/8"	Aluminum	

FILTERS

Part No.	Description	Micron Rating	Replaces
18-7944	Short - 3.875"	10	Mercury - 35-807172, 35-802893Q, 35-806771, 35-8053691, 35-805369, 35-604941, 35-60494, 35-57250, 35-55501, 35-52456
18-7945	Long - 4.35"	10	Mercury - 35-802893Q, 35-806771, 35-8053691, 35-805369, 35-604941, 35-60494, 35-57250, 35-55501, 35-52456 Yamaha - ABB-FUELF-IL-TR
18-7866	High Capacity - 6"	10	Yamaha - MAR-FUELF-IL-TR
18-7967	V6 EFI 1995-Earlier with sensor (black)	10	Mercury - 35-18458Q3, 35-18458A3, 35-18458A2, 35-17808A1, 35-14571A1
18-7968	V6 EFI 1996-Up with sensor (blue)	10	Mercury - 35-18458Q4, 35-184585
18-7844	Short - 3.875"	21	Mercury - 35-807172, 35-802893Q
18-7845	Long - 4.35"	21	Mercury - 35-806771, 35-8053691, 35-60494A4, 35-604941, 35-57250, 35-55501 Yamaha - ABB-FUELF-IL-TR
18-79911	Long - 8.5"	10	Mercury - 35-8M0079962

FUEL WATER SEPARATOR COVERS

Part No.	Description
18-8953	Fits: Yamaha mini-10 size filter
18-8954	Fits: Yamaha 18-7866 sized filter
18-8955	Fits: 18-7944 & 18-7945 sized filter

FUEL WATER SEPARATOR KITS

Part No.	Kit Type	Micron Rating	Contents	Replaces
18-79912	1/4" Aluminum (Tall Filter)	10	1 - 18-79911 & 1 - 18-7853-1	Mercury - 35-8M0082290
18-7983-1	1/4" Aluminum (Short Filter)	10	1 - 18-7944 & 1 - 18-7853-1	Mercury - 35-802893A4, Q4, 35-60494A4, 35-807172A4, 35-60494A1, 35-57250A1, 35-55501A1, 35-52456A1
18-7982-1	1/4" Aluminum (Tall Filter)	10	1 - 18-7945 & 1 - 18-7853-1	
18-7966-1	1/4" Aluminum (High Capacity Filter)	10	1 - 18-7866 & 1 - 18-7853-1	Yamaha - MAR-SEPAR-AT-OR
18-7986-1	3/8" Aluminum (Tall Filter)	10	1 - 18-7945 & 1 - 18-7775	
18-7984-1	1/4" Stainless Steel (Tall Filter)	10	1 - 18-7945 & 1 - 18-7777	Yamaha - MAR-SPRTR-HD-SS
18-7985-1	3/8" Stainless Steel (Tall Filter)	10	1 - 18-7945 & 1 - 18-7776	
18-7848-1	1/4" Aluminum (Short Filter)	21	1 - 18-7844 & 1 - 18-7853-1	Mercury - 35-807172A4, Q4, 35-60494A4, 35-805369A4, 35-57250A1, 35-55501A1, 35-52456A1, 35-60494A1, 52444
18-7852-1	1/4" Aluminum (Tall Filter)	21	1 - 18-7845 & 1 - 18-7853-1	Yamaha - MAR-SEPAR-AT-OR
18-7775-1	3/8" Aluminum (Tall Filter)	21	1 - 18-7845 & 1 - 18-7775	
18-7777-1	1/4" Stainless Steel (Tall Filter)	21	1 - 18-7845 & 1 - 18-7777	Yamaha - ABB-SPRTR-HD-SS
18-7776-1	3/8" Stainless Steel (Tall Filter)	21	1 - 18-7845 & 1 - 18-7776	



FUEL WATER SEPARATOR KITS - BONUS PACK CONTAINS SPARE FILTER

Part No.	Kit Type	Micron Rating	Contents
18-7983-2 •	1/4" Aluminum	10	2 - 18-7944 & 1 - 18-7853-1
18-7982-2 •	1/4" Aluminum	10	2 - 18-7945 & 1 - 18-7853-1
18-7848-2 •	1/4" Aluminum	21	2 - 18-7844 & 1 - 18-7853-1
18-7852-2 •	1/4" Aluminum	21	2 - 18-7845 & 1 - 18-7853-1

*Each kit contains 2 brass pipe plugs

SIERRA AquaVue™ & METAL COLLECTION BOWL FUEL WATER SEPARATOR KITS

Sierra AquaVue™ and metal collection bowl separator filters allow water to be drained from the filter to extend service life. Use the AquaVue™ collection bowl for outboard, above deck installations. USCG regulations require the use of the flame resistant metal collection bowl below deck.



1 1/16" - 16 thread size



*Each kit contains 2 brass pipe plugs

10 MICRON FILTER KITS WITH COLLECTION BOWLS

Part No.	Kit Type	Contents
18-7932-1 •	1/4" Aluminum w/ AquaVue™ collection bowl	1 - 18-7919 & 1 -18-7853-1, 1 - 18-7922-1
18-7951 •	1/4" Aluminum w/ metal collection bowl	1 - 18-7919 & 1 - 18-7853-1, 1 - 18-7924
18-7937-1 •	1/4" Stainless Steel w/ AquaVue™ collection bowl	1 - 18-7919 & 1 - 18-7777, 1 - 18-7922-1
18-7938 •	1/4" Stainless Steel w/ metal collection bowl	1 - 18-7919 & 1 - 18-7777, 1 - 18-7924

REPLACEMENT BOWLS

Part No.	Description	Replaces
18-7922-1	AquaVue™ Collection Bowl	Suzuki 99105-20004-BWL
18-7924	Metal Collection Bowl	Yamaha MAR-10171-00-10

REPLACEMENT ELEMENTS & ELEMENT BOWL ASSEMBLIES

Part No.	Description	Replaces
18-7919	Spin on replacement 10 Micron, 7 1/2" tall	Mercury 35-809097, 35-8M0103095 Yamaha MAR-24563-00-00 Racor S3213
18-7928-1 •	Filter & AquaVue™ Collection Bowl Mercury/Yamaha Style Contains: 18-7919 , 18-7922-1	Racor B32013
18-7929 •	Filter & Metal Collection Bowl Mercury/Yamaha Style Contains: 18-7919 , 18-7924	Mercury 35-809100 Racor B32020MAM
18-0179	Bowl O-Ring Standard Metal and AquaVue™ Collection Bowl	Racor RK22244
18-7394	Bowl O-Ring Mini 10 AquaVue™ Collection Bowl	Racor RK10012
18-9884	Bowl Wrench	Racor RK22628

3/8" Pipe Plugs - 18-4264
1/4" Pipe Plugs - 18-4256

• Display Packaged

COMPACT BRACKET & SEPARATOR KIT FOR OUTBOARDS UP TO 115HP 10 MICRON FILTRATION FOR SMALL OUTBOARD MOTORS



18-7965-1
10 MICRON COMPACT SEPARATOR KIT
Replaces: Yamaha MAR-MINIF-LT-AS
Contains:
1 - 18-7774 bracket
1 - 18-7865 filter



18-7774
COMPACT ALUMINUM BRACKET
13/16" - 18 thread size



18-7865
REPLACEMENT FILTER
Replaces: Yamaha MAR-MINIF-IL-TR



18-79906
FUEL FILTER
For: Racor style Mini-10 Bowl-style filter
Use with drain bowls 18-7987 & 18-7988



18-7987
AquaVue™ BOWL
For: Racor style Mini-10



18-7988
COLLECTION BOWL
For: Racor style Mini-10

OMC REPLACEMENT FUEL FILTERS



18-7920
10 MICRON REPLACEMENT FILTER
Replaces: OMC 771839, Racor S3214, Mercury 35-809099
1" - 12 thread size



18-7941-1
FILTER & AquaVue™ BOWL
OMC style
Contains: 18-7920, 18-7922-1



18-7943
FILTER & METAL BOWL
OMC style
Contains: 18-7920, 18-7924



18-7946
10 MICRON REPLACEMENT FILTER
Replaces: OMC 502905
OMC thread



18-7846
21 MICRON REPLACEMENT FILTER
Replaces: OMC 502905
OMC thread



18-7930
FUEL FILTER
Replaces: OMC 173326
For: 1977-83 Fuel system with add-on filter kit

VOLVO STYLE FUEL WATER SEPARATOR KITS



18-8149
HIGH CAPACITY FUEL WATER SEPARATING FILTER 10 MICRON
Replaces: Volvo 3847644
For use with side-by-side fuel pump applications.



18-7778
VOLVO ALUMINUM REPLACEMENT BRACKET
Replaces: Volvo 3850861
13/16" - 18 thread size

10 MICRON REPLACEMENT FILTERS		
Part No.	Description	Replaces
18-7989	Volvo SX/EFI	Volvo 3851218-2, 3852413, 3862228
	Cobra EFI	OMC 502906
21 MICRON REPLACEMENT FILTERS		
Part No.	Description	Replaces
18-7789	Volvo SX/EFI	Volvo 3851218-2, 3852413
	Cobra EFI	OMC 502906

REPLACEMENT ELEMENTS & ASSEMBLIES FOR RACOR FILTER KITS



• Display Packaged

ELEMENT & BOWL KITS		
PART #	DESCRIPTION	CONTAINS
18-7969 •	Filter & Metal Bowl	18-7948, 18-7924
18-7994-1 •	Filter & AquaVue™ Bowl	18-7948, 18-7922-1
REPLACEMENT ELEMENT ONLY		
PART #	ELEMENT FOR RACOR	REPLACES
18-7947	120RRAC01 (Uses Mini Bowl below)	Honda 17670-ZW1-030GH Racor S3240 Suzuki 99105-20006
18-7948	320RRAC01 (1" - 14 thread size) (short filter)	Honda 17670-ZW1-801AH Mercury 35-886638 Racor S3227 Suzuki 99105-20005
18-7949	660RRAC02 (1" - 14 thread size) (tall filter)	Racor S3232
REPLACEMENT BOWL		
PART #	DESCRIPTION	REPLACES
18-7987	AquaVue™ Mini Bowl	Racor RK10222 Suzuki 99105-20006-BWL
18-7988	Mini Metal Bowl	-
BOWL WRENCH		
PART #	DESCRIPTION	REPLACES
18-9884	Bowl Wrench	Racor RK22628

DIESEL FUEL FILTERS

20 MICRON



18-7931

Replaces: **Detroit Diesel** 5574508
For: 8V-92, 8V-71

20 MICRON



18-7934

Replaces:
Cerlist Diesel 1512904
Model M

20 MICRON



18-7935

Replaces:
Fram CCS 1136
Fram FCS 1136 Filter Bracket

20 MICRON



18-7970

Replaces:
Cerlist Diesel 1512903
Model 3M



18-79960

FUEL FILTER ELEMENT

Replaces: **Yanmar** 104500-55710
Fits: All GM Series, YM Series, HM Series, QM Series

20 MICRON



18-7858

Replaces: **Volvo** 858201
For: CAV Type Unit
For: AQ120B, 125A, B, 131A, 140A, 145A,B, 151,BB, 140,145A

20 MICRON



18-7942

Replaces:
Volvo 466987, 3825133
For: MD100A, TMD100A, MD100B, MD120A, TMD120A, TAMD120A, MD120B, TMD120B, TAMD120B, MD70B, TMD70B, TAMD70B, THAMD70B, AQAD70B, MD70C, TMD70C, TAMD70C, AQD70C, TAMD60A, TAMD60B, TAMD60C, D5/D7 MARINE GENSET, D5A-T, D5A-TA, D7A-T, D7A-TA, D7C-TA, D63 MARINE, D71/73 MARINE, KAD32P, TAMD42WJ, KAD43P/44P/300, KAMD43P/44P/300, TAMD103A, TAMD61A, TAMD62A, TAMD71A, TAMD72A, TAMD72P, TAMD72WJ, TAMD74, TAMD75 MARINE, TMD102A, TAMD102A, TAMD102D, TMD122A, TAMD122A, TAMD122P, TMD31L, TAMD31P/L/M/S, AD31P/L, TMD41L, TAMD41P/L/M/H



18-7873

Replaces:
Mercuriser 35-808275
For models: D7.3/270 Bravo & MIE Diesel Engines (1994-96)



18-8124

Replaces: **Volvo** 829913
For: 2001, 2001B, 2002, 2002B, 2003, 2003B/T/TB, AQD2B, MD11C/D, MD17C/D, MD1B, MD2B, MD3B, MD5A/B/C, MD7/B



18-8125

Replaces: **Volvo** 3583443
For: D4-180i-B, D4-180i-C, D4-210A-A, D4-210A-B, D4-210i-A, D4-210i-B, D4-225A-B, D4-225A-C, D4-225i-B, D4-225i-C, D4-260A-A, D4-260A-B, D4-260A-C, D4-260D-B, D4-260D-C, D4-260i-A, D4-260i-B, D4-260i-C, D4-300A-A, D4-300A-C, D4-300D-A, D4-300D-C, D4-300i-A, D4-300i-C, D6-280A-A, D6-280A-B, D6-280i-A, D6-280i-B, D6-310A-A, D6-310A-B, D6-310D-A, D6-310D-B, D6-310i-A, D6-310i-B, D6-330A-B, D6-330A-C, D6-330D-B, D6-330D-C, D6-330i-B, D6-330i-C, D6-350A-A, D6-350A-B, D6-370A-B, D6-370A-C, D6-370D-A, D6-370D-B, D6-370D-C, D6-370i-A, D6-370i-B, D6-370i-C, D6-435D-A, D6-435D-C, D6-435i-A, D6-435i-C



18-8126

Replaces: **Volvo** 861477
For: D1-13 A, D1-13 B, D1-20 A, D1-20 B, D1-30 A, D1-30 B, D2-40 A, D2-40 B, D2-55 A, D2-55 B, D2-55 C, D2-55 D, D2-55 E, D2-55F, D2-75 A, D2-75 B, D2-75 C, D2-75F, MD2010A, MD2010B, MD2020A, MD2020B, MD2030A, MD2030B, MD2040A, MD2040B

FUEL FILTERS



20 MICRON

FUEL FILTER

18-7723

Fits: 1/4" and 5/16" hose

18-7724

Fits: 3/8" and 7/16" hose



18-7828-1

FUEL FILTER

Small Capacity for 1/4" Fuel Line



FUEL FILTERS

PART #	REPLACES	APPLICATION
18-7829	Mercury 35-16494, 35-816296, T, Q, 35-816296K03	1/4" Large Cap. (For 1/4" Fuel Line)
18-7830	Mercury 35-164941, 35-816296 1, 35-816296T1, Q2, 35-8162961, 35-816396Q1, 35-816296B2 35-816296B1, 35-134301	5/16"
18-7831	Mercury 802128A1 Johnson/Evinrude 398319	3/8"



18-7856-1

FUEL FILTER

Replaces: A.C. Delco GF-61

For: 5/16" Fuel Line



18-7857-1

FUEL FILTER

Replaces: A.C. Delco GF-61P

For: 3/8" Fuel Line



18-7790

FUEL FILTER KIT

Complete Kit Contains: Housing, Replaceable Element & Fittings for 1/4", 5/16", & 3/8" Fuel Lines



18-7791

FUEL FILTER ELEMENT

Replacement element for

18-7790 filter kit



18-9884

BOWL WRENCH

Replaces: Racor RK22628

Fits: Sierra, Racor and other aftermarket filter bowls

PRIMER BULBS



- Meets current EPA regulations in effect 1/1/2011 of 15 g/m2/24 hrs.
- Both EPA/CARB certified
- Utilizes Fluoroelastomer (FKM) material for traditional look and operation.
- 7 1/2" overall length including barbs



18-8002EP-1

PRIMER BULB ASSEMBLY

1/4" I.D.

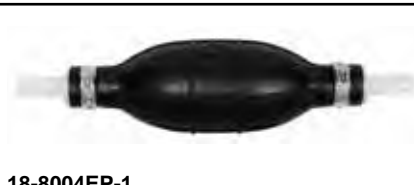

18-8004EP-1

18-8004-10EP-1

PRIMER BULB ASSEMBLY

Replaces: Mercury 89396A38, 89396Q38

Johnson/Evinrude 174511

5/16" I.D.



18-8005EP-1

18-8005-10EP-1

PRIMER BULB ASSEMBLY

Replaces: Mercury 13330A3, 13330Q,

Johnson/Evinrude 174512

3/8" I.D.

SILVERADO 4000 COMPLETE FUEL LINE ASSEMBLIES



- **Premium Rubber Fuel Line**
 - Polyester braid
 - Weather resistant CPE cover
 - Flexible THV barrier layer
- **Updated packaging**
- **Best hose on the market-resists kinking & easy to clamp.**



CHRYSLER / FORCE

8' LENGTH COMPLETE FUEL LINE ASSEMBLIES

3/8"
FUEL LINE ASSEMBLY

18-8011EP-2 *SILVERADO 4000 Premium*

OE# FS409752



*



18-8071
TANK
CONNECTOR
(SOLD SEPARATELY)



18-8005EP-1
PRIMER
BULB



18-8062
FUEL
CONNECTOR



*

FUEL LINE ASSEMBLY COMPONENTS

HONDA

9' LENGTH COMPLETE FUEL LINE ASSEMBLIES

3/8"
FUEL LINE ASSEMBLY

18-81042EP-2 *SILVERADO 4000 Premium* OE# 17700-ZW9-010
17700-ZW9-020



*



18-80400
TANK
CONNECTOR
(SOLD SEPARATELY)



18-80401
FUEL
CONNECTOR

18-8005EP-1
PRIMER
BULB

18-80403
FUEL
CONNECTOR



*

FUEL LINE ASSEMBLY COMPONENTS

Honda Fuel Application: 8, 9.9, 15, 25, 30, 40, 50, 75, 90, 115, 130 HP (2001-02)

* Tanks and Engines for picture purpose only.

JOHNSON / EVINRUDE

8' LENGTH COMPLETE FUEL LINE ASSEMBLIES

3/8" High Flow
FUEL LINE ASSEMBLY

18-8009EP-2 *SILVERADO 4000 Premium*

OE# 398549



18-8063
TANK
CONNECTOR
(SOLD SEPARATELY)



18-8092
FUEL
CONNECTOR



18-8005EP-1
PRIMER
BULB

18-8092
FUEL
CONNECTOR



FUEL LINE ASSEMBLY COMPONENTS

Fits: All V8, 1984 & later V6, 1985 & later 120 HP, 140 HP outboards, 2 HP (1 cyl.) - 75 HP (3 cyl.) (1976-02)

3/8"
FUEL LINE ASSEMBLY

18-8014EP-2 *SILVERADO 4000 Premium*

OE# 174509



18-8074
HOSE BARB
(SOLD SEPARATELY)



18-8005EP-1
PRIMER
BULB

18-8092
FUEL
CONNECTOR



FUEL LINE ASSEMBLY COMPONENTS

Fits: All V6 & V8 (1976-02)

MERCURY / MARINER

8' LENGTH COMPLETE FUEL LINE ASSEMBLIES

3/8"
FUEL LINE ASSEMBLY

18-8010EP-2 *SILVERADO 4000 Premium*



18-8068
18-8082
TANK
CONNECTOR
(SOLD SEPARATELY)



18-8084
FUEL
CONNECTOR



18-8005EP-1
PRIMER
BULB

18-8083
FUEL
CONNECTOR



FUEL LINE ASSEMBLY COMPONENTS

3/8"
FUEL LINE ASSEMBLY

18-8012EP-2 *SILVERADO 4000 Premium*

OE# 32-858114Q08,
32-858114K08



18-8074
HOSE BARB

18-8005EP-1
PRIMER
BULB

18-8073
HOSE BARB



FUEL LINE ASSEMBLY COMPONENTS

Has 1/8" NPT threaded fitting on engine end and 1/4" NPT threaded fitting on the tank end. Primer bulb is included in this 8ft. (2.44 m) assembly. Fits various applications using the older style twist type disconnects at the engine end and either a bayonet or thread-in fitting on the tank end.

* Tanks and Engines for picture purpose only.

MERCURY / MARINER (Cont.)

3/8" FUEL LINE ASSEMBLY

18-8024EP-2 *SILVERADO 4000 Premium*

OE# 32-858104Q08,
32-858104K08



*



18-8074
HOSE BARB

18-8005EP-1
PRIMER
BULB

18-8076
FUEL
CONNECTOR



*

FUEL LINE ASSEMBLY COMPONENTS

Has standard quick connect type fitting on engine end and 1/4" NPT threaded fitting on the tank end. Primer bulb is included in this 8 ft. (2.44 m) assembly. Fits Force 40 HP and larger (1993 & Newer), Force 9.9/15/25HP (1998), and all Mercury/Mariner outboards using clip on type disconnect at engine ends and a tank with threaded fuel pickup fitting.

3/8" FUEL LINE ASSEMBLY

18-8025EP-2 *SILVERADO 4000 Premium*

OE# 32-858105Q08,
32-858105K08



*



18-8068
18-8082
TANK
CONNECTOR
(SOLD SEPARATELY)



18-8084
FUEL
CONNECTOR

18-8005EP-1
PRIMER
BULB

18-8076
FUEL
CONNECTOR



*

FUEL LINE ASSEMBLY COMPONENTS

Has standard quick connect type fitting on engine end and bayonet style fitting on the tank end. Primer bulb is included in this 8 ft. (2.44 m) assembly. Fits Force 40 HP and larger (1993 & Newer), Force 9.9/15/25HP (1998), and all Mercury/Mariner outboards using clip-on type disconnect at the engine end and an older style tank with bayonet type connection.

3/8" FUEL LINE ASSEMBLY

18-8016EP-2 *SILVERADO 4000 Premium*

OE# 32-858109Q12,
32-858109K12



*



18-80402
TANK
CONNECTOR
(SOLD SEPARATELY)



18-8091
FUEL
CONNECTOR

18-8005EP-1
PRIMER
BULB

18-8076
FUEL
CONNECTOR



*

FUEL LINE ASSEMBLY COMPONENTS

Has double sealed quick connect type fitting on tank end and clip-on type quick connect on engine end. Primer bulb is included in this 8ft. (2.44m) assembly. Fits Force 40 HP and larger (1993 & Newer), Force 9.9/15/25HP (1998) and all Mercury Mariner outboards using clip-on type disconnects at both tank and engine ends



* Tanks and Engines for picture purpose only.

YAMAHA

8' LENGTH COMPLETE FUEL LINE ASSEMBLIES

3/8"

FUEL LINE ASSEMBLY

18-8017EP-2 *SILVERADO 4000 Premium*

OE# 6YL-24306-60-00



*



18-8077-1
TANK
CONNECTOR
(SOLD SEPARATELY)



18-8076
FUEL
CONNECTOR

18-8005EP-1
PRIMER
BULB

18-8076
FUEL
CONNECTOR



*

FUEL LINE ASSEMBLY COMPONENTS
Fits: F75-F250 and 115-300 HP

UNIVERSAL

8' LENGTH FUEL LINE ASSEMBLIES

5/16"

FUEL LINE ASSEMBLY

18-8013EP-2 *SILVERADO 4000 Premium*



*



18-8004EP-1
PRIMER
BULB



*

FUEL LINE ASSEMBLY COMPONENTS

3/8"

FUEL LINE ASSEMBLY

18-8015EP-2 *SILVERADO 4000 Premium*



*



18-8005EP-1
PRIMER
BULB



*

FUEL LINE ASSEMBLY COMPONENTS

12' LENGTH COMPLETE FUEL LINE ASSEMBLIES

5/16"

FUEL LINE ASSEMBLY

18-8032EP-2 *SILVERADO 4000 Premium*



*





18-8004EP-1
PRIMER
BULB



*

FUEL LINE ASSEMBLY COMPONENTS

HOSE BARBS	HOSE BARB APPLICATION						18-8045 REDUCING NIPPLE FITTING 1/8" x 1/4" NPT HEX	18-4256 PIPE PLUG 1/4" Threads
	Part #	Mercury O.E. #	OMC O.E. #	Barb	NPT	Conn. Type		
	18-8041	—	—	5/8"	3/8"	Male		
	18-8042	—	—	1/4"	1/4"	Male		
	18-8043	—	—	1/4"	1/8"	Male		
	18-8054	22-63186	—	5/16"	1/8"	Male		
	18-8055	22-63187	173311	5/16"	1/4"	Male		
	18-8073	—	—	3/8"	1/8"	Male		
	18-8074	—	173312	3/8"	1/4"	Male		
	18-8093	—	—	1/4"	1/4"	Female		
	18-8094	—	—	5/16"	1/4"	Female		
	18-8095	—	—	3/8"	1/4"	Female		
	18-8108	—	—	3/8"	3/8"	Male		
	18-8109	—	—	5/16"	3/8"	Male		

18-4264
PIPE PLUG
3/8" Threads



18-8046
FUEL TANK ELBOW
1/8" NPT x 1/4" NPT
90°



18-8047
FUEL TANK ELBOW
1/4" NPT Threads
90°



18-8067
18-8110
18-8110-9①
Bulk Pack of 12 (18-8067)
FUEL ELBOW
3/8" Barb with
1/4" NPT Thread
90°



18-1650
SHUT OFF VALVE
3 way 1/4" FNPT Valve



18-1651
SHUT OFF VALVE
2 way 1/4" FNPT Male/Male
Shut off Valve



18-1652
SHUT OFF VALVE
2 way 1/4" FNPT Male/
Female Shut off Valve



18-1653
SHUT OFF VALVE
2 way 1/4" FNPT Female/
Female Shut off Valve



18-1654
SHUT OFF VALVE
4 way 1/4" FNPT Valve



18-1655
SHUT OFF VALVE
3 way 1/4" FNPT Valve w/ Detent



18-1656
SHUT OFF VALVE
3 way 3/8" FNPT Valve w/ Detent



PKG. OF 10



SNAPPER CLAMPS					
PART #	O.E.	O.E. #	CLAMP RANGE	CLAMP SIZE	
18-8020 ①	Mercury J/E	54-41582-7 322652	.538 - .608	8	
18-8021 ①	J/E	911616	.597 - .665	10	
18-8034 ①	J/E	329654	.670 - .780	12	
18-8200 ①	J/E	322653	.360 - .406	2	
18-8201 ①	J/E	124249	.410 - .468	4	
18-8202 ①	J/E	322654	.475 - .536	6	
18-8203 ①	J/E	329653	.750 - .875	14	
18-8204 ①	J/E	324825	.875 - .975	19	

FUEL LINE

- ★ Universal
- ★ Vinyl
- ★ 35 psi working pressure

*Not intended for diesel fuel



10' Length	50' Roll	I.D.	O.D.
18-8150-10	18-8150	1/8"	1/4"
18-8151-10	18-8151	3/16"	5/16"
18-8152-10	18-8152	1/4"	3/8"

FUEL LINE HOSE
SILVERADO 4000

16-337-0566
5/16" I.D.

16-337-0386
3/8" I.D.



50' Reels ALCOHOL RESISTANT
SAE J1527 Type B1-15 and ISO 8469

18-7598
PULL-START LOCK



18-7599
FUEL LOCK

Protect your outboard from theft, disconnect fuel line and simply install fuel lock. Designed to fit clip on style fuel connectors. Fits: Johnson Evinrude, Mercury/Mariner, Yamaha and Honda.



① Priced per Package

FUEL LINE HOSE

MADE FROM AN ALCOHOL RESISTANT COMPOUND — 50' REELS



18-8048
BLEEDER HOSE

.090 I.D. x .220 O.D.
Similar to Mercury
32-99130122, 32-892024122

18-8050
.0625 I.D. x .190 O.D.
Similar to Mercury 32-9938779



18-8051
FUEL LINE HOSE
for OMC Pressurized Systems

Replaces: J/E 322656
(Double)



18-8052
FUEL LINE HOSE

3/16" I.D.
Non-Pressurized Systems
Replaces: J/E 122838

PRIMER BULBS



- Nitrile construction.
- Manufactured for countries that do not need EPA/CARB compliancy.
- Resistant to alcohol laden fuels.



18-8002S
PRIMER BULB ASSEMBLY
1/4" I.D.



18-8004S
18-8004-10S
PRIMER BULB ASSEMBLY
Replaces: Mercury 89396A38, 89396Q38
Johnson/Evinrude 174511
5/16" I.D.



18-8005S
18-8005-10S
PRIMER BULB ASSEMBLY
Replaces: Mercury 13330A3, 13330Q,
Johnson/Evinrude 174512
3/8" I.D.

SILVERADO 4000 COMPLETE FUEL LINE ASSEMBLIES



- Eight of the most popular numbers, utilizing the Silverado 4000 line and the non-domestic primer bulb.

- Updated packaging.



JOHNSON / EVINRUDE

8' LENGTH COMPLETE FUEL LINE ASSEMBLIES

3/8" High Flow
FUEL LINE ASSEMBLY

18-8009S-1 *SILVERADO 4000 Premium*

OE# 398549



18-8063
TANK
CONNECTOR
(SOLD SEPARATELY)

*



18-8092
FUEL
CONNECTOR

*



18-8005S
PRIMER
BULB

*



18-8092
FUEL
CONNECTOR

*



*

FUEL LINE ASSEMBLY COMPONENTS

Fits: All V8, 1984 & later V6, 1985 & later 120 HP, 140 HP outboards, 2 HP (1 cyl.) - 75 HP (3 cyl.) (1976-02)

8' LENGTH COMPLETE FUEL LINE ASSEMBLIES

3/8"
FUEL LINE ASSEMBLY

18-8014S-1 *SILVERADO 4000 Premium*

OE# 174509



18-8074
HOSE BARB
(SOLD SEPARATELY)

*



18-8005S
PRIMER
BULB

*



18-8092
FUEL
CONNECTOR

*



*

FUEL LINE ASSEMBLY COMPONENTS

Fits: All V6 & V8 (1976-02)

MERCURY / MARINER

8' LENGTH COMPLETE FUEL LINE ASSEMBLIES

3/8"
FUEL LINE ASSEMBLY

18-8016S-1 *SILVERADO 4000 Premium*

OE# 32-858109Q12,
32-858109K12



18-80402
TANK
CONNECTOR
(SOLD SEPARATELY)

*



18-8091
FUEL
CONNECTOR

*



18-8005S
PRIMER
BULB

*



18-8076
FUEL
CONNECTOR

*



*

FUEL LINE ASSEMBLY COMPONENTS

Has double sealed quick connect type fitting on tank end and clip-on type quick connect on engine end. Primer bulb is included in this 8ft. (2.44m) assembly. Fits Force 40 HP and larger (1993 & Newer), Force 9.9/15/25HP (1998) and all Mercury Mariner outboards using clip-on type disconnects at both tank and engine ends

YAMAHA

8' LENGTH COMPLETE FUEL LINE ASSEMBLIES

3/8"
FUEL LINE ASSEMBLY

18-8017EP-2 *SILVERADO 4000 Premium*

OE# 6YL-24306-60-00



18-8077-1
TANK
CONNECTOR
(SOLD SEPARATELY)

*



18-8076
FUEL
CONNECTOR

*



18-8005EP-1
PRIMER
BULB

*



18-8076
FUEL
CONNECTOR

*



*

FUEL LINE ASSEMBLY COMPONENTS

Fits: F75-F250 and 115-300 HP

* Tanks and Engines for picture purpose only.

YAMAHA

8' LENGTH COMPLETE FUEL LINE ASSEMBLIES

3/8"
FUEL LINE ASSEMBLY

18-8017S-1 *SILVERADO 4000 Premium*

OE# 6YL-24306-60-00



18-8077-1
TANK
CONNECTOR
(SOLD SEPARATELY)



18-80415
FUEL
CONNECTOR

18-8005S
PRIMER
BULB

18-80415
FUEL
CONNECTOR



*

*

FUEL LINE ASSEMBLY COMPONENTS
Fits: F75-F250 and 115-300 HP

UNIVERSAL

8' LENGTH FUEL LINE ASSEMBLIES

5/16"
FUEL LINE ASSEMBLY

18-8013S-1 *SILVERADO 4000 Premium*



18-8004S
PRIMER
BULB



*

*

FUEL LINE ASSEMBLY COMPONENTS

8' LENGTH FUEL LINE ASSEMBLIES

3/8"
FUEL LINE ASSEMBLY

18-8015S-1 *SILVERADO 4000 Premium*



18-8005S
PRIMER
BULB



*

*

FUEL LINE ASSEMBLY COMPONENTS

12' LENGTH COMPLETE FUEL LINE ASSEMBLIES

5/16"
FUEL LINE ASSEMBLY

18-8032S-1 *SILVERADO 4000 Premium*



18-8004S
PRIMER
BULB





















*

*

FUEL LINE ASSEMBLY COMPONENTS

* Tanks and Engines for picture purpose only.

 <p>18-7254 Replaces: Chrysler 3745414 Inlet: 3/8" - 24 • Outlet: 1/2" - 20 Use replacement gasket 18-0889</p>	 <p>18-7255 Replaces: Chrysler 3745415 Inlet: 3/8" - 24 • Outlet: 1/2" - 20</p>	 <p>18-7256 Replaces: Mercruiser 32722, Crusader 32722</p>
 <p>18-7260</p>	 <p>18-7264 Replaces: Chrysler 2279913, 1736073</p>	 <p>18-7265 Replaces: Chris-Craft 16.83-08758, F18308762</p>
 <p>18-7266 Replaces: Ford DJL 9350A</p>	 <p>18-7267 Replaces: Mercruiser 62092, 62092T, 54552 OMC 982063 Gasket included</p>	 <p>18-7268 Replaces: OMC 981650 Volvo 3855276 Dual Diaphragm requires sight glass</p>
 <p>18-7270 Replaces: Crusader 21140 Gasket included</p>	 <p>18-7272 Replaces: Crusader 97039</p>	 <p>18-7274 Replaces: Mercruiser 86246, 86246A1, 78485, 71646 86246T OMC 509409</p>
 <p>18-7275 Replaces: Mercruiser 86247, 86247T, 86247A2, 78820, 63196, 46860 OMC 509410 Gasket included</p>	 <p>18-7278 Replaces: Mercruiser 86234A4, 86234A05, 86234A3, 86234, 77594, 71327, 47585 OMC 985602, 985603, 982240, 509395 Use replacement gasket 18-0889 Use replacement pump filter 18-7860</p>	 <p>18-7281 Replaces: Volvo 826493, 3855276 OMC 981650 Gasket included</p>
 <p>18-7282 Replaces: Mercruiser 42725A3, 861676T09 OMC 509407 Use replacement gasket 18-0889 Use replacement pump filter 18-7784</p>	 <p>18-7283 Replaces: Mercruiser 97401A2, 97401A8, 861678A1, 8M0058164, 97401 OMC 509404 Use replacement gasket 18-0889</p>	 <p>18-7284 Replaces: Mercruiser 41141A2, 862077A1 OMC 509408 Use replacement gasket 18-0889 Use replacement pump filter 18-7784</p>

ALL SIERRA FUEL PUMPS INCLUDE MOUNTING GASKET



18-7286
Replaces: Volvo 841161



18-7288-1
Replaces:
Mercruiser 812454A1, 862048A1, 812454A3,
97399A2, 97399



18-7289
Replaces: OMC 982997
Gasket included



18-7258
Replaces: OMC 380986, GM 6414989



18-7326
ELECTRIC FUEL PUMP
• 8 psi, 25 gpm
Replaces: Mercruiser 805656A2, 805656A6,
805656A5, 805025A2, 861155A6, 861155A5
OMC/Volvo 3858261, 3850809, 3854620, 3857986



18-7330
ELECTRIC FUEL PUMP
• 120 psi
Replaces: OMC/Volvo 3857650,
3855958, 988037, 3854280



18-7331
ELECTRIC FUEL PUMP
• 8 psi, 45 gpm
Replaces: OMC/Volvo 3858714,
3850810, 3857985



18-7332
ELECTRIC FUEL PUMP
Includes bracket and mounting hardware
43 GPH – 7 PSI Max. – 1/4 NPSF for 3/8 hose
– operates with both gasoline and diesel fuel - 24 Volt only



18-7333
ELECTRIC FUEL PUMP
UNIVERSAL
12V, 72GPH at 5.75 PSI, 1/4" NPSF
for 3/8" hose, for use with gasoline and diesel fuel.
OP72533 pressure safety switch recommended.

Year	Engine	Application	OE #	#s Superseded from	Part #
Mercruiser					
1996	262/4.3L	Low Pressure Supply Pump For F.I. System	805656A2		18-7326
1996	262/4.3L	Carbureted w/electric pump - Low PSI	805656A2		18-7326
1992-93	262/4.3L	Carbureted w/electric pump - Low PSI	805656A2		18-7326
OMC					
1992-94	262/4.3L	Low Pressure	3858261	385,080,938,508,103,000,000	18-7326
1997-98	350/5.7L, 454/7.4L, & 502/8.2L	Engines w/MPI - High Pressure	3857650		18-7330
1996	454/7.4L & 502/8.2L	Engines w/MPI - High Pressure	3857650		18-7330
1993-94	4.3L thru 5.8L	Low pressure electric fuel pump	3858261	3850809	18-7326
1992-1994	454/7.4L & 502/8.2L	GM Mark V Eng. - Low Pressure	3858714	3850810, 3857985	18-7331
Volvo-Penta					
1994-99	262/4.3L (HU-WT)	High Pressure pump	3857650		18-7330
1994-99	262/4.3L GL/GS (All)	Carbureted - Low Pressure	3858261	3850809	18-7326
1994-99	262/4.3L GI (HU-WT)	W.Elec. Pump - Low Pressure	3858261	3850809	18-7326
1994-99	454/7.4L & 502/8.2L (HU-WT)	Low pressure system	3858714	3850810, 3857985	18-7331
1993-99	350/5.7L, 454/7.4L, & 502/8.2L	Engines w/MPI - High Pressure	3857650		18-7330
1996-99	454/7.4L & 502/8.2L (HU-WT)	Engines w/MPI - High Pressure	3857650		18-7330
1994-99	5.0L thru 5.8L	Low pressure electric fuel pump	3858261	3850809	18-7326
1994-99	454/7.4L & 502/8.2L (HU-WT)	GM Mark V Eng. - Low Pressure	3858714	3850810, 3857985	18-7331
1992-93	454/7.4L	GM Mark V Eng. - Low Pressure	3858714	3850810, 3857985	18-7331

ALL SIERRA FUEL PUMPS INCLUDE MOUNTING GASKET

Many fuel pumps are often used on similar engines. In order to identify the correct fuel pump for your application, it is necessary to determine the position of the inlet, outlet and separator fitting (where applicable) in relation to the rocker arm. The angle between the rocker arm and the fuel inlet is expressed in terms of clock position. Place pump with rocker arm in the 12 o'clock position. The rocker arm must be held behind the fuel pump body. (The bottom of the fuel pump body must face you.) Observe the relationship of the fuel inlet to the rocker arm. This position is the clock position of the pump. Examples of this in the outline drawing below show that if the fuel inlet is at position "A", it is considered a 6 o'clock pump, if at position "B", a 3 o'clock pump, and at position "C" an 8 o'clock pump.

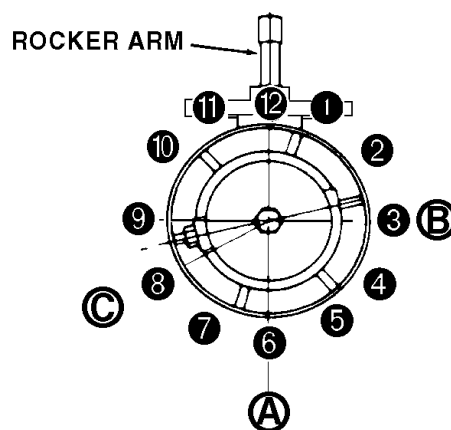

AC STYLE FUEL PUMPS

Engines Manufactured Before February 1, 1979

CLOCK POSITION

Engine	Application	Flange I.D. #	Inlet	Outlet	Separator	Part #
GM153, 230, 250, 292, (4&6 cyl)	Crusader, Mercruiser, OMC	6790	8	4	—	18-7256
Hercules B, D, J, JXD, Series, M Series	Chris-Craft, US Marine, Owens Yacht	7241	6	9	—	—
GM225, PB-V215 (V-6)	OMC, Palmer	40001	8	4	—	—
GM-V-8, 283, 307, 327, 350, 409	Chris-Craft, Owens, Universal, Crusader	40155	9	3	10	18-7260
GM V-8 307, 350	OMC	40778	4	10	9	—
Chrysler V-8 273, 318, 340, 360	Chrysler	40781	4	8	—	18-7264

Engines Manufactured After January 31, 1979

Chrysler V-8 318, 360	Chrysler	6766	4	8	4	18-7254
Chrysler V-8 361, 400, 413, 440	Chrysler	6767	4	8	4	18-7255
GM V-8 305, 350, 400	Mercruiser, OMC, Chris-Craft	41412	9	3	9	18-7265
Ford V-8 302, 351w	Ford, Mercruiser, Commander	41413	5	4	4	18-7266
Ford V-8 302, 351w	OMC, Mercruiser, Pleasurecraft, Thermo-Electron	41414	7	5	4	18-7267
GM V-8 305, 307, 350, 400	Harman, OMC, Thermo-Electron (5.25-6.5 PSI)	41415	7	5	8	18-7268*
GM V-8 454	Mercruiser	41416	9	8	7	—
GM V-8 305, 350, 400	Thermo-Electron (5.75-7PSI)	41417	7	5	8	18-7270
GM V-8 454	Thermo-Electron	41418	3	9	8	18-7271
GM V-8 283, 305, 350, 400	Chris-Craft, Crusader, Hardin, Thermo-Electron (5.75-6.5 PSI)	41419	3	9	8	18-7272
GM V-8 305, 350, 400	Mercruiser	41421	10	9	7	18-7274
GM V-8 454	Hawk, Mercruiser	41422	9	3	7	18-7275

*18-7268 – Dual Diaphragm requires sight glass

CARTER STYLE FUEL PUMPS

Engine	Application	Flange I.D. #	Inlet	Outlet	Sight Tube Connection	Part #
GM (4 & 6 cyl) 153,181,250, 225	Chris-Craft, Indmar, Marine Power, Mercruiser, OMC	60032	8	4	3	18-7278
GM V-8 305, 350	Volvo Penta	61125/6973	9	11	9	18-7281
For Inline (4 cyl) 120, 140, 3.0L, 224 CID	Mercruiser	60337	8	3	8	18-7282
GM V-6 262/4.36	OMC	60201	2	4	9	18-7289
GM V-8 305, 350	Mercruiser, Panther	60600	10	9	4	18-7283
GM V-6 231, 262	Hardin, Mercruiser	60315	8	3	8	18-7284
XP Stamped Steel Pump	Volvo Penta AQ120B (spec# 867465), AQ125A/B, AQ131A/B/C/D, AQ140A (spec# 867464), BB140A, AQ145A, BB145A, AQ151A/B/C, AQ171A/C, AQ230A/B, AQ250A/B, AQ251A	60029	3	6	11	18-7286



18-7628
INTAKE MANIFOLD
 Small-block GM with vortec cylinder heads
 Brass-lined water jackets for salt water applications

ALL SIERRA CARBURETORS INCLUDE BASE GASKET

- Precision remanufactured to meet or exceed OEM specifications
- Re-calibrated and re-engineered to maximize fuel efficiency and performance
- All carburetors are flow tested throughout the entire throttle range
- Fuel mixture and idle settings are pre-set to ensure that only minor idle and choke adjustments are necessary during installation
- All bases are resurfaced and throttle shaft bushings replaced

UNIVERSAL CARBURETORS



18-7635
CARBURETOR
(REMANUFACTURED)
 300 CFM Holley 2V
 Use replacement gasket **18-0360**



18-7636
CARBURETOR
(REMANUFACTURED)
 500 CFM Holley 2V
 Use replacement gasket **18-0994**



18-7637
CARBURETOR
(REMANUFACTURED)
 600 CFM Holley 4V (Front inlet)
 Gasket included • Use replacement gasket **18-0647**



18-7638
CARBURETOR
(REMANUFACTURED)
 600 CFM Holley 4V-side inlet



18-7640
CARBURETOR
(REMANUFACTURED)
 Universal Q-jet with electric choke
 Use replacement carb kit **18-7018**
 Use replacement gasket **18-0462**

MERCUISE CARBURETORS

NEW CASTING NON-REMANUFACTURED



18-7370N
CARBURETOR
 Replaces: 3310-860070A2, 3310-806077A2, 3310-806078A2, 1389-9562A1, 1389-9350A2, 1389-8490A2, 1389-815396A2, 3310-806077A2
 For: MCM 120/2.5L & 140/3.0L
 Gasket included • Use replacement gasket **18-0994**



18-7373N
MERCARB 2V
CARBURETOR
 Replaces:
 Mercruiser 3310-864941A01
 2002-2004 4.3L engines (s/n OM615000-OW300012)
 Use Replacement Carb Kit **18-7098-1**
 Gasket included • Use replacement gasket **18-0994**



18-7375N
CARBURETOR
 Replaces: 3310-864942A01, 3310-861448A1
 For: 1998-2004 MCM 5.0L
 Gasket included • Use replacement gasket **18-0994**



18-7376N
CARBURETOR
 Replaces: 3310-864943A01, 3310-861245A1
 For: 1998 and newer 5.7L applications
 Gasket included • Use replacement gasket **18-0994**



18-7615N
Q-JET CARBURETOR
 Replaces: 1347-816373A4, 1347-804624R1, 1347-804624R02
 Use Replacement Carb Kit **18-7095**
 Gasket included • Use replacement gasket **18-2848**

ALL SIERRA CARBURETORS INCLUDE BASE GASKET

 <p>18-7603-1 CARBURETOR (REMANUFACTURED) 2 Barrel - Rochester Replaces: Mercruiser 1347-818622, 1376-5659A1, 1347-818622 1, 1347-818622R02 Rochester 7044185 Use replacement carb kit 18-7075 Use replacement gaskets 18-0994 & 18-0434</p>	 <p>18-7604-1 CARBURETOR (REMANUFACTURED) 4 Barrel - Rochester Replaces: Mercruiser 3304-9354A2, 1347-804623R02 Use replacement carb kit 18-7095 Use replacement gasket 18-2848</p>	 <p>18-7605-1 CARBURETOR (REMANUFACTURED) 4 Barrel - Rochester Replaces: Mercruiser 1347-9661A3, 1347-804623A1, 1347-804623R02 Rochester 17057283, 17057285, 17059291, 17059292, 17080564, 17080565 Use replacement carb kit 18-7095 Use replacement gasket 18-2848</p>	 <p>18-7607-1 CARBURETOR (REMANUFACTURED) Replaces: Rochester 17082403 For: Rochester Carb: Crusader 454 Use replacement carb kit 18-7095 Use replacement gasket 18-2848</p>
 <p>18-7608-1 CARBURETOR (REMANUFACTURED) 2 Barrel - Rochester Replaces: Mercruiser 1347-818620, 1347-818620 1, 1347-818620R02, Rochester 7040080, 7040083, 7040089, 7042183, 7043183, 7043184, 17059057, 17059052 Use replacement carb kit 18-7070 Use replacement gasket 18-0356</p>	 <p>18-7609-1 CARBURETOR (REMANUFACTURED) 2 Barrel - Rochester Replaces: Mercruiser 1347-818619, 1347-818619 1, 1347-818619 1R02, Rochester 7036543, 7040082, 7041369, 7043182, 7044182, 17059054 Use replacement carb kit 18-7070 Use replacement gasket 18-0356</p>	 <p>18-7610-1 CARBURETOR (REMANUFACTURED) 2 Barrel - Rochester Replaces: Mercruiser 1347-818621, 1347-818621 1, 1347-818621 1R02 Rochester 17081060 Use replacement carb kit 18-7070 Use replacement gasket 18-0356</p>	 <p>18-7611-2 CARBURETOR (REMANUFACTURED) 2 Barrel - Rochester Replaces: Mercruiser 3310-807312A1, 3310-807312R02 Use replacement carb kit 18-7098-1 Use replacement gasket 18-0994</p>
 <p>18-7613-1 CARBURETOR (REMANUFACTURED) 4 Barrel - Carter (Weber) Replaces: Mercruiser 3310-806969A1, 3310-806969R01 Use replacement carb kit 18-7748 Use replacement gasket 18-0467</p>	 <p>18-7615-1 CARBURETOR (REMANUFACTURED) 4 Barrel - Rochester Replaces: Mercruiser 1347-816373A4, 1347-804624R1, 1347-804624R02 Rochester 17057298, 17059280, 17059288, 17080561, 17085013 Use replacement carb kit 18-7095 Use replacement gasket 18-2848</p>	 <p>18-7616-1 CARBURETOR (REMANUFACTURED) 4 Barrel - Rochester Replaces: Mercruiser 1347-8288A1, 1347-804626R02 Rochester 1708563, 17057287, 17059287, 17059290, 17080560 Use replacement carb kit 18-7072 Use replacement gasket 18-2848</p>	
 <p>18-7639 CARBURETOR (REMANUFACTURED) Replaces: 3310-864943A01, 861245A1 Mercarb-5.7L 2V 1998 and newer 5.7L (OL010337-OW300754) & 5.7L MIE (OL002003-OW090899) Use replacement carb kit 18-7098-1 Use replacement gasket 18-0994</p>	 <p>18-7617-1 CARBURETOR (REMANUFACTURED) 4 Barrel - Rochester Replaces: Mercruiser 1347-9863A3, 1347-804625R1, 1347-804625R02 Rochester 17059280 Use replacement carb kit 18-7095 Use replacement gasket 18-2848</p>	 <p>18-7618-1 CARBURETOR (REMANUFACTURED) 4 Barrel - Rochester Replaces: Mercruiser 13478289A1, 1347-804624R1, 1347-804624R02 Rochester 17059289, 7044291, 17080561, 17080562 Use replacement carb kit 18-7095 Use replacement gasket 18-2848</p>	 <p>18-7619-1 CARBURETOR (REMANUFACTURED) 4 Barrel - Rochester Replaces: Mercruiser 1347-9142A2, 1347-8460 A3 Rochester 17081299, 17083522, 17059283, 17059298 Use replacement carb kit 18-7077 Use replacement gasket 18-0462</p>

CARB APPLICATION BEGINS ON NEXT PAGE

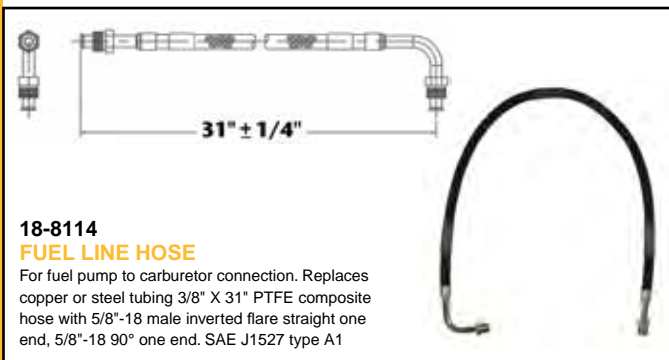

18-8114
FUEL LINE HOSE

For fuel pump to carburetor connection. Replaces copper or steel tubing 3/8" X 31" PTFE composite hose with 5/8"-18 male inverted flare straight one end, 5/8"-18 90° one end. SAE J1527 type A1

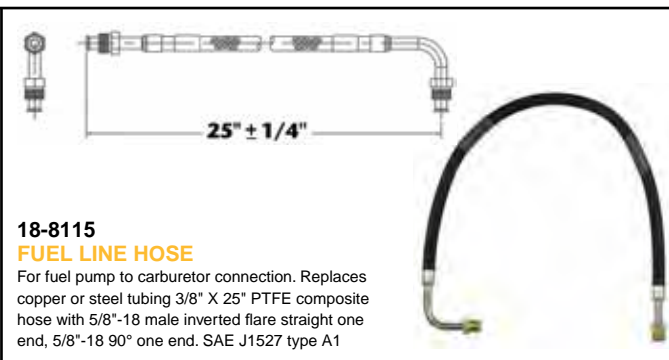

18-8115
FUEL LINE HOSE

For fuel pump to carburetor connection. Replaces copper or steel tubing 3/8" X 25" PTFE composite hose with 5/8"-18 male inverted flare straight one end, 5/8"-18 90° one end. SAE J1527 type A1

MERCURISER CARBURETORS APPLICATION

Model	Year	# of Cyl.	Beginning Serial #	Ending Serial #	Original Carb #	Replacement Carb #	Mfg. Carb.	Carb Code & Model	Carb #
90	1970-1971	L4	2851424	3225967	1351-4263A1	1347-818619 1	7040082	R2/2GC	18-7609-1
90	1972	L4	3225868	3226957	1351-4263A2	1347-818619 1	7041369	R2/2GC	18-7609-1
110	1963-1966	L4	1357370	2044033	1336-2076	—	7036543	R2/2GC	18-7609-1
120	1972-1973	L4	3377341	3770649	1351-4263A3	1347-818619 1	7041369	R2/2GC	18-7609-1
120	1974-1975	L4	3770650	4469865	1351-5202A1	1347-818619 1	7043182	R2/2GC	18-7609-1
120	1976-1978	L4	4469866	5192048	1351-6065A2	1347-818619 1	7044182	R2/2GC	18-7609-1
120	1979-1982	L4	5192049	6229717	1351-7354A1	1347-818619 1	17059054	R2/2GC	18-7609-1
120/2.5L	1983-1989	L4	6229718	OC853255	1351-8480A2	1348-818621 1	17081060	R2/2GC	18-7610-1
140	1970	L4	2816417	2911439	1351-4032A1	1347-818620 1	7040080	R2/2GC	18-7608-1
140	1970-1973	L4	2911440	3771644	1351-4293A1	1347-818620 1	7040084	R2/2GC	18-7608-1
140	1974-1978	L4	3771645	5157668	1351-5203A1	1347-818620 1	7043184	R2/2GC	18-7608-1
140	1979-1982	L4	5157669	6229717	1351-7355A1	1347-818620 1	17059052	R2/2GC	18-7608-1
140/3.0L	1983-1989	L4	6229718	OC856556	1351-8480A2	1348-818621 1	17081060	R2/2GC	18-7610-1
165 (6 Cyl)	1970-1972	L6	2770032	3354791	1351-4282A1	1347-818620 1	7040083	R2/2GC	18-7608-1
165 (6 Cyl)	1972-1973	L6	3354702	3774864	1351-4871A1	1347-818620 1	7042183	R2/2GC	18-7608-1
165 (6 Cyl)	1974-1978	L6	3774865	5178958	1351-5204A1	1347-818620 1	7043183	R2/2GC	18-7608-1
488	—	—	6170297	1347-8460 6916778	1347-9142A2	—	17059283 17059298 17083522 17081299	R4/4ME	18-7619-1
165 (6 Cyl)	1979-1981	L6	5178959	5813433	1351-7356A1	1347-818620 1	17059050	R2/2GC	18-7608-1
180/1903.7LX	—	—	6916779	Later	1347-8460 1347-9142A2	—	17059283 17059298 17083522 17081299 17083522	R4/4ME R4/4ME	18-7619-1
205/4.3LX	1985-1991	V-6	OA331455	OD714369	3304-9354A2	3304-9354A2	N/A	R4/4MV	18-7604-1
898/200/5.0L	1987-95	V-8	OB525982	OF600999	1389-9670A2	3310-807312A1	N/A	M2/MERCARB	18-7611-2
888	1971-1977	V-8	3108723	4887829	1376-5659A1	1376-818622 1	7044185	R2/2GC	18-7603-1
228	1977-1978	V-8	4765100	5069430	1347-6427A1	1347-9661A3	17057282	R4/4MV	18-7605-1
228 TR & MIE	1977-1978	V-8	4765100	5069430	1347-6438A1	1347-9661A3	17057283	R4/4MV	18-7605-1
228	1978-1981	V-8	5069431	6021783	1347-7361A1	1347-9661A3	17059292	R4/4MV	18-7605-1
228	1982	V-8	6021784	6218461	1347-8296A4	1347-9661A3	17080565	R4/4MV	18-7605-1
223/230/5.0LX	1983-1995	V-8	6218462	OF600999	1347-9661A3	1347-9661A3	17080565	R4/4MV	18-7605-1
228 MIE	1978-1982	V-8	5069431	6040745	1347-7364A1	1347-9661A3	17059291	R4/4MV	18-7605-1
230 MIE	1982-1987	V-8	6040746	OB788151	1347-8290A1	1347-9661A3	17080564	R4/4MV	18-7605-1
255 MIE (GM)	1975-1978	V-8	4175500	4924564	1347-5732A1	1347-8289A1	7044291	R4/4MV	18-7618-1
255 MIE (GM)	1978	V-8	4924565	5195908	1347-7062A1	1347-8289A1	17059289	R4/4MV	18-7618-1
255 MIE (GM)	1979-1980	V-8	5195909	5907057	1347-7365A1	1347-8289A1	17059289	R4/4MV	18-7618-1
260 MIE	1980-1986	V-8	5907058	OB522505	1347-8289A1	1347-8289A1	17080562	R4/4MV	18-7618-1
260/5.7MIE	1987-1993	V-8	OB522506	OF024999	1347-9662A4	1347-816373A4	17080561	R4/4MV	18-7615-1
255	1975-1976	V-8	41745500	4767999	1347-5732A1	1347-8289A1	7044291	R4/4MV	18-7618-1
260	1978	V-8	4908850	5060805	1347-6492A1	1347-816373A4	17057298	R4/4MV	18-7615-1
260	1978-1982	V-8	5060806	6024393	1347-7362A1	1347-816373A4	17059288	R4/4MV	18-7615-1
260	1982-1986	V-8	6024393	OB525981	1347-8292A4	1347-816373A4	17080561	R4/4MV	18-7615-1
260/5.7L ALPHA	1987-1993	V-8	OB525982	OF000454	1347-9662A4	1347-816373A4	17080561	R4/4MV	18-7615-1
5.7L(2BBL)	1996-1997	V-8	OF601000	OK999999	3310-807312A1	3310-807312A1	—	M2/MERCARB	18-7611-1

APPLICATION CONTINUED ON NEXT PAGE

MERCURISER CARBURETORS APPLICATION

Model	Year	# of Cyl.	Beginning Serial #	Ending Serial #	Original Carb #	Replacement Carb #	Mfg. Carb.	Carb Code & Model	Carb #
5.7L (Gen II)	1998-2004	V-8	OL010037	OW300754	3310-864943101	3310-864943101	N/A	M2/MERCARB	18-7639
5.7L BRAVO (w/o High Rise Intake)	1987-1991	V-8	OB525982	OD617327	1347-9662A4	1347-816373A4	17080561	R4/4MV	18-7615-1
5.7L BRAVO (w/ High Rise Intake)	1987-1991	V-8	OB525982	OD617327	1347-8289A1	1347-8289A1	17080562	R4/4MV	18-7618-1
350 MAGNUM ALPHA	1986-1991	V-8	OA635178	OD617327	1347-8289A1	1347-8289A1	17080562	R4/4MV	18-7618-1
5.7L SKI	1985-1993	V-8	OA338533	OF025099	1347-9415T	1347-9415T	17085013	R4/4MV	18-7615-1
5.7L SKI(2BBL)	1996-1997	V-8	OF775200	OK999999	3310-807312A1	3310-807312A1	—	M2/MERCARB	18-7611-2
300MR/TRS	1985-1986	V-8	6668677	OB430367	1347-7498A7	1347-7498A7	17059280	R4/4MV	18-7615-1
330 MCM	1977-1978	V-8	4623115	5027230	1347-6493A1	1347-8291A3	17057287	R4/4MV	18-7616-1
330 MCM	1977-1981	V-8	5027231	6083144	1347-7363A1	1347-8291A3	17059290	R4/4MV	18-7616-1
330 MCM	1982-1987	V-8	6083145	OB816540	1347-8291A3	1347-8291A3	1708563	R4/4MV	18-7616-1
330 MIE	1977-1978	V-8	4623115	5226384	1347-6493A1	1347-8288A1	17057287	R4/4MV	18-7616-1
330 MIE	1979-1980	V-8	5226385	5889913	1347-7366A1	1347-8288A1	17059287	R4/4MV	18-7616-1
340/7.4L MIE	1981-1992	V-8	5889914	OD715493	1347-8288A1	1347-8288A1	17080560	R4/4MV	18-7616-1
7.4L MIE	1995-1997	V-8	OF350000	OK999999	3310-806969A1	3310-806969A1	9780	WEBER	18-7613-1
7.4L BRAVO I/II	1988-1991	V-8	OB771113	OD603117	1347-8291A3	1347-8291A3	17080563	R4/4MV	18-7616-1
7.4L BRAVO I/II	1995-1997	V-8	OF352000	OK999999	3310-806969A1	3310-806969A1	9780	WEBER	18-7613-1
7.4L BRAVO III	1996-1997	V-8	OF800700	OK999999	3310-806969A1	3310-806969A1	9780	WEBER	18-7613-1
370/400	1978-1987	V-8	4179554	OB714586	1347-7498A2	1347-9863A3	17059280	R4/4MV	18-7617-1
454 MAG ALPHA	1986-1988	V-8	OA631894	OB785148	1347-8291A3	1347-8291A3	17080563	R4/4MV	18-7616-1
454 MAG BRAVO	1988-1992	V-8	OB721206	OD808068	1347-7498A2	1347-9863A3	17059280	R4/4MV	18-7617-1



ALL SIERRA CARBURETORS INCLUDE BASE GASKET

**NEW CASTING
NON-REMANUFACTURED**



**18-7615N
Q-JET CARBURETOR**
Replaces: 1347-816373A4,
1347-804624R1,
1347-804624R02
Use replacement carb kit **18-7095**

Heat riser choke



**18-7608-1
CARBURETOR
(REMANUFACTURED)**
2 Barrel Rochester
Replaces: OMC 381668, 980528,
982219, 982217
Use replacement carb kit **18-7070**
Use replacement gasket **18-0356**

Heat riser choke



**18-7609-1
CARBURETOR
(REMANUFACTURED)**
2 Barrel Rochester
Replaces: OMC 382733, 980530,
982217, 984180, 381494, 772831
Use replacement carb kit **18-7070**
Use replacement gasket **18-0356**



**18-7615-1
CARBURETOR
(REMANUFACTURED)**
4 Barrel Rochester
Replaces: OMC 981705, 982223, 983855,
981359, 981564, 985822, 981803, 981428
Use replacement carb kit **18-7095**
Use replacement gasket **18-2848**



**18-7605-1
CARBURETOR
(REMANUFACTURED)**
4 Barrel Rochester
Replaces: OMC 382821, 383766, 384194
Use replacement carb kit **18-7095**
Use replacement gasket **18-2848**



**18-7619-1
CARBURETOR
(REMANUFACTURED)**
For: V-8, 305 & 350 CID
Models: AQ225B, C, D, E, F, 225 A,B,
BB225 A, AV, B, C, 290 A, AQ260A, B,
260 A, AV, B, C, 501 A/M S4A, 570 M S4A
Use replacement carb kit **18-7095**
Use replacement gasket **18-0462**

OMC STERN DRIVE CARBURETOR APPLICATION

HP	MODEL	YEAR	OMC CARBURETOR #	MFG CARBURETOR #	CARB. CODE & MODEL	PART #
80	80	1968-1969	382733, 772831	7028085, 17059053, 17086064, 17087311	R2, 2GC	18-7609-1
90	90	1970-1971	382733, 772831	7028085, 17059053, 17086064, 17087311	R2, 2GC	18-7609-1
120	120 (400 SERIES)	1972-1986	381668, 980528, 982219	7044186, 17059056	R2, 2GC	18-7608-1
140	140 (400 SERIES)	1973-1985	979821, 980530, 982217, 984180	17086107	R2, 2GC	18-7608-1
155	155	1967-1972	772831	7026180	R2, 2GC	18-7609-1
165	165	1972-1976	979821, 980530	17086107	R2, 2GC	18-7609-1
185	185	1989	984180	17086064	R2, 2GC	18-7609-1
200	200	1966-1968	381494	7025187	R2, 2GC	18-7609-1
210	210	1968-1972	382821, 383866	7028282, 7028280	R4, 4MV	18-7605-1
214	215	1971-1976	382821	7028280	R4, 4MV	18-7605-1
225	225	1971-1976	382821	7028280	R4, 4MV	18-7605-1
230	230	1971-1976	382821	7028280	R4, 4MV	18-7605-1
230	230 (800 SERIES)	1979-1989	981705, 982223	17057290, 17059285, 17059286, 17086117	R4, 4MV	18-7615-1
245	245	1972-1975	384194	7040284	R4, 4MV	18-7605-1
250	250	1970-1974	384194	7040284	R4, 4MV	18-7605-1
260	260 (800 SERIES)	1975-1976	384194	7040284	R4, 4MV	18-7605-1
260	260 (800 SERIES)	1979-1989	982223	17057290, 17059285, 17059286, 17086117	R4, 4MV	18-7615-1
	2.5L	1982-1986	982219, 982217	17059056, 17059053	R2, 2GC	18-7608-1
	3.0L	1982-1986	982219, 982217	17059056, 17059053	R2, 2GC	18-7608-1
	3.0L	1987-1990	984180	17086064	R2, 2GC	18-7608-1
	3.8L (4V)	1979-1985	983855	17082515, 17085010	R4, 4MV	18-7615-1
	4.3L (4V)	1979-1989	983855	17082515, 17085010	R4, 4MV	18-7615-1
	5.0L (GM / 4V)	1979-1989	982223	17057290, 17059285, 17059286, 17086117	R4, 4MV	18-7615-1
	5.7L (4V)	1979-1989	982223	17057290, 17059285, 17059286, 17086117	R4, 4MV	18-7615-1
	305 CID ①	1977-1983	981359, 982215,	17057290, 17059285, 17059286, 17086117	R4, 4MV	18-7615-1
	350 CID ①	1977-1983	981564, 982223	17057290, 17059285, 17059286, 17086117	R4, 4MV	18-7615-1
	350 (4V)	1988-1989	985822	17057290, 17059285, 17059286, 17086117	R4, 4MV	18-7615-1
	454 CID ①	1977-1978	981803, 981428	17057290, 17059285, 17059286, 17086117	R4, 4MV	18-7615-1

① In-Board

18-7039
CARB KIT

Contains adjustable needles & seats

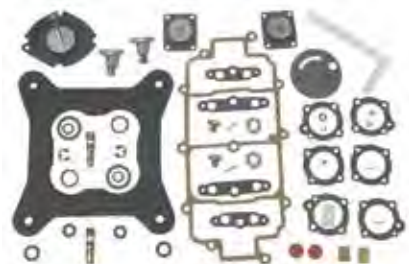

18-7095
CARB KIT

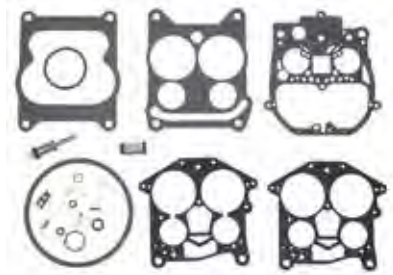

CARBURETOR TO CARBURETOR KIT INTERCHANGE

Carburetor #	Carb. Kit #	Float #	Carburetor #	Carb. Kit #	Float #	Carburetor #	Carb. Kit #	Float #
INBOARD			CARTER/WEBER (CONT.)			FORD (CONT.)		
CARTER/WEBER			CARTER/WEBER (CONT.)			FORD (CONT.)		
2617	18-7725	—	6212	18-7089	—	E8JL-9510-DA	18-7017	—
2618	18-7725	—	6310	18-7022	—	E9JL-DA	18-7017	—
2669	18-7025	—	6446	18-7092	—	F1JL-AA	18-7236	—
2853	18-7022	18-7201	9263	18-7091	—	F1JL-EA	18-7727	—
2911	18-7725	—	9264	18-7091	—	F1JL-BA	18-7729	—
2912	18-7725	—	9661	18-7749	—	F1JL-CA	18-7245	—
2935	18-7725	—	9770	18-7749	—	F1JL-EA	18-7727	—
2955	18-7022	—	9781	18-7749	—	HOLLEY		
3035	18-7725	—	9770SA	18-7749	—	R-4397A	18-7096	—
3041	18-7022	18-7201	9781S	18-7749	—	R-4473A	18-7096	18-7206
3116	18-7022	18-7201	9600	18-7748	—	R-4473AAS	18-7096	18-7206
3117	18-7725	—	9662	18-7748	—	R-4607A	18-7096	18-7206
3157	18-7725	—	9663	18-7748	—	R-4608A	18-7096	18-7206
3195	18-7725	—	9665	18-7748	—	R-4608AAS	18-7096	18-7206
3204	18-7022	18-7201	9666	18-7748	—	R-6150A	18-7081	18-7206
3205	18-7025	—	9772	18-7748	—	R-6151A	18-7096	18-7206
3212	18-7726	—	9773	18-7748	—	R-6151AAA	18-7096	18-7206
3213	18-7091	—	9774	18-7748	—	R-6152A	18-7096	18-7206
3214	18-7091	—	9776	18-7748	—	R-6152AAA	18-7096	18-7206
3285	18-7022	18-7201	9776	18-7748	—	R-6317A	18-7081	18-7206
3314	18-7022	18-7201	9777	18-7748	—	R-6317-1A	18-7081	18-7206
3354	18-7022	18-7201	9780	18-7748	—	R-6407A	18-7096	18-7206
3355	18-7725	—	9782	18-7748	—	R-6647A	18-7728	—
3389	18-7725	—	9665S	18-7748	—	R-6647AAA	18-7728	—
3390	18-7725	—	9772SA	18-7748	—	R-6576A	18-7096	18-7206
3392	18-7091	—	9776S	18-7748	—	R-7036A	18-7081	18-7206
3543	18-7091	—	9776SA	18-7748	—	R-7128A	18-7017	—
3660	18-7022	—	9776SB	18-7748	—	R-7159A	18-7017	—
3887	18-7022	18-7201	9779S	18-7748	—	R-7163A	18-7017	—
3951	18-7080	—	9780S	18-7748	—	R-9392A	18-7096	—
3971	18-7080	—	FORD			R-9393A	18-7729	—
3979	18-7726	—	C9FF-9510-D	18-7096	18-7206	R-9394A	18-7729	—
3980	18-7089	—	C9FF-9510-E	18-7096	18-7206	R-50399A	18-7729	—
3981	18-7726	—	D1FF-9510-LA	18-7081	18-7206	R-50399-1A	18-7729	—
4157	18-7022	18-7201	D1FF-9510-MA	18-7096	18-7206	R-50405A	18-7729	—
4207	18-7080	—	D1FF-9510-NA	18-7096	18-7206	R-50405-1A	18-7729	—
4208	18-7080	—	D1JJ-9510-B	18-7081	18-7206	R-50417A	18-7236	—
4268	18-7726	—	D2JL-9510-C	18-7096	18-7206	R-50417-1A	18-7236	—
4394	18-7080	—	D2JL-9510-E	18-7096	18-7206	R-50418A	18-7729	—
4476	18-7091	—	D3JL-9510-S	18-7081	18-7206	R-50419A	18-7729	—
4695	18-7023	—	D4JL-9510-F	18-7017	—	R-50419-1A	18-7237	—
4699	18-7089	—	D4JL-9510-G	18-7017	—	R-50419-2A	18-7237	—
6117	18-7023	—	D4JL-9510-J	18-7017	—	R-50461A	18-7236	—
6130	18-7089	—	E0JL-9510-CA	18-7096	—	R-50461-1A	18-7236	—

CARBURETOR TO CARBURETOR KIT INTERCHANGE (Cont.)

Carburetor #	Carb. Kit #	Float #	Carburetor #	Carb. Kit #	Float #	Carburetor #	Carb. Kit #	Float #
HOLLEY (CONT.)			HOLLY (CONT.)			MERCURY MARINE (CONT.)		
R-50462A	18-7729	—	R-84022AA	18-7040	—	1347-7498A2	18-7095	18-7201
R-50462-1A	18-7729	—	R-84023AA	18-7039	—	1347-7498A7	18-7095	18-7201
R-50463A	18-7237	—	R-84024AA	18-7040	—	1347-8288A1	18-7095	18-7201
R-50463-1A	18-7237	—	R-84026AA	18-7040	—	1347-8289A1	18-7095	18-7201
R-50464A	18-7017	—	R-84026-1AA	18-7040	—	1347-8290A1	18-7095	18-7201
R-50467A	18-7236	—	R-84026-2AA	18-7040	—	1347-8291A3	18-7095	18-7201
R-50467-1A	18-7236	—	R-84028AA	18-7039	—	1347-8292A4	18-7095	18-7201
R-50468A	18-7729	—	R-84037AA	18-7040	—	1347-8296A4	18-7095	18-7201
R-50468-1A	18-7729	—	R-84038AA	18-7039	—	1347-8460A3	18-7077	18-7201
R-50469A	18-7245	—	R-84039AA	18-7039	—	1347-9142A2	18-7095	18-7201
R-50469-1A	18-7245	—	R-84040AA	18-7040	—	1347-9415T	18-7095	18-7201
R-50470A	18-7017	—	R-84041AA	18-7070	—	1347-9661A3	18-7095	18-7201
R-50483A	18-7727	—	R-84042AA	18-7040	—	1347-9662A4	18-7095	18-7201
R-80262A	18-7729	—	R-84044AA	18-7039	—	1347-9863A3	18-7095	18-7201
R-80263A	18-7236	—	R-84044-1AA	18-7039	—	1351-3635A1	18-7070	18-7200
R-80264A	18-7729	—	R-84046A	18-7727	—	1351-4032A1	18-7070	18-7200
R-80265A	18-7237	—	R-84046AA	18-7039	—	1351-4263A1	18-7070	18-7200
R-80311A	18-7241	—	MERCURY MARINE			1351-4263A2	18-7070	18-7200
R-80311-1A	18-7241	—	1336-2076	18-7070	18-7200	1351-4263A3	18-7070	18-7200
R-80311-2A	18-7241	—	1336-3594A1	18-7070	18-7200	1351-4282A1	18-7070	18-7200
R-80312A	18-7238	—	1337-2103	18-7078	—	1351-4293A1	18-7070	18-7200
R-80312-1A	18-7238	—	1337-2604	18-7078	—	1351-4871A1	18-7070	18-7200
R-80313A	18-7246	—	1338-2161	18-7071	—	1351-5202A1	18-7070	18-7200
R-80313-1A	18-7246	—	1338-2166	18-7071	—	1351-5203A1	18-7070	18-7200
R-80315A	18-7237	—	1338-2428	18-7071	—	1351-5204A1	18-7070	18-7200
R-80315-1A	18-7237	—	1338-2431	18-7071	—	1351-6065A2	18-7070	18-7200
R-80316A	18-7246	—	1338-2608	18-7071	—	1351-7354A1	18-7070	18-7200
R-80316-1A	18-7246	—	1338-2609	18-7071	—	1351-7355A1	18-7070	18-7200
R-80318A	18-7017	—	1338-2633	18-7070	18-7200	1351-7356A1	18-7070	18-7200
R-80318-1A	18-7017	—	1338-2991	18-7070	18-7200	1351-8480A2	18-7070	18-7200
R-80319A	18-7245	—	1346-2770	18-7080	—	1356-4066	18-7096	18-7206
R-80319-1A	18-7245	—	1347-3237A2	18-7072	18-7201	1356-4642	18-7081	18-7206
R-80320A	18-7236	—	1347-3237A3	18-7072	18-7201	1356-5155	18-7096	18-7206
R-80320-1A	18-7236	—	1347-3237A4	18-7072	18-7201	1356-5169	18-7096	18-7206
R-80321A	18-7246	—	1347-3342	18-7072	18-7201	1376-5659A1	18-7075	18-7202
R-80321-1A	18-7246	—	1347-3353	18-7072	18-7201	1376-5659A2	18-7075	18-7202
R-80328A	18-7239	—	1347-3689A1	18-7072	18-7201	1376-5744A1	18-7075	18-7202
R-80328-1A	18-7239	—	1347-4179A1	18-7072	18-7201	1376-5990A1	18-7076	18-7202
R-80328-2A	18-7239	—	1347-4179A2	18-7072	18-7201	1376-6152A1	18-7075	18-7202
R-80330A	18-7241	—	1347-4180A1	18-7072	18-7201	1376-6491A1	—	18-7202
R-80330-1A	18-7241	—	1347-4533A1	18-7072	18-7201	1376-8295A3	—	18-7202
R-80378A	18-7242	—	1347-5326A2	18-7072	18-7201	1389-815396A2	18-7098-1	18-7202
R-80378-1A	18-7242	—	1347-5732A1	18-7072	18-7201	1389-815397A2	18-7098-1	18-7202
R-80382A	18-7244	—	1347-5981A1	18-7072	18-7201	1389-8488A2	18-7097	18-7202
R-80382-1A	18-7244	—	1347-6427A1	18-7072	18-7201	1389-8489A5	18-7097	18-7202
R-80383A	18-7245	—	1347-6438A1	18-7072	18-7201	1389-8490A2	18-7097	18-7202
R-80383-1A	18-7245	—	1347-6492A1	18-7072	18-7201	1389-9562A1	18-7098-1	18-7202
R-80385A	18-7246	—	1347-6493A1	18-7072	18-7201	1389-9563A1	18-7098-1	18-7202
R-80386A	18-7244	—	1347-7062A1	18-7072	18-7201	1389-9564A1	18-7098-1	18-7202
R-80386-1A	18-7244	—	1347-7361A1	18-7095	18-7201	1389-9670A2	18-7098-1	18-7202
R-80390A	18-7243	—	1347-7362A1	18-7095	18-7201	3300-8886A2	18-7095	18-7201
R-80364	18-7729	—	1347-7363A1	18-7095	18-7201	3304-9353A2	18-7097	18-7202
R-80434	18-7730	—	1347-7364A1	18-7095	18-7201	3304-9354A2	18-7095	18-7201
R-80444A	18-7241	—	1347-7365A1	18-7095	18-7201	3304-9565A1	18-7098-1	18-7202
R-84018AA	18-7039	—	1347-7366A1	18-7095	18-7201			

CARBURETOR TO CARBURETOR KIT INTERCHANGE (Cont.)

Carburetor #	Carb. Kit #	Float #	Carburetor #	Carb. Kit #	Float #	Carburetor #	Carb. Kit #	Float #
ROCHESTER			ROCHESTER (CONT.)			ROCHESTER (CONT.)		
17056287	18-7072	18-7201	17083110	18-7086	18-7200	7025082	18-7070	18-7200
17057130	18-7086	18-7202	17083515	18-7095	18-7201	7025180	18-7078	—
17057131	18-7086	18-7202	17083522	18-7095	18-7201	7025183	18-7071	—
17057132	18-7076	18-7202	17084001	18-7095	18-7201	7025184	18-7071	—
17057133	18-7086	18-7202	17084516	18-7095	18-7201	7025188	18-7070	18-7200
17057134	18-7086	18-7202	17085008	18-7086	18-7200	7025564	18-7078	—
17057138	18-7086	18-7202	17085010	18-7072	18-7201	7025638	18-7071	—
17057139	—	18-7202	17085013	18-7095	18-7201	7025662	18-7071	—
17057282	18-7072	18-7201	17086064	18-7070	18-7200	7025756	18-7078	—
17057283	18-7072	18-7201	17086069	18-7095	18-7201	7026084	18-7070	—
17057287	18-7072	18-7201	17086107	18-7086	18-7200	7026088	18-7070	18-7200
17057290	18-7095	18-7201	17086115	18-7095	18-7201	7027080	18-7072	18-7201
17057292	18-7072	18-7201	17086116	18-7095	18-7201	7027081	18-7072	18-7201
17057295	18-7072	18-7201	17086117	18-7095	18-7201	7027083	18-7072	18-7201
17057298	18-7072	18-7201	17087311	18-7070	18-7200	7027088	18-7072	18-7201
17057299	18-7072	18-7201	17087311	18-7095	18-7201	7028085	18-7070	18-7200
17058280	18-7072	18-7201	7013071	18-7019	—	7028086	18-7070	18-7200
17059050	18-7070	18-7200	7015087	—	18-7200	7028188	18-7070	18-7200
17059051	18-7086	18-7200	7015088	—	18-7200	7028280	18-7072	18-7201
17059052	18-7070	18-7200	7015089	—	18-7200	7028282	18-7072	18-7201
17059053	18-7070	18-7200	7015090	18-7019	—	7029280	18-7072	18-7201
17059054	18-7070	18-7200	7015091	18-7019	—	7029285	18-7072	18-7201
17059055	—	18-7200	7015097	—	18-7200	7036543	18-7070	18-7200
17059056	—	18-7200	7015098	—	18-7200	7036646	18-7070	18-7200
17059057	18-7086	18-7200	7019082	18-7070	18-7200	7037082	18-7072	18-7201
17059058	18-7086	18-7200	7019084	18-7019	—	7040080	18-7070	18-7200
17059059	18-7086	18-7202	7020082	—	18-7200	7040081	18-7070	18-7200
17059060	18-7086	18-7200	7020084	18-7019	—	7040082	18-7070	18-7202
17059280	18-7095	18-7201	7020085	18-7019	—	7040083	18-7070	18-7200
17059283	18-7095	18-7201	7020087	18-7078	—	7040084	18-7070	18-7200
17059285	18-7095	18-7201	7020088	18-7070	18-7200	7040283	18-7072	18-7201
17059286	18-7095	18-7201	7020991	18-7078	—	7040284	18-7072	18-7201
17059287	18-7095	18-7201	7020992	18-7070	18-7200	7041187	—	18-7200
17059288	18-7095	18-7201	7020993	18-7070	18-7200	7041280	18-7072	18-7201
17059289	18-7095	18-7201	7020994	18-7071	—	7041285	18-7072	18-7201
17059290	18-7095	18-7201	7020995	18-7078	—	7041369	18-7070	18-7200
17059291	18-7095	18-7201	7020996	18-7071	—	7041831	18-7072	18-7201
17059292	18-7095	18-7201	7023080	—	18-7200	7042181	—	18-7200
17059293	18-7095	18-7201	7023084	18-7078	—	7042183	18-7070	18-7200
17059294	18-7095	18-7201	7023085	18-7078	—	7043182	18-7070	18-7200
17059295	18-7095	18-7201	7023088	18-7078	—	7043183	18-7070	18-7200
17059296	18-7095	18-7201	7023089	18-7078	—	7043184	18-7070	18-7200
17059298	18-7095	18-7201	7023181	18-7078	—	7043259	—	18-7201
17065977	18-7072	18-7201	7023183	18-7078	—	7043282	—	18-7201
17080050	18-7086	18-7200	7023186	—	18-7200	7044182	18-7070	18-7200
17080350	—	18-7202	7023188	—	18-7200	7044185	18-7075	18-7202
17080560	18-7095	18-7201	7024083	18-7071	—	7044186	—	18-7200
17080561	18-7095	18-7201	7024084	18-7078	—	7044187	18-7075	18-7202
17080562	18-7095	18-7201	7024086	18-7078	—	7044283	18-7072	18-7201
17080563	18-7095	18-7201	7024087	18-7071	—	7044284	18-7072	18-7201
17080564	18-7095	18-7201	7024089	18-7071	—	7044286	18-7072	18-7201
17080565	18-7095	18-7201	7024180	18-7071	—	7044287	18-7072	18-7201
17081060	18-7070	18-7200	7024181	18-7071	—	7044288	18-7072	18-7201
17081299	18-7077	18-7201	7024182	18-7078	—	7044289	18-7072	18-7201
17082403	18-7095	18-7201	7024188	—	18-7200	7044290	18-7072	18-7201

CARBURETOR TO CARBURETOR KIT INTERCHANGE (Cont.)

Carburetor #	Carb. Kit #	Float #	Carburetor #	Carb. Kit #	Needle & Seat #	Carburetor #	Carb. Kit #	Needle & Seat #
ROCHESTER (CONT.)			TILLOTSON (CONT.)			TILLOTSON (CONT.)		
7044291	18-7072	18-7201	AJ-56A	18-7013	18-7057	KA-24A	18-7013	18-7057
7045197	18-7076	18-7202	AJ-56AB	18-7013	18-7057	KA-24AT	18-7013	18-7057
7045282	—	18-7201	AJ-57A	18-7013	18-7057	KA-25A	18-7013	18-7057
7045283	18-7072	18-7201	CO-10A	18-7037	18-7057	KA-26A	18-7013	18-7057
SOLEX			CO-10B	18-7037	18-7057	KA-26B	18-7013	18-7057
44PA1	18-7000	—	CO-11A	18-7037	18-7057	KA-27A	18-7013	18-7057
44PHN-3	18-7001	—	CO-1A	18-7037	18-7057	KA-2A	18-7013	18-7057
VOLVO-PENTA			CO-2A	18-7037	18-7057	KA-2AT	18-7013	18-7057
826359-2	18-7095	18-7201	CO-3A	18-7037	18-7057	KA-5A	18-7013	18-7057
826414-5	18-7086	18-7202	CO-4A	18-7037	18-7057	KA-5A	18-7013	18-7057
826415-2	18-7095	18-7201	CO-4B	18-7037	18-7057	KA-7A	18-7013	18-7057
826442-6	18-7095	18-7201	CO-4C	18-7037	18-7057	KA-7B	18-7013	18-7057
835556-2	18-7095	18-7201	CO-4D	18-7037	18-7057	KA-8A	18-7013	18-7057
841667-9	18-7086	18-7202	CO-5A	18-7037	18-7057	KA-8AT	18-7013	18-7057
856138-3	18-7072	18-7201	CO-6A	18-7037	18-7057	KA-9A	18-7013	18-7057
856236-5	18-7040	—	CO-6B	18-7037	18-7057	KA-9AT	18-7013	18-7057
841047-4	18-7095	18-7201	CO-6C	18-7037	18-7057	KB-10A	18-7013	18-7057
841048-2	18-7086	18-7202	CO-7A	18-7037	18-7057	KB-11A	18-7013	18-7057
841313-0	18-7095	18-7202	CO-7B	18-7037	18-7057	KB-12A	18-7013	18-7057
M875398-0	18-7085	—	CO-7C	18-7037	18-7057	KB-14A	18-7013	18-7057
ZENITH			CO-8A	18-7037	18-7057	KB-3A	18-7013	18-7057
34VN	18-7008	—	CO-9A	18-7037	18-7057	KB-3AT	18-7013	18-7057
8963, A-J	18-7732	—	KA-10A	18-7013	18-7057	KB-4A	18-7013	18-7057
8983, A-H	18-7732	—	KA-10AT	18-7013	18-7057	KB-5A	18-7013	18-7057
12091, A	18-7732	—	KA-11A	18-7013	18-7057	KB-6A	18-7013	18-7057
12206	18-7732	—	KA-11AT	18-7013	18-7057	KB-6B	18-7013	18-7057
ZENITH-STROMBERG			KA-12A	18-7013	18-7057	KB-7A	18-7013	18-7057
C1865F	18-7085	—	KA-12AT	18-7013	18-7057	KB-7B	18-7013	18-7057
C1865R	18-7085	—	KA-13A	18-7013	18-7057	KB-8A	18-7013	18-7057
C3040F	18-7085	—	KA-13AT	18-7013	18-7057	KB-9A	18-7013	18-7057
C3040R	18-7085	—	KA-14A	18-7013	18-7057	KC-10A	18-7013	18-7057
C3098F	18-7085	—	KA-14AT	18-7013	18-7057	KC-10AT	18-7013	18-7057
C3098R	18-7085	—	KA-15A	18-7013	18-7057	KC-11A	18-7013	18-7057
C3200F	18-7085	—	KA-16A	18-7013	18-7057	KC-11AT	18-7013	18-7057
C3200R	18-7085	—	KA-16AT	18-7013	18-7057	KC-13A	18-7013	18-7057
C3201F	18-7085	—	KA-17A	18-7013	18-7057	KC-14A	18-7013	18-7057
C3201M	18-7085	—	KA-17AT	18-7013	18-7057	KC-14AT	18-7013	18-7057
C3201R	18-7085	—	KA-18A	18-7013	18-7057	KC-15A	18-7013	18-7057
C3231F	18-7085	—	KA-18AT	18-7013	18-7057	KC-15AT	18-7013	18-7057
C3231R	18-7085	—	KA-19A	18-7013	18-7057	KC-1A	18-7013	18-7057
C3232F	18-7085	—	KA-19AT	18-7013	18-7057	KC-1AT	18-7013	18-7057
C3232M	18-7085	—	KA-20A	18-7013	18-7057	KC-2A	18-7013	18-7057
C3232R	18-7085	—	KA-21A	18-7013	18-7057	KC-2AT	18-7013	18-7057
OUTBOARD TILLOTSON			KA-21AT	18-7013	18-7057	KC-3A	18-7013	18-7057
Carb #	Carb Kit #	Needle & Seat #	KA-21B	18-7013	18-7057	KC-3AT	18-7013	18-7057
AJ-50A	18-7013	18-7057	KA-21C	18-7013	18-7057	KC-4A	18-7013	18-7057
AJ-52A	18-7013	18-7057	KA-21CT	18-7013	18-7057	KC-5A	18-7013	18-7057
AJ-53A	18-7013	18-7057	KA-21D	18-7013	18-7057	KC-5B	18-7013	18-7057
AJ-53AT	18-7013	18-7057	KA-21DT	18-7013	18-7057	KC-5BT	18-7013	18-7057
AJ-54A	18-7013	18-7057	KA-22A	18-7013	18-7057	KC-5BTA	18-7013	18-7057
AJ-54AT	18-7013	18-7057	KA-22B	18-7013	18-7057	KC-5C	18-7013	18-7057
AJ-55AO	18-7013	18-7057	KA-22C	18-7013	18-7057	KC-5CT	18-7013	18-7057
AJ-55AT	18-7013	18-7057	KA-23A	18-7013	18-7057	KC-5CTA	18-7013	18-7057

CARBURETOR TO CARBURETOR KIT INTERCHANGE (Cont.)

Carburetor #	Carb. Kit #	Needle & Seat #	Carburetor #	Carb. Kit #	Needle & Seat #	Carburetor #	Carb. Kit #	Needle & Seat #
TILLOTSON (CONT.)			TILLOTSON (CONT.)			WALBRO (CONT.)		
KC-6A	18-7013	18-7057	WB-19D	18-7037	18-7057	WMK-9	18-7021	18-7061
KC-6AT	18-7013	18-7057	WB-1A	18-7037	18-7057	WMK-10	18-7021	18-7061
KC-7A	18-7013	18-7057	WB-1B	18-7037	18-7057	WMK-11	18-7021	18-7061
KC-7AT	18-7013	18-7057	WB-1C	18-7037	18-7057	WMK-12	18-7021	18-7061
KC-7B	18-7013	18-7057	WB-20A	18-7037	18-7057	WMK-13	18-7021	18-7061
KC-7BT	18-7013	18-7057	WB-20B	18-7037	18-7057	WMK-14	18-7021	18-7061
KC-8A	18-7013	18-7057	WB-21A	18-7037	18-7057	WMK-15	18-7021	18-7061
KC-9A	18-7013	18-7057	WB-21B	18-7037	18-7057	WMK-18	18-7021	18-7061
KC-9B	18-7013	18-7057	WB-21C	18-7037	18-7057	WMK-19	18-7021	18-7061
KC-9C	18-7013	18-7057	WB-22A	18-7037	18-7057	WMK-20	18-7021	18-7061
KD-1A	18-7013	18-7057	WB-23A	18-7037	18-7057	WMK-21	18-7021	18-7061
KD-1B	18-7013	18-7057	WB-24A	18-7037	18-7057	WMK-22	18-7021	18-7061
KD-1BR	18-7013	18-7057	WB-25A	18-7037	18-7057	WMK-24	18-7021	18-7061
KD-2A	18-7013	18-7057	WB-26A	18-7037	18-7057	WMK-25	18-7021	18-7061
KD-4A	18-7013	18-7057	WB-26B	18-7037	18-7057	WMK-26	18-7021	18-7061
KD-5A	18-7013	18-7057	WB-27A	18-7037	18-7057	WMK-27	18-7021	18-7061
KD-6A	18-7013	18-7057	WB-27B	18-7037	18-7057	WMK-28	18-7021	18-7061
KD-6AT	18-7013	18-7057	WB-28A	18-7037	18-7057	WMK-29	18-7021	18-7061
KD-6B	18-7013	18-7057	WB-2A	18-7037	18-7057	WMK-30	18-7021	18-7061
KD-6BT	18-7013	18-7057	WB-2B	18-7037	18-7057	WMK-31	18-7021	18-7061
KD-7A	18-7013	18-7057	WB-2C	18-7037	18-7057	WMK-32	18-7021	18-7061
KD-7B	18-7013	18-7057	WB-30A	18-7037	18-7057	WMK-35	18-7021	18-7061
RD-10A	18-7037	18-7057	WB-31A	18-7037	18-7057	WMK-36	18-7021	18-7061
TC-1A	18-7037	18-7057	WB-3A	18-7037	18-7057	WMK-38	18-7021	18-7061
TC-1B	18-7037	18-7057	WB-3B	18-7037	18-7057	WMK-39	18-7021	18-7061
WB-10A	18-7037	18-7057	WB-3C	18-7037	18-7057	WMK-40	18-7021	18-7061
WB-10B	18-7037	18-7057	WB-4A	18-7037	18-7057	WMK-41	18-7021	18-7061
WB-10C	18-7037	18-7057	WB-4B	18-7037	18-7057	WMK-41-1A	18-7021	18-7061
WB-10D	18-7037	18-7057	WB-4C	18-7037	18-7057	WMK-41-1B	18-7021	18-7061
WB-10E	18-7037	18-7057	WB-5A	18-7037	18-7057	WMK-41-3A	18-7021	18-7061
WB-11A	18-7037	18-7057	WB-5B	18-7037	18-7057	WMK-41-3B	18-7021	18-7061
WB-11B	18-7037	18-7057	WB-6A	18-7037	18-7057	WO-8A-1	—	18-7061
WB-12A	18-7037	18-7057	WB-7A	18-7037	18-7057	WO-8A-2	—	18-7061
WB-12B	18-7037	18-7057	WB-7B	18-7037	18-7057	WO-8A-3	—	18-7061
WB-13A	18-7037	18-7057	WB-8A	18-7037	18-7057	WO-8A-4	—	18-7061
WB-13B	18-7037	18-7057	WB-8B	18-7037	18-7057	WO-8A-5	—	18-7061
WB-13C	18-7037	18-7057	WB-8C	18-7037	18-7057	WO-8A-6	—	18-7061
WB-13D	18-7037	18-7057	WB-8D	18-7037	18-7057	WO-9-1	—	18-7061
WB-14A	18-7037	18-7057	WB-9A	18-7037	18-7057	WO-9-2	—	18-7061
WB-14B	18-7037	18-7057	WB-9B	18-7037	18-7057	WO-9-3	—	18-7061
WB-15A	18-7037	18-7057	WB-9C	18-7037	18-7057	WO-9-4	—	18-7061
WB-15B	18-7037	18-7057	WB-9D	18-7037	18-7057	WO-9-5	—	18-7061
WB-15C	18-7037	18-7057	WM-16	18-7021	18-7061	WO-9-6	—	18-7061
WB-15D	18-7037	18-7057	WM-17	18-7021	18-7061	WO-9A-1	—	18-7061
WB-16A	18-7037	18-7057	WALBRO			WO-9A-2	—	18-7061
WB-16B	18-7037	18-7057	WM-23	18-7021	18-7061	WO-9A-3	—	18-7061
WB-16C	18-7037	18-7057	WMD-1	18-7021	18-7061	WO-9A-4	—	18-7061
WB-16D	18-7037	18-7057	WMK-1	18-7021	18-7061	WO-9A-5	—	18-7061
WB-17A	18-7037	18-7057	WMK-2	18-7021	18-7061	WO-9A-6	—	18-7061
WB-17B	18-7037	18-7057	WMK-3	18-7021	18-7061			
WB-17C	18-7037	18-7057	WMK-4	18-7021	18-7061			
WB-19A	18-7037	18-7057	WMK-5	18-7021	18-7061			
WB-19B	18-7037	18-7057	WMK-7	18-7021	18-7061			
WB-19C	18-7037	18-7057	WMK-8	18-7021	18-7061			



FLAMETHROWER ELECTRONIC DISTRIBUTORS

Magnetic triggered billet distributors designed to meet or exceed SAE J1171 Standards.

Performance Features:

- Cobalt magnets and Hall Effect trigger for stable timing and precise spark distribution.
- Compensates for inherent electronic delay
- Synchronized peak current and spark timing reduces heat build-up
- Compatible with most capacitive discharge ignition boxes
- Integrated patented Ignitor II technology with adaptive dwell control
- Non-vented distributor cap equipped with stainless steel fasteners
- Triple screen spark arrester for added protection



Part No.	Description
18-5481	Ford 351W (Conventional Rotation)
18-5482	Ford 351C, 351M, 400, 429, 460 (Conventional Rotation)
18-5483	Small and BB Chevrolet (Standard Deck height) (Conventional Rotation)
18-5477	Ford 302 (Conventional Rotation)
18-5478	Chrysler LA series (Conventional Rotation)
18-5479	Small and BB Chevrolet (Standard Deck height) Reverse Rotation

THUNDERBOLT HEI DISTRIBUTORS



Designed as a direct replacement for Mercury Thunderbolt IV Ignition Distributors. Meets or Exceeds SAE J1171 Standards.

Performance Features:

- Battery Powered (HEI) High Energy Ignition.
- Uses a Hall-Effect type sensor to trigger ignition accurately even at extremely low RPM.

Part No.	Description
18-5470	GM V8
18-5471	GM V6



DELCO HVS DISTRIBUTORS

Aluminum housing construction replaces weaker Factory plastic housing. Designed as a direct replacement for late model GM HVS Distributor. Meets or Exceeds SAE J1171 Standards.

Performance Features:

- Includes steel gear, which is compatible with flat tappet or hydraulic roller cams.
- Reliable high signal strength trigger system.
- Ball bearing and bushing combination provide maximum timing stability and long life.

Part No.	Description
18-5350	GM Vortec V6
18-5351	GM Vortec V8



DELCO EST DISTRIBUTORS



Aluminum housing construction. Designed as a direct replacement for late model GM EST Distributor. Meets or Exceeds SAE J1171 Standards.

Performance Features:

- Includes steel gear, which is compatible with flat tappet or hydraulic roller cams.
- Reliable high signal strength trigger system.
- Ball bearing and bushing combination provide maximum timing stability and long life.

Part No.	Description
18-5475	GM 4 Cyl
18-5476	GM V6
18-5484-1	GM V8



CONVERSION KITS FOR DELCO EST DISTRIBUTORS



18-5512
I/V 4 DELCO EST CONVERSION KIT
 Description: Converts 4 Cylinder GM Engines to Electronic
 Includes: Distributor, Coil, Ignition Wires, and Harnesses



18-5513
V-6 DELCO EST CONVERSION KIT
 Description: Converts 6 Cylinder GM Engines to Electronic
 Includes: Distributor, Coil, Ignition Wires, and Harnesses



18-5514
V-8 DELCO EST CONVERSION KIT
 Description: Converts 8 Cylinder GM Engines to Electronic
 Includes: Distributor, Coil, Ignition Wires, and Harnesses

YLM STYLE MAGNETIC BREAKERLESS ELECTRONIC DISTRIBUTOR

Designed for 12 Volt Negative ground systems, the Sierra YLM Series Marine distributors replace original equipment marine distributors with modern, high performance technology. This complete, self-contained ignition system combines the triggering device and amplifier into a single unit that sits inside the distributor housing. A self-contained module/pickup assembly has no moving parts to wear out. Sierra's time tested reliability you need in extreme marine conditions. A simple wiring hook up allows this system to fit a wide variety of marine applications. This ignition system drives both original equipment and high performance coils.

Performance Features:

- Improved performance and combustion efficiency.
- Improved spark plug life.
- Accurate spark timing.
- Reduced maintenance.
- Easy installation.

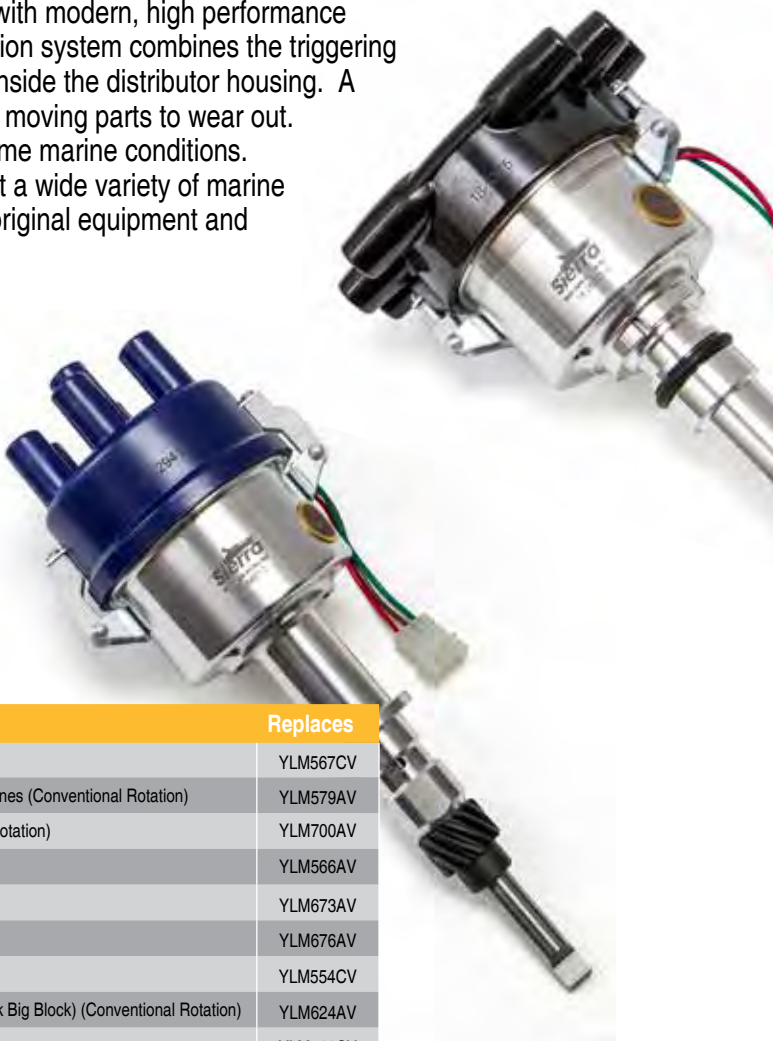

Part No.	Description	Replaces
18-5496-2	Ford 351C, 460 CID (Conventional Rotation)	YLM567CV
18-5497-2	Chrysler V8 273, 318 (67 & UP) 340, 360 CID "LA" Engines (Conventional Rotation)	YLM579AV
18-26310-2	GM 4.3L/262 CID Engines (EVEN Fire) (Conventional Rotation)	YLM700AV
18-26311-2	GM 327Q, 350Q Engines (Conventional Rotation)	YLM566AV
18-5486-2	GM L4, 153 & 181 CID (Conventional Rotation)	YLM673AV
18-5487-2	GM L6, 194, 230, 250, 292 CID (Conventional Rotation)	YLM676AV
18-5489-2	Ford 351W (Conventional Rotation)	YLM554CV
18-5494-2	GM V8 482, 502, 540 CID (Except 348, 409, & Tall Deck Big Block) (Conventional Rotation)	YLM624AV
18-5495-2	Ford 302 (Conventional Rotation)	YLM512CV
18-5498-2	GM V8, 482, 502, 540 CID (Except 348, 409 & Tall Deck Big Block) (Reverse Rotation)	YLM624BV

CONVERSION KITS FOR DELCO EST DISTRIBUTORS



18-5518 I/L 4 SIERRA ELECTRONIC DISTRIBUTOR CONVERSION KIT

Description: Converts 4 Cylinder GM Engines to Electronic
Includes: Distributor, Coil, Ignition Wires, and Harnesses



18-5519 I/L 6 SIERRA ELECTRONIC DISTRIBUTOR CONVERSION KIT

Description: Converts 6 Cylinder GM Engines to Electronic
Includes: Distributor, Coil, Ignition Wires, and Harnesses



18-5520 V-8 SIERRA ELECTRONIC DISTRIBUTOR CONVERSION KIT

Description: Converts 8 Cylinder GM Engines to Electronic
Includes: Distributor, Coil, Ignition Wires, and Harnesses

YL STYLE POINT-TYPE DISTRIBUTORS

Using new materials and technology, the Sierra YL Series Distributor delivers more performance and reliability for today's marine performance engines. This proven ignition system drives both original equipment and high performance coils.

Performance Features:

- Stabilized points eliminate point float and bounce.
- High dielectric condenser with brass case eliminates corrosion.
- Mylar insulation provides greater protection against current leaks and shorting.
- Super Duty cap and rotor.
- Self-Lubricating bushings.



Part No.	Description	Replaces
18-5309-1	Ford 302 (Conventional Rotation)	YL512CV
18-5312-1	Ford 351 (Conventional Rotation)	YL554CV
18-5313-1	Most GM V8 (Conventional Rotation)	YL624AV
18-5315-1	Most GM 4 Cylinder Engines (120 & 140HP) (Conventional Rotation)	YL673AV
18-5316-1	Most GM V8 (Reverse Rotation)	YL624BV
18-5339-1	GM V8 327	YL566AV
18-26104-1	Ford V8 351C (Conventional Rotation)	YL567EV
18-26107-1	4.3L/262 CID Engines (EVEN Fire) (Conventional Rotation)	YL700AV
18-26110-1	Chrysler V8, 273, 318 (1967 & Up), 340 and 360 "LA" Engines	YL579AV
18-26111-1	3.7L Mercruiser (Conventional Rotation)	YL648AV
18-26112-1	GM L6, 194, 230, 250, 292 CID (Conventional Rotation)	YLM676AV

DISTRIBUTOR PARTS



18-5515
DELCO EST DISTRIBUTOR COIL TO MODULE HARNESS
 Fits: Engines equipped with a Delco EST Distributor



18-5516
DELCO EST DISTRIBUTOR TIMING TOOL
 For: Engines equipped with Delco EST and cannot be placed in base timing mode with a diagnostic tool.



18-5517
DELCO EST SHIFT INTERRUPT HARNESS
 For: Engines equipped with a Delco EST Distributor and requires a shift interrupt lead.



18-26800
MARINE CAP CLIP KIT
 Replaces: Mallory 670
 Fits: Mallory Tall Cap



18-26810
PIGTAIL, GM HEI 4 TERMINAL
 Fits: Delco EST Distributors



18-26811
PIGTAIL, GM HEI 2 TERMINAL
 Fits: Delco EST Distributors



18-26812
CONNECTOR, HEI COIL GRAY
 Fits: Delco EST Ignition Coil



18-26813
CONNECTOR, HEI COIL BLACK
 Fits: Delco EST Ignition Coil



18-26815
DISTRIBUTOR HARNESS
 Replaces: Mallory 29349
 Fits: YLM & YLU Distributors

DISTRIBUTOR PARTS (cont.)



18-61051
SCREW KIT (4 PER PKG)

Fits: Mercruiser V6 & V8 Thunderbolt Distributor Caps



18-26820
DISTRIBUTOR GEAR

Fits: Standard rotation GM SB & BB engines



18-26821
DISTRIBUTOR CHEV REV GEAR

Fits: Mallory Distributors in Chevrolet BB & SB reverse rotation engines



18-28150
WIRE SEPARATOR / BLUE



18-28151
WIRE SEPARATOR / BLACK



18-28175
WIRE MARKERS

ELECTRONIC CONVERSION KIT APPLICATION

CHEVROLET MARINE

Model	Cylinders	Years	Footnotes	Distributor Make	Distributor #	Ignitor Kit	Ignitor II Kit
All Models	V6	1980-1988	⑥	Prestolite	IBM-7021	18-5293-1	18-5287-1
All Models	V8	1976-1988	⑥, ⑦	Prestolite	IBM-7011	18-5298	18-5288
All Models	V8	1976-1988	④, ⑥	Prestolite	IBM-7013	18-5299	18-5289

CHRIS-CRAFT

Model	Cylinders	Years	Footnotes	Distributor Make	Distributor #	Ignitor Kit	Ignitor II Kit
All Models	V8	1963-1971	⑥, ⑦	Prestolite	IBM-4115	18-5298	18-5288
All Models	V8	1963-1971	⑥, ⑦	Prestolite	IBM-4116	18-5298	18-5288
All Models	V8	1981-1985	④, ⑥	Prestolite	-	18-5299	18-5289
FL153	I4	1975-1980	①, ⑥	Delco	-	18-5297	18-5285
FL181	I4	1975-1980	①, ⑥	Delco	-	18-5297	18-5285

CHRYSLER INBOARD

Model	Cylinders	Years	Footnotes	Distributor Make	Distributor #	Ignitor Kit	Ignitor II Kit
273	V8	1983-1988	④, ⑥	Prestolite	IBM-7016	18-5299	18-5289
273	V8	1983-1988	④, ⑥	Prestolite	IBM-7017	18-5299	18-5289
318	V8	1983-1988	④, ⑥	Prestolite	IBM-7016	18-5299	18-5289
318	V8	1983-1988	④, ⑥	Prestolite	IBM-7017	18-5299	18-5289
340	V8	1983-1988	④, ⑥	Prestolite	IBM-7016	18-5299	18-5289
340	V8	1983-1988	④, ⑥	Prestolite	IBM-7017	18-5299	18-5289
440	V8	1983-1988	④, ⑥	Prestolite	IBM-7016	18-5299	18-5289
440	V8	1983-1988	④, ⑥	Prestolite	IBM-7017	18-5299	18-5289
M318A	V8	1959-1972	⑥, ⑦	Prestolite	IBM-4106	18-5298	18-5288
M318B	V8	1959-1972	⑥, ⑦	Prestolite	IBM-4106	18-5298	18-5288
M318C	V8	1959-1972	⑥, ⑦	Prestolite	IBM-4106	18-5298	18-5288
M318X	V8	1965-1966	⑥, ⑦	Prestolite	IBM-4120	18-5298	18-5288
M413	V8	1959-1972	⑥, ⑦	Prestolite	IBM-4106	18-5298	18-5288
M413D	V8	1959-1972	⑥, ⑦	Prestolite	IBM-4106	18-5298	18-5288
M426X	V8	1959-1972	⑥, ⑦	Prestolite	IBM-4106	18-5298	18-5288
M80	V8	1959-1972	⑥, ⑦	Prestolite	IBM-4106	18-5298	18-5288
M81	V8	1959-1972	⑥, ⑦	Prestolite	IBM-4106	18-5298	18-5288

① Clockwise Rotation
② Factory Electronic Ignition
③ Excluding distributor number YL670AV

④ Use with Screw Down Distributor Cap
⑤ Use with Clip Down Distributor Cap
⑥ Ignitor II cannot be used with solid core Ignition Wires

CRUSADER							
Model	Cylinders	Years	Footnotes	Distributor Make	Distributor #	Ignitor Kit	Ignitor II Kit
185	V8	1961-1969	ⓐ, ⓑ	Mallory	YL431A	18-5296-2	18-5290
185	V8	1961-1969	ⓐ, ⓑ	Mallory	YD431A	18-5296-2	18-5290
220	V8	1961-1969	ⓐ, ⓑ	Mallory	YL431A	18-5296-2	18-5290
220	V8	1961-1969	ⓐ, ⓑ	Mallory	YD431A	18-5296-2	18-5290
230	V8	1961-1969	ⓐ, ⓑ	Mallory	YL431A	18-5296-2	18-5290
230	V8	1961-1969	ⓐ, ⓑ	Mallory	YD431A	18-5296-2	18-5290
283	V8	1961-1969	ⓐ, ⓑ	Prestolite	IBM-4110	18-5298	18-5288
302	V8	1975-1978	ⓐ, ⓑ	Prestolite	IBM-7007	18-5298	18-5288
302	V8	1975-1978	ⓐ, ⓑ	Prestolite	IBM-7007A	18-5298	18-5288
305	V8	1977-1982	ⓐ, ⓑ	Prestolite	IBM-7011	18-5298	18-5288
305	V8	1977-1982	ⓐ, ⓑ	Prestolite	IBM-7011C	18-5298	18-5288
305	V8	1977-1982	ⓐ, ⓑ	Prestolite	IBM-7011D	18-5298	18-5288
305	V8	1983-1987	ⓐ, ⓑ	Mallory	-	18-5296-2	18-5290
305	V8	1987-1988	ⓐ, ⓑ	Prestolite	IDU-7801	18-5239	18-5240
327	V8	1961-1969	ⓐ, ⓑ	Prestolite	IBM-4110	18-5298	18-5288
350	V8	1977-1982	ⓐ, ⓑ	Prestolite	IBM-7011	18-5298	18-5288
350	V8	1977-1982	ⓐ, ⓑ	Prestolite	IBM-7011C	18-5298	18-5288
350	V8	1977-1982	ⓐ, ⓑ	Prestolite	IBM-7011D	18-5298	18-5288
350	V8	1983-1987	ⓐ, ⓑ	Mallory	-	18-5296-2	18-5290
350	V8	1987-1988	ⓐ, ⓑ	Prestolite	IDU-7801	18-5239	18-5240
409	V8	1961-1969	ⓐ, ⓑ	Prestolite	IBM-4110	18-5298	18-5288
454	V8	1977-1982	ⓐ, ⓑ	Prestolite	IBM-7011	18-5298	18-5288
454	V8	1977-1982	ⓐ, ⓑ	Prestolite	IBM-7011C	18-5298	18-5288
454	V8	1977-1982	ⓐ, ⓑ	Prestolite	IBM-7011D	18-5298	18-5288
454	V8	1983-1987	ⓐ, ⓑ	Mallory	-	18-5296-2	18-5290
454	V8	1987-1988	ⓐ, ⓑ	Prestolite	IDU-7801	18-5239	18-5240

DEARBORN MARINE							
Model	Cylinders	Years	Footnotes	Distributor Make	Distributor #	Ignitor Kit	Ignitor II Kit
221 CID	V8	1961-1969	3, 6	Mallory	YL362	18-5296-2	18-5290
221 CID	V8	1961-1969	3, 6	Mallory	YL455	18-5296-2	18-5290
221 CID	V8	1961-1969	3, 6	Mallory	YL519	18-5296-2	18-5290
260 CID	V8	1961-1969	3, 6	Mallory	YL362	18-5296-2	18-5290
260 CID	V8	1961-1969	3, 6	Mallory	YL455	18-5296-2	18-5290
260 CID	V8	1961-1969	3, 6	Mallory	YL519	18-5296-2	18-5290
262 CID	V8	1960-1969	3, 6	Mallory	YL350A	18-5296-2	18-5290
262 CID	V8	1960-1969	3, 6	Mallory	YL387A	18-5296-2	18-5290
272 CID	V8	1960-1969	3, 6	Mallory	YL350A	18-5296-2	18-5290
272 CID	V8	1960-1969	3, 6	Mallory	YL387A	18-5296-2	18-5290
289 CID	V8	1961-1969	3, 6	Mallory	YL362	18-5296-2	18-5290
289 CID	V8	1961-1969	3, 6	Mallory	YL455	18-5296-2	18-5290
289 CID	V8	1961-1969	3, 6	Mallory	YL519	18-5296-2	18-5290
292 CID	V8	1960-1969	3, 6	Mallory	YL350A	18-5296-2	18-5290
292 CID	V8	1960-1969	3, 6	Mallory	YL387A	18-5296-2	18-5290
312 CID	V8	1960-1969	3, 6	Mallory	YL350A	18-5296-2	18-5290
312 CID	V8	1960-1969	3, 6	Mallory	YL387A	18-5296-2	18-5290
352 CID	V8	1961-1969	3, 6	Mallory	YL362	18-5296-2	18-5290
352 CID	V8	1961-1969	3, 6	Mallory	YL455	18-5296-2	18-5290
352 CID	V8	1961-1969	3, 6	Mallory	YL519	18-5296-2	18-5290
390 CID	V8	1961-1969	3, 6	Mallory	YL362	18-5296-2	18-5290
390 CID	V8	1961-1969	3, 6	Mallory	YL455	18-5296-2	18-5290
390 CID	V8	1961-1969	3, 6	Mallory	YL519	18-5296-2	18-5290

APPLICATION CONTINUED ON NEXT PAGE

- ⓐ Clockwise Rotation
- ⓑ Factory Electronic Ignition
- ⓒ Excluding distributor number YL670AV
- ⓓ Use with Screw Down Distributor Cap
- ⓔ Use with Clip Down Distributor Cap
- ⓕ Ignitor II cannot be used with solid core Ignition Wires

DEARBORN MARINE

Model	Cylinders	Years	Footnotes	Distributor Make	Distributor #	Ignitor Kit	Ignitor II Kit
427 CID	V8	1965-1969	②, ③	Mallory	YL494A-2	18-5296-2	18-5290
427 CID	V8	1965-1969	②, ③	Mallory	YL494B-2	18-5296-2	18-5290

FORD MARINE

Model	Cylinders	Years	Footnotes	Distributor Make	Distributor #	Ignitor Kit	Ignitor II Kit
302 CID	V8	1973-1988	②, ③	Prestolite	IBM-7007	18-5298	18-5288
302 CID	V8	1973-1988	②, ③	Prestolite	IBM-7008	18-5298	18-5288
302 CID	V8	1973-1988	②, ③	Prestolite	IBM-7019	18-5299	18-5289
302 CID	V8	1973-1988	②, ③	Prestolite	IBM-7020	18-5299	18-5289
351 CID	V8	1973-1988	②, ③	Prestolite	IBM-7007	18-5298	18-5288
351 CID	V8	1973-1988	②, ③	Prestolite	IBM-7008	18-5298	18-5288
351 CID	V8	1973-1988	②, ③	Prestolite	IBM-7019	18-5299	18-5289
351 CID	V8	1973-1988	②, ③	Prestolite	IBM-7020	18-5299	18-5289
460 CID	V8	1973-1988	②, ③	Prestolite	IBM-7007	18-5298	18-5288
460 CID	V8	1973-1988	②, ③	Prestolite	IBM-7008	18-5298	18-5288
460 CID	V8	1973-1988	②, ③	Prestolite	IBM-7019	18-5299	18-5289
460 CID	V8	1973-1988	②, ③	Prestolite	IBM-7020	18-5299	18-5289

GRAY MARINE

Model	Cylinders	Years	Footnotes	Distributor Make	Distributor #	Ignitor Kit	Ignitor II Kit
138	V8	1950-1969	②, ③	Mallory	YL429	18-5296-2	18-5290
138	V8	1950-1969	②, ③	Mallory	YL429C	18-5296-2	18-5290
138	V8	1950-1969	②, ③	Mallory	YL429D	18-5296-2	18-5290
178	V8	1950-1969	②, ③	Mallory	YL429	18-5296-2	18-5290
178	V8	1950-1969	②, ③	Mallory	YL429C	18-5296-2	18-5290
178	V8	1950-1969	②, ③	Mallory	YL429D	18-5296-2	18-5290
401 CID	V8	ALL	②, ③	Mallory	YL455A	18-5296-2	18-5290
401 CID	V8	ALL	②, ③	Mallory	YL455A	18-5296-2	18-5290
CF175	V8	1965-1968	②, ③	Prestolite	IBM-4119	18-5298	18-5288
CF175	V8	1965-1968	②, ③	Prestolite	IBM-4119A	18-5298	18-5288
CF195	V8	1965-1968	②, ③	Prestolite	IBM-4119	18-5298	18-5288
CF195	V8	1965-1968	②, ③	Prestolite	IBM-4119A	18-5298	18-5288
CH175	V8	1965-1968	②, ③	Prestolite	IBM-4119	18-5298	18-5288
CH175	V8	1965-1968	②, ③	Prestolite	IBM-4119A	18-5298	18-5288
CH195	V8	1965-1968	②, ③	Prestolite	IBM-4119	18-5298	18-5288
CH195	V8	1965-1968	②, ③	Prestolite	IBM-4119A	18-5298	18-5288

INDMAR

Model	Cylinders	Years	Footnotes	Distributor Make	Distributor #	Ignitor Kit	Ignitor II Kit
All Models	V8	1979-1979	②, ③	Prestolite	IBM-7011	18-5298	18-5288

MARINE POWER

Model	Cylinders	Years	Footnotes	Distributor Make	Distributor #	Ignitor Kit	Ignitor II Kit
305 CID	V8	1978-1983	②, ③	Prestolite	IBM-7011	18-5298	18-5288
305 CID	V8	1978-1983	②, ③	Prestolite	IBM-7013	18-5299	18-5289
350 CID	V8	1978-1983	②, ③	Prestolite	IBM-7011	18-5298	18-5288
350 CID	V8	1978-1983	②, ③	Prestolite	IBM-7013	18-5299	18-5289
454 CID	V8	1978-1983	②, ③	Prestolite	IBM-7011	18-5298	18-5288
454 CID	V8	1978-1983	②, ③	Prestolite	IBM-7013	18-5299	18-5289

MERCURISER

Model	Cylinders	Years	Footnotes	Distributor Make	Distributor #	Ignitor Kit	Ignitor II Kit
110	I4	ALL	①, ③	Delco	-	18-5297	18-5285
120	I4	ALL	①, ③	Delco	-	18-5297	18-5285
140	I4	ALL	①, ③	Delco	-	18-5297	18-5285

APPLICATION CONTINUED ON NEXT PAGE

- ① Clockwise Rotation
- ② Factory Electronic Ignition
- ③ Excluding distributor number YL670AV
- ④ Use with Screw Down Distributor Cap
- ⑤ Use with Clip Down Distributor Cap
- ⑥ Ignitor II cannot be used with solid core Ignition Wires

MERCUISER							
Model	Cylinders	Years	Footnotes	Distributor Make	Distributor #	Ignitor Kit	Ignitor II Kit
140	V6	ALL	ⓐ	Delco	-	18-5294	18-5286
150	V6	ALL	ⓐ	Delco	-	18-5294	18-5286
160	V6	ALL	ⓐ	Delco	-	18-5294	18-5286
165	I4	ALL	ⓐ, ⓑ	Delco	-	18-5297	18-5285
165	V6	ALL	ⓐ	Delco	-	18-5294	18-5286
170	I4	ALL	ⓐ, ⓑ	Delco	-	18-5297	18-5285
180	I4	ALL	ⓐ, ⓑ	Delco	-	18-5297	18-5285
190	I4	ALL	ⓐ, ⓑ	Delco	-	18-5297	18-5285
198	V8	ALL	ⓐ, ⓑ	Mallory	-	18-5296-2	18-5290
200	V6	ALL	ⓐ	Delco	-	18-5294	18-5286
215	V8	ALL	ⓐ, ⓑ	Mallory	-	18-5296-2	18-5290
225	V8	ALL	ⓐ, ⓑ	Mallory	-	18-5296-2	18-5290
228	V8	ALL	ⓐ, ⓑ	Mallory	-	18-5296-2	18-5290
233	V8	ALL	ⓐ, ⓑ	Prestolite	-	18-5298	18-5288
233	V8	ALL	ⓐ, ⓑ	Prestolite	-	18-5299	18-5289
250	V8	ALL	ⓐ, ⓑ	Mallory	-	18-5296-2	18-5290
255	V8	ALL	ⓐ, ⓑ	Mallory	-	18-5296-2	18-5290
260	V8	ALL	ⓐ, ⓑ	Mallory	-	18-5296-2	18-5290
280	V8	ALL	ⓐ, ⓑ	Mallory	-	18-5296-2	18-5290
330	V8	ALL	ⓐ, ⓑ	Mallory	-	18-5296-2	18-5290
370	V8	ALL	ⓐ, ⓑ	Mallory	-	18-5296-2	18-5290
400	V8	ALL	ⓐ, ⓑ	Mallory	-	18-5296-2	18-5290
440	V8	ALL	ⓐ, ⓑ	Mallory	-	18-5296-2	18-5290
470	I4	ALL	ⓐ, ⓑ	Delco	-	18-5297	18-5285
485	I4	ALL	ⓐ, ⓑ	Delco	-	18-5297	18-5285
888	V8	ALL	ⓐ, ⓑ	Prestolite	-	18-5298	18-5288
888	V8	ALL	ⓐ, ⓑ	Mallory	-	18-5296-2	18-5290
898	V8	ALL	ⓐ, ⓑ	Mallory	-	18-5296-2	18-5290
120 Alpha 1	V6	ALL	ⓐ	Delco	-	18-5294	18-5286
140 Alpha 1	V6	ALL	ⓐ	Delco	-	18-5294	18-5286
460 TRS	V8	ALL	ⓐ, ⓑ	Mallory	-	18-5296-2	18-5290
470R	I4	ALL	ⓐ, ⓑ	Delco	-	18-5297	18-5285
488R	I4	ALL	ⓐ, ⓑ	Delco	-	18-5297	18-5285
5.7 Ski	V8	ALL	ⓐ, ⓑ	Mallory	-	18-5296-2	18-5290

OMC

Model	Cylinders	Years	Footnotes	Distributor Make	Distributor #	Ignitor Kit	Ignitor II Kit
100HP	I4	1964-1988	ⓐ, ⓑ	Delco	-	18-5297	18-5285
110HP	I4	1964-1988	ⓐ, ⓑ	Delco	-	18-5297	18-5285
120HP	I4	1964-1988	ⓐ, ⓑ	Delco	-	18-5297	18-5285
140HP	I4	1964-1988	ⓐ, ⓑ	Delco	-	18-5297	18-5285
150HP	V6	1964-1966	ⓐ	Delco	1110309	18-5297	18-5285
150HP	V6	1964-1966	ⓐ	Delco	1110322	18-5297	18-5285
165HP	V6	1972-1976	ⓐ	Delco	980156	18-5297	18-5285
2.5L	I4	1982-1988	ⓐ, ⓑ	Delco	982351	18-5297	18-5285
3.0L	I4	1982-1988	ⓐ, ⓑ	Delco	982351	18-5297	18-5285
ALL	V8	1966-1988	ⓐ, ⓑ	Mallory	-	18-5296-2	18-5290
ALL	V8	1974-1988	ⓐ, ⓑ	Prestolite	980902	18-5298	18-5288
ALL	V8	1974-1988	ⓐ, ⓑ	Prestolite	981080	18-5298	18-5288
ALL	V8	1974-1988	ⓐ, ⓑ	Prestolite	982320	18-5298	18-5288
ALL	V8	1982-1988	ⓐ, ⓑ	Prestolite	IBM-7013C	18-5299	18-5289
ALL	V8	1982-1988	ⓐ, ⓑ	Prestolite	IBM-7013D	18-5299	18-5289

ⓐ Clockwise Rotation
 ⓑ Factory Electronic Ignition
 ⓐ Excluding distributor number YL670AV
 ⓐ Use with Screw Down Distributor Cap
 ⓑ Use with Clip Down Distributor Cap
 ⓐ Ignitor II cannot be used with solid core Ignition Wires

ONAN

Model	Cylinders	Years	Footnotes	Distributor Make	Distributor #	Ignitor Kit	Ignitor II Kit
MDJC	I4	1961-1980	⑥	Autolite	IGW-4409A	18-5295	-

PLEASURECRAFT MARINE

Model	Cylinders	Years	Footnotes	Distributor Make	Distributor #	Ignitor Kit	Ignitor II Kit
302 CID	V8	1975-1978	⑥, ⑥	Prestolite	IBM-7007	18-5298	18-5288
302 CID	V8	1975-1978	⑥, ⑥	Prestolite	IBM-7008	18-5298	18-5288
305 CID	V8	1976-1982	⑥, ⑥	Prestolite	IBM-7011	18-5298	18-5288
305 CID	V8	1983-1988	⑥, ⑥	Prestolite	IBM-7013	18-5299	18-5289
350 CID	V8	1976-1982	⑥, ⑥	Prestolite	IBM-7011	18-5298	18-5288
350 CID	V8	1983-1988	⑥, ⑥	Prestolite	IBM-7013	18-5299	18-5289
351 CID	V8	1975-1978	⑥, ⑥	Prestolite	IBM-7007	18-5298	18-5288
351 CID	V8	1975-1978	⑥, ⑥	Prestolite	IBM-7008	18-5298	18-5288
454 CID	V8	1976-1982	⑥, ⑥	Prestolite	IBM-7011	18-5298	18-5288
454 CID	V8	1983-1988	⑥, ⑥	Prestolite	IBM-7013	18-5299	18-5289
460 CID	V8	1975-1978	⑥, ⑥	Prestolite	IBM-7007	18-5298	18-5288
460 CID	V8	1975-1978	⑥, ⑥	Prestolite	IBM-7008	18-5298	18-5288

THERMO-ELECTRON

Model	Cylinders	Years	Footnotes	Distributor Make	Distributor #	Ignitor Kit	Ignitor II Kit
305 CID	V8	1977-1982	⑥, ⑥	Prestolite	IBM-7011D	18-5298	18-5288
305 CID	V8	1981-1982	⑥, ⑥	Prestolite	IBM-7013	18-5299	18-5289
350 CID	V8	1977-1982	⑥, ⑥	Prestolite	IBM-7011D	18-5298	18-5288
350 CID	V8	1981-1982	⑥, ⑥	Prestolite	IBM-7013	18-5299	18-5289
454 CID	V8	1977-1982	⑥, ⑥	Prestolite	IBM-7011D	18-5298	18-5288
454 CID	V8	1981-1982	⑥, ⑥	Prestolite	IBM-7013	18-5299	18-5289

UNIVERSAL

Model	Cylinders	Years	Footnotes	Distributor Make	Distributor #	Ignitor Kit	Ignitor II Kit
Atomic 4	I4	1968-1970	①, ⑥	Delco	1112446	18-5297	18-5285

VOLVO PENTA

Model	Cylinders	Years	Footnotes	Distributor Make	Distributor #	Ignitor Kit	Ignitor II Kit
All Models	I4	ALL	⑥	Bosch	231178017	18-5292	-
All Models	V8	1977-1982	⑥, ⑥	Prestolite	IBM-7011A	18-5298	18-5288
All Models	V8	1977-1982	④, ⑥	Prestolite	IBM-7013A	18-5299	18-5289
All Models	V8	1986-1988	②, ⑥	Prestolite	IDU-7801	18-5239	18-5240

WAUKESHA

Model	Cylinders	Years	Footnotes	Distributor Make	Distributor #	Ignitor Kit	Ignitor II Kit
FC (12 Volt)	I4	1959-1973	⑥	Autolite	IGW-4301-3	18-5295	-
FCS (12 Volt)	I4	1959-1973	⑥	Autolite	IGW-4301-3	18-5295	-
FS (12 Volt)	I4	1959-1973	⑥	Autolite	IGW-4301-3	18-5295	-
IC (12 Volt)	I4	1959-1973	①, ⑥	Autolite	IGW-4301-3	18-5295	-
VGR-155	I4	1975-1978	①, ⑥	Delco	1112470	18-5297	18-5285

WISCONSIN

Model	Cylinders	Years	Footnotes	Distributor Make	Distributor #	Ignitor Kit	Ignitor II Kit
VE4 (12 Volt)	I4	1948-1957	⑥	Autolite	IGW Series	18-5295	-
VF4 (12 Volt)	I4	1948-1957	⑥	Autolite	IGW Series	18-5295	-
VL4 (12 Volt)	I4	1948-1957	⑥	Autolite	IGW Series	18-5295	-
VP4 (12 Volt)	I4	1948-1957	⑥	Autolite	IGW Series	18-5295	-

- ① Clockwise Rotation
- ② Factory Electronic Ignition
- ③ Excluding distributor number YL670AV
- ④ Use with Screw Down Distributor Cap
- ⑤ Use with Clip Down Distributor Cap
- ⑥ Ignitor II cannot be used with solid core Ignition Wires

IGNITION WIRE IDENTIFICATION CHART



IGNITION WIRE LEAD TYPES

Sierra #	No. of Wires	Coil Wire	Dist. End	Spark Plug End	Coil End	Coil Dist. End
OUTBOARD IGNITION WIRES						
18-28083	1	-	1	1	-	-
18-8815-1	1	-	4	4	-	-
18-8816-1	1	-	4	4	-	-
18-8818-1	1	-	4	4	-	-
18-8819-1	1	-	11	6	-	-
18-5227-1	1	-	11	6	-	-
18-5228-1	1	-	11	6	-	-
18-5231-1	1	-	4	4	-	-
18-5229-9-1	5	-	18	4	-	-
18-5230-9-1	5	-	18	4	-	-

Sierra #	No. of Wires	Coil Wire	Dist. End	Spark Plug End	Coil End	Coil Dist. End
OUTBOARD IGNITION WIRES						
18-28084	3	-	1	1	-	-
18-28082	4	-	9	1	-	-
18-28085	4	-	1	1	-	-
18-8839-1	4	-	4	6	-	-
18-28080	6	-	9	1	-	-
18-28081	6	-	11	1	-	-
18-28086	6	-	1	1	-	-
18-28090	6	-	4	6	-	-
18-8840-1	6	-	4	6	-	-
18-8846-1	4	-	19	20	-	-

IGNITION WIRE LEAD TYPES (Continued)

Sierra #	No. of Cylinders	Coil Wire	Dist. End	Spark Plug End	Coil End	Coil Dist. End
STERNDRIVE/INBOARD IGNITION WIRES						
18-28100*	1	12	-	-	1	5
18-28101*	1	12	-	-	1	4
18-28102*	1	14	-	-	9	5
18-28042	4	12	5	1	5	5
18-28050	4	12	4	2	9	9
18-8800-1	4	13	5	2	9	5
18-8807-1	4	13	5	2	9	5
18-8808-2	4	13	5	3	9	5
18-8811-1	4	12	7	3	7	7
18-8813-1	4	20	9	14	13	13
18-8814-1	4	11/11	2	2	2	4
18-8833-1	4	9	4	1	4	4
18-8841-1	4	11	15	15/16	4	15
18-8801-1	6	13	5	2	9	5
18-8809-1	6	13	5	1	9	5
18-8810-1	6	13	6	1	10	6
18-8829-1	6	21	17	1	8	8
18-8835-1	6	15.5	4	1	4	4
18-28019	8	12/15	4	1	-	-
18-28033	8	14	4	2	5	4
18-28043	8	14	9	2	9	9
18-28044	8	12	5	3	9	9
18-28046	8	12/24	9	1	9	5
18-8802-1	8	13	5	1	9	5

Sierra #	No. of Cylinders	Coil Wire	Dist. End	Spark Plug End	Coil End	Coil Dist. End
STERNDRIVE/INBOARD IGNITION WIRES						
18-8803-1	8	13	5	1	9	5
18-8804-1	8	12	6	1	10	6
18-8805-1	8	13	5	1	9	5
18-8806-1	8	13	5	1	9	5
18-8817-1	8	12	5	2	2	2
18-8820-1	8	14	4	1	6	4
18-8821-1	8	12	6	1	5	6
18-8822-1	8	15.5	4	1	4	4
18-8823-1	8	12/17	9	1	11	5
18-8824-1	8	14	4	1	6	4
18-8825-1	8	14	5	3	11	5
18-8826-1	8	14	9	2	11	9
18-8827-1	8	9	9	1	11	9
18-8828-1	8	21	17	1	8	8
18-8830-1	8	16	4	1	10	4
18-8832-1	8	9	4	1	4	4
18-8834-1	8	12	6	1	10	6
18-8836-1	8	16	4	1	4	4
18-8837-1	8	8	1	1	10	1
18-8838-2	8	-	8	12	-	-
18-8842-1	8	9	5	3	5	5
18-8843-1	8	16	5	3	5	5
18-8844-1	8	14	4	2	6	4

Sierra #	No. of Cylinders	Coil Wire	Dist. End	Spark Plug End	Coil End	Coil Dist. End
GENERATOR IGNITION WIRES						
23-4500	3	10	5	2	5	5
23-4501	4	-	5	12	-	-



PREMIUM MARINE SPARK PLUG WIRE LEADS

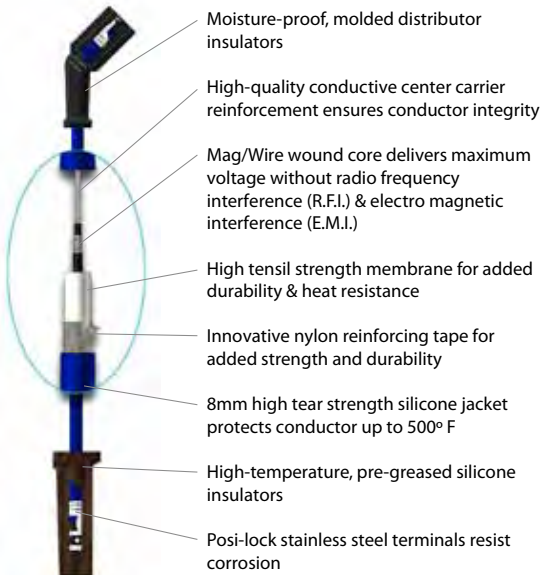

Sierra's **MAGFORCE** Ignition Wires are "Electronics Friendly" protecting all of your electronic devices and electronic engine controls from RFI and EMI while delivering the maximum amount of voltage. Exact fit design ensures easy installation and years of trouble - free service.



See application below.

PLUG WIRE SET APPLICATION CHARTS

CHRIS-CRAFT					
Engine	Cyl.	Distributor	Year Start	Year Stop	Plug Wire Set
181 CID (3.0L)	4	Conventional	ALL	ALL	18-8800-1
302	8	Conventional	ALL	ALL	18-28044
351	8	Conventional	ALL	ALL	18-28044
460	8	Conventional	ALL	ALL	18-28044
350	8	Conventional	1970	1990	18-8803-2
350	8	Conventional ❶	1970	1990	18-8823-1
454	8	Conventional	ALL	ALL	18-8817-1
502	8	Conventional	ALL	ALL	18-8817-1

❶ Models designed with Mallory side terminals

CHRYSLER					
Engine	Cyl.	Distributor	Year Start	Year Stop	Plug Wire Set
M273	8	Conventional & Electronic	1968	1974	18-8826-1
LM318	8	Conventional & Electronic	1968	1985	18-8826-1
M328	8	Conventional & Electronic	1960	1995	18-8826-1
M340	8	Conventional & Electronic	1968	1985	18-8826-1
M360	8	Conventional & Electronic	1975	1985	18-8826-1
361	8	Conventional & Electronic	1968	1985	18-8827-1
383	8	Conventional & Electronic	1960	1988	18-8827-1
400	8	Conventional & Electronic	1968	1985	18-8827-1
440	8	Conventional & Electronic	1968	1985	18-8827-1

CRUSADER-PCM					
Engine	Cyl.	Distributor	Year Start	Year Stop	Plug Wire Set
262 CID 4.3L	6	Prestolite	ALL	ALL	18-8801-1
262 CID 4.3L	6	Delco EST	ALL	ALL	18-8810-1
262 CID 4.3L	6	Delco HVS	ALL	ALL	18-8828-1
220 (305 CID 5.0L)	8	Mallory/Prestolite ❶	Up to	1987	18-8803-2
220 (305 CID 5.0L)	8	Mallory/Prestolite ❷	1987	1992	18-8803-2
270 (350 CID 5.7L)	8	Mallory/Prestolite ❶	Up to	1987	18-8803-2
270 (350 CID 5.7L)	8	Mallory/Prestolite ❷	1987	1992	18-8803-2
TB350	8	Delco EST ❸	1992	& Up	18-8824-1
5.7L Classic	8	Mallory	1999	& Up	18-8803-2
5.7L MPI Classic	8	Delco HVS	2007	& Up	18-8828-1
MP5.0L Captain's Choice	8	Delco HVS	2002	2005	18-8828-1
MP5.7L Captain's Choice	8	Delco HVS	2002	2005	18-8828-1
MP6.0L	8	Distributorless	2002	& Up	18-8838-1
350 (454 CID 7.4L)	8	Mallory ❹	Up to	1991	18-8803-2
454XL (454 CID 7.4L)	8	Delco EST ❺	1991	& Up	18-8824-1
CM454HO (454 CID 7.4L)	8	Delco EST ❻	1991	& Up	18-8824-1
454XL (454 CID 7.4L)	8	Delco EST ❼	1993	& Up	18-8824-1
MP8.1L	8	Distributorless	ALL	ALL	18-8838-1
502 (502 CID 8.2L)	8	Prestolite ❶	Up to	1991	18-8803-2
502 (502 CID 8.2L)	8	Delco EST ❷	Up to	1991	18-8824-1
502XL (502 CID 8.2L)	8	Delco EST ❸	1991	& Up	18-8824-1
TB502XL (502 CID 8.2L)	8	Delco EST ❹	1994	& Up	18-8824-1

❶ Serial Number up to 68702 ❷ Serial Number 68703-90232 ❸ Serial Number 90232 & UP ❹ Serial Number up to 88710
 ❺ Serial Number 88710 & Up ❻ Serial Number 92882 & Up ❼ Serial Number 94268 & Up

PLUG WIRE SET APPLICATION CHARTS (Cont.)

INDMAR

Engine	Cyl.	Distributor	Year Start	Year Stop	Plug Wire Set
140	8	Prestolite	Up to	1993	18-8803-2
200	8	Prestolite	Up to	1993	18-8803-2
225	8	Prestolite	Up to	1993	18-8803-2
250	8	Prestolite	Up to	1993	18-8803-2
275	8	Prestolite/Mallory	Up to	1993	18-8803-2
300	8	Prestolite/Mallory	Up to	1993	18-8803-2
350	8	Prestolite/Mallory	Up to	1993	18-8803-2
400	8	Prestolite/Mallory	Up to	1993	18-8803-2
5.7L EFI	8	Delco EST	1994	2009	18-8836-1
5.7L EFI	8	Delco HVS	2007	& Up	18-8828-1
6.0L EFI	8	Distributorless	2003	& Up	18-8838-1
6.2L EFI	8	Distributorless	2010	& Up	18-8838-1
454 Carbureted (7.4L)	8	Delco EST	1994	2011	18-8824-1
8.1L Vortec	8	Distributorless	2003	2011	18-8838-1
502 Carbureted (8.2L)	8	Delco EST	1994	2011	18-8824-1

MARINE POWER

Engine	Cyl.	Distributor	Year Start	Year Stop	Plug Wire Set
181	4	Delco	1986	1992	18-8800-1
262	6	Prestolite Ⓜ	1986	1992	18-8801-1
350	8	Prestolite Ⓜ	1986	1992	18-8802-1
350	8	Mallory	1986	1992	18-8802-1
3.0L	4	Delco EST	1993	& Up	18-8833-1
4.3L	6	Delco EST	1993	& Up	18-8835-1
5.0L	8	Delco EST	1993	2005	18-8822-1
5.0L	8	Delco HVS	2005	& Up	18-8828-1
5.7L	8	Delco EST	1993	2005	18-8822-1
5.7L	8	Delco HVS	2005	& Up	18-8828-1
7.4L	8	Delco EST	1993	2000	18-8832-1
8.2L	8	Delco EST	1993	2000	18-8832-1

Ⓜ Screw down cap

MERCURISER

Model	Cyl.	Distributor	Year Start	Year Stop	Serial # Start	Serial # End	Plug Wire Set
110	4	Delco	1963	1966	1537370	2044033	18-8800-1
120	4	Delco	1964	1986	1666601	0B531853	18-8800-1
2.5L	4	Delco	1987	1989	0B531854	0C853255	18-8800-1
140	4	Delco	1968	1986	2508261	0B450800	18-8800-1
3.0L	4	Delco	1987	1989	0B450801	0C856558	18-8800-1
3.0L, LX	4	Prestolite	1990	1991	0C856559	0D504541	18-8800-1
3.0L, LX	4	Delco Digital	1990	1991	0C856559	0D504541	18-8811-1
3.0L	4	Delco EST	1991	& Up	0D504542	& Up	18-8833-1
3.0LX	4	Delco EST	1991	1997	0D504542	0K999999	18-8833-1
3.0L MPI	4	Delco EST	2012	& Up	1A072812	& Up	18-8833-1
165	4	Delco	1987	1987	0B434940	0B774251	18-8808-2
170	4	Delco	1985	1986	6916779	0B434940	18-8808-2
180	4	Prestolite	1987	1987	0B436391	0B775248	18-8800-1
190	4	Delco	1985	1986	6916779	0B436390	18-8808-2
3.7L	4	Delco	1988	1989	0B774252	& Up	18-8808-2
3.7LX	4	Delco	1988	1989	0B775249	& Up	18-8808-2
3.7LX	4	Prestolite	1988	1989	0B775249	& Up	18-8800-1
470	4	Delco	1976	1984	4208370	6916778	18-8808-2
485	4	Delco	1980	1982	5685394	6218036	18-8808-2

MERCURISER CONTINUED ON NEXT PAGE

PLUG WIRE SET APPLICATION CHARTS (Cont.)

MERCUISER							
Model	Cyl.	Distributor	Year Start	Year Stop	Serial # Start	Serial # End	Plug Wire Set
488	4	Delco	1981	1984	6170297	6916778	18-8808-2
140	L6	Delco	1963	1963	1538930	1725960	18-8809-1
150	L6	Delco	1964	1966	1666495	2048046	18-8809-1
160	L6	Delco	1967	1969	2048022	2770031	18-8809-1
165	L6	Delco	1970	1981	2770032	5813433	18-8809-1
200	L6	Delco	1969	1969	2453769	2712072	18-8809-1
185	6	Prestolite	1983	1984	6330183	6919655	18-8801-1
175	6	Thunderbolt IV	1987	1987	0B527955	0B773242	18-8810-1
185	6	Thunderbolt IV	1985	1987	6919656	0B527954	18-8810-1
205	6	Thunderbolt IV	1985	1987	0A331445	0B775129	18-8810-1
262 Mag	6	Delco EST	1996	1997	0F803800	0K999999	18-8835-1
4.3L	6	Thunderbolt IV	1988	1996	0B773243	0F802999	18-8810-1
4.3L Alpha	6	Thunderbolt V	1998	& Up	0L010044	& Up	18-8810-1
4.3L Bravo	6	Thunderbolt V	1998	& Up	0L010044	& Up	18-8810-1
4.3L EFI	6	Delco EST	1998	1998	0L012009	0L359999	18-8835-1
4.3L EFI	6	Thunderbolt V	1999	2004	0L360000	&Up	18-8810-1
4.3L MPI	6	Delco HVS	2001	& Up	0M300000	& Up	18-8829-1
4.3LH Alpha	6	Thunderbolt V	1998	2004	0L010044	& Up	18-8810-1
4.3LH Bravo	6	Thunderbolt V	1998	2004	0L010044	& Up	18-8810-1
4.3LX, LXH	6	Thunderbolt IV	1988	1997	0B775130	0K999999	18-8810-1
215 MCM & MIE (Ford)	8	Autolite/Mallory	1970	1972	2781153	3563181	18-8803-2
225 MCM & MIE (Ford)	8	Autolite/Mallory/Mercury	1973	1974	3385721	4166999	18-8803-2
888 (Ford)	8	Autolite/Mallory	1971	1977	3108723	4887829	18-8803-2
190 (GM)	8	Delco	1963	1964	1564539	1730903	18-8803-2
198 MIE	8	Mallory	1977	1977	4776402	4931099	18-8803-2
200	8	Thunderbolt IV	1985	1987	6899058	8774444	18-8821-1
228	8	Mallory	1977	1982	4765100	6218461	18-8803-2
228	8	Thunderbolt IV	1983	1984	6218462	6899268	18-8821-1
228 MIE	8	Mallory	1977	1980	4765100	5907057	18-8803-2
230	8	Thunderbolt IV	1985	1987	6899269	0B773739	18-8821-1
230 MIE (LH)	8	Thunderbolt IV	1981	1987	5907058	0B788151	18-8821-1
230 MIE (RH)	8	Thunderbolt IV	1981	1987	5907058	0B788151	18-8821-1
5.0L	8	Thunderbolt IV	1988	1995	0B774445	0F600999	18-8821-1
5.0L Alpha	8	Thunderbolt V	1998	& Up	0L015751	& Up	18-8821-1
5.0L Bravo	8	Thunderbolt V	1998	& Up	0L015751	& Up	18-8821-1
5.0L EFI	8	Delco EST	1998	1998	0L012052	0L339999	18-8822-1
5.0L MIE (LH)	8	Thunderbolt IV	1988	1988	0B788152	0C396832	18-8821-1
5.0L MIE (RH)	8	Thunderbolt IV	1988	1988	0B788152	0C396832	18-8821-1
5.0L MPI Alpha	8	Delco HVS	2001	& Up	0M300000	& Up	18-8828-1
5.0LX	8	Thunderbolt IV	1988	1995	0B773740	0F600999	18-8821-1
898	8	Mallory	1977	1982	4762210	6218461	18-8803-2
898	8	Thunderbolt IV	1983	1984	6218462	6899057	18-8821-1
225 (GM)	8	Delco	1963	1969	1539620	2694014	18-8803-2
225 MIE (GM)	8	Thunderbolt	1968	1968	2278647	2694014	18-8803-2
250 MCM & MIE	8	Thunderbolt	1968	1969	2314301	2639854	18-8803-2
250	8	Mallory	1977	1977	4768000	4908849	18-8803-2
255 MCM & MIE	8	Mallory	1975	1976	3258728	4501254	18-8803-2
255 MCM & MIE	8	Mercury	1976	1976	4498701	4767999	18-8803-2
255 MIE	8	Mercury	1977	1980	4768000	5907057	18-8803-2
260	8	Mallory	1978	1982	4908850	6218461	18-8803-2
260	8	Thunderbolt IV	1982	1987	6218462	0B773304	18-8821-1
260 MIE (LH)	8	Thunderbolt IV	1981	1986	5907058	0B788151	18-8821-1
260 MIE (RH)	8	Thunderbolt IV	1981	1986	5907058	0B788151	18-8821-1

MERCUISER CONTINUED ON NEXT PAGE

PLUG WIRE SET APPLICATION CHARTS (Cont.)

MERCURISER

Model	Cyl.	Distributor	Year Start	Year Stop	Serial # Start	Serial # End	Plug Wire Set
270 MCM & MIE	8	Thunderbolt	1969	1972	2851074	3385720	18-8803-2
280 TRS	8	Mercury/Mallory	1975	1975	4176250	4499390	18-8803-2
300	8	Thunderbolt IV	1985	1986	6668677	0B430367	18-8821-1
320 EFI	8	Thunderbolt IV	1987	1989	0A543604	0C622418	18-8821-1
350 Mag Alpha	8	Thunderbolt IV	1986	1994	0A635178	0F353690	18-8821-1
350 Mag Alpha	8	Thunderbolt V	1995	1997	0F353691	0K999999	18-8821-1
350 Mag Alpha EFI	8	Delco EST	1996	1997	0F800300	0K999999	18-8822-1
350 Mag Bravo MPI	8	Delco EST	1995	1996	0F415189	0K999999	18-8822-1
350 Mag EFI Ski	8	Delco EST	1994	1997	0F215561	0K999999	18-8822-1
350 Mag MPI	8	Delco EST	1998	1998	0L010019	0L325952	18-8822-1
350 Mag MPI Alpha	8	Delco HVS	2001	& Up	0M300000	& Up	18-8828-1
350 Mag MPI Bravo	8	Delco HVS	2001	& Up	0M300000	& Up	18-8828-1
350 Mag MPI Horizon	8	Delco HVS	2001	& Up	0M300000	& Up	18-8828-1
350 Mag MPI Horizon MIE	8	Delco HVS	2001	& Up	0M300000	& Up	18-8828-1
350 Mag MPI MIE	8	Delco HVS	2001	& Up	0M300000	& Up	18-8828-1
350 Mag MPI Ski	8	Thunderbolt IV	1991	1996	0D505450	0K40399	18-8821-1
350 Mag MPI Ski	8	Thunderbolt V	1991	1997	0D505450	0K999999	18-8821-1
5.7L Alpha	8	Thunderbolt IV	1988	1995	0B773305	0F600999	18-8821-1
5.7L Alpha	8	Thunderbolt V	1996	1997	0F601000	& Up	18-8821-1
5.7L Bravo	8	Thunderbolt IV	1988	1993	0B773305	0F353524	18-8821-1
5.7L Bravo	8	Thunderbolt V	1994	& Up	0F353525	& Up	18-8821-1
5.7L EFI	8	Delco EST	1995	1998	0F225560	0L339999	18-8822-1
5.7L EFI MIE	8	Delco EST	1997	1997	0K040300	0K999999	18-8822-1
5.7L MIE	8	Thunderbolt IV	1988	1995	0B788152	0F746099	18-8821-1
5.7L MIE	8	Thunderbolt V	1996	1997	0F622100	0K999999	18-8821-1
5.7L MIE	8	Thunderbolt V	1998	& Up	0L002003	& Up	18-8821-1
5.7L Ski	8	Mallory/Prestolite	1985	1995	0A338553	0F775199	18-8802-1
5.7L Ski	8	Thunderbolt IV	1987	1995	0B514627	0F775199	18-8821-1
5.7L Ski	8	Thunderbolt V	1996	1997	0F775200	0K999999	18-8821-1
5.7L Ski	8	Thunderbolt V	1998	& Up	0L002005	& Up	18-8821-1
5.7LX Alpha & Bravo	8	Thunderbolt V	1996	1997	0F601000	0K999999	18-8821-1
5.7LX Bravo & EFI	8	Delco EST	1996	1997	0F752400	0K999999	18-8822-1
233 MCM & MIE (Ford)	8	Mercury/Prestolite	1975	1977	4173000	4902304	18-8803-2
255 MCM & MIE (Ford)	8	Mercury/Mallory	1973	1980	3258728	5907057	18-8803-2
MX 6.2L MPI	8	Delco HVS	2001	& Up	0M300000	& Up	18-8828-1
MX 6.2L MPI Horizon	8	Delco HVS	2001	& Up	0M300000	& Up	18-8828-1
MX 6.2L MPI Horizon MIE	8	Delco HVS	2001	& Up	0M300000	& Up	18-8828-1
MX 6.2L MPI MIE	8	Delco HVS	2001	& Up	0M300000	& Up	18-8828-1
377 MAG MPI BRAVO	8	Delco HVS	ALL	ALL	1A300000	& Up	18-8828-1
325 MCM & MIE	8	Thunderbolt	1969	1974	2278747	& Up	18-8803-2
325 MCM & MIE	8	Mallory	1969	1972	2278747	& Up	18-8803-2
390	8	Mallory	1968	1970	ALL		18-8803-2
330	8	Mallory	1977	1981	4623115	6083144	18-8803-2
330	8	Thunderbolt	1977	1981	4623115	6083144	18-8803-2
330	8	Thunderbolt IV	1982	1987	6083145	0B816540	18-8821-1
340 MIE	8	Thunderbolt IV	1981	1987	5889914	0B788365	18-8821-1
350 MIE	8	Thunderbolt	1974	1976	3780450	4623109	18-8803-2
370 TRS	8	Mallory/Holley	1978	1985	4179554	6721527	18-8803-2
370 TRS	8	Thunderbolt IV	1985	1987	6721528	0B714586	18-8821-1
400 TRS	8	Mallory/Holley	1980	1986	5668232	0B457644	18-8803-2
440 TRS	8	Mallory/Holley	1983	1986	6181070	0B485220	18-8803-2
450	8	Thunderbolt IV	1995	1996	0F347100	0F347277	18-8821-1
454 Mag Alpha	8	Thunderbolt IV	1986	1988	0A631894	0B785148	18-8821-1

MERCURISER CONTINUED ON NEXT PAGE

PLUG WIRE SET APPLICATION CHARTS (Cont.)

MERCURISER							
Model	Cyl.	Distributor	Year Start	Year Stop	Serial # Start	Serial # End	Plug Wire Set
454 Mag Bravo	8	Thunderbolt IV	1988	1997	0B721206	0K999999	18-8821-1
454 Mag EFI	8	Delco EST	1994	1996	0F115700	0F802349	18-8822-1
454 Mag MPI	8	Delco EST	1996	2001	0F802350	M024999	18-8822-1
454 Mag MPI Horizon MIE	8	Delco EST	1999	2001	0L002200	0L674000	18-8822-1
454 Mag MPI Ski	8	Delco EST	1995	1997	0F215800	0K999999	18-8822-1
7.4L Bravo I, II, III	8	Thunderbolt IV	1988	1997	0B771113	0K999999	18-8821-1
7.4L Bravo III	8	Thunderbolt V	1992	1997	603118	0K999999	18-8821-1
7.4L EFI MIE	8	Thunderbolt IV	1988	1996	0B788366	0F820141	18-8821-1
7.4L MIE	8	Thunderbolt IV	1988	1996	0B788366	0F820141	18-8821-1
7.4L MIE	8	Thunderbolt V	1992	1997	0D715494	0K999999	18-8821-1
7.4L MPI (L29)	8	Delco EST	1998	2001	0L010003	0M024330	18-8822-1
7.4L MPI MIE	8	Delco EST	1995	2001	0F563052	0M025999	18-8822-1
7.4LX Bravo EFI & MPI	8	Delco EST	1996	1997	0F602010	0K999999	18-8822-1
390	8	Thunderbolt	1969	1970	2781129	2825059	18-8803-2
460 TRS	8	Mallory/Holley	1983	1986	6180970	6181046	18-8803-2
460 Cyclone	8	ALL	1983	1985	ALL		18-8803-2
496 Mag & Mag HO	8	Delco (coil over plug)	2000	& Up	0M025000	& Up	18-8838-1
8.1 MIE & HO MIE	8	Delco (coil over plug)	2000	& Up	0M025000	& Up	18-8838-1
502 Mag Bravo	8	Thunderbolt IV	1990	1993	0G878221	0F114528	18-8821-1
502 Mag EFI	8	Delco EST	1993	1996	0B40650	0F802599	18-8822-1
502 Mag MPI	8	Delco EST	1996	2001	0F802600	0M024999	18-8822-1
525 SC	8	Thunderbolt IV	1991	1995	0D456000	0F877734	18-8821-1
8.2L MIE	8	Thunderbolt IV	1990	1996	0C878221	0F819619	18-8821-1
8.2L MPI MIE	8	Delco EST	1996	2001	0F819620	0L674200	18-8822-1

OMC						
Engine	Cyl.	Distributor	Year Start	Year Stop	Plug Wire Set	
2.3L	4	Mallory	1987	1990	18-8807-1	
2.3L	4	Prestolite	1990	1990	18-8807-1	
2.5L	4	Delco	1981	1986	18-8800-1	
3.0L	4	Delco	1982	1990	18-8800-1	
3.0L	4	Delco EST	1990	1998	18-8833-1	
3.8L	6	Prestolite	1981	1985	18-8801-1	
4.3L	6	Prestolite ②	1985	1990	18-8801-1	
4.3L	6	Prestolite	1991	1993	18-8801-1	
4.3L	6	Delco EST	1994	1998	18-8835-1	
5.0L (GM)	8	Prestolite ①	1979	1982	18-8802-1	
5.0L (GM)	8	Mallory	1981	1988	18-8802-1	
5.0L (GM)	8	Prestolite ②	1983	1988	18-8802-1	
5.0L (Ford)	8	Prestolite ②	1989	1990	18-8806-1	
5.0L (Ford)	8	Prestolite	1991	1996	18-8806-1	
5.0L (Ford)	8	Ford HEI	1993	1996	18-8820-1	
5.0L (GM)	8	Prestolite	1998	1998	18-8801-1	
5.0L (GM)	8	Delco EST	1998	1998	18-8822-1	
5.7L	8	Mallory	1982	1990	18-8802-1	
5.7L	8	Prestolite ②	1982	1990	18-8802-1	
5.7L	8	Prestolite ②	1991	1998	18-8802-1	
5.7L	8	Delco EST	1996	1998	18-8822-1	
5.8L	8	Prestolite ②	1989	1990	18-8842-1	
5.8L	8	Prestolite ②	1991	1996	18-8842-1	
5.8L	8	Ford HEI	1993	1996	18-8820-1	
7.4L	8	Mallory	1988	1988	18-8802-1	

OMC CONTINUED ON NEXT PAGE

PLUG WIRE SET APPLICATION CHARTS (Cont.)

OMC

Engine	Cyl.	Distributor	Year Start	Year Stop	Plug Wire Set
7.4L	8	Prestolite ②	1988	1988	18-8802-1
7.4L	8	Distributorless	1990	1991	18-8843-1
7.4L	8	Delco EST	1995	1998	18-8832-1
7.5L	8	Prestolite ②	1987	1987	18-8803-2
7.5L	8	Prestolite ②	1987	1989	18-8803-2
8.2L	8	Mallory	1984	1985	18-8802-1
8.2L	8	Prestolite ②	1984	1985	18-8802-1
8.2L	8	Delco EST	1998	1998	18-8832-1
80	4	ALL	1962	1968	18-8800-1
90	4	ALL	1962	1968	18-8800-1
100	4	Delco	1972	1973	18-8800-1
110	4	Delco	1964	1964	18-8800-1
120	4	Delco	1965	1981	18-8800-1
140	4	Delco	1973	1981	18-8800-1
170	8	Prestolite ①	1974	1974	18-8802-1
175	8	Prestolite ①	1975	1977	18-8802-1
185	8	Mallory	1967	1968	18-8802-1
185	8	Mallory	1978	1980	18-8802-1
185	8	Prestolite ①	1978	1980	18-8802-1
190	8	Prestolite ①	1974	1977	18-8802-1
200	8	Mallory	1979	1988	18-8802-1
200	8	Prestolite ①	1979	1981	18-8802-1
210	8	Mallory	1968	1970	18-8802-1
215	8	Mallory	1971	1971	18-8802-1
225	8	Mallory	1972	1976	18-8802-1
225	8	Mallory	1978	1978	18-8802-1
230	8	Mallory	1979	1981	18-8802-1
230	8	Prestolite ①	1979	1981	18-8802-1
230	8	Mallory	1975	1976	18-8802-1
235	8	Mallory	1971	1971	18-8802-1
235	8	Prestolite ①	1975	1977	18-8802-1
240	8	Prestolite ①	1978	1978	18-8802-1
245	8	Mallory	1975	1975	18-8802-1
250	8	Mallory	1970	1974	18-8802-1
250	8	Prestolite ①	1979	1979	18-8802-1
260	8	Mallory	1975	1976	18-8802-1
260	8	Mallory	1979	1981	18-8802-1
260	8	Prestolite ①	1979	1981	18-8802-1
290 JET	8	Mallory	1974	1975	18-8802-1
305	8	Mallory	1977	1979	18-8802-1
305	8	Mallory	1980	1981	18-8802-1
305	8	Prestolite ①	1981	1981	18-8802-1
350	8	Mallory	1977	1979	18-8802-1
350	8	Mallory	1980	1981	18-8802-1
350	8	Prestolite ①	1981	1981	18-8802-1
454	8	Mallory	1977	1979	18-8803-2
454	8	Mallory	1980	1981	18-8803-2
454	8	Prestolite ①	1981	1981	18-8803-2

① Clip down cap ② Snap down cap

VOLVO

Model	Cyl.	Distributor	Year Start	Year End	Plug Wire Set
AQ115A, B	4	Volvo	1969	1975	18-28050

VOLVO CONTINUED ON NEXT PAGE

PLUG WIRE SET APPLICATION CHARTS (Cont.)

VOLVO					
Model	Cyl.	Distributor	Year Start	Year End	Plug Wire Set
AQ120B	4	Volvo	1977	1980	18-8813-1
AQ125A, B	4	Volvo	1981	1985	18-8813-1
AQ130A, B, C, D	4	Volvo	1968	1977	18-28050
AQ131A, B, C, D	4	Volvo	1985	1989	18-8813-1
AQ140A	4	Volvo	1975	1979	18-8813-1
AQ145A, B	4	Volvo	1979	1985	18-8813-1
AQ151A, B, C	4	Volvo	1985	1989	18-8813-1
AQ175A	6	Volvo	1981	1985	18-8801-1
AQ190A	8	Volvo	1976	1977	18-8802-1
AQ200B	8	Mallory (Tall Cap)	1974	1976	18-8802-1
AQ200B	8	Mallory (Flat Cap)	1974	1976	18-8823-1
AQ200C	8	Mallory (Tall Cap)	1976	1977	18-8802-1
AQ200C	8	Mallory (Flat Cap)	1976	1977	18-8823-1
AQ205A	6	Volvo	1988	1989	18-8801-1
AQ211A	8	Volvo	1986	1989	18-8802-1
AQ225B	8	Mallory (Tall Cap)	1974	1976	18-8802-1
AQ225B	8	Mallory (Flat Cap)	1974	1976	18-8823-1
AQ231A, B	8	Volvo	1986	1989	18-8802-1
AQ240A	8	Volvo	1976	1977	18-8802-1
AQ255A	8	Mallory (Flat Cap)	1977	1978	18-8823-1
AQ255B	8	Mallory (Tall Cap)	1978	1978	18-8802-1
AQ255B	8	Mallory (Flat Cap)	1978	1978	18-8823-1
AQ260A	8	Mallory (Tall Cap)	1979	1985	18-8802-1
AQ260A	8	Mallory (Flat Cap)	1979	1985	18-8823-1
AQ260B	8	Mallory (Tall Cap)	1985	1986	18-8802-1
AQ271A, B, C, D	8	Volvo	1986	1989	18-8802-1
AQ280A	8	Mallory (Tall Cap)	1978	1979	18-8802-1
AQ280A	8	Mallory (Flat Cap)	1978	1979	18-8823-1
AQ290A	8	Mallory (Tall Cap)	1979	1985	18-8802-1
AQ290A	8	Mallory (Flat Cap)	1979	1985	18-8823-1
AQ311A, B	8	Volvo	1986	1989	18-8802-1
BB140A	4	Volvo	1975	1979	18-8813-1
BB145A	4	Volvo	1979	1985	18-8813-1
BB225A, AV, B, C	8	Volvo	1973	1977	18-8802-1
BB231A	8	Volvo	1987	1987	18-8802-1
BB260A, AV, B, C	8	Volvo	1978	1985	18-8802-1
BB261A	8	Volvo	1988	1989	18-8802-1
230A, B	4	Volvo	1989	1992	18-8813-1
250A, B	4	Volvo	1989	1992	18-8813-1
432A	6	Delco EST	1992	1993	18-8835-1
434A	6	Delco EST	1992	1993	18-8835-1
3.0GLM	4	Delco EST	1993	1994	18-8833-1
3.0GLM	4	Delco EST	2002	2004	18-8833-1
3.0GLP	4	Delco EST	2002	2010	18-8833-1
3.0GSM	4	Delco EST	1994	2002	18-8833-1
3.0GSP	4	Delco EST	1993	2002	18-8833-1
3.0GX1	4	Delco EST	2008	2009	18-8833-1
4.3GI	6	Delco EST	1994	2000	18-8835-1
4.3GL	6	Delco EST	1993	2010	18-8835-1
4.3GS	6	Delco EST	1993	1999	18-8835-1
4.3GX1	6	Delco HVS	2001	2015	18-8829-1
4.3GX1	6	Delco EST	2001	2002	18-8835-1
4.3GXIE	6	Delco HVS	2009	2015	18-8829-1

VOLVO CONTINUED ON NEXT PAGE

PLUG WIRE SET APPLICATION CHARTS (Cont.)

VOLVO

Model	Cyl.	Distributor	Year Start	Year End	Plug Wire Set
4.3SI	6	Delco HVS	2001	2009	18-8829-1
4.3SI-BF	6	Delco HVS	2001	2002	18-8829-1
5.0FI	8	Ford	1994	1996	18-8820-1
5.0FL	8	Prestolite	1994	1996	18-8802-1
5.0GI	8	Delco EST	1997	2000	18-8836-1
5.0GL	8	Prestolite	1997	2001	18-8802-1
5.0GL	8	Delco EST	2001	2006	18-8836-1
5.0GXI	8	Delco HVS	2001	2015	18-8828-1
5.0GXI-A	8	Delco EST	2001	2002	18-8836-1
5.0GXIC	8	Delco HVS	2007	2009	18-8828-1
5.0GXIE	8	Delco HVS	2007	2015	18-8828-1
5.0OSI	8	Delco HVS	2001	2009	18-8828-1
5.0OSiE	8	Delco HVS	2008	2009	18-8828-1
5.7GI	8	Delco EST	1993	1997	18-8836-1
5.7Gi	8	Delco HVS	2001	2015	18-8828-1
5.7GI	8	Delco EST	2004	2005	18-8836-1
5.7GiC	8	Delco HVS	2008	2009	18-8828-1
5.7GiCE	8	Delco HVS	2008	2009	18-8828-1
5.7GiE	8	Delco HVS	2007	2015	18-8828-1
5.7GIL	8	Delco HVS	2002	2009	18-8828-1
5.7GIL-A	8	Delco EST	2001	2001	18-8836-1
5.7GL	8	Prestolite	1993	1997	18-8802-1
5.7GL	8	Delco EST	1993	1997	18-8836-1
5.7GL	8	Delco EST	2001	2004	18-8836-1
5.7GL-A	8	Mallory	2001	2001	18-8802-1
5.7GSI	8	Delco EST	1996	2001	18-8836-1
5.7GSP	8	Prestolite	1996	2000	18-8802-1
5.7GXI	8	Delco HVS	2001	2015	18-8828-1
5.7GXI-A, B	8	Delco EST	2000	2002	18-8836-1
5.7GXIC	8	Delco HVS	2007	2008	18-8828-1
5.7GXICE	8	Delco HVS	2007	2010	18-8828-1
5.7GXIE	8	Delco HVS	2007	2015	18-8828-1
5.7GXIL	8	Delco HVS	2001	2008	18-8828-1
5.7GXIL-A, B	8	Delco EST	2000	2002	18-8836-1
5.7OSi	8	Delco HVS	2001	2009	18-8828-1
5.7OSiE	8	Delco HVS	2008	2009	18-8828-1
5.7OSXI	8	Delco HVS	2001	2009	18-8828-1
5.7OSXiE	8	Delco HVS	2008	2009	18-8828-1
5.8FI	8	Ford	1994	1996	18-8820-1
5.8FL	8	Prestolite	1994	1996	18-8803-1
5.8FSI	8	Prestolite	1994	1996	18-8803-1
7.4GI	8	Delco EST	1994	2000	18-8836-1
7.4GL	8	Prestolite	1993	1997	18-8802-1
7.4GLI	8	Prestolite	1993	1996	18-8802-1
7.4GLP	8	Prestolite	1993	1997	18-8802-1
7.4GLP	8	Prestolite	1994	1997	18-28051
7.4GLP	8	Delco EST	1995	1996	18-8836-1
7.4GSI	8	Delco EST	1994	2000	18-8836-1
8.1Gi-A	8	Distributorless	1999	2015	18-8838-1
8.1GiC	8	Distributorless	2007	2015	18-8838-1
8.1GiCE	8	Distributorless	2007	2015	18-8838-1
8.1GiE	8	Distributorless	2007	2015	18-8838-1
8.1GiL	8	Distributorless	2000	2008	18-8838-1

VOLVO CONTINUED ON NEXT PAGE

PLUG WIRE SET APPLICATION CHARTS (Cont.)

VOLVO

Model	Cyl.	Distributor	Year Start	Year End	Plug Wire Set
8.1GSi	8	Distributorless	2000	2001	18-8838-1
8.1GXi	8	Distributorless	2001	2015	18-8838-1
8.1GXIE	8	Distributorless	2007	2015	18-8838-1
8.1GXil	8	Distributorless	2001	2008	18-8838-1
8.1IPSCE	8	Distributorless	2008	2015	18-8838-1
8.1OSI	8	Distributorless	2003	2009	18-8838-1
8.1OSIE	8	Distributorless	2008	2009	18-8838-1
8.2GLI	8	Prestolite	1993	1994	18-8803-1
8.2GLP	8	Prestolite	1993	1994	18-8803-1
8.2GSI	8	Delco EST	1995	2000	18-8836-1
DPX375	8	Distributorless	2000	2002	18-8838-1
DPX385	8	Delco EST	1996	2000	18-8836-1
DPX415	8	Delco EST	1996	2000	18-8836-1
DPX420	8	Distributorless	2000	2002	18-8838-1
V6-200	6	Delco HVS	2012	2015	18-8828-1
V6-225	6	Delco HVS	2012	2015	18-8828-1
V8-270	8	Delco HVS	2012	2015	18-8829-1
V8-300	8	Delco HVS	2012	2015	18-8829-1
V8-320	8	Delco HVS	2012	2015	18-8829-1

YAMAHA STERNDRIVE

Model	Cyl.	Distributor	Year Start	Year End	Plug Wire Set
3.0L	4	Delco EST	1990	1993	18-8835-1
4.3L	6	YEMS	1989	1989	18-8835-1
4.3L	6	Delco EST	1990	1990	18-8835-1
5.0L	8	YEMS	1989	1989	18-8836-1
5.7L	8	Delco EST	1989	1990	18-8836-1
7.4L	8	Delco EST	1992	1992	18-8836-1



OIL FILTERS

Sierra oil filters are engineered with premium grade materials that will not only withstand but excel in the extreme environment of the Marine world. Sierra ensures the excellent performance of their filters by:

- Epoxy coating all canisters for corrosion resistance.
- Using a heavy-wall steel canister for further corrosion protection.
- Using high-efficiency filter media that meets or exceeds the OE's filtration.
- Backed by Sierra's industry leading warranty.

DIESEL OIL FILTERS

 <p>18-0032 Replaces: Volvo 847741</p>	 <p>18-0033 Replaces: Volvo 21707133</p>	 <p>18-0034 Replaces: Volvo 477556</p>
 <p>18-0035 Replaces: Volvo 3582732 Full Flow</p>	 <p>18-0036 Replaces: Volvo 3582733 Bypass</p>	 <p>18-7871 Replaces: MerCruiser 35-805809</p>
 <p>18-7880 Replaces: Caterpillar 1R-0658 Volvo-Penta 466634</p>	 <p>*18-7884 Replaces: Universal 299381 Volvo-Penta 834337 Thread Spec: 3/4" x 16NPT</p>	 <p>*18-7886 Replaces: Perkins 2654403 Thread Spec: 3/4" x 16NPT</p>
 <p>*18-7910-1 Replaces: Westerbeke 30220 Yanmar 124450-35100, 119350-35151, 119350-35150 Thread Spec: 20mm x 1.5</p>	 <p>*18-7917 Replaces: Yanmar 124450-35110, 124550-35110, 171056-35110, 171056-35111, 124085-35113 Thread Spec: 20mm x 1.5</p>	 <p>*18-7925 Replaces: Westerbeke 21235 Thread Spec: 3/4" x 16NPT</p>
 <p>*18-7926 Replaces: Volvo 423135, 4785974 Thread Spec: 1" x 12NPT</p>	 <p>18-7927 Replaces: Caterpillar 1R-0714 Thread Spec: 1 1/8" x 16NPT</p>	

* Anti-Drain-Back Valve

Valve eliminates dry starts, prevents oil from draining back into crankcase during engine shutdown.

STERNDRIVE & INBOARD OIL FILTERS



***18-7824-2
Short GM**
Replaces:
Chris-Craft 16.81-08746
Crusader 201104
Indmar 50-1001
Mercruiser 35-802885Q, 32716, 866340Q02, Q03, 866340K01, Mercruiser Vazer, 35-866340Q02, 35-866340K01, 35-866340Q, 52731A1, 52731, 52022, 32717, 14957
OMC 173232, 778864
Pleasurecraft R077002
Volvo-Penta 835440
Yamaha YSC-10231-20-0C
Thread Spec: 13/16" x 16NPT



***18-7875
Long Ford**
Replaces:
Chris-Craft 16.81-06536
Chrysler 1851658, 56874, F724002
Crusader 9002514
Mercruiser 60565, 35-802886Q
OMC 173231, 502900
Pleasurecraft R077001
Yamaha YSC-16231-20-0C
Thread Spec: 3/4" x 16NPT



***18-7876-1
Long GM**
Replaces:
Mercruiser 35-866340Q03, 35-866340Q02, 52731, 52731A1, 54111, 35-802885Q, 14957, 52022, 32717, 32716
OMC 173233, 502901
Volvo 3850559
Yamaha YSC-14231-20-0C
Thread Spec: 13/16" x 16NPT



***18-7878-1
Short Ford**
Replaces:
Chrysler 3549957, L-19, L-1008
Mercruiser 803470, 46692, 38463
OMC 502904
Volvo 430143, 1266286, 3517857
Thread Spec: 3/4" x 16NPT



***18-7879-1
V-6 GM**
Replaces:
Chrysler L-319
Mercruiser 35-802884Q, 41815, 35-883702Q, K
OMC 173834, 502903
Volvo 841750
Thread Spec: 18mm x 1.5



18-57824
Replaces:
Ilmor MV8V1021
Fits: Mastercraft and Ilmor V8 GM New LS Series SB engines (Remote Mount)



18-8779
Replaces:
Indmar 872025
Fits: 6.2L Ford Engines 2015-2016



**18-57702
CRANKCASE FILTER**
Replaces: 876069
Fits: Volvo MD30A, TMD30A, TAMD30A, MD31A, TMD31A, TAMD31A, MD40A, TMD40A, TMD40B, TAMD40A, TAMD40B, TMD41A, TAMD41A

4-CYCLE OUTBOARD OIL FILTERS



18-7758
Replaces:
Mercury 35-877761K01, 35-877761Q01
Thread Spec: 22mm x 1.5



***18-7895**
Replaces:
Johnson/Evinrude 778888, 5035703
Suzuki 16510-93J00
Thread Spec: 3/4" x 16NPT



***18-7896**
Replaces:
Johnson/Evinrude 778886, 5033539
Suzuki 16510-61A20-MHL
Thread Spec: 3/4" x 16NPT



***18-7897**
Replaces:
Johnson/Evinrude 778887, 5033919
Suzuki 16510-82703
Thread Spec: 3/4" x 16NPT



18-7901
Replaces:
Mercury 825467A1, 825467T1
Yamaha 6G8-13440-00-00



***18-7902**
Replaces:
Yamaha 3FV-13440-20-00, 3FV-13440-00-00
Thread Spec: 20mm x 1.5

* Anti-Drain-Back Valve
Valve eliminates dry starts, prevents oil from draining back into crankcase during engine shutdown.



18-7903
Replaces:
 Johnson/Evinrude 5033102, 763364
 Suzuki 16510-05240



***18-7905-1**
Replaces:
 Suzuki 16510-96J00
Thread Spec: 20mm x 1.5



***18-7906-1**
Replaces:
 Yamaha 69J-13440-00-00, 69J-13440-01-00
 Mercury 35-822626T7, 35-822626Q15, 35-8226267
Thread Spec: 3/4" x 16NPT



***18-7909**
Replaces:
 Honda 15400-POH-305PE, 15400-POH-305, 15400-ZJI-004, 15400-PLM-A01PE
Thread Spec: 20mm x 1.5



***18-7911-1**
Replaces:
 Honda 15400-PFB-007
 Nissan 3R0-07615-0
 Yamaha 5GH-13440-00-00
Thread Spec: 20mm x 1.5



***18-7913**
Replaces:
 Honda 15400-PFB-014
 Mercury 35-822626Q1, Q03
Thread Spec: 20mm x 1.5



***18-7914**
Replaces:
 Mercury 35-822626Q2, 35-822626Q04, 35-877768K01, 35-822626K04, 35-822626T2, 35-8M0064104, 35-8M0008397
Thread Spec: 20mm x 1.5



***18-7915-1**
Replaces:
 Johnson/Evinrude 778885, 5031411
 Suzuki 16510-87J00
Thread Spec: 3/4" x 16NPT



***18-7916**
Replaces:
 Johnson/Evinrude 434839
Thread Spec: 3/4" x 16NPT



***18-7918**
Replaces:
 Mercury 35-883701K01, 35-877769K01
Thread Spec: 24mm x 1.5



***18-7921**
Replaces:
 Mercury 35-896546T, 35-877767K01
Thread Spec: 24mm x 1.5



***18-7954**
Replaces: Yamaha N26-13440-02-00, N26-13440-00-00
Fits: F350
Thread Spec: 3/4" x 16NPT



18-7974
Replaces:
 Volvo 3827069
Thread Spec: 18mm x 1.5



18-8003
Replaces:
 Volvo 8692305



18-8700
OIL FILTER
Replaces: 5GH-13440-50-00, 5GH-13440-20, 5JW-13400-00-00, 2MB-E3440-00-00, 1WD-E3440-00-00
Fits: F15(2006-12), F20(2006-12), F25(2009-12), F40(2008-12), F50(2005-12), F60(2005-12), F70(2010-12), T25(2009-12), T50(2005-12), T60(2005-12)



18-8870
OIL FILTER
Replaces: Suzuki 16510-45H10
Fits: F9.9 Type T/TH(Sn 110001 & Newer), F15(Sn 110001 & Newer)

* Anti-Drain-Back Valve

Valve eliminates dry starts, prevents oil from draining back into crankcase during engine shutdown.

OIL & LUBRICANT DISPLAY RACK

Generate incremental sales by selling high-margin oil and lubricant products from Sierra. Create exciting displays and rotate products frequently, using this quality fixture that helps sell the products for you.

This gleaming, black metal display with heavy-duty casters and high impact graphics works to make a powerful impression. Comes complete with 4 high-tech metal shelves, heavy-duty casters and custom graphics.

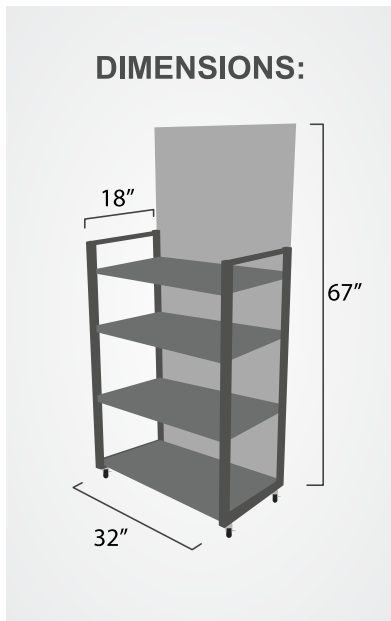

PART NO. 18-9490-1
(RACK ONLY • DOES NOT INCLUDE PRODUCT)



OIL

TC-W3



Sierra TC-W3 is a high performance lubricant that has been manufactured and designed to meet and exceed all (Domestic & Import) engine manufacturers warranties. Exceeds JASO, ISO, API and NMMA, for advanced generation 2-cycle lubricants.

- Ideal for oil injection systems or pre-mix applications.
- Significantly reduced aquatic toxicity to fish compared to other outboard oils on the market today.
- Reduces ring sticking, deposit formation and exhaust port blockage. Less friction allowing for easier starting.
- Formulated to improve performance and extend engine life by reducing wear on critical engine components.
- Ideal for today's high horsepower outboards that demand maximum performance.
- Excellent performance with lower quality fuels.
- Exceeds the industry standards established in 1997.
- Guaranteed and backed by our famous Sierra comprehensive warranty. (Will not void your engine manufacturer's warranty)



OUTBOARD 4-CYCLE OIL DISPLAY

18-9495
Display Only



2-STROKE OIL MIXING BOTTLE

Re-usable bottle for precise measuring of oil to fuel ratio for your engine.

18-9798
32 FL. OZ bottle

PREMIUM BLEND TC-W3	
Part No.	Description
18-9500-1	Pint (12 per case) (473ml)
18-9500-1P	84 case pallet (Pt.) 12 per case
18-9500-2	Quart (12 per case) (946ml)
18-9500-2P	84 case pallet (Qt.)
18-9500-3	Gallon (6 per case) (3.78L)
18-9500-3P	36 case pallet (Ga.)
18-9500-4	2.5 Gallon (2 per case) (9.46L)
18-9500-4P	42 case pallet (2.5 Ga.)
18-9500-6	16 Gallons (60.57L)
18-9500-7	55 Gallons (208L)
18-9500-7P	4 - 55 Gallon drum pallet

TC-W3 DISPLAY	
Part No.	Description
18-9499	Corrugated display with graphics. One case of quart bottles (18-9500-2), one case of gallon bottles (18-9500-3).
18-9494	Display Only

DIRECT INJECTION, TC-W3			
Part No.	Description	OE	OE No.
18-9530-3	Gallon (3.78L)	Mercury Optimax Yamaha HPDI BRP Ficht, DI E-TEC XD-50	92-858037K01 LUB-2STRK-M1-4 764354
18-9530-3P	36 Case Pallet (Gal)		
18-9530-4	2.5 Gallon (2 per case) (9.46L)	Mercury Optimax Yamaha HPDI BRP Ficht, DI E-TEC XD-50	
18-9530-4P	36 Case Pallet (2.5 Gal)	Mercury Optimax Yamaha HPDI BRP Ficht, DI E-TEC XD-50	
18-9530-6	16 Gallon (61L)		
18-9530-7	55 Gallon Drum	Mercury Optimax Yamaha HPDI BRP Ficht, DI E-TEC XD-50	92-858039K01 LUB-2STRK-M1-55 777228
18-9530-7P	4 - 55 Gal. Drum Pallet		

FULL SYNTHETIC TC-W3 2-STROKE OUTBOARD			
Part No.	Description	OE	OE No.
18-9540-2	Quart (964ml)	BRP E-Tec/Universal E-TEC XD-100	—
18-9540-3	Gallon (3.78L)	BRP E-Tec/Universal E-TEC XD-100	764357
18-9540-3P	36 Case Pallet (Gal)		
18-9540-7	55 Gal. Drum	BRP E-Tec/Universal E-TEC XD-100	777120

20W-40 FC-W 4-STROKE MINERAL OUTBOARD ENGINE OIL

20W-40 FC-W 4-STROKE MINERAL OUTBOARD OIL

- Formulated to protect your engine in the most demanding marine conditions.
- Developed to replace the 10W-30 in warmer climates.
- Meets or exceeds OE specifications for Outboard Oil.
- Advanced additive package to prevent rust and corrosion, breakdown under high RPM and maximum load conditions.



20W40 FC-W 4-STROKE MINERAL OUTBOARD ENGINE OIL			
Part No.	Yamaha No.	Description	Case Qty.
18-9450-2	LUB-20W40-FC-12	Quart (946ml)	12

See OE Cross Reference Chart on Page 192

25W-50 FC-W SEMI-SYNTHETIC MARINE ENGINE OIL

25W-50 FC-W MARINE ENGINE OIL

- For use in supercharged Mercury Verado.
- Offered in liter, 4 liter and 16 gallon containers.
- Semi-Synthetic formulation for superior protection under high loads and operating stress.
- NMMA FC-W® Certified/API-SL.

25W-50 FC-W SEMI-SYNTHETIC OIL			
Part No.	Mercury No.	Description	Case Qty.
18-9552-3	92-858084K01	4 Liter (4.2224 qt.)	6
18-9552-8	—	1 Liter (1.0556 qt.)	12
18-9552-6	—	16 Gallon (61L)	



10W-40 FC-W SEMI-SYNTHETIC MARINE ENGINE OIL

10W-40 FC-W SEMI-SYNTHETIC ENGINE OIL

- Direct Suzuki replacement oil.
- Semi-Synthetic formulation for superior protection under high loads and operating stress.
- Offered in quart, gallon, 16 gallon and 55 gallon drums.
- NMMA FC-W® Certified/API-SL.

10W-40 FC-W SEMI-SYNTHETIC OIL			
Part No.	Suzuki No.	Description	Case Qty.
18-9551-2	990C0-10W40-1QT	Quart (946ml)	12
18-9551-3	990C0-10W40-1GL	Gallon (3.785L)	6
18-9551-6		16 Gallon (61L)	
18-9551-7		55 Gallon (208L)	



15W-40 DIESEL ENGINE OIL

15W-40 DIESEL ENGINE OIL

- Meets the following manufactures specifications: Volvo VDS-3; Cummins CES20078, CES20077, CES20076; Detroit Diesel DDC93D214; CAT ECF-2, ECF-1; Global DHD-1.
- Increased detergency to fight soot and carbon deposits.
- Certified to API CI-4+ Rating. Meets the highest standards of diesel oil in the marine industry.

15W-40 DIESEL ENGINE OIL				
Part No.	Mercury No.	Volvo No.	Description	Case Qty.
18-9553-2	—	40005011	Quart (946ml)	12
18-9553-3		40005012	Gallon (3.785L)	6
18-9553-5	—	40005013	5 Gallon (18.95L)	
18-9553-6	—	—	16 Gallon (61L)	
18-9553-7	—	40005014	55 Gallon (208L)	



10W-30 FC-W 4-STROKE MARINE OUTBOARD ENGINE OIL

10W-30 4-STROKE MARINE OUTBOARD ENGINE OIL is a highly refined petroleum product formulated with premium base stock and highly refined additives. Specifically formulated to meet or exceed the tough requirements of the Marine 4-Stroke motor manufacturers, Mercury, Yamaha, Johnson-Evinrude, Suzuki and Honda.

- Excellent anti-wear characteristics
- Reduces friction
- Formulated to offer maximum corrosion protection
- Reduces sludge keeps engine cleaner for better efficiency
- Low temperature viscosity offers better cold starting
- Meets and exceeds quality performance API SJ, CF-2, CH-4, NMMA FC-W® Certified



10W30 FC-W MARINE OUTBOARD ENGINE OIL

Part No.	Mercury No.	Description	Case Qty.
18-9420-2	92-802833Q1	Quart (946ml)	12
18-9420-2P	92-802833Q1	84 Case Pallet (Qt.)	12
18-9420-3	92-802835Q1	Gallon (3.785L)	6
18-9420-3P	92-802835Q1	36 Case Pallet (Gal.)	6
18-9420-30	92-802835Q1	30 Gallon (113.6L)	
18-9420-30P	92-802835Q1	30 Gallon (Pallet)	5 / Pallet
18-9420-7	92-802836A1	55 Gallon (208L)	
18-9420-7P	92-802836A1	55 Gallon (Pallet)	4 / Pallet

25W-40 FC-W 4-STROKE MARINE STERN DRIVE ENGINE OIL

25W-40 4-STROKE MARINE STERN DRIVE ENGINE OIL has been formulated to provide excellent lubrication and corrosion protection. Stern drive and inboard engines operate under high load and running stresses. This product is developed for the marine environment and will out perform standard 4-cycle automotive engine oils. Sierra's 25W-40 oil offers excellent detergency, anti-oxidants, antiwear, and corrosion protection. The benefits to your engine are reduced wear to the internal components, protection of internal parts from corrosion, cleaner pistons, and prevention of ring sticking. Excellent low temperature operating properties. Meets or exceeds quality performance API SJ, CF-4, CH-4. **Recommended for use in Mercruiser and OMC.**

- NMMA FC-W® Certified



25W40 FC-W 4-STROKE STERN DRIVE ENGINE OIL

Part No.	Mercruiser No.	Description	Case Qty.
18-9400-2	92-802837Q1	Quart (946ml)	12
18-9400-2P	92-802837Q1	84 Case Pallet (Qt.)	12
18-9400-30		30 Gallon (113.6L)	
18-9400-30P		30 Gallon (Pallet)	5 / Pallet
18-9400-4	92-857389A1	5 Quart (4.7 L)	4
18-9400-4P	92-857389A1	36 Case Pallet (5 Qt.)	4
18-9400-7	92-802841A1	55 Gallon (208L)	
18-9400-7P	92-802841A1	55 Gallon (Pallet)	4 / Pallet

25W40 FC-W SYNTHETIC BLEND ENGINE OIL

This 4-cycle oil is blended with premium grade synthetic and mineral based stock combined with superior designed additives formulated for the stress endured by sterndrive and inboard engines.

- Superior corrosion protection
- Advanced lubrication for reduction of wear to internal engine components.
- Outstanding friction reduction and wear protection.
- Removes thermal breakdown under high RPM's, extreme temperatures and loads.
- Extensively tested for outstanding performance.
- NMMA FC-W® Certified/API-SL.



25W40 FC-W SYNTHETIC BLEND MERCUISER STERNDRIVE ENGINE OIL

Part No.	Mercruiser No.	Description	Case Qty.
18-9440-2	92-883724K01	Quart (946ml)	12
18-9440-2P	92-883724K01	84 Case Pallet (Qt.)	12
18-9440-4	92-883725K01	5 Quart (4.7 L)	4
18-9440-4P	92-883725K01	36 Case Pallet (5 Qt.)	4
18-9440-7	92-858057K01	55 Gallon (208L)	
18-9440-7P	92-858057K01	55 Gallon (Pallet)	4 / Pallet

25W40 FC-W SYNTHETIC BLEND 4-STROKE OUTBOARD OIL

This oil is blended with premium grade synthetic and mineral based stock combined with superior designed additives formulated for the extreme rigors of the marine environment.

- Superior corrosion protection.
- Advanced lubrication for reduction of wear to internal engine components.
- Minimized piston ring deposits.
- Extensively tested for outstanding performance.
- NMMA FC-W® Certified/API-SL.



SYNTHETIC BLEND 4-STROKE OUTBOARD OIL 25W40

Part No.	Mercury No.	Description	Case Qty.
18-9440-3	92-883723K01	4 Liter (4.2224 qt.)	6
18-9440-8	92-883722K01	1 Liter (1.0556 qt.)	12

SAE 30 FULL SYNTHETIC MARINE ENGINE OIL

A special blend of synthetic base oil and a balanced additive system that exceeds the FC-W requirements for marine engine oil.

- Recommended for gasoline and diesel inboard and sterndrive engines.
- Superior engine protection during startups, operation and storage.
- Reduces friction and wear for extended engine life.
- Longer lubrication effectiveness than mineral oils.
- Reduces oil consumption and improves fuel economy.
- API-CF/SL.



FULL SYNTHETIC ENGINE OIL SAE 30

Part No.	Volvo No.	Description	Case Qty.
18-9410-2	3842343	1 Quart (946ml)	12
18-9410-4	3842344*	5 Quarts (4.7L)	4
18-9410-7	3858061	55 Gallon (208L)	

* Convenient 5 qt Container

SYNTHETIC OIL 10W30 FC-W

Formulated specifically for 4-stroke outboard and sterndrive engine technology. A special blend of synthetic base oil and a balanced additive system that exceeds the FC-W requirements for marine engine oils. Recommended for use in both outboard and sterndrive applications. Offers faster lubrication at start up in low temperatures, excellent protection at high temperatures, and greater resistance to oxidation for lower oil consumption.

- NMMA FC-W® Certified/API-SL.



10W30 SYNTHETIC MARINE ENGINE LUBRICANT

Part No.	Volvo No.	Description	Case Qty.
18-9690-2	—	1 Quart (946ml)	12
18-9690-3	—	1 Gallon	6

NMMA FC-W Certified for use in 4 stroke OB and stern drive applications

15W-40 HEAVY DUTY ENGINE OIL

This oil is specifically formulated for the heavy duty inboard marine market, including cruisers and towboats calling for a 15W-40.

- Meets API Service classification up to CK-4.
- Meets the performance specifications for API service classification SM.
- Premium base stocks and additive package ingredients places Sierra Heavy Duty at the leading edge of lubrication technology.
- Suitable for fuels on any sulfur level
- Not for use in gasoline engines equipped with catalytic converters.
- Replaces: Shell Rotella T4, Delo 400, MerCruiser, Indmar, Pleasurecraft, Crusader, Volvo Penta, MasterCraft



15W40 MULTI-VEHICLE ENGINE OIL			
Part No.	Indmar No.	Description	Case Qty.
18-9554-2	872005	Quart (946ml)	12
18-9554-4	872006 (7QT)	5 Quart (4.7L)	4
18-9554-5	-	5 Gallon (18.95L)	
18-9554-7	-	55 Gallon (208L)	

5W-30 SEMI-SYNTHETIC ENGINE OIL

Our 5W-30 Semi-Synthetic is an ultra-high performance engine oil that utilizes premium base stocks and industry leading additives.

- Meets and or exceeds FC-W Catalyst and FC-W specifications
- Proprietary additive package
 - Enhanced detergent package to suspend and prevent sludge.
 - Reduces friction to maintain high performance
 - Prevents thermal and oxidation break down under extreme temperatures
 - High shear stability maintains viscosity to prevent excessive thinning in high performance applications
 - Advanced ZDDP additive technology prevents phosphorus depletion extending catalyst life while maintaining anti-wear protections.
- Meets or exceeds API SM category requirements
- Replaces: Honda, Indmar, Ilmor, PCM



5W-30 SEMI-SYNTHETIC FC-WCAT			
Part No.	Indmar No.	Description	Case Qty.
18-9555-2	872003	Quart (946ml)	12
18-9555-4	872004 (7QT)	5 Quart (4.7L)	4
18-9555-7	-	55 Gallon (208L)	

5W-30 FULL SYNTHETIC ENGINE OIL

A full synthetic 5W-30 is an ultra-high engine performance oil that utilizes premium base stocks and industry leading additives.

- Meets and or exceeds FC-W Catalyst and FC-W specifications
- Proprietary additive package
 - Enhanced detergent package to suspend and prevent sludge.
 - Reduces friction to maintain high performance
 - Prevents thermal and oxidation break down under extreme temperatures
 - High shear stability maintains viscosity to prevent excessive thinning in high performance applications
 - Advanced ZDDP additive technology prevents phosphorus depletion extending catalyst life while maintaining anti-wear protections.
- Meets or exceeds API SM category requirements
- Replaces: Yamalube, MerCruiser, Indmar, Mobile 1, Ilmor, Indmar, PCM, MasterCraft



5W-30 FULL SYNTHETIC FC-WCAT			
Part No.	Ilmor/MasterCraft	Description	Case Qty.
18-9558-2	550022689	Quart (946ml)	12
18-9558-4	550046126	5 Quart (4.7L)	4
18-9558-7	-	55 Gallon (208L)	

25W-40 CATALYST ENGINE OIL

These oils have been specifically designed to meet the unique requirements of modern 4-stroke recreational engines with or without emission catalyst systems.

- Approved for all 4-Stroke applications including Outboard, Sterndrive and Inboard. Exceeds all 4-Stroke requirements including FC-W and FC-W Cat Compatible.
- Formulated to offer maximum corrosion protection.
- Advanced lubrication for extended engine life and wear protection.
- Capitalizing “ZDDP” anti-wear additive technology to prevent phosphorus depletion and extend the emission catalyst life.
- NMMA FC-W® Certified.



25W40 CATALYST OIL

Part No.	Mercury No.	Description	Case Qty.
18-9400CAT-2	92-8M0078627	1 Quart (946ml)	12
18-9400CAT-2P	92-8M0078627	84 Case Pallet (Qt.)	12
18-9400CAT-4	—	5 Quart (4.7 L)	4
18-9400CAT-4P	—	36 Case Pallet (5 Qt.)	4
18-9400CAT-7	92-8M0078621	55 Gallon (208L)	
18-9400CAT-7P	92-8M0078621	55 Gallon (Pallet)	4 / Pallet

10W-30 CATALYST ENGINE OIL

Our NMMA FC-W Catalyst Compatible Engine Oils have been specifically designed to meet the unique requirements of modern 4-stroke recreational engines with or without emission catalyst systems.

- Approved for all 4-Stroke applications including Outboard, Sterndrive and Inboard and exceeds all 4-Stroke requirements including FC-W and FC-W Cat Compatible.
- Provides superior corrosion protection under extreme conditions.
- Industry leading wear protection and deposit control.
- Capitalizing on “ZDDP” anti-wear additive technology to prevent phosphorus depletion and extend the emission catalyst life.
- NMMA FC-W® Certified



10W30 CATALYST OIL

Part No.	Mercury No.	Description	Case Qty.
18-9420CAT-2	92-8M0078625	Quart (946ml)	12
18-9420CAT-2P	92-8M0078625	84 Case Pallet (Qt.)	12
18-9420CAT-3	92-8M0078626	Gallon	6
18-9420CAT-3P	92-8M0078626	36 Case Pallet (Gal.)	6
18-9420CAT-7	92-8M0078618	55 Gallon (208L)	
18-9420CAT-7P	92-8M0078618	55 Gallon (Pallet)	4 / Pallet

25W-40 SYNTHETIC CATALYST ENGINE OIL

A special blend specifically designed to meet the unique requirements of modern 4-stroke recreational engines with or without emission catalyst systems.

- Minimizes corrosion that is formed inside the engine.
- Displays enhanced detergent and dispersants properties to suspend and prevent engine sludge formation.
- Industry leading wear protection and deposit control.
- Prevents excessive thinning under extreme performance operations.
- Capitalizing on “ZDDP” anti-wear additive technology to prevent phosphorus depletion and extend the emission catalyst life.
- NMMA FC-W® Certified/API-SL.



25W40 SYNTHETIC CATALYST OIL

Part No.	Mercury No.	Description	Case Qty.
18-9440CAT-2	92-8M0078629	Quart (946ml)	12
18-9440CAT-2P	92-8M0078629	84 Case Pallet (Qt.)	12
18-9440CAT-4	—	5 Quart (4.7 L)	4
18-9440CAT-4P	—	36 Case Pallet (5 Qt.)	4
18-9440CAT-7	92-8M0078624	55 Gallon (208L)	
18-9440CAT-7P	92-8M0078624	55 Gallon (Pallet)	4 / Pallet

SIERRA OIL CROSS-REFERENCE CHARTS

PREMIUM BLEND TC-W3

Part No.	Description
18-9500-1	Pint (12 per case) (473ml)
18-9500-1P	84 case pallet (Pt.) 12 per case
18-9500-2	Quart (12 per case) (946ml)
18-9500-2P	84 case pallet (Qt.)
18-9500-3	Gallon (6 per case) (3.78L)
18-9500-3P	36 case pallet (Ga.)
18-9500-4	2.5 Gallon (2 per case) (9.46L)
18-9500-4P	42 case pallet (2.5 Ga.)
18-9500-6	16 Gallons (60.57L)
18-9500-7	55 Gallons (208L)
18-9500-7P	4 - 55 Gallon drum pallet

DIRECT INJECTION, TC-W3

Part No.	Description	OE	OE No.
18-9530-3	Gallon (3.78L)	Mercury Optimax Yamaha HPDI BRP Ficht, DI E-TEC XD-50	92-858037K01 LUB-2STRK-M1-4 764354
18-9530-3P	36 Case Pallet (Gal)		
18-9530-4	2.5 Gallon (2 per case) (9.46L)	Mercury Optimax Yamaha HPDI BRP Ficht, DI E-TEC XD-50	
18-9530-6	16 Gallon (61L)		
18-9530-7	55 Gallon Drum	Mercury Optimax Yamaha HPDI BRP Ficht, DI E-TEC XD-50	92-858039K01 LUB-2STRK-M1-55 777228
18-9530-7P	4 - 55 Gallon Drum Pallet		

FULL SYNTHETIC TC-W3 2-STROKE OUTBOARD

Part No.	Description	OE	OE No.
18-9540-2	Quart (964ml)	BRP E-Tec/Universal E-TEC XD-100	—
18-9540-3	Gallon (3.78L)	BRP E-Tec/Universal E-TEC XD-100	764357
18-9540-3P	36 Case Pallet (Gal)		
18-9540-7	55 Gal. Drum	BRP E-Tec/Universal E-TEC XD-100	777120

20W40 FC-W 4-STROKE MINERAL OUTBOARD OIL

Part No.	Yamaha No.	Description	Case Qty.
18-9450-2	LUB-20W40-FC-12	Quart (946ml)	12

25W-50 FC-W SEMI-SYNTHETIC OIL

Part No.	Mercury No.	Description	Case Qty.
18-9552-3	92-858084K01	4 Liter (4.2224 qt.)	6
18-9552-8	—	1 Liter (1.0556 qt.)	12
18-9552-6	—	16 Gallon (61L)	

10W-40 FC-W SEMI-SYNTHETIC OIL

Part No.	Suzuki No.	Description	Case Qty.
18-9551-2	990C0-10W40-1QT	Quart (946ml)	12
18-9551-3	990C0-10W40-1GL	Gallon (3.785L)	6
18-9551-6		16 Gallon (61L)	
18-9551-7		55 Gallon (208L)	

15W-40 DIESEL ENGINE OIL

Part No.	Mercury No.	Volvo No.	Description	Case Qty.
18-9553-2	—	40005011	Quart (946ml)	12
18-9553-3	—	40005012	Gallon (3.785L)	6
18-9553-5	—	40005013	5 Gallon (18.95L)	
18-9553-6	—	—	16 Gallon (61L)	
18-9553-7	—	40005014	55 Gallon (208L)	

10W30 SYNTHETIC MARINE ENGINE LUBRICANT

Part No.	Volvo No.	Description	Case Qty.
18-9690-2	—	1 Quart (946ml)	12
18-9690-3	—	1 Gallon	6

NMMA FC-W Certified for use in 4 stroke OB and stern drive applications

10W30 FC-W 4-STROKE OUTBOARD ENGINE OIL

Part No.	Mercury No.	Description	Case Qty.
18-9420-2	92-802833Q1	Quart (946ml)	12
18-9420-2P	92-802833Q1	84 Case Pallet (Qt.)	12
18-9420-3	92-802835Q1	Gallon (3.785L)	6
18-9420-3P	92-802835Q1	36 Case Pallet (Gal.)	6
18-9420-7	92-802836A1	55 Gallon (208L)	
18-9420-7P	92-802836A1	55 Gallon (Pallet)	4 / Pallet

25W40 FC-W 4-STROKE STERN DRIVE ENGINE OIL

Part No.	Mercuriser No.	Description	Case Qty.
18-9400-2	92-802837Q1	Quart (946ml)	12
18-9400-2P	92-802837Q1	84 Case Pallet (Qt.)	12
18-9400-30		30 Gallon (113.6L)	
18-9400-30P		30 Gallon (Pallet)	5 / Pallet
18-9400-4	92-857389A1	5 Quart (4.7 L)	4
18-9400-4P	92-857389A1	36 Case Pallet (5 Qt.)	4
18-9400-7	92-802841A1	55 Gallon (208L)	
18-9400-7P	92-802841A1	55 Gallon (Pallet)	4 / Pallet

25W40 FC-W SYNTHETIC BLEND MERCURISER STERNDRIVE OIL

Part No.	Mercuriser No.	Description	Case Qty.
18-9440-2	92-883724K01	Quart (946ml)	12
18-9440-2P	92-883724K01	84 Case Pallet (Qt.)	12
18-9440-4	92-883725K01	5 Quart (4.7 L)	4
18-9440-4P	92-883725K01	36 Case Pallet (5 Qt.)	4
18-9440-7	92-858057K01	55 Gallon (208L)	
18-9440-7P	92-858057K01	55 Gallon (Pallet)	4 / Pallet

FULL SYNTHETIC ENGINE OIL SAE 30

Part No.	Volvo No.	Description	Case Qty.
18-9410-2	3842343	1 Quart (946ml)	12
18-9410-4	3842344*	5 Quarts (4.7L)	4
18-9410-7	3858061	55 Gallon (208L)	

* Convenient 5 qt Container

25W40 FC-W SYNTHETIC BLEND 4-STROKE OUTBOARD OIL

Part No.	Mercury No.	Description	Case Qty.
18-9440-3	92-883723K01	4 Liter (4.2224 qt.)	6
18-9440-8	92-883722K01	1 Liter (1.0556 qt.)	12

25W40 CATALYST OIL

Part No.	Mercury No.	Description	Case Qty.
18-9400CAT-2	92-8M0078627	1 Quart (946ml)	12
18-9400CAT-2P	92-8M0078627	84 Case Pallet (Qt.)	12
18-9400CAT-4	—	5 Quart (4.7 L)	4
18-9400CAT-4P	—	36 Case Pallet (5 Qt.)	4
18-9400CAT-7	92-8M0078621	55 Gallon (208L)	
18-9400CAT-7P	92-8M0078621	55 Gallon (Pallet)	4 / Pallet

10W30 CATALYST OIL

Part No.	Mercury No.	Description	Case Qty.
18-9420CAT-2	92-8M0078625	Quart (946ml)	12
18-9420CAT-2P	92-8M0078625	84 Case Pallet (Qt.)	12
18-9420CAT-3	92-8M0078626	Gallon	6
18-9420CAT-3P	92-8M0078626	36 Case Pallet (Gal.)	6
18-9420CAT-7	92-8M0078618	55 Gallon (208L)	
18-9420CAT-7P	92-8M0078618	55 Gallon (Pallet)	4 / Pallet

25W40 SYNTHETIC CATALYST OIL

Part No.	Mercury No.	Description	Case Qty.
18-9440CAT-2	92-8M0078629	Quart (946ml)	12
18-9440CAT-2P	92-8M0078629	84 Case Pallet (Qt.)	12
18-9440CAT-4	—	5 Quart (4.7 L)	4
18-9440CAT-4P	—	36 Case Pallet (5 Qt.)	4
18-9440CAT-7	92-8M0078624	55 Gallon (208L)	
18-9440CAT-7P	92-8M0078624	55 Gallon (Pallet)	4 / Pallet

10W-40 FULL SYNTHETIC ATV/UTV ENGINE OIL

- Off Road Formulation- Suitable for ATV, UTV, & Dirt Bike Applications
- Meets API SM & JASO MA Specifications
- Designed for use in wet clutch applications
- Designed for use in liquid & air cooled engines
- Formulated with premium performance additives to prevent rusting prevalent in recreation due to their seasonal use
- Provides exceptional wear protection and deposit control for engine longevity

10W40 FULL SYNTHETIC ATV/UTV ENGINE OIL			
Part No.	OE CROSS	Description	Case Qty.
72-5100-2	Arctic Cat 0436-880 Honda HP4 Yamaha Yamalube Performance All Purpose 10w40	1 Quart (946ml)	12
72-5100-3	Arctic Cat 0436-879	1 Gallon (3.785L)	6
72-5100-7	—	55 Gallon drum (208L)	



0W-40 FULL SYNTHETIC ATV/UTV ENGINE OIL

- Off Road Formulation- Suitable for ATV, UTV, & Dirt Bike Applications
- To be used in extreme cold environments
- Meets API SM & JASO MA Specifications
- Designed for use in wet clutch applications
- Designed for use in liquid & air cooled engines
- Formulated with premium performance additives to prevent rusting prevalent in recreation vehicles due to their seasonal use
- Exceptional wear protection and deposit control for engine longevity

0W40 FULL SYNTHETIC ATV/UTV ENGINE OIL			
Part No.	OE CROSS	Description	Case Qty.
72-5101-2	Arctic Cat 1436-434 Can-Am XPS 779139	1 Quart (946ml)	12
72-5101-3	Arctic Cat 1436-435 Can-Am #779140	1 Gallon (3.785L)	6
72-5101-7	—	55 Gallon drum (208L)	



2-STROKE FULL SYNTHETIC ENGINE OIL MULTI-PURPOSE

- 2-Stroke Full Synthetic Oil with Ester Technology
- Designed for use in direct inject & pre-mix applications
- Multi-Use for many markets: ATV, UTV, PWC, Snowmobile, & Small Engines
- Meets JASO FD, ISO-L-EGD, & API TC 2-stroke performance standards

2-STROKE FULL SYNTHETIC MULTI-PURPOSE ENGINE OIL			
Part No.	OE CROSS	Description	Case Qty.
72-5103-2	Arctic Cat 4639-349 Honda HP2 Yamaha Yamalube All Performance Two Stroke Ski-Doo XPS 779126 Polaris VES Kawasaki K61021-208A	1 Quart (946ml)	12
72-5103-3	Arctic Cat 5639-469 Honda HP2 Yamaha Yamalube All Performance Two Stroke Ski-Doo 779127 Polaris VES	1 Gallon (3.785L)	6
72-5103-4	Honda HP2 Yamaha Yamalube All Performance Two Stroke Polaris VES	5 Gallon (18.95L)	
72-5103-5	Honda HP2, Polaris VES	16 Gallon (61L)	
72-5103-7	Honda HP2, Polaris VES	55 Gallon drum (208L)	



80W-90 SEMI-SYNTHETIC HYPOID GEAR OIL

- To be used in front/rear differentials
- Suitable for use in applications calling for an API GL-5 gear oil
- Formulated with premium performance additives that provide extreme pressure protection, anti-weld, anti-scuff and anti-wear properties

80W90 SEMI-SYNTHETIC HYPOID GEAR OIL			
Part No.	OE CROSS	Description	Case Qty.
72-5102-2	Arctic Cat 1436-159 Honda 08208-0080 Polaris Angle Drive Fluid	1 Quart (946ml)	12
72-5102-4	Arctic Cat 0436-901 Polaris Angle Drive Fluid	5 Gallon (18.95L)	
72-5102-5	Polaris Angle Drive Fluid	16 Gallon (61L)	
72-5102-7	Polaris Angle Drive Fluid	55 Gallon drum (208L)	



5W-50 FULL SYNTHETIC ENGINE OIL

- 5W-50 Full Synthetic Engine Oil
- Off Road Formulation- Suitable for ATV, UTV, & Dirt Bike Applications
- To be used in extreme cold environments
- Meets API SM & JASO MA Specifications
- Designed for use in wet clutch applications
- Designed for use in liquid & air cooled engines
- Formulated with premium performance additives to prevent rusting prevalent in recreation vehicles due to their seasonal use
- Exceptional wear protection and deposit control for engine longevity

5W50 FULL SYNTHETIC ENGINE OIL			
Part No.	OE CROSS	Description	Case Qty.
72-5104-2	Polaris PS-4	1 Quart (946ml)	12
72-5104-3	Polaris PS-4	1 Gallon (3.785L)	6
72-5104-7	Polaris PS-4	55 Gallon drum (208L)	



FOAM FILTER OIL

- Foam Filter Oil
- Dyed red for easy detecting during application
- Increases surface area of foam filter to trap small particles extending engine life
- Waterproof formula

FOAM FILTER OIL			
Part No.	OE CROSS	Description	Case Qty.
72-5105-2	—	1 Quart (946ml)	12
72-5105-3	—	1 gallon (3.785L)	6
72-5105-7	—	55 gallon drum (208L)	



POWERSPORTS OIL FULL PRODUCT LISTING

P/N	Description	P/N	Description
72-5100-2	10W-40 Full Synthetic High Performance Engine Oil - QT	72-5103-3	2 Stroke Full Synthetic High Performance Engine Oil - GAL
72-5100-3	10W-40 Full Synthetic High Performance Engine Oil - GAL	72-5103-4	2 Stroke Full Synthetic High Performance Engine Oil - 5 GAL
72-5100-7	10W-40 Full Synthetic High Performance Engine Oil 55 - GAL	72-5103-5	2 Stroke Full Synthetic High Performance Engine Oil - 16 GAL
72-5101-2	0W-40 Full Synthetic High Performance Engine Oil - QT	72-5103-7	2 Stroke Full Synthetic High Performance Engine Oil - 55 GAL
72-5101-3	0W-40 Full Synthetic High Performance Engine Oil - GAL	72-5104-2	5W-50 Full Synthetic High Performance Engine Oil - QT
72-5101-7	0W-40 Full Synthetic High Performance Engine Oil - 55 GAL	72-5104-3	5W-50 Full Synthetic High Performance Engine Oil - GAL
72-5102-2	80W-90 Semi Synthetic High Performance Hypoid Gear Oil - QT	72-5104-7	5W-50 Full Synthetic High Performance Engine Oil - 55 GAL
72-5102-4	80W-90 Semi Synthetic High Performance Hypoid Gear Oil - 5 GAL	72-5105-2	Foam Filter Oil - QT
72-5102-5	80W-90 Semi Synthetic High Performance Hypoid Gear Oil - 16 GAL	72-5105-3	Foam Filter Oil - GAL
72-5102-7	80W-90 Semi Synthetic High Performance Hypoid Gear Oil - 55 GAL	72-5105-7	Foam Filter Oil - 55 GAL
72-5103-2	2 Stroke Full Synthetic High Performance Engine Oil - QT		

EXTENDED LIFE COOLANT / ANTIFREEZE

Our Premium Blend Extended Life formula provides year-round protection against freezing and boil-over in all water-cooled engines. Protects for 2,500 hours or 5 years. Hybrid, nitrated HOAT/NOAT formula with ethylene glycol base is compatible with all other coolants.

The 50/50 is pre-mixed with deionized water; not intended to be diluted. This formula provides excellent metal protection and cavitation protection capabilities. Product color is clear red/orange.

EXTENDED LIFE COOLANT / ANTIFREEZE		
Part No.	Mercury No.	Description
18-9320	—	1 Gallon (3.78L), Full Strength
18-9305	92-877770K1	55 Gallon (208L), 50/50 Pre-mixed



HEAVY DUTY EXTENDED LIFE COOLANT / ANTIFREEZE

The Heavy Duty Extended Life formula provides year-round protection against freezing and boil-over in all diesel engines. Protects for 15,000 hours or 7 years. Poly organic POAT formula with ethylene glycol base is compatible with all other coolants.

The 50/50 is pre-mixed with deionized water; not intended to be diluted. Provides excellent metal protection and cavitation protection capabilities. Product color is yellow.

HEAVY DUTY EXTENDED LIFE COOLANT / ANTIFREEZE		
Part No.	Mercury No.	Description
18-9350	—	1 Gallon (3.78L), Full Strength



SYNTHETIC BLEND COOLANT / ANTIFREEZE

This extended life formula utilizes synthetic, propylene glycol for non-toxic protection against freezing and boil-over in all water-cooled engines. Protects gas engines for 4,000 hours or 2 years, diesel engines for 12,500 hours or 7 years. Compatible with all other coolants.

High-tech poly organic POAT formula combines with unique additive package to allow engines to maintain optimum engine operating temperature in order to produce full horsepower; seals pinhole leaks and fissures. Excellent metal protection and cavitation protection capabilities. Product is clear blue in color.

SYNTHETIC BLEND COOLANT / ANTIFREEZE		
Part No.	Mercury No.	Description
18-9360	—	1 Gallon (3.78L), 50/50 Pre-mixed



GEAR LUBE



SYNTHETIC GEAR LUBE

Specifically formulated to optimize gear life by reducing friction and providing superior wear protection in severe operating conditions. The unique synthetic formulation is shear stable and resists oxidation to ensure high performance over a wide range of ambient operating temperatures.

- API GL-5/MIL-L-210E • Weight: 75W-90 • Color: Gold

Part No.	Volvo No.	Description	Case Qty.
18-9680-2	1141679	1 Quart (946ml)	12
18-9680-5	1141681	5 Gallon	
18-9680-7	1141682	55 Gallon	

SIERRA HI-PERFORMANCE “SYNTHETIC BLEND” LOWER UNIT GEAR LUBE



- Synthetic blended marine formulation reduces operating friction for increased performance and protection of gears, bearings and other gear case components.
- Recommended for use in high performance and high load operating conditions in both outboard and I/O lower units.
- Sierra Hi-Performance gear lube has been designed to surpass the performance of the O.E. Hi-Performance gear lubricants . . . for the finest product available demand Sierra Hi-Performance gear lube.
- Recommended for engines 75 HP and above.
- GL-5 Rated
- Color: Blue-Green
- Weight: 80W-90

Replaces: Mercury (Quicksilver) Hi-Performance Blend
 OMC (System Matched) Ultra-HPF Blend
 Yamaha (Yamalube) LUB-GEARL-11-00

Part No.	Description
18-9650-0	10 Oz. Tube (12 per case) (283.5g)
18-9650-2	Quart (12 per case) (946ml) • Replaces: Mercury 92-858064Q01
18-9650-2P	84 case pallet (Qt.)
18-9650-5	5 Gallons (18.95L) • Replaces: Mercury 92-858008Q01
18-9650-5P	36 - 5 Gallon container pallet
18-9650-6	16 Gallon (61L) • Replaces: Mercury 92-858067Q01
18-9650-6P	9 - 16 Gallon container pallet
18-9650-7	55 Gallons (208L) • Replaces: Mercury 92-858068Q01
18-9650-7P	4-55 Gallon drum pallet



SIERRA PREMIUM LOWER UNIT GEAR LUBE

- Recommended for all general marine applications requiring a GL-5 class lubricant.
- Ideal for replacing all old hypoid 90 application needs.
- Formulated for use in freshwater or saltwater conditions and all standard marine applications.
- Reduces friction and protects gears, bearings and other gearcase components.
- Recommended for engines under 75 HP.
- Color: Amber • Weight: 80W-90

Replaces: Mercury (Quicksilver) Premium Blend
 OMC (System Matched) Hi-Vis Lubricant
 Yamaha (Yamalube) LUB-GEARL-11-04

Part No.	Description
18-9600-0	10 Oz. Tube (12 per case) (283.5g) • Replaces: Mercury 92-802844Q02
18-9600-9	Kit Contains: (1) 18-9786 & (2) 18-9600-0
18-9600-2	Quart (12 per case) (946ml) • Replaces: Mercury 92-858058Q01
18-9600-2P	84 case pallet (Qt.)
18-9600-5	5 Gallons (18.95L) • Replaces: Mercury 92-858007Q01
18-9600-5P	36 - 5 Gallon container pallet
18-9600-6	16 Gallon (61L) • Replaces: Mercury 92-858061Q01
18-9600-7	55 Gallons (208L) • Replaces: Mercury 92-858062Q01
18-9600-7P	4 - 55 Gallon drum pallet



18-9600-9 GEAR LUBE KIT

Contains:

Part No.	Description	Qty.
18-9786	Lower Unit Fill Tube	1
18-9600-0	10 oz. Tube Lower Unit Gear Lube	2

- Color: Amber • Weight: 80W-90



SIERRA TYPE “C” GEAR LUBE

- Formulated for older model outboards and I/O's equipped with electric shift.
- Reduces friction and protects gears, bearings and other gearcase components.
- Weight: 75W

Replaces: OMC (System Matched) Premium Blend

Part No.	Description
18-9620-0	10 Oz. Tube (12 per case) (283.5g)
18-9620-2	Quart (12 per case) (946ml)
18-9620-5	5 Gallons (18.95L)

ENGINE CARE PRODUCTS

SIERRA PRO PERFORMANCE GREASE

- Specifically formulated for marine applications
- Premium lithium formulation for optimum corrosion protection in freshwater and saltwater applications
- Ideal for marine trailer wheel bearing, universal joints, outdrive pivot joints, gimbal bearings and shaft splines
- Operating Temp: -40°F - 350°F

Part No.	Mercury No.	Description
18-9200-0	92-8M0071838	8 Oz. Tube (226.8g) (Case of 12)
18-9200-1	92-8M0071841	15 Oz. Cartridge (425.2g) (Case of 10)
18-9200-2*	92-8M0071837	3 Oz. (85.05g) Cartridge (Pkg. of 2)
18-9200-4*	92-8M0071837	3 Oz. (85.05g) Cartridge (Pkg. of 4)

*Display Packaged



SIERRA HYDRO DEFENSE MARINE GREASE

18-9240-0
(8 oz Tube)

Replaces:
Mercury 92-802859A1

18-9240-1
(14oz Cartridge)

Replaces:
Mercury 92-802863A1

- Prohibits rust and corrosion.
- Prevents wear against the most extreme friction in marine applications.
- Will not break down in marine conditions.
- Contains PTFE for minimum wear and added friction protection.
- For use on prop shafts, trailer bearings, throttle and shift cables and linkage, swivel pins and more!



OIL DRAIN KITS



For easy installation this kit includes:

- 42" hose with hose hanger
- Universal oil pan replacement plug
- End cap

Note: Does not fit late model oil pan utilizing metric threads M12- 1.75

- Makes changing your oil a snap and without the mess!
- Permanently mounts to bottom of oil pan to make changing oil more convenient.
- Drains 4 quarts of oil in less than 15 minutes without a pump.
- Fittings on hose machined from corrosion resistant brass.
- Assembly sized to pass through most common hull drains.



18-7894 OIL DRAIN ADAPTER

Machined from corrosion resistant brass.

For: Mercruiser 224 CID (3.7L) Engines
1/4" - 18 NPT Threads
Remove adapter from 18-7891 & replace

Part No.	Description	Application
18-7891	For: GM, Chrysler & Most Ford	Oil Pans 1/2" — 20 Threads



18-2446 FILL/DRAIN KIT – OUTBOARD

• 3/8" - 16 thread
Fits: Johnson/Evinrude & Mercury Gearcase



18-2447 FILL/DRAIN KIT – STERN DRIVE

• 3/8" - 16 thread
Fits: Stern Drive Gearcase, Mercruiser, OMC & Volvo Penta SX & DP



18-2448 LOWER UNIT FILL/DRAIN KIT

• M8 - 1.25 thread
Fits: Yamaha, Nissan/Tohatsu, & Honda Lower Units

OIL CHANGE KITS



18-9390 OIL CHANGE KIT

Replaces:
Yamaha LUB-MRNSM-KT-10
Fits: F30(2001-06), F40(1999-08), F40A(2009 & Up), F50(1995 & Up), T50(1996 & Up), F60(2002 & Up), T60(2003 & Up), F70(2010 & Up)



18-9391 OIL CHANGE KIT

Replaces:
Yamaha LUB-MRNMD-KT-10
Fits: F75(2003 & Up), F80(1999-02), F90(2003 & Up), F100(1999-02), F115(2000 & Up)

18-8600
E-GO! FUEL INJECTION CLEANING KIT

For: Mercury, Honda, Yamaha

- Cleans away layers of fuel deposits when the engine is running.
- Helps maintain injector's cleanliness and performance throughout the life of your engine.
- For best results, use E-GO! Blast Fuel Injector Cleaner (18-8606).

Contains:

- Cleaning System Container **18-8601**
- Hose **18-8602**
- Small Fitting **18-8603**
- Large Fitting **18-8604**
- Carrying Case **18-8605**



New

18-8608
E-GO FLEXIBLE NOZZLE SUPPORT
Support for Throttle Body Adaptor



New



18-8609
E-GO! THROTTLE BODY ADAPTER
Fits: All engines with Throttle body fuel supply

New



18-8610
E-GO! ADAPTER
Fits: All Yamaha EF1

18-8606
E-GO! BLAST FUEL INJECTOR CLEANER

Replaces: Mercury 92-8M0062765
For: Mercury, Yamaha, Honda

- Cleans all fuel injector types
- Prevents rough idling and stalling
- Reduces intake and port deposits
- Maximizes fuel economy

Use with 18-8600 Fuel Injector Cleaning Kit

* Labeled for US/Canada sales ONLY



18-8607
E-GO! BOOST FUEL SYSTEM BOOSTER

For: Mercury, Yamaha, Honda

- Cleans entire fuel system
- Cleans all fuel injector types
- Prevents rough idling and stalling
- Stabilizes fuel during storage
- Maximizes fuel economy
- Easy! Just pour and go

* Labeled for US domestic sales ONLY



SANITATION SYSTEM CLEANER

18-9093 (1 Gal.) (Ready-To-Use)

18-9095 (1 Gal.) (Concentrate)

- Removes uric scale, calcium carbonate and other solids
- Safe for all sanitation system components
- USDA certified bio based product - Non-toxic, Biodegradable, Non-hazardous



18-9730-1
LITHIUM SPRAY GREASE (WHITE)
12 Oz. (340g)

- Multi-purpose spray lubricant for Marine applications
- Ideal for lubricating shift components and miscellaneous applications where a light grease lubricant is required
- Water and heat resistant
- Prevents corrosion



LQ-5 FILTERED LUBRICANT

18-9182 8.5 FL. OZ
18-9183 16 FL. OZ



2-STROKE OIL MIXING BOTTLE

18-9798
32 FL. OZ bottle
Re-usable bottle for precise measuring of oil to fuel ratio for your engine.



18-9884
BOWL WRENCH

Replaces: Racor RK22628
Fits: Sierra, Racor and other aftermarket filter bowls



18-52207
TUBE KIT
Replacement tubes for oil extractors
18-52204 and **18-52104.**



18-9780
FLEX FILL SPOUT
Pouring device for quart bottles

18-52205
FLUID DISPENSER
 For easily dispensing fluids for any application.

- Large 1.2 gallon capacity
- Sealed internal pump components
- Flow control valve equipped
- Quick connect fittings
- 20PSI Max Pressure
- Includes pressure gauge
- Integrated pressure relief valve



18-52206
FLUID DISPENSER/EXTRACTOR
 For removing/dispensing fluid in difficult to reach areas.

- No-drip cap
- 7 oz. capacity
- 7 1/2" flexible tube



18-52204
OIL EXTRACTOR
 For Quick, Easy & Clean Oil Changes

- Large 8.8 Liter (2.3 Gallon) capacity not only can extract fluids, but is capable of dispensing too! Simply move the bi-directional valve and this unit will create a vacuum or move the other direction and it creates pressure to dispense the fluid.
- Built-in shut-off valve to prevent overfilling
- Comes complete with 5 feet of flexible hose and two rigid dipstick tubes.



18-52104
OIL EXTRACTOR
 For Quick, Easy & Clean Oil Changes

- This 8.8 Liter (2.3 Gallon) capacity air operated extractor can be used to remove a wide range of fluids, such as engine oil, brake fluid, antifreeze and more
- Built-in shut-off valve to prevent overfilling
- This unit can be used away from the air source by creating a vacuum, closing off both shut-off valves, then take to where it's needed
- Comes complete with 5 feet of flexible hose, two rigid dipstick tubes, and a brake bleeding kit



OIL FILTER WRENCHES



18-9778
 Size: 2-7/16" thru 3"
 Fits small outboard filters

18-9789
 Size: 2-9/16" thru 3-1/4"

18-9790
 Size: 3-5/16" thru 3-3/4"



OIL ABSORBENT PADS
 Highly Absorbent & Disposable

18-81100 (Pkg. of 3)
18-81101 (150 pad Shop Pack)



OIL ABSORBENT PADS
 Oil Zap II Absorbent & Disposable
18-81103 (150 pad Shop Pack)

New



18-9779
GEAR LUBE PUMP
 Universal Gear Lube Pump for use with standard or wide mouth bottles.
 Includes adapters for all major outboard engine manufacturers.
 Premium construction with aluminum fittings for long life.



18-9781
OIL PUMP
 Replaces: Mercury 91-850730Q01, 91-8M0072133

- Ideal for "do-it-yourself" owners
- Quart size application is perfect for most marine drives
- Includes tube fitting for domestic lower units with flexible fill line



LOWER UNIT FILL TUBE
18-9786 (Standard) **18-9787** (Import)

- Flush & fill tool for small gearcases requiring the 10 ounce tube package
- Ideal for "do-it-yourself" in home maintenance
- Includes appropriate lower unit fitting for specific applications



18-9898
HOSE PINCH-OFF PLIERS
 Use to pinch off rubber hoses up to 1 1/2" OD



18-9794
GEAR LUBE ADAPTER
 Replaces: Mercury 91-883704Q03

For: Nissan, Yamaha, Honda, Tohatsu
 For use with Sierra quart pumps or lower unit fill tubes.
Metric 8-1.25 thread



18-9795
GEAR LUBE ADAPTER
 For: Suzuki lower unit
 For use with Sierra quart pumps or lower unit fill tubes.
Metric 10-1.25 thread



18-81006
GREASE FILLER ADAPTER
 Fits: OMC and Volvo Dual Prop



18-9788
LUBE PUMP
5 Gallon (18.95L)
 For filling lower units on outboards and stern drives.
 Tapered/unthreaded hose end.
 Designed for use with our 18-9600-5, 18-9620-5 and 18-9650-5



GREASE GUNS
18-9782 (14 Oz.) **18-9783*** (3 Oz.)
 Replaces: Mercury 91-74057Q6
 Heavy duty all steel construction for dependable, long service life.
 * Display Packaged



18-9784
BARREL PUMP
For: 16 thru 55 gallon drum

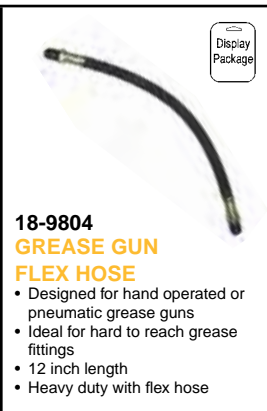

18-9804
GREASE GUN
FLEX HOSE
• Designed for hand operated or pneumatic grease guns
• Ideal for hard to reach grease fittings
• 12 inch length
• Heavy duty with flex hose



18-9785
EASY LUBER
Replaces:
Mercury 91-30500
• Ideal for quick and easy lube jobs using squeeze tubes
• Compact size, perfect for under seat and tackle box storage
• Use with all 10 oz. grease tubes



18-0116
GASKET MATERIAL
Synthaseal non-asbestos:
Excellent oil resistance: Designed to seal rough surfaces: Will withstand 350° F.



37643
THREADLOCKER
Medium Strength



18-9066
LOCTITE® THREADLOCKER
Medium Strength
Color: Blue Gel



18-9067
LOCTITE® THREADLOCKER
Medium Strength
Color: Red Gel



37701
THREADLOCKER
High Strength

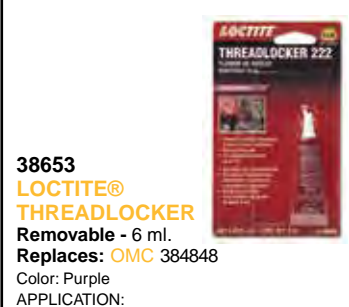

38653
LOCTITE® THREADLOCKER
Removable - 6 ml.
Replaces: OMC 384848
Color: Purple
APPLICATION:
For 1/4" or smaller fasteners. Armature screws, float chamber screws, leaf valve screws, jet screws. A medium strength threadlocker that seals against leakage and can be disassembled with ordinary tools.

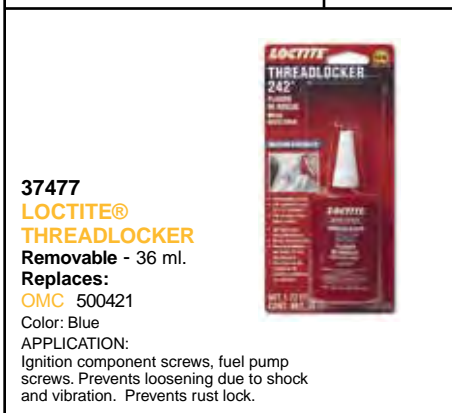

37477
LOCTITE® THREADLOCKER
Removable - 36 ml.
Replaces:
OMC 500421
Color: Blue
APPLICATION:
Ignition component screws, fuel pump screws. Prevents loosening due to shock and vibration. Prevents rust lock.

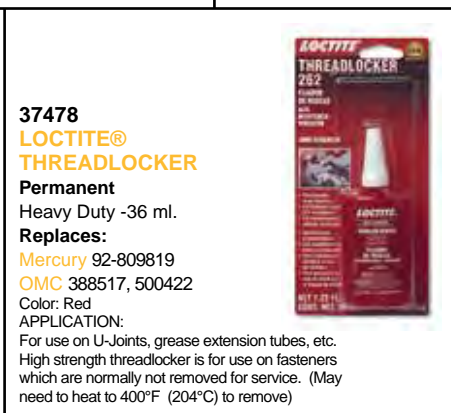

37478
LOCTITE® THREADLOCKER
Permanent
Heavy Duty -36 ml.
Replaces:
Mercury 92-809819
OMC 388517, 500422
Color: Red
APPLICATION:
For use on U-Joints, grease extension tubes, etc. High strength threadlocker is for use on fasteners which are normally not removed for service. (May need to heat to 400°F (204°C) to remove)



37479
LOCTITE® THREADLOCKER
Permanent
High Strength -36 ml.
Replaces: OMC 500423
Mercury 92-809820
Color: Red
APPLICATION:
High strength, permanent threadlocker for heavy duty applications. (MASTER PACK 10)



37509
LOCTITE® KLEAN 'N PRIME™
4.5 oz.
Replaces: Mercury 92-59327-1, 92-809824, FT8935
OMC 384884
Color: Green
APPLICATION:
Cleans parts, activates surfaces and speeds cure. For use with Threadlockers, Bearing Mount, High Strength Retaining Compound, Gasket Maker and Pipe Sealant with Teflon.



22355
ODC FREE CLEANER
12 oz.
Replaces: OMC 390905
Color: Clear
APPLICATION:
Clean parts before reassembly. Removes dirt, oil and solvent. Leaves no residue. Solvent is non-flammable and low-toxicity. Cold degreaser.



79040
LOCTITE® CHISEL™ GASKET REMOVER
18 oz.
Replaces: OMC Gasket Remover 390928
Color: Milky White/Clear
APPLICATION:
Remove old gaskets, paint and grime with Gasket Remover. Strips off hard carbon deposits. Eliminates harsh scraping that may damage a flange surface.



37467
LOCTITE® ULTRA BLACK SILICONE
80 ml. Tube
Color: Black
APPLICATION:
Seal, caulk and insulate electrical connections. Best general purpose sealant for sealing flanges, valve covers and flexible joints. Operating temperature to 400°F (204°C).



2096059
LOCTITE® GASKET MAKER
50 ml.
Color: Red
APPLICATION: Gel sealant can be used in place of cut gaskets to seal cylinder block to crankcase half on many current Outboard, Inboard and I/O models. Used to make, coat or repair gaskets in minutes.



1525607
LOCTITE® GASKET SEALANT
16 fluid oz.
Replaces: Mercury 92-802881A1, 92-342271 (Perfect Seal), 92-34227, 92-34227Q02
OMC 317201, 508235
(Gasket Sealing Compound)
A slow drying, non-hardening brush-top sealant. Gasoline, oil and grease resistant.

37566
LOCTITE®
ANTI-SEIZE™
 1 lb. can w/brush



Color: Gray
APPLICATION: Use on mechanical joints and external moving parts such as starter bushings, prop shaft splines and battery terminals. Dresses exhaust gaskets. Coats and protects metal parts. Lubricates threads, gears, chains, cables, pulleys, rollers and pivots to temperatures up to 1600°F. (871°C) Heavy-duty, temperature resistant compound fortified with graphite and metallic flake. Will not evaporate or harden.



56507
LOCTITE® PIPE SEALANT

Replaces: OMC 910048
 Color: White
APPLICATION: Seals steering line connectors. Helps prevent loss of hydraulic fluids, fuels, water, gas or air. Use on fittings, valves and plugs.
 PST 6ML with Teflon®

37534
LOCTITE®
DIELECTRIC
GREASE

9.76 ml
Replaces:
 Mercruiser 92-41669-1, 92-823506 1, 92-802882A1
 Color: Clear
APPLICATION: Protects ignition and electrical connectors, distributor caps, spark plug boots and boat trailer electrical connections against salt, dirt and corrosion.



18-9125
OETIKER CLAMP KIT
Replaces: Johnson Evinrude 787133, 787145



Part #	Qty	Johnson/Evinrude #	Oetiker #	Description	
18-9141	1	787145	14100082	Oetiker Jaw Pincers	
Nominal ID					
Part #	Qty	Johnson/Evinrude #	Oetiker #	Inches	mm
18-9126-9	10	346930	16700004	3/8"	9.5
18-9127-9	10	348838	16700006	13/32"	10.5
18-9128-9	10	349516	16700007	7/16"	11.3
18-9129-9	10	347107	16700010	1/2"	13.3
18-9130-9	10	347108	16700011	17/32"	13.8
18-9131-9	10	346931	16700012	35/64"	14
18-9132-9	10	346785	16700013	9/16"	14.5
18-9133-9	10	346786	16700016	5/8"	15.7
18-9134-9	10	348839	16700017	11/16"	17
18-9135-9	10	346151	16700024	13/16"	21
18-9136-9	10	346152	16700031	1"	25.6
18-9137-9	10	346153	16700037	1 3/16"	30.1
18-9138-9	10	349759	16700040	1 1/4"	31.6
18-9139-9	10	349729	16700053	1 5/8"	41
18-9140-9	10	346150	16700020	23/32"	18.5

All clamps are standard package of 10. Each package of 10 is available individually.

18-9145
OETIKER CLAMP KIT
Replaces: Yamaha YB-6AW04-A, Mercruiser 91-803146A2



Part #	Qty.	Yamaha #	Oetiker #	Description	
18-9141	1	YB-6AW04-4	14100082	Oetiker Jaw Pincers	
Nominal ID					
Part #	Qty.	Yamaha #	Oetiker #	Inches	mm
18-9133-9	50	YB-6AW04-1	16700016	5/8"	15.7
18-9146-9	50	YB-6AW04-3	16702498	25/32"	19.8

All clamps are standard package of 10. Each Package of 10 is available individually.



18-2455
DRAIN PLUG GASKET ASSORTMENT

Fits: Multiple Manufacturers & Most Drives
 Contains 50 each of 18-4698, 18-60103, 18-4248, 18-8331, 18-2945 & 18-2430

18-8997
DUAL FEED FLUSH -
ROUND CUPS
 Universal
 Fits most engines up to 115 H.P.



18-8998-1
ENGINE
FLUSHER -
RECTANGULAR
CUPS
 Universal
 Fits most engines 120 H.P. and UP



18-8999
DUAL FEED
FLUSH -
RECTANGULAR
CUPS
 Universal
 Fits most engines 120 H.P. and UP



18-9009
INBOARD FLUSHER
 Universal
 Fits most inboard engines



18-9010
MOTOR FLUSHER
 (Heavy Duty)

- High quality EPDM rubber cups
- Corrosion resistant dicromate finish
- Installs in seconds
- Use with a standard garden hose
- Hose connector complete with rubber washer
- No tools required

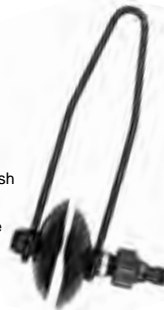

18-9895
DUAL WATER PICKUP SEAL
Replaces:
 Mercury/Evinrude 881150K1
Fits: Mercury and E-Tec Engine with Nose Cone Dual Water Pickup.





18-79987
TRANSOM PLATE (SMALL)

Size: 2" x 15"
 Universal fit plate designed to add transom support.



18-79988
TRANSOM PLATE (LARGE)

Size: 4" x 17"
 Oversized universal fit plate designed to add transom support.

NAUTALIFT™ GAS LIFT SUPPORTS AND ACCESSORIES

MARINE GRADE GAS FILLED SUPPORTS

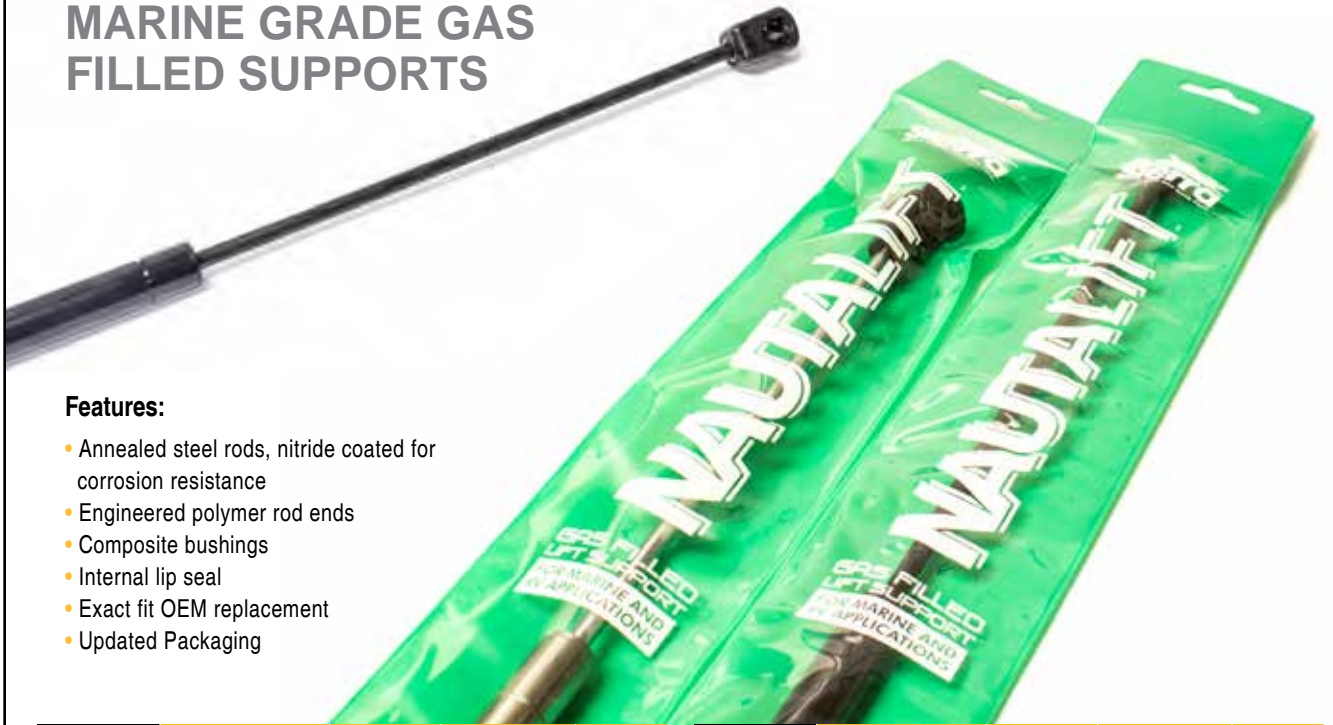

Features:

- Annealed steel rods, nitride coated for corrosion resistance
- Engineered polymer rod ends
- Composite bushings
- Internal lip seal
- Exact fit OEM replacement
- Updated Packaging

Part No.	OE No.	Extended Lgth (in.)	Compressed Lgth. (in.)	Rated (lbs.)	Part No.	OE No.	Extended Lgth (in.)	Compressed Lgth. (in.)	Rated (lbs.)
GS62600	GSNI-4900-20	7.5	5.5	20	GS62720	GSNI-5200-20	17	11	20
GS62610	GSNI-4900-40	7.5	5.5	40	GS62730	GSNI-5200-30	17	11	30
GS62620	GSNI-4900-80	7.5	5.5	80	GS62740	GSNI-5200-40	17	11	40
GS62630	GSNI-5000-20	10	7	20	GS62750	GSNI-5200-60	17	11	60
GS62640	GSNI-5000-40	10	7	40	GS62760	GSNI-5200-90	17	11	90
GS62650	GSNI-5000-60	10	7	60	GS62770	GSNI-5300-20	20	12	20
GS62660	GSNI-5100-20	12	8.5	20	GS62780	GSNI-5300-30	20	12	30
GS62670	GSNI-5100-30	12	8.5	30	GS62790	GSNI-5300-40	20	12	40
GS62680	GSNI-5150-20	15	9.5	20	GS62800	GSNI-5300-60	20	12	60
GS62690	GSNI-5150-30	15	9.5	30	GS62810	GSNI-2300-80	20	12	80
GS62700	GSNI-5150-40	15	9.5	40	GS62820	GSNI-2300-90	20	12	90
GS62710	GSNI-5150-60	15	9.5	60	GS62830	GSNI-2300-120	20	12	120



Industry standard 16mm composite end fittings — no rust, no rattles, no problems.

Composite bushing — long wearing, retains lubrication for smooth operation.

Electrostatic black paint finish on steel tube for corrosion protection and appearance.

Nitrided rod. Corrosion resistant. Micro fine finish holds oil to lubricate seals.

NAUTALIFT™ STAINLESS STEEL GAS LIFT SUPPORTS

MARINE GRADE GAS FILLED SUPPORTS



Features:

- Designed for demanding saltwater applications
- 316L Stainless Steel Rod and Cylinder
- Engineered polymer rod ends
- Composite bushings
- Internal lip seal
- Updated Packaging



Part No.	OE No.	Extended Lgth (in.)	Compressed Lgth. (in.)	Rated (lbs.)	Part No.	OE No.	Extended Lgth (in.)	Compressed Lgth. (in.)	Rated (lbs.)
GSS62600	GSSX-4900-20	7.5	5.5	20	GSS62740	GSSX-5200-40	17	11	40
GSS62610	GSSX-4900-40	7.5	5.5	40	GSS62750	GSSX-5200-50	17	11	50
GSS62630	GSSX-5000-20	10	7	20	GSS62760	GSSX-5200-90	17	11	90
GSS62640	GSSX-5000-40	10	7	40	GSS62770	GSSX-5300-20	20	12	20
GSS62670	GSSX-5100-30	12	8.5	30	GSS62780	GSSX-5300-30	20	12	30
GSS62680	GSSX-5150-20	15	9.5	20	GSS62790	GSSX-5300-40	20	12	40
GSS62700	GSSX-5150-40	15	9.5	40	GSS62800	GSSX-5300-60	20	12	60
GSS62710	GSSX-5150-60	15	9.5	60	GSS62820	GSSX-2300-90	20	12	90
GSS62720	GSSX-5200-20	17	11	20	GSS62830	GSSX-2300-120	20	12	120



GS62840
Black zinc plated steel flat bracket with 10mm ball stud. 2.25" wide



GS62850
Stainless steel flat bracket with 10mm ball stud. 2.25" wide



GS62860
Black zinc plated steel 90° angle bracket with 10mm ball stud. 2" wide • .65" base



GS62870
Stainless steel 90° angle bracket with 10mm ball stud. 2" wide • .65" base



GS62880
Black zinc plated steel 90° angle bracket with 10mm ball stud. 2" x 1.2" base



GS62900
Stainless steel 90° angle bracket with 10mm ball stud. 2" x 1.2" base



GS62910
Zinc plated steel 10mm ball stud with threaded shaft. 5/16" - 18



GS62920
Stainless steel 10mm ball stud with threaded shaft. 5/16" - 18



GS62890
Rod end with internal threads for either end of Nautalift gas filled lift supports. Unique construction makes installation easy and safe.



18-95560
ENGINE OIL PRIMER



18-79834
LIFTING EYE TOOL
For: Johnson/Evinrude V4 & V6



18-79817
UNIVERSAL ENGINE PULLER
Fits: 2 and 4 bbl manifolds



Part #	O.E. #	Description
18-9885	328360	Collar
18-9886	328361	Collar
18-9887	328363	Collar
18-9892	341440	Collar
18-9888	328364	Gauge Bar
18-9889	328365	Gauge Bar
18-9890	328366	Gauge Bar
18-9891	328367	Gauge Bar
18-9894	393279	Screw



18-79825
GIMBAL BEARING INSTALLER TOOL
For: Mercruiser, OMC and Volvo
Use with **18-4442** Alignment tool



18-79820-1
GIMBAL PULLER TOOL
For: Mercruiser, OMC and Volvo



18-79833-1
FLYWHEEL PULLER TOOL
For: Mercury



18-79823
STEPLESS CLAMP 90 DEGREE TOOL
Fits: Crimp type stepless clamps



18-9896
LIFTING EYE TOOL
Replaces: Mercury 91-904551, 91-90455T1, 91-90455T, 91-878232, 91-75132, 91-47448A1



18-9897
VERADO FLYWHEEL PULLER/LIFTING EYE
Replaces: Mercury 91-895343T02, 91-895343T01, 91-895343A02
Fits: All verado engines as a lifting eye and flywheel puller.



18-9879
INTERMEDIATE SHIFT CABLE SNAKE
Description: Use to easily remove and install intermediate shift cables in Mercury drives.



18-79815
FUEL FILTER TOOL
Replaces: Yamaha YB-ACC04
For: Yamaha F150-F350, 2.6L & 3.3LHPDI (2006 & Up)



18-79814
FUEL FILTER TOOL
Replaces: Mercury 91-896661



18-79813
BEARING CARRIER PULLER TOOL
For: Mercruiser, Mercury and Yamaha



18-9876
SHIM GAUGE BAR
Replaces: 349957
For: 40 HP, V-8 with thru hub exhaust



18-9806E
SHIFT CABLE TOOL
Replaces: Mercury Marine 91-12037
Description: Installs and removes shift cables on MC-I, R-MR, Alpha One, Alpha One/Gen II drive units. Use with **18-2190** and **18-2190E** cables.



18-9807
SHIFT CABLE ADJUSTMENT TOOL
Replaces: Mercury Marine 91-12427, 91-12427T
 Description: Attaches over the shift cable, used for proper Bravo drive unit shift cable adjustment at the shift plate.



18-9874
DRIVE SHAFT PRELOAD TOOL
Replaces: Mercury Marine 91-14311A2, 91-44307A1, 91-14311A04, 91-14311A1
 Description: Preloads drive shaft bearing when checking pinion height and backlash on MC-I, R-MR, Alpha One, Alpha One/Gen II drive units and outboards.



18-9808
NEEDLE BEARING DRIVER
Replaces: Mercury Marine 91-15755T, 91-15755, 91-37263, 91-31109
 Description: Installs needle bearings in MC-I, R-MR, Alpha One, and Alpha One/Gen II bearing carriers.



18-9803
SPANNER NUT WRENCH
Replaces: Mercury Marine 91-17256
 Description: Removes and installs driveshaft bearing retainer on MC-I, R-MR, Blackhawk, all Bravo and all Alpha drive units.



18-9809
BEARING CARRIER RETAINER TOOL
Replaces: Mercury Marine 91-17257
 Description: Loosens and tightens bearing carrier retainer on Bravo Two drives.



18-9810
SHIFT CABLE ANCHOR ADJUSTMENT TOOL
Replaces: Mercury Marine 91-17262A1
 Description: Used to install shift cable core wire on all Bravo drive units.



18-9812
BEARING & SEAL INSTALLATION TOOL
Replaces: Mercury Marine 91-17275A1
 Description: Installs shifter shaft bushings on all Bravo drive units.



18-9814
PLATE/PULLER BAR
Replaces: Mercury Marine 91-29310
 Description: Used as a guide to remove and install gimbal bearing on MC-I, R-MR, Alpha One, Blackhawk and all Bravo drives.



18-9817
SHIFT SHAFT BUSHING TOOL
Replaces: Mercury Marine 91-31107T, 91-31107, 91-24150, 91-23033T, 91-23033
 Description: Removes and installs the shift shaft bushing in the gear case of MC-I, R-MR and Alpha One drive units and outboards.



18-9821
DRIVER HEAD
Replaces: Mercury Marine 91-32325, 91-32325T
 Description: Installs gimbal bearing in MC-I, R-MR, Alpha One, Alpha One/Gen II, Blackhawk and all Bravo drive units.



18-9823
DRIVER HEAD
Replaces: Mercury Marine 91-33489
 Description: Installs the small roller bearing in the gimbal housing of MC-I, R-MR and Alpha One drive units.



18-9824
DRIVER HEAD
Replaces: Mercury Marine 91-33491
 Description: Installs needle bearing in forward gear and removes and installs seals and bearing in gimbal housing of MC-I, R-MR and Alpha One drive units.



18-9825
DRIVER HEAD
Replaces: Mercury Marine 91-33492T, 91-33492
 Description: Removes and installs lower swivel pin needle bearing in gimbal ring on MC-I, R-MR and Alpha One drive units.



18-9826
BEARING CUP DRIVER
Replaces: Mercury Marine 91-33493, 91-33493T
 Description: Installs upper drive shaft bearing cup in drive shaft housing of MC-I, R-MR and Alpha One drive units.

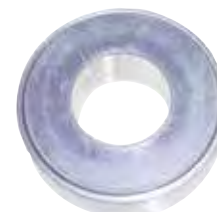

18-9827
BEARING CUP DRIVER
Replaces: Mercury Marine 91-34379T
 Description: Installs drive shaft bearing cup in gear housing of MC-I, R-MR, Alpha One drive units and outboards.

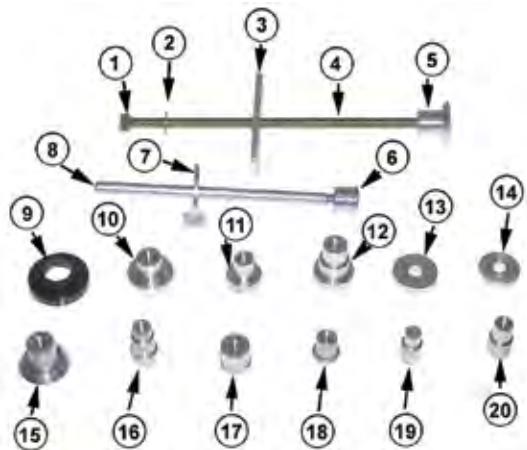
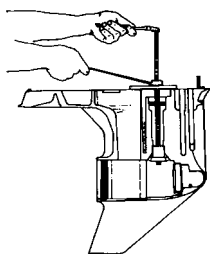

**18-9820
INSTALLATION TOOL KIT**

Replaces: Mercury Marine 91-31229A7
Description: removes and installs bearings in MC-I, R-MR, Alpha One, Alpha One Gen II and all Bravo gear cases.

— CONTAINS —

Part #	O.E. #	Description	Part #	O.E. #	Description	
1	NSS	11-24156	11	18-9837	91-38628T	Puller/Driver Head
2	18-9805	12-34961	12	18-9808	91-15755T	Needle Bearing Driver
3	18-9814	91-29310	13	18-9830	91-36571T	Pilot Washer
4	18-9819	91-31229	14	18-9836	91-37350	Washer
5	18-9821	91-32325T	15	18-9849	91-52394	Bearing Puller
6	18-9848	91-52393	16	18-9832	91-37292	Bearing Puller
7	18-9815	91-37324	17	18-9822	91-32336	Driver Head
8	18-9835	91-37323	18	18-9829	91-36569T	Driver Head
9	18-9816	91-30366T1	19	18-9833	91-37311	Driver Head
10	18-9828	91-36379	20	18-9834	91-37312	Driver Head

**18-9829
DRIVER HEAD**

Replaces: Mercury Marine 91-36569
Description: Removes pinion bearing from MC-I, R-MR and Alpha One drive units.



**18-9830
PILOT WASHER**

Replaces: Mercury Marine 91-36571
Description: Removes pinion bearing in MC-I, R-MR and Alpha One drive units.

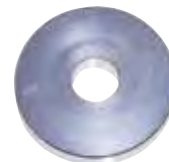

**18-9831
BEARING CUP DRIVER**

Replaces: Mercury Marine 91-36577, 91-36577T
Description: Installs forward gear bearing cup in gear housing of MC-I, R-MR and Alpha One drive units.

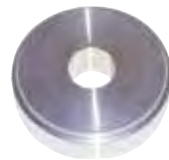

**18-9835
DRIVER ROD**

Replaces: Mercury Marine 91-37323
Description: Used with various drivers to install bearings on Alpha One, Gen II and Bravo One and Two gear cases.



**18-9837
PULLER/DRIVER HEAD**

Replaces: Mercury Marine 91-38628T
Description: Installs pinion bearing on MC-I, R-MR and Alpha One drive units.



**18-9838
U-JOINT ADAPTER**

Replaces: Mercury Marine 91-38756
Description: Supports yoke when disassembling u-joint on all drive units.



**18-9839
BEARING CUP DRIVER**

Replaces: Mercury Marine 91-38918T
Description: Installs bearing cup in top cover of drive shaft housing of MC-I, R-MR, Alpha One drive units and outboards.



**18-9840
PULLER**

Replaces: Mercury Marine 91-38919
Description: Removes swivel pins from R-MR and Alpha One gimbal rings.



**18-9841
DRIVE SHAFT SHIMMING TOOL**

Replaces: Mercury Marine 91-42840T
Description: Shims pinion gear on Bravo One drives.



**18-9842
DRIVE SHAFT
RETAINER WRENCH**

Replaces: Mercury Marine 91-43506T
Description: Removes and installs threaded bearing retainer on Alpha stern drives and outboards.



**18-9843
CLAMP PLATE**

Replaces: Mercury Marine 91-43559
Description: Holds preload while checking backlash and bearing preload on Bravo One and Two drive units.



**18-9844
TAPERED INSERT TOOL**

Replaces: Mercury Marine 91-43579
Description: Installs tapered insert retainer into water inlet hose on all Bravo drive units.



18-9845
SEAL DRIVER

Replaces: Mercury Marine 91-43591T
Description: Installs upper drive shaft oil seal on Alpha One and Alpha One/Gen II drive units.



18-9846
SEAL DRIVER

Replaces: Mercury Marine 91-44110
Description: Installs oil seals in water pump base on Alpha One and Alpha One/Gen II drive units and outboards.



18-9847
BELLOWS EXPANDER TOOL

Replaces: Mercury Marine 91-45497A1
Description: Installs exhaust bellows on MC-I, R-MR, Alpha One, Bravo One and Two and Blackhawk drive units.



18-9850
BACKLASH INDICATOR

Replaces: Mercury Marine 91-53459
Description: Checks gear backlash on TR, TRS, MC-I, R-MR, Alpha One, Alpha One/Gen II and Bravo One and Two drive units.



18-9851
OIL SEAL DRIVER

Replaces: Mercury Marine 91-55916
Description: Installs oil seals in TR and Bravo One and Two drive unit bearing carrier.



18-9852
BEARING DRIVER

Replaces: Mercury Marine 91-55918
Description: Installs needle bearings in Bravo One and Two and TR drive unit bearing carrier.



18-9853
PINION GEAR SHIMMING TOOL

Replaces: Mercury Marine 91-56048T, 91-56048001
Description: Measures pinion height of MC-I, R-MR, Alpha One and Alpha One/Gen II drive units.



18-9854
DRIVE SHAFT ADAPTER

Replaces: Mercury Marine 91-56775T
Description: Provides a wrench surface to turn the drive shaft on MC-I, R-MR, Alpha One, Alpha One/Gen II drive units and outboards.



18-9855
DRIVEN GEAR SHIMMING TOOL

Replaces: Mercury Marine 91-60523
Description: Measures upper drive gear clearance on MC-I, R-MR, Alpha One and Alpha One/Gen II drive units.



18-9856
DRIVE GEAR SHIMMING TOOL

Replaces: Mercury Marine 91-60526T
Description: Measures upper drive gear clearance on MC-I, R-MR, Alpha One, Alpha One/Gen II drive units.



18-9857
PINION NUT ADAPTER

Replaces: Mercury Marine 91-61067A3
Description: Holds pinion nut when removing pinion gear and drive shaft on MC-I, R-MR, Alpha One drive units and outboards.



18-9858
BEARING CARRIER RETAINER WRENCH

Replaces: Mercury Marine 91-61069T
Description: Removes and installs bearing carrier retainer nuts on Bravo One and Two, MC-I, R-MR, Alpha One, Alpha One/Gen II, TRS drive units and outboards.



18-9868
DRIVE SHAFT ADAPTER

Replaces: Mercury Marine 91-61077
Description: Provides a wrench surface to turn the propeller shaft on MC-I, R-MR, Alpha One, Alpha One/Gen II, Bravo One and TRS drive units.



18-9859
PULLER

Replaces: Mercury Marine 91-63616
Description: Removes upper swivel shaft on MC-I, R-MR, Alpha One, Alpha One/Gen II, Bravo One, Two and Three and Blackhawk gimbal rings.



18-9860
BEARING DRIVER

Replaces: Mercury Marine 91-63638T
Description: Removes and installs lower drive shaft pinion bearing on TR and Bravo One and Two drive units.



18-9861
HINGE PIN TOOL
Replaces: Mercury Marine 91-78310
 Description: Removes and installs hinge pins from all Mercury Marine drive units.



18-9869
UPPER DRIVE SHAFT HOUSING SEAL DRIVER
Replaces: Mercury Marine 91-817570T
 Description: Installs seals in Alpha One/Gen II upper drive shaft housing.



18-9870
SLEEVE INSTALLATION TOOL
Replaces: Mercury Marine 91-818162
 Description: Installs the aluminum sleeve in the u-joint bellows of all Bravo, Alpha One/Gen II, Blackhawk drive units and outboards.



18-9871
SLEEVE REMOVAL TOOL
Replaces: Mercury Marine 91-818169T
 Description: Removes the aluminum sleeve from the u-joint bellows of all Bravo, Alpha One/Gen II and Blackhawk drive units.



18-9872
PUMP ALIGNMENT TOOLS
Replaces: Mercury Marine 91-821571A1
 Description: Aligns Alpha One/Gen II water pump during installation.



18-9863
BEARING DRIVER
Replaces: Mercury Marine 91-89865
 Description: Installs bearing carrier seals on Bravo One and Two drive units.



18-9865
DRIVE SHAFT BEARING TOOL
Replaces: Mercury Marine 91-90774
 Description: Presses bearing cone onto Alpha One/Gen II drive shaft housing pinion gear.



18-9875
PULLER ASSEMBLY
Replaces: Mercury Marine 91-90244A1
 Description: Removes and installs drive shaft housing bearings and sleeves on all Bravo drive units.



18-9866
DIAL INDICATOR HOLDING TOOL
Replaces: Mercury Marine 91-89897
 Description: Secures dial indicator to gear housing when checking backlash on MC-I, R-MR, Alpha One, TR, TRS drive units and outboards.

New



18-8611
O2 SENSOR SOCKET
 • Universal
 • 7/8" (22mm) w/ 25/32" wire opening
 • 3/8" Drive

New



18-8612
O2 SENSOR SOCKET
 • Universal
 • 7/8" or 22mm w/ 9/32" wire opening
 • 3/8" Drive

New



18-8613
O2 SENSOR WRENCH
 • Universal
 • 7/8" or 22mm
 • 3/8" drive
 • 6 point

New



18-8614
O2 SENSOR WRENCH
 • Universal
 • 7/8" or 22mm
 • 1/2" drive, 2" overall depth

New



18-8615
O2 SENSOR WRENCH
 • Universal
 • Includes 6 and 12 point socket
 • 3/8" Drive

New



18-8616
O2 SENSOR WRENCH
 • Universal
 • Includes 6 and 12 point socket
 • 3/8" Drive, 2 1/8" offset

new



18-8617
O2 SENSOR WRENCH

- Universal
- 6 point
- 3/8" Drive, 1.2" overall depth



18-9800
COMPRESSION TESTER

Description: Perfect for hard to reach bottom spark plug holes on older Mercury models.



18-9902
DEEP WELL COMPRESSION TEST ADAPTER

For deep well spark plug holes to perform compression testing. Works with 18-9900 compression tester.

- 14mm and 18mm threads
- Reaches 8" beyond the installation surface



18-9801
MULTI METER/DVA TESTER

Replaces: Mercury Marine 91-99750A1
Description: Tests electrical and ignition systems. Consists of a VOA meter with built-in direct voltage adapter.

18-9900
DIGITAL COMPRESSION TESTER

For Testing Compression on Gasoline powered engines.

- Stores max compression value for up to 12 cylinders
- Backlit LCD Display
- Auto Shutoff
- Sealed and Vibration protected
- Displays values in PSI, Bar, and kPa
- Fits many Outboard, Inboard, PWC, ATV, Recreational gasoline engines



18-9903
ENGINE IGNITION ANALYZER

Description: For the diagnosis and performance measurement of all types of spark ignition systems, from conventional to the newest Coil on Plug in use.

- Displays everything on a 3.5" color screen.
- Rechargeable battery provides 6+ hours of use.
- Durable design (MIL-STD-810) drop test approved.
- Comes with hard shell carrying case.
- Includes 18-9914 Plug Wire Sensor Clip and Extension Lead.



18-9914
PLUG WIRE SENSOR CLIP EXTENSION

Description: Extension Lead with Plug wire sensor clip for 18-9903.

- 2 m (78") long shielded cable with BNC connector.
- Sensor accepts wires of up to 9 mm (3/8") diameter.
- Cable can also be used with coil on plug sensor supplied with the 18-9903.



EC09090
DIGITAL MINI MULTIMETER

Compact design and the functions you need for overall convenience

- 3 1/2 digit LCD display
- 16 test ranges, 6 functions
- Battery & protective holster included
- Fuse protected, removable safety leads and jacks



18-9904
FAULT FINDER

Description: For locating electrical short and open circuits.

- Includes 18-9906 & 18-9907.
- Operates on 6 to 42 VDC systems.
- 8 in. flexible probe reaches in congested places.
- Adjustable sensitivity.
- Transmitter and receiver LEDs signal open or short circuit conditions.
- Auto polarity transmitter that leads with 5 amp alligator clips.
- Includes hard shell carrying case.



18-9905
AC/DC LOW CURRENT CLAMP METER

Description: Designed to accurately measure current, current leaks (parasitic draws down to 1mA) and electrical loads from 1mA to 100 amp AC/DC and voltages from 0 to 600 AC/DC.

- Current measurement: 1 mA up to 100 A.
- Voltage measurement up to 600 V.
- Clamp opens up to 1/2" (12.5 mm).
- Operates with one rotary switch.
- Includes soft shell carrying case.



18-9908
AC/DC 600A CLAMP METER

Description: Allows the measurement of AC/DC currents with a resolution down to 0.1 A, and up to a maximum of 600A, making it ideal for testing all kinds of loads such as found in: electric motors, fuel pumps, charging systems, starter currents, alternators, etc.

- Current measurement: up to 600A.
- Voltage measurement: up to 600 V.
- Clamp opens up to 1" (25.4 mm).
- Operates with one rotary switch.
- Includes soft shell carrying case.



Front View

18-9906
CORDLESS CIRCUIT TESTER

Description: Specifically designed for use on autos, trucks, trailers, RV's & boats.

- No ground or clip necessary.
- Range of operation: 3 to 28 VDC.
- Powered by one AA alkaline battery.
- Wireless design eliminates tangles.



18-9907
FUSE SOCKET TEST CONNECTORS

Description: Covers the most common fuse socket adapters requirements in the automotive and vehicular electrical repair field.

- Fits all Maxi, ATO and Mini type fuses.
- Maximum conductivity and durability.
- Molded for easy insertion and removal.



18-9911
REFLECTIVE TAPE

Description: A package of specially formulated self adhesive reflective tape strips, for use as a target for optical tachometers. Its highly reflective surface is designed to scatter the light (infrared, laser or visible) emitted by the optical tachometer, improving the detection of the rotating or moving object from a wide range of angles and distances.

- 6 strips - 8" (L) x 0.2" (W) / 20 cm (L) x 0.5 cm (W)



18-9912
LASER TACHOMETER & COUNTER

Description: Used to measure and test the number of rotations per minute (RPM) or total number of rotations or events on any spinning shaft, pulley, wheel, drive belt, fan, or other rotating objects in general, safely, accurately and easily.

- Measures from 2.5 to 99999 RPM.
- 0.05% accuracy.
- 2 to 20" measuring range.
- Laser-powered optical system.
- Memory recall functions (minimum & maximum).
- Uses 18-9911 Reflective Tape.



18-9910
OXYGEN SENSOR TESTER/SIMULATOR

Description: For testing and diagnostics on any Oxygen Sensor, to quickly determine whether the sensor is defective and needs replacement.

- Signal output shown in real time on LED bar graph.
- Auto detection of common wire misconnections.
- Works with zirconium, titanium & air/fuel ratio sensors.
- Comes with hard shell carrying case.



18-9913
SMARTACH (DIESEL AND GASOLINE ENGINE TACHOMETER)

Description: A tachometer designed for use on any engine equipped with an alternator, and only requires a simple connection to the electrical system (e.g. battery, alternator, cigarette lighter connector) to measure engine RPM.

- Measures from 200 to 9,999 RPM
- 0.05% accuracy.
- Large 4 1/2 digit LCD display.
- Comes with hard shell carrying case.



18-9909
PROFESSIONAL DVOM

Description: Offers full auto range features and functionality. Equipped with a 4 digit LCD display with analog bar graph it is capable of measuring AC/DC voltage up to 600 Volt and AC/DC current up to 10 A. Other functions includes tachometer for RPM measurement, dwell, temperature, resistance, frequency, fuel injection test, diode test, continuity check and overload protection.

- State of the art design and styling.
- 4 digit LCD display with analog bar graph.
- AC/DC voltage measurement: up to 600 V.
- AC/DC current measurement: up to 10 A.
- Tachometer function measures 30 to 20000 RPM
- Comes with hard shell carrying case.

EC01350
TERMINALS & CONNECTORS W/CRIMP TOOL

30 pc. terminal assortment packed with crimp tool/wire cutter. Attractive 5 compartment clamshell fits neatly in tool box or glove compartment. Handy for emergencies. Perfect for the do-it-yourselfers.



EC09040
DUAL VOLTAGE CIRCUIT TESTER

Dual bulb tester for testing both 6 and 12 volt circuits. Also can be used to check spark plug wires. This is the most commonly used tester for troubleshooting auto, truck, van and boat wiring. Supplied with ground wire and clip. Packed one per card.



18-8960
IGNITION SPARK TESTER

Description: Use to check for ignition spark in up to 4 ignition wires at a time.



18-9802
TIMING LIGHT

Replaces: Mercury Marine 91-99379
 Description: Checks ignition timing. Powered by two "D" cell batteries, portable.



18-4442
ENGINE ALIGNMENT TOOL

Replaces: Mercury Marine 91-57797A3, 91-57797A2, 91-57797A1, 91-8M0067546, 91-48347, 91-37384
 Description: Used to verify engine alignment on all MC-I, R-MR, Alpha One and Alpha One/Gen II.



18-9849
BEARING PULLER

Replaces: Mercury Marine 91-52394
 Description: Removes and installs bearings in MC-I, R-MR, Alpha One, Alpha One/Gen II, all Bravo and outboard gear cases.



18-9862
BEARING DRIVER

Replaces: Mercury Marine 91-87119
 Description: Installs driveshaft bearing onto driveshaft.



18-9873
BEARING DRIVER

Replaces: Mercury Marine 91-813653
 Description: Installs u-joint oil seal into bearing carrier, also used to pilot the puller rod for gear housing needle bearing installation on Bravo One and Two drive units.



18-9815
PILOT PLATE

Replaces: Mercury Marine 91-37324
 Description: Removes and installs bearings in MC-I, R-MR, Alpha One, Alpha One/Gen II, all Bravo and outboard gear cases.



18-9816
MANDREL

Replaces: Mercury Marine 91-30366T1
 Description: Removes and installs bearings in MC-I, R-MR, Alpha One, Alpha One/Gen II, all Bravo and outboard gear cases.



18-9819
PULLER SHAFT

Replaces: Mercury Marine 91-31229
 Description: Removes and installs bearings in MC-I, R-MR, Alpha One, Alpha One/Gen II, all Bravo and outboard gear cases.

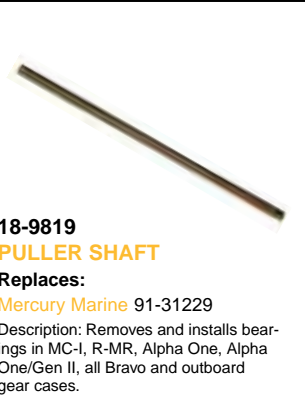

18-9822
DRIVER HEAD

Replaces: Mercury Marine 91-32336
 Description: Removes and installs bearings in MC-I, R-MR, Alpha One, Alpha One/Gen II, all Bravo and outboard gear cases.



18-9828
DRIVER HEAD

Replaces: Mercury Marine 91-36379
 Description: Removes and installs bearings in MC-I, R-MR, Alpha One, Alpha One/Gen II, all Bravo and outboard gear cases.

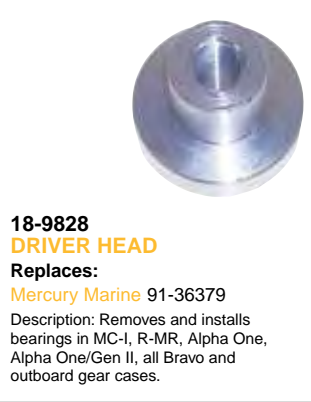

18-9832
BEARING PULLER

Replaces: Mercury Marine 91-37292
 Description: Removes and installs bearings in MC-I, R-MR, Alpha One, Alpha One/Gen II, all Bravo and outboard gear cases.



18-9833
DRIVER HEAD

Replaces: Mercury Marine 91-37311
 Description: Removes and installs bearings in MC-I, R-MR, Alpha One, Alpha One/Gen II, all Bravo and outboard gear cases.



18-9834
DRIVER HEAD

Replaces: Mercury Marine 91-37312
 Description: Removes and installs bearings in MC-I, R-MR, Alpha One, Alpha One/Gen II, all Bravo and outboard gear cases.



18-9848
DRIVER

Replaces: Mercury Marine 91-52393
 Description: Removes and installs bearings in MC-I, R-MR, Alpha One, Alpha One/Gen II, all Bravo and outboard gear cases.



STARTER ROPE
 (200' Spools)

Part #	Desc.	Replaces:
18-4911	5/32" X 200'	OMC 322236
18-4913	3/16" X 200'	OMC 316705
18-4914	1/8" X 200'	OMC 316706



18-4904
STARTER HANDLE & ROPE

#4.5 (9/64") Rope
 Handle Only: 18-4901



CABLE BOOT

18-4454 For 3" Hole
 18-4455 For 4 1/2" Hole



Safe-Skeg

Whether you are looking to protect your new skeg, repair your damaged one, or even just add some shine. Safe-Skeg is made of 316 Marine Grade Stainless Steel Construction and installation takes minutes.

- Material Thickness: 1.5mm, 50% thicker than the competition.
- Drain Hole to protect against corrosion and freeze-up.
- Brilliantly polished with seamless design.
- Skid Plate not necessary due to extra thickness in material.



Motor	Horsepower	Stroke	Year Range	Part No.
Evinrude/Johnson	150-175-185-200-225	2	1986-2003	35-SS630
Evinrude/Johnson	90-100-115-120-140	2	1980-2001	35-SS635
Evinrude/Johnson	75 & 90 (E-TEC) 150-200 DCX & DPX (E-TEC) 225-250 DPL Blue (E-TEC)	2	2002-2008 2004 & Up 2004 & Up	35-SS670
Evinrude/Johnson	60, 70, 90, 115, 140 (by Suzuki) Suzuki 90, 115, 140	4	1999-2003; 2003 & Up	35-SS680
Force Outboard	70 - 90 HP (by Mercury)	2	1998-2002	35-SS625
Force Outboard	70-75	2	1991-1997	35-SS650
Honda	135,150,200,225	4	2004 & Up	35-SS685
Mer cruiser	Pre Alpha #1 Drives		1973-1984	35-SS600
Mer cruiser	Alpha 1 Drives		1985-1990	35-SS605
Mer cruiser	Alpha 1 Generation II Drives		1991-Present	35-SS610
Mer cruiser	Bravo 1 & 3 Drives		1990-Present	35-SS615
Mercury/Mariner	225	2	1996-2004	35-SS660
Mercury/Mariner	135-150-175-200	2 & 4	1978-2005	35-SS620
Mercury	150	4	2012 & Up	35-SS715
Suzuki Outboard	150-175-200-225	2	1986-2002	35-SS645
Volvo	DP Drives 1996-2007; SX Drives 2007 & Up			35-SS655
Volvo Penta	SX Drives (Single Prop)		1995-2006	35-SS665
Yamaha	115-130 2 Stroke 115-130 4 Stroke	2 4	2003 & Up 2000 & Up	35-SS690
Yamaha Outboard	200-225-250-300	2 & 4	2003-Present	35-SS695
Yamaha Outboard	60-70-80-90-100	2 & 4	2002-Present	35-SS700
Replacement Hardware Kit				35-SSKIT1

SELOC MANUALS

OUTBOARDS

* Available on SelocOnline



18-01101*
CHRYSLER/FORCE
ALL ENGINES
1962-1999
3-150 HP, 1 - 5 cyl.,
including L-Drive.



18-01200*
HONDA
ALL ENGINES
1978-2001
2-130 HP, 1 - 4 cyl.,
including Jet Drives.



18-01202*
HONDA
2002-2014
2-225 HP, 1 - 4 cyl.
& V6, including Jet
Drives.



18-01301*
JOHNSON/EVINRUDE
1958-1972
1.5-125 HP, 1 - 4 cyl.



18-01302*
JOHNSON/EVINRUDE
1973-1989
1.25-60 HP, 1 - 2 cyl.



18-01308*
JOHNSON/EVINRUDE
1973-1991
60-235 HP, 3 - 6 cyl.

SELOC MANUALS

OUTBOARDS (CONT.)

* Available on SelocOnline



18-01311*
JOHNSON/EVINRUDE
1992-2001
65-300 HP, V4, V6 & V8, including jet drives.



18-01312*
JOHNSON/EVINRUDE
1990-2001
1.25-70 HP, 2 & 4-Stroke In Line engines.



18-01313*
EVINRUDE
2002-2014
15-300 HP, All engines.



18-01314*
JOHNSON
2002-2007
3.5-250 HP, All engines.



18-01400
MARINER
1977-1989
2-60 HP, 1 - 2 cyl.



18-01402
MARINER
1977-1989
45-220 HP, 3 - 6 cyl.



18-01404*
MERCURY
1965-1989
2-40 HP, 1 & 2-cyl.



18-01406*
MERCURY
1965-1989
40-115 HP, 3 & 4-cyl.



18-01408*
MERCURY
1965-1989
90-300 HP, 6 - cyl.



18-01416*
MERCURY/MARINER
1990-2000
2.5-275 HP, All 2-Stroke models.



18-01418*
MERCURY
2001-2014
2.5-300 HP, All 2-Stroke Engines.



18-01422*
MERCURY
2005-2011
2.5-300 HP, All 4-Stroke Engines.



18-01500*
NISSAN/TOHATSU
1992-2013
2.5-140 HP, All Engines.



18-01600*
SUZUKI
1988-2003
2-225 HP, All 2-Stroke Engines.



18-01602*
SUZUKI
1996-2007
2.5-300 hp, All 4-Stroke Engines.



18-01701*
YAMAHA
1984-1996
2-250 HP, All 2 & 4-Stroke Engines.



18-01703*
YAMAHA
1997-2014
2-300 HP, All 2-Stroke Engines.



18-01705*
YAMAHA
1995-2004
2.5-225 HP, All 4-Stroke Engines.

STERN DRIVES & INBOARDS

* Available on SelocOnline



18-01707*
YAMAHA
2005-2010
2.5-350 HP, All 4-Stroke Engines.

SUZUKI
1975-1998
QM, GM/HM, JH, JH2 Diesel Engines.
[Web Only](#)

YANMAR
2008-2014
2.5-300 hp All 4 Stroke Engines.
[Web Only](#)



18-03200*
MERCUISER
1964-1991
All gas engines and stern drives.



18-03206*
MERCUISER
1992-2000
Covers all engines and drive units, including transmissions.



18-03208*
MERCUISER
2001-2013
All gas engines & drives, includes inboards & transmissions.



18-03400*
OMC
1964-1986
All gas engines and drives.



18-03404*
OMC COBRA
1986-1998
Covers all gas engines & Cobra/King Cobra drives.



18-03600*
VOLVO/PENTA
1968-1991
Covers all gas engines & drives.



18-03602*
VOLVO/PENTA
1992-1993
Covers all stern drive units powered by Volvo 4-cylinder engines.



18-03606*
VOLVO/PENTA
1992-2002
Covers all gas engines & drives.



18-03608*
VOLVO/PENTA
2003-2012
Covers all gas engines & drives.

SELOC MANUALS

PERSONAL WATERCRAFT

* Available on SelocOnline



18-09000
SEA-DOO
1988-1991
All Sea-Doo & Bombardier models.



18-09002
SEA-DOO/
BOMBARDIER
1992-1997



18-09006*
SEA-DOO/
BOMBARDIER
2002-2011
All 4-Stroke Models.



18-09200
KAWASAKI
1973-1991
300-650 Series.



18-09202
KAWASAKI
1992-1997
550-1100 Series.



18-09400
POLARIS
1992-1997
650-1050 Series, inc.
Fuji-powered models.



18-09600
YAMAHA
1987-1991
All Yamaha, Jet-N-Cat & Cayuna models.



18-09602
YAMAHA
1992-1997
650-1200 Series.



18-09606*
YAMAHA
2002-2011
All 4-Stroke Models.



18-00535
PEGBOARD DISPLAY RACK

Face-out display of 9 SKUs, 18 books. 9 pockets, 2 books deep. Signage included. 14 x 27 x 9. Gray



18-00534
REVOLVING FLOOR DISPLAY RACK

Face-out display of 20 SKUs, 40 books. 4 sides with 5 pockets, 2 books deep. Signage included. 66" x 18" x 18". Gray

SELOC PRO

Seloc Pro is the most comprehensive database tool available to marine technicians! Unlimited access to our database of boat and mechanical repair - a completely automated repair and refinishing system with hull and mechanical labor times, service procedures, wiring diagrams, specifications and an estimating module with parts and pricing.

18-05500
SELOC PRO ONLINE (1 YEAR SUBSCRIPTION)

18-05504
SELOC PRO ONLINE (9 MONTH SUBSCRIPTION)

SELOCONLINE

18-05004
SELOCONLINE (DIY INTERNET ACCESS)
3 YEAR, SINGLE ENGINE SUBSCRIPTION

SelocOnline is an internet based repair product allowing the boater unlimited internet access for three years to a single manufacturer/model/year engine. SelocOnline can be accessed from any computer that has an internet connection and can be viewed from multiple devices on any web-based browser.

The main features of SelocOnline are unit repair sections that contain detailed step-by-step instructions with photos and illustrations (color in newer models). In addition, there are quick access buttons to Maintenance Schedules, Parts Database, Wiring Diagrams, Specification Charts, Dealer Finder and a searchable hyperlinked Index.



18-05002
SELOCONLINE.COM CD DISPLAY

Attractive countertop POP display holds six SelocOnline.com cd's. Must purchase 6 cd's to receive free display.

STATS

SIERRA TOUCH AND TEST SYSTEM

STATS is the perfect solution for performing diagnostics on your marine engine. This self contained system requires no additional computer hardware to operate and works with most popular engine brands. The console integrates an easy to use touch screen with a left/right tactile user interface to create an efficient user experience.



FEATURES & BENEFITS

- Plug and Play Design
- ECU Identification
- Fault Code Reading
- Possible Causes of Faults to aid in diagnosis
- Displays/Records Live Data
- Performs Engine System Functions
- Component Actuation
- PWC Key and Remote Programming
- Splash/Vibration Resistant
- Free Internet Software Updates
- Print & Save Service Results
- USB, PC Interface
- Diagnostic & Sierra Parts Catalog Software

Sierra STATS® is available in two convenient packages. You can choose between a yearly subscription, or a one-time purchase.

OPTION 1: SUBSCRIPTION (COMPLETE KIT)

Part No. 18-SD500

- Includes: 1st year unlimited use subscription for all software platforms offered on STATS®, core hardware and accessory bags, specific cables for Mercury®/Mercruiser®, Mercury® G3, MEFI® 1-4, Johnson®/Evinrude®, Suzuki® O/B, Yamaha® O/B, and Honda® O/B.
- Tester can be topped off to a maximum of 50 tokens every loader update free of charge.
- As new software is launched, it is automatically released to subscription testers for use.
- All other cables will be available as a hardware kit:

Part No.	Cable	Part No.	Cable
18-SD115SUB	Yamaha® PWC	18-SD116SUB	Kawasaki®
18-SD117SUB	Sea-Doo®	18-SD413SUB	MEFI 5-6®
18-SD406SUB	Volvo® Diesel	18-SD407SUB	Yanmar®

STATS SUBSCRIPTION RENEWAL (1 YEAR) • Part No. 18-SD501

Unlimited use of all software offered by STATS for a 12 mo. period. Late renewal fees may apply.

OPTION 2: ONE-TIME PURCHASE (COMPLETE SYSTEM)

Part No. 18-SD410

- Includes: All software and hardware for Mercury®/Mercruiser®, Mercury® G3, MEFI® 1-4, Johnson®/Evinrude®, Suzuki® O/B, Yamaha® O/B, & Honda O/B.
- One-time purchase with no subscription fees. New lower cost and free updates.



18-ADA500
STATS TESTER (CONSOLE)



18-ADA501HC
STATS ACCESSORY HARD CASE



18-ADA502
STATS TESTER (CONSOLE)
NEOPRENE CASE



18-ADA503
STATS DONGLE CASE



18-ADA504
STATS YAMAHA NEOPRENE
CARRY CASE



18-ADA505
STATS MERCURY/
MERCUISER/MEFI
CARRY CASE



18-ADA506
STATS BRP/SEADOO
NEOPRENE CARRY CASE



18-ADA507
STATS KAWASAKI NEOPRENE
CARRY CASE



18-ADA508
STATS SUZUKI NEOPRENE
CARRY CASE



18-ADA509
STATS VOLVO
NEOPRENE BAG



18-ADA510
STATS MEFI NEOPRENE
CARRY CASE



18-ADA511
STATS HONDA
NEOPRENE BAG



18-ADA512
STATS GENERIC
NEOPRENE BAG



18-ADC400
STATS DONGLE A UNIVERSAL



18-ADC401
STATS DONGLE B SEADOO
4 TECH ENGINES



18-ADC409
STATS DONGLE C SEADOO DI ENGINES



18-ADC412
STATS DONGLE D BRP DESS
(2 STROKE)



18-ADC152
STATS POWER CABLE (AC)
 Includes adapters to work with North American, European, Australian, and United Kingdom electrical plugs.



18-ADC450
STATS POWER CABLE (12V)



18-ADC199
JACK SCREWS FOR STATS CONSOLE
 Enables the Master Cable to be secured to the 25-way connector on the STATS tester



18-ADC153
STATS USB CABLE



18-ADC300E
STATS MASTER CABLE (20')



18-ADC402
STATS BRP SAFETY KEY
PROGRAMMING CABLE



18-ADC403
 STATS YAMAHA
 DIAGNOSTIC CABLE



18-ADC404
 STATS BRP
 DIAGNOSTICS CABLE



18-ADC406
 STATS KAWASAKI
 T-IN POWER CABLE



18-ADC407
 STATS MERCURY
 DIAGNOSTIC CABLE



18-ADC408
 STATS BRP
 T-IN POWER CABLE



18-ADC410
 STATS MERCURY
 OUTBOARD CABLE



18-ADC411
 STATS HYDROSPACE/BENELLI/WEBER
 DIAGNOSTIC CABLE



18-ADC414
 STATS KAWASAKI
 POWER CABLE (4-STROKE)



18-ADC415
 STATS VOLVO DIESEL
 DIAGNOSTIC CABLE



18-ADC416
 STATS KAWASAKI
 FITCH DI CABLE



18-ADC417
 STATS YANMAR DIESEL
 DIAGNOSTIC CABLE



18-ADC418
 STATS YAMAHA
 REMOTE PROGRAMMING CABLE



18-ADC419
STATS KAWASAKI
KEY PROGRAMMING CABLE



18-ADC420
STATS SUZUKI
4 PIN DIAGNOSTIC CABLE



18-ADC421
STATS SUZUKI
8 PIN DIAGNOSTIC CABLE



18-ADC422
STATS BRP
DESS DIAGNOSTIC CABLE



18-ADC423
STATS JOHNSON EVINRUDE
DIAGNOSTIC CABLE



18-ADC424
STATS MEFI 1-4 DIAGNOSTIC CABLE



18-ADC425
STATS MEFI 5-6 DIAGNOSTIC CABLE



18-ADC427
STATS HONDA DIAGNOSTIC CABLE



18-ADC428
STATS MERCURY G3
DIAGNOSTIC CABLE

ENGINE ADD ON UPGRADE KITS

Upgrade your STATS console to perfectly suit your needs.

With our Engine Add On Software Kits you can purchase only the software that you require.

18-SD111	MERCURY/MERCURISER/MEFI 1-4
18-SD112	JOHNSON/EVINRUDE
18-SD113	YAMAHA OUTBOARD
18-SD114	SUZUKI
18-SD115	YAMAHA PWC
18-SD116	KAWASAKI
18-SD117	SEA DOO
18-SD405	HYDROSPACE/BENELLI/WEBER
18-SD406	VOLVO D3, D4, D6
18-SD407	YANMAR DIESEL
18-SD413	MEFI 5-6 UPGRADE KIT
18-SD414	HONDA
18-SD415	MERCURY G3 (DROP SHIP ONLY)

 <p>18-5013 TUNE-UP KIT</p> <p>— CONTAINS — Part # Desc. O.E.# 18-5149 Contact Set F12044 18-5169 Condenser F12042-1</p>	 <p>18-5149 CONTACT SET</p> <p>Replaces: F12044, FP2437A</p>	 <p>18-5150 CONTACT SET</p> <p>Replaces: FA305310-2, 817764A2</p>	 <p>18-5169 CONDENSER</p> <p>Replaces: F12042-1</p>
 <p>18-5241 CONDENSER</p> <p>Replaces: F12181-1</p>	 <p>18-5803 SOLENOID</p> <p>Replaces: F177917</p>	 <p>18-5835 SOLENOID</p> <p>Replaces: 89-803822T, 89-F460917-1, F460917-1, 89-817109A3 For: Early model 35-150 HP</p>	 <p>18-5834 SOLENOID</p> <p>Replaces: 89-817109A2 For: 75 HP (3 cyl.) S/N G127500 & UP</p>

 <p>18-5775 SWITCH BOX</p> <p>Replaces: 332-7778A12</p>	 <p>18-5881 SWITCH BOX</p> <p>Replaces: 332-5772A7, 332-5772A5</p>	 <p>18-5790 SWITCH BOX ASSEMBLY</p> <p>Replaces: 18495A26</p>
--	--	--

 <p>18-5870 STATOR</p> <p>Replaces: 398-832075A4</p>	 <p>18-5873 STATOR & KIT</p> <p>Replaces: 398-832075A6 For: 100, 115, 125 HP</p>	 <p>18-5186 IGNITION COIL</p> <p>Replaces: 339-7370A13, 339-7370B13, 339-832757B4</p> <p>D 18-5186D Display Package</p>
---	--	--

COIL & STATOR APPLICATION

Year	HP	S/N	Coil	Stator	Year	HP	S/N	Coil	Stator
1992-95	40/50	E000001-E138599	18-5186	—	1990-95	120	ALL	18-5186	—
1996-99	40/50	E138600-E369299	—	18-5870	1994-95	120	E065487-E138599	18-5186	18-5873
1991-95	70	E000001-E138599	18-5186	—	1994-95	SPORT JET 120	E095088-E141088	18-5186	18-5873
1996-99	75	E138600-UP	—	18-5870	1996-99	120	E138600-UP	—	18-5870
1991-95	90	E000001-E138599	18-5186	—	1989-94	150	ALL	18-5186	—
1996-99	90	E138600-UP	—	18-5870					

CHRYSLER IGNITION

HP	Model	Contact Set	Condenser	Tune-Up Kit	Starter Solenoid	HP	Model	Contact Set	Condenser	Tune-Up Kit	Starter Solenoid
4.5	42HA	—	18-5241	—	N/A	9.9	92H1H,H1J,H2J,H3K	—	18-5241	—	N/A
4.9	44HA,44/45HB, HC, HD	—	18-5241	—	N/A	9.9 [Ⓜ]	92/93H9F,98/99H9A	—	18-5241	—	N/A
5	52/53HA	—	18-5241	—	N/A	9.9	92/93HA-HE,H0G, 94H1F	—	18-5241	—	N/A
5	54/55HA, HB, HC, HD	—	18-5241	—	N/A	9.9 [Ⓢ]	94/95HA	—	18-5241	—	18-5803
6	60HA,62/63HA-HH, H9M	—	18-5241	—	N/A	9.9 [Ⓣ]	94/95HA-HE	—	18-5241	—	N/A
6	64HA-HC, H0F, H1G, H2H, H8D, H9E	—	18-5241	—	N/A	10 [Ⓤ]	102/103HD,H8B, 108/109HA,H8B	—	18-5241	—	—
7	72/73HA	—	18-5241	—	N/A	10	102/103/104/105HA, HB, HC	—	18-5241	—	N/A
8	82/83HA-HH,H9K	—	18-5241	—	N/A	12.9	122/123H9E, 128/129H9A	—	18-5241	—	—

Ⓤ Items ending in "D" are Display Packaged - Regular number is Non-Display

APPLICATION CONTINUED ON NEXT PAGE

CHRYSLER IGNITION (Cont.)

HP	Model	Contact Set	Condenser	Tune-Up Kit	Starter Solenoid	HP	Model	Contact Set	Condenser	Tune-Up Kit	Starter Solenoid
12.9	122/123/124/125HA, HC, HD	—	18-5241	—	N/A	35③	356/357HA-HF	18-5162	—	—	18-5803
15	152H1G, H1H, H2H, H3J	—	18-5241	—	N/A	35	360/361HA, HB	18-5149	18-5169	18-5013	—
15	152/153HA, HB, H0F	—	18-5241	—	N/A	45③	450 THRU 457HA, HC-HH	18-5162	—	—	18-5803
15①	152/153HC, H8D, H9E	—	18-5241	—	—	45②	450 THRU 457HA, HC-HH	18-5149	18-5169	18-5013	18-5803
15	154/155HA, 154HB	—	18-5241	—	N/A	45①	450 THRU 457HC-HH	18-5162	N/A	N/A	18-5803
15	158/159HA, H8B, H9C	—	18-5241	—	—	45	450/451HK, 452/453HC-HJ, H8K	18-5149	18-5169	18-5013	—
20	202H2N, 202/203HA-HG, H0L	—	18-5241	—	N/A	45	456/7H0L, HJ, H1M, H9K, 457H3P, H2N	18-5162	—	—	18-5803
20①	202/203H1M, H9K	—	18-5241	—	—	45	458/459HA, HG	18-5162	N/A	N/A	18-5803
20	204/205HA-HG	—	18-5241	—	N/A	45③	458/459HA-HF	18-5162	—	—	18-5803
20①	206/207H9B	—	18-5241	—	—	45①	458/459HA-HF	18-5162	N/A	N/A	18-5803
25	252H1F, H2F, H3G, 252/253H8C	—	18-5241	—	N/A	45②	458/459HA-HF	18-5149	18-5169	18-5013	18-5803
25②	252/253HB, H8D, 254/255HB	—	18-5241	—	N/A	45	459H0J, H9H	18-5162	—	—	18-5803
25	252/253/254/255HA	—	18-5241	—	N/A	45	464HA	18-5149	18-5169	18-5013	18-5803
25③	252/253/254/255HB, 256/257HA	18-5162	—	—	—	50	503H3A, 507H1A, H2B, H2C, H3D, R3E	18-5162	—	—	18-5803
25②	256/257HA, H8C	—	18-5241	—	N/A	55	551HA	18-5162	—	—	18-5803
30②	302/303H9C, HB	—	18-5241	—	N/A	55②	554 THRU 559HA, HC-HG	18-5149	18-5169	18-5013	18-5803
30	302/303/304/305HA	—	18-5241	—	N/A	55③	554 THRU 559HA, HC-HG	18-5162	—	—	18-5803
30③	302/303/304/305HB, 306/607HA	18-5162	—	—	—	55①	554 THRU 559HA, HC-HG	18-5162	N/A	N/A	18-5803
30②	304/305HB, 306/607HA	—	18-5241	—	N/A	70	706/707HA, HC-HF	18-5150	N/A	N/A	18-5803
35②	350/351HK, H8L, 356/357HK, H8M	—	18-5241	—	N/A	75	756/757HA	18-5150	N/A	N/A	18-5803
35③	350/351/354/355HC-HH	18-5162	—	—	18-5803	85	856/857HA, HC, HD, HE	18-5150	N/A	N/A	18-5803
35②	350/351/354/355HC-HH	18-5149	18-5169	18-5013	18-5803	90	906/907HA	18-5150	N/A	N/A	18-5803
35①	350/351/354/355HH, 356/357HF	18-5162	N/A	N/A	18-5803	105	1056/1057HA-HF, 1058HA, HB, HC	18-5150	N/A	N/A	18-5803
35③	350/351/356/357HK	18-5162	—	—	—	105	1058HD, 1059HD	N/A	N/A	N/A	18-5803
35	350/352/353/354/355HA, 352/353HF	18-5149	18-5169	18-5013	18-5803	120	1206/1207HA-HF, 1208HA, HB, HC	18-5150	N/A	N/A	18-5803
35	352/353HC-HE, HG-HJ, H2P, H8K, H9L	18-5149	18-5169	18-5013	—	120	1208HD, 1209HD	N/A	N/A	N/A	18-5803
35	353H0M, H1N	18-5149	18-5169	18-5013	—	130	1306/1307HA	18-5150	N/A	N/A	18-5803
35②	356/357HA-HF	18-5149	18-5169	18-5013	18-5803	135	1356/1357HA, 1358HA, HB, HC	18-5150	N/A	N/A	18-5803
						135	1358HD, 1359HD	N/A	N/A	N/A	18-5803
						150	1508HA	18-5150	N/A	N/A	18-5803

- ① Magnapower ignition (w/alternator & C-D Unit) ③ Standard ignition (w/alternator) ⑤ 95HA S/N 3300 & up, 95HA S/N 3125 & up
 ② Magneto ignition (no alternator) ④ 94 HA S/N 3299 & below, 95HA S/N 3124

FORCE IGNITION

Year	Model	Serial #	Contact Set	Condenser	Solenoid	Switch Box
1984-87	9.9/15	N/A	—	18-5241	—	—
1996-99	40/50	E138600-E369299	—	—	18-5834②	—
1984-87	50	N/A	18-5162	—	18-5803	—
1988	50	N/A	—	—	18-5803①	—
1991B, 1992C	70	E000001-E039023	18-5162	—	18-5803	18-5790
1991-95	70	E000001-E138599	—	—	—	18-5790
1996-99	75	E138600-UP	—	—	18-5834②	—
1991D-1992C	90	E000001-E039023	N/A	N/A	—	18-5775
1991	90 L-DRIVE	N/A	N/A	N/A	—	18-5775
1991-95	90	E000001-E138599	—	—	—	18-5790
1996-99	90	E138600-UP	—	—	18-5834②	—
1993-94	SPORT JET 90	E023150-E033710	N/A	N/A	—	18-5775
1991D-1992C& 1993, 1994	120	E000001-E093699	N/A	N/A	—	18-5881
1995	120	E093700-E138599	N/A	N/A	—	18-5881
1996-99	120	E138600-UP	—	—	18-5834②	18-5790
1991-92	120 L-DRIVE	N/A	N/A	N/A	—	18-5881

① Except "D" Models ② Style II

PREMIUM MARINE SPARK PLUG WIRE LEADS

Sierra's MAGFORCE Ignition Wires are "Electronics Friendly" protecting all of your electronic devices and electronic engine controls from RFI and EMI while delivering the maximum amount of voltage. Exact fit design ensures easy installation and years of trouble - free service.



- Moisture-proof, molded distributor insulators
- High-quality conductive center carrier reinforcement ensures conductor integrity
- Mag/Wire wound core delivers maximum voltage without radio frequency interference (R.F.I.) & electro magnetic interference (E.M.I.)
- High tensil strength membrane for added durability & heat resistance
- Innovative nylon reinforcing tape for added strength and durability
- 8mm high tear strength silicone jacket protects conductor up to 500° F
- High-temperature, pre-greased silicone insulators
- Posi-lock stainless steel terminals resist corrosion



Part No.	Description
18-8819-1	7" Spark Plug Wire
18-5228-1	9" Spark Plug Wire
① 18-5228-1D	9" Spark Plug Wire
②③ 18-5229-9-1	22" Spark Plug Wire (pkg of 5)
②③ 18-5230-9-1	10" Spark Plug Wire (pkg of 5)



18-9802
TIMING LIGHT
Self-powered accurate up to 10,000 RPM's

BATTERY CABLES
Gauge cable with soldered lug terminals on each end to accept a 3/8" stud.

Part No.	Size	Color	Gauge
BC88523	2'	Red	4
BC88533	2'	Black	4
BC88543	4'	Red	2
BC88553	4'	Black	2
BC88563	6'	Red	2
BC88573	6'	Black	2
BC88583	8'	Red	1
BC88593	8'	Black	1

18-5225
SPARK PLUG WIRE KIT
Replaces:
Mercury 84-99215A26, 84-813706A26
Kit includes 25 ft. roll of 7mm hypalon ignition wire with a metallic core and a large assortment of three different end fittings to fit outboard motors.

18-5222
IGNITION WIRE
Silicone Core
(100' Spool)
8mm

18-5226
IGNITION WIRE
Metallic Core
(100' Spool)
7mm Hypalon

PKG. OF 10

18-5224
18-5224-9②
IGNITION WIRE TERMINAL

PKG. OF 10

18-5750
18-5750-9②
UNIVERSAL SPARK PLUG BOOTS
Supplied complete w/Terminal Connector

18-5752
UNIVERSAL SPARK PLUG BOOTS
(8mm)

18-5206
CONDENSER
Replaces: 398-176

① Items ending in "D" are Display Packaged - Regular number is Non-Display
② Priced per Package
③ Uses 7mm wire copper core



18-5742
VOLTAGE REGULATOR
Replaces: 8152792, 815279T3, 815279T2, 830179A2, 817411, F746470, F718470
 Force engines with 16 amp - 20 amp charging system model years 1991-92



18-5744
VOLTAGE REGULATOR
Replaces: 8152794, 883071A1, 856747T1, 854514A1, 830179A1, 8174111, 815279T5, 815279T4
 Force engines with 16 amp - 20 amp charging system model years 1993-present

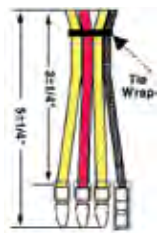

18-6762
TILT/TRIM MOTOR
Replaces: 449541-3, 455541

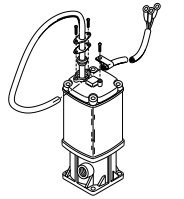

18-6775
TILT/TRIM MOTOR
Replaces: 824051, 830250A6
For: 90 HP (1995-97) and 120 HP (1995-97)
 Contains: All parts necessary, a new 3-wire motor/reservoir, drive shaft coupler, oil seal, o-ring and hardware.

If you have this 3-wire single ram system, use **18-6775**



18-6286
TILT/TRIM MOTOR
 Heavy Duty Late Model Mercury/Force 25-50HP Outboards w/2-wire connection and flat blade shaft. 4 bolt mount.
Replaces: 827675A1



18-6279
TILT/TRIM MOTOR
Replaces: 820545, F694541-1
 Late model Force outboards w/2 wire connection

18-6777
TILT/TRIM MOTOR

Replaces: 818903A1, 819762A4-A7, 819479A1, 819480A1, 81977A8-A9, 822870A1, 830250A3-T3, 832021A1-T4-A2-T2, 855654A1-T2, 19217A1-A5
 Contains: All parts necessary, a new 2-wire motor/reservoir, drive shaft coupler, oil seal, O-ring and hardware.

For:

HP	Years	HP	Years
40	1992-94	90	1991-94
50	1991-94	120	1990-94
70	1991-95	150	1989-94
75	1996-99		

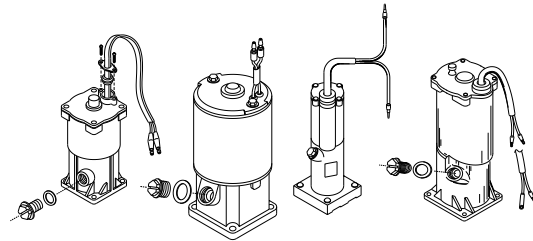

If you have any of the 2-wire single ram systems, use **18-6777**



18-6439
STARTER
Replaces: 50-803903T, 50-F575955
Fits: 50HP (1984-92)



18-6441
STARTER
Replaces: 50-803900T, 50-F514955
Fits: 25 HP (1983-84, 1989), 30 hp (1979), 35 HP (1976-78, 1986-91)



18-5613
OUTBOARD STARTER
Replaces: Mercury/Force FK616955, F616955, F490955, F480955, FS438955, F438955-1, F85955-1, FA85955, FS438955, FS480955, FS489955, FS490955



18-5618
OUTBOARD STARTER
Replaces: Mercury/Force 50-819968-2, 50-8199684, 50-8199683, 50-8199681, 50-819968, 50-898265003



18-5622
OUTBOARD STARTER
Replaces: Mercury/Force 50-820193, 50-820193T1

18-5673
DRIVE ASSEMBLY
Replaces: Mercury/Force F15100, F15110, 819222



18-5697
DRIVE BRUSH KIT
Replaces: 75384, F15164









CHRYSLER/FORCE

Years	Starter	OEM #	Drive Assembly	O.E. #	Tooth Count	Drive Brush Kit	O.E. #
1983-84	18-6441	50-F514955/514955	18-5655	F15150	10	18-5697	F15157
1989	18-6441	50-F514955/514955	18-5655	F15150	10	18-5697	F15157
1979	18-6441	50-F514955/514955	18-5655	F15150	10	18-5697	F15157
1976-78	18-6441	50-F514955/514955	18-5655	F15150	10	18-5697	F15157
1986-91	18-6441	50-F514955/514955	18-5655	F15150	10	18-5697	F15157
1966-89	①	201955/FK575955	-	F15150	9	18-5697	F15164
1966-92	18-6439	50-F575955	18-5655	F15150	10	18-5697	F15164
1966-92	①	50-F514955/514955	-	-	10	18-5697	F15164
1992-99	18-5622	50-820193/50-820193T1	18-5677	811902	13	18-5697	F15164
1992-94	①	50-819271/50-820193A1	18-5677	811902	13	18-5697	F15164
1966-89	18-5613	50-819085/F616955-1/F616955	-	819222	9	18-5697	F15164
1966-89	18-5613*	480955/FK616955	-	F15100, F15110	9	18-5697	F15164
1991-95	18-5613	50-819085/F616955-1/F616955	-	819222	9	-	F15190
1996-98	18-5613	50-819085/F616955-1/F616955	-	819222	9	-	F15190
1989	18-5613	50-819085/F616955-1/F616955	-	819222	9	18-5697	F15164
1992-97	18-5618	50-819968-2	-	820583	9	-	F15190
1991-98	18-5613	50-819085/F616955-1/F616955	-	819222	9	-	F15190
1990-91	18-5613	50-819085/F616955-1/F616955	-	819222	9	18-5697	F15164
1990-91	18-5613	50-819085/F616955-1/F616955	-	819222	9	18-5697	F15164
1990-94	18-5613	50-819085/F616955-1/F616955	-	819222	9	18-5697	F15164
1989A-1992C	18-5613	50-819085/F616955-1/F616955	-	819222	9	-	F15190
1989-1994	18-5613	50-819085/F616955-1/F616955	-	819222	9	-	F15190

① No replacement starter available, drive parts only

* Only fits 140 HP (1983-1984)

 <p>18-7033 CARB KIT Replaces: FK10003, FK10026, FK10053, FK10102-1</p>	 <p>18-7037 CARB KIT Replaces: FK10004, FK10005, FK10007, FK10008, FK10027, FK10057, FK10108, FRK739</p>	 <p>18-7041 NEEDLE & SEAT Replaces: FO16311, FO10790</p>	
 <p>18-7057 NEEDLE & SEAT Replaces: F010790 .078 Bore</p>	 <p>18-7805 FUEL PUMP KIT Replaces: F24747-1</p>	 <p>18-7806-1 FUEL PUMP KIT</p>	 <p>18-7817 DIAPHRAGM KIT Replaces: 21-42990A7, A8, A9, A10, 21-857005A1</p>

CHRYSLER

HP	Model	Carb Kit	Needle & Seat	Fuel Pump Kit
3.6	32/33HA,HB,HC	18-7037	18-7057	N/A
4.5	42HA	18-7037	18-7057	18-7805
5	52/53HA	-	-	18-7805
6	60HA	18-7037	18-7057	18-7805
6	60H0D,H8B,H9C	-	-	18-7805
6	61H0C,H8B,H9B	-	-	18-7805
6	62H8J,H9K,H9L	-	-	18-7805
6	67H9B,H9C	-	-	18-7805
6	62/63H9M	18-7037	18-7057	18-7805
6	62/63HA ①	18-7037	18-7057	18-7805

① S/N 3001 & up

APPLICATION CONTINUED ON NEXT PAGE

CHRYSLER (Cont.)				
HP	Model	Carb Kit	Needle & Seat	Fuel Pump Kit
35	352/353HE, HF, HG, HH, HJ, H2P	18-7037	18-7057	—
35	354/355HE, HF, HG, HH	18-7037	18-7057	—
35	356/357HC, HD, HC, HE, HF, HK, H8M	18-7037	18-7057	—
35	357H3N, R3P, 360/361HA, HB	18-7037	18-7057	—
35	356/357HA, HB	18-7037	18-7057	18-7806-1
45	450/451HK	18-7037	18-7057	—
45	450 THRU 457HA, HC, HD	18-7037	18-7057	18-7806-1
45	450 THRU 457HE, HF, HG, HH	18-7037	18-7057	—
45	452/453HJ, H8K	18-7037	18-7057	—
45	456/457H0L, HJ, H1M, H9K, 457H2N	18-7037	18-7057	—
45	458/459HA, HB	18-7037	18-7057	18-7806-1
45	458/459HD, HC, HE, HF, HG	18-7037	18-7057	—
45	459H0J, H9H	18-7037	18-7057	—
45	468/469HA	18-7037	18-7057	—
50	503H3A, 507H1A, H2B, H2C, H3D, R3E	18-7037	18-7057	—
55	551HA, 554 THRU 559HA, HD, HF ③	18-7037	18-7057	18-7806-1
55	554 THRU 559HE, HG	18-7037	18-7057	—
55	558/559HH, HJ, HK, H9L	18-7033	18-7057	—
55	559H0M, H0N, H1N, H2P, H3R, V3S	18-7033	18-7057	—
60	608/609HA	18-7033	18-7057	—
65	659HA, HB	—	18-7057	—
70	706/707HA, HC, HD, HE	18-7033	18-7057	18-7806-1
70	706/707HF, 709HOAN, H9A	18-7037	18-7041	—
70	T700H9A	18-7037	18-7057	—
75	754H0B, 456H0F, H2H, 757HD, H9E	18-7033	18-7057	—
75	756/757HA, HB, HC, 756H1G	18-7037	18-7041	—
75	758H0B, H1C, P/S759H9A	18-7037	18-7041	—
75	758H2D, T750H9A	18-7037	18-7057	—
85	850H0A, H1C, 851H9A, P/S855H9A	18-7033	18-7057	—
85	856H0H, H1J, H2K	18-7033	18-7057	—
85	856/7HA, HC, HD	18-7033	18-7057	18-7806-1
85	856/7HE	18-7037	18-7041	—
85	857HF, H9G	18-7033	18-7057	—
85	858H0C, H1D, H2E	18-7033	18-7057	—
85	859HA, H8A, H9B, T850H9A	18-7033	18-7057	—
90	906/907HA, HB, HC	18-7033	18-7057	—
100	T1000H9A, 1002H0AN, 1004H0B, H9A	—	18-7057	—
100	1006H0B, H1C, 1007H9A, 1008H0A, H1B	—	18-7057	—
105	1055HA	18-7037	18-7057	—
105	1055HB	—	18-7057	—
105	1056/1057HA, HB, HC, HD	18-7037	18-7057	18-7806-1
105	1056/1057HE, HF	18-7037	18-7057	—
105	1057HH, 1058H2G	—	18-7057	—
105	1058 HA, HB, HC	18-7037	18-7057	18-7806-1
105	1058/9HD, HE	18-7037	18-7057	—
105	1058/1059HF, 1059HG	—	18-7057	—
115	1159HA	—	18-7057	—
120	1206/1207HA, HB, HC, HD	18-7037	18-7057	18-7806-1
120	1206/1207HE, HF	18-7037	18-7057	—
120	1208HA, HB, HC	18-7037	18-7057	18-7806-1
120	1208/1209HD, HE	18-7037	18-7057	—
120	1208/1209HF, 1209HG	—	18-7057	—
130	1306/1307HA	18-7037	—	18-7806-1
135	1358HA, HB, HC	18-7037	18-7057	18-7806-1
150	1508HA	18-7037	—	18-7806-1

③ 554HF S/N 11072 & up 555HF 14439 & up, 557HF 14581 & up 558HF 11108 & up, 559HF 14309 & up

FORCE

HP	MODEL	YEAR	BEGINNING SERIAL #	ENDING SERIAL #	FUEL PUMP KIT
5	5	1988-1996	N/A	N/A	18-7805
7.5	7.5	1985	N/A	N/A	18-7805
9.9 / 15	9.9 / 15	1984-1998	N/A	N/A	18-7805
25	25	1989	N/A	N/A	18-7806-1
35	35	1986-1987	N/A	N/A	18-7806-1
35A	35A	1988-1991	N/A	N/A	18-7806-1
35B	35B	1988-1991	N/A	N/A	18-7806-1
35C	35C	1989-1991	N/A	N/A	18-7806-1
40 / 50	40 / 50	1992	E000001	E065371	18-7806-1
40 / 50	40 / 50	1992-1994	E065372	E093669	18-7817
40 / 50	40 / 50	1995	E093700	E138599	18-7817
40 / 50	40 / 50	1997-1999	E138600	& UP	18-7817
50	50	1984-1992	N/A	N/A	18-7806-1
60	60	1985	N/A	N/A	18-7806-1
70	70	1991B / 1992C	E000001	E039023	18-7806-1 ①
70	70	1992-1995	E039024	E138599	18-7817 ①
75	75	1996-1999	E138600	& UP	18-7817
85	85	1983-1988 / 1989A, 1989B	N/A	N/A	18-7806-1
85	85	1989C-H / L-DRIVE	N/A	N/A	18-7806-1
90	90	1991A / 1991B / 1991C	N/A	N/A	18-7806-1
90	90	1991D-1992C	E000001	E039023	18-7806-1 ①
90	90	1992-1994	E039024	E093699	18-7817 ①
90	90	1995-1999	E093700	& UP	18-7817
90	90 L-Drive	1991	N/A	N/A	18-7806-1
90	90	1990	N/A	N/A	18-7806-1
90	90 L-DRIVE	1990	N/A	N/A	18-7806-1
90	SPORT JET 90	1993-1994	E023150	E066619	18-7806-1
90	SPORT JET 90	1995-1996	E138325	E138599	18-7806-1
90	SPORT JET 90XR	1996-1997	E141089	& UP	18-7806-1
120	120	1990A-1991C	N/A	N/A	18-7806-1
120	120	1991D-1992C	E000001	E093699	18-7817 ①
120	120	1993-1994	E000001	E093699	18-7817
120	120	1995	E093700	E138599	18-7817
120	120	1996-1999	E0138600	& UP	18-7817
120	120 L-DRIVE	1990-1992	N/A	N/A	18-7806-1
120	120 SPORT JET	1995-1997	E095088	E138599	18-7806-1
125	125	1984-1989	N/A	N/A	18-7806-1
125	125 L-DRIVE	1989	N/A	N/A	18-7806-1
150	150	1989-1992	UP TO	E065371	18-7806-1
150	150	1993-1994	E000001	E093699	18-7817

① Serial # E000001-E065371 use 18-7806-1

FUEL WATER SEPARATORS



Sierra offers a complete line of 10 and 21 micron fuel water separating filters including drainable bowl filters to protect your carbureted and fuel injected engine.

Refer to pages 136-140 for a complete listing of OEM and universal applications.

Sierra fuel water separators remove over 99.8% of emulsified water from your gasoline. Sierra's 10 micron filters are over 90% efficient at removing particles as small as 10 micron. All filters flow @ 90 GPH to feed even the hungriest motor. Sierra 10 micron filters are recommended to prevent damage to sensitive inboard and outboard fuel injection systems.

8' LENGTH COMPLETE FUEL LINE ASSEMBLIES

FUEL LINE ASSEMBLY

18-8011EP-2 SILVERADO 4000 Premium

OE# FS409752



18-8071 TANK CONNECTOR
(SOLD SEPARATELY)



18-8005EP-1 PRIMER BULB



18-8062 FUEL CONNECTOR



*

FUEL LINE ASSEMBLY COMPONENTS

*

CHRYSLER FUEL APPLICATION

Engine	Year
6 HP	1976-82
7.5 HP	1979-85
8 HP	1976-79
9.9 HP	1979-95
10 HP	1976-78
12 HP	1979
15 HP	1976-95
20 HP	1978-82
25 HP	1975-78, 1981-84, 1989
30 HP	1979-82

Engine	Year
35 HP	1974-89
40 HP	1992-94
45 HP	1974-84
50 HP	1981-94
55 HP	1974-83
60 HP	1984-85
65 HP	1978
70 HP	1979-80, 1991-95
75 HP	1975-84
85 HP	1977-88

Engine	Year
90 HP	1975-77, 1983-84, 1991-94
100 HP	1979-84
105 HP	1976-78, 1982
115 HP	1977-84
120 HP	1976-77, 1990-94
125 HP	1981-88
135 HP	1976-77
140 HP	1978-84
150 HP	1989-94



18-8002EP-1
18-8002EP-1-10^①
PRIMER BULB
1/4"



18-8004EP-1
18-8004EP-1-10^①
PRIMER BULB
5/16"
Large capacity bulb



18-8005EP-1
18-8005EP-1-10^①
PRIMER BULB
3/8"
Large capacity bulb

① Discount shop pack of 10 - Priced per package



18-8062 FUEL CONNECTOR
3/8" barb
Replaces: 197787-3
Mates with **18-8071**



18-8071 TANK CONNECTOR
1/4" NPT .432 O.D.
Mates with **18-8062** (Male)



18-3550 THERMOSTAT
Replaces: F85068-2, F84068-2, F85068-1, F85068
140°



18-3556 THERMOSTAT
Replaces: F97068-2
3/4" - 130°



18-3557 THERMOSTAT
Replaces: F335068
1" - 143°



18-3559 THERMOSTAT
Replaces: F528068
1" - 110°



18-3030 IMPELLER
Replaces: 47-803630T, F523065, F523065-1
For: Force outboard, 85 HP (1975-89, except 1989 D, F, G, H), 125 HP A,B,&C (1981-88)



18-3017
18-3017-10^②
IMPELLER
Replaces: 47-89984T4, 47-F694065, 47-803631T



18-3056
18-3056-10^②
IMPELLER
Replaces: 47-430262





18-3057 IMPELLER
Replaces: 47-85089-3

APPLICATION ON NEXT PAGE

- ① Items ending in "D" are Display Packaged - Regular number is Non-Display
- ② Discount shop pack of 10 - Priced per package

			
18-3062 IMPELLER Replaces: 47-42038-2, 002	18-3084 IMPELLER Replaces: 47-F40065-2	18-3085 IMPELLER Replaces: 47-F84065	18-8900 IMPELLER Replaces: 47-19453
			
18-8901 IMPELLER Replaces: 47-F462065	18-8903 IMPELLER Replaces: 47-F436065-2	18-45003 IMPELLER Replaces: 47-F433065 Fits: Force 35/45/55 hp (1974-80)	18-3240 WATER PUMP KIT For: 9.9HP (1979-97) 10HP (1974-78) 12HP (1979) 15HP (1974-97) 20HP (1973-78) 25HP (1973-78)

 <p style="text-align: center;">① 18-3251D Display Package</p> <p>18-3251 WATER PUMP KIT For: 85HP (1989 D, F, G, H) 90HP (all except 1995-97 & Sport Jet) 120HP (all except 1995-97 & Sport Jet) 125HP (1988-89) 150HP (1989-up)</p> <p style="text-align: center;">— CONTAINS —</p> <table border="1" style="width: 100%; border-collapse: collapse;"> <thead> <tr> <th>Part #</th> <th>Desc.</th> <th>O.E. #</th> <th>Qty.</th> </tr> </thead> <tbody> <tr> <td>18-0416</td> <td>Gasket, Wear Plate</td> <td>27-F694830</td> <td>1</td> </tr> <tr> <td>18-3017</td> <td>Impeller</td> <td>47-89984T4</td> <td>1</td> </tr> </tbody> </table>	Part #	Desc.	O.E. #	Qty.	18-0416	Gasket, Wear Plate	27-F694830	1	18-3017	Impeller	47-89984T4	1	 <p style="text-align: center;">① 18-3214D Display Package</p> <p>18-3214 IMPELLER REPAIR KIT Replaces: 46-43024A7</p> <p style="text-align: center;">— CONTAINS —</p> <table border="1" style="width: 100%; border-collapse: collapse;"> <thead> <tr> <th>Part #</th> <th>Desc.</th> <th>O.E. #</th> <th>Qty.</th> </tr> </thead> <tbody> <tr> <td>18-2564</td> <td>Water Pump Base to Face Plate Gasket</td> <td>27-43033-1</td> <td>1</td> </tr> <tr> <td>18-2565</td> <td>Water Pump Base to Gear Hsg. Gasket</td> <td>27-43047-1</td> <td>1</td> </tr> <tr> <td>18-2566</td> <td>Face Plate to Water Pump Cover Gasket</td> <td>27-817277</td> <td>1</td> </tr> <tr> <td>18-2944</td> <td>Seal Ring</td> <td>26-45577</td> <td>1</td> </tr> <tr> <td>18-3056</td> <td>Impeller</td> <td>47-43026-1</td> <td>1</td> </tr> <tr> <td>18-3122</td> <td>Impeller Plate</td> <td>817276</td> <td>1</td> </tr> <tr> <td>18-7420</td> <td>O-Ring</td> <td>25-21836</td> <td>1</td> </tr> </tbody> </table>	Part #	Desc.	O.E. #	Qty.	18-2564	Water Pump Base to Face Plate Gasket	27-43033-1	1	18-2565	Water Pump Base to Gear Hsg. Gasket	27-43047-1	1	18-2566	Face Plate to Water Pump Cover Gasket	27-817277	1	18-2944	Seal Ring	26-45577	1	18-3056	Impeller	47-43026-1	1	18-3122	Impeller Plate	817276	1	18-7420	O-Ring	25-21836	1	 <p style="text-align: center;">① 18-3215D Display Package</p> <p>18-3215 IMPELLER REPAIR KIT</p> <p style="text-align: center;">— CONTAINS —</p> <table border="1" style="width: 100%; border-collapse: collapse;"> <thead> <tr> <th>Part #</th> <th>Desc.</th> <th>O.E. #</th> <th>Qty.</th> </tr> </thead> <tbody> <tr> <td>18-2560</td> <td>Impeller Washer Gasket</td> <td>12-86645</td> <td>2</td> </tr> <tr> <td>18-2561</td> <td>Gear Hsg. to Face Plate Gasket</td> <td>27-85087</td> <td>1</td> </tr> <tr> <td>18-2562</td> <td>Gear Hsg. to Face Plate Gasket</td> <td>27-99326-1</td> <td>1</td> </tr> <tr> <td>18-3057</td> <td>Impeller</td> <td>47-85089-3</td> <td>1</td> </tr> <tr> <td>18-7419</td> <td>O-Ring</td> <td>25-69202</td> <td>1</td> </tr> </tbody> </table>	Part #	Desc.	O.E. #	Qty.	18-2560	Impeller Washer Gasket	12-86645	2	18-2561	Gear Hsg. to Face Plate Gasket	27-85087	1	18-2562	Gear Hsg. to Face Plate Gasket	27-99326-1	1	18-3057	Impeller	47-85089-3	1	18-7419	O-Ring	25-69202	1
Part #	Desc.	O.E. #	Qty.																																																																			
18-0416	Gasket, Wear Plate	27-F694830	1																																																																			
18-3017	Impeller	47-89984T4	1																																																																			
Part #	Desc.	O.E. #	Qty.																																																																			
18-2564	Water Pump Base to Face Plate Gasket	27-43033-1	1																																																																			
18-2565	Water Pump Base to Gear Hsg. Gasket	27-43047-1	1																																																																			
18-2566	Face Plate to Water Pump Cover Gasket	27-817277	1																																																																			
18-2944	Seal Ring	26-45577	1																																																																			
18-3056	Impeller	47-43026-1	1																																																																			
18-3122	Impeller Plate	817276	1																																																																			
18-7420	O-Ring	25-21836	1																																																																			
Part #	Desc.	O.E. #	Qty.																																																																			
18-2560	Impeller Washer Gasket	12-86645	2																																																																			
18-2561	Gear Hsg. to Face Plate Gasket	27-85087	1																																																																			
18-2562	Gear Hsg. to Face Plate Gasket	27-99326-1	1																																																																			
18-3057	Impeller	47-85089-3	1																																																																			
18-7419	O-Ring	25-69202	1																																																																			

① Items ending in "D" are Display Packaged - Regular number is Non-Display
 ② Discount shop pack of 10 - Priced per package

CHRYSLER/FORCE

HP	Year	Serial No.	Impeller	Impeller Kit	Thermostat
9.9	1979-97	ALL	18-8903	18-3240	—
9.9/15	1998	E288600-E344999 □	18-3062	—	—
10	1974-78	ALL	18-8903	18-3240	—
12	1979	ALL	18-8903	18-3240	—
15	1974-97	ALL	18-8903	18-3240	—
20	1973-78	ALL	18-8903	18-3240	—
20	1979-82	ALL	18-8901	18-3240	—
25	1973-78	ALL	18-8903	18-3240	—
25	1996-98	E127700-E344999	18-3057	18-3215	18-3556
30	1980-82	ALL	18-8901	—	—
35	1976-78, 83-84 & 86-88	ALL	18-8901	—	18-3556
35	1979-82	ALL	18-3084	—	18-3556
40/50	1992-94	E065372-E093669	—	—	18-3556
40/50	1995-99	E093700-E369299	18-3057	—	18-3556

① Except model "C" for 1988 ② 1989 "D" & "E" models ③ Mercury Lower Unit

APPLICATION CONTINUED ON NEXT PAGE

CHRYSLER/FORCE (Cont.)

HP	Year	Serial No.	Impeller	Impeller Kit	Thermostat
50	1984-91,1992A	N/A	—	—	18-3556
70	1979-80	ALL	18-3085		18-3559
70	1991-95	E138600-E345999	18-8900	—	—
75	1979	ALL	18-3085		18-3559
75	1980	ALL	18-3030		18-3559
75	1996-98	E138600-E345999	18-8900	—	—
75	1999	E345000-UP	18-3057	—	—
85	1977-88	ALL	18-3030		18-3559
85	1989	A,B	18-3030		18-3559
85	1989	C,E	18-3030		—
85	1989	D, F, G, H	18-3017		—
85	L-DRIVES 1989	A,B,C	18-3017	—	—
90	1991A,B,C,D-1992C	E000001-E039023	18-3017	18-3251	—
90	1992-94	E039024-E093699	18-3017	18-3251	—
90	1995-97	E093700-UP	18-3056	18-3214	—
90 L-DRIVE	1991	N/A	18-3017	18-3251	—
90 & L-DRIVE	1990	N/A	18-3017	18-3251	—
SPORT JET 90	1993-94	E023150-E066619	—	—	—
SPORT JET 90	1995-96	E138325-E138599	—	—	—
SPORT JET 95XR	1996-97	E141089-UP	—	—	—
100	1979-80	ALL	18-3030		18-3559
105	1977-78	ALL	18-3030		18-3559
115	1977-80	ALL	18-3030		18-3559
120/135	1977	ALL	18-3030		18-3559
120	1990A-91C	N/A	18-3017	18-3251	—
120	1991D-92C& 1993, 1994	E000001-E093699	18-3017	18-3251	—
120	1995-97	E093700-UP	18-3056	18-3214	—
120 L-DRIVE	1990-92	N/A	18-3017	18-3251	—
120 SPORT JET	1995-97	E095088-E138599	—	—	—
125	1981-89	ALL	18-3030	—	18-3559 □ □
125	1988	C	18-3030	—	—
125 L-DRIVE	1989	N/A	18-3017	18-3251	18-3559
140	1978-80	ALL	18-3030		18-3559
150	1989-92	UP TO E065371	18-3017	18-3251	—
150	1993-UP	E000001-E093699	18-3017	18-3251	—

① Except model "C" for 1988 ② 1989 "D" & "E" models ③ Mercury Lower Unit

CHRYSLER IMPELLER APPLICATION

HP	Model	Year	Serial #	Impeller	Impeller Kit	Thermostat
9.9	9.9	1979-1997	All	18-8903	18-3240	N/A
9.9 / 15	9.9 / 15	1998	E288600 - E344999 ①	18-3062	N/A	N/A
10	10	1974-1978	All	18-8903	18-3240	N/A
12	12	1979	All	18-8903	18-3240	N/A
15	15	1974-1997	All	18-8903	18-3240	N/A
20	20	1973-1978	All	18-8903	18-3240	N/A
20	20	1979-1982	All	18-8901	18-3240	N/A
25	25	1973-1978	All	18-8903	18-3240	N/A
25	25	1996-1998	E127700 - E344999	18-3057	18-3215	18-3556
30	30	1980-1982	All	18-8901	N/A	N/A
35	35	1976-1978	All	18-8901	N/A	18-3556
35	35	1983-1984	All	18-8901	N/A	18-3556
35	35	1986-1988	All	18-8901	N/A	18-3556

① Mercury lower unit ② Except model "c" for 1988 ③ 1989 "D" & "E" models

APPLICATION CONTINUED ON NEXT PAGE

CHRYSLER IMPELLER APPLICATION

HP	Model	Year	Serial #	Impeller	Impeller Kit	Thermostat
35	35	1979-1982	All	18-3084	N/A	18-3556
40 / 50	40 / 50	1992-1994	E065372 - E093669	N/A	N/A	18-3556
40 / 50	40 / 50	1995-1999	E093700 - E369299	18-3057	N/A	18-3556
50	50	1984-1991	N/A	N/A	N/A	18-3556
50	50	1992A	N/A	N/A	N/A	18-3556
70	70	1979-1980	All	18-3085	N/A	18-3559
70	70	1991-1995	E138600 - E345999	18-8900	N/A	N/A
75	75	1979	All	18-3085	N/A	18-3559
75	75	1980	All	18-3030	N/A	18-3559
75	75	1996-1998	E138600 - E345999	18-8900	N/A	N/A
75	75	1999	E345000 & UP	18-3057	N/A	N/A
85	85	1977-1988	All	18-3030	N/A	18-3559
85	85	1989	A, B	18-3030	N/A	18-3559
85	85	1989	C, E	18-3030	N/A	N/A
85	85	1989	D, F, G, H	18-3017	N/A	N/A
85	L-DRIVES	1985	A, B, C	18-3017	N/A	N/A
90	A, B, C, D	1991	E000001 - E039023	18-3017	18-3251	N/A
90	C	1992	E000001 - E039023	18-3017	18-3251	N/A
90	90	1983-1984	ALL	18-3030	N/A	N/A
90	90	1992-1994	E039024 - E093699	18-3017	18-3251	N/A
90	90	1995-1997	E093700 & UP	18-3056	18-3214	N/A
90	90 L-DRIVE	1991	N/A	18-3017	18-3251	N/A
90	90 / 90 L-DRIVE	1990	N/A	18-3017	18-3251	N/A
90	SPORT JET 90	1993-1994	E023150 - E066619	N/A	N/A	N/A
90	SPORT JET 90	1995-1996	E138325 - E138599	N/A	N/A	N/A
95	SPORT JET 95XR	1996-1997	E141089 & UP	N/A	N/A	N/A
100	100	1979-1981	ALL	18-3030	N/A	18-3559
100	100	1983-1984	ALL	18-3030	N/A	N/A
105	105	1977-1978	ALL	18-3030	N/A	18-3559
105	105	1982	ALL	18-3030	N/A	N/A
115	115	1977-1982	ALL	18-3030	N/A	18-3559
120 / 135	120 / 135	1977	ALL	18-3030	N/A	18-3559
120	1990A	1990	N/A	18-3017	18-3251	N/A
120	1991C	1991	N/A	18-3017	18-3251	N/A
120	1991D	1991	E000001 - E093699	18-3017	18-3251	N/A
120	1992C	1992	E000001 - E093699	18-3017	18-3251	N/A
120	1993-1994	1993-1994	E000001 - E093699	18-3017	18-3251	N/A
120	120	1995-1997	E093700 & UP	18-3056	18-3214	N/A
120	120 L-DRIVE	1990-1992	N/A	18-3017	18-3251	N/A
120	120 SPORT JET	1995-1997	E095088 - E138599	N/A	N/A	N/A
125	125	1981-1989	ALL	18-3030	N/A	18-3559 ②③
125	125	1988	C	18-3030	N/A	N/A
125	125 L-DRIVE	1989	N/A	18-3017	18-3251	18-3559
140	140	1978-1982	ALL	18-3030	N/A	18-3559
150	150	1989-1992	UP TO E065371	18-3017	18-3251	N/A
150	150	1993 & UP	E000001 - E093699	18-3017	18-3251	N/A

① Mercury lower unit

② Except model "c" for 1988

③ 1989 "D" & "E" models



FORCE PISTON APPLICATION

HP/Model	Cyl.	Bore Size	Piston	OEM Part #	Rings	OEM Part #
40-50	2	3.312 / STD.	18-4629	700-834794T3, FA691015, 700-F694015	18-39010 ①	39-817869A1, FA663260
40-50	2	3.322 / .010	18-4630	700-834794A4, 700-FSA694015	—	39-817869A2, FSA335260
40-50	2	3.342 / .030	18-4631	700-834794A5, 700-818134A1	—	39-817869A3, 39-818110A1
40-50	2	3.375 / STD	18-4632	700-834800A4, 700-819005A8	18-3998 ①	39-8204757A2, FA528269, FA528260, 39-820457A1, 39-820457A2
40-50	2	3.385 / .010	18-4633	700-834800A5, 700-819005A12, 700-834800A2	18-3999	39-820641A1
40-50	2	3.405 / .030	18-4634	700-834800A6	—	39-818129A2
85-90 & L-DRIVES	3	3.312 / STD.	18-4629	700-834794T3, FA691015	18-39010 ①	39-817869A1, FA663260
85-90 & L-DRIVES	3	3.322 / .010	18-4630	700-834794A4, 700-FSA694015	—	39-817869A2, FSA335260
85-90 & L-DRIVES	3	3.342 / .030	18-4631	700-834794A5, 700-818134A1	—	39-817869A3, 39-818110A1
90 L-DRIVE, SPORT JET	3	3.375 / STD.	18-4632	700-834800A4, 700-819005A8	18-3998 ①	39-8204757A2, FA528269, FA528260, 39-820457A1, 39-820457A2
90 L-DRIVE, SPORT JET	3	3.385 / .010	18-4633	700-834800A5, 700-819005A12, 700-834800A2	18-3999	39-820641A1
90 L-DRIVE, SPORT JET	3	3.405 / .030	18-4634	700-834800A6	—	39-818129A2
120-150	4	3.312 / STD.	18-4629	700-834794T3, FA691015, 700-F694015	18-39010 ①	39-817869A1, FA663260
120-150	4	3.322 / .010	18-4630	700-834794A4, 700-FSA694015	—	39-817869A2, FSA335260
120-150	4	3.342 / .030	18-4631	700-834794A5, 700-818134A1	—	39-817869A3, 39-818110A1
120 L-DRIVE, SPORT JET	4	3.375 / STD.	18-4632	700-834800A4, 700-819005A8	18-3998 ①	39-8204757A2, FA528269, FA528260, 39-820457A1, 39-820457A2
120 L-DRIVE, SPORT JET	4	3.385 / .010	18-4633	700-834800A5, 700-819005A12, 700-834800A2	18-3999	39-820641A1
120 L-DRIVE, SPORT JET	4	3.405 / .030	18-4634	700-834800A6	—	39-818129A2

① Keystone Rings

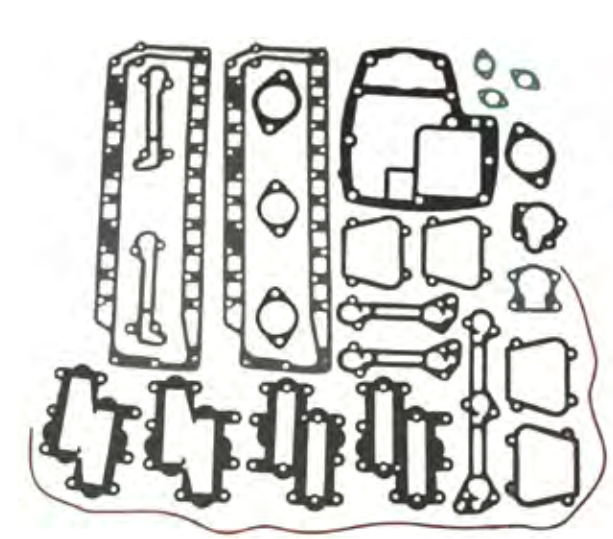

18-4312
POWERHEAD GASKET SET
 Powerhead Gasket Sets Do Not Include Head Gaskets

— CONTAINS —

PART #	GASKET DESC.	O.E. #	QTY.
18-0968	Cyl. Drain Reed Plate	27-F84748-3	2
18-0861	Cyl. Drain Reed Plate	27-F85748-2	1
18-0869	Port Cover Gasket	27-F40223	4
18-0915	Deflector Plate	27-F406406	2
18-0854	Thermostat Cover	27-F476067	1
18-0958	Exhaust Plate	27F-372154	2
18-0960	Carburetor	27-F85906	2
18-0141	By-Pass	27-F85762	2
18-0315	Carburetor	27-F440906	2

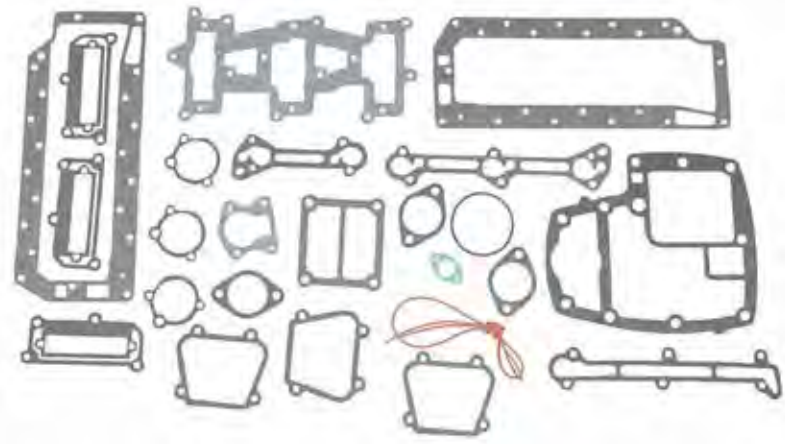

18-4313
POWERHEAD GASKET SET
 Powerhead Gasket Sets Do Not Include Head Gaskets

— CONTAINS —

PART #	GASKET DESC.	O.E. #	QTY.
18-0968	Cyl. Drain Reed Plate	27-F84748-3	1
18-0853	Manifold	27-F85159-1	1
18-0855	Carburetor Adapter Flange	27-F85168-1	3
18-0857	Cyl. Drain Cover	27-F85472-2	1
18-0861	Cyl. Drain Reed Plate	27-F85748-2	1
18-0869	Port Cover	27-F40223	2
18-0854	Thermostat Cover	27-F476067	1
18-0152	Intake	27F-481836	3
18-0119	Exhaust Port Plate	27-F85154	2
18-0114-1	Manifold End Cap	907761	1
18-7108	O-Ring	—	1
18-0960	Carburetor	27-F85906	3
18-0141	By-Pass	27-F85762	2
18-2534	Seal	184122-1	1

CHRYSLER POWERHEAD GASKET SET APPLICATION

HP	Years	Part #	HP	Years	Part #	HP	Years	Part #
45	1972-83 ①	—	85	1970-73, 1977-88	18-4313	120	1971-77	18-4312
50	1981-87	—	90	1974-77	18-4313	125	1983-88 ②	18-4312
55	1972-76 ①	—	100	1979-81, 1983	18-4312	130	1972	18-4312
70	1970-73, 1979-80	18-4313	105	1972-78, 1982	18-4312	135	1974-77	18-4312
75	1974-83	18-4313	115	1977-83	18-4312	140	1978-83	18-4312

① Beginning mid year 1972 All BC, BE, HC & HE Models

② For 1988 A & B Models

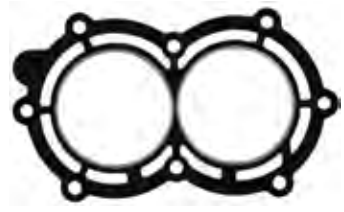

18-3851
HEAD GASKET
 Replaces: 27-F286529-3
 For: 9.9 and 15 HP

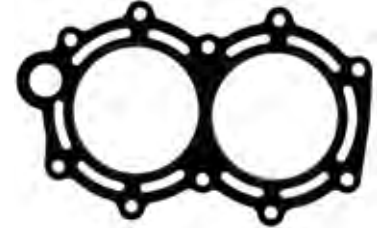

18-3852
HEAD GASKET
 Replaces: 27-F513529
 For: 25 and 35 HP



18-3853
HEAD GASKET
 Replaces: 27-F691529-1
 For: 45 and 50 HP

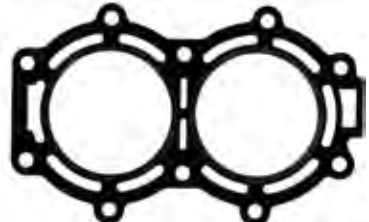

18-3854
HEAD GASKET
 Replaces: 27-F658529
 For: 50 HP



18-3855
HEAD GASKET
 Replaces: 27-820438
 For: 70, 75, 85 and 90 HP

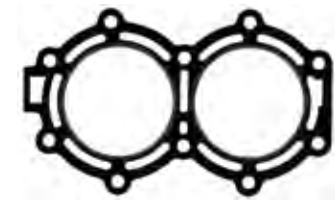

18-3856
HEAD GASKET
 Replaces: 27-F201529-1
 For: 1984-1987 "A" models 50 HP

18-3857

HEAD GASKET

Replaces: 27-824615/27-824615-2, F476529, F476529-1, F476529-2, 27-F476529-4
For: 100 thru 140 H.P.



18-3859

HEAD GASKET

Replaces: 27-819138-2
For: 25 HP (E127700-E344999)







HEAD GASKET APPLICATION



HP	Model/Year	Serial #	Part No.	HP	Model/Year	Serial #	Part No.
9.9/15	1984-92,A,B	N/A	18-3851	90	1990-92,C,E	N/A	18-3855
9.9/15	1992-98	E000001 & UP	18-3851	90	1991-99	E000001 & UP	18-3855
25	1989A,B	N/A	18-3852	90	1990-91 L-DRIVE,A,B,C,D	N/A	18-3855
35	1986-91,A,B,C	N/A	18-3852	90	1993-95 SPORT JET	E023150-E138599	18-3855
40	1992C & 1992-99	E000001 & UP	18-3853	95	1996-97 SPORT JET XR	E141089 & UP	18-3855
50	1990A,1989-92,B,C,D,Z	N/A	18-3853	120	1990-92,A,C	N/A	18-3857
50	1984-87,A	N/A	18-3856	120	1990-99	E000001 & UP	18-3857
50	1988-89,A /1987-88,B,C,D	N/A	18-3854	120	1990-92,A,B,C,D L-DRIVE	N/A	18-3857
70	1991-92,B,C	N/A	18-3855	120	1995-99 SPORT JET,XR,XR2	N/A	18-3857
70	1992-95	E000001 & UP	18-3855	125	1983-89, A	N/A	18-3857
75	1996-99	E138600 & UP	18-3855	125	1986-89, B	N/A	18-3857
85	1984-89,A,L /1986-89,B,C,	N/A	18-3855	125	1988-89, C	N/A	18-3857
85	1986,M,N	N/A	18-3855	125	1989, D, E	N/A	18-3857
85	1985 L-DRIVE A,B,C	N/A	18-3855	150	1989A-1992C		N/A
85	1989,D,E,F,G,H	N/A	18-3855	150	1989-1994	E000001-E093699	N/A
90	1990-91,A,B,D	N/A	18-3855				

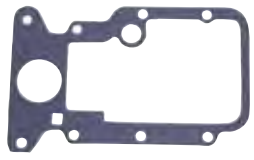



<p>PKG. OF 2</p> <p>18-0141 18-0141-9^① BYPASS GASKET Replaces: 27-F85762</p>	<p>PKG. OF 2</p> <p>18-0152 18-0152-9^① INTAKE GASKET Replaces: 27-F481836</p>	<p>PKG. OF 2</p> <p>18-0315 18-0315-9^① CARBURETOR GASKET Replaces: 27-F440906</p>	<p>PKG. OF 2</p> <p>18-0960 18-0960-9^① CARBURETOR MOUNTING GASKET Replaces: 27-F85906</p>
<p>18-0314 CARBURETOR ADAPTER GASKET Replaces: 27-828316, 27-F178168, 27-F178168-1, F178168</p>	<p>PKG. OF 2</p> <p>18-0855 18-0855-9^① CARBURETOR ADAPTER FLANGE GASKET Replaces: 27-F85168-2</p>	<p>PKG. OF 2</p> <p>18-0915 DEFLECTOR PLATE GASKET Replaces: 27-F406406</p>	<p>18-0861 CYLINDER DRAIN REED PLATE GASKET Replaces: 27-F85748-2</p>
<p>PKG. OF 2</p> <p>18-0119 18-0119-9^① EXHAUST PLATE GASKET Replaces: 27-F85154-1</p>	<p>18-0958 EXHAUST PLATE GASKET Replaces: 27-F372154-1</p>	<p>PKG. OF 2</p> <p>18-0869 18-0869-9^① PORT COVER GASKET Replaces: 27-F40223, 27-820500A3</p>	<p>PKG. OF 2</p> <p>18-0115 18-0115-9^① POWERHEAD BASE GASKET Replaces: 27-F307279-2</p>

SEE PAGES 201-202 FOR OUR COMPLETE LINE OF GASKET SEALANTS

① Priced per Package

 <p>18-0154 LOWER EXHAUST CYLINDER GASKET Replaces: 27-F40279-1</p>	<p>PKG. OF 2</p>  <p>18-0854 18-0854-9① THERMOSTAT COVER GASKET Replaces: 27-F476067</p>	<p>PKG. OF 2</p>  <p>18-0873 18-0873-9① THERMOSTAT GASKET Replaces: 27-F97067, 27-819377</p>	 <p>18-0622 LOWER WEAR PLATE GASKET Replaces: 27-19701</p>
--	--	--	---

<p>PKG. OF 2</p>  <p>18-0415 18-0415-9① WATER PUMP GASKET Replaces: 27-F523031</p>	<p>PKG. OF 2</p>  <p>18-0416 WEAR PLATE GASKET Replaces: 27-F694830</p>	 <p>18-0417 18-0417-9① WATER PUMP GASKET Replaces: 27-F84031</p>
--	--	--

<p>PKG. OF 2</p>  <p>18-2534 SEAL (40") Replaces: F184122-1</p>	 <p>18-2370 BEARING CARRIER Replaces: 19291A3 For: Force 40/50 HP (1995-99), 70 HP (1991-95), 75 HP (1996-98), Mercury/Mariner 30/40 HP 2 cyl (9854537-OP016999), 30/40 4-stroke (OG760300-up), 40/50 HP/30Jet 3 cyl (9973100-up), 60 HP 3 cyl (OD000750-up), 60 HP 4-stroke 9973100-up)</p>	<p>①18-2375D </p>  <p>18-2375 DRAIN PLUG (MAGNET) 18-23751-9① (Package of 50 without gasket)</p>
---	--	--

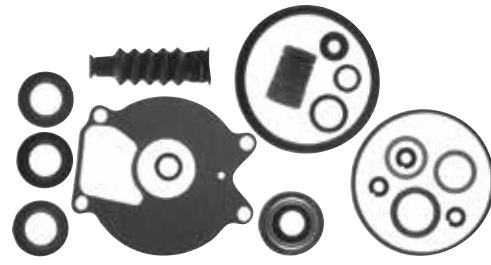
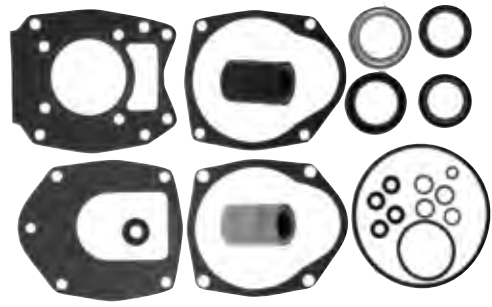
 <p>18-2624 LOWER UNIT SEAL KIT Replaces: 26-85090A2</p> <p>— CONTAINS —</p>	 <p>18-2626 LOWER UNIT SEAL KIT Replaces: 26-43035A4</p> <p>— CONTAINS —</p>
---	--

PART #	DESC.	O.E. #	QTY.	PART #	DESC.	O.E. #	QTY.
18-0579	Oil Seal	26-41131	1	18-0522	Oil Seal	26-43036	1
18-0580	Oil Seal	26-41132	1	18-0583	Oil Seal	26-43035	1
18-0586	Seal	26-99325	2	18-2002	Oil Seal	26-76868	1
18-7419	O-Ring	25-69202	1	18-2053	Oil Seal	26-70081	1
18-2562	Gear Hsg to Face Plate Gasket	27-99326-1	1	18-2054	Oil Seal	26-816464	1
18-2945	Washer	12-20260	2	18-2563	Face Plate to Water Pump Cover Gasket	27-43034-1	1
18-2742	Boot	85552	1	18-2564	Water Pump Base to Face Plate Gasket	27-43033-1	1
18-2560	Washer	12-86645	2	18-2565	Water Pump Base to Gear Hsg Gasket	27-43047-2	1
18-7135	O-Ring	25-35276	1	18-2566	Face Plate to Water Pump Cover Gasket	27-817277	1
18-7956	O-Ring	25-85549	1	18-2945	Washer	12-19183	3
18-7100	O-Ring	25-85594	1	18-4261	Washer	19643	1
18-7959	O-Ring	25-99691	1	18-7198	O-Ring	25-45710	1

SEE PAGES 201-202 FOR OUR COMPLETE LINE OF GASKET SEALANTS

① Priced per Package

APPLICATION FOR SEAL KITS ON PAGE 238



18-2629
LOWER UNIT SEAL KIT
 Replaces: 26-85090A1



18-2630
LOWER UNIT SEAL KIT
 Replaces: FK1060



18-2631
LOWER UNIT SEAL KIT
 Replaces: FK1061



18-2632
LOWER UNIT SEAL KIT
 Replaces: FK1063-2, FK1063-1
 — CONTAINS —

PART #	DESC.	O.E. #	QTY.
18-2244	Washer	10-79953A2	3
18-7127	O-Ring	25-F84305	1
18-0500	Seal	26-817472	1
18-0512	Seal	26-F84307-1	1
18-7169	O-Ring	25-F24278	1
18-7176	O-Ring	25-90011	1
18-7467	O-Ring	25-54030	1
18-7141	O-Ring	802047	1



18-2633
LOWER UNIT SEAL KIT
 Replaces: FK1127



18-2635
LOWER UNIT SEAL KIT
 Replaces: 26-814669A2, 26-814669A1, FK1234
 — CONTAINS —

PART #	DESC.	O.E. #	QTY.
18-0500	Seal	26-817472	1
18-0622	Lower Wear Plate Gasket	27-19701	1
18-2051	Seal	26-69188	1
18-2052	Seal	26-69189	1
18-2945	Washer	12-19183	3
18-7168	O-Ring	25-48171	2
18-7173	O-Ring	25-30224	1
18-7950	O-Ring	25-45258	1

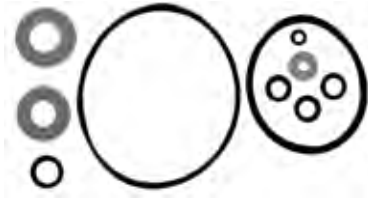

18-2636
LOWER UNIT SEAL KIT
 Replaces: 26-820645A, FK1074
 — CONTAINS —

PART #	DESC.	O.E. #	QTY.
18-0500	Seal	26-817472	1
18-0502	Seal	26-819396	1
18-0503	Seal	26-F40307-2	1
18-2945	Washer	12-19183	2
18-7116	O-Ring	25-62704	1
18-7134	O-Ring	25-F40342	1
18-7141	O-Ring	25-25007	1
18-7952	O-Ring	25-88657	1

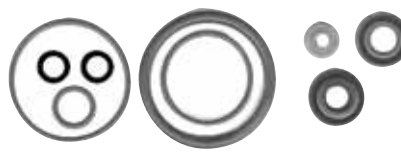

18-2637-1
LOWER UNIT SEAL KIT
 Replaces: FK1064
 — CONTAINS —

PART #	DESC.	O.E. #	QTY.
18-0500	Seal	26-817472	1
18-0592	Seal	26-F318307	1
18-2945	Washer	12-19183	2
18-7149	O-Ring	25-525555	1
18-7171	O-Ring	25-F525305	1
18-7191	O-Ring	25-F474342	1



18-2638
LOWER UNIT SEAL KIT
 Replaces: FK1065
 — CONTAINS —

PART #	DESC.	O.E. #	QTY.
18-0500	Seal	26-817472	1
18-0584	Seal	26-66022, 26-F346118	1
18-0593	Seal	26-F901307-2	2
18-0623	Lower Unit Gasket	27-F286555	1
18-2945	Washer	12-19183	3
18-7138	O-Ring	25-F455305	1

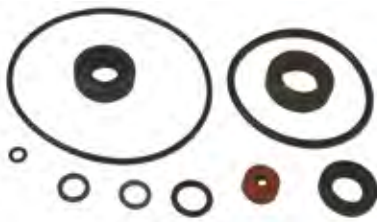

18-2639
LOWER UNIT SEAL KIT
 Replaces: FK1068
 — CONTAINS —

PART #	DESC.	O.E. #	QTY.
18-0584	Seal	26-66022	1
18-2945	Washer	12-19183	2
18-7134	O-Ring	25-F498618	1
18-7141	O-Ring	25-25007	1
18-7176	O-Ring	25-90011	1

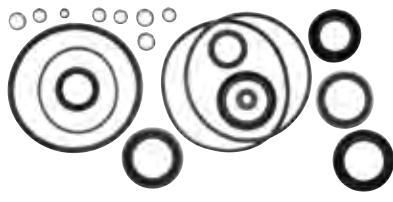

18-2640
LOWER UNIT SEAL KIT
 Replaces: FK1203-1, FK1203
 — CONTAINS —

PART #	DESC.	O.E. #	QTY.
18-0500	Seal	26-817472	1
18-2014	Seal	26-F694305	1
18-2076	Seal	26-12224	1
18-2077	Seal	26-14077	1
18-2945	Washer	12-19183	3
18-7426	Grommet	25-30271	1
18-7127	O-Ring	25-F84305	1
18-7134	O-Ring	25-F498618	1
18-7169	O-Ring	25-F24278	1
18-7176	O-Ring	25-F74305	1
18-7413	O-Ring	25-62702	4



18-2697-1
LOWER UNIT SEAL KIT
 Replaces: 26-41365A3
 — CONTAINS —

PART #	DESC.	O.E. #	QTY.
18-0581	Oil Seal	26-413651	2
18-0584	Oil Seal	26-66022	1
18-0585	Oil Seal	26-821928	1
18-0586	Oil Seal	26-99325	1
18-2728	Water Tube Seal	26-42102-1	1
18-2945	Washer	12-19183	2
18-3149-2	Water Pump Base	46-42040A5	1
18-4261	Washer	19643	1
18-7162	O-Ring	25-33145	1

APPLICATION ON NEXT PAGE

CHRYSLER/FORCE LOWER UNIT SEAL KIT APPLICATION

Model / HP	Year	Seal Kit	Model / HP	Year	Seal Kit	Model / HP	Year	Seal Kit
6/7.5	1978-Up	18-2637	55	1972 1/2-1974	18-2636	85 L Drive	1989	18-2640
9.9/15	1997 & prior	18-2638	55 ②	1978-82	18-2630	90	1974-77	18-2631
9.9/15	1998	18-2697-1	55 ①	1983	18-2633	90	1983	18-2632
20/25	1972-78	18-2639	60 ②	1984 & Prior	18-2630	90	1990-94	18-2640
25	1989	18-2636	60 ①	1985	18-2633	90	1995-99	18-2626
25	1996-97	18-2624	65 ①	All	18-2633	90 L Drive	1990-91	18-2640
25	1998	18-2629	70	1970-73	18-2631	105	1970-76	18-2631
35	1970-72	18-2630	70	1979	18-2631	105	1979-83	18-2632
35	1972 1/2	18-2636	70	1991-95	18-2635	120	1990-94	18-2640
35	1973	18-2630	75	1975-79	18-2631	120	1995-99	18-2626
35	1974-75	18-2636	75	1980-83	18-2632	125 ③	1983-89	18-2632
35	1986-91	18-2639	75	1996-98	18-2635	125 D & E	1989	18-2640
35 B	1989-91	18-2636	75	1999	18-2626	125 L Drive	1989	18-2640
40	1992-94	18-2636	85	1980-89	18-2632	150	1989-94	18-2640
50	1984-94	18-2636	① With one piece lower units			② With two piece lower units		③ 1989 A,B,C Models Only



©18-3701D Display Package

**18-3701
PROP NUT KIT**

— CONTAINS —

Part #	O.E. #	Description	QTY.
18-3200	F697140	Tab Washer	2
18-3700	F7000	Prop Nut	1



**18-4446
PROP WRENCH KIT
(18-4444 Wrench Only)**

— CONTAINS —

Part #	Desc.	QTY.
18-3200	Tab Washer	2
18-3700	Prop Nut	1
18-4444	Prop Wrench	1

PROP NUT & TAB WASHER APPLICATION

HP	Year	Model Type	Tab Washer	Prop Nut	Prop Nut Kit
90 ④	1990	A	—	18-3700	—
90	1990	B, C	18-3200	18-3700	18-3701
90	1991	ALL	18-3200	18-3700	18-3701
90 L-Drive	1990	C	18-3200	18-3700	18-3701
90 L-Drive	1991	ALL	18-3200	18-3700	18-3701
120	1990	A	—	18-3700	—
120	1990	B,C	18-3200	18-3700	18-3701
120	1991	ALL	18-3200	18-3700	18-3701
120 L-Drive	1990	ALL	18-3200	18-3700	18-3701
120 L-Drive	1991	B,D	18-3200	18-3700	18-3701
125 L-Drive	1989	ALL	—	18-3700	—
150	1989	ALL	—	18-3700	—
150	1990	A	—	18-3700	—
150	1990	B, C, D	18-3200	18-3700	18-3701
150	1991	ALL	18-3200	18-3700	18-3701

④ 903F90A, X90A, 908F90A, X90A Models only.

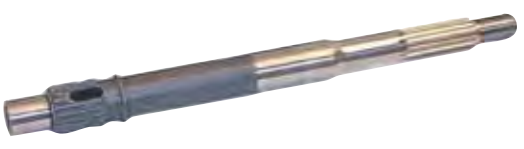

**18-2254
PROP SHAFT**
Replaces: 44-850308



**18-3719
PINION NUT**
Replaces: 11-35921, 11-47411,
11-826375, 11-F694188
5/8" - 18 thread • 1 1/16" wrench

18-1112
REVERSE GEAR
THRUST BEARING
 Replaces: 31-F523901



18-1113
REVERSE GEAR BEARING
 Replaces: 31-F523143

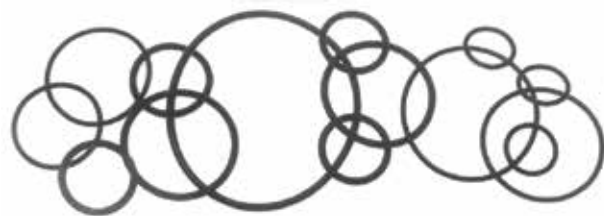

O-RINGS

Part No.	O.E. No.	Dimensions	
		I.D.	Width
18-7120	25-F498618	0.215	0.065
18-7127	25-F84305, 25-32507, F83404	3.315	0.135
18-7134 ●⑦	25-20195, 25-201951	0.5	0.1
18-7169 ●⑦	25-F24278	3.5	0.135
18-7176 ●⑦	25-F74305	2.16	0.1
18-7457	25-F455305	1.799	0.103
18-7950	25-45258	9.843	0.984
18-7952 ●⑦	25-88657	2.4803	0.1378
18-7956 ●⑦	25-85549	2.4803	0.1969
18-7100 ●⑦	25-85594	0.2362	0.1575

● PKG OF 5



18-79989
TRAILERING STICKS
 Fits: Most outboards over 150hp with three ram
 intrigrel tilt/trim.



OIL SEALS

Part No.	O.E. No.	Part No.	O.E. No.	Part No.	O.E. No.
18-0500	26-817472	18-0580	26-41132	18-0593	26-F901307-2
18-0502	26-819396	18-0583	26-43035	18-8347	26-8164641, 26-816464, 26-76384
18-0503	26-F40307-2	18-0584	26-66022, 26-F346118	18-8354	26-828627
18-0512	26-F84307-1	18-0586	26-99325		
18-0579	26-41131	18-0592	26-F318307		

**THE VERY BEST
 PARTS OF BOATING**



Honda Model Number Identification

BF2	Manufacturer	Horse-power	Model Year	Shaft Length	Steering System	Market
	BF = Honda	EX: 2	DX = 1999 DY = 2000 D1 = 2001 D2 = 2002 D3 = 2003 D4 = 2004 D5 = 2005 D6 = 2006 DK0 = 2007-up	S = 15" L = 20"	H = Throttle Grip C = Centrifugal Clutch	A = American

EXAMPLE: BF2D1SCHA = Honda, 2 HP, 2001 Model, 15", Centrifugal Clutch w/Throttle Grip, American

BF5- BF20	Manufacturer	Special Features	Horse-power	Model Year	Shaft Length	Steering System	Starter	Market
	BF = Honda	P = High Thrust Propeller = Standard Propeller	EX: 5 20	D1 = 2001 D2 = 2002 D3 = 2003 D4 = 2004 D5 = 2005 D6 = 2006 DK0 = 2007-up	S = 15" L = 20" XL = 25"	H = Throttle Grip C = Centrifugal Clutch	S = Electric = Manual T = Electric w/ Power Tilt	A = American

EXAMPLE: BFP5D1LHSA = Honda, High Thrust Prop., 5 HP, 2001 Model, 20", Throttle Grip, Elec. Start, American

BF25- BF225	Manufacturer	Horse-power	Model Year	Shaft Length	Steering System	Tilt & Trim	Market
	BF = Honda	EX: 25 115 225	AX = 1999 AY = 2000 A1 = 2001 A2 = 2002 A3 = 2003 A4 = 2004 A5 = 2005 A6 = 2006 K0 = 2007-up	S = 15" L = 20" X = 25" XX = 30"	R = Remote Control H = Tiller Handle	T = Tilt & Trim = Manual Tilt J = Jet Drive	A = American

EXAMPLE: BF25A1LRTA = Honda, 25 HP, 2001 Model, 20", Remote Control, Tilt & Trim, American

NOTE: After the 2006 model year Honda Marine dropped specific year designations.

 18-7494 COIL Replaces: 30520-PNA-007 Fits: 130/ 135/ 150/ 105 jet/ & 150 HP VTEC 1998-2007	 18-23251 IGNITION COIL Replaces: 30520-PWC-003 Fits: BF75(2007 & Up), BF90(2007 & Up)	 PKG. OF 10 18-5224 18-5224-9① SPARK PLUG WIRE TERMINAL
---	--	--

 18-5225 SPARK PLUG WIRE KIT Kit includes 25 ft. Roll of 7 MM Hypalon Ignition Wire With a Metallic Core and a Large Assortment of Three Different End Fittings to Fit Outboard Motors.	 18-5226 IGNITION WIRE Metallic Core 100' Spool 7mm Hypalon	 PKG. OF 10 18-5750 18-5750-9① UNIVERSAL SPARK PLUG BOOTS Supplied complete with Terminal Connector	 18-5752 UNIVERSAL SPARK PLUG BOOT (8mm)
--	---	---	--

 18-6475 ALTERNATOR Replaces: 31630-ZW5-003 Fits: BF115 (1999 & Up), BF130 (1999-2004)	 18-6476 ALTERNATOR Replaces: 31630-ZY6-003 Fits: BF135 & BF150 (2004 & Up)	 18-6433 OUTBOARD STARTER Replaces: 31200-ZV5-013 Fits: 40 H.P. (1999-UP)
---	--	--

① Priced per Package



18-6445
STARTER
Replaces: Honda 31200-ZW9-802
Fits: 8 & 9.9HP (2001 & Up)



18-6959
STARTER
Replaces: 31200-ZY6-003, 31200-ZY9-003,
31200-ZY9A-0031
Fits: 75-150HP 2004-2010



18-15061
OUTBOARD STARTER
Replaces: 31200-ZW1-004
Fits: BF75-90(1997-06)



18-6258
TILT/TRIM MOTOR
Replaces: 36120-ZV5-821
Fits: BF35,BF40,BF45,BF50 (1992-2002)



18-6742
TRIM MOTOR
Replaces: 36120-ZY3-023
Fits: 200-225 HP (02-Up), 175 HP (07-Up)



18-6743
TRIM MOTOR
Replaces: 36120-ZY9-003
Fits: 75-90 HP (07-Up)



18-6745
TRIM MOTOR
Replaces: 36120-ZY6-013
Fits: 135-150 HP (04-Up), 115 HP (07-Up)



18-6793
TRIM MOTOR
Replaces: 36120-ZV5-822
Fits: 40,50 H.P. (2002-03)

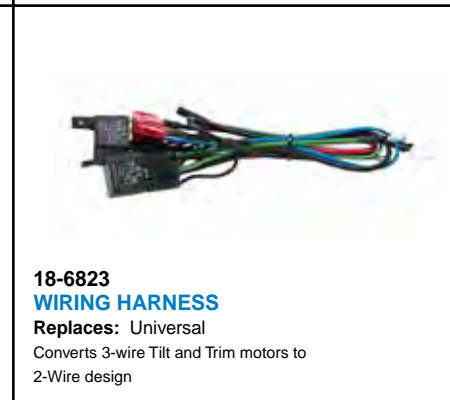

18-6823
WIRING HARNESS
Replaces: Universal
Converts 3-wire Tilt and Trim motors to
2-Wire design

FUEL WATER SEPARATORS



Sierra offers a complete line of 10 and 21 micron fuel water separating filters including drainable bowl filters to protect your carbureted and fuel injected engine.

Refer to pages 136-140 for a complete listing of OEM and universal applications.

Sierra fuel water separators remove over 99.8% of emulsified water from your gasoline. Sierra's 10 micron filters are over 90% efficient at removing particles as small as 10 micron. All filters flow @ 90 GPH to feed even the hungriest motor. Sierra 10 micron filters are recommended to prevent damage to sensitive inboard and outboard fuel injection systems.

Sierra #	Honda #	Description
18-7947	17670-ZW1-030GH	Spin on Replacement Filter
18-7948	17670-ZW1-801AH	Spin on Replacement Filter
18-7720	16900-SR3-004	Fuel Filter
18-7786	16900-SA5-004	Fuel Filter Kit
18-7785	16010-ST5-993	Fuel Filter Kit

9' LENGTH COMPLETE FUEL LINE ASSEMBLIES



3/8"
FUEL LINE ASSEMBLY

18-81042EP-2 *SILVERADO 4000 Premium*

OE# 17700-ZW9-010
17700-ZW9-020



*



18-80400
TANK CONNECTOR
(SOLD SEPARATELY)



18-80401
FUEL CONNECTOR

18-8005EP-1
PRIMER BULB

18-80403
FUEL CONNECTOR



*

FUEL LINE ASSEMBLY COMPONENTS

Honda Fuel Application: 8, 9.9, 15, 25, 30, 40, 50, 75, 90, 115, 130 HP (2001-02)

* Tanks and Engines for picture purpose only.



18-8002EP-1
18-8002EP-1-10①
PRIMER BULB
1/4"

18-8004EP-1
18-8004EP-1-10①
PRIMER BULB
5/16"
Large capacity bulb

18-8005EP-1
18-8005EP-1-10①
PRIMER BULB
3/8"
Replaces: 174512
Large capacity bulb



18-38008
FUEL CONNECTOR
Replaces: 17660-ZV5-902
Fits: 3/8" hose barb, Use with 18-80406



18-80401
FUEL CONNECTOR
Female hose connector, new style, 3/8" hose. Will not interchange with OE's 5/16" hose assemblies.
Mates with **18-80400**, tank outlet



18-80403
FUEL CONNECTOR
Female 3/8 hose connector with rectangular locking post. Will not interchange with OE's 5/16" hose assemblies. For late model engine: For use with our 18-81042 fuel hose assembly, motor end.
Mates with **18-80407**



18-80400
TANK CONNECTOR
Replaces: 16977-ZV5-A00
Male tank outlet, new style, 1/4"NPT, nickel plated brass. Male connector, for fuel tank.
Mates with **18-80401**



18-80406
FUEL CONNECTOR
Replaces: 16977-ZV5-900
Male tank outlet, old style, 1/4" NPT.



18-80407
FUEL CONNECTOR
Replaces: 17710-ZW9-033
5/16" with interlocking post
Fits: BF8-BF130 (2003)
Mates with **18-80403, 18-80408**



18-80408
FUEL CONNECTOR
Replaces: 17650-ZW9-003
Female 5/16" connector with rectangular locking post. Fits late model engine
Mates with **18-80407**



18-80420
FUEL CONNECTOR
Replaces: 17650-921-003ZB
Fits: BF5/BF8A 2001 and earlier
Mates with 17710-881-00ZA

FUEL FILTERS



Part No.	OE No.
18-7712	16910-GB2-005
18-8226 •	16910-ZV4-015

• Retail Packaged Item



18-79908
FUEL FILTER
Replaces: 16911-ZY3-010
Fits: BF90(2007 & Up), BF115(1997 & Below, 2002 & Up), BF130(2002-04), BF135(2004 & Up), BF150(2004 & Up), BF175(2007 & Up), BF200(2002 & Up), BF225(2002 & Up), BF250(1997 & Below)



18-79909
FUEL FILTER
Replaces: 16901-ZY3-003
Fits: BF115D LA, BF115D XA, BF115D XCA, BF115DK1 LA, BF115DK1 XA, BF115DK1 XCA, BF135A4 LA, BF135A4 XA, BF135A4 XCA, BF135A5 LA, BF135A5 XA, BF135A5 XCA, BF135A6 LA, BF135A6 XA, BF135A6 XCA, BF135AK0 LA, BF135AK0 XA, BF135AK0 XCA, BF135AK2 LA, BF135AK2 XA, BF135AK2 XCA, BF150A4 LA, BF150 4 XA, BF150A4 XCA, BF150A5 LA, BF150A5 XA, BF150A5 XCA, BF150A6 LA, BF150A6 XA, BF150A6 XCA, BF150AK0 LA, BF150AK0 XA, BF150AK0 XCA, BF175AK1 LA, BF175AK1 XA, BF175AK1 XCA, BF175AK2 LA, BF175AK2 XA, BF175AK2 XCA, BF200A2 LA, BF200A2 XA, BF200A2 XCA, BF200A3 XA, BF200A3 XCA, BF200A3 XXA, BF200A3 XXCA, BF200A4 LA, BF200A4 XA, BF200A4 XCA, BF200A4 XXA, BF200A4 XXCA, BF200A5 LA, BF200A5 XA, BF200A5 XCA, BF200A5 XXA, BF200A6 LA, BF200A6 XA, BF200A6 XCA, BF200A6 XXA, BF200AK0 LA, BF200AK0 XA, BF200AK0 XCA, BF200AK1 LA, BF200 AK1 XA, BF200AK1 XCA, BF200AK2 LA, BF200AK2 XA, BF200AK2 XCA



18-7599
FUEL LOCK
Protect your outboard from theft, disconnect fuel line and simply install fuel lock. Designed to fit clip on style fuel connectors. Fits: Johnson Evinrude, Mercury/Mariner, Yamaha and Honda.



18-7657
OXYGEN SENSOR
Replaces: 35655-ZY3-013



18-7658
OXYGEN SENSOR
Replaces: 35655-ZY9-003



18-7659
OXYGEN SENSOR
Replaces: 35668-ZY6-003



18-32153
OXYGEN SENSOR
Replaces: 35655-ZY3-C01, 35655-ZZ5-004
Fits: BF40D, BF50D, BF250A (1997 & Prior), BF40DK2, BF50DK2, BF225AK1, BF225AK2 (2007 & Up)



18-25200
CAMSHAFT SENSOR
Replaces: 37500-PNB-003
Fits: 75 hp MFI



18-25201
CAMSHAFT SENSOR
Replaces: 37510-PNB-003
Fits: BF5 (2007 & Up), BF135 (2004 & Up), BF150 (2004 & Up)



18-7552
SENSOR, MAP
Replaces: 37830-PGK-A01
Fits: BF135A 2004-2006, BF135AK0, BF150A 2004-2006, BF150AK0, BF200A 2002-2006, BF200AK0, BF225A 2002-2006, BF225AK0



18-7558
SENSOR, KNOCK
Replaces: 30530-PPL-A01
Fits: BF135A 2004-2006, BF150 2004-2006



18-7559
SENSOR, KNOCK
Replaces: 30530-P8F-A01
Fits: BF200A 2002-2006, BF200AK0, BF225 2002-2006, BF225AK0



18-7050
CARB KIT
Fits: BF9.9(2000 & below), BF15(2002 & below)



18-7051
CARB KIT
Fits: BF9.9(2001 & Up), BF15(2003 & Up)



18-7052
CARB KIT
Fits: BF75(1997 & Up), BF90(1997 & Up)



18-7053
CARB KIT
Fits: BF8(1996 & below)BF75(1996 & below), BF100(1996 & below)



18-7047
NEEDLE VALVE
Replaces: 16011-ZV4-005
Fits: BF8(2001 & Up), BF9.9(All), BF15(All), BF20(2003 & Up), BF25(All), BF30(All), BF35(1997), BF40(All), BF45(1997), BF50(All), BF75(1997 & Up), BF90(1997 & Up)



18-7048
NEEDLE VALVE
Replaces: 16011-881-741
Fits: BF5(2003 & below), BF8(All), BF75(1997 & below), BF100(1997 & below)



18-3627
THERMOSTAT
Replaces: 19300-881-761
For: BF5A1, BF5A2, BF5A3, BF5A4, BF5A5, BF5A6, BF5AH, BF5AK, BF5AK0, BF5AM, BF5AW, BF5AX, BF5AY, BF8A3, BF8A4, BF8A5, BF8A6, BF8AH, BF8AK, BF8AK0, BF8AM, BF8AW, BF8AX, BF8AY, BF9.9AH, BF9.9AK, BF9.9AM, BF9.9AW, BF9.9AX, BF9.9AY, BF15A1, BF15A2, BF15AH, BF15AK, BF15AM, BF15AW, BF15AX, BF15AY, BF50F, BF75E, BF75F, BF100E, BF100F
52°C



18-3628-1
THERMOSTAT
Replaces: 19300-ZW9-003
For: BF8D1, BF8D2, BF8D3BF15D3, BF15D4, BF15D5, BF15D6, BF15DK0, BF20D3, BF20D4, BF20D5, BF20D6, BF20DK0, BF25D4, BF25D5, BF25D6, BF25DK0, BF30D4, BF30D5, BF30D6, BF30DK0, BF40A4, BF40A5, BF40A6, BF40AK0, BF40D, BF50A4, BF50A5, BF50A6, BF50AK0, BF50D, BF60A, BFP60A, BF75DK0, BF90DK0, BF200A2, BF225A2
60°C



18-3629
THERMOSTAT
Replaces: 19300-881-741, 19300-921-003
For: BF8AM, BF8AW, BF8AX, BF8AY, BF8A3, BF8A4, BF8A5, BF8A6, BF8AK0, BF75, BF75A, BF75B, BF75C, BF75D, BF75E, BF75F, BF75K1, BF75K2, BF75K3, BF75Z, BF100, BF100A, BF100B, BF100C, BF100D, BF100E, BF100F, BF100Z
62°C

① Discount shop pack of 10 - Priced per package



18-3630
THERMOSTAT

Replaces: 19300-ZV5-043
For: BF25A, BF25A1, BF25A2, BF25A3, BF25AW, BF25AX, BF25AY, BF30A, BF30A1, BF30A2, BF30A3, BF30AW, BF30AX, BF30AY, BF35AM, BF40A, BF40A1, BF40A2, BF40A3, BF40AW, BF40AX, BF40AY, BF45AM, BF50A, BF50A1, BF50A2, BF50A3, BF50AW, BF50AX, BF50AY, BF75A1, BF75A2, BF75A3, BF75A4, BF75A6, BF75AT, BF75AW, BF75AX, BF75AY, BF90A1, BF115A1, BF115A2, BF115AX, BF115AY, BF130A1, BF130A2, BF130AX, BF130AY
72°C



18-3031
IMPELLER

Replaces: 19210-ZY3-003
Fits: BF200 & BF225 (2002 & Up)



18-3100
IMPELLER

Replaces: 19210-ZW9-013, 19210-ZW9-003
Fits: BF8D/9.9D short, long shaft



18-3056
18-3056-10②
IMPELLER

Replaces: 19210-ZW1-003
For: 75-90 HP



18-3245
IMPELLER

Replaces: 19210-881-A01, 19210-881-A02, 19210-ZW9-A02
For: 5, 7.5, 8, 10 HP



18-32455
IMPELLER

Replaces: 19210-ZW9-A32, 19210-ZW9-A31
For: Honda 8 & 9.9 (2001 & Up); Honda 15 & 20 (2003 & Up)



18-3246
IMPELLER

Replaces: 19210-ZV4-013, 19210-ZV4-651
For: BF9.9, BF15, AH, AK, AM, AW Series # 14ZV40M



18-3247
IMPELLER

Replaces: 19210-ZV4-651
For: 8, 9.9, 15 HP



18-3248
IMPELLER

Replaces: 19210-ZV5-003
For: 35, 40, 45, 50 HP



18-3249
IMPELLER

Replaces: 19210-ZV7-003
For: 25, 30 HP



18-3250
IMPELLER

Replaces: 19210-ZW1-B04
For: 75, 90, 115, 130 HP



18-3122
IMPELLER PLATE

Replaces: 19231-ZW1-003
For: 75-90 HP



18-3268
IMPELLER KEY

Replaces: 90752-ZV4-650
Fits: BF9.9A, BF15A



18-3269
IMPELLER KEY

Replaces: 90752-ZV7-000
Fits: BF25, BF30



18-3270
IMPELLER KEY

Replaces: 90752-ZV5-003
Fits: BF35, BF40, BF45, BF50



18-3271
IMPELLER KEY

Replaces: 90752-ZW1-B02
Fits: BF75-BF90 AX & Up, BF115, BF130



18-3273
IMPELLER KEY

Replaces: 90752-ZY3-003
Fits: BF200, BF225



18-3187
IMPELLER REPAIR KIT

Replaces: 06192-ZW1-305
Fits: BF75-90, (1996-98)
Includes impeller 18-3056



18-3214
WATER PUMP KIT

Replaces: 19021-ZW1-003
For: BF 70/BF 90 1996-98
Includes impeller 18-3056





18-3278
WATER PUMP SERVICE KIT
Replaces: 06192-ZV1-C00
Fits: BF5
 Includes impeller **18-3245**



18-3279
WATER PUMP SERVICE KIT
Replaces: 06192-881-C00
Fits: BF8A (USA)
 Includes impeller **18-3245**



18-3280
WATER PUMP SERVICE KIT
Replaces: 06192-ZV4-000
Fits: BF9.9A/BF15A
 Includes impeller **18-3247**



18-3281
WATER PUMP SERVICE KIT
Replaces: 06192-ZV7-000
Fits: BF25/30
 Includes impeller **18-3249**



18-3282
WATER PUMP SERVICE KIT
Replaces: 06192-ZV5-003
Fits: BF35/45, BF40/50
 Includes impeller **18-3248**

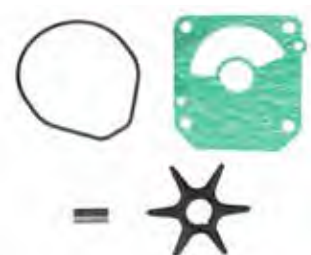

18-3283
WATER PUMP SERVICE KIT
Replaces: 06192-ZW1-000
Fits: BF115/130, BF75/90 AX & Later
 Includes impeller **18-3250**



18-3284
WATER PUMP SERVICE KIT
Replaces: 06192-ZY6-000
Fits: BF135 / BF150
 Includes impeller **18-3250**



18-3285
WATER PUMP SERVICE KIT
Replaces: 06192-ZY3-000
Fits: BF200/225
 Includes impeller **18-3031**



18-3478
WATER PUMP REPAIR KIT
 Without Housing
Replaces: 06192-ZW9-A30
Fits: BFP8D/BFP9.9D (2003-06), BF15D/BF20D (2003-06), BFP20D (2004-06), BFP8D/BFP9.9D/BF15D/BFP15D/BF20D (K0, K2, K3), BFP20D (K0)
 — CONTAINS —

Part #	Desc.	O.E.#	Qty.
18-32455	Impeller	19210-ZW9-A32	1
18-99153	Gasket, Water Pump	19232-ZW9-000	1
18-71335	O-Ring	91301-ZG3-000	1
18-3025	Key, Impeller	90752-ZW9-A30	1



18-3489
WATER PUMP REPAIR KIT
 Without Housing
Replaces: 06192-ZX2-C00
Fits: BF250A (ALL)
 — CONTAINS —

Part #	Desc.	O.E.#	Qty.
18-3031	Impeller	19210-ZY3-003	1
18-99154	Gasket, Water Pump	19234-ZX2-C00	1
18-8299	O-Ring	91356-ZY3-003	1
18-3273	Key, Impeller	90752-ZY3-003	1



18-3492
WATER PUMP REPAIR KIT
 Without Housing
Replaces: 06192-ZW1-B03
Fits: BF75A/BF90A/BF115A/BF130A (1999-02)
 — CONTAINS —

Part #	Desc.	O.E.#	Qty.
18-3250	Impeller	19210-ZW1-B04	1
18-0481	Gasket, Water Pump	19234-ZW1-B00	1
18-0482	Gasket, Water Pump	19242-ZW1-B00	1
18-1820	Seal, Water Pump	91251-ZW1-B04	2



18-3493
WATER PUMP REPAIR KIT
 Without Housing
Replaces: 06192-ZW9-000
Fits: BF8D/BFP8D/BF9.9D/BFP9.9D (2002-06), BF8D, BFP8D/BF9.9D/BFP9.9D (K0, K2, K3)
 — CONTAINS —

Part #	Desc.	O.E.#	Qty.
18-3100	Impeller	19210-ZW9-013	1
18-99153	Gasket, Water Pump	19232-ZW9-000	1
18-71335	O-Ring	91301-ZG3-000	1
18-3022	Key, Impeller	90752-ZW9-000	1



18-4536
WATER PUMP REPAIR KIT
 Without Housing
Replaces: 06192-ZV4-A00
Fits: BF9.9A/15A (1998-01)
 — CONTAINS —

Part #	Desc.	O.E.#	Qty.
18-3247	Impeller	19210-ZV4-651	1
18-2495	Gasket, Water Pump	19232-ZV4-610	2
18-8298	Seal, Water Pump	91252-935-004	1

① Items ending in "D" are Display Packaged - Regular number is Non-Display • ② Discount shop pack of 10 - Priced per package













HONDA 4-STROKE WATER PUMP REPAIR KIT APPLICATION

Model	HP	Year	Honda Code	Impeller	Gasket	Kit without Housing
BF5A	5	1998-06	6315899	18-3245	18-2524	18-3278
BF5A	5	K0, K2, K3	6315899	18-3245	18-2524	18-3278
BF8A	8	1998-00	6315386	18-3245	18-2608 18-2609	18-3279
BF8A	8	2003-06	6315386	18-3245	18-2608 18-2609	18-3279
BF8A	8	K0	6315386	18-3245	18-2608 18-2609	18-3279
BF8D	8	2002-06	7452345	18-3100	18-99153	18-3493
BF8D	8	K0, K2, K3	7452345	18-3100	18-99153	18-3493
BFP8D	8	2002-06	7452345	18-3100	18-99153	18-3493
BFP8D	8	2002-06	7452352	18-32455	18-99153	18-3478
BFP8D	8	K0, K2, K3	7452345	18-3100	18-99153	18-3493
BFP8D	8	K0, K2, K3	7452352	18-32455	18-99153	18-3478
BF9.9A	9.9	1998-01	6310494	18-3247	18-2495	18-4536
BF9.9A	9.9	1999-02	7452360	18-3247	18-2495	18-3280
BF9.9D	9.9	2002-06	7452345	18-3100	18-99153	18-3493
BF9.9D	9.9	K0, K2, K3	7452345	18-3100	18-99153	18-3493
BFP9.9D	9.9	2002-06	7452345	18-3100	18-99153	18-3493
BFP9.9D	9.9	2002-06	7452352	18-32455	18-99153	18-3478
BFP9.9D	9.9	K0, K2, K3	7452345	18-3100	18-99153	18-3493
BFP9.9D	9.9	K0, K2, K3	7452352	18-32455	18-99153	18-3478
BF15A	15	1998-01	6310494	18-3247	18-2495	18-4536
BF15A	15	1999-02	7452360	18-3247	18-2495	18-3280
BF15D	15	2003-06	7452352	18-32455	18-99153	18-3478
BF15D	15	K0, K2, K3	7452352	18-32455	18-99153	18-3478
BFP15D	15	K0, K2, K3	7452352	18-32455	18-99153	18-3478
BF20D	20	2003-06	7452352	18-32455	18-99153	18-3478
BF20D	20	K0, K2, K3	7452352	18-32455	18-99153	18-3478
BFP20D	20	2004-06	7452352	18-32455	18-99153	18-3478
BFP20D	20	K0	7452352	18-32455	18-99153	18-3478
BF25A	25	2001-03	7452378	18-3249	18-2496	18-3281
BF25D	25	2004-06	7452378	18-3249	18-2496	18-3281
BF25D	25	K0, K2, K3	7452378	18-3249	18-2496	18-3281
BF30A	30	2001-03	7452378	18-3249	18-2496	18-3281
BF30D	30	2004-06	7452378	18-3249	18-2496	18-3281
BF30D	30	K0, K2, K3	7452378	18-3249	18-2496	18-3281
BF40A	40	2000-06	7452386	18-3248	18-2496 18-0176	18-3282
BF40A	40	K0	7452386	18-3248	18-2496 18-0176	18-3282
BF40D	40	K2	7452386	18-3248	18-2496 18-0176	18-3282
BF40D	40	Pre-1997	7452386	18-3248	18-2496 18-0176	18-3282
BF50A	50	2000-06	7452386	18-3248	18-2496 18-0176	18-3282
BF50A	50	K0	7452386	18-3248	18-2496 18-0176	18-3282
BF50D	50	K2	7452386	18-3248	18-2496 18-0176	18-3282
BF50D	50	Pre-1997	7452386	18-3248	18-2496 18-0176	18-3282
BF75A	75	1997-98	4921441	18-3056	18-2565	18-3214
BF75A	75	1999-02	6706634	-	-	18-3492
BF75A	75	2003-06	7452394	18-3250	NSS	18-3283
BF75D	75	K0, K2	7452394	18-3250	NSS	18-3283
BF90A	90	1997-98	4921441	18-3056	18-2565	18-3214

APPLICATION CONTINUED ON NEXT PAGE

HONDA 4-STROKE WATER PUMP REPAIR KIT APPLICATION (CONT.)

Model	HP	Year	Honda Code	Impeller	Gasket	Kit without Housing
BF90A	90	1999-02	6706634	-	-	18-3492
BF90A	90	2003-06	7452394	18-3250	NSS	18-3283
BF90D	90	K0, K2	7452394	18-3250	NSS	18-3283
BF115A	115	1999-02	6706634	-	-	18-3492
BF115A	115	2003-06	7452394	18-3250	NSS	18-3283
BF115A	115	K0	7452394	18-3250	NSS	18-3283
BF115D	115	K1	7632797	18-3250	18-2497	18-3284
BF115D	115	Pre-1997	7632797	18-3250	18-2497	18-3284
BF130A	130	1999-02	6706634	-	-	18-3492
BF130A	130	2003-04	7452394	18-3250	NSS	18-3283
BF135A	135	2004-06	7632797	18-3250	18-2497	18-3284
BF135A	135	K0, K2	7632797	18-3250	18-2497	18-3284
BF150A	150	2004-06	7632797	18-3250	18-2497	18-3284
BF150A	150	K0, K2	7632797	18-3250	18-2497	18-3284
BF175A	175	K1	7452402	18-3031	18-2499 18-8299	18-3285
B175A	175	K2	7452402	18-3031	18-2499 18-8299	18-3285
BF200A	200	2002-06	7452402	18-3031	18-2499 18-8299	18-3285
BF200A	200	K0, K1, K2	7452402	18-3031	18-2499 18-8299	18-3285
BF225A	225	2002-06	7452402	18-3031	18-2499 18-8299	18-3285
BF225A	225	K0, K1, K2	7452402	18-3031	18-2499 18-8299	18-3285
BF250A	250	ALL		18-3031	18-99154	18-3489

 <p>18-2499 WATER PUMP GASKET Replaces: 19234-ZY3-000 Fits: BF200, BF225</p>	 <p>18-2524 WATER PUMP GASKET Replaces: 19232-ZV1-A10 Fits: BF5</p>	 <p>18-2608 WATER PUMP GASKET Replaces: 19232-881-850 Fits: BF8A</p>	 <p>18-2609 WATER PUMP GASKET Replaces: 19234-881-850 Fits: BF8A</p>
 <p>18-0176 WATER PUMP GASKET Replaces: 19242-ZV5-000</p>	 <p>18-2495 WATER PUMP GASKET Replaces: 19232-ZV4-610 Fits: BF9.9A, BF15A</p>	 <p>18-2496 WATER PUMP GASKET Replaces: 19233-ZV5-000 Fits: BF25, BF30</p>	<p>PKG. OF 2</p>  <p>18-2563 18-2563-9^① IMPELLER GASKET Replaces: 19232-ZW1-003</p>
<p>PKG. OF 2</p>  <p>18-2564 18-2564-9^① IMPELLER GASKET Replaces: 19234-ZW1-003</p>	<p>PKG. OF 2</p>  <p>18-2565 18-2565-9^① IMPELLER GASKET Replaces: 19242-ZW1-003</p>	 <p>18-2480 GASKET SET Replaces: 16010-ZV4-005 Fits: BF8(2001), BF9.9(2001 & below), BF15(2002 & below), BF25(All), BF30(All), BF35(1997), BF40(All), BF45(1997), BF50(All), BF75(1997-06), BF90(1997-06)</p>	 <p>18-2481 GASKET SET Replaces: 16010-ZW9-003 Fits: BF8(2002 & Up), BF9.9(2002 & Up), BF15(2003 & Up), BF20(2003 & Up)</p>

SEE PAGES 201-202 FOR OUR COMPLETE LINE OF GASKET SEALANTS

① Priced Per Package



18-2482
GASKET SET
Replaces: 16010-881-003
Fits: BF5(2003 & below), BF8(2000 & below, 2003 & Up), BF50(1996 & below), BF75(1996 & below), BF100(1996 & below)



18-2470
CARB MOUNTING GASKET
Replaces: 16221-ZV4-610
Fits: BF9.9 (2000 & below), BF15 (2002 & below)



18-2471
CARB MOUNTING GASKET
Replaces: 16221-ZW9-000
Fits: BF8(2001 & Up), BF9.9(2001 & Up)



18-2472
CARB MOUNTING GASKET
Replaces: 16221-ZW1-000
Fits: BF75(1997-06), BF90(1997-06)



18-2473
CARB MOUNTING GASKET
Replaces: 16201-881-850
Fits: BF8(2000 & below, 2003 & Up), BF75(1996 & below), BF100(1996 & below)



PKG. OF 2
18-2945
18-2945-9①
18-29451-9①
 (PKG. OF 50)
DRAIN SCREW GASKET
 Used with **18-2244** Drain Screw



18-0300
INTAKE MANIFOLD GASKET
Replaces: 17105-ZY6-000
Fits: BF135-BF150

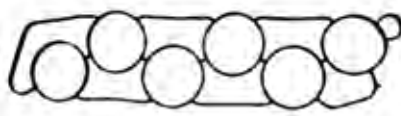

18-0390
INTAKE MANIFOLD GASKET
Replaces: 17105-ZY3-004
Fits: BF200-BF225 (2002 and UP)



18-0248
INTAKE MANIFOLD GASKET
Replaces: 17151-ZW5-000



18-0382
THROTTLE BODY GASKET
Replaces: 17109-ZY6-000
Fits: BF75-BF150



18-0396
THROTTLE BODY GASKET
Replaces: 17109-ZY3-004
Fits: BF200-BF225 (2002 & UP)



18-0737
THROTTLE BODY GASKET
Replaces: 16176-P0A-004



18-3288
SEAL
Replaces: 91252-ZV1-003
Fits: BF5



18-8298
SEAL
Replaces: 91252-935-004
Fits: BF8A

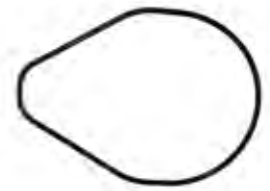

18-8299
MOLDED RUBBER SEAL (O-RING MATERIAL)
Replaces: 91356-ZY3-003
Fits: BF200, BF225

SEE PAGES 201-202 FOR OUR COMPLETE LINE OF GASKET SEALANTS

① Priced per Package



18-1156
FORWARD GEAR BEARING
 Replaces: 91051-ZW1-003



18-1157
FORWARD GEAR INNER BEARING
 Replaces: 91057-ZW1-003



18-1158
CARRIER BEARING
 Replaces: 91053-ZW1-003



18-7909
OIL FILTER
 Replaces: 15400-POH-305PE,
 15400-POH-305, 15400-ZJI-004,
 15400-PLM-A01PE
 (Application on next page)



18-7913
OIL FILTER
 Replaces: 15400-PFB-014
 (Application on next page)



18-7911-1
OIL FILTER
 Replaces: 15400-PFB-007
 (Application on next page)

Models	Years	SS Number	Replace	Part No.	Models	Years	SS Number	Replace	Part No.
BF8D, BFP8D	2001-Current	15400-PFB-004	15400-PFB-014	18-7913	BF50A	1998-Earlier	15400-PJ7-005	15400-PFB-014	18-7913
BF9D, BFP9D	2001-Current	15400-PM3-004	15400-PFB-014	18-7913	BF25	1999-2005	15400-ZW4-003	15400-PFB-007	18-7911-1
BF15D, BFP15D	2003-Current	15400-PM3-405	15400-PFB-014	18-7913	BF30	1999-2005	15400-ZW4-003	15400-PFB-007	18-7911-1
BF20D	2003-Current	15400-PJ7-015	15400-PFB-014	18-7913	BF40	1999-2005	15400-ZW4-003	15400-PFB-007	18-7911-1
BF25A	1998-Earlier	15400-PJ7-005	15400-PFB-014	18-7913	BF50	1999-2005	15400-ZW4-003	15400-PFB-007	18-7911-1
BF30A	1998-Earlier	15400-PJ7-005	15400-PFB-014	18-7913	BF75, BF90	1997-Current	15400-POH-305PE	15400-PLM-A01PE	18-7909
BF35AM	1998-Earlier	15400-PJ7-005	15400-PFB-014	18-7913	BF115, BF130	1999-Current	15400-POH-305	15400-PLM-A01PE	18-7909
BF40A	1998-Earlier	15400-PJ7-005	15400-PFB-014	18-7913	BF135, BF150	2004-Current	15400-ZJI-004	15400-PLM-A01PE	18-7909
BF45AM	1998-Earlier	15400-PJ7-005	15400-PFB-014	18-7913	BF200, BF225	2002-Current	15400-ZJI-999AH	15400-PLM-A01PE	18-7909

Zinc is for saltwater only applications.
 Magnesium is for fresh water only applications.
 Aluminum is for brackish water, or if boat is used in both fresh and salt environments.



18-2448
LOWER UNIT
FILL/DRAIN KIT
 • M8 - 1.25 thread
 Fits: Yamaha, Nissan/Tohatsu, & Honda Lower Units



③ **18-6068**
ANODE
 Replaces: 41109-ZW1-003
 BF75-BF90 (1997-98)

SEE PAGES 182-184 & 1147-1170 FOR ADDITIONAL OIL FILTER INFORMATION

- ① Aluminum ② Magnesium ③ Zinc ④ Priced per Package
 ⑤ Items ending in "D" are Display Packaged - Regular number is Non-Display



② 18-6241
 ③ 18-6011
 ① 18-6011A
ANODE
 Replaces: 41107-ZW1-003ZA
 BF75-BF90 (1997-98)



① 18-6165A
ANODE, TRIM TAB
 Replaces: 41107-ZV5-00-00
 Fits: BF25, BF30, BF35, BF45, BF50 (1997-Up)



① 18-6163A
 ② 18-6163M
ANODE KIT
 Fits: Honda BF90-115 Engines

PKG. OF 10



18-3200
 18-3200-9④
TAB WASHER
 Replaces: 90508-ZW1-003
 For: 75-90 HP

⑤ 18-3701D



18-3701
PROP NUT KIT
 — CONTAINS —

Part #	O.E. #	Description
18-3200	90508-ZW1-003	Tab Washer
18-3700	90301-ZW1-003	Prop Nut



18-79989
TRAILERING STICKS
 Fits: Most outboards over 150hp with three ram intrigrel tilt/trim.

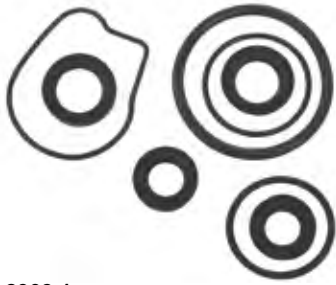

18-8362-1
LOWER UNIT SEAL KIT
 For: Series 14ZV50M



18-8363
LOWER UNIT SEAL KIT



18-8365
LOWER UNIT SEAL KIT

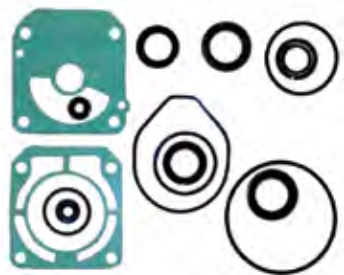

18-8366
LOWER UNIT SEAL KIT



OIL SEALS

Part No.	Description	O.E. No.
18-0522	Drive Shaft	91254-ZW1-003
18-0583	Drive Shaft	91251-ZW1-003
18-2002	Prop Shaft	91252-ZW1-003
18-2053	Prop Shaft	91255-ZW1-003
18-2054	Shift Shaft	91253-ZW1-003

PKG. OF 5



18-7198
 18-7198-9④
O-RING
 Replaces: 91353-ZW1-003

LOWER UNIT SEAL KIT APPLICATION	
HP/Model	Part #
BF9.9, BF15	18-8363
BF35AM, BF45AM, BF40A, BF40AW, BF40AX, BF50A, BF50AW, BF50AX	18-8362-1
BF75, BF90	18-8366
BF115, BF130	18-8365

Johnson/Evinrude Model Identification

Outboards 1980-1998

Model Variation	Style	Horse-power	Design Feature	Shaft Year Length	Built
A = Australia B = Belgium C = Canada H = Hong Kong S = South Africa T = Tracker V = Boat Builder	J = Johnson E = Evinrude C = Commercial V = Quiet Rider	Example: 20 40 200	AE = Elec. Start - Alaska AR = Rope Start - Alaska BA = AC Lighting - Rope Start BE = Belgium Derated - Elec. Start BF = Belgium Derated - Rope Start BG = Belgium Derated - Rope Start BI = Belgium Derated - Rope Start BR = Euro Rope Start C = Counter Rotation CE = Canada Derated - Elec. Start CR = Canada Derated - Rope Start D = Remote Electric DE = Derated - Elec. Start DR = Derated - Rope Start DT = Derated - Elec. Start/Trim & Tilt E = Elec. Start ER = Elec. Start - Sport Styling ES = Elec. Start - Special FA = 4-stroke - Rope Start FE = 4-stroke - Elec. Start/Remote FP = Commercial w/Program Tilt FR = 4-stroke - Rope Start FRE = 4-stroke - Elec. Start/Remote FS = FICHT - Trim & Tilt FT = FICHT - Trim & Tilt/Special Styling G = Special Styling H = Less Integral Tank/Hydraulic Steering I = FICHT Fuel Injection IE = Italy Elec. Start IK = Italy Elec. Start J = Jet Drive K = 3-CYL 25/35 KC = Kerosene Rope Start KG = Kerosene/Gasoline KS = Kerosene Rope Start M = Manual Tilt - Elec. Start MS = Manual Tilt - Elec. Start/Special N = Counter Rotation P = Power Steering Q = 3-CYL 25/35 Trim & Tilt R = Rope Start RA = Australia Rope Start RC = Rope Start - Commercial/CD Ignition RD = Rope Start - Deluxe RE = Remote Elec. RP = Commercial w/Program Tilt RS = Rope Start - Commercial RW = Commercial w/Program Tilt S = Sail - Special Styling SC = Special Styling/Counter Rotation SE = Elec. Start Non-Tilt Sail SI = Italy Special Derated SL = 60 Degree V - Trim & Tilt SP = Special Styling SR = Rope Start - Sail - Non-Tilt ST = Special Styling - Trim & Tilt T = Trim & Tilt - Elec. Start TE = Tiller Elec. TR = Trim & Tilt - Sport styling TT = Tiller - Trim & Tilt U = Manual Tilt V = Special Gearcase W = 110 Degree Angle Drive - Rope Start WM = Elec. Commercial - Manual Tilt WMP = Same as "WM" w/Chrome Pump WT = Elec. Commercial - Trim & Tilt WTP = Same as "WT" w/Chrome Pump	= 15" L = 20" Y = 22.5" X = 25" Z = 30"	I = 1 N = 2 T = 3 R = 4 O = 5 D = 6 U = 7 C = 8 E = 9 S = 0 EX: CS = 1980 ES = 1990 EU = 1997 SC = 2008

EXAMPLE: VE70TLEDA - Boat Builder Model, Evinrude, 70 HP, Trim & Tilt w/Elec. Start, 1996 Model









MODEL IDENTIFICATION CHART CONTINUED ON NEXT PAGE

Johnson/Evinrude Model Identification

Outboards 1999 and Newer

Style	Horse-power	Design Feature	Shaft Length	Year Built
J = Johnson E = Evinrude	Example: 20 40 200	3 = 3-CYL (25 or 35 HP) 4 = Four Stroke Engine B = Blue Paint C = Counter-Rotation w/Trim & Tilt D = E-TEC E = Electric Start w/Remote Steering F = FICHT Fuel Injection G = Graphite Paint J = Jet M = Military Model P = Power Trim & Tilt R = Rope Start w/Tiller Steering S = Special Styling (White Evinrude) T = Tiller Steering TE = Tiller Electric W = Commercial Model	= 15" L = 20" Y = 22.5" X = 25" Z = 30"	I = 1 N = 2 T = 3 R = 4 O = 5 D = 6 U = 7 C = 8 E = 9 S = 0 EX: EE = 1999 SC = 2008

EXAMPLE: E70PLEEA - Evinrude model, 70 HP, Power Trim&Tilt, 20", 1999 model

<div style="text-align: right; margin-bottom: 5px;"> 18-5001D Display Package </div>  <p>18-5001 TUNE-UP KIT Replaces: 172525</p> <table style="width: 100%; border-collapse: collapse;"> <thead> <tr> <th colspan="4" style="text-align: center;">— CONTAINS —</th> </tr> <tr> <th style="text-align: left;">Part #</th> <th style="text-align: left;">Desc.</th> <th style="text-align: left;">O.E.#</th> <th style="text-align: left;">Qty.</th> </tr> </thead> <tbody> <tr> <td>18-5200</td> <td>Condenser</td> <td>580256</td> <td>1</td> </tr> <tr> <td>18-5157</td> <td>Contact set</td> <td>580290</td> <td>2</td> </tr> </tbody> </table>	— CONTAINS —				Part #	Desc.	O.E.#	Qty.	18-5200	Condenser	580256	1	18-5157	Contact set	580290	2	<div style="text-align: right; margin-bottom: 5px;"> 18-5002D Display Package </div>  <p>18-5002 TUNE-UP KIT Replaces: 172523</p> <table style="width: 100%; border-collapse: collapse;"> <thead> <tr> <th colspan="4" style="text-align: center;">— CONTAINS —</th> </tr> <tr> <th style="text-align: left;">Part #</th> <th style="text-align: left;">Desc.</th> <th style="text-align: left;">O.E.#</th> <th style="text-align: left;">Qty.</th> </tr> </thead> <tbody> <tr> <td>18-5205</td> <td>Condenser</td> <td>581419</td> <td>2</td> </tr> <tr> <td>18-5156</td> <td>Contact Set</td> <td>580148</td> <td>2</td> </tr> </tbody> </table>	— CONTAINS —				Part #	Desc.	O.E.#	Qty.	18-5205	Condenser	581419	2	18-5156	Contact Set	580148	2	<div style="text-align: right; margin-bottom: 5px;"> 18-5003D Display Package </div>  <p>18-5003 TUNE-UP KIT Replaces: 172806</p> <table style="width: 100%; border-collapse: collapse;"> <thead> <tr> <th colspan="4" style="text-align: center;">— CONTAINS —</th> </tr> <tr> <th style="text-align: left;">Part #</th> <th style="text-align: left;">Desc.</th> <th style="text-align: left;">O.E.#</th> <th style="text-align: left;">Qty.</th> </tr> </thead> <tbody> <tr> <td>18-5205</td> <td>Condenser</td> <td>581419</td> <td>2</td> </tr> <tr> <td>18-5141</td> <td>Contact Set</td> <td>581207</td> <td>2</td> </tr> </tbody> </table>	— CONTAINS —				Part #	Desc.	O.E.#	Qty.	18-5205	Condenser	581419	2	18-5141	Contact Set	581207	2
— CONTAINS —																																																		
Part #	Desc.	O.E.#	Qty.																																															
18-5200	Condenser	580256	1																																															
18-5157	Contact set	580290	2																																															
— CONTAINS —																																																		
Part #	Desc.	O.E.#	Qty.																																															
18-5205	Condenser	581419	2																																															
18-5156	Contact Set	580148	2																																															
— CONTAINS —																																																		
Part #	Desc.	O.E.#	Qty.																																															
18-5205	Condenser	581419	2																																															
18-5141	Contact Set	581207	2																																															
<div style="text-align: right; margin-bottom: 5px;"> 18-5006D Display Package </div>  <p>18-5006 TUNE-UP KIT Replaces: 172522</p> <table style="width: 100%; border-collapse: collapse;"> <thead> <tr> <th colspan="4" style="text-align: center;">— CONTAINS —</th> </tr> <tr> <th style="text-align: left;">Part #</th> <th style="text-align: left;">Desc.</th> <th style="text-align: left;">O.E.#</th> <th style="text-align: left;">Qty.</th> </tr> </thead> <tbody> <tr> <td>18-5199</td> <td>Condenser</td> <td>580321</td> <td>2</td> </tr> <tr> <td>18-5156</td> <td>Contact Set</td> <td>580148</td> <td>2</td> </tr> </tbody> </table>	— CONTAINS —				Part #	Desc.	O.E.#	Qty.	18-5199	Condenser	580321	2	18-5156	Contact Set	580148	2	<div style="text-align: right; margin-bottom: 5px;"> 18-5011 </div>  <p>18-5011 TUNE-UP KIT Replaces: 172521</p> <table style="width: 100%; border-collapse: collapse;"> <thead> <tr> <th colspan="4" style="text-align: center;">— CONTAINS —</th> </tr> <tr> <th style="text-align: left;">Part #</th> <th style="text-align: left;">Desc.</th> <th style="text-align: left;">O.E.#</th> <th style="text-align: left;">Qty.</th> </tr> </thead> <tbody> <tr> <td>18-5199</td> <td>Condenser</td> <td>580321</td> <td>1</td> </tr> <tr> <td>18-5156</td> <td>Contact Set</td> <td>580148</td> <td>1</td> </tr> </tbody> </table>	— CONTAINS —				Part #	Desc.	O.E.#	Qty.	18-5199	Condenser	580321	1	18-5156	Contact Set	580148	1	 <p>18-5141 CONTACT SET Replaces: 581207</p>																
— CONTAINS —																																																		
Part #	Desc.	O.E.#	Qty.																																															
18-5199	Condenser	580321	2																																															
18-5156	Contact Set	580148	2																																															
— CONTAINS —																																																		
Part #	Desc.	O.E.#	Qty.																																															
18-5199	Condenser	580321	1																																															
18-5156	Contact Set	580148	1																																															
 <p>18-5156 CONTACT SET Replaces: 580148</p>	 <p>18-5157 CONTACT SET Replaces: 580290</p>	<p style="text-align: center; color: blue;">CONDENSERS</p> <p>18-5199 Replaces: 580321</p> <p>18-5205 Replaces: 581419</p>	 <p>18-5200 CONDENSER Replaces: 580256</p>																																															

APPLICATION BEGINS ON NEXT PAGE

① Items ending in "D" are Display Packaged - Regular number is Non-Display

JOHNSON/EVINRUDE TUNE-UP KIT APPLICATION

HP	Year Start	Year Stop	Contact Set	Condenser	Tune-Up Kit	HP	Year Start	Year Stop	Contact Set	Condenser	Tune-Up Kit
1.2	1986	1990	18-5156	18-5199	18-5011	25	1955	1955	18-5156	18-5199	18-5006
1.5	1968	1970	18-5156	18-5199	18-5011	25	1969	1976	18-5156	18-5205	18-5002
2	1971	1985	18-5156	18-5199	18-5011	28	1962	1964	18-5156	18-5205	18-5002
3	1952	1968	18-5156	18-5199	18-5006	30	1956	1956	18-5156	18-5199	18-5006
3	1989	1990	18-5156	18-5199	18-5006	33	1965	1970	18-5156	18-5205	18-5002
4	1969	1976	18-5156	18-5199	18-5006	35	1958	1959	18-5156	18-5199	18-5006
4	1981	1988	18-5156	18-5199	18-5006	35	1976	1976	18-5141	18-5205	18-5003
5	1965	1968	18-5156	18-5199	18-5006	38	1968	1968	18-5156	18-5199	18-5006
5.5	1954	1964	18-5156	18-5199	18-5006	40	1960	1961	18-5156	18-5199	18-5006
6	1965	1976	18-5156	18-5199	18-5006	40	1962	1973	18-5156	18-5205	18-5002
7.5	1956	1958	18-5156	18-5199	18-5006	40	1974	1976	18-5141	18-5205	18-5003
9.5	1964	1973	18-5156	18-5199	18-5006	40 Comm	1981	1983	18-5141	18-5205	18-5003
10	1950	1963	18-5156	18-5199	18-5006	50	1958	1959	18-5157	18-5200	18-5001
9.9	1970	1970	18-5156	18-5199	18-5006	60	1964	1967	18-5157	18-5200	18-5001
9.9	1974	1976	18-5141	18-5205	18-5003	75	1961	1967	18-5157	18-5200	18-5001
15	1956	1956	18-5156	18-5199	18-5006	80	1966	1967	18-5157	18-5200	18-5001
15	1974	1976	18-5141	18-5205	18-5003	90	1964	1965	18-5157	18-5200	18-5001
18	1956	1961	18-5156	18-5199	18-5006	90	1968	1968	18-5157	18-5200	18-5001
18	1962	1973	18-5156	18-5205	18-5002	100	1966	1966	18-5157	18-5200	18-5001
20	1968	1973	18-5156	18-5205	18-5002						

 <p>18-5163 IGNITION COIL Replaces: 581130, 763809</p>	 <p>18-5170 IGNITION COIL Replaces: 583740, 583298</p>	 <p>18-5172 IGNITION COIL Replaces: 581786, 502881</p>	 <p>18-5176 IGNITION COIL KIT Replaces: 582106, 582330 582366, 583737, 584561</p> <p>①18-5176D </p>
--	--	---	--

 <p>18-5179 IGNITION COIL Replaces: 582508</p> <p>①18-5179D </p>	 <p>18-5181 IGNITION COIL Replaces: 582995, 584477</p> <p>①18-5181D </p>	 <p>18-5192 IGNITION COIL Replaces: 581610, 582091, 502888</p> <p>①18-5192D </p>
--	---	--

 <p>18-5193 IGNITION COIL Replaces: 580740, 582382</p>	 <p>18-5194 IGNITION COIL Replaces: 582160, 584632, 502890, 581032</p>	 <p>18-5196 IGNITION COIL Replaces: 581407, 502880</p> <p>①18-5196D </p>
---	--	--

APPLICATION BEGINS ON NEXT PAGE

① Items ending in "D" are Display Packaged - Regular number is Non-Display

JOHNSON/EVINRUDE IGNITION COIL APPLICATION

HP	Year Start	Year Stop	Coil	Qty.	HP	Year Start	Year Stop	Coil	Qty.	HP	Year Start	Year Stop	Coil	Qty.
2	1971	1973	18-5181	1	20	1966	1972	18-5181	2	60	1980	1984	18-5176	2
2	1975	1985	18-5181	1	20	1973	1973	18-5163	1	60	1985	1987	18-5179	3
2	1995	2001	18-5179	1	20	1985	1987	18-5179	2	60	1988	1988	18-5176	3
2.5	1987	1988	18-5170	1	20	1988	1988	18-5176	2	60	1989	2001	18-5179	3
3	1955	1968	18-5181	2	20	1989	1998	18-5179	2	65	1972	1973	18-5194	3
3	1989	1990	18-5181	2	25	1951	1953	18-5181	2	65	1984	1984	18-5176	3
3	1991	1997	18-5170	1	25	1955	1955	18-5181	2	65	1985	1988	18-5179	3
3	1998	2001	18-5179	1	25	1969	1972	18-5181	2	65	1989	1990	18-5176	3
3	2003	2005	18-5179	1	25	1973	1976	18-5163	1	65	1991	2001	18-5179	3
3.3	1995	1997	18-5179	1	25	1973	1976	18-5172	2	70	1974	1975	18-5194	3
4	1969	1976	18-5181	2	25	1977	1984	18-5176	2	70	1979	1984	18-5176	3
4	1977	1980	18-5176	2	25	1985	1987	18-5179	2	70	1985	1987	18-5179	3
4	1981	1988	18-5181	2	25	1988	1988	18-5176	2	70	1988	1988	18-5176	3
4	1986	1987	18-5179	2	25	1989	2005	18-5179	2	70	1989	2001	18-5179	3
4	1987	2001	18-5170	1	28	1962	1964	18-5181	2	75	1975	1975	18-5194	3
4	1988	1988	18-5176	2	28	1986	1996	18-5179	2	75	1979	1984	18-5176	3
4	1989	1996	18-5179	2	28	1995	1998	18-5170	1	75	1985	1987	18-5179	3
4.5	1980	1983	18-5176	2	30	1956	1956	18-5181	2	75	1988	1988	18-5176	3
5	1965	1968	18-5181	2	30	1984	1984	18-5176	2	75	2000	2001	18-5170	2
5	1996	1998	18-5170	1	30	1985	1987	18-5179	2	85	1969	1972	18-5193	1
5	1997	2001	18-5179	2	30	1988	1988	18-5176	2	85	1973	1975	18-5194	3
5.5	1954	1964	18-5181	2	30	1989	2005	18-5179	2	85	1976	1977	18-5192	4
6	1965	1976	18-5181	2	30	1999	2001	18-5170	1	85	1978	1980	18-5176	4
6	1977	1979	18-5176	2	33	1965	1970	18-5181	2	85	1991	1995	18-5179	4
6	1984	1984	18-5176	2	35	1957	1959	18-5181	2	88	1987	1987	18-5179	4
6	1985	1990	18-5179	2	35	1976	1976	18-5172	2	88	1988	1988	18-5176	4
6	1991	2005	18-5170	1	35	1977	1984	18-5176	2	88	1989	1996	18-5179	4
6	1997	2001	18-5179	2	35	1986	1987	18-5179	2	90	1981	1984	18-5176	4
6	2003	2004	18-5179	2	35	1988	1988	18-5176	2	90	1985	1987	18-5179	4
7.5	1954	1958	18-5181	2	35	1989	1994	18-5179	2	90	1988	1988	18-5176	4
7.5	1980	1983	18-5176	2	35	1996	1996	18-5179	2	90	1989	1998	18-5179	4
8	1984	1984	18-5176	2	40	1960	1973	18-5181	2	90	1995	2006	18-5170	2
8	1985	1990	18-5179	2	40	1974	1974	18-5196	2	100	1971	1972	18-5193	1
8	1991	2005	18-5170	1	40	1975	1979	18-5172	2	100	1979	1980	18-5176	4
9.5	1964	1973	18-5181	2	40	1983	1983	18-5172	2	100	1984	1984	18-5176	4
9.9	1974	1976	18-5196	2	40	1984	1984	18-5176	2	100	1985	1997	18-5179	4
9.9	1977	1984	18-5176	2	40	1985	1987	18-5179	2	100	1988	1988	18-5176	4
9.9	1985	1992	18-5179	2	40	1988	1988	18-5176	2	100	1998	2001	18-5170	2
9.9	1993	2001	18-5170	1	40	1989	2005	18-5170	1	105	1997	2001	18-5170	2
10	1949	1952	18-5181	2	40	1999	2001	18-5179	2	105	2003	2003	18-5170	2
10	1953	1953	18-5181	2	45	1986	1992	18-5179	2	110	1986	1987	18-5179	4
10	1954	1963	18-5181	2	45	1992	1997	18-5170	1	110	1988	1988	18-5176	4
10	2003	2007	18-5170	1	48	1987	1987	18-5179	2	110	1989	1989	18-5179	4
14	1988	1988	18-5179	2	48	1988	1988	18-5176	2	112	1994	1996	18-5179	4
14	1989	1989	18-5176	2	48	1989	1996	18-5170	1	115	1969	1970	18-5193	1
15	1953	1953	18-5181	2	50	1971	1975	18-5194	2	115	1973	1975	18-5194	4
15	1955	1956	18-5181	2	50	1979	1984	18-5176	2	115	1976	1977	18-5192	4
15	1965	1968	18-5181	2	50	1985	1987	18-5179	2	115	1978	1984	18-5176	4
15	1974	1976	18-5196	2	50	1988	1988	18-5176	2	115	1985	1985	18-5179	4
15	1977	1984	18-5176	2	50	1989	2005	18-5170	1	115	1990	1998	18-5179	4
15	1985	1992	18-5179	2	50	1995	1998	18-5179	2	115	1995	2006	18-5170	2
15	1993	2007	18-5170	1	55	1978	1984	18-5176	2	120	1985	1987	18-5179	4
18	1957	1972	18-5181	2	55	1985	1992	18-5179	2	120	1988	1988	18-5176	4
18	1973	1973	18-5163	1	55	1992	2005	18-5170	1	120	1989	1994	18-5179	4

APPLICATION CONTINUED ON NEXT PAGE

JOHNSON/EVINRUDE IGNITION COIL APPLICATION (Cont.)

HP	Year Start	Year Stop	Coil	Qty.	HP	Year Start	Year Stop	Coil	Qty.	HP	Year Start	Year Stop	Coil	Qty.
125	1971	1972	18-5193	1	150	1985	1991	18-5179	6	185	1989	1990	18-5179	6
125	1989	1990	18-5179	4	150	1988	1988	18-5176	6	185	1992	1994	18-5179	6
125	1992	1998	18-5179	4	150	1991	2006	18-5170	3	200	1976	1978	18-5192	6
130	1995	2001	18-5179	4	155	1984	1984	18-5176	6	200	1979	1983	18-5176	6
135	1973	1975	18-5194	4	155	1985	1985	18-5179	6	200	1986	2001	18-5179	6
135	1976	1976	18-5192	4	155	1987	1987	18-5179	6	200	1999	1999	18-5170	3
135	2000	2001	18-5170	2	155	1988	1988	18-5176	6	225	1986	2001	18-5179	6
140	1977	1977	18-5192	4	155	1989	1992	18-5179	6	225	1999	1999	18-5170	3
140	1978	1984	18-5176	4	175	1977	1978	18-5192	6	235	1978	1978	18-5192	6
140	1985	1987	18-5179	4	175	1979	1983	18-5176	6	235	1979	1984	18-5176	6
140	1988	1988	18-5176	4	175	1985	1991	18-5179	6	235	1985	1985	18-5179	6
140	1989	1994	18-5179	4	175	1991	2006	18-5170	3	250	1991	2001	18-5179	6
150	1978	1978	18-5192	6	185	1984	1984	18-5176	6	275	1985	1988	18-5179	6
150	1979	1984	18-5176	6	185	1985	1985	18-5179	6	300	1985	1995	18-5179	6



18-5753
POWER PACK
Replaces: 385391, 581731, 581311
(pack 4)



18-5754
POWER PACK
Replaces: 581726
(pack 3)



18-5755
POWER PACK
Replaces: 581397, 764708
(pack 2)



18-5756
POWER PACK
Replaces: 582056
Same as 18-5753 w/o Hardware Pack
(1) Hole Drilled



18-5757
POWER PACK
Replaces: 582057, 581713
Same as 18-5754 w/o Hardware Pack
(2) Holes Drilled



18-5758
POWER PACK
Replaces: 582453, 583380, 582452



18-5759
POWER PACK
Replaces: 582125, 581805



18-5760
POWER PACK
Replaces: 582138, 582400, 582642, 582556



18-5761
POWER PACK
Replaces: 583114



18-5763
POWER PACK
Replaces: 582285, 583170



18-5764
POWER PACK
Replaces: 582261, 586696



18-5766
POWER PACK
Replaces: 583748



18-5767
POWER PACK
Replaces: 584783



18-5768
POWER PACK
Replaces: 584908, 5001344



18-5770-1
POWER PACK
Replaces: 584028



18-5771
POWER PACK
Replaces: 584032



18-5772-1
POWER PACK
Replaces: 584041



18-5773
POWER PACK
Replaces: 584642, 763803



18-5774-1
POWER PACK
Replaces: 585145, 5004532



18-5780
POWER PACK
Replaces: 585189, 5004533



18-5781-1
POWER PACK
Replaces: 586661, 584636, 586212, 585114



18-5782
POWER PACK
Replaces: 582705, 763793



18-5783
POWER PACK
Replaces: 582811, 763794



18-5784-1
POWER PACK
Replaces: 583110



18-5785
POWER PACK
Replaces: 585261



18-5794
IGNITION MODULE
Replaces: 584489, 584329, 583896, 584331



18-5883
IGNITION MODULE
Replaces: 584488

APPLICATION BEGINS ON NEXT PAGE



18-5885
POWER PACK
Replaces: 583865
For: V-6 5800 rpm limit



18-5886
POWER PACK & SENSOR
Replaces: 436367, 584122
For: V6 engines with optical sensor and BLUE sleeve on power pack. Do not use with gray sleeved stator.

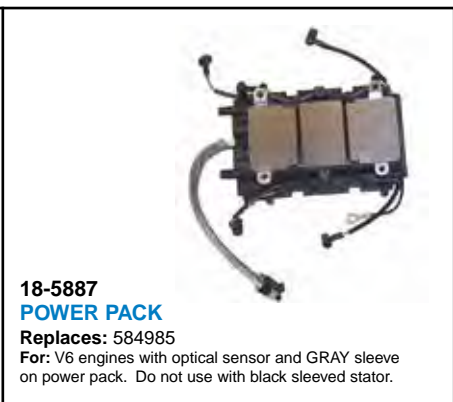

18-5887
POWER PACK
Replaces: 584985
For: V6 engines with optical sensor and GRAY sleeve on power pack. Do not use with black sleeved stator.



18-5891
POWER PACK
Replaces: 583605
For: 3 & 6 cyl. 6700 rpm limit



18-5893
POWER PACK
Replaces: 586667, 584037, 586217, 583476
For: V-4 & V-8 6700 rpm limit



18-5884
OPTICAL SENSOR
Replaces: 586343
For: V-4 & V-6 engines



18-9802
TIMING LIGHT
Self-powered accurate up to 10,000 RPM's

Model	Years	Power Pack	Model	Years	Power Pack	Model	Years	Power Pack
4	1977-80,1984	18-5758	25	1985	—	48	1987-88	18-5763
4	1993	18-5883	25	1986-88	18-5763	48	1991-93	18-5794
4 DLX	1986-88, 1994-99	18-5763	25	1989-92	18-5794	50	1971-75	18-5755
4.5	1980-84	18-5758	25	1993-95	18-5768	50	1979,1981-84	18-5758
4.5	1986-87	18-5763	25	1996-01	18-5768 ⑩	50	1985	—
5	1984	18-5758	25 COM.	1986-88	18-5764 ⑦	50	1986-88	18-5763
5	1985	—	28	1986-88	18-5763	50	1991-93	18-5794
5	1986-88, 1993-98	18-5763	28	1989-92	18-5794	50 Rope Start	1993- 01	18-5768
6	1977-79,1984	18-5758	28	1996-01	18-5768	50 Electric Start	1993- 01	18-5785
6	1985	—	30	1984	18-5758	50 (3 cyl)	1996-99	18-5780 ⑧
6	1986-88, 1993-01	18-5763	30	1985	—	55	1976-77	18-5755
6.5COM.	1992-99	18-5763	30	1986-88	18-5763	55	1978-82	18-5758
7.5	1980-83	18-5758	30	1989-92	18-5794	55	1991-92	18-5794
8	1993-95	18-5763	30	1993-95	18-5768	60	1970-71	—
9.9,15	1977-84	18-5758	30	1996-01	18-5768 ⑩	60	1980-84	18-5758
9.9,15	1985	—	35	1977-84	18-5758	60	1985	—
9.9,15	1986-88	18-5763	35	1985	—	60	1986-88	—
9.9,15	1993-99	18-5767 ②	35	1986-88	18-5763	60	1989-92	18-5766
14	1987	18-5763	35	1989-92	18-5794	60	1993-95	18-5774-1 ⑧
10/15COM.	1992	18-5763	35	1993-95	18-5768	60	1996-99	18-5780 ⑧
10,15COM.	1993-99	18-5767	40	1982	18-5758	65	1972-73	18-5754 ③
20	1981-84	18-5758	40	1985	—	65	1989-92	18-5766
20	1985	—	40	1986-88	18-5763	65	1993-95	18-5774-1 ⑧
20	1986-88	18-5763	40	1991-93	18-5794	70	1974-78	18-5754 ③
20	1989-92	18-5794	40 Rope Start	1993- 01	18-5768	70	1979-84	18-5760
20	1993-95	18-5768	40 Electric Start	1993- 01	18-5785	70	1985	18-5782 ⑧
20	1996-01	18-5768 ⑩	40 COM.	1986-88	18-5764	70	1986-88	—
25	1977-84	18-5758 ④	45	1991-92	18-5794	70	1989-92	18-5766

① 2 Power Packs required per engine
 ② Order 18-5756 for Power Pack w/o cover,insulated pad and mounting screws
 ③ Order 18-5757 for Power Pack w/o cover,insulated pad and mounting screws

④ All Models except Worktwin, Workhorse and Commercial Model for 1983
 ⑤ Port side only for 1983 model STLCT
 ⑥ Port side only for 1984 models with suffix beginning with "S"
 ⑦ 2 cyl. only

⑧ 3 cyl. only
 ⑨ Sea Drive Series
 ⑩ Except remote models
 ● Refer to picture
 ● For 2 stroke models only

Model	Years	Power Pack	Model	Years	Power Pack	Model	Years	Power Pack
70	1993-95	18-5774-1 ⑧	110	1986-87	18-5784-1	185	1984	18-5760 ①
70	1996-99	18-5780 ⑧	110	1988	—	185	1990, 1992	18-5893
75	1975-78	18-5754 ③	115	1969-70	—	185	1993-99	18-5781-1
75	1979-84	18-5760	115	1973-77	18-5753 ②	200	1976-78	18-5754 ③ ①
75	1985	18-5782 ⑧	115	1978-84	18-5759 ①	200	1979-83	18-5760 ①
75	1986-88	—	115	1985	18-5783	200	1987	18-5891
85	1969-72	—	120	1986	—	200, 225	1988-92	18-5893
85	1973-77	18-5753 ②	120	1988-99	18-5772-1	200, 225	1993-99	18-5781-1
85	1978-80	18-5759 ①	125	1971-72	—	225	1987	18-5891
88, 90	1986-87	18-5784-1	130	1988-99	18-5772-1	235	1978	18-5754 ③ ①
88	1988	—	135	1973-76	18-5753 ②	235	1979-84	18-5760 ① ⑤ ⑥
88,90	1989-99 Crossflow	18-5770-1	140	1977	18-5753 ②	250	1991	18-5893
90	1981-83	18-5759 ①	140	1978-83	18-5759 ①	275	1986-87	—
90	1985	18-5783	140	1986	—	300	1987	—
90	1988	—	140	1988-99	18-5772-1	300	1991	18-5893
100	1971	—	150	197-78	18-5754 ③ ①	V-8	1993-99	18-5773
100	19,681,972	—	175	1979-83	18-5760 ①	1.6L	1984 & prior	18-5759 ⑨
100	1979-80	18-5759 ①	175	1986-88	18-5761	1.6L	1985	18-5782
100	1988	—	175	1989-91	18-5885	1.6L	1986-87	18-5784-1
100, 115	1989-99 Crossflow	18-5770-1	175	1991-92	18-5886 ①	2.0L	1988-99	18-5772-1
110 (TCLDF only)	1986	18-5783	175	1993-03	18-5887	2.5, 2.6L	1986-88	18-5761 ⑨

- ① 2 Power Packs required per engine
- ② Order 18-5756 for Power Pack w/o cover,insulated pad and mounting screws
- ③ Order 18-5757 for Power Pack w/o cover,insulated pad and mounting screws
- ④ All Models except Worktwin, Workhorse and Commercial Model for 1983
- ⑤ Port side only for 1983 model STLCT
- ⑥ Port side only for 1984 models with suffix beginning with "S"
- ⑦ 2 cyl. only
- ⑧ 3 cyl. only
- ⑨ Sea Drive Series
- ⑩ Except remote models
- ① Refer to picture
- ② For 2 stroke models only

PREMIUM MARINE SPARK PLUG WIRE LEADS

Sierra's MAGFORCE Ignition Wires are "Electronics Friendly" protecting all of your electronic devices and electronic engine controls from RFI and EMI while delivering the maximum amount of voltage. Exact fit design ensures easy installation and years of trouble - free service.



Part #	OEM #	Description	Part #	OEM #	Description
18-8815-1	OMC 582365	4" Spark Plug Wire	18-5230-9-1 ①③	Universal	10" Spark Plug Wire (pkg of 5)
18-8816-1	OMC 582365	6" Spark Plug Wire	18-8839-1	—	90 & 115 hp Outboard Wire Set Two - 14" • Two - 16"
18-5231-1	OMC 582365	9" Spark Plug Wire	18-8840-1	—	150 & 175 hp Outboard Wire Set Two - 14" • Two - 16"
18-5231-1D ②	OMC 582365	9" Spark Plug Wire	18-28090	—	V6 Outboard Plug Wire Set
18-8818-1	OMC 582365	12" Spark Plug Wire	18-28092	—	V4 Outboard Plug Wire Set
18-5229-9-1 ①③	Universal	22" Spark Plug Wire (pkg of 5)			

PKG. OF 10



18-5224
18-5224-9^①
SPARK PLUG WIRE TERMINAL
 Replaces: 510364



18-5225
SPARK PLUG WIRE KIT
 Includes 25 ft Roll of Hypalon Ignition Wire with a copper conductor and a large assortment of three different end fittings to fit Johnson/Evinrude motors.



18-5226
IGNITION WIRE
(100' Spool)
 Hypalon
 Replaces: 510883, 772584

PKG. OF 10



18-5750
18-5750-9^①
UNIVERSAL SPARK PLUG BOOTS
 Supplied complete w/ Terminal Connector
 Replaces: 581027, 580339



18-5752
UNIVERSAL SPARK PLUG BOOT
 8mm



MP39100
IGNITION SWITCH
 Replaces: 386545
 (5 Terminals - 3 Position)



MP39760
IGNITION SWITCH
 Replaces: 393301, 508180
 (6 Terminals - Push to Choke - 3 Position)



MP39830
IGNITION SWITCH
 Replaces: 386545
 (6 Terminals - Pistol Shaped Key - 3 Position)
 Pollak



MP28890
IGNITION LANYARD
 Replaces: 176288
 1996-Newer



18-1282
LANYARD & CLIP
 Replaces: 398602
 Tiller Steer Models - ALL



MP28870
MP28872-1 (Bulk - 100 pc/carton)
SWITCH & LANYARD
 Replaces: 585134



MP28880
LANYARD
 Replaces: 432230
 1995-older

① Priced per package
 ② Items ending in "D" are Display Packaged - Regular number is Non-Display
 ③ Uses 7mm copper core



MP28900
MP28902-1 "Bulk" - 100 pieces per carton
LANYARD
Replaces: 432230
 1995-Older



18-5877
STATOR
Replaces: 584643, 763779
For: 185-300 HP Loopers (1993-2001)



18-5878
STATOR
Replaces: 584981, 763759
For: 150-175 HP (1993-2006)
 Gray Sleeve

JOHNSON/EVINRUDE STATOR APPLICATION

HP	Year Start	Year Stop	Stator
185	1993	1994	18-5877
200	1993	2001	18-5877
225	1993	2001	18-5877
250	1993	2001	18-5877
300	1993	1995	18-5877
150	1993	2006	18-5878
175	1993	2006	18-5878



18-6277
TILT/TRIM ASSEMBLY
Replaces: 435548
Heavy Duty, 2 Wire Connection, Flat Blade Shaft (O-ring included)
Fits: OMC V6(1993), Commercial V8 (1993-Up)



18-6823
WIRING HARNESS
Replaces: Universal
Converts 3-wire Tilt and Trim motors to 2-Wire design



18-6280
TILT/TRIM ASSEMBLY
Replaces: 437801
Heavy Duty, OMC J Suffix 40,48,50HP(1992-Up)w/ 2 Wire Connection and Hollow Hex Shaft
 (O-ring included)



18-6281
TILT/TRIM MOTOR
Replaces: 438786, 439937, 5005254
(O-ring included)
Plastic housing
Heavy Duty for OMC Outboards 75HP-250HP EFI(1998-Up)



18-6285
TILT/TRIM ASSEMBLY
Replaces: 433226
(O-ring included)
Heavy Duty OMC (1989-92) M Suffix 40,48,50HP w/ 2 Wire Connection and Hollow Hex Shaft



18-6756
TILT/TRIM MOTOR
Replaces: 172588, 173944
Fits: (1982-98) 2 cylinder 2 stroke engines that have been fitted with tilt kit 173946.



18-6759
TILT/TRIM MOTOR
Replaces: 394176, 391264, 393988, 985237
Newer 2 wire design for most 3, 4, 6 and 8 cyl. applications 1982 to present. 3 bolt.
(MOTOR ONLY)
Use 18-7510 O-ring (O-ring included)
Replaces: 321163



18-6761
TILT/TRIM MOTOR
Replaces: 387277, 582048, 582155, 584107
(O-ring included)
Older 3 wire design for most 3, 4, 6 cylinder outboards up to 1981 (Motor Only)



18-6762
TILT/TRIM MOTOR
Replaces: 172543
For most 85, 115 & 135 hp V-4 applications (Motor and Reservoir)



18-6767-1
TILT/TRIM MOTOR
Replaces: 172850, 173564, 173596
For: 1974 (115 & 135 HP)
For most 45 hp commercial models 1989-90, 2 cylinder applications (1984-88), 3 cylinder applications (1977-83) and 4 cylinder applications (1974-77) (Motor and Reservoir)
For Repair Kit use 18-6252



18-6780
TILT/TRIM MOTOR
Replaces: 438529, 438531, 434496
For: 90, 115, 200, 225 HP (1991-Up); 120, 140 HP (1991-94); 130 HP (1995-Up)



18-6815
TRIM MOTOR
Replaces: Johnson/Evinrude
Fits: 2004-09 40-50HP 2006-09 60HP, 2009 25-30HP Evinrude



18-6744
TRIM MOTOR
Replaces: 5006319
Fits: 75-90 HP (04-Up), 115 HP (07-Up), 130 HP (10-Up)



18-6816
TRIM MOTOR
Replaces: 172588, 173944
Fits: 40, 50, 70, and 75HP with short shaft



18-6252
TILT & TRIM MOTOR REPAIR KIT
For use with 18-6767-1
*** Includes Brushes**



POWER TRIM ASSEMBLIES

PART NO.	OE NO.	APPLICATION
18-6801	5005114	115-130HP, V4 (2000-09)
18-6802	5005113	135-200HP, V6, 60° (2000-09)
18-6803	5005115/5007662	200-250HP, V6, 90° (2000-09)



**18-5705
POWER TRIM RELAY**

Replaces:
582472, 584416, 586224
5 Terminal • Single Pull
Double Throw • 12 Volt

Contact	Resistive	Conductive
Open	40 Amps	30 Amps
Closed	20 Amps	15 Amps



①18-5801D



**18-5801
SOLENOID**
Replaces: 985064, 586842,
586730
Grounded Base

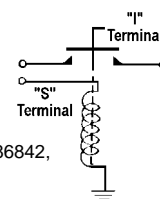

⑥18-5823D



**18-5823
SOLENOID**

Replaces: 584580
Fits: 9.9 4-stroke(1995-01), 9.9 (1993 & Up),
15 4-stroke(1995-01), 15 (1993 & Up), 8
(1996-98).

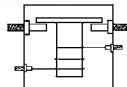

⑥18-5833D



**18-5833
SOLENOID**

Replaces: 586774
Fits: E40 (2004-07), E50 (2004-06), E60
(2006-07), E75 (2004-07), E90 (2004-07),
E115 (2007), E150 (2007), E175 (2007), E200
(2005-07), E225 (2005-07), E250 (2005-07)

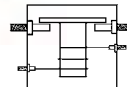

**18-5807
SOLENOID**

Replaces: 378444,
Prestolite SAW4206

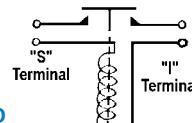

⑥18-5808D



**18-5808
SOLENOID**

Replaces: 395419, 582708

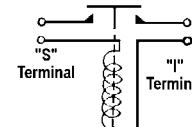

**18-5813
SOLENOID**

Replaces: 584128

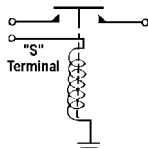

⑥18-5814D



**18-5814
SOLENOID**

Replaces: 581528, 172869

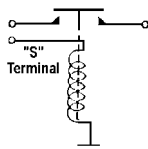

BATTERY CABLES

Gauge cable with soldered lug terminals on each end to accept 3/8" stud.

Part No.	Size	Color	Gauge	Part No.	Size	Color	Gauge
BC88523	2'	red	4	BC88563	6'	red	2
BC88533	2'	black	4	BC88573	6'	black	2
BC88543	4'	red	2	BC88583	8'	red	1
BC88553	4'	black	2	BC88593	8'	black	1

JOHNSON/EVINRUDE STARTER SOLENOID APPLICATION

HP	Year Start	Year Stop	Starter Solenoid	HP	Year Start	Year Stop	Starter Solenoid
9.9	1990	1992	18-5813	33	1968	1970	18-5808
15	1990	1992	18-5813	35	1957	1959	18-5807
18	1957	1959	18-5807	35	1976	1988	18-5808
20	1985	1998	18-5808	35	1991	2001	18-5808
25	1972	2005	18-5808	40	1960	1966	18-5807
25	2009	2009	18-5833	40	1967	1976	18-5808
28	1986	1996	18-5808	40	1984	2005	18-5808
30	1984	2005	18-5808	40	2004	2009	18-5833
30	2009	2009	18-5833	45	1989	1992	18-5808
33	1965	1967	18-5807	48	1987	1996	18-5808

① Without Electric Shift ② With Electric Shift

APPLICATION CONTINUED ON NEXT PAGE

JOHNSON/EVINRUDE STARTER SOLENOID APPLICATION (CONT.)

HP	Year Start	Year Stop	Starter Solenoid	HP	Year Start	Year Stop	Starter Solenoid
50	1958	1959	18-5807	100	1984	2001	18-5808
50	1971	1975	18-5808	105	1998	2003	18-5808
50	1979	2005	18-5808	110	1986	1989	18-5808
50	2004	2009	18-5833	112	1994	1996	18-5808
55	1968	1969	18-5808	115	1969	1970	18-5808
55	1976	1981	18-5808	115	1973	1985	18-5808
55	1989	1992	18-5808	115	1990	2006	18-5808
55	1996	1997	18-5808	115	2007	2009	18-5833
55	2008	2009	18-5833	120	1985	1994	18-5808
60	1964	1966	18-5807	125	1971	1972	18-5808
60	1967	1971	18-5808	125	1989	1990	18-5808
60	1980	2001	18-5808	125	1992	1998	18-5808
60	2006	2009	18-5833	130	1995	2000	18-5808
65	1968	1968	18-5808	130	2009	2009	18-5833
65	1972	1973	18-5808	135	1973	1976	18-5808
65	1984	2001	18-5808	135	2001	2001	18-5808
65	2008	2009	18-5833	140	1977	1994	18-5808
70	1970	2001	18-5808	150	1978	2006	18-5808
75	1960	1964	18-5807	150	2007	2009	18-5833
75	1965	1965	18-5807 ❶	155	1984	1992	18-5808
75	1965	1965	18-5808 ❷	175	1977	2006	18-5808
75	1975	1988	18-5808	175	2007	2009	18-5833
75	2004	2009	18-5833	185	1984	1985	18-5808
80	1966	1966	18-5807 ❶	185	1989	1994	18-5808
80	1966	1967	18-5808 ❷	200	1976	2001	18-5808
85	1968	1980	18-5808	200	2005	2009	18-5833
85	1991	1995	18-5808	225	1986	2001	18-5808
88	1987	1996	18-5808	225	2005	2009	18-5833
90	1964	1964	18-5807	235	1978	1985	18-5808
90	1965	1965	18-5808	250	1991	2001	18-5808
90	1981	2006	18-5808	250	2005	2009	18-5833
90	2004	2009	18-5833	275	1985	1988	18-5808
100	1966	1968	18-5808	300	1985	1995	18-5808
100	1971	1972	18-5808	300	2008	2009	18-5833
100	1979	1980	18-5808				

❶ Without Electric Shift ❷ With Electric Shift

JOHNSON/EVINRUDE TRIM RELAY/SOLENOID APPLICATION

HP	Year Start	Year Stop	Trim Relay / Solenoid	HP	Year Start	Year Stop	Trim Relay / Solenoid
60	1986	2001	18-5705	125	1989	1998	18-5705
65	1991	1995	18-5705	135	1976	1976	18-5814
70	1980	1981	18-5814	140	1977	1981	18-5814
70	1981	2001	18-5705	140	1981	1994	18-5705
75	1980	1981	18-5814	150	1978	1981	18-5814
75	1982	1987	18-5705	150	1981	2006	18-5705
75	2000	2003	18-5705	175	1977	1981	18-5814
85	1976	1980	18-5814	175	1981	2006	18-5705
85	1991	1995	18-5705	185	1984	1985	18-5705
88	1986	1996	18-5705	185	1990	1994	18-5705
90	1981	1981	18-5814	200	1976	1981	18-5814
90	1981	2006	18-5705	200	1981	1983	18-5705
100	1979	1980	18-5814	200	1986	2005	18-5705
100	1984	2005	18-5705	225	1986	2005	18-5705
110	1986	1989	18-5705	235	1978	1981	18-5814
115	1976	1981	18-5814	235	1981	1985	18-5705
115	1981	1985	18-5705	250	1991	2005	18-5705
115	1990	2006	18-5705	275	1985	1988	18-5705
120	1985	1994	18-5705	300	1985	1995	18-5705



18-5708
RECTIFIER
 Replaces: 582399, 583408
 6-10 AMP



18-5709
RECTIFIER
 Replaces: 581778
 4-5 AMP



18-5825
REGULATOR/RECTIFIER
 Replaces: 395204



18-5826
REGULATOR/RECTIFIER
 Replaces: 584890



18-5827
REGULATOR/RECTIFIER
 Replaces: 585001, 584476



18-5828
REGULATOR/RECTIFIER
 Replaces: 585219, 439561



18-5829
REGULATOR/RECTIFIER
 Replaces: 586048



18-5830
REGULATOR/RECTIFIER
 Replaces: 586075



18-5831
REGULATOR/RECTIFIER
 Replaces: 586271, 584641, 585995



18-5832
REGULATOR/RECTIFIER
 Replaces: 583266, 583689,
 586000, 584424

Model	Year	Part #	Model	Year	Part #
9.9,15	1974-92	18-5709	90	1981-92	18-5708
20	1989-98 ④	18-5709	90-115 60 DEGREE-V4	1996-UP	18-5830
25	1977-03 (2 CYL) ④	18-5709	100	1971,1979-80,1984-92 ③	18-5708
25/40/50TL/ J ELEC TR	1992	18-5827	115	1973-92	18-5708
25SIK/ SIL/ SIT	1994-1995	18-5827	120/140	1985	18-5832
25/35 3 CYL.	1995-UP	18-5826	125	1971-72	18-5708
28	1989-96	18-5709	135	1974 ⑦	18-5708
30	1989-03 (2 CYL) ④	18-5709	135	1973,1975-76	18-5708
35	1976-93 (2 CYL) ④	18-5709	140	1977-88	18-5708
35JET/ TL/ J ELEC.	1992-1993	18-5827	150	1979-88	18-5708
35JET/ M-TE/ TTL	1993-1995	18-5827	150/175 60 DEGREE-V6	1991-1995	18-5828
35JET/ EL/ TL/ TTL	1996	18-5827	150/175 60 DEGREE-V6	1996-UP	18-5829
35JET ELEC.	1997	18-5827	155	1984-88	18-5708
40	1974-76,1988-92	18-5709	175	1977-83	18-5708
40/50TE/ EL/ TL/ TTL	1993-1996	18-5827	185	1984-88	18-5708
40/ 50 ELEC. 2 CYCLE.	1993-03 (2 CYCLE.)	18-5827	185/200/225	1993-1994	18-5831
45	1989-92 COMM	18-5709	185/200/225/200COMM	1990-1992	18-5832
45SS	1989-90	18-5709	200	1976-83	18-5708
48	1989-92	18-5709	200/225	1986-1989	18-5832
50	1971-75	18-5708	200/225/200COMM	1994-1997	18-5831
50	1979-92	18-5709	235	1978-88	18-5708
55	1976-77	18-5708	250/300	1991-1995	18-5831
55	1978-81, 1980-92 ①	18-5709	250	1997	18-5831
60	1970 ⑥, 1971	18-5708	275	1985-1986	18-5832
60	1980-88	18-5709	275/300 (3.6L)	1987	18-5832
60	1989-91 ⑥	18-5708	275/300	1988	18-5832
SST60	1989-90	18-5708	300 (3.6L) — PORT & STBD.	1985-1986	18-5832
60	1992-01	18-5827	300	1989-1990	18-5832
65	1972-73, 1988-91	18-5708	1.8/2.0L V4 "S"	1987-1990	18-5832
65 ELEC.	1992	18-5827	2.7L V6	1986-1987	18-5832
70	1974-91 ②	18-5827	3.0L V6	1988-1990	18-5832
70	1992-01	18-5708	3.0L V6	1993-1998	18-5832
75	1975-88	18-5708	3.6L V8	1987	18-5832
85	1970-80	18-5708	4.0L V8	1989-1990	18-5832
88	1989-92	18-5708	V-4 & V-6 Crossflow with 35 AMP	ALL	18-5825

① Also Commercial Models
 ② 1991 EL & TL Models only
 ③ Except 1992 Models WTLNE & WTXENE

④ Electric Start only
 ⑤ D Models only

⑥ EL & TL Models only
 ⑦ 135443, 135483 Models only



18-6434
OUTBOARD STARTER
 Replaces: 386430, 763454
 Fits: 9.9,15 HP (1974-92), 8 HP 4 Stroke (1996-98)



18-5640
OUTBOARD STARTER
 Replaces: 395207, 387094, 585062, 586288, 778992
 Fits: 150-235 HP, V6 models

**ALL STARTERS ARE COUNTER CLOCKWISE ROTATION
 STARTER APPLICATION ON PAGE 266**



18-5612
OUTBOARD STARTER
 Replaces: 432925, 586287, 586286
 Fits: 175 HP models (1992)



18-5617
OUTBOARD STARTER
 Replaces: 586274, 778995
 Fits: 9.9, 15 HP models



18-5619
OUTBOARD STARTER
 Replaces: 584799, 396235, 391511, 397023, 586731, 586890
 Fits: V6/V8 Looper models



18-5624
OUTBOARD STARTER
 Replaces: 583482, 585056, 586279
 Fits: 20-35 HP models (1989 & up)



18-5627
OUTBOARD STARTER
 Replaces: 583473, 585059, 585459, 778991
 Fits: 20-35 HP models (1987-93)



18-5628
OUTBOARD STARTER
 Replaces: 393570, 585060, 586285, 778994
 Fits: 140 HP models (1993)



18-5629
OUTBOARD STARTER
 Replaces: 392133, 585061, 386591, 586278
 Fits: 18-40 HP models



18-5630
OUTBOARD STARTER
 Replaces: 387684, 585063, 389275, 384163, 586280, 778993
 Fits: 50-60 HP, 2 cyl. models



18-5631
OUTBOARD STARTER
 Replaces: 584818, 586277, 778996
 Fits: V-4, 60° models (1997 & up)



18-5632
OUTBOARD STARTER
 Replaces: 584980, 586284
 Fits: V-4, 60° models (1997 & up)



18-5634
OUTBOARD STARTER
 Replaces: 585057, 585051, 385529, 389954, 586283
 Fits: 140 HP models (1977)



18-5648
OUTBOARD STARTER
 Replaces: 585058, 586281, 386657, 391735, 585050, 384777
 Fits: 70 HP models

ALL STARTERS ARE COUNTER CLOCKWISE ROTATION
 STARTER APPLICATION ON NEXT PAGE



18-6826
STARTER

Replaces: 586768, 587045
Fits: 40-90HP E-Tec Engines



18-6863
STARTER

Replaces: 584608, 586275
Fits: Johnson/Evinrude 9.9-15HP 4-Stroke Engines



18-6945
STARTER

Replaces: 5036972
Fits: Johnson, Suzuki 25HP 2006-11



18-6250
OUTBOARD STARTER REPAIR KIT

Prestolite
2 Brush



18-6251
OUTBOARD STARTER REPAIR KIT

Prestolite
4 Brush



18-5655
DRIVE ASSEMBLY

Replaces: 321648
See next page for additional application



18-5671
DRIVE ASSEMBLY

Replaces: 384781
See next page for additional application



18-5674
DRIVE ASSEMBLY

Replaces: 387683
See chart below for additional application



18-5678
DRIVE ASSEMBLY

Replaces: 585269, 586101
See chart below for additional application



18-5679
DRIVE ASSEMBLY

Replaces: 585267, 586100
See chart below for additional application



18-5697
DRIVE BRUSH KIT

Replaces: 385952
See chart below for additional application

HP	Years	Starter #	O.E. Part #	O.E. #	Drive Assembly ②	O.E. #	Tooth Count	Drive Brush Kit ②	O.E. #
9.9/ 15	1974-92	—	386430	395264	—	319977	10	NA	NA
9.9/ 15	1993 & UP	18-5617	586274	395264	—	319977	10	NA	NA
9.9/ 15	1997 & Up 4 stroke	—	584613	NSS	18-5679 ①	585267	10	18-5697	385952
20 ⑦	1985-88	18-5629	586278	393354	18-5655	321648	11	18-5697	385952
20 thru 30 ⑦	1993-98	18-5629	586278	393354	18-5655	321648	11	18-5697	385952
25 thru 35 ⑦	1977-88	18-5629	586278	NSS	18-5655	321648	11	18-5697	385952
20 thru 30 ⑤	1989-92	18-5627	585059	393354	18-5671 ①	384781	9	18-5697	385952
25 thru 35	1997-99 3 cylinders	18-5631	586277	586100	NSS ①	NSS	10	18-5697	385952
40-50	1984-88	18-5630	586280	NSS	18-5671 ①	384781	9	18-5697	385952
50	1972	18-5630	586280	NSS	18-5671 ①	585269	9	18-5697	385952
40-50 ①	1989-99	18-5624	586279	NSS	18-5678 ①	585269	9	18-5697	385952
55	1978	18-5630	586280	NSS	18-5678 ①	585269	9	18-5697	385952
60	1985 2 cylinders	18-5630	586280	NSS	18-5678 ①	585269	9	18-5697	385952
50	1985-99 3 cylinders	18-5648	586281	NSS	18-5678 ①	585269	9	18-5697	385952
55	1969	18-5648	586281	NSS	18-5678 ①	585269	9	18-5697	385952
60	1971	18-5648	586281	NSS	18-5671* 18-5678 ①	384781	9	18-5697	385952
60	1986-01 3 cylinders	18-5648	586281	NSS	18-5678 ①	585269	9	18-5697	385952
65	1985-01 3 cylinders	18-5648	586281	NSS	18-5678 ①	585269	9	18-5697	385952
70, 75	1980-01	18-5648	586281	NSS	18-5678 ①	585269	9	18-5697	385952
85 thru 115	1973-99 crossflows	18-5634	586283	NSS	18-5679 ①	586100	10	18-5697	385952

**ALL STARTERS ARE COUNTER CLOCKWISE ROTATION
STARTER APPLICATION CONTINUED ON NEXT PAGE**

HP	Years	Starter #	O.E. Part #	O.E. #	Drive Assembly ②	O.E. #	Tooth Count	Drive Brush Kit ②	O.E. #
90, 115	1995-99 looper	18-5632	586284	NA	NA	NA	NA	18-5697	385952
120 thru 140	1985-94	18-5628	586285	NSS	18-5679 ①	586100	10	18-5697	385952
130	1995-99	18-5628	586285	NSS	18-5679 ①	586100	10	18-5697	385952
V-6 Crossflow	1976-92	18-5640	586288	393285	18-5674	387683	8	18-5697	385952
150, 175 60°	1991-99 loopers	18-5612	586286	NA	NA	NA	NA	18-5697	385952
150 thru 175 V-6	1997-03	18-5612	586287	NSS	NSS	NA	NA	NA	433850
200 thru 300	1986-Up std. rotation	18-5619	586411	397375	NA	NA	10	18-5697	385952

Note: Some starters will replace Prestolite versions however replacement parts are for Bosch versions only.
 * Starter drive retained with nut

NSS Not sold separately

① Drive kit includes drive assembly with clip style retainer

② Drive kits, drive assemblies, and brush sets offered are for "Bosch Style" starters only.

⑤ With 9 tooth pinion

⑦ For Bosch models

4-STROKE FUEL SYSTEM KITS



18-7761
CARBURETOR REBUILD KIT
 Fits: Johnson/Evinrude Four-Stroke 4-6 hp. (2007)



18-7773
CARBURETOR REBUILD KIT
 Replaces: 5032424
 Fits: 25, 30 HP (2000-01) (2004 & Up)

2-STROKE FUEL SYSTEM KITS



18-7010
CARB KIT
 Replaces: 382050, 382051, 382054



18-7024
CARB KIT
 Replaces: 382053, 382052, 385356, 439075



18-7026
CARB KIT
 Replaces: 382057



18-7042
CARB KIT
 (without float)
 Replaces: 392061, 398729, 396701



18-7222
CARB KIT
 (with float)
 Replaces: 392061, 398729, 396701



18-7043
CARB KIT
 Replaces: 382045, 382046, 382047, 382049, 383052, 383067, 398532, 439071, 398514



18-7046
CARB KIT
 Replaces: 390055, 392550, 398526, 435443, 434888, 439076, 433519
 Contains 18-7038 Needle/Seat



18-7219
CARB KIT
 Replaces: 439073, 431897



18-7221
CARB KIT
 Replaces: 435442, 438996

2-STROKE FUEL SYSTEM KITS



18-7223
CARB KIT w/ Needle & Seat
 Replaces: 398452, 391305, 398453, 439072, 391937



18-7247
CARB KIT
 Replaces: 438996, 436852
 For: V4 & V6 (60°) 1988-2001

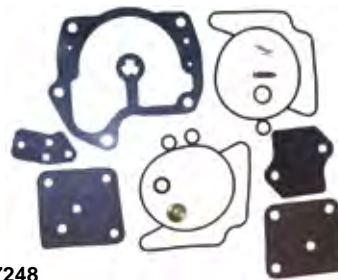

18-7248
CARB KIT
 Replaces: 437327, 439079, 439078, 435676, 435677, 435678, 435752



18-0871
SERVICE VALVE WITH O-RING
 Replaces: 175158
 Fits: All Johnson/Evinrude with primer valve (except 1993 9.9 & 15hp.)



18-7044
SERVICE VALVE KIT
 Replaces: 175158+437228
 Fits: All Johnson/Evinrude with primer valve (except 1993 9.9 & 15 H.P.)



18-0993
COVER & GASKET ASSEMBLY
 Replaces: 437228
 Fits: All Johnson/Evinrude with primer valve (except 1993 9.9 & 15hp.)



NEEDLE & SEAT

Part #	Replaces
18-7093	396521, 678882, 378895
18-7094	379313, 396522
18-7038	396520, 379312, 387262

PKG. OF 10



18-7106
18-7106-9^①
NEEDLE PACKING
 Replaces: 307583



18-7210
FLOAT
 Replaces: 382363

PKG. OF 5



18-7296
18-7296-9^①
ADJUSTING NEEDLE RETAINER
 Replaces: 315232

① Priced per Package

HP	YEAR	CARB. KIT W/O FLOAT	CARB. KIT W/ FLOAT	NEEDLE & SEAT	CARB. FLOAT
1.5	1970-90	18-7043	—	18-7094	—
2	1970-90	18-7043	—	18-7094	—
3	1952-67	18-7043	—	18-7038	—
3	1968	18-7043	—	18-7094	—
4	1983-89	18-7223	—	18-7094	—
4	1991-93	18-7223	—	18-7094	—
4.5	1982-84, 1987	18-7223	—	18-7094	—
5	1965-67	18-7043	—	18-7094	—
5	1968	18-7024	—	18-7093	—
5	1984-85	18-7223	—	18-7094	—
5.5	1954-67	18-7043	—	18-7094	—
6	1954-79	18-7043	—	18-7094	—
6	1968	18-7024	—	18-7093	—
6	1984-85	18-7223	—	18-7094	—
6.8	1986-96	18-7219	—	—	—
7.5	1955-58	18-7043	—	18-7094	—
7.5	1982-83	18-7223	—	18-7094	—
8	1984-85	18-7223	—	18-7094	—
9.9	1974-88	18-7223	—	18-7094	—

① Commercial ② Also Commercial ③ Early Production ④ Cross Flow ⑤ Except 1995-Up 3 Cylinder Models

HP	YEAR	CARB. KIT W/O FLOAT	CARB. KIT W/ FLOAT	NEEDLE & SEAT	CARB. FLOAT
9.9/15	1989-96	18-7219	—	—	—
10	1954-63	18-7043	—	18-7094	—
14	1968 ③	18-7223	—	18-7094	—
15	1955-56	18-7043	—	18-7094	—
15	1974-88	18-7223	—	18-7094	—
18	1957-68	18-7043	—	18-7094	—
18	1969-73	18-7042	18-7222	18-7093	18-7210
20	1957-68	18-7043	—	18-7094	—
20	1969-90	18-7042	18-7222	18-7093	18-7210
20	1991-96	18-7219	—	18-7094	—
25	1954-55	18-7024	—	18-7093	—
SAIL DR	1978-UP	18-7042	18-7222	18-7093	18-7210
25	1969-95 ⑤	18-7042	18-7222	18-7093	18-7210
28	1962-64	18-7010	—	18-7093	—
28	1976-95	18-7042	18-7222	18-7093	18-7210
30	1956	18-7024	—	18-7093	—
30	1976-UP	18-7042	18-7222	18-7093	18-7210
33	1965-70	18-7010	—	18-7093	—
35	1957-59	18-7024	—	18-7093	—
35	1959	18-7010	—	18-7093	—
35	1976-95 ⑤	18-7042	18-7222	18-7093	18-7210
40	1960-63, 1971	18-7010	—	18-7093	—
40	1965-70, 1972-78	18-7024	—	18-7093	—
40	1971-90, 1979-92 ①	18-7042	18-7222	18-7093	18-7210
45	1971-97 ②	18-7042	18-7222	18-7093	18-7210
48	1992-97	18-7042	18-7222	18-7093	18-7210
50	1958-59	18-7026	—	18-7093	—
50	1971-97	18-7042	18-7222	18-7093	18-7210
55	1968-69, 1971-97 ②	18-7042	18-7222	18-7093	18-7210
60	1964-67	18-7026	—	18-7093	—
60	1970-97	18-7042	18-7222	18-7093	18-7210
65	1972-97	18-7042	18-7222	18-7093	18-7210
70	1972-97 (3 CYL)	18-7042	18-7222	18-7093	18-7210
75	1960-63	18-7026	—	18-7093	—
75	1975-88	18-7042	18-7222	18-7093	18-7210
80	1966-67	18-7026	—	18-7093	—
85	1968	18-7026	—	18-7093	—
85	1971-79	18-7046	—	18-7093	—
85	1969-70, 1991-93	18-7046	—	18-7038	—
V-4	1969-79	18-7046	—	18-7038	—
V-4	1983-84	18-7046	—	18-7038	—
88,90	1985-95	18-7046	—	18-7038	—
90	1981-82, 1983 ③	18-7046	—	18-7038	—
90	1995-02	18-7247	—	—	—
100	1971, 1980	18-7046	—	18-7038	—
100	1972, 1979	18-7046	—	18-7093	—
100	1998-01	18-7247	—	—	—
105	1999-01	18-7247	—	—	—
115	1969, 1980-95	18-7046	—	18-7038	—
115	1995-02	18-7046	—	18-7093	—
115	1995-02	18-7247	—	—	—
V-6	1976-90 ④	18-7046	—	18-7038	—
115	1983	18-7046	—	18-7038	—
120	1985-90	18-7248	—	18-7094	—
120	1985-90, 1993	18-7248	—	18-7094	—

① Commercial ② Also Commercial ③ Early Production ④ Cross Flow ⑤ Except 1995-Up 3 Cylinder Models

HP	YEAR	CARB. KIT W/O FLOAT	CARB. KIT W/ FLOAT	NEEDLE & SEAT	CARB. FLOAT
125	1971-72	18-7046	—	18-7093	—
125	1993	18-7248	—	18-7094	—
125C	1989-95	18-7248	—	18-7094	—
135	1973-76	18-7046	—	18-7093	—
140	1977, 1980-83	18-7046	—	18-7038	—
140	1978-79	18-7046	—	18-7093	—
140	1985-90	18-7248	—	18-7094	—
140	1993	18-7248	—	18-7094	—
150	1979-90	18-7046	—	18-7038	—
150	1992-96, 1998-02	18-7247	—	—	—
155	1984-93 ①	18-7046	—	18-7038	—
175	1977-91	18-7046	—	18-7038	—
175	1992-96, 1998-02	18-7247	—	—	—
185	1984	18-7046	—	18-7038	—
185	1989-93	18-7221	—	18-7094	—
200	1976-83	18-7046	—	18-7038	—
200	1986-90	18-7248	—	18-7094	—
200	1992-93	18-7221	—	18-7094	—
225	1986-90, 1992-93	18-7221	—	18-7094	—
235	1978-84	18-7046	—	18-7038	—
250	1991-93	18-7221	—	18-7094	—
275\3.6L	1985-88	18-7221	—	18-7094	—
300	1988, 1991-93	18-7221	—	18-7094	—

① Commercial ② Also Commercial ③ Early Production ④ Cross Flow ⑤ Except 1995-Up 3 Cylinder Models



18-7350
FUEL PUMP
Replaces: 397839, 391638, 395091, 397274
For: 6/8/9.9/15 HP 1981-92
Uses kit **18-7823**



18-7351
FUEL PUMP
Replaces: 434728, 438562
For: 9.9/15 HP 1993-2006
Uses kit **18-7800**



18-7352
FUEL PUMP
Replaces: 438556, 388268, 385781, 394543, 382354, 395713, 398338, 432451, 398387, 433387
For: 25-55 HP 1976-89 (non-VRO)
Uses kit **18-7821**



18-7353
FUEL PUMP
Replaces: 438555, 433386
For: 20-30 HP 1990-2000
Uses kit **18-7800**



18-7800
FUEL PUMP KIT
Replaces: 438616, 433519



18-7801
FUEL PUMP KIT
Replaces: 379777



18-7820
FUEL PUMP KIT
Replaces: 393103



18-7821
FUEL PUMP KIT
Replaces: 398514, 395867



18-7822
FUEL PUMP KIT
Replaces: 432962

Display Package



18-7823
FUEL PUMP KIT
Replaces: 393088

PKG. OF 2



18-7796
18-7796-9④
CHECK VALVE
Replaces: 335334
(Enlarged to show detail)



18-3497
DIAPHRAGM KIT
Replaces: 5033372
4-5 HP (2003-06), 6 HP (2005-06)
4-Stroke



18-3498
DIAPHRAGM KIT
Replaces: 5036216, 5037584
10-15 HP (2005-07)
4-Stroke



18-3499
DIAPHRAGM KIT
Replaces: 5030699
9.9,15 HP (2002-04), 25HP (2004-06),
30HP (2004-07), 40-70 HP (2002-06)
4-Stroke

FUEL PUMP REPAIR KIT APPLICATION

ALL KITS ARE FOR NON-VRO (VARIABLE RATIO OILING) PUMPS

HP	Year Start	Year Stop	Fuel Pump Repair Kit	HP	Year Start	Year Stop	Fuel Pump Repair Kit	HP	Year Start	Year Stop	Fuel Pump Repair Kit
2.5	1987	1988	18-7823	25	2001	2001	18-3497④	50	1990	2012	18-7800
3	1989	1997	18-7823	25	2004	2005	18-3497④	50	AA	AG	18-7800
4	1982	2001	18-7823	28	1962	1963	18-7801	50	1999	2006	18-3497④
4	2003	2007	18-3497④	28	1986	1987	18-7821	55	1983	1984	18-7820
4.5	1982	1987	18-7823	28	1988	1990	18-7822①	55	1985	1990	18-7821
5	1982	1983	18-7823	28	1990	1998	18-7800	55	1991	2005	18-7800
5	1985	1993	18-7823	30	1984	1984	18-7820	55	2008	2012	18-7800
5	1996	1998	18-7823	30	1985	1987	18-7821	55	AA	AG	18-7800
5	2003	2007	18-3497④	30	1988	1990	18-7822①	60	1964	1967	18-7801
6	1984	2005	18-7823	30	1990	2005	18-7800②	60	1982	1984	18-7820
6	1987	1987	18-7821	30	2001	2001	18-3497④	60	1985	1985	18-7821
6	2003	2007	18-3497④	30	2004	2007	18-3497④	60	1988	1988	18-7821
7.5	1980	1983	18-7823	35	1958	1959	18-7801	60	2002	2006	18-3497④
8	1982	2005	18-7823	35	1976	1984	18-7820	60	2005	2012	18-7800
8	1987	1987	18-7821	35	1986	1987	18-7821	60	AA	AG	18-7800
9.9	1974	1992	18-7823	35	1988	1990	18-7822①	65	1984	1984	18-7820
9.9	1987	1990	18-7821②	35	1990	2001	18-7800	65	1985	1985	18-7800④
9.9	1990	1999	18-7800	40	1960	1964	18-7801	65	1985	1986	18-7821
10	1996	2007	18-7800	40	1971	1976	18-7820	65	1989	1989	18-7821
10	2002	2004	18-3497④	40	1983	1984	18-7820	65	1991	2001	18-7800
10	2005	2007	18-3497④	40	1985	1987	18-7821	65	2008	2012	18-7800
14	1988	1989	18-7823	40	1988	1990	18-7822①	65	AA	AF	18-7800
15	1974	1998	18-7823	40	1990	2012	18-7800②	70	1982	1984	18-7820
15	1987	1990	18-7821②	40	AA	AG	18-7800	70	1998	2006	18-3497④
15	1990	2007	18-7800	40	1999	2006	18-3497④	75	1960	1965	18-7801
15	2002	2004	18-3497④	45	1958	1959	18-7801	75	1982	1984	18-7820
15	2005	2007	18-3497④	45	1986	1990	18-7821	75	2004	2012	18-7800
20	1985	1987	18-7821	45	1991	1997	18-7800	75	AA	AF	18-7800
20	1988	1990	18-7822①	48	1987	1987	18-7821	80	1966	1967	18-7801
20	1990	1998	18-7800②	48	1988	1990	18-7822①	85	1977	1983	18-7820
25	1971	1976	18-7823	48	1990	1996	18-7800②	88	1987	1990	18-7821①
25	1977	1984	18-7820	50	1958	1959	18-7801	88	1990	1996	18-7800②
25	1985	1987	18-7821	50	1982	1984	18-7820	90	1964	1965	18-7801
25	1988	1990	18-7822①	50	1985	1987	18-7821	90	1981	1983	18-7820
25	1990	2005	18-7800②	50	1988	1990	18-7822	90	1997	1998	18-7800

④ Priced per Package

FUEL PUMP REPAIR KIT APPLICATION

ALL KITS ARE FOR NON-VRO (VARIABLE RATIO OILING) PUMPS

HP	Year Start	Year Stop	Fuel Pump Repair Kit	HP	Year Start	Year Stop	Fuel Pump Repair Kit	HP	Year Start	Year Stop	Fuel Pump Repair Kit
90	2004	2012	18-7800	112	1994	1996	18-7800	150	1978	1984	18-7820
90	AA	AF	18-7800	115	1982	1983	18-7820	175	1977	1983	18-7820
100	1966	1966	18-7801	115	1997	1998	18-7800	200	1977	1983	18-7820
100	1989	1990	18-7821	115	2004	2005	18-7800	235	1978	1984	18-7820
100	1996	1997	18-7800	125	1995	1998	18-7800				
105	1997	2003	18-7800	140	1977	1983	18-7820				

④ Priced per Package

APPLICATION CONTINUED ON NEXT PAGE

FUEL PUMP APPLICATION

HP	Year Start	Year Stop	Fuel Pump	HP	Year Start	Year Stop	Fuel Pump
6	1988	1991	18-7350	35	1990	1994	18-7353
8	1988	1991	18-7350	35	1996	1996	18-7353
9.9	1981	1992	18-7350	40	1968	1976	18-7352
9.9	1993	1999	18-7351	40	1983	1984	18-7352
10	1997	1998	18-7351	50	1974	1975	18-7352
10	2000	2001	18-7351	50	1979	1984	18-7352
10	2003	2007	18-7351	55	1976	1981	18-7352
15	1981	1998	18-7350	55	1983	1984	18-7352
15	1993	2007	18-7351	60	1980	1984	18-7352
20	1990	1998	18-7353	85	1977	1980	18-7352
25	1977	1984	18-7352	90	1981	1983	18-7352
25	1990	2005	18-7353	90	1997	1998	18-7352
28	1990	1996	18-7353	100	1979	1980	18-7352
30	1984	1984	18-7352	100	1997	1997	18-7352
30	1990	2005	18-7353	115	1977	1983	18-7352
33	1968	1970	18-7352	115	1997	1998	18-7352
35	1976	1984	18-7352	140	1977	1983	18-7352

FUEL WATER SEPARATOR KITS



21 MICRON FILTER KITS FOR CARBURETED ENGINES



KIT TYPE	PART #	MICRON RATING	CONTENTS
1/4" ALUMINUM (SHORT FILTER)	18-7848-1 •	21	1 - 18-7844 filter & 1 18-7853-1 bracket 2 - 18-4256 1/4" PIPE PLUGS
1/4" ALUMINUM BONUS PACK CONTAINS SPARE FILTER	18-7848-2 •	21	2 - 18-7844 FILTER & 1 18-7853-1 BRACKET 2 - 18-4256 1/4" PIPE PLUGS
1/4" ALUMINUM (TALL FILTER) CONTAINS SPARE FILTER	18-7852-1 •	21	1 - 18-7845 FILTER & 1 18-7853-1 BRACKET 2 - 18-4256 1/4" PIPE PLUGS
3/8" ALUMINUM (TALL FILTER)	18-7775-1 •	21	1 - 18-7845 FILTER & 1 18-7775 BRACKET 2 - 18-4264 3/8" PIPE PLUGS
1/4" STAINLESS STEEL (TALL FILTER)	18-7777-1 •	21	1 - 18-7845 FILTER & 1 18-7777 BRACKET 2 - 18-4256 1/4" PIPE PLUGS
3/8" STAINLESS STEEL (TALL FILTER)	18-7776-1 •	21	1 - 18-7845 FILTER & 1 18-7776 BRACKET 2 - 18-4264 3/8" PIPE PLUGS

• Display Packaged

**- UNIVERSAL DESIGN -
DIRECT REPLACEMENT FOR MERCURY AND YAMAHA
FUEL WATER SEPARATOR BRACKETS**



Bracket Type	Part #
1/4" Stainless Steel	18-7777
3/8" Stainless Steel	18-7776



Bracket Type	Part #
1/4" Aluminum	18-7853-1
3/8" Aluminum	18-7775

10 MICRON FILTER KITS FOR FUEL INJECTED ENGINES

• Display Packaged

Kit Type	Part #	Micron Rating	Contents
1/4" Aluminum (Short Filter)	18-7983-1 •	10	1 - 18-7944 filter & 1 18-7853-1 bracket 2 - 18-4256 1/4" pipe plugs
1/4" Aluminum Bonus Pack Contains spare filter	18-7983-2 •	10	2 - 18-7944 filter & 1 18-7853-1 bracket 2 - 18-4256 1/4" pipe plugs
1/4" Aluminum (Tall Filter)	18-7982-1 •	10	1 - 18-7945 filter & 1 18-7853-1 bracket 2 - 18-4256 1/4" pipe plugs
1/4" Aluminum Bonus Pack Contains spare filter	18-7982-2 •	10	2 - 18-7945 filter & 1 18-7853-1 bracket 2 - 18-4256 1/4" pipe plugs
1/4" Aluminum (High Capacity Filter)	18-7966-1 •	10	1 - 18-7866 filter & 1 18-7853-1 bracket 2 - 18-4256 1/4" pipe plugs
3/8" Aluminum (Tall Filter)	18-7986-1 •	10	1 - 18-7945 filter & 1 18-7775 bracket 2 - 18-4264 3/8" pipe plugs
1/4" Stainless Steel (Tall Filter)	18-7984-1 •	10	1 - 18-7945 filter & 1 18-7777 bracket 2 - 18-4256 1/4" pipe plugs
3/8" Stainless Steel (Tall Filter)	18-7985-1 •	10	1 - 18-7945 filter & 1 18-7776 bracket 2 - 18-4264 3/8" pipe plugs



10 MICRON FILTER KITS WITH DRAIN BOWLS

Sierra AquaVue™ and metal bowl separator filters allow water to be drained from the filter to extend service life. Use the AquaVue™ bowl for outboard, above deck installations. USCG regulations require the use of the flame resistant metal bowl below deck.

Kit Type	Part #	Micron Rating	Contents
1/4" Aluminum w/ AquaVue™ bowl	18-7932-1 •	10	1 - 18-7919 filter & 1 18-7853-1 bracket 1 - 18-7922-1 AquaVue™ bowl 2 - 18-4256 1/4" pipe plugs
1/4" Aluminum w/ metal drain bowl	18-7951 •	10	1 - 18-7919 filter & 1 18-7853-1 bracket 1 - 18-7924 metal bowl 2 - 18-4256 1/4" pipe plugs
1/4" Stainless Steel w/ AquaVue™ bowl	18-7937-1 •	10	1 - 18-7919 filter & 1 18-7777 bracket 1 - 18-7922-1 AquaVue™ bowl 2 - 18-4256 1/4" pipe plugs
1/4" Stainless Steel w/ metal drain bowl	18-7938 •	10	1 - 18-7919 filter & 1 18-7777 bracket 1 - 18-7924 metal bowl 2 - 18-4256 1/4" pipe plugs

COMPACT BRACKET AND SEPARATOR KIT - FOR SMALL OUTBOARDS AND FRESH WATER APPLICATIONS

**18-7774
COMPACT ALUMINUM BRACKET**



**18-7965-1
10 MICRON COMPACT
SEPARATOR KIT**
Contains:
1 - 18-7774 bracket
1 - 18-7865 filter



• Display Packaged

REPLACEMENT FILTERS



UNIVERSAL DESIGN

10 MICRON REPLACEMENT FILTERS

21 MICRON REPLACEMENT FILTERS

Part No.	Description	Part No.	Description
18-7944	Short - 3.875"	18-7844	Short - 3.875"
18-7945	Long - 4.35"	18-7845	Long - 4.35"
18-7866	High Capacity - 6"		
18-7865	Compact 10 Micron		

REPLACEMENT FILTERS FOR OMC

10 MICRON REPLACEMENT FILTERS

21 MICRON REPLACEMENT FILTERS

Part No.	Description	Replaces	Part No.	Description	Replaces
18-7946	OMC thread	OMC 502905	18-7846	OMC thread	OMC 502905
18-7989	Cobra EFI	OMC 502906	18-7789	Cobra EFI	OMC 502906



• Display Packaged

10 MICRON REPLACEMENT FILTERS AND KITS WITH DRAIN BOWLS

REPLACEMENT ELEMENTS

ELEMENT & BOWL KITS

Part No.	Description	Replaces	Part No.	Description						
18-7919	Spin on replacement	Racor S3213	18-7928-1 •	Filter & AquaVue™ Bowl Contains: 18-7919 filter, 18-7922-1 bowl						
18-7920	Spin on replacement OMC style	OMC 502906 Racor S3214	18-7929 •	Filter & Metal Bowl Contains: 18-7919 filter, 18-7924 bowl						
<h3 style="text-align: center;">REPLACEMENT BOWLS</h3> <table border="1"> <thead> <tr> <th>Part No.</th> <th>Description</th> </tr> </thead> <tbody> <tr> <td>18-7922-1</td> <td>AquaVue™ Collection Bowl</td> </tr> <tr> <td>18-7924</td> <td>Metal Collection Bowl</td> </tr> </tbody> </table>			Part No.	Description	18-7922-1	AquaVue™ Collection Bowl	18-7924	Metal Collection Bowl	18-7941-1 •	Filter & AquaVue™ Bowl Contains: 18-7920 filter, 18-7922-1 bowl
			Part No.	Description						
18-7922-1	AquaVue™ Collection Bowl									
18-7924	Metal Collection Bowl									
18-7943 •	Filter & Metal Bowl Contains: 18-7920 filter, 18-7924 bowl									



**18-79781
FUEL FILTER**
Replaces: 433190
60° V4 and V6



**18-7953
FUEL FILTER**
Replaces: 5035974
Fits: 25HP (2006-07) / 90,115,140
4 stroke (2005-06)



**18-7716
FUEL FILTER**
Replaces: 5032323
Fits: Johnson 25 4-Stroke (2004-05), 30
4-Stroke (2004-07), 40/60/70 4-Stroke
(2002-06), 90/115/140 4-Stroke (2003-04,
2006), Evinrude 25/30/40/50/70 4-Stroke
(2000-01)



**18-7719
FUEL FILTER**
Replaces: 5032238
Fits: Johnson 4/5 (2003-07), 6 4-Stroke
(2005-07), 10/15 4-Stroke (2002-07),
40/50/60/70 4-Stroke (2002-06), Evin-
rude 40/50 4-Stroke (2000-01)



**18-7722
FUEL FILTER**
• 3/8" barbs
Replaces: 5005266
For: E-Tec 40, 50, 60, 75, 90,115, 150, 175 & 200DPL



**18-7826
FUEL FILTER**
Replaces: 305185



INLINE FUEL FILTERS

Part No.	Application
18-7828-1 •	1/4" Small Capacity (For 1/4" Fuel Line)
18-7829	1/4" Large Capacity (For 1/4" Fuel Line)
18-7830	5/16" Replaces: OMC 398327
18-7831	3/8" Replaces: OMC 398319

8' LENGTH COMPLETE FUEL LINE ASSEMBLIES

3/8" FUEL LINE ASSEMBLY **18-8009EP-2 SILVERADO 4000 Premium** **OE# 398549**



18-8063 TANK CONNECTOR
(SOLD SEPARATELY)



18-8092 FUEL CONNECTOR



18-8005EP-1 PRIMER BULB



18-8092 FUEL CONNECTOR

FUEL LINE ASSEMBLY COMPONENTS
Fits: 2 HP (1 cyl.) - 75 HP (3 cyl.) (1976-02)

8' LENGTH COMPLETE FUEL LINE ASSEMBLIES

3/8" FUEL LINE ASSEMBLY **18-8014EP-2 SILVERADO 4000 Premium** **OE# 174509**



18-8074 HOSE BARB
(SOLD SEPARATELY)



18-8005EP-1 PRIMER BULB



18-8092 FUEL CONNECTOR



FUEL LINE ASSEMBLY COMPONENTS
Fits: All V6 & V8 (1976-02)



18-8004EP-1
18-8004-10EP-1
PRIMER BULB
5/16"
Replaces: 174511, 775638
Large capacity bulb



18-8005EP-1
18-8005-10EP-1
PRIMER BULB
3/8"
Replaces: 174512
Large capacity bulb

HOSE BARB APPLICATION

INLINE FUEL FILTERS				
Part No.	OMC No.	Barb	NPT	Conn. Type
18-8055	173311	5/16"	1/4"	Male
18-8074	173312	3/8"	1/4"	Male



18-8056
18-8056-10
FUEL CONNECTOR
5/16"
Replaces: 174508, 775640
Mates with 18-8063



18-8063
18-8063-10
TANK CONNECTOR
Replaces: 502867, 772681, 0772681
(1/4" NPT)
Mates with 18-8056 & 18-8092



18-8072
FUEL ELBOW
3/8" Barb w/ 3/8" NPT Thread
Replaces: 174177
90°



18-8092
FUEL CONNECTOR
3/8"
Replaces: 176445, 775641
Mates with 18-8063



18-3290
INDICATOR ELBOW
Replaces: 321886
Pipe threaded to hose



BLEEDER HOSE

18-8048 **18-8050**
.090 I.D. x .220 O.D. .0625 I.D. x .190 O.D.



18-8051
FUEL LINE HOSE
1/8" I.D.
Replaces: 322656
For OMC Pressurized Systems



18-8052
FUEL LINE HOSE
3/16" I.D.
Replaces: 122838
Non-Pressurized Systems

SAE J1527 USCG Type B1-15 SILVERADO 4000



16-337-0560
5/16" I.D.
16-337-0380
3/8" I.D.
Also available in 50' reels.

***** Tanks and Engines for picture purpose only.

① Discount shop pack of 10 - Priced per package



18-9125
OETIKER CLAMP KIT
Replaces: 787133, 787145

Part #	Qty	Johnson/Evinrude #	Oetiker #	Description	
18-9141	1	787145	14100082	Oetiker Jaw Pincers	
				Nominal ID	
Part #	Qty	Johnson/Evinrude #	Oetiker #	Inches	mm
18-9126-9	10	346930	16700004	3/8"	9.5
18-9127-9	10	348838	16700006	13/32"	10.5
18-9128-9	10	349516	16700007	7/16"	11.3
18-9129-9	10	347107	16700010	1/2"	13.3
18-9130-9	10	347108	16700011	17/32"	13.8
18-9131-9	10	346931	16700012	35/64"	14
18-9132-9	10	346785	16700013	9/16"	14.5
18-9133-9	10	346786	16700016	5/8"	15.7
18-9134-9	10	348839	16700017	11/16"	17
18-9135-9	10	346151	16700024	13/16"	21
18-9136-9	10	346152	16700031	1"	25.6
18-9137-9	10	346153	16700037	1 3/16"	30.1
18-9138-9	10	349759	16700040	1 1/4"	31.6
18-9139-9	10	349729	16700053	1 5/8"	41
18-9140-9	10	346150	16700020	23/32"	18.5

All clamps are standard package of 10. Each package of 10 is available individually.

PKG. OF 10



SNAPPER CLAMPS

Part No.	Clamp O.E. No.	Range	Size
① 18-8020	322652	.538 - .608	8
① 18-8021	911616	.597 - .665	10
① 18-8034	329654	.670 - .780	12
① 18-8200	322653	.360 - .406	2
① 18-8201	124249	.410 - .468	4
① 18-8202	322654	.475 - .536	6
① 18-8203*	329653	.750 - .875	14
① 18-8204*	324825	.875 - .975	19



56507
LOCTITE® PST 6ML
PIPE SEALANT
Replaces: 910048
(with Teflon®)



18-3001
IMPELLER
Replaces: 277181, 434424



18-3002
IMPELLER
Replaces: 375638, 775518



18-3003
IMPELLER
Replaces: 377178, 775519



18-3006
IMPELLER
Replaces: 378891, 775521



18-3015
IMPELLER
Replaces: 396852, 433935, 797407
With Key
For: 2.5, 3, 4 Ultra, Excel



18-3043
IMPELLER
Replaces: 389642



18-3044
IMPELLER
Replaces: 385072





















18-3050
18-3050-10①
IMPELLER
Replaces: 386084



18-3051
IMPELLER
Replaces: 395289

① This product is priced per piece. To order price per package, please add -9 to the part number.

 <p>18-8904 IMPELLER Replaces: 5031417 Fits: 25-30HP (2000-01, 2004-07), 40-50HP (1999-06)</p>	 <p>18-8906 IMPELLER Replaces: 436137 Fits: 5HP (1996-98), 6-8HP (1991-2005)</p>	 <p>18-8907 IMPELLER Replaces: 5033542 Fits: 90, 115, 140 (2003-06)</p>	
 <p>18-3053-1 IMPELLER Replaces: 396725 Wedge Key</p>	 <p>18-3055 IMPELLER Replaces: 389589</p>	 <p>18-3059 18-3059-10^① IMPELLER Replaces: 381538, 389289, 394534, 395864, 397131, 435821, 435748, 439948, 5001593 Includes 18-3299 Impeller Key</p>	 <p>18-3082 IMPELLER Replaces: 382547 Slotted Key</p>
 <p>18-3083 IMPELLER Replaces: 377230, 777213</p>	 <p>18-3090 IMPELLER Replaces: 387361, 763735</p>	 <p>18-3091 IMPELLER Replaces: 389576</p>	 <p>18-3099 IMPELLER Replaces: 5033112 For: 4 Stroke 9.9 and 15 HP (2002-up)</p>
 <p>18-3104-1 IMPELLER Replaces: 432941, 437059, 765350</p>	 <p>18-3366 IMPELLER Replaces: 390286</p>	 <p>18-3368 IMPELLER Replaces: 396809</p>	 <p>18-45312 IMPELLER Replaces: 114812 Fits: J/E 2(1993-99), 3(1991-99)</p>
 <p>18-4539 IMPELLER Replaces: 5008967 Fits: 15 (AA-AF), 25 (AA-AF), 30 (AA-AF)</p>	 <p>18-45221 IMPELLER Replaces: 382221 Fits: Johnson Evinrude 1.5/2 hp (1967-84)</p>	 <p>18-3102 IMPELLER PLATE Replaces: 305303</p>	 <p>18-3103 IMPELLER PLATE Replaces: 303069</p>

APPLICATION BEGINS ON PAGE 285

① Discount shop pack of 10 - Priced per package



18-3127
IMPELLER PLATE
Replaces: 319275



18-3182
IMPELLER PLATE
Replaces: 317841



18-3346
CUP & PLATE ASSEMBLY
Replaces: 435027



18-3359
WEAR PLATE
Replaces: 328755



18-3126
WEAR PLATE
Replaces: 321940



18-3178
WEAR PLATE
Replaces: 318995



18-3343
WEAR PLATE
Replaces: 320981



18-3358
INSERT CUP
Replaces: 328751



18-3455
INSERT CUP
Replaces: 340619
For: 40, 50, 25 Jet, 30 Jet 1995-Up,
E-Tec 40/50/60 HP All



18-3179
WATER PUMP CUP
Replaces: 324097



18-3501
DIAPHRAGM & CUP ASSEMBLY
Replaces: 435957
For: 8 (1996-97), 10 (1996-97), 15 (1996-97),
40 (1995-97), 50 (1995-97), 55 (1995-97),
60 (1993-96), 65 (1993-96), 70 (1993-96),
120 (1993-94), 125 (1993-95), 130 (1995-96),
140 (1993-94), 250 (1994-95), 300 (1994-95)

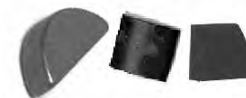

IMPELLER KEYS

Part No.	Replaces	Std. Pkg
18-3295 ③	330619, 344470	3
18-3138 ① ③	334897	2
18-3108	308928	1
18-3299 ③	331107	5
18-3326	300611	1

① Pkg of 2 ② Pkg of 3

APPLICATION BEGINS ON PAGE 285

③ This product is priced per piece. To order priced per package, please add -9 to the part number.



18-3180
WATER PUMP HOUSING
Replaces: 435390



18-3129
WATER PUMP HOUSING
Replaces: 435673, 438591, 436954, 432955



18-3336
WATER PUMP HOUSING
Replaces: 384087



18-3363
WATER PUMP HOUSING
Replaces: 330560



18-3367
WATER PUMP HOUSING
Replaces: 393632



18-3405
WATER PUMP HOUSING
Replaces: 435959

New



18-4568
IMPELLER HOUSING
Replaces: 5007554
Fits: 90 (2013 & Up), 115/130 (2009 & Up)

New



18-4569
IMPELLER HOUSING
Replaces: 339720

New



18-4571
IMPELLER HOUSING
Replaces: 360347
Fits: 200-300HP (2009 & Up)



18-3201
IMPELLER REPAIR KIT
Replaces: 379763

— CONTAINS —

Part #	Desc.	O.E. #	Qty.
18-3001	Impeller	277181, 434424	1
NSS	Plate	203132	1



18-3202
IMPELLER REPAIR KIT

— CONTAINS —

Part #	Desc.	O.E. #	Qty.
18-3001	Impeller	277181, 434424	1
18-3102	Impeller Plate	305303	1



18-3203
IMPELLER REPAIR KIT
Replaces: 379766, 379766

— CONTAINS —

Part #	Desc.	O.E. #	Qty.
18-3002	Impeller	375638	1
18-3103	Impeller Plate	303069	1

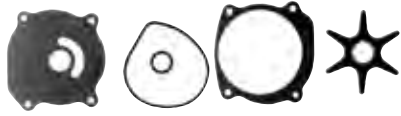

18-3210
IMPELLER REPAIR KIT

— CONTAINS —

Part #	Desc.	O.E. #	Qty.
18-3043	Impeller	389642	1
18-2536	Rubber Seal	321120	1
18-2557	Impeller Gasket	324701, 338484	1
18-7158	O-Ring	310967, 310585	1

New



18-8905
IMPELLER REPAIR KIT
Replaces: 5008968
For: 15HP (2011 & Up), 25-30HP (2009, 2011 & Up)

— CONTAINS —

Part #	Desc.	O.E. #	Qty.
18-3295	Key	344470	1
18-4539	Impeller	5008967	1
18-5701	Spring, Pressure Relief	355169	1
18-5703	Spring, Thermostat	355209	1

APPLICATION BEGINS ON PAGE 285

③ This product is priced per piece. To order priced per package, please add -9 to the part number.

①18-3211D



18-3211
IMPELLER REPAIR KIT

— CONTAINS —

Part #	Desc.	O.E. #	Qty.
18-3059	Impeller	395864, 397131, 435821	1
18-2536	Rubber Seal	321120	1
18-2557	Impeller Gasket	324701, 338484	1
18-3299	Impeller Key	331107	1
18-7158	O-Ring	310967, 310585	1
18-3138	Impeller Key	334897	1



18-3238
WATER PUMP KIT
Replaces: 388891

— CONTAINS —

Part #	Desc.	O.E. #	Qty.
18-3051	Impeller	395289	1
18-0446	Water Pump Gasket	323311	1
18-0445	Water Pump Gasket	323312	1
18-2030	Oil Seal	321786	1
18-7105	O-Ring	311338	2
18-3133	Stainless Steel Bolt	331979	4



18-3453
WATER PUMP KIT
With Housing
Replaces: 5006511
For: E-Tec 40/50/60 HP All



18-3454
WATER PUMP KIT
With Housing
Replaces: 438592
For: 40, 50, 25 Jet, 30 Jet 1995-Up
Includes impeller **18-3104-1**



18-3325
WATER PUMP KIT
Replaces: 387326

— CONTAINS —

Part #	Desc.	O.E. #	Qty.
18-7134	O-Ring	339543	1
18-3108	Flywheel Key	308928	1
18-3337	Grommet	315837	1
18-3083	Impeller	377230	1
18-3343	Impeller Plate	320981	1
18-2705	Grommet	315748	1



18-3327
WATER PUMP KIT
With Housing
Replaces: 394711, 386697, 391698, 389112, 387610

— CONTAINS —

Part #	Desc.	O.E. #	Qty.
18-3050	Impeller	386084	1
18-3180	Housing	435390	1
18-3178	Wear Plate	318995	1
18-3179	Water Pump Cup	324097	1
18-3329	Grommet	302497	1
18-2392	Grommet	327035	1
18-2025	Oil Seal	318972	1
18-7116	O-Ring	303097	1
18-7139	O-Ring	319085	1
18-3326	Pin	300771	1
18-3369	Stainless Steel Bolt	319126	4



18-3376
WATER PUMP KIT
Without Housing
Replaces: 384956

— CONTAINS —

Part #	Desc.	O.E. #	Qty.
18-3083	Impeller	377230	1
18-3343	Impeller Plate	320981	1
18-3108	Flywheel Key	308928	1
18-3337	Grommet	315837	1
18-7134	O-Ring	339543	1
18-2705	Grommet	315748	1
18-3136	Screw (Long)	324430	2
18-3369	Stainless Steel Bolt	319126	2



18-3377
WATER PUMP KIT
Without Housing
Replaces: 382468

— CONTAINS —

Part #	Desc.	O.E. #	Qty.
18-3002	Impeller	375638	1
18-3103	Impeller Plate	303069	1
18-3329	Water Tube Grommet	302497	1
18-3326	Pin	300771	1

APPLICATION BEGINS ON PAGE 285

① Items ending in "D" are Display Packaged - Regular number is Non-Display



18-3378
WATER PUMP KIT

With Housing
Replaces: 391635, 439077

— CONTAINS —

Part #	Desc.	O.E. #	Qty.
18-3055	Impeller	389589	1
18-3343	Impeller Plate	320981	1
18-3336	Housing	384087	1
18-2709	Wear Plate Gasket	336530	1
18-3365	Stainless Steel Bolt	909533	2
18-3369	Stainless Steel Bolt	319126	2
18-2705	Seal	315748	1
18-3337	Water Tube Grommet	315837	1
18-7134	O-Ring	303059	1



18-3379
WATER PUMP KIT

Without Housing
Replaces: 390381

— CONTAINS —

Part #	Desc.	O.E. #	Qty.
18-3366	Impeller	390286	1
18-3352	Impeller Plate	325398	1
18-3354	Water Pump Gasket	325399	2
18-3332	Grommet	304056	1



18-3380
WATER PUMP KIT

Without Housing
Replaces: 390770

— CONTAINS —

Part #	Desc.	O.E. #	Qty.
18-3055	Impeller	389589	1
18-3343	Impeller Plate	320981	1
18-2709	Wear Plate Gasket	336530	1
18-3365	Stainless Steel Bolt	909533	2
18-3136	Stainless Steel Bolt	319126	2
18-2705	Seal	315748	1
18-3337	Water Tube Grommet	315837	1
18-7134	O-Ring	303059	1



18-3381
WATER PUMP KIT

Without Housing
Replaces: 393509

— CONTAINS —

Part #	Desc.	O.E. #	Qty.
18-3051	Impeller	395289	1
18-3359	Impeller Plate	328755	1
18-0124	Impeller Plate Gasket	325537	1
18-3358	Water Pump Cup	328751	1
18-2539	Rubber Seal	328753	1
18-3329	Grommet	302497	1
18-7100	O-Ring	301877	1
18-7105	O-Ring	311338	2
18-7146	O-Ring	554545	1
18-3133	Stainless Steel Bolt	331979	6



18-3382
WATER PUMP KIT

With Housing
Replaces: 393630

— CONTAINS —

Part #	Desc.	O.E. #	Qty.
18-3051	Impeller	395289	1
18-3359	Impeller Plate	328755	1
18-3367	Housing	393632	1
18-3358	Water Pump Cup	328751	1
18-0124	Impeller Plate Gasket	325537	1
18-3329	Grommet	302497	1
18-7100	O-Ring	301877	1
18-7105	O-Ring	311338	2
18-7146	O-Ring	554545	1
18-3133	Stainless Steel Bolt	331979	6



18-3383
WATER PUMP KIT

With Housing
Replaces: 395270

— CONTAINS —

Part #	Desc.	O.E. #	Qty.
18-3051	Impeller	395289	1
18-3363	Housing	330560	1
18-3358	Water Pump Cup	328751	1
18-3360	Impeller Housing Gasket	329390	1
18-3329	Grommet	302497	1
18-3133	Stainless Steel Bolt	331979	4



18-3384
WATER PUMP KIT
Without Housing
Replaces: 386124

— CONTAINS —

Part #	Desc.	O.E. #	Qty.
18-7158	O-Ring	310585	1
18-3108	Flywheel Key	308928	1
18-3043	Impeller	389642	1
18-3182	Impeller Plate	317841	1
18-2026	Oil Seal	321453	1
18-3135	Screw	306643	2
18-3136	Screw	323626	4
18-2389	Grommet	314832	2



18-3385
WATER PUMP KIT
Without Housing
Replaces: 396932

— CONTAINS —

Part #	Desc.	O.E. #	Qty.
18-3368	Impeller	396809	1
18-3343	Impeller Plate	320981	1
18-2705	Seal	315748	1
18-7481	Rubber Seal	324981	1
18-7134	O-Ring	303059	1
18-3337	Water Tube Grommet	315837	1
18-3365	Stainless Steel Bolt	909533	2
18-3369	Stainless Steel Bolt	319126	2



18-3387
WATER PUMP KIT
Without Housing
Replaces: 432956

— CONTAINS —

Part #	Desc.	O.E. #	Qty.
18-2703	Grommet	314008	1
18-3053-1	Impeller	396725	1
18-2705	Seal	315748	1
18-3133	SS Bolt	331979	4
18-7174	O-Ring	326649	1
18-7481	O-Ring	324981	1
18-2709	Wear Plate Gasket	336530	1
18-3126	Wear Plate	321940	1
18-3127	Impeller Plate	319275	1
18-3138	Impeller Key	334897	1
18-3299	Flywheel Key	331107	1
18-3153	Stainless Steel Bolt	908158	1



18-3388
WATER PUMP KIT
Without Housing
Replaces: 386533, 389143

— CONTAINS —

Part #	Desc.	O.E. #	Qty.
18-0969	Impeller Housing Gasket	319586	1
18-3108	Stainless Steel Key	323950	1
18-2703	Grommet	314008	1
18-3127	Impeller Plate	319275	1
18-2705	Seal	315748	1
18-3082	Impeller	382547	1
18-3153	Stainless Steel Bolt	334597	1
18-2709	Wear Plate Gasket	336530	1
18-3133	Stainless Steel Bolt	331979	4
18-3126	Wear Plate	321940	1



18-3389
WATER PUMP KIT
With Housing
Replaces: 436957, 0438591, 0432955

— CONTAINS —

Part #	Desc.	O.E. #	Qty.
18-7481	O-Ring	324981	1
18-2703	Grommet	314008	1
18-3053-1	Impeller	396725	1
18-3127	Impeller Plate	319275	1
18-2705	Seal	315748	1
18-3133	Stainless Steel Bolt	908158	1
18-3299	Flywheel Key	331107	1
18-7174	O-Ring	326649	1
18-2709	Wear Plate Gasket	336530	1
18-3129	Housing	435673	1
18-3138	Impeller Key	334897	1
18-3126	Wear Plate	321940	1



18-3390
WATER PUMP KIT
Without Housing
Replaces: 395060, 0435447, 0434421, 5001594

— CONTAINS —

Part #	Desc.	O.E. #	Qty.
18-3059	Impeller	397131, 435821	1
18-2557	Impeller Gasket	324701, 338484	1
18-3299	Impeller Key	331107	1
18-7158	O-Ring	310967, 310585	1
18-3135	Stainless Steel Screw	306643	2
18-2703	Grommet	314008	1
18-2704	Grommet	320943	1
18-2706	Grommet	321008	1
18-3136	Stainless Steel Bolt	323626	4
18-2769	Rubber Seal	332000	1
18-3133	Stainless Steel Bolt	331979	4
18-3346	Cup Plate Assy.	435027	1
18-3138	Impeller Key	334897	1



18-3391
WATER PUMP KIT
 With Housing
 Replaces: 395072

— CONTAINS —

Part #	Desc.	O.E. #	Qty.
18-3346	Cup & Plate Assy.	435027	1
18-2769	O-Ring	332000	1
18-2557	Impeller Plate Gasket	338484, 324701	1
18-2704	Grommet	320943	1
18-3136	Stainless Steel Bolt	323626	4
18-3299	Flywheel Key	331107	1
18-3153	Stainless Steel Bolt	908158	1



18-3392
WATER PUMP KIT
 With Housing
 Replaces: 434421, 5001594

— CONTAINS —

Part #	Desc.	O.E. #	Qty.
18-3059	Impeller	395864, 397131, 435821	1
18-3346	Cup & Plate Assy.	435027	1
18-3299	Impeller Key	331107	1
18-7158	O-Ring	310967, 310585	1
18-3135	Stainless Steel Screw	306643	2
18-2703	Grommet	314008	1
18-2704	Grommet	320943	1
18-2706	Grommet	321008	1
18-3136	Stainless Steel Bolt	323626	4
18-2769	Rubber Seal	332000	1
18-2557	Impeller Gasket	324701, 338484	1
18-3133	Stainless Steel Bolt	331979	4



18-3393
WATER PUMP KIT
 With Housing
 Replaces: 395073, 388644

— CONTAINS —

Part #	Desc.	O.E. #	Qty.
18-3043	Impeller	389642	1
18-2557	Impeller Gasket	324701, 338484	1
18-3346	Cup & Plate Assy.	435027	1
18-3108	Water Pump Key	323950	1
18-0110	Shift Housing Gasket	324670	1
18-7158	O-Ring	310967, 310585	1
18-3135	Stainless Steel Screw	306643	2
18-2703	Grommet	314008	1
18-2704	Grommet	320943	1
18-2706	Grommet	321008	1
18-3136	Stainless Steel Bolt	323626	4
18-2769	O-Ring	332000	1
18-7143	O-Ring	322501	1
18-3133	Stainless Steel Bolt	331979	4



18-3394
WATER PUMP KIT
 Without Housing
 Replaces: 433548, 0433549, 0438592

— CONTAINS —

Part #	Desc.	O.E. #	Qty.
18-7481	O-Ring	324981	1
18-2708	Grommet	333758	1
18-2709	Wear Plate Gasket	336530	1
18-3104-1	Impeller	432941	1
18-3138	Impeller Key	334897	1
18-2705	Seal	315748	1
18-3133	Stainless Steel Bolt	331979	4
18-3126	Wear Plate	321940	1



18-3399
WATER PUMP KIT
 With Housing
 Replaces: 396933, 0439077

— CONTAINS —

Part #	Desc.	O.E. #	Qty.
18-7134	O-Ring	303059	1
18-3337	Grommet	315837	1
18-3368	Impeller	396809	1
18-2709	Wear Plate Gasket	336530	1
18-3369	Screw (Short)	319126	2
18-2705	Seal	315748	1
18-3336	Housing	384087	1
18-3365	Screw (Long)	909533	2
18-3343	Wear Plate	320981	1



18-3400
WATER PUMP KIT
 Without Housing
 Replaces: 391698, 0394711

— CONTAINS —

Part #	Desc.	O.E. #	Qty.
18-3050	Impeller	386084	1
18-3178	Impeller Plate	318995	1
18-3179	Water Pump Cup	324097	1
18-3329	Grommet	302497	1
18-2392	Grommet	327035	1
18-2025	Oil Seal	318972	1
18-7116	O-Ring	303097	1
18-3369	Screw	319126	4
18-3326	Pin	300771	1
18-7139	O-Ring	319085	1



18-3401
WATER PUMP KIT

Without Housing

Replaces: 395271, 394394, 0395270

— CONTAINS —

Part #	Desc.	O.E. #	Qty.
18-3051	Impeller	395289	1
18-3360	Gasket	329398	1
18-3358	Cup	328773	1
18-7440-1	O-Ring	301967	2
18-2013	Oil Seal	321786	1
18-3329	Grommet	302497	1
18-0108	Gasket	324449	1
18-3133	Stainless Steel Bolt	331979	4



18-3402
WATER PUMP KIT

Without Housing

Replaces: 382296

— CONTAINS —

Part #	Desc.	O.E. #	Qty.
18-3003	Impeller	377178	1
18-3102	Impeller Plate	305303	1
18-2891	Gasket	303339	1
18-3326	Pin	300771	1
18-3329	Grommet	302497	1
18-2023	Oil Seal	313282	1



18-3403
WATER PUMP KIT

Without Housing

Replaces: 388644

— CONTAINS —

Part #	Desc.	O.E. #	Qty.
18-7158	O-Ring	310585	1
18-3108	Key	308928	1
18-2703	Grommet	314008	1
18-3135	Screw	306643	4
18-2026	Seal	321453	1
18-3136	Housing Screw	323626	1
18-3043	Impeller	389642	1
18-3346	Cup & Plate Assembly	435027	1
18-2536	Gasket	321120	1
18-2704	Grommet	320943	1



18-3315-2
WATER PUMP KIT

With Housing

Replaces: 435929, 5001595

For: 90/115SL (1995-UP), 120/125ESX (1993-94), 120/130/140/150/175/V-6/V-8(1993-UP)

— CONTAINS —

Part #	Desc.	O.E. #	Qty.
18-2557	Gasket	324701	1
18-3405	Housing, WP	435485	1



18-4537
WATER PUMP KIT

Without Housing

Replaces: 5008972

Fits: 15 (AA-AF), 25 (AA-AF), 30 (AA-AF)

— CONTAINS —

Part #	Desc.	O.E. #	Qty.
18-0124	Gasket	325537	1
18-3359	Plate	328755	1
18-2539	Seal	328753	1
18-3295	Key	344470	1
18-4539	Impeller	5008967	1
18-5701	Spring, Pressure Relief	355169	1
18-5703	Spring, Thermostat	355209	1
18-3358	Cup	328751	1
18-7146	O-Ring	554545	1
18-1595	Screw M6X25	353590	6
18-3367	Housing, Impeller	393632	1
18-2147	Bushing	328754	1
18-3329	Grommet	302497	1
18-7100	O-Ring	301877	1
18-1823	Seal and Pin Assembly	5007770	1



18-3472
WATER PUMP KIT

Without Housing

Replaces: 5007972

Fits: 200-300HP (2009 & Up)

— CONTAINS —

Part #	Desc.	O.E. #	Qty.
18-2557	Gasket, Water Pump	338484	1
18-4579	Plate, Outer Wear	338485	1
18-7963	Seal, Impeller Plate	331353	1
18-3059	Impeller	5001593	1
18-71336	O-Ring, Impeller to Plate	302035	1
18-3299	Key, Impeller	331107	1
18-4549	Cup, Insert	338486	1
18-7143	O-Ring, Cup to Housing	331188	1
18-4571	Housing, Impeller	360347	1
18-71338	O-Ring, Water Tube	346865	4
18-9084	Cover, Impeller Housing	354578	1
18-1597	Screw, Housing	302325	4
18-3135	Screw, Cover to Housing	306643	2
18-2704	Grommet, Pump to Exhaust Housing	320943	1
18-1824	Grommet, Sleeve, 20" Models	349354	1
18-1826	Grommet, Sleeve, 25" and 30"	338601	1
18-1822	Sleeve, Extension 25" Models	354580	1

APPLICATION BEGINS ON NEXT PAGE

© This product is priced per piece. To order priced per package, please add -9 to the part number.

New



**18-3476
WATER PUMP KIT**

Without Housing
Replaces: 5007556
Fits: 90 (2013 & Up), 115/130 (2009 & Up)

— CONTAINS —

Part #	Desc.	O.E. #	Qty.
18-2557	Gasket, Plate	338484	1
18-4579	Plate, Outer Wear	338485	1
18-7963	Seal, Housing Plate	331353	1
18-3059	Impeller	5001593	1
18-71336	O-ring, Impeller to Plate	302035	1
18-3299	Key, Impeller	331107	1
18-4549	Cup, Insert	338486	1
18-7143	O-Ring, Cup to Housing	331188	1
18-4568	Housing, Impeller	5007554	1
18-1597	Screw, Housing	302325	4
18-1821	Grommet, Pump to Exhaust Housing	353690	1

New



**18-3491
WATER PUMP KIT**

Without Housing
Replaces: 437907
Fits: 25/35 (1996-01)

— CONTAINS —

Part #	Desc.	O.E. #	Qty.
18-7100	O-Ring	301877	1
18-0124	Gasket	325537	1
18-1596	Screw	328725	6
18-3358	Cup, Impeller	328751	1
18-2539	Seal	328753	1
18-2147	Bushing, Shift Rod	328754	1
18-3359	Plate, Impeller	328755	1
18-4569	Housing, Impeller	339720	1
18-1825	Grommet	340811	1
18-71340	Seal	342370	1
18-3051	Impeller w/ Key	395289	1
18-7146	O-Ring	554545	1

New



**18-4529
WATER PUMP KIT**

Without Housing
Replaces: 396644
Fits: 4HP (1986-92), 5HP (1980-83, 1996-01), 6HP (1984-01, 2003-05), 8HP (1980-01, 2003-05)

— CONTAINS —

Part #	Desc.	O.E. #	Qty.
18-3026	Drive Key	331130	1
18-1827	Grommet	321129	1
18-3329	Grommet	302497	1
18-4277	Screws	324430	4
18-4578	Impeller Hsg Plate	324640	1
18-4551	Impeller Hsg Cup	324641	1
18-99156	Impeller Hsg Gasket	325040	2
18-3091	Impeller Assembly	389576	1
18-7413	O-Ring	303191	1



STAINLESS STEEL BOLTS

Part No.	O.E. #	Size
18-3133	330619, 344470	1/4 x 20 x 11/16"
18-3135 ①③	306643	1/8 x 20 x 1/2"
18-3136 ①③	323626	1/4 x 20 x 13/4"
18-3153	908158	1/4 x 20 x 1/2"
18-3365	909533	1/4 x 20 x 1"
18-3369	319126	1/4 x 20 x 1"
18-4276 ②③	324334	1/4 x 20 x 1 1/32"
18-4277 ②③	324430	1/4 x 20 x 2"

① Std. Pkg of 2 ② Std. Pkg of 5

JOHNSON/EVINRUDE WATER PUMP KIT APPLICATION

HP	Year	Impeller	Impeller Plate	Plate & Cup	Cup	Repair Kit	Pump Kit w/o Hsg.	Pump Kit w/Hsg.	Housing Kit
2 Jr, Colt	1985-90	18-3090	—	—	—	—	—	—	—
2.5	1987-06	18-3015	—	—	—	—	—	—	—
3	1952-78	18-3001	—	—	—	18-3201	—	—	—
3.5	1987-06	18-3015	—	—	—	—	—	—	—
4	1969-72	18-3001	—	—	—	18-3201	—	—	—
4 ⑦	1973-83	18-3001	—	—	—	18-3201	—	—	—
4 ⑧	1976-80	18-3090	—	—	—	—	—	—	—
4	1986-92	18-3091	18-4578	—	18-4551	—	18-4529	—	—
4 Deluxe	1980-97	18-3091	—	—	—	—	—	—	—
4 Ultra Excel	1987-06	18-3015	—	—	—	—	—	—	—
4.5	1980-97	18-3091	—	—	—	—	—	—	—
5	1965-68	18-3001	—	—	—	—	—	—	—
5	1980-01	18-3091	18-4578	—	18-4551	—	18-4529	—	—
5 (4-Stroke)	1998-Up	18-3091	—	—	—	—	—	—	—
5.5	1954-64	18-3001	18-3102	—	—	18-3202	—	—	—
6	1952-78	18-3001	18-3102	—	—	18-3202	—	—	—

① Except chrome pumps

② Except SL models 1995 & Up/FFI models

③ "S" Suffix

④ "F" Suffix

⑤ Except 1993-94 25" & 30" V6 & V8

⑦ For water pumps using 1 water tube

⑧ 90 degree gearcase

JOHNSON/EVINRUDE WATER PUMP KIT APPLICATION (CONT.)

HP	Year	Impeller	Impeller Plate	Plate & Cup	Cup	Repair Kit	Pump Kit w/o Hsg.	Pump Kit w/Hsg.	Housing Kit
6	1979	18-3090	—	—	—	—	—	—	—
6	1984-05	18-3091	18-4578	—	18-4551	—	18-4529	—	—
6 (4-Stroke)	1998-Up	18-3091	—	—	—	—	—	—	—
7.5	1954-58	18-3001	18-3102	—	—	18-3202	—	—	—
8	1980-05	18-3091	18-4578	—	18-4551	—	18-4529	—	—
8 (2-Stroke)	1986-97	18-3091	—	—	—	—	—	—	—
9.5	1964-73	18-3003	18-3102	—	—	—	18-3402	—	—
10	1958-63	18-3003	18-3102	—	—	—	18-3402	—	—
10	1949-57	18-3002	18-3103	—	—	18-3203	18-3377	—	—
9.9/15	1974-Up	18-3050	18-3178	—	18-3179	—	18-3400	18-3327	18-3180
9.9/15 (4-Stroke)	1995-Up	18-3050	18-3178	—	18-3179	—	18-3400	18-3327	18-3180
15,18	1953-65	18-3002	—	—	—	18-3203	18-3377	—	—
15	2011 & Up	18-4539	18-3359	—	18-3358	—	—	18-4537	—
15	AA-AF	18-4539	18-3359	—	18-3358	—	—	18-4537	—
20	1966-73	18-3002	—	—	—	18-3203	18-3377	—	—
20	1982-84	18-3051	—	—	18-3358	—	18-3401	18-3383	18-3363
20	1985-Up	18-3051	18-3359	—	18-3358	—	18-3381	18-3382	18-3367
25	1951-55	18-3006	—	—	—	—	—	—	—
25	1969-78	18-3002	18-3103	—	—	18-3203	18-3377	—	—
25	1979-84	18-3051	—	—	18-3358	—	18-3401	18-3383	18-3363
25	1985-Up	18-3051	18-3359	—	18-3358	—	18-3381	18-3382	18-3367
25	1996-01	18-3051	18-3359	—	18-3358	—	18-3491	—	18-4569
25	2011 & Up	18-4539	18-3359	—	18-3358	—	—	18-4537	—
25	AA-AF	18-4539	18-3359	—	18-3358	—	—	18-4537	—
28	1962-64	18-3006	—	—	—	—	—	—	—
28	1978-Up	18-3051	—	—	18-3358	—	18-3401	18-3383	18-3363
30	1951-57	18-3006	—	—	—	—	—	—	—
30	1984-Up	18-3051	18-3359	—	18-3358	—	18-3381	18-3382	18-3367
30	2011 & Up	18-4539	18-3359	—	18-3358	—	—	18-4537	—
30	AA-AF	18-4539	18-3359	—	18-3358	—	—	18-4537	—
33	1962-71	18-3006	—	—	—	—	—	—	—
35	1951-57	18-3006	—	—	—	—	—	—	—
35	1958-59	18-3083	—	—	—	—	—	—	—
35	1976-77	18-3006	—	—	—	—	—	—	—
35	1978-79	18-3051	—	—	—	—	18-3238	—	—
35	1980-82	18-3051	N/A	—	18-3358	—	—	18-3382	18-3367
35	1983-Up	18-3051	18-3359	—	18-3358	—	—	—	—
35	1996-01	18-3051	18-3359	—	18-3358	—	18-3491	—	18-4569
35 Jet	1992-93	18-3104-1	—	—	—	—	18-3394	—	—
40	1960-70	18-3083	—	—	—	—	—	—	—
40	1971-73	18-3006	—	—	—	—	—	—	—
40 Comm.	1981-90	18-3366	18-3352	—	—	—	18-3379	—	—
40	1984-85	18-3055	18-3343	—	—	—	18-3385	18-3399	18-3336
40	1986-88	18-3368	18-3343	—	—	—	18-3385	18-3399	18-3336
40	1989-98	18-3104-1	—	—	—	—	18-3394	—	—
40	1999-Up	18-3053-1	—	—	—	—	18-3394	—	—
45/55 Comm.	1985	18-3055	—	—	—	—	18-3380	—	18-3336
45/55	1989	18-3368	18-3343	—	—	—	18-3385	18-3399	18-3336
45/55 Comm.	1986-88,	18-3368	—	—	—	—	18-3385	18-3399	18-3336
48	1987-88	18-3368	18-3343	—	—	—	18-3385	18-3399	18-3336
48	1989-96	18-3104-1	18-3127	—	—	—	18-3394	—	—
50	1971-78	18-3083	18-3343	—	—	—	18-3376	—	—

① Except chrome pumps

③ "S" Suffix

⑤ Except 1993-94 25" & 30" V6 & V8

② Except SL models 1995 & Up/FFI models

④ "F" Suffix

⑦ For water pumps using 1 water tube

⑧ 90 degree gearcase

JOHNSON/EVINRUDE WATER PUMP KIT APPLICATION

HP	Year	Impeller	Impeller Plate	Plate & Cup	Cup	Repair Kit	Pump Kit w/o Hsg.	Pump Kit w/Hsg.	Housing Kit
50	1979-85	18-3055	18-3343	—	—	—	18-3380	18-3378	18-3336
50	1986-88	18-3368	18-3343	—	—	—	18-3385	18-3399	18-3336
50	1989-98	18-3104-1	—	—	—	—	18-3394	—	—
55	1968-69	18-3082	—	—	—	—	—	—	—
55	1976-78	18-3083	—	—	—	—	—	—	18-3336
55	1979-85	18-3055	18-3343	—	—	—	18-3380	18-3378	18-3336
60	1964-67	—	—	—	—	—	—	—	—
60	1970-71	18-3082	—	—	—	—	—	—	—
60	1980-85	18-3055	—	—	—	—	18-3380	18-3378	18-3336
60	1986-94	18-3053-1	18-3127	—	—	—	18-3387	18-3389	—
60	1995-Up	18-3053-1	18-3127	—	—	—	18-3387	—	—
65	1968	—	—	—	—	—	—	—	—
65	1972-73	18-3082	—	—	—	—	—	—	—
65 Comm.	1984-94	18-3053-1	18-3127	—	—	—	18-3387	18-3389	—
65 Comm.	1995-Up	18-3053-1	18-3127	—	—	—	18-3387	—	—
70	1974-78	18-3082	18-3127	—	—	—	18-3388	—	—
70	1979-94	18-3053-1	18-3127	—	—	—	18-3387	18-3389	—
70	1995-Up	18-3053-1	18-3127	—	—	—	18-3387	—	—
75	1960-65	—	—	—	—	—	—	—	—
75	1974-78	18-3082	18-3127	—	—	—	18-3388	—	—
75	1979-88	18-3053-1	18-3127	—	—	—	18-3387	18-3389	18-3129
80	1966-67	—	—	—	—	—	—	—	—
85	1968	—	—	—	—	—	—	—	—
85	1969-72	18-3044	18-3182	—	—	—	—	—	—
85	1973-77	18-3043	18-3182	—	—	—	18-3384	—	—
85	1978	18-3043	—	18-3346	—	—	—	18-3393⑦	18-3391
85	1979-95	18-3059	—	18-3346	—	18-3211	18-3390	18-3392	18-3391
90	1964-68	—	—	—	—	—	—	—	—
90	1979-Up	18-3059	—	18-3346	—	18-3211	18-3390	18-3392②	18-3391
90	2013 & Up	18-3059	18-4579	—	18-4549	—	18-3476	—	18-4568
90 SL,DI	1995 & UP	18-3059	—	18-3346	—	18-3211	18-3390	18-3315-2	18-3405
100	1969-72	18-3044	—	—	—	—	—	—	—
100	1979-Up	18-3059	—	18-3346	—	18-3211	18-3390	18-3392	18-3391
100 Comm. ①	1984-Up	18-3059	—	18-3346	—	18-3211	18-3390	18-3392	18-3391
105 Comm.	1998-2001	18-3059	—	18-3346	—	18-3211	18-3390	18-3315-2	18-3405
115	1969-70	18-3044	—	—	—	—	—	—	—
115	1973-76	18-3043	—	—	—	—	18-3384	—	—
115	1977-78	18-3043	—	18-3346	—	—	—	18-3393⑦	18-3391
115	1979-Up	18-3059	—	18-3346	—	18-3211	18-3390	18-3392②	18-3391
115	2013 & Up	18-3059	18-4579	—	18-4549	—	18-3476	—	18-4568
115 SL,DL	1995 & UP	18-3059	—	18-3346	—	18-3211	18-3390	18-3315-2	18-3405
120 25" ④	1993-2000	18-3059	—	18-3346	—	18-3211	18-3390	18-3315-2	18-3405
125	1971-72	18-3044	—	—	—	—	—	—	—
125 ESX 25" ③	1993-94	18-3059	—	18-3346	—	18-3211	18-3390	18-3392	18-3391
125 ESX 25"	1994-95	18-3059	—	18-3346	—	18-3211	18-3390	18-3392	18-3391
125 ESX 25" ④	1993-94	18-3059	—	18-3346	—	18-3211	18-3390	—	—
130	1997 & UP	18-3059	—	18-3346	—	18-3211	18-3390	18-3315-2	18-3405
130	2013 & Up	18-3059	18-4579	—	18-4549	—	18-3476	—	18-4568
130 25"	1994-2000	18-3059	—	18-3346	—	18-3211	18-3390	18-3315-1	18-3405
135	1973-75	18-3043	18-3182	—	—	18-3210	18-3384	—	—
135	1976	18-3043	18-3182	—	—	—	—	—	—
135 25"	2001	18-3059	—	18-3346	—	18-3211	18-3390	18-3315-2	18-3405

① Except chrome pumps

③ "S" Suffix

⑤ Except 1993-94 25" & 30" V6 & V8

② Except SL models 1995 & Up/FFI models

④ "F" Suffix

⑦ For water pumps using 1 water tube

⑧ 90 degree gearcase

JOHNSON/EVINRUDE WATER PUMP KIT APPLICATION (CONT.)

HP	Year	Impeller	Impeller Plate	Plate & Cup	Cup	Repair Kit	Pump Kit w/o Hsg.	Pump Kit w/Hsg.	Housing Kit
140	1977-78	18-3043	—	18-3346	—	—	—	18-3393⑦	18-3391
140	1979-Up	18-3059	—	18-3346	—	18-3211	18-3390	18-3392	18-3391
140 25" ④	1993	18-3059	—	18-3346	—	18-3211	18-3390	18-3315-2	18-3405
140 25"	1994-2000	18-3059	—	18-3346	—	18-3211	18-3390	18-3315-2	18-3405
150	1976-78	18-3043	—	18-3346	—	18-3210	—	18-3393⑦	18-3391
150	1979-Up	18-3059	—	18-3346	—	18-3211	18-3390	18-3392	18-3391
150 20"	1993 & UP	18-3059	—	18-3346	—	18-3211	18-3390	18-3392	18-3391
150 SL 20"	1994-98	18-3059	—	18-3346	—	18-3211	18-3390	18-3315-2	18-3405
150 EL 20"	1996-98	18-3059	—	18-3346	—	18-3211	18-3390	18-3315-2	18-3405
150 25"	1993 & UP	18-3059	—	18-3346	—	18-3211	18-3390	18-3315-2	18-3405
150 DI	1997 & UP	18-3059	—	18-3346	—	18-3211	18-3390	18-3315-2	18-3405
150	2000 & UP	18-3059	—	18-3346	—	18-3211	18-3390	18-3315-2	18-3405
175	1976-78	18-3043	—	18-3346	—	18-3210	—	18-3393⑦	18-3391
175 SL 20"	1994-98	18-3059	—	18-3346	—	18-3211	18-3390	18-3315-2	18-3405
175 EL 20"	1996-98	18-3059	—	18-3346	—	18-3211	18-3390	18-3315-2	18-3405
175 25"	1993 & UP	18-3059	—	18-3346	—	18-3211	18-3390	18-3315-2	18-3405
175 DI	1997 & UP	18-3059	—	18-3346	—	18-3211	18-3390	18-3315-2	18-3405
175	2000 & UP	18-3059	—	18-3346	—	18-3211	18-3390	18-3315-2	18-3405
200	1976-78	18-3043	—	18-3346	—	—	—	18-3393⑦	18-3391
200	2009 & Up	18-3059	18-4579	—	18-4549	—	18-3472	—	18-4571
200 Comm.	1990	18-3059	—	18-3346	—	18-3211	18-3390	18-3392	18-3391
200 25" & 30"	1993-97	18-3059	—	18-3346	—	18-3211	18-3390	18-3315-2	18-3405
225	2009 & Up	18-3059	18-4579	—	18-4549	—	18-3472	—	18-4571
225 20"	1993 & UP	18-3059	—	18-3346	—	18-3211	18-3390	18-3392	18-3391
225 25" & 30"	1993-97	18-3059	—	18-3346	—	18-3211	18-3390	18-3315-2	18-3405
235	1978	18-3043	—	18-3346	—	—	—	18-3393⑦	18-3391
235	1979-Up	18-3059	—	18-3346	—	18-3211	18-3390	18-3392	18-3391
250	2009 & Up	18-3059	18-4579	—	18-4549	—	18-3472	—	18-4571
275	2009 & Up	18-3059	18-4579	—	18-4549	—	18-3472	—	18-4571
300	2009 & Up	18-3059	18-4579	—	18-4549	—	18-3472	—	18-4571
V4 Cross 20" & 25"	1993 & UP	18-3059	—	18-3346	—	18-3211	18-3390	18-3392	18-3391
V4 Loop 20"	1993 & UP	18-3059	—	18-3346	—	18-3211	18-3390	18-3392	18-3391
V4,V6,V8 ⑤	1982-94	18-3059	—	18-3346	—	18-3211	18-3390	18-3392	18-3391
V6,V8 20"	1993 & UP	18-3059	—	18-3346	—	18-3211	18-3390	18-3392	18-3391
V6 & V8 25" & 30"	1993 & UP	18-3059	—	18-3346	—	18-3211	18-3390	18-3315-2	18-3405
Sea Drives	1979-Up	18-3059	—	18-3346	—	18-3211	18-3390	18-3392⑥	18-3391

① Except chrome pumps

② Except SL models 1995 & Up/FFI models

③ "S" Suffix

④ "F" Suffix

⑤ Except 1993-94 25" & 30" V6 & V8

⑦ For water pumps using 1 water tube

⑥ 90 degree gearcase

18-3563
POPPET
RELIEF VALVE
V-6 Crossflow
Replaces: 321027



18-3564
POPPET
RELIEF VALVE
V-4 Crossflow
Replaces: 318395



18-1219
GROMMET
V-6 Crossflow
Replaces: 320880



PKG. OF 2

18-1221
18-1221-9①
RETAINER GASKET
V-4 / V-6 Loop Charge
Replaces: 330273



18-3562
VALVE CUP
V-6 Crossflow
Replaces: 321222



18-1243
VALVE SPRING
V-4 / V-6 Crossflow
Replaces: 317245



① Priced per Package



18-1222
THERMOSTAT GASKET
V-4 / V-6 Loop Charge
Replaces: 394408



18-3567
RUBBER VALVE
V-6 Crossflow
Replaces: 321221



18-3565
RETAINER
V-6 Crossflow
Replaces: 321220



18-2391
GROMMET
V-4 Crossflow
Replaces: 321692



18-3500
THERMOSTAT
Replaces: 394409, 434137
For: 3 cyl. (1992 & UP),
90° Looper (1990-1992)
140°



18-3544
THERMOSTAT
Replaces: 435491
Fits: E100 (2004-06), E110 (04-06), E115 (2002-06), E75 (2002-03), E90 (2002-03), E150 (1991-94), E175 (1991-94), J105 (2003), J115 (2002-06), J150 (1991-92, 1993-94, 2002-06), J175 (1991-92, 1994, 2002-06), J90 (2004-06)



18-3545
THERMOSTAT 130°
Replace: 437090
Fits: E115 (1997),
E135, E150, E175 (2000-06)



18-3546
THERMOSTAT 130°
Replaces: 5001036
Fits: E200, E225, E250 (2000-05),
J200, J225, J250 (2000-01)



18-3543
THERMOSTAT 143°
Replaces: 393659, 434841,
378065, 508626, 5005440
Fits: 40-250hp E-tech, 6-55hp, Cross V4
& V6, 9.9 4-Stroke (1994-01), 15 4-Stroke
(1994-01)



18-3643
THERMOSTAT
Replaces: 433379
Fits: 6-8HP (1990), 9.9/15HP (1990-92),
40/48/50HP (1990-94), 45/55 (1992-94)



18-3557
THERMOSTAT 143°
Replaces: 396987, 382385



18-3561
THERMOSTAT
Replaces: 436195
143°



18-1506
VERNATHERM 143°
Replaces: 394411
For: 10/15 (1993-95), 60/125/185 (1989-90),
65 (1987-89), 70/200/225 (1986-90),
120/140/300 (1985-90), 275 (1985-88)



18-3560
VERNATHERM
Replaces: 384719
105°
Fits most 3 & 4 cyl., 1985-90



18-3669D Display Package
THERMOSTAT KIT
— CONTENTS —

Part #	Description	O.E. #
18-3557	Thermostat	396987
18-2548	Thermostat Cover Gasket	332108
18-0929	Thermostat Gasket	313416



18-3673D Display Package
THERMOSTAT KIT
V-4 Crossflow
Uses thermostat **18-3543**



18-3674D Display Package
THERMOSTAT KIT
V-6 Crossflow
Uses thermostat **18-3543**



18-3566
TELL TALE HOSE ELBOW
Replaces: 331894



18-1507
THERMOSTAT SEAL
Replaces: 335981
For: 60° V-4 & V-6



18-1734
THERMOSTAT SEAL
Replaces: 334742
For: OMC thermostat application 6, 8, 10,
15, 40, 48, 50 HP (1989-94)

APPLICATION ON PAGE 290

① Items ending in "D" are Display Packaged - Regular number is Non-Display

Crossflow V-4 Engine

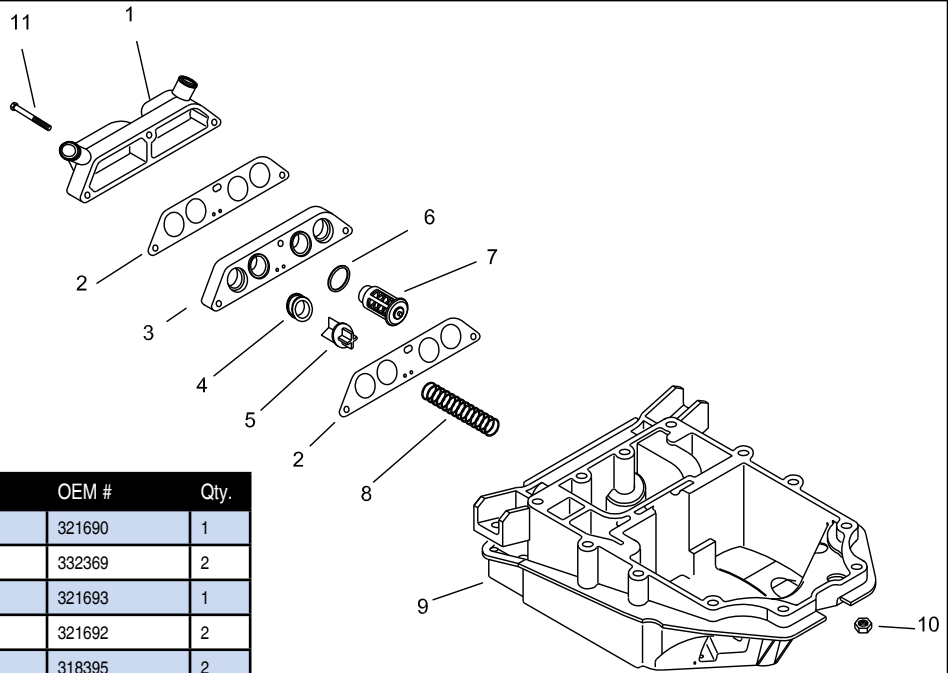

Fig. #	Description	Part #	OEM #	Qty.
1	Cover	~	321690	1
2	Gasket	18-0977	332369	2
3	Valve Body	~	321693	1
4	Grommet	18-2391	321692	2
5	Valve	18-3564	318395	2
6	Thermostat Gasket	18-0675	321932	2
7	Thermostat	18-3543	434841, 393659	2
8	Spring	18-1243	317245	2
9	Adapter	~	331039	1
10	Nut	~	306422	4
11	Screw Cover	~	305652	3

Crossflow V-6 Engine

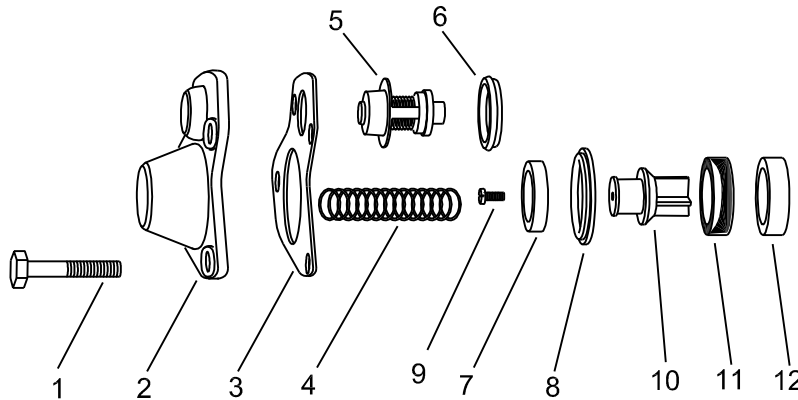

Fig. #	Description	Part #	OEM #	Qty.
1	Screw	—	306778	4
2	Cover	—	321013	1
3	Gasket	18-2546	321184	1
4	Spring	18-1243	317245	1
5	Thermostat	18-3543	393659	1
6	Thermostat Gasket	18-0182	310058	1

Fig. #	Description	Part #	OEM #	Qty.
7	Retainer	18-3565	321220	1
8	Seal	18-3567	321221	1
9	Stainless Steel Bolt	18-3135	306643	1
10	Valve	18-3563	321027	1
11	Grommet	18-1219	320880	1
12	Valve Cap	18-3562	321222	1

JOHNSON/EVINRUDE THERMOSTAT APPLICATION

HP	Years	Thermostat Kit	Thermostat	Valve	Valve Seat	Valve Diaphragm	Valve Retainer	Valve Cup	Valve Spring	Grommet
5	1965-68, 1986	18-3672 ⑤	18-3543	—	—	—	—	—	—	—
5.5	1959-64	18-3672 ⑤	18-3543	—	—	—	—	—	—	—
6	1965-79, 1986	18-3672 ⑤	18-3543	—	—	—	—	—	—	—
6	1990	18-3643	—	—	—	—	—	—	—	—
7.5	1980-86	18-3672 ⑤	18-3543	—	—	—	—	—	—	—
8	1986	18-3672 ⑤	18-3543	—	—	—	—	—	—	—
8	1990	18-3643	—	—	—	—	—	—	—	—
9.5	1964-73	18-3672 ⑤	18-3543	—	—	—	—	—	—	—

① All 1989-91 models except DR & DT
 ② Commercial

③ Commercial also
 ④ Except 60 degree models

⑤ For complete Thermostat Kit including gaskets & spring use 18-3674

APPLICATION CONTINUED ON NEXT PAGE

JOHNSON/EVINRUDE THERMOSTAT APPLICATION

HP	Years	Thermostat Kit	Thermostat	Valve	Valve Seat	Valve Diaphragm	Valve Retainer	Valve Cup	Valve Spring	Grommet
9.9	1974-86	18-3672 ⑤	18-3543	—	—	—	—	—	—	—
9.9	1990-92	18-3643	—	—	—	—	—	—	—	—
10	1959-63	18-3672 ⑤	18-3543	—	—	—	—	—	—	—
15	1974-86	18-3672 ⑤	18-3543	—	—	—	—	—	—	—
15	1990-92	18-3643	—	—	—	—	—	—	—	—
18	1959-73	18-3672 ⑤	18-3543	—	—	—	—	—	—	—
20	1981-94	18-3672 ⑤	18-3543	—	—	—	—	—	—	—
25 ①	1969-94	18-3672 ⑤	18-3543	—	—	—	—	—	—	—
28	1989-94	18-3672 ⑤	18-3543	—	—	—	—	—	—	—
30	1986-94	18-3672 ⑤	18-3543	—	—	—	—	—	—	—
35	1959, 1976-94	18-3672 ⑤	18-3543	—	—	—	—	—	—	—
40	1960-69	18-3672 ⑤	18-3543	—	—	—	—	—	—	—
40	1990-94	18-3643	—	—	—	—	—	—	—	—
45	1989-92 ②	18-3672 ⑤	18-3543	—	—	—	—	—	—	—
45	1992-94	18-3643	—	—	—	—	—	—	—	—
48	1990-94	18-3643	—	—	—	—	—	—	—	—
50	1971-75, 1979, 1981-86	18-3672 ⑤	18-3543	—	—	—	—	—	—	—
50	1990-94	18-3643	—	—	—	—	—	—	—	—
55	1976-92 ③	18-3672 ⑤	18-3543	—	—	—	—	—	—	—
55	1992-94	18-3643	—	—	—	—	—	—	—	—
60	1969-70	18-3669 ⑤	18-3557	—	—	—	—	—	—	—
60	1980-86	18-3672 ⑤	18-3543	—	—	—	—	—	—	—
60, 60TTL	1993	—	18-3561	—	—	—	—	—	—	—
65	1971-73	18-3669	18-3557	—	—	—	—	—	—	—
65	1993	—	18-3561	—	—	—	—	—	—	—
65C	1984-86	18-3669	18-3557	—	—	—	—	—	—	—
65 Jet	1994-95	18-3673	18-3543	18-3564	—	—	—	—	18-1243	18-2391
70	1974-86	18-3669	18-3557	—	—	—	—	—	—	—
70,70TTL	1993	—	18-3561	—	—	—	—	—	—	—
75	1978-88	18-3669	18-3557	—	—	—	—	—	—	—
80 Jet	1994-95	18-3673	18-3543	18-3564	—	—	—	—	18-1243	18-2391
85	1978-80	18-3673	18-3543	18-3564	—	—	—	—	18-1243	18-2391
85	1993-95	18-3673	18-3543	18-3564	—	—	—	—	18-1243	18-2391
88	1987-95	18-3673	18-3543	18-3564	—	—	—	—	18-1243	18-2391
90 ④	1983-95	18-3673	18-3543	18-3564	—	—	—	—	18-1243	18-2391
90 Jet	1994	18-3673	18-3543	18-3564	—	—	—	—	18-1243	18-2391
100	1979-80	18-3673	18-3543	18-3564	—	—	—	—	18-1243	18-2391
100	1990-95	18-3673	18-3543	18-3564	—	—	—	—	18-1243	18-2391
100 Comm	1984-95	18-3673	18-3543	18-3564	—	—	—	—	—	—
110	1985-89	18-3673	18-3543	18-3564	—	—	—	—	18-1243	18-2391
112	1994-95	18-3673	18-3543	18-3564	—	—	—	—	18-1243	18-2391
115 ④	1978-95	18-3673	18-3543	18-3564	—	—	—	—	18-1243	18-2391
120	1988-91	—	—	—	—	18-1222	—	18-1221	—	—
140	1978-85	18-3673	18-3543	18-3564	—	—	—	—	18-1243	18-2391
140	1988-91	—	—	—	—	18-1222	—	18-1221	—	—
150	1978-91	18-3672 ⑤	18-3543	18-3563	18-1219	18-3567	18-3565	18-3562	18-1243	18-0182
155	1984-91	18-3672 ⑤	18-3543	18-3563	18-1219	18-3567	18-3565	18-3562	18-1243	18-0182
175	1977-91	18-3672 ⑤	18-3543	18-3563	18-1219	18-3567	18-3565	18-3562	18-1243	18-0182
185	1984-85	18-3672 ⑤	18-3543	18-3563	18-1219	18-3567	18-3565	18-3562	18-1243	18-0182
200	1977-83	18-3672 ⑤	18-3543	18-3563	18-1219	18-3567	18-3565	18-3562	18-1243	18-0182
200	1988-93	—	—	—	—	18-1222	18-3565	18-1221	—	—
225	1988-93	—	—	—	—	18-1222	18-3565	18-1221	—	—
235	1978-85	18-3672 ⑤	18-3543	18-3563	18-1219	18-3567	18-3565	18-3562	18-1243	18-0182

① All 1989-91 models except DR & DT
 ② Commercial

③ Commercial also
 ④ Except 60 degree models

⑤ For complete Thermostat Kit including gaskets & spring use 18-3674



Piston Rings are available individually

SIERRA PISTON KIT CONTENTS
(SEE APPLICATION CHARTS FOR SPECIFIC APPLICATIONS)

HP	Cyl.	Bore Size	Piston	OEM Part No.	Piston Ring	OEM Part No.	OEM Part No.	Circlips	OEM Part No.
9.9/15	2	2.188 / std.	—	397487	—	386279	N/A	—	325262
9.9/15	2	2.218 / .030	—	396574	18-3933	386280	N/A	—	325262
9.9/15	2	2.188 / std.	—	387660	—	386279	N/A	—	325262
9.9/15	2	2.218 / .030	18-4062	387661	18-3933	386280	N/A	—	325262
25-35	2	3.000 / std.	18-4107	392621	18-3910	396377	320954	18-4290 ①	317831
25-35	2	3.020 / .020	—	N/A	18-3911	396378	320954	18-4290 ①	317831
25-35	2	3.030 / .030	—	396576	18-3912	396379	320954	18-4290 ①	317831
35-60	2 & 3	3.187 / std.	—	391798	18-3913	391170, 434107	322188	18-4290 ①	317831
35-60	2 & 3	3.207 / .020	—	N/A	18-3914	N/A	322188	18-4290 ①	317831
35-60	2 & 3	3.217 / .030	—	396581	18-3915	391416, 434109	322188	18-4290 ①	317831
60-75	3	3.000 / std.	18-4124	387284	18-3910	396377	320954	18-4290 ①	317831
60-75	3	3.020 / .020	18-4114	387285	18-3911	396378	320954	18-4290 ①	317831
60-75	3	3.030 / .030	18-4104	396583	18-3912	396379	320954	18-4290 ①	317831
50-70	3	3.187 / std.	18-4063	394461	18-3913	391170, 434107	322188	18-4290 ①	317831
50-70	3	3.217 / .030	18-4064	398483	18-3915	391416, 434109	322188	18-4290 ①	317831

SIERRA V-4/V-6 PISTON KIT CONTENTS
(SEE APPLICATION CHARTS FOR SPECIFIC APPLICATIONS)

Model/HP	Cyl.	Bore Size	Piston	OEM Part #	Piston Ring	OEM Part #	Wrist Pin	OEM Part #	Circlips	OEM Part #
85-300	4 & 6	3.5	18-4120	393271, 393924	18-3904	394930	18-4280	327861	18-4290 ①	317831
85-300	4 & 6	3.52	18-4110	—	18-3906	396503, 385662	18-4280	327861	18-4290 ①	317831
85-300	4 & 6	3.53	18-4100	396585, 396588	18-3905	396504	18-4280	327861	18-4290 ①	317831
150-235	4 & 6	3.625	18-4123	392455	18-3907	390509	18-4280	327861	18-4290 ①	317831
150-235	4 & 6	3.645	18-4113	N/A	—	N/A	18-4280	327861	18-4290 ①	317831
150-235	4 & 6	3.655	18-4103	396587	18-3908	390510	18-4280	327861	18-4290 ①	317831
Loopers										
120-300	4 & 6	3.685 (port)	18-4065	432072, 432969	18-3975	431870	N.S.S.	—	18-4292	326765
120-300	4 & 6	3.685 (starboard)	18-4066	432073, 432970	18-3975	431870	N.S.S.	—	18-4292	326765
120-300	4 & 6	3.715 (port)	18-4067	432077, 433003	18-3974	431844	N.S.S.	—	18-4292	326765
120-300	4 & 6	3.715 (starboard)	18-4068	432078, 433004	18-3974	431844	N.S.S.	—	18-4292	326765
120-300	4 & 6	3.500 (port)	18-4122	393566	18-3904	394930	18-4280	327861	18-4290 ①	317831
120-300	4 & 6	3.500 (starboard)	—	391481	18-3904	394930	18-4280	327861	18-4290 ①	317831
120-300	4 & 6	3.520 (port)	—	N/A	18-3906	396503, 385662	18-4280	327861	18-4290 ①	317831
120-300	4 & 6	3.520 (starboard)	18-4111	N/A	18-3906	396503, 385662	18-4280	327861	18-4290 ①	317831
120-300	4 & 6	3.530 (port)	18-4102	393612	18-3905	396504	18-4280	327861	18-4290 ①	317831
120-300	4 & 6	3.530 (starboard)	18-4101	391653	18-3905	396504	18-4280	327861	18-4290 ①	317831
185, 200-225	6	3.5995 (port)	standard 18-4190	436860	18-3901	436254	—	—	—	—
185, 200-225	6	3.5995 (starboard)	standard 18-4079	436859	18-3901	436254	—	—	—	—
185, 200-225	6	3.5995 (port)	0.02 18-4195	439015	18-3947	439538	—	—	—	—
185, 200-225	6	3.5995 (starboard)	0.02 18-4086	439516	18-3947	439538	—	—	—	—
185, 200-225	6	3.5995 (port)	0.03 18-4165	439515	—	439538	—	—	—	—
185, 200-225	6	3.5995 (starboard)	0.03 18-4087	439515	—	439538	—	—	—	—

① This product is priced per piece. To order priced per package, please add -9 to the part number.

INLINE PISTON & RINGS APPLICATION

HP	Year	Cyl	Std. Bore	Std. Piston	.020 OS Piston	.030 OS Piston	Std. Rings	.020 OS Rings	.030 OS Rings
5/6/8/7.5	1986-95	2	1.937	18-4069	—	—	18-3972	—	—
9.9/15	1974-80	2	2.188	—	—	18-4062	—	—	18-3933
9.9/15	1981-93	2	2.188	—	—	—	—	—	18-3933
10	1988-90	2	2.188	—	—	—	—	—	18-3933
14	1988-90	2	2.188	—	—	—	—	—	18-3933
15 4-Stroke	1995-UP	2	2.188	—	—	—	—	—	18-3933
18 Jet	1995-98	2	3	18-4107	—	—	18-3910	18-3911	18-3912
20	1981-99	2	3	18-4107	—	—	18-3910	18-3911	18-3912
25	1977-80	2	3	—	—	—	18-3910	18-3911	18-3912
25	1981-96	2	3	18-4107	—	—	18-3910	18-3911	18-3912
25	1983-93	2	3.187	—	—	—	18-3913	18-3914	18-3915
28	1986-96	2	3	18-4107	—	—	18-3910	18-3911	18-3912
28 Jet	1995-96	2	3.187	—	—	—	18-3913	18-3914	18-3915
30	1984-98	2	3	18-4107	—	—	18-3910	18-3911	18-3912
35	1976-80	2	3	—	—	—	18-3910	18-3911	18-3912
35	1981-92	2	3	18-4107	—	—	18-3910	18-3911	18-3912
35	1986-87	2	3.187	—	—	—	18-3913	18-3914	18-3915
35 Jet	1990-98	2	3.187	—	—	—	18-3913	18-3914	18-3915
40	1975-83	2	3.187	—	—	—	18-3913	18-3914	18-3915
40	1984-98	2	3.187	—	—	—	18-3913	18-3914	18-3915
40 Comm.	1981-97	2	3.187	—	—	—	18-3913	18-3914	18-3915
45 Comm.	1985-92	2	3.187	—	—	—	18-3913	18-3914	18-3915
45SS	1987-90	2	3.187	—	—	—	18-3913	18-3914	18-3915
48	1987-97	2	3.187	—	—	—	18-3913	18-3914	18-3915
50	1981-95	2	3.187	—	—	—	18-3913	18-3914	18-3915
50	1995-98	3	3.187	18-4063	—	18-4064	18-3913	18-3914	18-3915
55	1976-79	2	3.187	—	—	—	18-3913	18-3914	18-3915
55 Comm.	1980-95	2	3.187	—	—	—	18-3913	18-3914	18-3915
60	1980-85	2	3.187	—	—	—	18-3913	18-3914	18-3915
60 (49 CID Model)	1986-88	3	3	18-4124	18-4114	18-4104	18-3910	18-3911	18-3912
60	1986-98	3	3.187	18-4063	—	18-4064	18-3913	18-3914	18-3915
65, 65 Comm.	1972-73	3	3	—	—	—	18-3910	18-3911	18-3912
49 CID Model	1984-86	3	3	18-4124	18-4114	18-4104	18-3910	18-3911	18-3912
65	1987-95	3	3.187	18-4063	—	18-4064	18-3913	18-3914	18-3915
65 Jet	1991-95	4	3.5	18-4120	18-4110	18-4100	18-3904	18-3906	18-3905
70	1974-75	3	3	—	—	—	18-3910	18-3911	18-3912
70	1976-85	3	3	18-4124	18-4114	18-4104	18-3910	18-3911	18-3912
70	1986-94	3	3.187	18-4063	—	18-4064	18-3913	18-3914	18-3915
75	1975	3	3	—	—	—	18-3910	18-3911	18-3912
75	1976-88	3	3	18-4124	18-4114	18-4104	18-3910	18-3911	18-3912

JOHNSON/EVINRUDE PISTONS (for V-4, V-6 and V-8 Applications)

HP	Cyl	Year	Std. Bore	STANDARD		.020° OS		.030° OS		Piston Rings	.020 OS Rings	.030 OS Rings	Powerhead Bearing Set
				Port	STBD	Port	STBD	Port	STBD				
65 Jet	4	1991-95	3.5	18-4120	18-4120	18-4110	18-4110	18-4100	18-4100	18-3904	18-3906	18-3905	18-1386
80 Jet	4	1991-96	3.5	18-4120	18-4120	18-4110	18-4110	18-4100	18-4100	18-3904	18-3906	18-3905	—
85	4	1979-80, 1991-95	3.5	18-4120	18-4120	18-4110	18-4110	18-4100	18-4100	18-3904	18-3906	18-3905	18-1386
88	4	1987-95	3.5	18-4120	18-4120	18-4110	18-4110	18-4100	18-4100	18-3904	18-3906	18-3905	18-1386
90	4	1981-98	3.5	18-4120	18-4120	18-4110	18-4110	18-4100	18-4100	18-3904	18-3906	18-3905	18-1386
100 ①	4	1979-97	3.5	18-4120	18-4120	18-4110	18-4110	18-4100	18-4100	18-3904	18-3906	18-3905	18-1386
110	4	1986-90	3.5	18-4120	18-4120	18-4110	18-4110	18-4100	18-4100	18-3904	18-3906	18-3905	18-1386
115	4	1974-77	3.5	18-4120	18-4120	18-4110	18-4110	18-4100	18-4100	18-3904	18-3906	18-3905	—
115	4	1978-98	3.5	18-4120	18-4120	18-4110	18-4110	18-4100	18-4100	18-3904	18-3906	18-3905	18-1386

① Except 1991 60° V Models

JOHNSON/EVINRUDE PISTONS (for V-4, V-6 and V-8 Applications) (Cont.)

HP	Cyl	Year	Std. Bore	STANDARD		.020" OS		.030" OS		Piston Rings	.020 OS Rings	.030 OS Rings	Powerhead Bearing Set
				Port	STBD	Port	STBD	Port	STBD				
120	4	1985-87	3.5	—	—	—	18-4111	18-4102	18-4101	18-3904	18-3906	18-3905	—
120	4	1988-94	3.685	18-4065	18-4066	—	—	18-4067	18-4068	18-3975	—	—	—
125 Comm.	4	1992-95	3.685	18-4065	18-4066	—	—	18-4067	18-4068	18-3975	—	—	—
130	4	1995-98	3.685	18-4065	18-4066	—	—	18-4067	18-4068	18-3975	—	—	—
135	4	1974-76	3.5	18-4120	18-4120	18-4110	18-4110	18-4100	18-4100	18-3904	18-3906	18-3905	—
140	4	1977	3.5	18-4120	18-4120	18-4110	18-4110	18-4100	18-4100	18-3904	18-3906	18-3905	—
140	4	1978-84	3.5	18-4120	18-4120	18-4110	18-4110	18-4100	18-4100	18-3904	18-3906	18-3905	18-1386
140	4	1985-87	3.5	—	—	—	18-4111	18-4102	18-4101	18-3904	18-3906	18-3905	—
140	4	1988-94	3.685	18-4065	18-4066	—	—	18-4067	18-4068	18-3975	—	—	—
1600CC	4	1988	3.5	18-4120	18-4120	18-4110	18-4110	18-4100	18-4100	18-3904	18-3906	18-3905	18-1386
150	6	1973-77	3.5	18-4120	18-4120	18-4110	18-4110	18-4100	18-4100	18-3904	18-3906	18-3905	—
150	6	1978-91	3.5	18-4120	18-4120	18-4110	18-4110	18-4100	18-4100	18-3904	18-3906	18-3905	—
155 Comm.	6	1984-92	3.5	18-4120	18-4120	18-4110	18-4110	18-4100	18-4100	18-3904	18-3906	18-3905	—
175	6	1977-83	3.5	18-4120	18-4120	18-4110	18-4110	18-4100	18-4100	18-3904	18-3906	18-3905	—
175	6	1986-91	3.625	18-4123	18-4123	18-4113	18-4113	—	—	18-3907	—	18-3908	—
185	6	1984-85	3.5	18-4120	18-4120	18-4110	18-4110	18-4100	18-4100	18-3904	18-3906	18-3905	—
185	6	1990-93	—	—	—	—	—	—	—	—	—	—	18-1389
185 Looper	6	1993-94	3.5995	18-4190	18-4079	18-4195	18-4086	18-4165	—	—	—	—	—
200	6	1976-83	3.5	18-4120	18-4120	18-4110	18-4110	18-4100	18-4100	18-3904	18-3906	18-3905	18-1389
200	6	1985-87	3.5	—	—	—	18-4111	18-4102	18-4101	18-3904	18-3906	18-3905	—
200 ①	6	1988-93	3.685	18-4065	18-4066	—	—	18-4067	18-4068	18-3975	—	—	18-1389
200-225 Looper	6	1993-01	3.5995	18-4190	18-4079	18-4195	18-4086	18-4165	18-4087	—	—	—	—
225	6	1985-87	3.5	—	—	—	18-4111	18-4102	18-4101	18-3904	18-3906	18-3905	18-1389
225	6	1988-93	3.685	18-4065	18-4066	—	—	18-4067	18-4068	18-3975	—	—	18-1389
235	6	1980-85	3.625	18-4123	18-4123	18-4113	18-4113	18-4103	18-4103	18-3907	—	18-3908	—
250/300	6	1990-93	3.685	18-4065	18-4066	—	—	18-4067	18-4068	18-3975	—	—	—
2500CC	6	1988	3.5	18-4120	18-4120	18-4110	18-4110	18-4100	18-4100	18-3904	18-3906	18-3905	—
250	6	1988-92	3.685	18-4065	18-4066	—	—	18-4067	18-4068	18-3975	—	—	—
275	8	1988-92	3.685	18-4065	18-4066	—	—	18-4067	18-4068	18-3975	—	—	—
275	8	1985-87	3.5	—	—	—	18-4111	18-4102	18-4101	18-3904	18-3906	18-3905	—
300	8	1988-92	3.685	18-4065	18-4066	—	—	18-4067	18-4068	18-3975	—	—	—
300/3.6L	8	1985-87	3.5	—	—	—	18-4111	18-4102	18-4101	18-3904	18-3906	18-3905	—

60° Eagle Series

HP	Cyl.	Bore Size	Piston	OE No.	Piston Ring	OE No.
90-175	4 & 6	3.600 (port)	—	436242	18-4088	436353
90-175	4 & 6	3.600(starboard)	—	436243	18-4088	436353
90-175	4 & 6	3.620 (port)	—	N/A	18-4089	N/A
90-175	4 & 6	3.620 (starboard)	—	N/A	18-4089	N/A
90-175	4 & 6	3.630 (port)	—	439519	18-4090	436354

OMC V-4/V-6 60° Eagle Series Pistons

H.P.	YEAR	CYL.	STD. BORE	STANDARD		.020" O.S.		.030" O.S.		STD. RINGS	.030" O.S. Rings
				(PORT)	(STBD)	(PORT)	(STBD)	(PORT)	(STBD)		
90-175	1991-2000	4 & 6	3.600	—	—	—	—	18-4058	—	18-4088	18-4090

OMC SEA DRIVE PISTONS

H.P.	YEAR	CYL.	STD. BORE	STANDARD		.020" O.S.		.030" O.S.		STD. RINGS	.020" O.S. RINGS	.030" O.S. RINGS
				(PORT)	(STBD)	(PORT)	(STBD)	(PORT)	(STBD)			
1.6L	1983-89	4	3.500	18-4120	18-4120	18-4110	18-4110	18-4100	18-4100	18-3904	18-3906	18-3905
1.8L	1987	4	3.500	—	—	—	18-4111	18-4102	18-4101	18-3904	18-3906	18-3905
2.5L	1982, 1984-85	6	3.500	18-4120	18-4120	18-4110	18-4110	18-4100	18-4100	18-3904	18-3906	18-3905
2.6L	1982-86	6	3.625	18-4123	18-4123	18-4113	18-4113	—	—	18-3907	—	18-3908
2.7L	1987	6	3.500	—	—	—	18-4111	18-4102	18-4101	18-3904	18-3906	18-3905
3.6L	1987	8	3.500	—	—	—	18-4111	18-4102	18-4101	18-3904	—	18-3905

ORIGINAL EQUIPMENT MANUFACTURER RECOMMENDS THE REPLACEMENT OF ROD BOLTS WITH EVERY POWER HEAD REBUILD.



ROD BOLTS

Part #	OE#	Application
18-4075	308186	For V-4 & V-6 Crossflow engines
18-4075-9 ^{①②}	308186	For V-4 & V-6 Crossflow engines
18-4076	330081	For V-4 Looper engines



**18-1752
CONNECTING ROD**

Replaces: 394462
For: 40HP (1999-01), 50HP (1995-98), 60HP (1989-01), 70HP (1986-01)



**18-1753
CONNECTING ROD**

Replaces: 395861
For: 30HP (1999-01), 40 HP (1985-02), 45HP (1986-87, 1990-97), 48HP (1987-96), 50HP (1985-02), 55HP (1985-93, 1999-01), 60 HP (1985)



**18-4148-1
CONNECTING ROD**

Replaces: 394488, 5004705
For: V-4 Looper engines and some V-6 applications



**18-4197
CRANKSHAFT**

Replaces: 334665
3 Cylinder Looper
Year HP
1989-92 60
1989-92 65 Comm
1989-95 70



**18-1352
CENTER MAIN
BEARING**

Replaces: 378252



**18-1353
CENTER MAIN
BEARING**

Replaces: 387041



**18-1360
ROD BEARING**

Replaces: 396041



**18-1361
ROD CRANK END
BEARING**

Replaces: 387787



**18-1378
ROD BEARING**

Replaces: 388344



**18-1374
WRIST PIN
BEARING**

Replaces: 395627



**18-1376
WRIST PIN BEARING**

Replaces: 434844



**18-1377
CENTER MAIN
BEARING**

Replaces: 320499



**18-4712
SLEEVE**

I.D. 3.1875 • O.D. 3.453 • Wall 0.125 • Length 5.556
Replacement straight sleeve with ports cut in

APPLICATION BEGINS ON NEXT PAGE

① Priced per Package

② Package of 12



18-4040

**NEEDLE BEARINGS
(18 Needles)**

Replaces: 387142, 387139
(Crank End)
(Must re-use cage)



POWERHEAD BEARINGS

Part #	Replaces:	Description
18-1391	330854	Lower Crankshaft Bearing
18-1393	393896	Upper Crankshaft Bearing
18-1395	385503	Lower Crankshaft Bearing
18-1396	390641	Lower Crankshaft Bearing

POWERHEAD BEARING KITS

18-1386

Contains

Part No.	Bearing Type	OE No.	Qty.
18-1353	Ctr. Main	387041	1
18-1377	Ctr. Main	320499	1
18-1374	Wrist Pin	395627	4
18-1395	Lower Crankshaft	385503	1
18-1361	Rod Crank End	387787	4



18-1389

Contains

Part No.	Bearing Type	OE No.	Qty.
18-1353	Ctr. Main	387041	2
18-1377	Ctr. Main	320499	2
18-1376	Wrist Pin	434844	6
18-1396	Lower Crankshaft	390641	1
18-1360	Rod	396041	4



HP	Year	Sleeve	Connecting Rod	Rod Bolt	Wrist Pin Brg.	Rod Brg. Complete	Rod Brgs.	Center Main Brg.	Split Brg. (sleeve)	Upper Crank Brg.	Lower Crank Brg.	Powerhead Brg. Kit
2 CYLINDER												
9.9	1974-83	-	-	-	-	-	-	-	-	-	-	-
9.9	1974-83	-	-	-	-	-	-	-	-	-	-	-
9.9	1974-80	-	-	-	-	-	-	-	-	-	-	-
9.9	1981-83	-	-	-	-	-	-	-	-	-	-	-
9.9	1986-92	-	-	-	-	-	-	-	-	-	-	-
9.9	1984-97	-	-	-	-	-	-	-	-	-	-	-
9.9	1998	-	-	-	-	-	-	-	-	-	-	-
14 Comm	1988-89	-	-	-	-	-	-	-	-	-	-	-
15	1974-83	-	-	-	-	-	-	-	-	-	-	-
15	1984-97	-	-	-	-	-	-	-	-	-	-	-
15 Comm	1994	-	-	-	18-1296	-	-	-	-	-	-	-
18	1960-68	-	-	-	-	-	18-4040	-	-	-	-	-
18	1970-73	-	-	-	-	-	18-4040	-	-	-	-	-
18 Jet	1996-97	-	-	-	18-1374	18-1378	-	-	-	18-1393	18-1391	-
20	1981-84	-	-	-	18-1374	18-1378	18-4040	-	-	-	18-1391	-
20	1985-97	-	-	-	18-1374	18-1378	-	-	-	18-1393	18-1391	-
25	1970-76	-	-	-	-	-	18-4040	-	-	-	-	-
25	1977	-	-	-	-	18-1378	18-4040	-	-	-	18-1391	-
25	1978-80	-	-	18-4075	-	18-1378	18-4040	-	-	-	18-1391	-
25	1981-84	-	-	-	18-1374	18-1378	18-4040	-	-	18-1391	18-1391	-
25 ①	1985-97	-	-	-	-	-	-	-	-	18-1393	18-1391	-
25	1985-97	-	-	18-4075	18-1374	18-1378	-	-	-	-	-	-
25 Comm	1982-84	-	-	-	18-1374	18-1378	18-4040	-	-	-	18-1391	-
25 Comm	1985-97	-	-	-	18-1374	18-1378	-	-	-	18-1393	18-1391	-
28	1987-97	-	-	-	18-1374	18-1378	-	-	-	18-1393	18-1391	-
30	1981-93	-	-	18-4075	18-1374	18-1378	18-4040	-	-	-	-	-
30	1984-1992	-	-	18-4075	-	18-1378	18-4040	-	-	-	-	-
30	1985-97	-	-	-	18-1374	18-1378	18-4040	-	-	18-1393	18-1391	-
30	1984	-	-	-	-	18-1378	18-4040	-	-	-	18-1391	-
33	1965-69	-	-	-	-	18-1378	18-4040	-	-	-	-	-
33	1970	-	-	-	-	18-1378	18-4040	-	-	-	-	-

① Except "D" Models
② Two Cylinder Models

③ Three Cylinder Models
④ 90 Degree Models

⑤ 60 Degree Models
⑥ V-4, V-6 & V-8 Model engines do not include upper bearings in kits

APPLICATION CONTINUED ON NEXT PAGE

HP	Year	Sleeve	Connecting Rod	Rod Bolt	Wrist Pin Brg.	Rod Brg. Complete	Rod Brgs.	Center Main Brg.	Split Brg. (sleeve)	Upper Crank Brg.	Lower Crank Brg.	Powerhead Brg. Kit
35	1976-80	-	-	-	-	18-1378	18-4040	-	-	-	18-1391	-
35	1981-84	-	-	18-4075	18-1374	-	18-4040	-	-	-	18-1391	-
35	1985-97	-	-	-	18-1374	18-1378	-	-	-	18-1393	18-1391	-
35	1976-1993	-	-	18-4075	18-1374	18-1378	-	-	-	-	-	-
35	1977	-	-	18-4075	-	-	-	-	-	-	-	-
35	1978-1980	-	-	18-4075	-	18-1378	18-4040	-	-	-	18-1391	-
35	1981-1993	-	-	18-4075	18-1374	18-1378	-	-	-	18-1393	18-1391	-
40	1984-92	18-4712	-	18-4075	18-1374	18-1378	-	18-1352	-	-	18-1391	-
40	1961-70	-	-	-	-	-	18-4040	-	-	-	-	-
40	1971-73	-	-	-	-	18-1378	18-4040	-	-	-	-	-
40	1974-76	-	-	-	-	18-1378	18-4040	18-1352	-	-	18-1154	-
40	1984-86	-	-	-	18-1374	18-1378	-	18-1352	-	18-1372	18-1154	-
40	1987-97	-	-	-	18-1374	18-1378	-	18-1352	-	-	18-1154	18-1389
40	1983	-	-	18-4075	-	-	-	18-1352	-	-	18-1154	-
40 Comm	1982-83	-	-	-	-	18-1378	-	18-1352	-	-	-	-
40 Comm	1984-85	-	-	-	-	18-1378	-	18-1352	-	18-1372	-	-
40 Comm	1989-90	-	-	-	-	18-1378	-	18-1352	-	-	-	-
40 Comm	1994	-	-	-	18-1374	18-1378	-	18-1352	-	-	-	-
40 Comm	1995-97	-	-	-	18-1374	-	-	18-1352	-	-	-	-
45 Comm	1985-86	-	-	-	18-1374	18-1378	-	18-1352	-	18-1372	-	-
45 Comm	1987-94	-	-	-	18-1374	18-1378	-	18-1352	-	18-1372	-	-
45 Comm	1995-97	-	-	-	18-1374	-	-	18-1352	-	-	-	-
45 Comm	1987	-	-	-	18-1374	18-1378	-	18-1352	-	-	18-1154	-
45ss	1987-90	-	-	-	18-1374	18-1378	-	18-1352	-	18-1372	-	-
48	1987	18-4712	-	-	18-1374	18-1378	-	18-1352	-	18-1372	-	-
48	1987-92	18-4712	-	18-4075	18-1374	18-1378	-	18-1352	-	-	-	-
48	1988-96	-	-	-	18-1374	18-1378	-	18-1352	-	-	-	-
50	1979-83	18-4712	-	18-4075	18-1374	18-1378	18-4040	18-1352	-	18-1372	-	-
50	1979-86	-	-	-	18-1374	18-1378	-	18-1352	-	18-1372	-	-
50	1981-93	18-4712	-	18-4075	18-1374	18-1378	-	18-1352	-	-	-	-
50i	1987-97	-	-	-	18-1374	18-1378	-	18-1352	-	-	-	-
50i	1995-97	-	-	-	18-1374	18-1378	-	18-1352	-	-	-	-
55	1968-69	-	-	-	-	18-1378	18-4040	18-1352	-	-	-	-
55	1976-81	-	-	-	18-1374	18-1378	18-4040	18-1352	-	18-1372	-	-
55 Comm	1982	-	-	-	18-1374	18-1378	18-4040	18-1352	-	18-1372	-	-
55 Comm	1983-86	-	-	-	18-1374	18-1378	-	18-1352	-	18-1372	-	-
55 Comm	1987-94	-	-	-	18-1374	18-1378	-	18-1352	-	-	-	-
55 Comm	1995-97	-	-	-	18-1374	18-1378	-	18-1352	-	-	-	-
55	1978-93	18-4712	-	18-4075	-	-	-	-	-	-	-	-
60	1980-85	18-4712	-	18-4075	18-1374	18-1378	-	18-1352	-	18-1372	-	-
60	1964-67,70-71	-	-	-	-	18-1378	18-4040	18-1352	-	-	-	-
60	86-90	-	-	-	18-1374	18-1378	-	18-1352	-	18-1372	-	-
60	1991-93	-	-	-	18-1374	18-1378	-	18-1352	-	-	-	-
60	1994-97	-	-	-	18-1374	-	-	18-1352	-	-	-	-
SST-60	1989-90	-	-	-	18-1374	18-1378	-	18-1352	-	18-1372	-	-
3 Cylinder												
60	1985	-	-	18-4075	18-1374	18-1378	18-4040	18-1352	-	18-1372	-	-
60	1986-90	-	-	-	18-1374	18-1378	18-4040	18-1352	-	18-1372	-	-
60	1986-88	-	-	18-4075	18-1374	18-1378	18-4040	18-1352	-	18-1372	-	-
60	1989-92	-	-	18-4075	18-1374	18-1378	18-4040	18-1352	-	-	-	-
65	1968	-	-	-	-	18-1378	18-4040	18-1352	-	-	-	-
65	1972-73	-	-	-	-	18-1378	18-4040	18-1352	-	18-1372	-	-

① Except "D" Models
② Two Cylinder Models

③ Three Cylinder Models
④ 90 Degree Models

⑤ 60 Degree Models
⑥ V-4, V-6 & V-8 Model engines do not include upper bearings in kits

APPLICATION CONTINUED ON NEXT PAGE

HP	Year	Sleeve	Connecting Rod	Rod Bolt	Wrist Pin Brg.	Rod Brg. Complete	Rod Brgs.	Center Main Brg.	Split Brg. (sleeve)	Upper Crank Brg.	Lower Crank Brg.	Powerhead Brg. Kit
65 Comm	1984	-	-	-	18-1374	18-1378	18-4040	18-1352	-	18-1372	-	-
65 Comm	1985-90	-	-	-	18-1374	18-1378	18-4040	18-1352	-	18-1372	-	-
65 Comm	1991-93	-	-	-	18-1374	18-1378	18-4040	18-1352	-	-	-	-
65 Comm.	1994-97	-	-	-	18-1374	18-1378	18-4040	18-1352	-	-	-	-
65	1984-86	-	-	18-4075	18-1374	18-1378	18-4040	18-1352	-	18-1372	18-1154	-
70	1976-85	-	-	18-4075	18-1374	18-1378	18-4040	18-1352	-	18-1372	18-1154	-
70	1974-75	-	-	-	-	18-1378	18-4040	18-1352	-	18-1372	-	-
70	1976-90	-	-	-	18-1374	18-1378	18-4040	18-1352	-	18-1372	18-1154	-
70	1976-84	-	-	18-4075	18-1374	18-1378	18-4040	18-1352	-	18-1372	18-1154	-
70	1985-90	-	-	-	18-1374	18-1378	18-4040	18-1352	-	18-1372	18-1154	-
70	1991-93	-	-	-	18-1374	18-1378	18-4040	18-1352	-	-	-	-
70	1994-97	-	-	-	18-1374	-	-	18-1352	-	-	-	-
75	1960-65	-	-	-	-	18-1378	18-4040	18-1352	-	-	-	-
75	1975	-	-	-	-	18-1378	18-4040	18-1352	-	18-1372	18-1154	-
75	1976-84	-	-	18-4075	18-1374	18-1378	18-4040	18-1352	-	18-1372	18-1154	-
75	1982-88	-	-	18-4075	18-1374	18-1378	18-4040	18-1352	-	18-1372	18-1154	-
75	1985-88	-	-	-	18-1374	18-1378	18-4040	18-1352	-	18-1372	18-1154	-
75 ⑥	1976-88	-	-	18-4075	18-1374	18-1378	18-4040	18-1352	-	18-1372	18-1154	-
V-4 CROSSFLOW												
65JET	1992-95	-	-	18-4075	18-1374	18-1361	18-4040	18-1353	18-1377	-	18-1395	18-1386
80	1966- 67	-	-	-	-	18-1378	18-4040	18-1352	-	-	-	-
80JET	1993-97	-	-	18-4075	18-1374	18-1361	18-4040	18-1353	18-1377	-	18-1395	18-1386
80JET	1992-97	-	-	-	18-1374	18-1361	18-4040	18-1353	18-1377	-	18-1395	18-1386
85	1968-72	-	-	-	-	18-1378	18-4040	18-1352	-	-	18-1154	-
85	1973	-	-	-	18-1374	18-1378	18-4040	18-1352	-	-	18-1395	-
85	1974-78	-	-	-	18-1374	18-1361	18-4040	18-1352	-	-	18-1395	-
85 ⑥	1979-80	-	-	18-4075	18-1374	18-1361	18-4040	18-1353	18-1377	-	18-1395	18-1386
85 ⑥	1991-95	-	-	-	18-1374	18-1361	18-4040	18-1353	18-1377	-	18-1395	18-1386
85	1979-80,92	-	-	18-4075	18-1374	18-1361	18-4040	18-1353	18-1377	-	18-1395	18-1386
85TTL	1992-95	-	-	18-4075	18-1374	18-1361	18-4040	18-1353	18-1377	-	18-1395	18-1386
88	1987-91	-	-	18-4075	18-1374	18-1361	18-4040	18-1353	18-1377	-	18-1395	18-1386
88 ⑥	1987-96	-	-	18-4075	18-1374	18-1361	18-4040	18-1353	18-1377	-	18-1395	18-1386
88	1987-92	-	-	18-4075	18-1374	18-1361	18-4040	18-1353	18-1377	-	18-1395	18-1386
88	1993	-	-	18-4075	18-1374	18-1361	18-4040	18-1353	18-1377	-	18-1395	18-1386
88	1992-96	-	-	18-4075	18-1374	18-1361	18-4040	18-1353	18-1377	-	18-1395	18-1386
90	1981-86	-	-	18-4075	18-1374	18-1361	18-4040	18-1353	18-1377	-	18-1395	18-1386
90	1986-91	-	-	18-4075	18-1374	18-1361	18-4040	18-1353	18-1377	-	18-1395	18-1386
90	1992-94	-	-	18-4075	18-1374	18-1361	18-4040	18-1353	18-1377	-	18-1395	18-1386
90 ⑥ ④	1981-97	-	-	18-4075	18-1374	18-1361	18-4040	18-1353	18-1377	-	18-1395	18-1386
90 ④	1981-97	-	-	18-4075	18-1374	18-1361	18-4040	18-1353	18-1377	-	18-1395	18-1386
90 ⑤	1995-97	-	-	18-4075	18-1374	18-1361	18-4040	18-1353	18-1377	-	18-1395	18-1386
90JET ⑥	1994-95	-	-	18-4075	18-1374	18-1361	18-4040	18-1353	18-1377	-	18-1395	18-1386
90	1981-92	-	-	18-4075	18-1374	18-1361	18-4040	18-1353	18-1377	-	18-1395	18-1386
90	1993	-	-	18-4075	18-1374	18-1361	18-4040	18-1353	18-1377	-	18-1395	18-1386
100	1966- 68	-	-	-	-	18-1378	18-4040	18-1352	-	-	18-1154	-
100	1971- 72	-	-	-	-	18-1378	18-4040	18-1352	-	-	18-1154	-
100 ⑥	1979-80	-	-	18-4075	18-1374	18-1361	18-4040	18-1353	18-1377	-	18-1395	18-1386
100	1984-85	-	-	18-4075	18-1374	18-1361	18-4040	18-1353	18-1377	-	18-1395	18-1386
100	1986-91	-	-	18-4075	18-1374	18-1361	18-4040	18-1353	18-1377	-	18-1395	18-1386
100 ⑥	1990-94	-	-	18-4075	18-1374	18-1361	18-4040	18-1353	18-1377	-	18-1395	18-1386
100 Comm ⑥	1984-97	-	-	18-4075	18-1374	18-1361	18-4040	18-1353	18-1377	-	18-1395	18-1386
100	1979-81,92	-	-	18-4075	18-1374	18-1361	18-4040	18-1353	18-1377	-	18-1395	18-1386
100	1992-97	-	-	18-4075	18-1374	18-1361	18-4040	18-1353	18-1377	-	18-1395	18-1386

① Except "D" Models
② Two Cylinder Models

③ Three Cylinder Models
④ 90 Degree Models

⑤ 60 Degree Models
⑥ V-4, V-6 & V-8 Model engines do not include upper bearings in kits

APPLICATION CONTINUED ON NEXT PAGE

HP	Year	Sleeve	Connecting Rod	Rod Bolt	Wrist Pin Brg.	Rod Brg. Complete	Rod Brgs.	Center Main Brg.	Split Brg. (sleeve)	Upper Crank Brg.	Lower Crank Brg.	Powerhead Brg. Kit
100	1993	-	-	18-4075	18-1374	18-1361	18-4040	18-1353	18-1377	-	18-1395	18-1386
100 Comm	1984-87,89-92	-	-	18-4075	18-1374	18-1361	18-4040	18-1353	18-1377	-	18-1395	18-1386
100 Comm.	1993	-	-	18-4075	18-1374	18-1361	18-4040	18-1353	18-1377	-	18-1395	18-1386
110 ⑥	1986-89	-	-	18-4075	18-1374	18-1361	18-4040	18-1353	18-1377	-	18-1395	18-1386
112 ⑥	1994-96	-	-	-	18-1374	18-1361	18-4040	18-1353	18-1377	-	18-1395	18-1386
115	1969-70	-	-	-	-	18-1378	18-4040	18-1352	-	-	18-1154	-
115	1973	-	-	18-4075	18-1374	18-1378	18-4040	18-1352	-	-	18-1395	-
115	1974-78	-	-	18-4075	18-1374	18-1361	18-4040	18-1352	-	-	18-1395	-
115 ⑥ ④	1990-97	-	-	-	18-1374	18-1361	18-4040	18-1353	18-1377	-	18-1395	18-1386
115 ⑥	1979-85	-	-	18-4075	18-1374	18-1361	18-4040	18-1353	18-1377	-	18-1395	18-1386
115	1991-92	-	-	18-4075	18-1374	18-1361	18-4040	18-1353	18-1377	-	18-1395	18-1386
115	1990-91	-	-	18-4075	18-1374	18-1361	18-4040	18-1353	18-1377	-	18-1395	18-1386
115	1993	-	-	18-4075	18-1374	18-1361	18-4040	18-1353	18-1377	-	18-1395	18-1386
115	1992-94	-	-	18-4075	18-1374	18-1361	18-4040	18-1353	18-1377	-	18-1395	18-1386
115 ④	1990-97	-	-	-	18-1374	18-1361	18-4040	18-1353	18-1377	-	-	-
115 ⑤	1995-97	-	-	-	-	18-1361	18-4040	18-1353	18-1377	-	-	-
115JET ⑥	1994-97	-	-	-	18-1374	18-1361	18-4040	18-1353	18-1377	-	18-1395	18-1386
115C	1984	-	-	18-4075	18-1374	18-1361	18-4040	18-1353	18-1377	-	18-1395	18-1386
120 ⑥	1985-94	-	-	-	18-1376	18-1360	-	18-1353	18-1377	-	18-1396	-
125	1971-72	-	-	-	-	18-1378	18-4040	18-1352	-	-	-	-
125 Comm ⑥	1989-95	-	-	-	18-1376	18-1360	-	18-1353	18-1377	-	18-1396	-
125Esx ⑥	1991-94	-	-	-	18-1376	18-1360	-	18-1353	18-1377	-	18-1396	-
130 ⑥	1994-97	-	-	-	18-1376	18-1360	-	18-1353	18-1377	-	18-1396	-
135	1973	-	-	-	18-1374	18-1378	18-4040	18-1352	-	-	18-1395	-
135	1974-76	-	-	18-4075	18-1374	18-1361	18-4040	18-1352	-	-	18-1395	-
140	1977-78	-	-	18-4075	18-1374	18-1361	18-4040	18-1352	-	-	18-1395	-
140	1979	-	-	18-4075	-	-	-	-	-	-	-	-
140 ⑥	1979-84	-	-	-	18-1374	18-1361	18-4040	18-1353	18-1377	-	18-1395	18-1386
140 ⑥	1985-94	-	-	-	18-1376	18-1360	-	18-1353	18-1377	-	18-1396	-
140	1977-84	-	-	18-4075	18-1374	18-1361	18-4040	18-1353	18-1377	-	18-1395	18-1386
1600CC	1988	-	-	18-4075	-	-	-	-	-	-	-	-
1.6L	-	-	-	18-4075	-	-	-	-	-	-	-	-
V-6 CROSSFLOW												
150 ⑥	1978-91	-	-	-	18-1374	18-1361	18-4040	18-1353	18-1377	-	18-1395	-
150 ⑤	1991-97	-	-	-	-	18-1361	18-4040	18-1353	-	-	-	-
150 Comm ⑤	1993-95	-	-	-	-	18-1361	18-4040	18-1353	-	-	-	-
150	1978-85	-	-	18-4075	18-1374	18-1361	18-4040	18-1353	18-1377	-	18-1395	-
150	1978-88	-	-	18-4075	18-1374	18-1361	18-4040	18-1353	18-1377	-	18-1395	-
150	1986-91	-	-	18-4075	18-1374	18-1361	18-4040	18-1353	18-1377	-	-	-
150	1989-91	-	-	18-4075	18-1374	18-1361	18-4040	18-1353	18-1377	-	-	-
155 Comm	1984-85	-	-	18-4075	18-1374	18-1361	18-4040	18-1353	18-1377	-	18-1395	-
155 Comm ⑥	1984-92	-	-	-	18-1374	18-1361	18-4040	18-1353	18-1377	-	18-1395	-
155 Comm	1986-91	-	-	18-4075	-	-	-	-	-	-	-	-
175 ⑥	1977-91	-	-	-	18-1374	18-1361	18-4040	18-1353	18-1377	-	18-1395	-
175 ⑤	1991-97	-	-	-	-	18-1361	18-4040	18-1353	-	-	-	-
175	1977-83	-	-	18-4075	18-1374	18-1361	18-4040	18-1353	18-1377	-	-	-
175	1986-90	-	-	18-4075	18-1374	18-1361	18-4040	18-1353	18-1377	-	-	-
175	1977-83,85	-	-	18-4075	18-1374	18-1361	18-4040	18-1353	18-1377	-	-	-
185 ⑥	1984-85	-	-	18-4075	18-1374	18-1361	18-4040	18-1353	18-1377	-	18-1395	18-1389
185	1990	-	18-4148-1	18-4076	-	-	-	-	-	-	-	-
185 ⑥	1990-94	-	-	-	18-1376	18-1360	-	18-1353	18-1377	-	18-1396	18-1389
185	1990-93	-	18-4148-1	18-4076	-	-	-	-	-	-	-	-

① Except "D" Models
② Two Cylinder Models

③ Three Cylinder Models
④ 90 Degree Models

⑤ 60 Degree Models
⑥ V-4, V-6 & V-8 Model engines do not include upper bearings in kits

APPLICATION CONTINUED ON NEXT PAGE

HP	Year	Sleeve	Connecting Rod	Rod Bolt	Wrist Pin Brg.	Rod Brg. Complete	Rod Brgs.	Center Main Brg.	Split Brg. (sleeve)	Upper Crank Brg.	Lower Crank Brg.	Powerhead Brg. Kit
185	1992-94	-	18-4148-1	18-4076	-	-	-	-	-	-	-	-
200 ⑥	1976-83	-	-	18-4075	18-1374	18-1361	18-4040	18-1353	18-1377	-	18-1395	18-1389
200	1986-97	-	-	-	18-1376	18-1360	-	18-1353	18-1377	-	18-1396	-
200 Comm	1990	-	18-4148-1	18-4076	-	-	-	-	-	-	18-1396	-
200 Comm	1990-94	-	-	-	18-1376	18-1360	-	18-1353	18-1377	-	-	-
200	1976-83	-	-	18-4075	18-1374	18-1361	18-4040	18-1353	18-1377	-	18-1395	-
200C	1990	-	-	18-4076	18-1376	18-1360	-	18-1353	18-1377	-	18-1396	-
200	1986-91	-	-	18-4076	-	-	-	-	-	-	-	-
200	1986-93	-	-	18-4076	-	-	-	-	-	-	-	-
225 ⑥	1986-97	-	-	-	18-1376	18-1360	-	18-1353	18-1377	-	18-1396	18-1389
235 ⑥	1978-85	-	-	18-4075	18-1374	18-1361	18-4040	18-1353	18-1377	-	18-1395	-
235	1978-79	-	-	18-4075	18-1374	18-1361	18-4040	18-1353	18-1377	-	-	-
235	1980-85	18-4718	-	18-4075	18-1374	18-1361	18-4040	18-1353	18-1377	-	-	-
250	1991-95	-	-	-	18-1376	18-1360	-	18-1353	18-1377	-	18-1396	-
250	1997	-	-	-	18-1376	18-1360	-	18-1353	18-1377	-	18-1396	-
275	1985-88	-	-	-	18-1376	18-1360	-	18-1353	18-1377	-	18-1396	-
3.6L	1985-87	-	-	-	18-1376	18-1360	-	18-1353	18-1377	-	18-1396	-
300	1988-95	-	-	-	18-1376	18-1360	-	18-1353	18-1377	-	18-1396	-
2500CC	1988	-	-	-	-	-	-	-	-	-	-	-
2.5L	1982,84-85	-	-	-	-	-	-	-	-	-	-	-
2.6L	1982-86	18-4718	-	-	-	-	-	-	-	-	-	-
V-4 LOOPER												
120	1985	-	-	18-4076	18-1376	18-1360	-	18-1353	18-1377	-	18-1396	-
120	1985-94	-	-	18-4076	18-1376	18-1360	-	18-1353	18-1377	-	18-1396	-
125	1985-94	-	-	18-4076	18-1376	18-1360	-	18-1353	18-1377	-	18-1396	-
140	1985-94	-	-	18-4076	18-1376	18-1360	-	18-1353	18-1377	-	18-1396	-
1.8L	ALL	-	-	18-4076	-	-	-	-	-	-	-	-
V-6 LOOPER												
225	1986-91	-	-	18-4076	18-1376	18-1360	-	18-1353	18-1377	-	18-1396	-
225	1986-93	-	-	18-4076	18-1376	18-1360	-	18-1353	18-1377	-	18-1396	-
2.7L	1987	-	-	18-4076	-	-	-	-	-	-	-	-
275	1985-88	-	-	18-4076	18-1376	18-1360	-	18-1353	18-1377	-	18-1396	-
300	1985-95	-	-	18-4076	18-1376	18-1360	-	18-1353	18-1377	-	18-1396	-

① Except "D" Models
② Two Cylinder Models

③ Three Cylinder Models
④ 90 Degree Models

⑤ 60 Degree Models
⑥ V-4, V-6 & V-8 Model engines do not include upper bearings in kits



18-4329
CRANKSHAFT SEAL KIT
For: 20-35 HP

HP	Years	HP	Years
20	1981-89	30	1984-89
25	1977-89	35	1976-89
28	1986-88		



18-4330
CRANKSHAFT SEAL KIT
For: 40-75 HP



18-4331
CRANKSHAFT SEAL KIT
For: Crossflow V-4 - V-6



18-4332
CRANKSHAFT SEAL KIT
For: 9.9 - 15 HP



18-8355
CRANKSHAFT SEAL KIT
For:

Year	Model/HP	Year	Model/HP
1990	20-30AC, TE, E/ 20-35R/25COMM.	1993-96	20-35R/25/30TE/ 20-30E
1991-92	25/28/32R, TE, RE	1994-96	20-30AC,E/ 25COMM./28



18-1286
UPPER CRANKSHAFT SEAL
Replaces: 336232
For: 60° & EFI 90-115HP & 150-175HP



***18-7895**
OIL FILTER
 Replaces: 778888, 5035703
 200/225 (2004-05)



***18-7896**
OIL FILTER
 Replaces: 778886, 5033539
 90-115 EFI (2003-05)



***18-7897**
OIL FILTER
 Replaces: 778887, 5033919
 140 EFI (2003-05)



18-7903
OIL FILTER
 Replaces: 5033102, 763364
 9.9-15HP (2002-07)



***18-7915-1**
OIL FILTER
 Replaces: 778885, 5031411
 25-70 HP (1998-2005)



***18-7916**
OIL FILTER
 Replaces: 434839
 9.9 & 15 HP models from (1995-2001)
 OMC Built



18-70936
HOSE (CYLINDER HEAD, STARBOARD)
 Replaces: 340975, 321724
 Fits: 90 (1994-95), 100 (1996-97), 115 (1994-97), E88 (1996), E90 (1996-98), E100 (1996-97), E112 (1996), E115 (1996-98), J88 (1996), J90 (1996-98), J100 (1997-98), J112 (1996), J115 (1996-98)



18-70937
HOSE (CYLINDER HEAD, PORT)
 Replaces: 340976
 Fits: 90 (1994-95), 100 (1996-97), 115 (1994-97), E88 (1996), E90 (1996-98), E100 (1996-97), E112 (1996), E115 (1996-98), J88 (1996), J90 (1996-98), J100 (1997-98), J112 (1996), J115 (1996-98)

SEE PAGES 201-202 FOR OUR COMPLETE LINE OF GASKET SEALANTS

— CONTAINS —

Part #	Desc.	O.E. #	Qty.
18-0933	Air Silencer Gasket	314115	1
18-0935	Base To Cover Gasket	314322	1
18-0951	Carburetor to Manifold Gasket	317305	1
18-2543	Water Jacket Gasket	318609	1
18-0118	Carburetor Gasket	325092	3
18-2913	Exhaust Cover Gasket	318609	2
18-2938	Exhaust Cover Gasket	331917	1
18-2548	Thermostat Gasket	332108	1
18-2865	Adapter to Powerhead Gasket	313763	1
18-0929	Thermostat Gasket	313416	1



18-4300
POWERHEAD GASKET SET
 Replaces: 385416, 439084

— CONTAINS —

Part #	Desc.	O.E. #	Qty.
18-2876	By-Pass Cover Gasket	307133	4
18-2866	Exhaust Cover Gasket	317914	2
18-0953	Water Pass. Gasket	317951	1
18-0117	Exhaust Plate Gasket	317995	1
18-0955	Exhaust Cover Gasket	318156	1
18-2873	Cyl. Cover Starboard Gasket	318335	2
18-0957	Adapter To Powerhead Gasket	318373	1
18-2867	Manifold to Crankcase Gasket	319174	1
18-2864	Adapter to Powerhead Gasket	321727	1
18-0991	Leaf Plate Gasket	321907	4
18-0134	Carburetor to Manifold Gasket	327707	2
18-2857	Air Silencer To Carburetor Gasket	386573, 319771	2

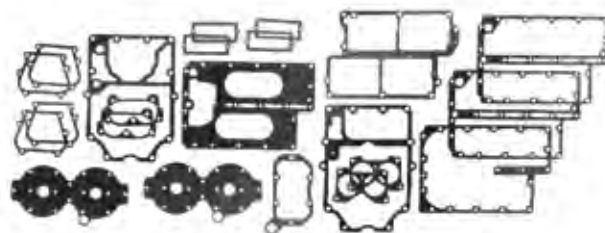

18-4301
POWERHEAD GASKET SET
 Replaces: 388602

APPLICATIONS BEGIN ON PAGE 308

* Anti-Drain-Back Valve
 Valve eliminates dry starts, prevents oil from draining back into crankcase during engine shutdown.

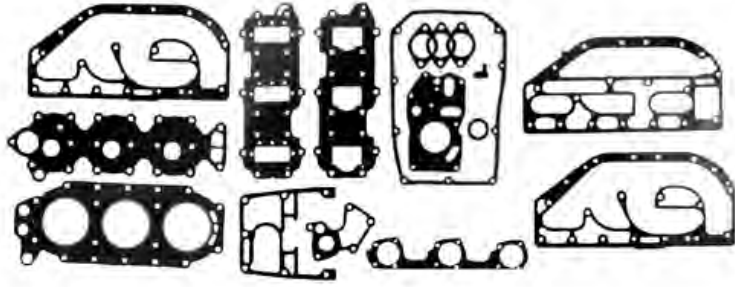

18-4302
POWERHEAD GASKET SET
 Replaces: 390078

— CONTAINS —

Part #	Desc.	O.E. #	Qty.
18-2960	Head Gasket	313413	1
18-2865	Adapter to Powerhead Gasket	313763	1
18-0951	Carb to Manifold Gasket	317305	1
18-2543	Water Jacket Gasket	318609	1
18-0989	Air Silencer Gasket	321794	1
18-0118	Carburetor Gasket	325092	3
18-0102	Exhaust Manifold Gasket	323469	1
18-2913	Exhaust Cover Gasket	331916	2
18-2938	Exhaust Cover Gasket	331917	1
18-2548	Thermostat Cover Gasket	332108	1
18-0975	Carb to Silencer Gasket	333008	1

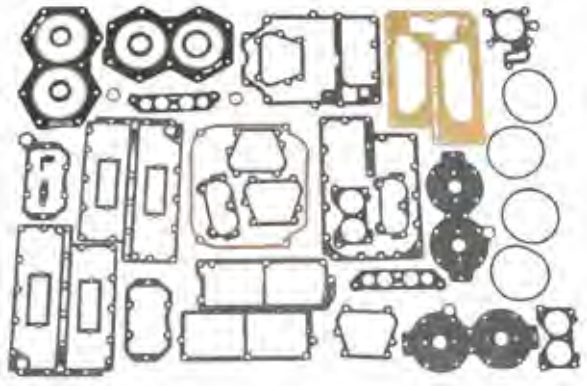

18-4303-1
POWERHEAD GASKET SET
 Replaces: 389556, 391300, 439085

— CONTAINS —

Part #	Desc.	O.E. #	Qty.
18-0850	Fuel Pump Mtg Gasket	303615	1
18-2876	By-Pass Cover Gasket	307133	4
18-2866	Exhaust Cover Gasket	317914	2
18-0953	Water Passage Gasket	317951	1
18-0117	Exhaust Plate Gasket	317995	1
18-2873	Gasket	318335	2
18-2074	Seal	0339620	1
18-2956	Water Jacket Head Gasket	318358	2
18-2867	Manifold to Crankcase Gasket	319174	1
18-2857	Air Silencer to Carb. Gasket	386573, 319771	2
18-0985	Air Silencer Gasket	321722	1
18-2864	Adapter to Powerhead Gasket	321727	1
18-0991	Leaf Plate Gasket	321907	4
18-2547	Water Pass. Cover Gasket	322858	1
18-0102	Exhaust Manifold Gasket	323469	1
18-0134	Intake Plate Gasket	326926	1
18-0977	Thermostat Gasket	332369	2

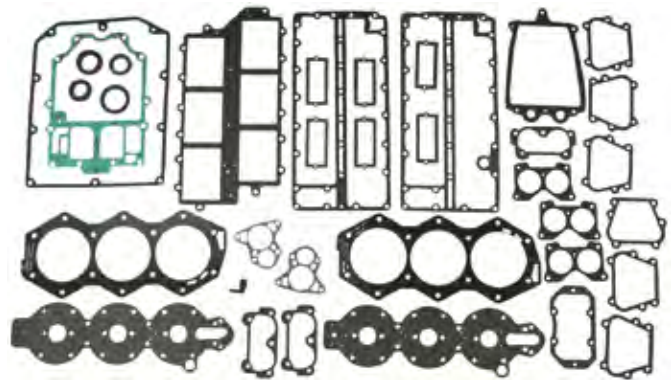

18-4304-1
POWERHEAD GASKET SET
 Replaces: 391988

— CONTAINS —

Part #	Desc.	O.E. #	Qty.
18-2549	Exhaust Plate Gasket	321543	1
18-2876	By-Pass Cover Gasket	307133	6
18-2544	Water Jacket Cover Gasket	321028	2
18-2545	Exhaust Plate Gasket	321182	1
18-0979	Air Silencer Gasket	321183	1
18-2546	Thermostat Gasket	321184	2
18-0991	Leaf Plate Gasket	321907	6
18-2547	Water Passage Cover Gasket	322858	1
18-0995	Adapter to Powerhead Gasket	323222	1
18-0134	Carburetor To Manifold Gasket	327707	3
18-0148	Intake Manifold Gasket	329718	1
18-2964	Head Gasket	320745, 335360, 766779	2
18-2550	Powerhead Gasket	323214	1
18-2857	Air Silencer To Carburetor Gasket	386573, 319771	1
18-2001	Oil Seal	330137	1
18-2074	Oil Seal	0339620	2
18-8307	Oil Seal	331103	1



18-4305
POWERHEAD GASKET SET
 Replaces: 393433, 437806, 439083
 For: 2 cylinder models only

— CONTAINS —

Part #	Desc.	O.E. #	Qty.
18-0851	Relief Port Twin Gasket	329826	1
18-0850	Fuel Pump Mtg. Gasket	303615	1
18-0941	Water Jacket Cover Gasket	315538	1
18-0118	Carburetor Gasket	325092	2
18-0120	Exhaust Cover Gasket	325211	1
18-0128	Powerhead Mtg. Twin Gasket	326468, 351018	1
18-3802	Head Gasket	327795, 335359	1
18-0136	Powerhead Mounting Gasket	328283	1
18-0157	Airbox Split Twin Gasket	330698	1
18-0154	Airbox Split Twin Gasket	—	1
18-0159	Airbox Split Twin Gasket	330909	1
18-0983	Carb. to Air Box Twin Gasket	321497	1
18-0182	Thermostat Gasket	310058	1
18-0963	Intake Manifold Twin Gasket	335633	1

— CONTAINS —

Part #	Desc.	O.E. #	Qty.
18-0850	Fuel Pump Mtg. Gasket	303615	1
18-0122	Outer Leaf Plate Gasket	325260	1
18-0961	Carburetor to Intake Manifold Gasket	318932	1
18-0967	By-Pass Cover Gasket	319332	1
18-0112	Powerhead Mtg. Gasket	324717	1
18-0959	Inner Leaf Plate Gasket	318924	1
18-2907	Adapter Housing Gasket	325721	1
18-2905	Water Cover Gasket	329920	1
18-2853	Exhaust Cover Gasket	318925	2
18-2963	Head Gasket	330818	1
18-2879	Filter Cap to Pump Gasket	331363, 338876	1

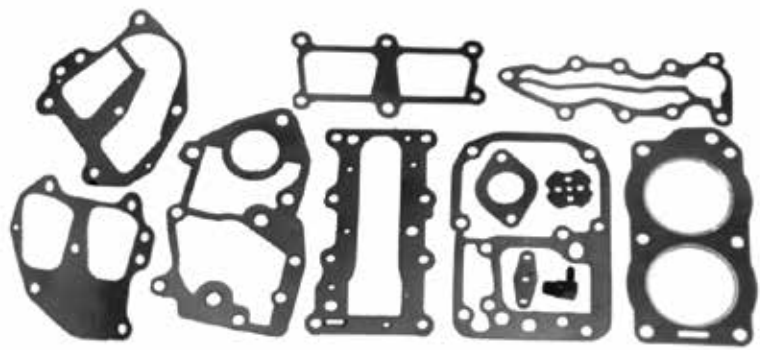

18-4306
POWERHEAD GASKET SET
Replaces: 394546

— CONTAINS —

Part #	Desc.	O.E. #	Qty.
18-0850	Fuel Pump Mounting Gasket	303615	1
18-0971	By-Pass Gasket	319661	1
18-0981	Leaf Plate Gasket	321479	1
18-0106	Exhaust Manifold Gasket	324323	2
18-0118	Carburetor Gasket	325092	1
18-2862	Manifold to Leaf Plate Gasket	321573, 326260	1
18-0126	Inner Exhaust Cover Gasket	326264	1
18-2852	Powerhead to Lower Unit Gasket	330621	1
18-3803	Head Gasket	329419, 765012	1



18-4307
POWERHEAD GASKET SET
Replaces: 433941, 392567, 392615, 389206

— CONTAINS —

Part #	Desc.	O.E. #	Qty.
18-0991	Leaf Plate	321907	6
18-0995	Adapter to Powerhead Gasket	323222	1
18-0134	Carburetor to Manifold Gasket	327707	3
18-0148	Intake Manifold Gasket	329718	1
18-0979	Air Silencer Gasket	321183	1
18-0945	Outer Exhaust Gasket	336430	1
18-0927	Inner Exhaust Cover Gasket	393561	1
18-2544	Water Jack. Cover Gasket	321028	2
18-2546	Thermostat Gasket	321184	2
18-2547	Water Passage Cover Gasket	322858	1
18-2550	Powerhead Gasket	323214	1
18-2857	Air Silencer Carburetor Gasket	386573, 319771	1
18-2876	By-Pass Cover Gasket	307133	6
18-7416	O-Ring	329380	1
18-7417	O-Ring	329381	1
18-3801	Head Gasket	325647, 335361	2

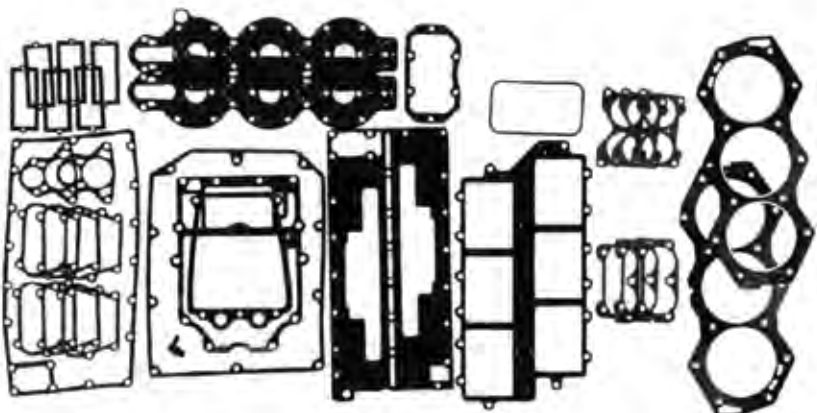

18-4309
POWERHEAD GASKET SET
Replaces: 394885, 434381

— CONTAINS —

Part #	Desc.	O.E. #	Qty.
18-0142	Intake Manifold Gasket	328622	1
18-0155	Rectifier Mtg. Gasket	330412	2
18-0138	Adapter to Powerhead Gasket	328590	1
18-0140	AirBox Gasket	328604	2
18-2074	Oil Seal	0339620	1
18-2075	Oil Seal	0353076	1
18-7418	O-Ring	326741	4
18-3837	Head Gasket	328623	2
18-0978	Cover to Base Gasket	331598	2

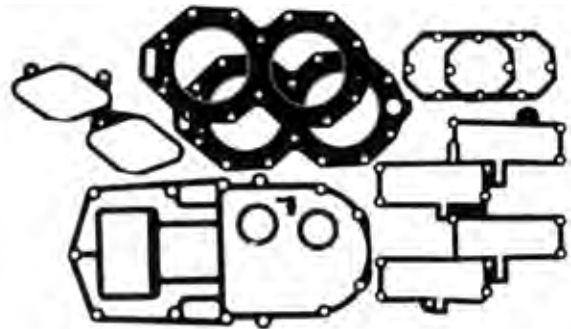

18-4310
POWERHEAD GASKET SET
Replaces: 396750

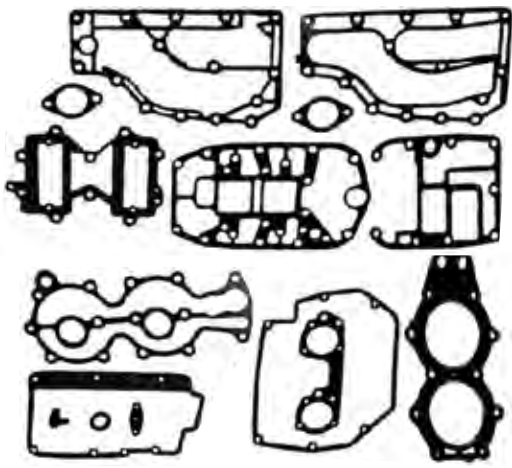

18-4318
POWERHEAD GASKET SET
 Replaces: 390076

— CONTAINS —

Part #	Desc.	O.E. #	Qty.
18-0963	Intake Manifold GasketTwin	335633	1
18-0850	Fuel Pump Mtg. Gasket	303615	1
18-0118	Carburetor Gasket	325092	2
18-0983	Carburetor to Airbox	321497	1
18-3802	Head Gasket	327795, 335359	1
18-0941	Water Jacket Cover Gasket	315538	1
18-0157	Air Box Split Gasket	330698	1
18-0128	Powerhead Mounting Gasket	326468, 351018	1
18-0136	Powerhead Mounting Gasket	328283	1
18-1224	Exhaust Cover Gasket	315869	1
18-1218	Exhaust Cover Gasket	315868	1
18-0182	Seal	310058	1

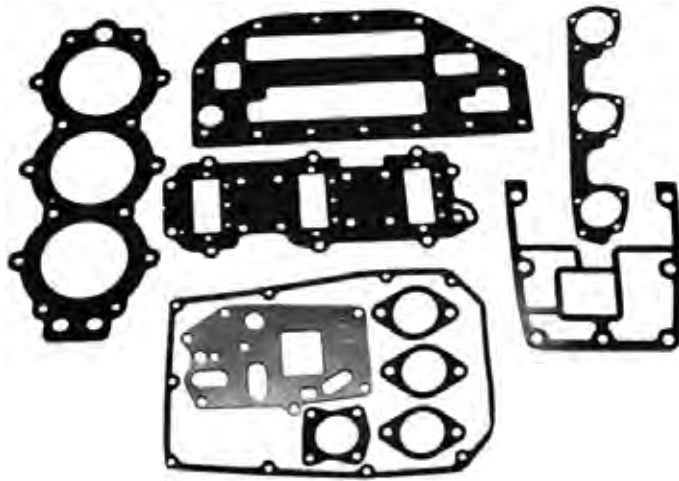

18-4321
POWERHEAD GASKET SET
 Replaces: 398047, 438904

— CONTAINS —

Part #	Desc.	O.E. #	Qty.
18-0118	Carburetor Gasket	325092	3
18-0989	Air Silencer Gasket	321794	1
18-0975	Carb to Silencer Gasket	333008	1
18-3836	Head Gasket	329836	1
18-1202	Thermostat Cover Gasket	329830	1
18-1205	Adapter Gasket	329828	1
18-1207	Exhaust Manifold Gasket	329833, 343863	1
18-1212	Intake Manifold Gasket	326926	1
18-1219	Grommet	320880	1
18-1221	Retainer	330273	1

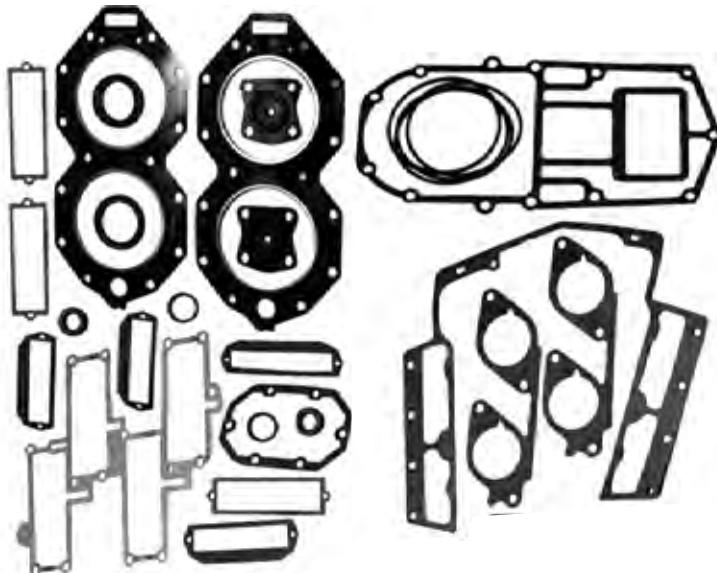

18-4322
POWERHEAD GASKET SET
 Replaces: 432570

— CONTAINS —

Part #	Desc.	O.E. #	Qty.
18-0987	Throttle Body to Manifold Gasket	332319	2
18-0142	Intake Manifold Gasket	328622	1
18-2074	Seal	0339620	1
18-2075	Seal	0353076	1
18-0130	Reed Box Gasket	332266	4
18-7418	O-Ring	326741	4
18-0155	Rectifier Mtg. Gasket	330412	1
18-3866	Head Gasket	328623, 340115	2
18-0138	Adapter to Powerhead Gasket	328590	1
18-0144	Reed Box Gasket	328626	4
18-1221	Retainer	330273	2
18-1219	Grommet	320880	2
18-1222	Thermostat Gasket	394408	2

— CONTAINS —

Part #	Desc.	O.E. #	Qty.
18-0130	Reed Box Gasket	332266	6
18-3839	Head Gasket	334726, 333670	2
18-0161	Lower Manifold Gasket	331532	1
18-0155	Rectifier Mtg. Gasket	330412	1
18-0142	Intake Manifold Gasket	328622	1
18-0987	Throttle Body to Manifold Gasket	332319	3
18-0978	Cover to Base Gasket	331598	1
18-0965	Adapter to Powerhead Gasket	333879	1
18-7418	O-Ring	326741	4
18-2074	Seal	0339620	1
18-2075	Seal	0353076	2
18-1222	Thermostat Gasket	394408	2
18-1221	Retainer	330273	2
18-1219	Grommet	320880	2
18-0412	Thermostat Gasket	337068	2

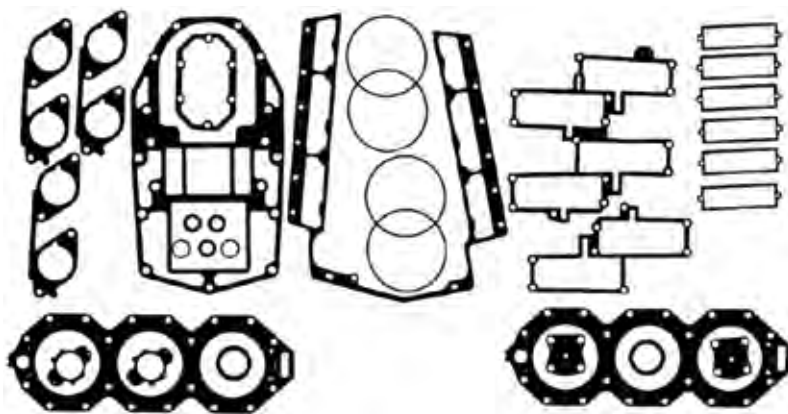

18-4323
POWERHEAD GASKET SET
Replaces: 436891

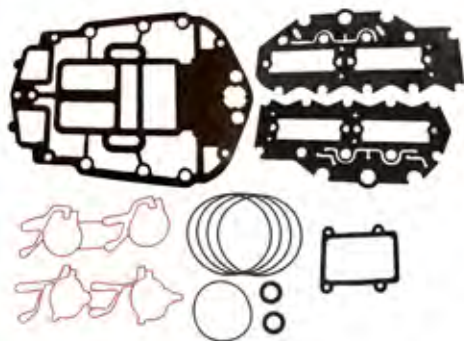

18-4402
POWERHEAD GASKET SET
Replaces: 437779, 439559
Fits: 90 V4 60 degree (1995-00), 115 V4 60 degree (1995-00)

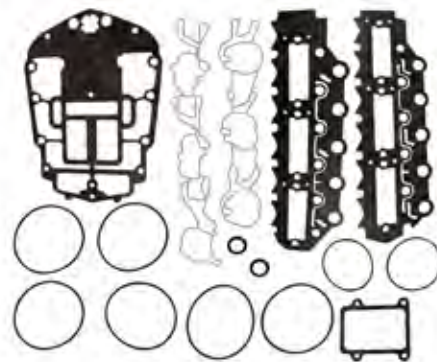

18-4406
POWERHEAD GASKET SET
Replaces: 437155
Fits: 150 60 degree (1991-00), 175 60 degree (1991-00)

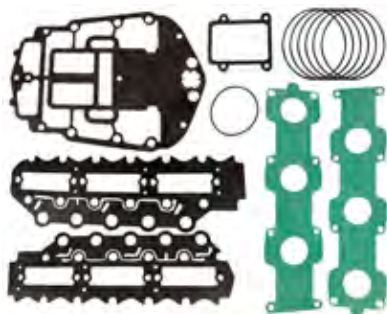

18-4420
POWERHEAD GASKET SET
Replaces: 439202
Fits: 150 Ficht FFI, 175 Ficht FFI

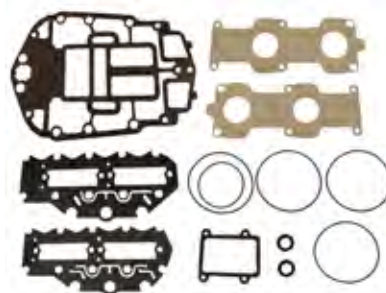

18-4421
POWERHEAD GASKET SET
Replaces: 5000400
Fits: 90 Ficht FFI, 115 Ficht FFI, 135 Ficht FFI

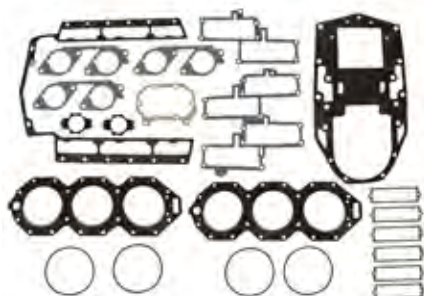

18-4428
POWERHEAD GASKET SET
Replaces: 437725
Fits: 200 BB (1993 & Up), 225 BB (1993 & Up), 225 Ficht FFI (1999 & Up), 250 Carb only (2000)

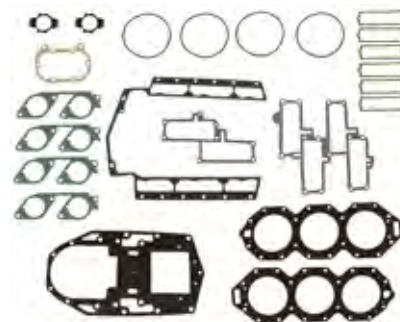

18-4429
POWERHEAD GASKET SET
Fits: 200 Ficht FFI (1999-01), 225 (2000-04), 250 (2000-04), 3.3L (2000-04)

PKG. OF 2



18-2884
18-2884-9^①
HEAD GASKET
 Replaces: 313782

PKG. OF 2



18-2885
18-2885-9^①
HEAD GASKET
 Replaces: 303438

PKG. OF 2



18-2888
18-2888-9^①
HEAD GASKET
 Replaces: 332010, 326953



18-2950
HEAD GASKET
 Replaces: 309612, 766870

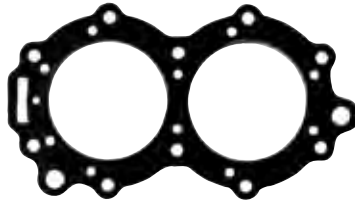

18-2951
HEAD GASKET
 Replaces: 304720



18-2952
HEAD GASKET
 Replaces: 203034

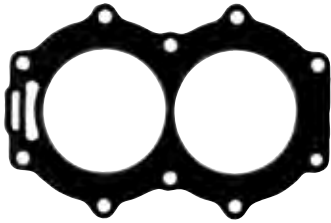

18-2954
HEAD GASKET
 Replaces: 319633



18-2956
HEAD GASKET
 Replaces: 318358



18-2957
HEAD GASKET
 Replaces: 307069



18-2958
HEAD GASKET
 Replaces: 315539



18-2959
HEAD GASKET
 Replaces: 306048

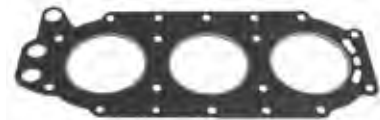

18-2960
HEAD GASKET
 Replaces: 313413



18-2961
HEAD GASKET
 Replaces: 329103

















18-2962
HEAD GASKET
 Replaces: 322332



18-2963
HEAD GASKET
 Replaces: 330818, 320533, 318914

^① Priced per Package

 <p>18-2964 HEAD GASKET Replaces: 320745, 335360, 766779</p>	 <p>18-3800 HEAD GASKET Replaces: 325273</p>	 <p>18-3801 HEAD GASKET Replaces: 325647, 335361</p>
 <p>18-3802 HEAD GASKET Replaces: 320658, 327795, 335359</p>	 <p>18-3803 HEAD GASKET Replaces: 324324, 329419, 765012 For: 2 cylinder models only</p>	 <p>18-3836 HEAD GASKET Replaces: 329836</p>
 <p>18-3837 HEAD GASKET Replaces: 328623</p>	 <p>18-3838 HEAD GASKET Replaces: 331211</p>	 <p>18-3839 HEAD GASKET Replaces: 333670, 334726</p>
 <p>18-3841-2 HEAD GASKET Replaces: 203130</p>	 <p>18-3898 HEAD GASKET Replaces: 332819</p>	 <p>18-3866 HEAD GASKET Replaces: 340115, 333549 For: V-4 Loop Charge</p>
 <p>18-3895 HEAD GASKET Replaces: 332816</p>	 <p>18-3896 HEAD GASKET Replaces: 332817</p>	 <p>18-0491 HEAD GASKET Replaces: 346007 Fits: 200 Ficht FFI (1999-01), 225 (2000-04), 250 (2000-04), 3.3L (2000-04)</p>
 <p>18-0492 HEAD GASKET Replaces: 340919, 345257 Fits: 200 BB (1993 & Up), 225 BB (1993 & Up), 225 Ficht FFI (1999 & Up) 250 Carb only (2000)</p>	<p>PKG. OF 12</p>  <p>18-7110 18-7110-9^① CYLINDER HEAD O-RING Replaces: 335523 3.960 O.D. x 0.103 H Fits: 90/115 HP (1995-98), 100 HP (1998), 105 HP (1997-98), 150/175 HP (1991-97) 90 Ficht FFI, 115 Ficht FFI, 135 Ficht FFI, 150 Ficht FFI, 175 Ficht FFI, 90 V4 60 degree(1995-00), 115 V4 60 degree (1995-00), 150 60 degree(1991-00), 175 60 degree(1991-00)</p>	

① Priced per Package

HEAD GASKET/GASKET SET APPLICATION

HP	Year	Head Gasket	Low Comp. Head Gasket	Gasket Set	HP	Year	Head Gasket	Low Comp. Head Gasket	Gasket Set
1.5	1968-70	18-2884	—	—	65 Comm.	1987-95	18-3836	—	18-4321
2, Colt, Jr.	1971-90	18-2884	—	—	65 Jet	1991-95	18-2956 ①	18-3898 ①	18-4303-1
2.5,3,4,4.5, Ultra, Excel 4	1981-93	18-2888	—	—	70	1974-76	18-2960	18-3895	18-4300 ⑨
3	1957-68	18-3841-2	—	—	70	1977-85	18-2960	18-3895	18-4302
4	1969-80	18-3841-2	—	—	70	1986-97	18-3836	—	18-4321
4	1969-80	18-3841-2	—	—	75	1960-65	18-2959 ①	—	—
4.5	1980	18-3841-2	—	—	75	1975	18-2960	18-3895	18-4300 ⑨
5	1965-68	18-2961	—	—	75	1977-88	18-2960	18-3895	18-4302
5	1984-95	18-3800	—	—	80	1966-67	18-2959 ①	—	—
5.5	1957-58	18-2885	—	—	80 Jet	1991-96	18-2956 ①	18-2956 ①	18-4303-1
5.5	1959-64	18-2961	—	—	85	1968-72	18-2959 ①	—	—
6	1965-79	18-2961	—	—	85	1979-80,91-95	18-2956 ①	18-3898 ①	18-4303-1
6	1984-95	18-3800	—	—	88	1987-95	18-2956 ①	18-3898 ①	18-4303-1
6.5 Comm.	1989-90	18-3800	—	—	90	1964-65	18-2959 ①	—	—
7.5	1957-58	18-2952	—	—	90	1981-95	18-2956 ①	18-3898 ①	18-4303-1
7.5	1980-93	18-3800	—	—	100	1966-72	18-2959 ①	—	—
8	1984-95	18-3800	—	—	100 ③	1979-95	18-2956 ①	18-3898 ①	18-4303-1
9.5	1964-73	18-2950	—	—	1600CC	1988	18-2956 ①	18-3898 ①	18-4303-1
9.9	1974-92	18-2963	—	18-4306 ②	110	1986-89	18-2956 ①	18-3898 ①	18-4303-1
10 Comm.	1989-90	18-2963	—	18-4306	115	1969-70	18-2959 ①	—	—
14	1988-90	18-2963	—	18-4306	115	1973-77	18-2956 ①	18-3898 ①	—
15	1974-92	18-2963	—	18-4306 ④	115	1978-95	18-2956 ①	18-3898 ①	18-4303-1
18	1959-73	18-2962	—	—	120	1985-87	18-3837 ①	—	18-4310
18 Jet	1995-98	18-3803	—	18-4307	120	1988-94	18-3866 ①	—	18-4322
20	1981-99	18-3803	—	18-4307	125 Comm.	1992-95	18-3866 ①	—	18-4322
25	1969-76	18-2962	—	—	130	1995-98	18-3866 ①	—	18-4322
25	1977-78	18-2954	—	—	135	1973-76	18-2956 ①	18-3898 ①	18-4301
25 ⑤	1979-03	18-3803	—	18-4307	140	1977	18-2956 ①	18-3898 ①	18-4301
28	1986-96	18-3803	—	18-4307	140	1978-84	18-2956 ①	18-3898 ①	18-4303-1
30 ⑤	1984-03	18-3803	—	18-4307	140	1985-87	18-3837 ①	—	18-4310
33	1965-70	18-2951	—	—	140	1988-94	18-3866 ①	—	18-4322
35	1957-58	18-2951	—	—	150	1973-91	18-2964 ①	18-3896 ①	18-4304-1
35	1976-78	18-2954	—	—	155 Comm.	1984-92	18-2964 ①	18-3896 ①	18-4304-1
35	1979-88	18-3803	—	18-4307	2500CC	1988	18-2964 ①	18-3896 ①	18-4304-1
35 ⑥	1987	18-3802	—	18-4305	175	1977-83	18-2964 ①	18-3896 ①	18-4304-1
40	1960-80	18-2957	—	—	175	1986-91	18-3801 ①	18-3897 ①	18-4309
40 Comm.	1981-90	18-2957	—	18-4324	185	1984-85	18-2964 ①	18-3896 ①	18-4304-1
40	1984-97	18-3802	—	18-4305	185	1990-93	18-3839 ①	—	18-4323
40 Comm.	1994-97	18-3802	—	18-4305	200	1976-83	18-2964 ①	18-3896 ①	18-4304-1
45 Comm.	1985-97	18-3802	—	18-4305	200	1986-87	18-3838 ①	—	—
45SS	1987-90	18-3802	—	—	200 ③	1988-93	18-3839 ①	—	18-4323
48	1987-97	18-3802	—	18-4305	225	1986-87	18-3838 ①	—	—
50	1958-59	—	—	—	225	1988-93	18-3839 ①	—	18-4323
50	1971-75	18-2958	—	18-4305 ⑦	235	1978-79	18-2964 ①	18-3896 ①	—
50	1979-80	18-3802	—	18-4318	235	1980-85	18-3801 ①	18-3897 ①	18-4309
50	1981-97	18-3802	—	18-4305	275/3.6L	1985-87	18-3840 ①	—	—
55	1968-69	18-2960	18-3895	—	OMC SEA DRIVE				
55	1977-79	18-3802	—	18-4318	HP	Year	Head Gasket	Low Comp. Head Gasket	Gasket Set
55	1980-97	18-3802	—	18-4305	1.6L	1983-90	18-2956	18-3898 ①	18-4303-1
55	1995	18-3802	—	—	1.8L	1987	18-3837	-	-
60	1970-71	18-2960	18-3895	—	2.0L	1988-90	18-3866 ①	-	18-4322
60	1980-85	18-3802	—	18-4305	2.5L	1982,84-85	18-2964	18-3896 ①	18-4304-1
60	1986-88	18-2960	18-3895	18-4302	2.6L	1982-86	18-3801 ①	18-3897 ①	-
60	1989-97	18-3836	—	18-4321	2.7L	1987	18-3838	-	-
SST60	1989-90	18-3836	—	—	3.0L	1988-90	18-3839	-	-
65	1968	—	—	—	3.6L	1987	18-3840	-	-
65	1972-73	18-2960	18-3895	18-4300 ⑨					
65 Comm.	1984-86	18-2960	—	18-4302					

① Two head gaskets required per engine
 ② 1976 G & H Suffix models only
 ③ Commercial models also

④ 1976 A Suffix models only
 ⑤ For 2 cylinder models only
 ⑥ D Suffix models only

⑦ 18-2958 Head Gasket required to complete set
 ⑨ Head Gasket Not Available in Gasket Set

STAINLESS STEEL BOLTS



HEX WASHER



HEX







HEAD STYLES





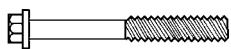
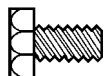
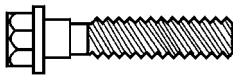

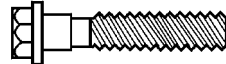



PAN







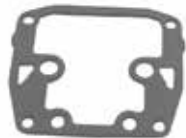



















FILLISTER

 <p>18-3133 Replaces: 331979 1/4" x 20 x 1 1/16" HEX For: Rewind starters, water pump housings, mid-sections and jet drive units</p>	<p>PKG. OF 2</p>  <p>18-3135 18-3135-9① Replaces: 306643 1/8" x 20 x 1/2" PAN HEAD For: Lower unit anodes, ignition covers and water pump housings</p>	<p>PKG. OF 2</p>  <p>18-3136 18-3136-9① Replaces: 323626 1/4" x 20 x 1 3/4" HEX WASHER For: Water pump housings, exhaust covers, intake manifolds, ignition coils and more</p>	 <p>18-3153 Replaces: 908158 1/4" x 20 x 1/2" HEX For: Lower unit anodes, bearing carriers, 45 HP and up and Cobra, 5 HP lower engine covers</p>
 <p>18-3365 Replaces: 909533 1/4" x 20 x 1" HEX WASHER For: Flywheel covers, intake covers and more</p>	 <p>18-3369 Replaces: 302325 1/4" x 20 x 1" HEX For: Impeller housings, ignition coils, exhaust covers, shift covers and starter brackets</p>	<p>PKG. OF 5</p>  <p>18-4276 18-4276-9① Replaces: 324334 1/4" x 20 x 1 1/32" HEX WASHER For: Water pump housings, exhaust covers, intake manifolds, ignition coils and more</p>	<p>PKG. OF 5</p>  <p>18-4277 Replaces: 324430 1/4" x 20 x 2" HEX For: Water pump housings, exhaust covers, intake manifolds, ignition coils and more</p>

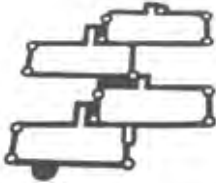
SEE PAGES 201-202 FOR OUR COMPLETE LINE OF GASKET SEALANTS

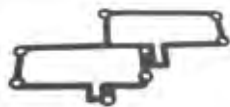















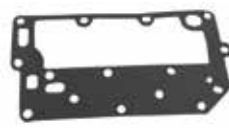
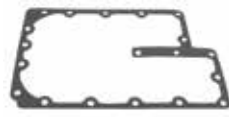
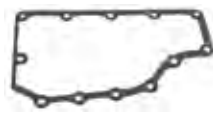

<p>PKG. OF 2</p>  <p>18-0118 18-0118-9① CARB GASKET Replaces: 325092</p>	<p>PKG. OF 2</p>  <p>18-0134 18-0134-9① V-4 & V-6 CARB TO MANIFOLD GASKET Replaces: 327707</p>	<p>PKG. OF 2</p>  <p>18-0961 18-0961-9① CARB MOUNTING GASKET Replaces: 318932</p>	 <p>18-0437 COVER GASKET Replaces: 334353</p>	 <p>18-0628 COVER GASKET Replaces: 341501</p>
 <p>18-1241 FLOAT BOWL AND NOZZLE GASKET</p>	 <p>18-2579 FLOAT BOWL GASKET Replaces: 338882</p>	 <p>18-2582 CARB BOWL GASKET Replaces: 338813</p>	 <p>18-8352 CARBURETOR MOUNTING GASKET Replaces: 332253</p>	<p>PKG. OF 2</p>  <p>18-2890 18-2890-9① FLOAT BOWL GASKET Replaces: 331203, 338886, 302994</p>
<p>PKG. OF 2</p>  <p>18-2893 18-2893-9① FLOAT BOWL GASKET Replaces: 303750</p>	<p>PKG. OF 2</p>  <p>18-2903 18-2903-9① FLOAT BOWL GASKET Replaces: 332696, 338880</p>	<p>PKG. OF 2</p>  <p>18-2906 18-2906-9① FLOAT BOWL GASKET Replaces: 333418, 333884, 338884 V-4, V-6</p>	<p>PKG. OF 2</p>  <p>18-2908 18-2908-9① FLOAT BOWL GASKET Replaces: 331499, 338878</p>	<p>PKG. OF 2</p>  <p>18-0850 18-0850-9① FUEL PUMP GASKET Replaces: 303615</p>

① Priced per package

<p>PKG. OF 2</p>  <p>18-2879 18-2879-9① FILTER CAP TO PUMP GASKET Replaces: 331363, 338876, 312634</p>	<p>PKG. OF 2</p>  <p>18-2900 18-2900-9① CAP TO FUEL PUMP GASKET Replaces: 332694, 338879, 312679</p>	<p>PKG. OF 2</p>  <p>18-2889 18-2889-9① FILTER BOWL GASKET Replaces: 302675</p>	<p>PKG. OF 2</p>  <p>18-2892 18-2892-9① FILTER BOWL GASKET Replaces: 303355</p>	 <p>18-0140 AIR BOX GASKET Replaces: 328604</p>
 <p>18-0157 AIR BOX GASKET Replaces: 330698</p>	 <p>18-0159 AIR BOX GASKET Replaces: 330909</p>	 <p>18-0933 AIR SILENCER GASKET Replaces: 314115 70/75 HP</p>	 <p>18-0935 BASE TO COVER GASKET Replaces: 314322 70/75 HP</p>	<p>PKG. OF 2</p>  <p>18-0975 18-0975-9① CARB TO SILENCER GASKET Replaces: 333008 3 Cyl.</p>
 <p>18-0978 COVER TO BASE GASKET Replaces: 331598 For: 185, 200 & 225 H.P., V-6</p>	 <p>18-0979 AIR SILENCER GASKET Replaces: 321183 V-6</p>	<p>PKG. OF 2</p>  <p>18-0983 18-0983-9① CARB TO AIR BOX TWIN GASKET Replaces: 321497</p>	 <p>18-0985 AIR SILENCER GASKET Replaces: 321722 V-4</p>	 <p>18-0989 AIR SILENCER GASKET Replaces: 321794 3 Cyl.</p>
<p>PKG. OF 2</p>  <p>18-2857 18-2857-9① AIR SILENCER GASKET Replaces: 386573, 319771</p>	<p>PKG. OF 2</p>  <p>18-0122 18-0122-9① 9.9 & 15 HP OUTER LEAFPLATE GASKET Replaces: 325260</p>	<p>PKG. OF 2</p>  <p>18-0130 18-0130-9① REED BLOCK GASKET Replaces: 332266 For: V-4, V-6 & V-8</p>	 <p>18-0142 INTAKE MANIFOLD GASKET Replaces: 328622</p>	<p>PKG. OF 2</p>  <p>18-0144 18-0144-9① REED BLOCK GASKET Replaces: 328626 For: 120-140 H.P V-4</p>
 <p>18-0148 INTAKE MANIFOLD GASKET Replaces: 329718 V-6</p>	 <p>18-0161 LOWER MANIFOLD GASKET Replaces: 331532 For: V-6</p>	 <p>18-0951 CARB TO MANIFOLD GASKET Replaces: 317305 3 Cyl.</p>	<p>PKG. OF 2</p>  <p>18-0959 18-0959-9① INNER LEAF PLATE GASKET Replaces: 318924 9.9 & 15 HP</p>	<p>PKG. OF 2</p>  <p>18-0963 18-0963-9① INTAKE MANIFOLD TWIN GASKET Replaces: 335633</p>



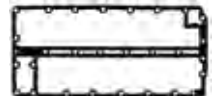
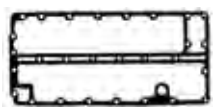

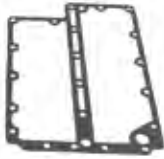
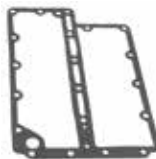
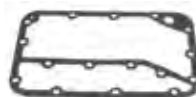









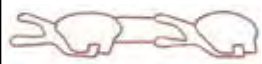







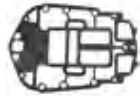



SEE PAGES 201-202 FOR OUR COMPLETE LINE OF GASKET SEALANTS

① Priced per package

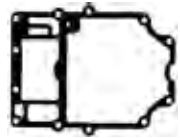
<p>PKG. OF 2</p>  <p>18-0981 18-0981-9① LEAF PLATE GASKET Replaces: 321479 25 & 35 HP</p>	<p>PKG. OF 2</p>  <p>18-0987 18-0987-9① THROTTLE BODY TO MANIFOLD GASKET Replaces: 332319</p>	<p>PKG. OF 2</p>  <p>18-0991 18-0991-9① LEAF PLATE GASKET Replaces: 321907 V-4/V-6</p>	<p>PKG. OF 2</p>  <p>18-0973 18-0973-9① CARB GASKET Replaces: 315052 V-4 Carburetor mounting includes: 100, 115, 125, 135, 140, 150, 175, 200, 235(1977-79), 85 (1969-79)</p>	 <p>18-1212 INTAKE MANIFOLD GASKET Replaces: 326926 For: 3 cyl.</p>
<p>PKG. OF 2</p>  <p>18-2862 18-2862-9① LEAF PLATE GASKET Replaces: 321573, 326260 25/35 HP</p>	<p>PKG. OF 2</p>  <p>18-2867 18-2867-9① MANIFOLD TO CRANKCASE GASKET Replaces: 319174 For: V-4</p>	 <p>18-0102 EXHAUST MANIFOLD GASKET Replaces: 323469 V-4</p>	<p>PKG. OF 2</p>  <p>18-0106 18-0106-9① EXHAUST MANIFOLD GASKET Replaces: 324323 25/35</p>	 <p>18-0117 EXHAUST PLATE GASKET Replaces: 317955 V-4</p>
 <p>18-0120 EXHAUST PLATE GASKET Replaces: 325211</p>	<p>PKG. OF 2</p>  <p>18-0126 18-0126-9① INNER EXHAUST COVER GASKET Replaces: 326264</p>	 <p>18-0927 INNER EXHAUST COVER GASKET 235 HP Replaces: 393561</p>	<p>PKG. OF 2</p>  <p>18-0999-9① INNER EXHAUST GASKET Replaces: 323459 V-4</p>	 <p>18-0945 OUTER EXHAUST GASKET Replaces: 336430, 323217</p>
 <p>18-0955 EXHAUST COVER GASKET Replaces: 318156 V-4</p>	 <p>18-1207 EXHAUST MANIFOLD GASKET Replaces: 329833, 343863</p>	 <p>18-1218 EXHAUST COVER GASKET Replaces: 315868</p>	 <p>18-1224 EXHAUST COVER GASKET Replaces: 315869</p>	<p>PKG. OF 2</p>  <p>18-2545 18-2545-9① EXHAUST PLATE GASKET Replaces: 321182 V-6</p>
<p>PKG. OF 2</p>  <p>18-2549 18-2549-9① EXHAUST COVER GASKET Replaces: 321435 V-6</p>	<p>PKG. OF 2</p>  <p>18-2853 18-2853-9① EXHAUST COVER GASKET Replaces: 318925 9.9/15 HP</p>	<p>PKG. OF 2</p>  <p>18-2866 18-2866-9① EXHAUST COVER GASKET Replaces: 317914 V-4</p>	<p>PKG. OF 2</p>  <p>18-2870 18-2870-9① EXHAUST COVER GASKET Replaces: 305176</p>	<p>PKG. OF 2</p>  <p>18-2871 18-2871-9① EXHAUST COVER GASKET Replaces: 304762</p>

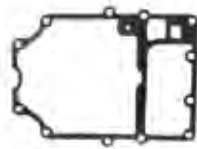



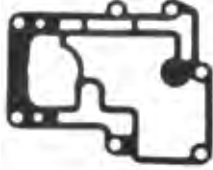
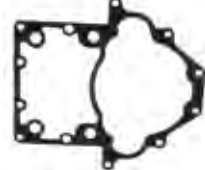



















SEE PAGES 201-202 FOR OUR COMPLETE LINE OF GASKET SEALANTS

① Priced per package

<p>PKG. OF 2</p>  <p>18-2886 18-2886-9① COVER PLATE GASKET Replaces: 203171</p>	<p>PKG. OF 2</p>  <p>18-2913 18-2913-9① EXHAUST COVER GASKET Replaces: 331916, 319097 3 Cyl.</p>	<p>PKG. OF 2</p>  <p>18-2938 18-2938-9① EXHAUST COVER GASKET Replaces: 331917 3 Cyl.</p>	 <p>18-1283 MOLDED INTAKE PORT GASKET Replaces: 335818 For: V6 60° Eagle series 90-115HP (1995-00)</p>	 <p>18-1284 MOLDED INTAKE PORT GASKET Replaces: 335819 For: V6 60° Eagle series 90-115HP (1995-00)</p>
 <p>18-1285 MOLDED INTAKE PORT GASKET Replaces: 335403 For: V6 60° Eagle series 150-175HP (1991-00)</p>	 <p>18-0112 POWERHEAD BASE GASKET Replaces: 324717 9.9 & 15 HP</p>	 <p>18-0128 POWERHEAD BASE GASKET Replaces: 326468, 351018</p>	 <p>18-0136 POWERHEAD BASE GASKET Replaces: 328283</p>	 <p>18-0138 POWERHEAD BASE GASKET Replaces: 328590</p>
 <p>18-0690 BASE GASKET Replaces: 347205 Fits: 200 BB (1993 & Up), 200 Ficht FFI (1999-01), 225 BB (1993 & Up), 225 Ficht FFI (1999 & Up), 225 (2000-04), 250 Carb only (2000), 250 (2000-04), 3.3L (2000-04)</p>	 <p>18-0691 BASE GASKET Fits: 150 Ficht FFI , 175 Ficht FFI</p>	 <p>18-0692 BASE GASKET Replaces: 339601 Fits: 90 V4 60 degree (1995-00), 90 Ficht FFI, 1150V4 60 degree (1995-00), 115 Ficht FFI, 135 Ficht FFI, 150 60 degree (1991-00), 175 60 degree (1991-00)</p>	 <p>18-0693 INTAKE GASKET Replaces: 336227 Fits: 135(2005-06), 150(1991-98), 150(1991-06), 175(1991-06)</p>	 <p>18-0694 INTAKE GASKET Replaces: 336226 Fits: 135(2005-06), 150(1991-05), 175(1991-05)</p>
 <p>18-0695 INTAKE GASKET Replaces: 336389 Fits: 90(1995-06), 115(1995-06), 100(1998-01, 2005)</p>	 <p>18-0696 INTAKE GASKET Replaces: 336388 Fits: 90(1995-06), 100(1998-01, 2005), 115(1995-06)</p>	 <p>18-0957 POWERHEAD BASE GASKET Replaces: 318373</p>	 <p>18-0965 ADAPTER OUTER POWERHEAD GASKET Replaces: 333879</p>	 <p>18-0995 POWERHEAD BASE GASKET Replaces: 323222 V-6</p>
<p>PKG. OF 2</p>  <p>18-1205 18-1205-9① ADAPTER COVER GASKET Replaces: 329828</p>	<p>PKG. OF 2</p>  <p>18-2550 18-2550-9① POWERHEAD BASE GASKET Replaces: 323214 V-6</p>	<p>PKG. OF 2</p>  <p>18-2852 18-2852-9① POWERHEAD BASE GASKET Replaces: 330621 25/35 HP</p>	<p>PKG. OF 2</p>  <p>18-2864 18-2864-9① POWERHEAD BASE GASKET Replaces: 321727 V-4</p>	<p>PKG. OF 2</p>  <p>18-2865 18-2865-9① POWERHEAD BASE GASKET Replaces: 313763 3 Cyl.</p>
<p>PKG. OF 2</p>  <p>18-2868 18-2868-9① POWERHEAD BASE GASKET Replaces: 310137 35/40 HP</p>	<p>PKG. OF 2</p>  <p>18-2877 18-2877-9① BAFFLE GASKET Replaces: 314421 18/25 HP</p>	<p>PKG. OF 2</p>  <p>18-2878 18-2878-9① BAFFLE GASKET Replaces: 319710 25/35</p>	<p>PKG. OF 2</p>  <p>18-2894 18-2894-9① EXHAUST HOUSING GASKET Replaces: 304314</p>	<p>PKG. OF 2</p>  <p>18-2898 18-2898-9① POWERHEAD BASE GASKET Replaces: 309956 V-4</p>











SEE PAGES 201-202 FOR OUR COMPLETE LINE OF GASKET SEALANTS

① Priced per package

<p>PKG. OF 2</p>  <p>18-2901 18-2901-9① EXHAUST HOUSING GASKET Replaces: 313065, 306205 5, 5.5, 6 HP</p>	<p>PKG. OF 2</p>  <p>18-2904 18-2904-9① EXHAUST PLATE GASKET Replaces: 319348 28, 33, 40 HP</p>	<p>PKG. OF 2</p>  <p>18-2907 18-2907-9① EXHAUST HOUSING GASKET Replaces: 325721</p>	<p>PKG. OF 2</p>  <p>18-0967 18-0967-9① BYPASS COVER GASKET Replaces: 319332 9.9 & 15 HP</p>	<p>PKG. OF 2</p>  <p>18-0971 BYPASS GASKET Replaces: 319661 25 & 35 HP</p>
<p>PKG. OF 2</p>  <p>18-2876 18-2876-9① BYPASS COVER GASKET Replaces: 307133</p>	<p>PKG. OF 2</p>  <p>18-0941 WATER JACKET GASKET Replaces: 315538 50/55 HP</p>	<p>PKG. OF 2</p>  <p>18-2543 18-2543-9① WATER JACKET GASKET Replaces: 318609 3 Cyl.</p>	<p>PKG. OF 2</p>  <p>18-0892 DEFLECTOR HOSE Replaces: 322411</p>	<p>PKG. OF 2</p>  <p>18-2544 18-2544-9① WATER JACKET GASKET Replaces: 321028 V-6</p>
<p>PKG. OF 2</p>  <p>18-2856 18-2856-9① WATER JACKET GASKET Replaces: 319665 25/35 HP</p>	<p>PKG. OF 2</p>  <p>18-3899 WATER COVER GASKET Replaces: 327674 For: 20, 25, 25C, 30, 35</p>	<p>PKG. OF 2</p>  <p>18-2872 18-2872-9① WATER JACKET GASKET Replaces: 307257, 318334 V-4</p>	<p>PKG. OF 2</p>  <p>18-2873 18-2873-9① WATER JACKET GASKET Replaces: 318335 V-4</p>	<p>PKG. OF 2</p>  <p>18-2905 18-2905-9① WATER COVER GASKET Replaces: 329920 9.9, 15 HP</p>
<p>PKG. OF 2</p>  <p>18-3360 IMPELLER HOUSING GASKET Replaces: 329390 20-25 HP</p>	<p>PKG. OF 2</p>  <p>18-0182 18-0182-9① THERMOSTAT GASKET Replaces: 310058</p>	<p>PKG. OF 2</p>  <p>18-0397 THERMOSTAT GASKET Replaces: 318917</p>	<p>PKG. OF 2</p>  <p>18-0412 18-0412-9① THERMOSTAT GASKET Replaces: 337068</p>	<p>PKG. OF 2</p>  <p>18-0441 18-0441-9① THERMOSTAT GASKET Replaces: 329076</p>
<p>PKG. OF 2</p>  <p>18-0929 18-0929-9① THERMOSTAT GASKET Replaces: 313416 3 Cyl.</p>	<p>PKG. OF 2</p>  <p>18-0675 THERMOSTAT GASKET Replaces: 321932 V-4</p>	<p>PKG. OF 2</p>  <p>18-0977 18-0977-9① THERMOSTAT GASKET Replaces: 332369 V-4</p>	<p>PKG. OF 2</p>  <p>18-1202 18-1202-9① THERMOSTAT GASKET Replaces: 329830</p>	<p>PKG. OF 2</p>  <p>18-1222 THERMOSTAT GASKET Replaces: 394408</p>

























SEE PAGES 201-202 FOR OUR COMPLETE LINE OF GASKET SEALANTS

① Priced per package

<p>PKG. OF 2</p>  <p>18-2547 18-2547-9① WATER PASSAGE GASKET Replaces: 322858 V-4/V-6</p>	<p>PKG. OF 2</p>  <p>18-2548 18-2548-9① THERMOSTAT GASKET Replaces: 332108 3 Cyl.</p>	<p>PKG. OF 2</p>  <p>18-2546 18-2546-9① THERMOSTAT GASKET Replaces: 321184 V-6</p>	<p>PKG. OF 2</p>  <p>18-0124 18-0124-9① IMPELLER PLATE GASKET Replaces: 325537</p>	<p>PKG. OF 2</p>  <p>18-0445 18-0445-9① WATER PUMP GASKET Replaces: 323312 35HP</p>
 <p>18-0446 WATER PUMP GASKET Replaces: 323311 35HP</p>	<p>PKG. OF 2</p>  <p>18-0969 18-0969-9① IMPELLER HOUSING GASKET Replaces: 319586</p>	<p>PKG. OF 5</p>  <p>18-2536 18-2536-9① IMPELLER HOUSING SEAL Replaces: 321120 V-4, V-6</p>	<p>PKG. OF 5</p>  <p>18-2539 18-2539-9① RUBBER SEAL Replaces: 328753</p>	<p>PKG. OF 2</p>  <p>18-2557 18-2557-9① IMPELLER GASKET Replaces: 324701, 338484 V-4, V-6, V-8</p>
<p>PKG. OF 2</p>  <p>18-2709 18-2709-9① WEAR PLATE GASKET Replaces: 336530</p>	<p>PKG. OF 2</p>  <p>18-0679 THERMOSTAT GASKET Replaces: 311145</p>	<p>PKG. OF 2</p>  <p>18-7428 18-7428-9① O-RING Replaces: 307103</p>	<p>PKG. OF 2</p>  <p>18-7481 18-7481-9① O-RING Replaces: 324981</p>	<p>PKG. OF 2</p>  <p>18-0155 18-0155-9① RECTIFIER MOUNTING GASKET Replaces: 330412</p>
<p>PKG. OF 2</p>  <p>18-0851 18-0851-9① RELIEF GASKET Replaces: 329826</p>	<p>PKG. OF 2</p>  <p>18-0953 18-0953-9① WATER PASSAGE GASKET Replaces: 317951 V-4/V-6</p>	<p>PKG. OF 2</p>  <p>18-0110 18-0110-9① SHIFT HOUSING GASKET Replaces: 324670</p>	 <p>18-0313 SHIFT ROD GASKET Replaces: 352165 For: E-Tec 75/90/115/150/ 175/200/225/250 HP</p>	<p>PKG. OF 2</p>  <p>18-0882 18-0882-9① SHIFT ROD GASKET Replaces: 304764</p>
<p>PKG. OF 2</p>  <p>18-2855 18-2855-9① SHIFT HOUSING GASKET Replaces: 314082</p>	<p>PKG. OF 2</p>  <p>18-2874 18-2874-9① SOLENOID COVER GASKET Replaces: 314876 V-4</p>	<p>PKG. OF 2</p>  <p>18-2880 18-2880-9① COVER PLATE GASKET Replaces: 304023</p>	<p>PKG. OF 2</p>  <p>18-0108 18-0108-9① LOWER GEAR CASE GASKET Replaces: 324449</p>	

SEE PAGES 201-202 FOR OUR COMPLETE LINE OF GASKET SEALANTS

① Priced per package

 <p>18-0540 EXHAUST LEG RUBBER SEAL Replaces: 320936</p>	<p>PKG. OF 2</p>  <p>18-0949 18-0949-9① TRUNION CAP GASKET Replaces: 316499</p>	 <p>18-2537 EXHAUST SEAL LEG Replaces: 324937</p>	<p>PKG. OF 2</p>  <p>18-2869 18-2869-9① EXHAUST HOUSING GASKET Replaces: 305312</p>	<p>PKG. OF 2</p>  <p>18-2891 18-2891-9① BEARING HOUSING GASKET Replaces: 303339 6HP</p>
 <p>18-8353 OIL SEAL Replaces: 320961</p>	 <p>18-1219 GROMMET Replaces: 320880</p>	 <p>18-2389 GROMMET Replaces: 314832</p>	 <p>18-2391 GROMMET Replaces: 321692</p>	 <p>18-2392 GROMMET Replaces: 327035</p>
<p>PKG. OF 2</p>  <p>18-2703 18-2703-9① GROMMET Replaces: 314008</p>	 <p>18-2704 GROMMET Replaces: 320943</p>	<p>PKG. OF 2</p>  <p>18-2706 18-2706-9① GROMMET Replaces: 321008</p>	<p>PKG. OF 2</p>  <p>18-2708 18-2708-9① GROMMET Replaces: 333758</p>	 <p>18-3329 GROMMET Replaces: 302497 9.9-35 HP</p>
 <p>18-3332 GROMMET Replaces: 304026</p>	 <p>18-3337 GROMMET Replaces: 315837 40-50 HP</p>	<p>PKG. OF 2</p>  <p>18-1221 18-1221-9① RETAINER GASKET Replaces: 330273</p>	 <p>18-2532 GEARCASE COVER SEAL Replaces: 305762 2 Cyl.</p>	 <p>18-2534 SEAL 40" Replaces: 309044 Material equivalent to that of O.E. spool # 309044 0.1005 O.D.</p>
 <p>18-7963 O-RING Replaces: 331353</p>	<p>PKG. OF 2</p>  <p>18-2705 18-2705-9① OIL SEAL Replaces: 315748</p>	<p>PKG. OF 2</p>  <p>18-2769 18-2769-9① RUBBER SEAL Replaces: 332000</p>	<p>PKG. OF 2</p>  <p>18-0917 TILT MOTOR GASKET Replaces: 311508</p>	 <p>18-8372 MOLDED SEAL Replaces: 323582 For: 5 & 7.5 HP (1978-83) Outboards</p>

SEE PAGES 201-202 FOR OUR COMPLETE LINE OF GASKET SEALANTS

① Priced per package

PKG. OF 2



18-2881
18-2881-9^④
HOUSING TO TANK GASKET
 Replaces: 332403, 125530
 For: 6 Gallon Fuel Tank

PKG. OF 2



18-2887
18-2887-9^④
FUEL TANK GASKET
 Replaces: 302557



18-1704
SCREW
 Replaces: 331980
 For: Waterpumps, power packs (1985-96)



18-4904
STARTER HANDLE & ROPE
 (Uses 9/64" Rope)
 Handle Only: **18-4901**

STARTER ROPE



18-4911
 5/32" x 200'
 Replaces: 322236, 772577

18-4913
 3/16" x 200'
 Replaces: 316705, 772578

18-4914
 1/8" x 200'
 Replaces: 316706, 772579



18-1505
STARTER GEAR
 Replaces: 318940
 For: 9.9 - 15HP
 (1974-1992)



18-6501
REWIND SPRING
 Replaces: 395460, 307573



18-6503
REWIND SPRING
 Replaces: 318944



18-6509
REWIND SPRING
 Replaces: 326877



18-6511
REWIND SPRING
 Replaces: 312932



18-6522
REWIND SPRING
 Replaces: 323653, 338534

H.P.	YEARS	REWIND SPRING	H.P.	YEARS	REWIND SPRING	H.P.	YEARS	REWIND SPRING	H.P.	YEARS	REWIND SPRING
2	1969-80	18-6511	4.5	1980-90	18-6511	10	1950-63	18-6501	18	1968-73	18-6501
3	1954-68	18-6501	5.5	1954-68	18-6501	12	1980-92	18-6522	20	1956-73,	18-6501
4 ^①	1969-92	18-6511	7.5	1954-68	18-6501	12	1956-68	18-6501	85-97		
4 ^②	1969-80	18-6511	9.9	1980-92	18-6522	15	1979-92	18-6522	28	1969-92	18-6501
4 ^③	1981-92	18-6509	9.9	1974-78	18-6503	15	1956-68	18-6501	25	1969-05	18-6501
			10	1980-92	18-6522	15	1974-78	18-6503	30	1984-05	18-6501
			^③	All 4D					35	1976-94	18-6501

^① 1992 4D Models only
^② Except 4D
^③ All 4D

PKG. OF 3



18-6513
18-6513-9^④
STARTER PAWL
 Replaces: 203698

PKG. OF 2



18-6512
18-6512-9^④
STARTER PAWL
 Replaces: 330525

HP	Years	Pawl	HP	Years	Pawl	HP	Years	Pawl
2	1971-88	18-6513	18	1957-73	18-6513	30	1984-90	18-6512
Jr/Colt	1990	18-6513	20	1981-90	18-6512	35	1976-77	18-6513
3	1957-67	18-6513	25	1969-76	18-6513	35	1978-90	18-6512
4	1978-90	18-6513	25	1977	18-6513	45	1958-59	18-6513
5.5	1957-64	18-6513	25	1978-90	18-6512	50	1958-89	18-6513
7.5	1957-76	18-6513	25C	1982-90	18-6512	60	1964-66	18-6513
10	1957-62	18-6513	30	1957-61	18-6512	75	1960-65	18-6513
						80	1966	18-6513

SEE PAGES 201-202 FOR OUR COMPLETE LINE OF GASKET SEALANTS

^④ Priced per package

ALWAYS GET A PERFECT FIT



ALL SIERRA MANIFOLDS:

- Manufactured as a direct OE replacement and are fully interchangeable with the OEM products they are designed to replace.
- Includes all the necessary gaskets and hardware for easy, out-of-the-box installation.
- Revised gasket material for more compressibility and better sealing properties.
- All manifolds are primed and painted for added durability, protection. Components are ready to install out-of-the box.
- Packaged for maximum protection during shipping and handling.
- Backed by Sierra's Comprehensive Warranty.

The Very Best Parts of Boating
www.sierramarine.com

Sierra
Marine Engine and Drive Parts

- 78 — Gear Housing Seal Kit 18-2658
- 77 — Water Pump Repair Kit W/ HOUSING 18-3382

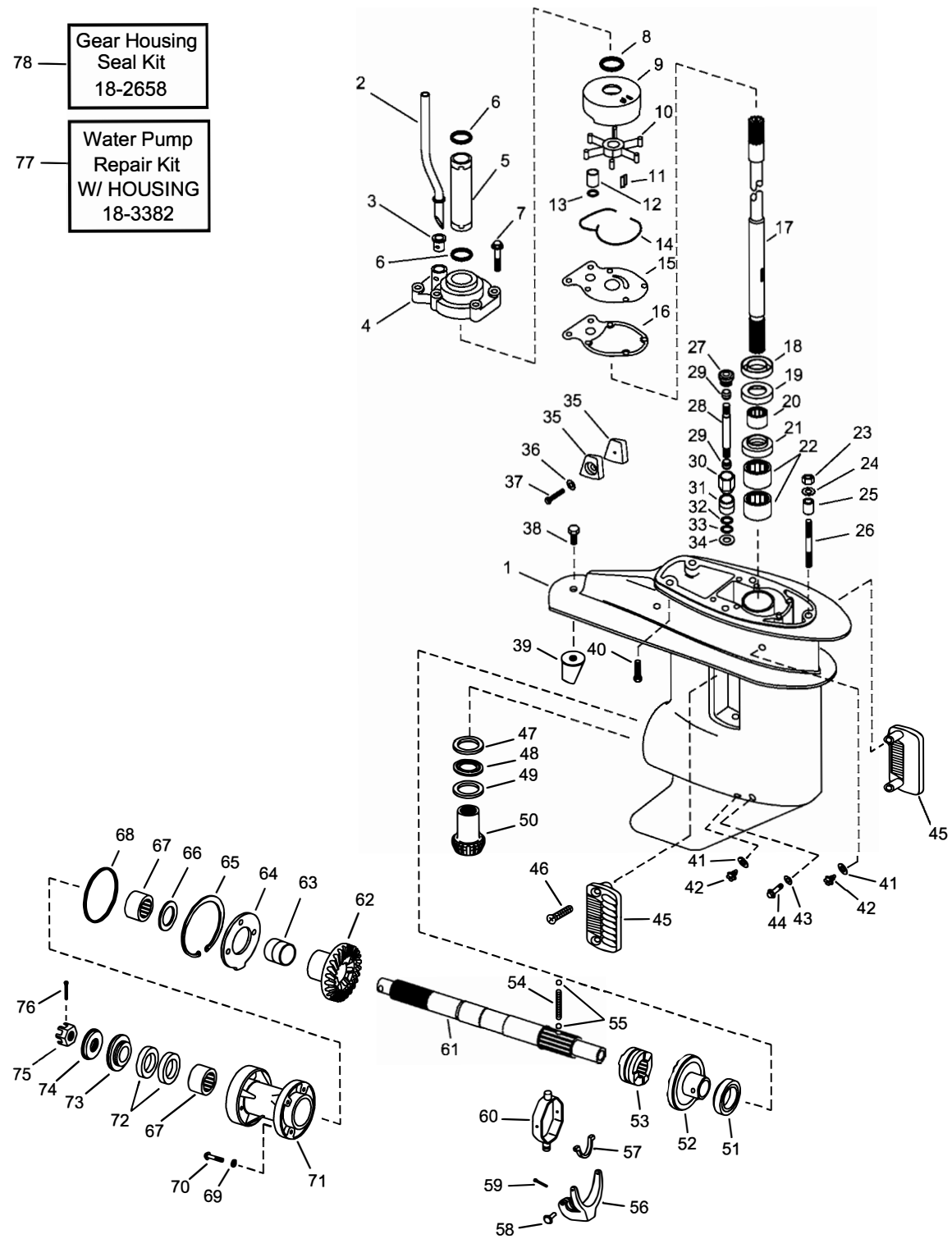

Complete Gear Housings Listed on Page 328

Figure #	Description	Part #	O.E.M. #	Qty.	Figure #	Description	Part #	O.E.M. #	Qty.
1	Gear Housing	—	434030	1	46	Screw, Screen Retaining	—	325539	2
2	Tube Water	—	395339	1	47	Washer, Thrust	—	327716	1
3	Grommet	18-3329	302497	1	48	Bearing, Thrust	—	388027	1
4	Housing, Water Pump	18-3367	393632	1	49	Washer, Thrust	—	330441	1
5	Tube, Extension	—	326692	1	50	Gear, Pinion	18-1288	328313	1
6	O-Ring	18-7105	311338	2	51	Bearing, Forward Gear	—	386186	1
7	Bolt, Water Pump Housing	—	328725	6	52	Gear, Forward	18-1287	392475	1
8	O-Ring	18-7146	554545	1	53	Clutch Sliding	18-1290	337020	1
9	Insert, Water Pump Housing	18-3358	328751	1	54	Spring, Detent	—	327070	1
10	Impeller	18-3051	395289	1	55	Ball, Detent	18-2243	316506	2
11	Key, Water Pump	18-3295	344470	1	56	Lever Shifter	—	337019	1
12	Bushing	—	328754	1	57	Cradle, Sliding Clutch	—	438311	1
13	O-Ring	18-7100	301877	1	58	Pin, Shift	—	302504	1
14	Seal, Rubber	18-2539	328753	1	59	Cotterpin, Shift Lever	—	303049	1
15	Plate, Wear	18-3359	328753	1	60	Yoke & Connector Assy.	—	390023	1
16	Gasket, Water Pump	18-0124	325537	1	61	Shaft, Propeller	—	439143	1
17	Drive Shaft (15")	—	341635	1	62	Gear, Reverse	18-1289	327655	1
	Drive Shaft (20")	—	341636	1	63	Bushing, Reverse Gear	—	319635	1
18	Seal Drive Shaft (upper)	18-2065	332261	1	64	Plate, Retainer	—	319746	1
19	Seal Drive Shaft (lower)	18-2033	321938	1	65	Ring, Retaining	—	319747	1
20	Bearing, Driveshaft	—	386473	1	66	Washer, Forward Gear Thrust	—	319684	1
21	Collar, Housing	—	322018	1	67	Bearing, Propshaft	—	437288	2
22	Bearing, Pinion	—	437288	2	68	O-Ring	18-7108	338518	1
23	Nut, Housing	—	306422	1	69	Seal	18-7475	332584	2
24	Washer, Locking	—	301250	1	70	Bolt, Carrier Retaining	—	319743	2
25	Bushing, Housing Alignment	—	319785	1	71	Carrier, Bearing	—	433428	1
26	Stud	—	320173	1	72	Seal, Propshaft	18-2026	321453	2
27	Connector, Shift	—	325624	1	73	Spacer, Prop	18-4229	319890	1
28	Shift Rod	—	331479	1	74	Spacer, Prop	18-4232	323943	1
29	Keeper, Nylon Shift	—	325625	2	75	Prop Nut	18-3707	319891	1
30	Nut, Shiftshaft Retaining	—	331465	1	76	Cotter Pin, Prop Nut	18-3743	320785	1
31	Bushing	—	326361	1	77	Water Pump Kit	18-3382	393639	1
32	O-Ring	18-7180	303347	1	78	Gear Housing Seal Kit	18-2658	396351	1
33	O-Ring	18-7100	301877	1					
34	Washer, Expanding	18-0189	321738	1					
35	Anode Kit	—	434029	1					
36	Lockwasher	—	304454	1					
37	Bolt, Anode Retaining	—	333677	1					
38	Bolt, Trim Tab Retaining	—	329217	1					
39	Trim Tab	—	336203	1					
40	Bolt, Housing Retaining	—	328333	4					
41	Gasket, Drain Plug	18-4248	311598	2					
42	Plug, Drain	18-2387	307551	2					
43	Seal	18-7475	332584	1					
44	Pin, Shift Lever Pivot	—	308376	1					
45	Screen, Water Inlet	—	336202, 336206	2					

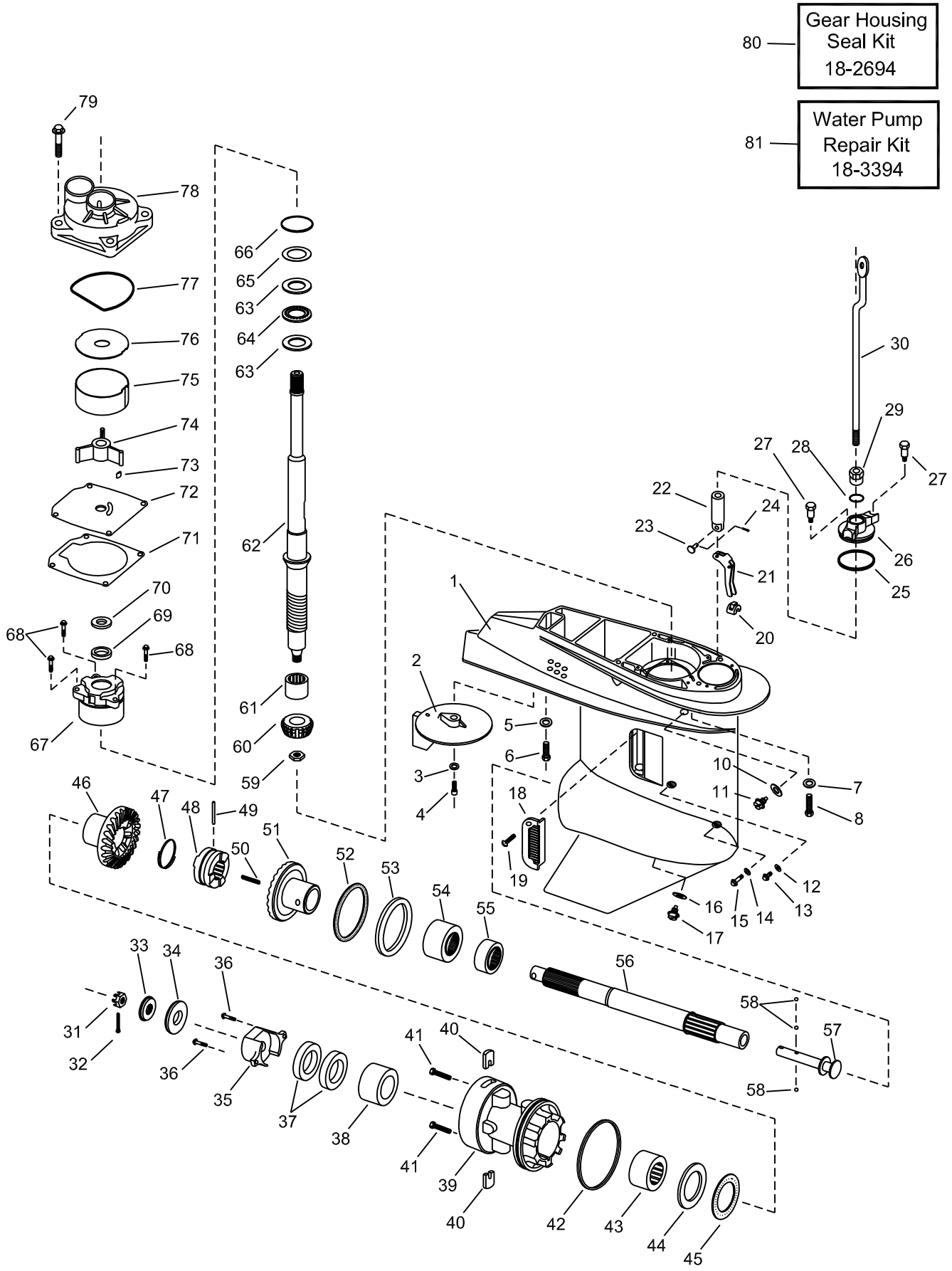

Complete Gear Housings Listed on Page 328

Figure #	Description	Part #	O.E.M. #	Qty.	Figure #	Description	Part #	O.E.M. #	Qty.
1	Housing, Gearcase	—	435275	1	47	Spring Clutch	18-2398	320311	1
2	Trim Tab	—	340539	1	48	Clutch Sliding	18-2308	332491	1
3	Washer, Anode	—	330266	1	49	Pin, Clutch Cross	—	320310	1
4	Bolt, Anode Retaining	—	330930	1	50	Spring Shifter	—	332484	1
5	Washer	—	330265	1	51	Gear Set, Forward & Pinion	18-2310	397627	1
6	Bolt	—	313697	1	52	Thrust Bearing, Forward Gear	18-1364	397538	1
7	Washer	—	330266	4	53	Thrust Washer, Forward Gear	18-0197	333725	1
8	Bolt	—	305282	4	54	Bearing Forward, Outer	18-1351	382407	1
10	O-Ring	18-4253-9	336982	1	55	Thrust Bearing, Forward Gear	18-1369	432264	1
11	Drain Plug, Upper	18-1236	309243	1	56	Propeller Shaft	18-2288	439138	1
12	Seal	18-7475	332584	1	57	Shaft, Shift Dog	—	332503	1
13	Retaining Screw	—	324852	1	58	Ball, Detent	18-2243	316506	3
14	O-Ring Screw	18-7109	317178	1	59	Nut, Pinion	—	313339	1
15	Screw, Shift Lever	—	333770	1	60	Gear Set, Forward & Pinion	18-2310	397627	1
16	Gasket, Drain Plug	18-4248	311598	1	61	Bearing Pinion	18-1356	382343	1
17	Drain Fill Plug, Lower	18-2378	318544	1	62	Driveshaft (std)	—	433066	1
18	Screen, Water Intake	—	332494	2		Driveshaft (long)	18-1721	433067	1
19	Bolt, Inlet Screen Retainer	—	325539	2	63	Washer, Thrust	18-0201	333771	2
20	Cradle, Shifter	—	332507	1	64	Thrust Bearing, Driveshaft	18-1368	398901	1
21	Lever, Shift	—	332492	1	65	Shim (.003)	—	313273	AR
22	Connector, Shift Rod	—	332508	1		Shim (.004)	—	313274	AR
23	Pin, Connector	—	302504	1		Shim (.005)	—	313275	AR
24	Cotter Pin	—	306376	1		Shim (.006)	—	313276	AR
25	O-Ring, Shift Rod Cover	—	338522	1		Shim (.007)	—	313277	AR
26	Cover, Shift Rod	18-1729	434588	1	66	O-Ring, Gear Housing	18-7173	310327	1
27	Bolt, Shift Rod Cover	—	316037	2	67	Cap, Upper Driveshaft, Retaining	—	435274	1
28	O-Ring, Shift Rod	18-7137	318372	1	68	Bolt, Driveshaft Retaining	—	317624	3
29	Bushing, Shift Rod	—	333780	1	69	Seal Lower	18-2059	321466	1
30	Shift Rod (std.)	—	332509	1	70	Seal Upper	18-2064	332205	1
	Shift Rod (long)	—	332510	1	71	Gasket, Impeller	18-2709	336530	1
31	Nut, Prop	18-3705	314503	1	72	Plate, Impeller	NSS	341038	1
32	Pin, Cotter	18-3742	314502	1	73	Key, Impeller	18-3138	334897	1
33	Spacer, Prop	18-4228	315810	1	74	Impeller	18-3104-1	432941	1
34	Washer, Prop Thrust	18-4230	320305	1	75	Skirting, Insert	NSS	324980	1
35	Anode, Bearing Housing	—	398873	1	76	Plate, Insert Top	18-3126	321940	1
36	Bolt, Anode Retaining	—	328694	2	77	Seal, Rubber	18-7481	324981	1
37	Oil Seals, Prop Shaft	18-2060	321467	2	78	Housing, W/P	18-3129	438544	1
38	Bearing, Needle	18-1355	386765	1	79	Bolt, Water Pump Housing	18-3369	302325	4
39	Bearing Carrier Assembly	18-1708	432276	1	80	Gear Housing Seal Kit	18-2694	433550	1
40	Tabs, Retaining	18-1343	332495	2	81	Water Pump Repair Kit	18-3394	433548	1
41	Bolt, Carrier Retaining	—	328744	2					
42	O-Ring, Bearing Housing	18-7172	553126	1					
43	Bearing, Needle	18-1354	386764	1					
44	Thrust Washer, Reverse Gear	18-0196	332514	1					
45	Thrust Bearing, Reverse Gear	18-1363	397537	1					
46	Gear, Reverse	18-2309	332489	1					

AR As required

NSS Not Sold Separate

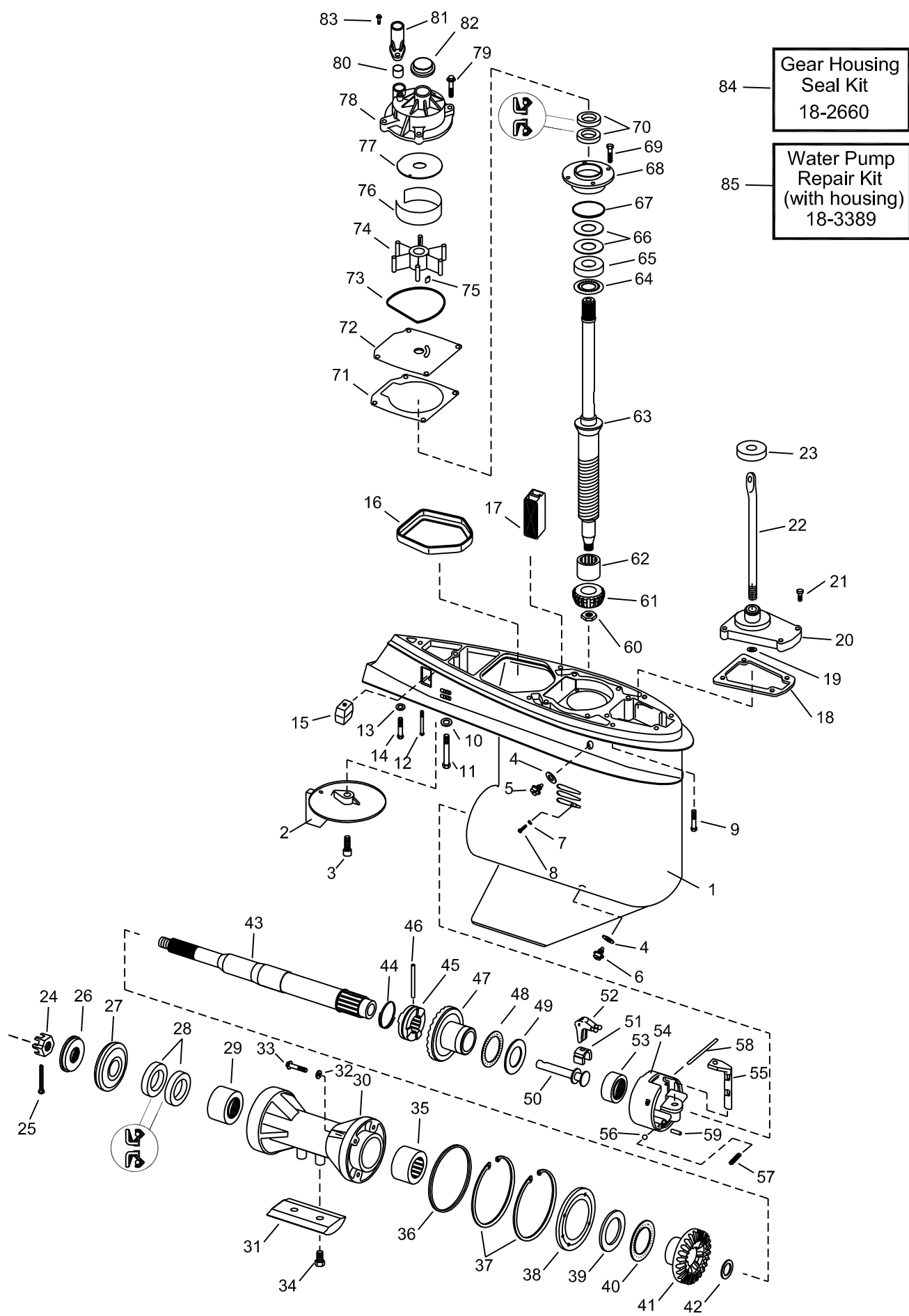

Complete Gear Housings Listed on Page 328

Figure #	Description	Part #	O.E.M. #	Qty.	Figure #	Description	Part #	O.E.M. #	Qty.
1	Housing Gearcase	—	392478	1	43	Propshaft	18-2250	439185, 439131	1
2	Trim Tab	—	318544	1					
3	Bolt, Trim Tab	—	313715	1	44	Retaining Spring	18-2399	324369	1
4	O-Rings, Drain Plugs	18-7145	333572	2	45	Clutch Sliding	18-2209	318303	1
5	Drain Fill Plug, Upper	18-2387	307551	1	46	Pin, Clutch Dog	18-1714	313448	1
6	Magnetic Drain Screw	18-2378	318544	1	47	Gear Set, Forward & Pinion	—	397338	1
7	Seal	18-7475	332584	1	48	Thrust Bearing, Forward Gear	18-1371	385043	1
8	Bolt, Pinion Retaining	—	324852	1	49	Thrust Washer, Forward Gear	18-0198	324766	1
9	Bolt, Housing	—	308843	4	50	Shaft, Shifter	—	326668	1
10	Lockwasher	—	306314	1	51	Cradle, Shifter	18-3766	334163	1
11	Bolt, Long Gearcase	—	313697	1	52	Lever, Shift	—	324037	1
12	Bolt, Anode	—	328096	1	53	Bearing, Housing	NSS	NSS	
13	Lockwasher	—	306470	1	54	Bearing Housing Assy.	—	391365	1
14	Bolt, Short Gearcase	—	306503	1	55	Detent Shift	—	326670	1
15	Anode, Cavitation	18-6024	436745	1	56	Detent Ball	—	327345	1
16	Seal, Exhaust	18-2537	324937	1	57	Detent Spring	—	911961	1
17	Screen, Water Inlet	—	314175	1	58	Pin, Shifter Housing	—	320145	1
18	Gasket, Shiftshaft Housing	18-2855	314082	1	59	Pin, Housing	18-3765	331880	1
19	O-Rings, Shiftshaft	18-7137	318372	1	60	Nut, Pinion	—	313339	1
20	Shiftshaft Housing	—	388651	1	61	Gear, Pinion	NSS	NSS	
21	Bolt, Shiftshaft Housing	18-3133	302325	4	62	Bearing, Pinion	18-1356	382343	1
22	Shiftshaft	—	327337	1	63	Driveshaft(std)	—	437376	1
23	Slinger, Shift Arm	18-2706	321008	1	64	Bearing, Thrust	—	317230	1
24	Nut, Propeller	18-3705	314503	1	65	Washer, Thrust	18-1367	385068	1
25	Cotter Pin, Prop Nut	18-3742	314502	1	66	Shim (.003)	18-2232	323889	AR
26	Spacer, Prop Nut	18-4228	315810	1	66	Shim (.004)	18-2233	323890	AR
27	Thrust Washer	18-4222	127084, 318841	1	66	Shim (.005)	18-2234	317232	AR
28	Outer Seal, Carrier	18-8326	330137	1	67	O-Ring Bearing Housing	18-7128	313754	1
28	Inner Seal, Carrier	18-2001	342787	1	68	Driveshaft Retaining Housing	—	385087	1
29	Carrier Bearing (Aft)	18-1350	379504	1	69	Bolt, Driveshaft Retaining	—	909386	4
30	Carrier Assembly	—	434391	1	70	Seal	18-8325	342786	1
31	Anode, Carrier	—	306470	1	71	Gasket, Water Pump	18-2709	336530	1
32	Seal	18-7475	332584	4	72	Plate, Impeller	18-3127	341038	1
33	Bolt, Carrier to Retainer	18-2379	320041	4	73	Seal, Water Pump Housing	18-7481	324981	1
34	Bolt, Carrier Anode	—	127466	2	74	Impeller	18-3053-1	396725	1
35	Carrier Bearing (Fore)	18-1351	382407	1	75	Key, Impeller	18-3138	334897	1
36	O-Ring , Bearing Housing	18-7127	313446	1	76	Liner, Water Pump Housing	—	321940	1
37	Retaining Rings	—	313445	2	77	Liner, Top Plate	18-3126	324980	1
38	Retaining Plate, Carrier	—	313453	1	78	Housing, Water Pump	18-3129	435673	1
39	Large Thrust Washer, Reverse Gear	18-0193	313447	1	79	Bolt, Water Pump Housing	18-3133	302325	1
40	Thrust Bearing, Reverse Gear	18-1366	382408	1	80	Seal, Guide tube	18-2703	314008	1
41	Gear, Reverse	18-2208	318304	1	81	Guide, Water Tube	—	319276	1
42	Small Thrust Washer, Reverse Gear	—	316484	1	82	Grommet	18-2705	342786	1
					83	Screw, Guide Tube	18-3153	908158	1
					84	Gear Housing Seal Kit	18-2660	396349	1
					85	Water Pump Repair Kit, Complete	18-3389	432955	1

AR As required

NSS Not Sold Separate

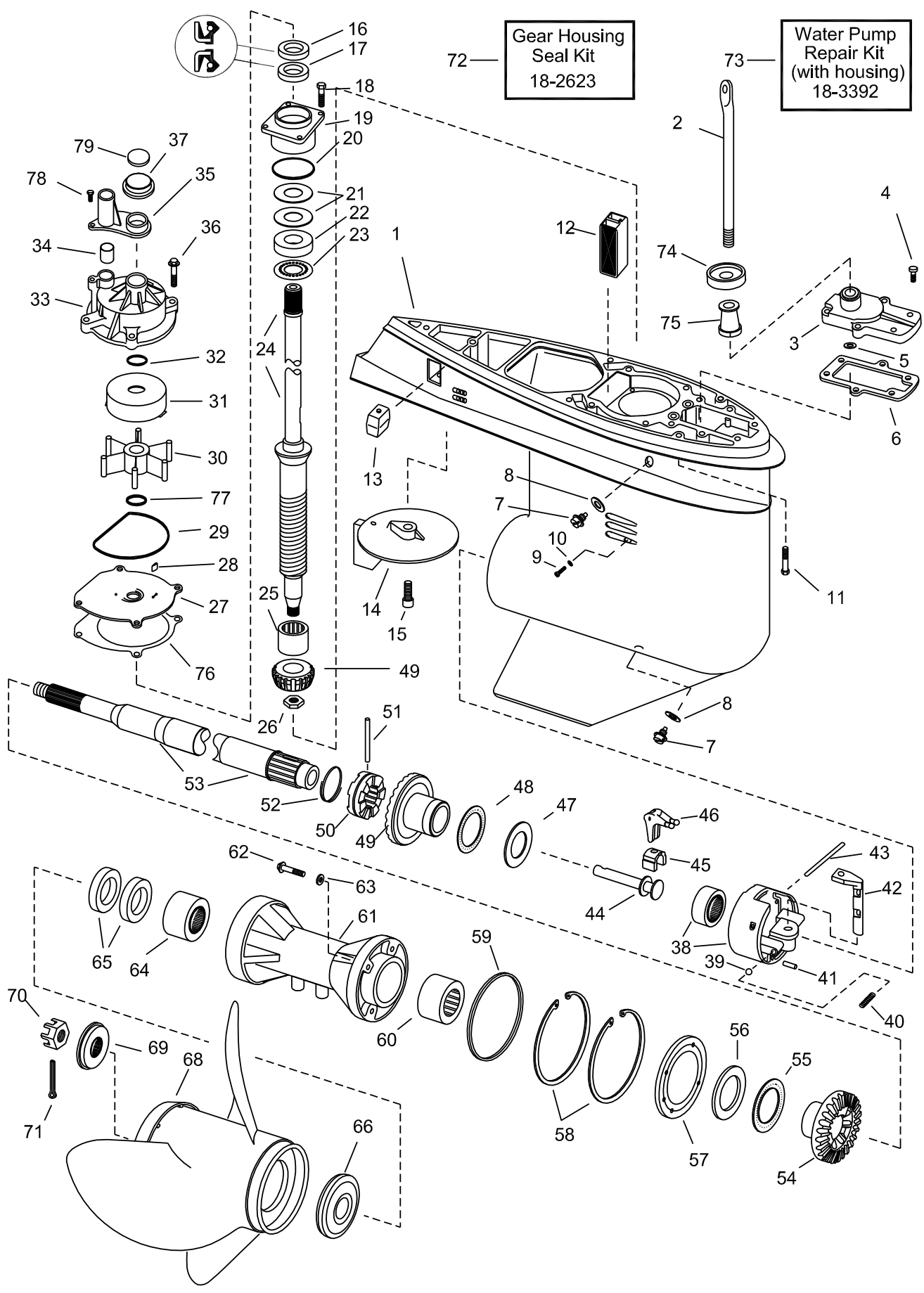

Complete Gear Housings Listed on Page 328

Figure #	Description	Part #	O.E.M. #	Qty.	Figure #	Description	Part #	O.E.M. #	Qty.
1	Housing Gearcase	—	431642	1	43	Pin, Shift Lever	—	320145	1
2	Shift Rod (long)	—	332120	1	44	Shift Shaft	18-3763	322941	1
	Shift Rod (x-long)	—	332121	1	45	Cradler, Shifter	18-3766	334163	1
3	Cover, Shift Rod	—	388618	1	46	Shift Lever	—	324037	1
4	Screw, Cover	18-3369	302325	6	47	Thrust Washer, Forward Gear	18-0198	324766	1
5	O-Ring, Shift Rod	18-7137	318372	1	48	Thrust Bearing, Forward Gear	18-1371	385043	1
6	Gasket, Shift Housing	18-0110	324670	1	49	Gear Set, Forward & Pinion	18-2218	398035	1
7	Magnetic Drain Screw	18-2378	318544	1	50	Sliding Clutch	18-2220	323664	1
8	O-Rings, Plugs	18-7145	333572	1	51	Pin, Clutch Dog	18-1714	313448	1
9	Screw	—	324852	1	52	Retaining Spring	18-2399	324369	1
10	O-Ring	18-7475	332584	1	53	Propeller Shaft	18-2252	387818	1
11	Screw, Gearcase to housing	—	331999	5	54	Gear, Reverse	18-2219	333077	1
12	Screen, Water intake	—	323466	1	55	Thrust Bearing, Reverse Gear	18-1366	382408	1
13	Anode	18-6024	393023	1	56	Thrust Washer, Reverse Gear	18-0195	314731	1
14	Trim Tab	—	327640	1	57	Retainer Plate/Bearing Housing	—	314732	1
15	Screw, Trim tab	—	313715	1	58	Retaining Rings	—	313445	2
16	Oil Seal, Upper	18-2061	329922	1	59	O-Ring, Bearing Housing	18-7127	313446	1
17	Oil Seal, Lower	18-2062	329923	1	60	Carrier Bearing (Fore)	18-1351	382407	1
18	Screw, Housing to gearcase	—	317624	4	61	Bearing Housing	—	397087	1
19	Bearing Housing	—	397493	1	62	Screw, Retainer	18-2377	316563	4
20	O-Ring Bearing Housing	18-7130	314728	1	63	O-Ring	18-7475	332583	1
21	Shim .003	18-2229	323362	AR	64	Roller Bearing (Aft)	18-1350	379504	1
	Shim .004	18-2230	323361	AR	65	Oil Seals, Prop Shaft	18-2001	330137	2
	Shim .005	18-2231	314745	AR	66	Thrust Washer	18-4222	318841	1
22	Thrust Washer, Pinion	18-0200	327656	1	68	Propeller	—	Various	1
23	Thrust Bearing, Pinion	18-1365	387656	1	69	Spacer, Prop Nut	18-4228	315810	1
24	Drive Shaft (long)	—	394613	1	70	Nut, Propeller	18-3705	314503	1
	Drive Shaft (x-long)	—	394614	1	71	Cotter Pin, Prop Nut	18-3742	314502	1
25	Bearing, Pinion	18-1357	384195	1	72	Gear Housing Seal Kit	18-2623	396354	1
26	Nut, Pinion	18-3719	314730	1	73	Water Pump Repair Kit (w/housing)	18-3392	395062	1
27	Wear Plate	18-3346	330380	1					
28	Key, Impeller	18-3299	331107	1	74	Grommet	18-2706	321008	1
29	Seal, Impeller Housing	18-7963	331353	1	75	Spacer, Shift rod	—	321122	1
30	Impeller	18-3059	395864	1	76	Gasket, Impeller housing plate	18-2557	324701	1
31	Cup, Impeller	18-3346	330379	1	77	O-Ring, Drive Shaft	—	302035	1
32	O-Ring, Drive Shaft	18-2769	332000	1	78	Screw, Cover to impeller	18-3135	306643	2
33	Housing, Water Pump	18-3130	395040	1	79	O-Ring, Driveshaft to crankcase	18-7158	310585	1
34	Grommet, Water Tube	18-2703	314008	1					
35	Pump cover	—	321159	1					
36	Screw, Impeller housing	—	328715	4					
37	Grommet	18-2704	320943	1					
38	Bearing Housing Assembly	—	391365	1					
39	Ball, Detent	—	327345	1					
40	Spring, Detent	—	326666	1					
41	Pin, Housing	18-3765	331880	1					
42	Detent, Shifter	—	323946	1					

AR As required

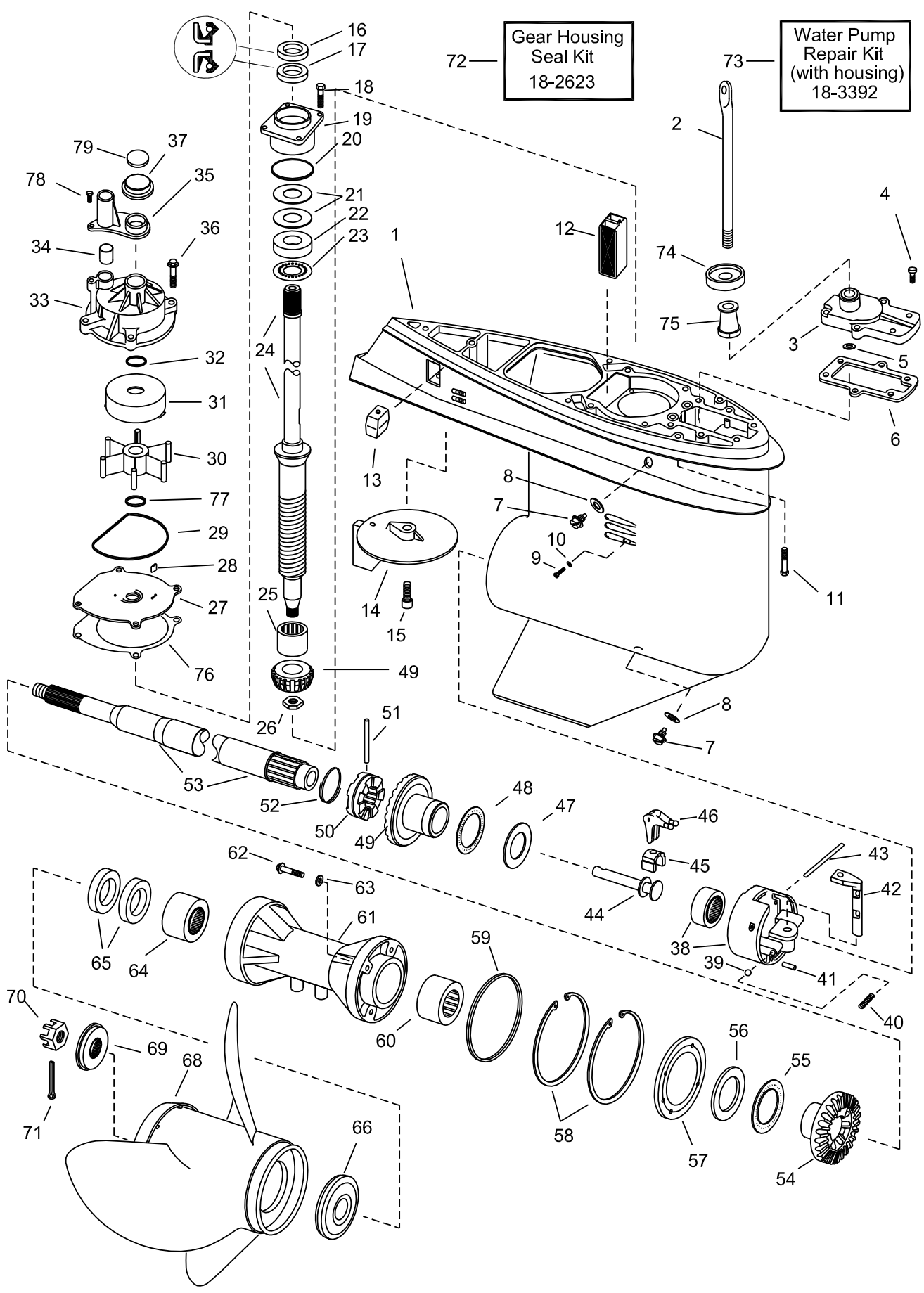

Complete Gear Housings Listed on Page 328

Figure #	Description	Part #	O.E.M. #	Qty.	Figure #	Description	Part #	O.E.M. #	Qty.
1	Housing Gearcase	—	438050	1	43	Pin, Shift Lever	—	328825	1
2	Shift Rod (long)	—	324407	1	44	Shift Shaft	18-3763	322941	1
2	Shift Rod (x-long)	—	324408	1	45	Cradler, Shifter	18-3766	334163	1
3	Cover & Shift Rod	—	435482	1	46	Shift Lever	18-3762	322938	1
4	Screw, Cover	18-3369	302325	6	47	Thrust Washer, Forward Gear	18-0199	327669	1
5	O-Ring, Shift Rod	18-7137	318372	1	48	Thrust Bearing, Forward Gear	18-1370	389042	1
6	Gasket, Shift Housing	18-0110	324670	1	49	Gear Set, Forward & Pinion	NSS	435020	1
7	Magnetic Drain Screw	18-2378	318544	2	50	Sliding Clutch	18-2216	337774	1
8	O-Rings, Plugs	18-7145	333572	2	51	Pin, Clutch Dog	18-1714	313448	1
9	Screw	—	324852	1	52	Retaining Spring	18-2399	324369	1
10	O-Ring	18-7120	307853	1	53	Propeller Shaft	18-2187	395209	1
11	Screw,Gearcase to housing	—	320741	5	54	Gear, Reverse	NSS	910994	1
12	Screen,Water intake	—	321123	1	55	Thrust Bearing, Reverse Gear	18-1366	382408	1
13	Anode	18-6024	393023	1	56	Thrust Washer, Reverse Gear	18-0195	314731	1
14	Trim Tab	—	327640	1	57	Retainer Plate/Bearing Housing	—	321174	1
15	Screw,Trim tab	—	313715	1	58	Retaining Rings	—	321171	2
16	Oil Seal, Upper	18-2061	329922	1	59	O-Ring , Bearing Housing	18-7133	305123	1
17	Oil Seal, Lower	18-2062	329923	1	60	Carrier Bearing (Fore)	18-1351	382407	1
18	Screw,Housing to gearcase	—	316534	4	61	Bearing Housing	—	397094	1
19	Bearing Housing	—	438963	1	62	Screw, Retainer	18-2377	316563	4
20	O-Ring Bearing Housing	18-7130	314728	1	63	O-Ring	18-7109	317178	1
21	Shim .003	18-2229	323362	AR	64	Roller Bearing (Aft)	18-1158	387247	1
21	Shim .004	18-2230	323361	AR	65	Oil Seals, Prop Shaft	18-2002	320862	2
21	Shim .005	18-2231	314745	AR	66	Thrust Washer	18-4223	333592	1
22	Thrust Washer, Pinion	18-0200	327656	1	68	Propeller	—	various	1
23	Thrust Bearing, Pinion	18-1365	387665	1	69	Spacer, Prop Nut	18-4231	320570	1
24	Drive Shaft (long)	see app chart	435755	1	70	Nut, Propeller	18-3708-1	398042	1
24	Drive Shaft (x-long)	see app chart	435756	1	71	Cotter Pin, Prop Nut	18-3741	306394	1
25	Bearing, Pinion	18-1117	387817	1	72	Gear Housing Seal Kit	18-2623	396353	1
26	Nut, Pinion	18-3719	314730	1	73	Water Pump Repair Kit (w/housing)	18-3392	434421	1
27	Cup & Plate Assembly	18-3346	330380	1					
28	Key, Impeller	18-3299	331107	1	74	Grommet	18-2706	321008	1
29	Seal, Impeller Housing	18-7963	331353	1	75	Spacer,Shift rod	—	321122	1
30	Impeller	18-3059	397131	1	76	Gasket,Impeller housing plate	18-2557	324701	1
31	Cup & Plate Assembly	18-3346	330379	1	77	O-Ring, Drive Shaft	18-7158	310585	1
32	O-Ring, Drive Shaft	18-7158	310585	1	78	Screw,Cover to impeller	18-3135	306643	2
33	Housing, Water Pump	18-3130	395040	1	79	O-Ring,Driveshaft to crankcase	18-7158	310585	1
34	Grommet, Water Tube	18-2703	314008	1					
35	Pump cover	—	321159	1					
36	Screw,Impeller housing	18-3136	323626	4					
37	Grommet	18-2704	320943	1					
38	Bearing Housing Assembly	—	389455	1					
39	Ball, Detent	18-1501	160084	1					
40	Spring, Detent	18-1502	911962	1					
41	Pin, Housing	18-3765	331880	1					
42	Detent, Shifter	—	323946	1					

AR As required



18-4840^②
COMPLETE LOWER GEARCASE ASSEMBLIES
 Replaces: 435277
 Fits: 40/48/50hp w/20" Shaft (1989-92)



18-4841^②
COMPLETE LOWER GEARCASE ASSEMBLIES
 Replaces: 435276
 Fits: 40/48/50hp w/15" Shaft (1989-92)



18-4843^②
COMPLETE LOWER GEARCASE ASSEMBLIES
 Replaces: 435279
 Fits: 40/48/50hp w/15" Shaft (1993 and Up)

PKG. OF 5



18-2377
18-2377-9^①
RETAINER SCREW
 Replaces: 316563

PKG. OF 4



18-2379
18-2379-9^①
LOWER UNIT CARRIER SCREW
 Replaces: 320041



18-4826
GEARCASE TO HOUSING SCREW
 Replaces: 331999

PKG. OF 5



18-4253-9^①
18-42531-9^①
 (PKG. OF 50)
DRAIN SCREW O-RING
 Replaces: 336982
 Used w/ 18-1236 Drain Screw

PKG. OF 5



18-4248
18-4248-9^①
18-42481-9^①
 (PKG. OF 50)
DRAIN/FILL PLUG WASHER
 (Plastic)
 Replaces: 311598
 Used with 18-2387 Drain Screw

PKG. OF 2



18-2945
18-2945-9^①
18-29451-9^①
 (PKG. OF 50)
DRAIN SCREW GASKET
 Replaces: 307552



18-1236
DRAIN SCREW
 Replaces: 309243
 For: 40-50 HP (1989-97)
 Cobra Drives



18-2387
18-23871-9^①
 (PKG. OF 50)
LOWER UNIT DRAIN/FILL SCREW
 Slot Head



18-4255
E-TEC DRAIN SCREW
 Replaces: 307551
 Allan Head



18-2378
18-23781-9^①
 (PKG. OF 50)
MAGNETIC DRAIN SCREW
 Slot Head

^① Priced per package

^② All gearcase assemblies pictured above are primed only. Be prepared to paint the gearcase to match your customer's engine.



18-4249
E-TEC DRAIN SCREW WITH MAGNET
 Replaces: 318544
 Allan Head



18-3708-1
PROP NUT & KEEPER
 Replaces: 398042

PKG. OF 5



PROP NUTS

PART #	O.E. #
18-3705 ②	314503
18-3706 ②	318971
18-3707 ②	319891

PKG. OF 10



COTTER PINS

PART #	O.E. #	DIMEN.
18-3735 ②	5030087	5/32" X 1 3/8"
18-3740 ②	302804	3/32" X 1"
18-3741 ②	309955	1/8" X 1 3/4"
18-3742 ②	314502	1/8" X 1 1/4"
18-3743 ②	320785	1/8" X 3/4"
18-3744 ②	552906	3/32" X 3/4"

③ **18-3715D** 



18-3715
PROP NUT KIT
 Replaces: 175266
 — CONTAINS —

Part #	O.E. #	Description
18-3708-1	398042	Prop Nut/Keeper
18-3741	309955	Cotter Pin
18-4231	320570	Prop Spacer

③ **18-3716D** 



18-3716
PROP NUT KIT
 Replaces: 175267
 — CONTAINS —

Part #	O.E.#	Description
18-3705	314503	Prop Nut
18-3742	314502	Cotter Pin
18-4228	315810	Prop Spacer

③ **18-3717D** 



18-3717
PROP NUT KIT
 Replaces: 175268
 — CONTAINS —

Part #	O.E. #	Description
18-3707	319891	Prop Nut
18-3743	320785	Cotter Pin
18-4232	323943	Prop Spacer



18-3753
PROP NUT KIT
 Replaces: 5005034
 Fits: 40-130 (2001 & Up)



18-3768
COVER NUT
 Replaces: 911751
 For: Cobra drives: 115 (1994-97),
 232 (1987-90), 252 (1986), 262 (1989),
 302 (1987)



18-4222
THRUST WASHER
 Replaces: 318841, 127084



18-4223
THRUST WASHER
 Replaces: 333592



18-4228
PROP SPACER
 Replaces: 315810



18-4229
THRUST WASHER
 Replaces: 319890



18-4230
THRUST WASHER
 Replaces: 320305



18-4231
PROP SPACER
 Replaces: 320570



18-4232
PROP SPACER
 Replaces: 323943

APPLICATION ON NEXT PAGE

① Priced per package ② This product is priced per piece. To order priced per package, please add -9 to the part number.
 ③ Items ending in "D" are Display Packaged - Regular number is Non-Display

JOHNSON/EVINRUDE

HP	Year	Spacer Before Prop	Washer After Prop	Prop Nut	Cotter Pin	Prop Nut Kit
9.9/15	1974-75	—	—	18-3706	18-3740	—
9.9/15	1976-99	—	—	18-3706	18-3744	—
20	1984-90	18-4229	18-4232	18-3707	18-3743	18-3717
20/30/35	1991-99	—	18-4232	18-3707	18-3743	18-3717
25 ⑥	1991	—	18-4232	18-3707	18-3743	18-3717
25 ⑦	1991	18-4232	18-4228	18-3705	18-3742	18-3716
25 ⑧	1992	—	18-4232	18-3707	18-3743	18-3717
25/30	1984-90	18-4229	18-4232	18-3707	18-3743	18-3717
35	1976-90	18-4229	18-4232	18-3707	18-3743	18-3717
40 ① ④	1984-99	18-4230	18-4228	18-3705	18-3742	18-3716
40 Comm	1996-97	18-4222	18-4228	18-3705	18-3742	18-3716
40 Comm	1998-99	—	18-4228	18-3705	18-3742	18-3716
45 Comm ②	1986-97	—	18-4228	18-3705	18-3742	18-3716
48 ①	1987-96	18-4230	18-4228	18-3705	18-3742	18-3716
50/60 TTL	1996-98	18-4222	18-4228	18-3705	18-3742	18-3716
50 ②	1971-74	18-4222	18-4228	18-3705	18-3742	18-3716
50 ① ④	1975-99	18-4230	18-4228	18-3705	18-3742	18-3716
50 EL&DT	1996-98	—	18-4228	18-3705	18-3742	18-3716
50 Comm ②	1977-79	18-4222	18-4228	18-3705	18-3742	18-3716
55	1968-69	18-4222	18-4228	18-3705	18-3742	18-3716
55 ①	1976-79	18-4230	18-4228	18-3705	18-3742	18-3716
55 Comm ②	1980-97	18-4222	18-4228	18-3705	18-3742	18-3716
55 Comm	1998-99	—	18-4228	18-3705	18-3742	18-3716
60/70 ④	1996-99	—	18-4228	18-3705	18-3742	18-3716
60	1970-71, 1986-95	18-4222	18-4228	18-3705	18-3742	18-3716
60 ①	1980-85	18-4230	18-4228	18-3705	18-3742	18-3716
65	1972-73	18-4222	18-4228	18-3705	18-3742	18-3716
65 Comm	1984-95	18-4222	18-4228	18-3705	18-3742	18-3716
65 Comm	1996-99	—	18-4228	18-3705	18-3742	18-3716
70	1974-95	18-4222	18-4228	18-3705	18-3742	18-3716
75 ②	1975-84	18-4222	18-4228	18-3705	18-3742	18-3716
75 ①	1975-85	18-4230	18-4228	18-3705	18-3742	18-3716
Formula E	1986-90	18-4230	18-4228	18-3705	18-3742	18-3716
Sprint	1986-90	18-4230	18-4228	18-3705	18-3742	18-3716
85	1969-80, 1995	18-4222	18-4228	18-3705	18-3742	18-3716
88/90	1981-95	18-4222	18-4228	18-3705	18-3742	18-3716
88	1996	—	18-4228	18-3705	18-3742	18-3716
90 ① ④	1996-99	—	18-4228	18-3705	18-3742	18-3716
90 ②	1996	—	18-4231	18-3708-1	—	—
90 V-4 ④	1997-99	—	18-4228	18-3705	18-3742	18-3716
90 V-4 ② ④	1997	18-4223	18-4231	18-3708-1	—	—
90 FSX/ FPX ④	1998-99	18-4223	18-4231	18-3708-1	—	—
100	1979-80	18-4222	18-4228	18-3705	18-3742	18-3716
100 ⑨	1988-94	18-4222	18-4228	18-3705	18-3742	18-3716
100 ⑩	1992	—	18-4231	18-3708-1	—	—
100 Comm ④	1996, 1998	—	18-4228	18-3705	18-3742	18-3716
100 Comm	1995-97, 1999	18-4223	18-4231	18-3708-1	—	—
100 Comm ③	1984-90	18-4223	18-4231	18-3708-1	18-3741	18-3715
110	1986-89	18-4222	18-4228	18-3705	18-3742	18-3716
112	1996	—	18-4228	18-3705	18-3742	18-3716
115	1973-94	18-4222	18-4228	18-3705	18-3742	18-3716
115 ① ④	1996-99	—	18-4228	18-3705	18-3742	18-3716
115 ②	1996	—	18-4231	18-3708-1	—	—
115 V-4 ④	1997-99	—	18-4228	18-3705	18-3742	18-3716
115 V-4 ② ④	1997	18-4223	18-4231	18-3708-1	—	—
115 FSX/ FPX ④	1998-99	18-4223	18-4231	18-3708-1	—	—
120 ③	1985	18-4223	18-4231	18-3708-1	18-3741	18-3715

APPLICATION CONTINUED ON NEXT PAGE

- ① Models equipped with small gearcase
- ② Models equipped with large gearcase
- ③ Models equipped with V-6 gearcase
- ④ For 3-Blade propeller only
- ⑤ Use 18-4222 for 4-Blade propeller

- ⑥ All models except DR, DE & DT
- ⑦ Models DR, DE & DT only
- ⑧ Except models RSU, RSLU, RWENB, RWLENB
- ⑨ Except 1992 models WTLNE, WTXNENE
- ⑩ Models WTLNE, WTXNENE

- ① 1992 ES models only
- ② Except 1992 ESX models
- ③ 1992 TL models only
- ④ 1992 CX, TX models only

JOHNSON/EVINRUDE

HP	Year	Spacer Before Prop	Washer After Prop	Prop Nut	Cotter Pin	Prop Nut Kit
120	1986-94	18-4222	18-4228	18-3705	18-3742	18-3716
125 ①	1971-94	18-4222	18-4228	18-3705	18-3742	18-3716
125 ②	1992	—	18-4231	18-3708-1	—	—
125 Comm	1991	—	18-4231	18-3708-1	18-3741	18-3715
125 Comm	1992-96	18-4223	18-4231	18-3708-1	—	—
130	1995-99	18-4223	18-4231	18-3708-1	—	—
135	1973-76	18-4222	18-4228	18-3705	18-3742	18-3716
140	1977-84	18-4222	18-4228	18-3705	18-3742	18-3716
140 ③	1985	18-4223	18-4231	18-3708-1	18-3741	18-3715
140 ⑥	1986-94	18-4222	18-4228	18-3705	18-3742	18-3716
140 ③	1990	18-4223	18-4231	18-3708-1	18-3741	18-3715
140 ④	1992	—	18-4231	18-3708-1	—	—
150	1978-90	18-4223	18-4231	18-3708-1	18-3741	18-3715
150	1991-95	—	18-4231	18-3708-1	18-3741	18-3715
150 ④	1996-99	18-4223	18-4231	18-3708-1	—	—
155 Comm	1984-90	18-4223	18-4231	18-3708-1	18-3741	18-3715
155 Comm	1991-95	—	18-4231	18-3708-1	18-3741	18-3715
175	1977-90	18-4223	18-4231	18-3708-1	18-3741	18-3715
175	1992	—	18-4231	18-3708-1	—	—
175 ④	1993-99	18-4223	18-4231	18-3708-1	—	—
185	1984-85	18-4223	18-4231	18-3708-1	18-3741	18-3715
185 Comm ④	1991-95	—	18-4231	18-3708-1	18-3741	18-3715
200	1976-90	18-4223	18-4231	18-3708-1	18-3741	18-3715
200/225 ④	1991-95	—	18-4231	18-3708-1	18-3741	18-3715
200/225 ④	1996-99	18-4223	18-4231	18-3708-1	—	—
225	1986-90	18-4223	18-4231	18-3708-1	18-3741	18-3715
235	1978-85	18-4223	18-4231	18-3708-1	18-3741	18-3715
250/300	1991	18-4223 ⑤	18-4231	18-3708-1	18-3741	18-3715
250/300	1992	—	18-4231	18-3708-1	—	—
250/300 ④	1993-95	18-4223	18-4231	18-3708-1	—	—
250	1996-99	18-4223	18-4231	18-3708-1	—	—
2.6L	1984-85	18-4223	18-4231	18-3708-1	18-3741	18-3715
275	1986	18-4223	18-4231	18-3708-1	18-3741	18-3715
3.6L	1986-90	18-4223	18-4231	18-3708-1	18-3741	18-3715

OMC SEA DRIVE

V4	1982-90	18-4222	18-4228	18-3708-1	18-3742	18-3715
V6	1982-90	18-4223	18-4231	18-3708-1	18-3741	18-3715
V8	1987, 1989-90	18-4223	18-4231	—	—	—

- ① Models equipped with small gearcase
- ② Models equipped with large gearcase
- ③ Models equipped with V-6 gearcase
- ④ For 3-Blade propeller only
- ⑤ Use 18-4222 for 4-Blade propeller

- ⑥ All models except DR, DE & DT
- ⑦ Models DR, DE & DT only
- ⑧ Except models RSU, RSLU, RWENB, RWLENB
- ⑨ Except 1992 models WTLNE, WTXNENE
- ⑩ Models WTLNE, WTXNENE

- ① 1992 ES models only
- ② Except 1992 ESX models
- ③ 1992 TL models only
- ④ 1992 CX, TX models only

 <p>18-8304 OIL SEAL Replaces: 321830</p>	 <p>18-0195 THRUST WASHER Reverse & Forward Gear Replaces: 314731 For: 45-60 HP - 2 Cyl, 3 Cyl, V-4 & V-6</p>	 <p>18-0197 THRUST WASHER Forward Gear Replaces: 333725 For: 40-55 HP - 1989-1995</p>	 <p>18-0198 THRUST WASHER Forward Gear Replaces: 324766 For: 3 Cyl, V-4 & V-6</p>
 <p>18-0200 THRUST WASHER Drive Shaft Replaces: 327656 For: V-4 & V-6</p>	 <p>18-0201 THRUST WASHER Drive Shaft Replaces: 333771 For: 40-60 HP - 1990-1995</p>	 <p>18-1117 PINION BEARING Replaces: 387817</p>	 <p>18-1154 BALL BEARING Replaces: 377139</p>



18-1158
CARRIER BEARING
 Replaces: 387247



18-1750
COMPLETE BEARING HOUSING
 For: Cobra Drives & V6



18-1161
TAPERED ROLLER BEARING
 Replaces: 983891



18-1299
LOWER MAIN BEARING
 Replaces: 433503
 For: V4 & V6 60° engines



18-1344
NEEDLE BEARING
 Ref. # J-1812
 Fits: Driveshaft bearing cup 18-4807
 (OE# 439476)



18-1350
NEEDLE BEARING
 (CARRIER)
 Replaces: 379504



18-1351
NEEDLE BEARING
 (CARRIER)
 Replaces: 382407



18-1354
NEEDLE BEARING
 Replaces: 386764



18-1355
NEEDLE BEARING
 Replaces: 386765



18-1356
NEEDLE BEARING
 (PINION)
 Replaces: 382343



18-1357
NEEDLE BEARING
 (PINION)
 Replaces: 384195



18-1363
THRUST BEARING
 Replaces: 397537



18-1364
THRUST BEARING
 Replaces: 397538



18-1365
THRUST BEARING
 Replaces: 387656



18-1366
THRUST BEARING
 Replaces: 382408



18-1367
THRUST BEARING
 Replaces: 385068



18-1368
THRUST BEARING
 Replaces: 398901



18-1369
THRUST BEARING
 Replaces: 432264



18-1370
THRUST FORWARD BEARING
 Replaces: 389042



18-1371
THRUST FORWARD BEARING
 Replaces: 385043

HP	Year	Drive Shaft Bearing	Pinion Gear Bearing	Fore Carrier Bearing	Aft Carrier Bearing	Fwd. Gear Thrust Bearing	Rev Gear Thrust Bearing	Fore Propshaft Bearing	Aft. Propshaft Bearing
25D	1989-95	18-1368	18-1356	18-1354	18-1355	18-1364	18-1363	18-1369	18-1351
35	1987	—	—	18-1354	18-1355	—	—	—	—
40	1984-88	—	—	18-1354	18-1355	—	—	—	—
40	1989-Up	18-1368	18-1356	18-1354	18-1355	18-1364	18-1363	18-1369	18-1351
45 Comm	1985-Up	—	18-1367	18-1356	18-1351	18-1350	18-1371	18-1366	—
48	1987-88	—	—	18-1354	18-1355	—	—	—	—
48	1989-96	18-1368	18-1356	18-1354	18-1355	18-1364	18-1363	18-1369	18-1351
50	1973-74	18-1367	18-1356	18-1351	18-1350	18-1366	18-1366	—	—
50	1975	—	—	18-1354	18-1355	—	—	—	—
50	1979-88	—	—	18-1354	18-1355	—	—	—	—
50	1989-Up	18-1368	18-1356	18-1354	18-1355	18-1364	18-1363	18-1369	18-1351
50 ①	1995-Up	18-1367	18-1356	18-1351	18-1350	18-1371	18-1366	—	—
55	1976-81	—	—	18-1354	18-1355	—	—	—	—
55 ②	1980-82	18-1367	18-1356	18-1351	18-1350	18-1366	18-1366	—	—
55 Comm	1983-Up	—	18-1367	18-1356	18-1351	18-1350	18-1371	18-1366	—
60 ②	1980-81	18-1367	18-1356	18-1351	18-1350	18-1366	18-1366	—	—
60	1980-85	—	—	18-1354	18-1355	—	—	—	—
60 ③	1986-87	—	—	18-1354	18-1355	—	—	—	—
60 ④	1986-97	18-1367	18-1356	18-1351	18-1350	18-1371	18-1366	—	—
65	1973	18-1367	18-1356	18-1351	18-1350	18-1371	18-1366	—	—
65 Comm	1984-97	—	18-1367	18-1356	18-1351	18-1350	18-1371	18-1366	—
70 ④	1974-97	18-1367	18-1356	18-1351	18-1350	18-1371	18-1366	—	—
70 ③	1979-85	—	—	18-1354	18-1355	—	—	—	—
75 ④	1975-88	18-1367	18-1356	18-1351	18-1350	18-1371	18-1366	—	—
75 ③	1979-87	—	—	18-1354	18-1355	—	—	—	—
85	1973-80	18-1365	18-1357	18-1351	18-1350	18-1371	18-1366	—	—
85	1991-95	18-1365	18-1357	18-1351	18-1350	18-1371	18-1366	—	—
88	1987-96	18-1365	18-1357	18-1351	18-1350	18-1371	18-1366	—	—
90	1981-97	18-1365	18-1357	18-1351	18-1350	18-1371	18-1366	—	—
100	1979-80	18-1365	18-1357	18-1351	18-1350	18-1371	18-1366	—	—
100	1990-94	18-1365	18-1357	18-1351	18-1350	18-1371	18-1366	—	—
100 Comm	1984-90	—	18-1365	18-1117	18-1351	18-1158	18-1370	18-1366	—
100 Comm ⑧	1989-90	—	18-1365	18-1357	18-1351	18-1350	18-1371	18-1366	—
100 Comm	1991-93	—	18-1365	18-1117	18-1351	—	18-1370	18-1366	—
110	1986-89	18-1365	18-1357	18-1351	18-1350	18-1371	18-1366	—	—
112	1994-95	18-1365	18-1357	18-1351	18-1350	18-1371	18-1366	—	—
115	1973-85	18-1365	18-1357	18-1351	18-1350	18-1371	18-1366	—	—
115	1990-95	18-1365	18-1357	18-1351	18-1350	18-1371	18-1366	—	—
120	1985	18-1365	18-1117	18-1351	18-1158	18-1370	18-1366	—	—
120	1986-92	18-1365	18-1357	18-1351	18-1350	18-1371	18-1366	—	—
125 Comm ⑤	1989-90	—	18-1365	18-1117	18-1351	18-1158	18-1370	18-1366	—
125 Comm ⑥	1989-90	—	18-1365	18-1357	18-1351	18-1350	18-1371	18-1366	—
125 Comm	1991-94	—	18-1365	18-1117	18-1351	—	18-1370	18-1366	—
125	1992	18-1365	18-1357	18-1351	18-1350	18-1371	18-1366	—	—
135	1973-76	18-1365	18-1357	18-1351	18-1350	18-1371	18-1366	—	—
140	1977-84	18-1365	18-1357	18-1351	18-1350	18-1371	18-1366	—	—
140	1985	18-1365	18-1117	18-1351	18-1158	18-1370	18-1366	—	—
140	1986-92	18-1365	18-1357	18-1351	18-1350	18-1371	18-1366	—	—
140 TX	1988-90	18-1365	18-1117	18-1351	18-1158	18-1370	18-1366	—	—
140 TX	1991-92	18-1365	18-1117	18-1351	—	18-1370	18-1366	—	—
150	1978-90	18-1365	18-1117	18-1351	18-1158	18-1370	18-1366	—	—
150	1991-95	18-1365	18-1117	18-1351	—	18-1370	18-1366	—	—
150 Comm	1993-95	—	18-1365	18-1117	18-1351	—	18-1370	18-1366	—
155 Comm	1984-90	—	18-1365	—	18-1351	18-1158	—	18-1366	—
155 Comm ⑤	1989-90	18-1365	18-1117	18-1351	18-1158	18-1370	18-1366	—	—
155 Comm ⑦	1989-90	18-1365	18-1117	18-1351	18-1158	18-1370	18-1366	—	—
175	1977	18-1365	18-1117	18-1351	18-1158	—	18-1366	—	—
175	1978-90	18-1365	18-1117	18-1351	18-1158	18-1370	18-1366	—	—
175	1991-97	18-1365	18-1117	18-1351	—	18-1370	18-1366	—	—
185	1984-85	18-1365	18-1117	18-1351	18-1158	18-1370	18-1366	—	—
185	1990	18-1365	18-1117	18-1351	18-1158	18-1370	18-1366	—	—
185	1992-94	18-1365	18-1117	18-1351	—	18-1370	18-1366	—	—
200	1976-77	18-1365	18-1117	18-1351	18-1158	—	18-1366	—	—
200	1978-90	18-1365	18-1117	18-1351	18-1158	18-1370	18-1366	—	—
200	1991-97	18-1365	18-1117	18-1351	—	18-1370	18-1366	—	—
200 Comm	1990-91	—	18-1365	18-1117	18-1351	18-1158	18-1370	18-1366	—
225	1986-90	18-1365	18-1117	18-1351	18-1158	18-1370	18-1366	—	—
225	1991-97	18-1365	18-1117	18-1351	—	18-1370	18-1366	—	—
235	1978-85	18-1365	18-1117	18-1351	18-1158	18-1370	18-1366	—	—

① 3 Cyl. Models ③ 15" Transom Models ⑤ WTP Models ⑦ WTA Models Only
 ② Rope Start Models ④ 20" Transom Models ⑥ ESX Models ⑧ Models with "S" Prefix Only

OUTBOARD SHAFTS



18-1723
LOWER DRIVE SHAFT
 Replaces: 346004
 For: V4 60° includes: E100, E115, E75, E 90, J115 & J90



18-2277
LOWER DRIVE SHAFT
 Replaces: 335722



18-2279
LOWER DRIVE SHAFT
 Replaces: 335679



18-9219
LOWER DRIVE SHAFT
 Replaces: 335677



18-1722
DRIVE SHAFT
 Replaces: 438399
 For: 20° Models, 40-50HP (1997-99)



18-1721
DRIVE SHAFT
 Replaces: 433067
 For: 20° Models, 40-50(1989-92)



18-2325
UPPER DRIVE SHAFT ASSEMBLY
 Replaces: 435760



18-2326
UPPER DRIVE SHAFT ASSEMBLY
 Replaces: 436232



18-2327
UPPER DRIVE SHAFT ASSEMBLY
 Replaces: 436234

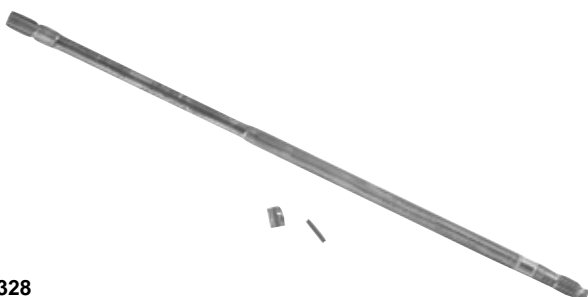

18-2328
UPPER DRIVE SHAFT ASSEMBLY
 Replaces: 435761



18-2330
UPPER DRIVE SHAFT ASSEMBLY
 (Extra Long)
 Replaces: 436235



18-2093
SEAL
 Replaces: 319664, 333096, 398051
 For: 20 - 35 HP(1977-95) seal for prop-shaft 18-2026, driveshaft 18-2033, upper crankcase 18-8351

HP	Year	Lower Drive Shaft	Upper Drive Shaft	Upper Drive Shaft (Extra Long)	HP	Year	Lower Drive Shaft	Upper Drive Shaft	Upper Drive Shaft (Extra Long)
85 TTL	1991	18-2277	—	—	140 TX	1990-91	18-9219	—	—
85 TTL	1992-95	18-2277	18-2326	—	140 TL	1991-94	18-2277	18-2326	—
88	1991	18-2277	—	—	140 TX	1992-94	18-9219	—	—
88	1992-96	18-2277	18-2326	—	150	1990	18-9219	—	—
90	1991	18-2277	—	—	150	1991	18-9219	—	—
90	1992-97	18-2277	18-2326	—	150	1992-97	18-9219	18-2327	18-2330
90 ① ②	1995-96	—	18-2327	—	150 Comm	1993-95	18-9219	18-2327	18-2330
90 ② ③	1995-96	18-9219	—	18-2330	155 Comm	1990	18-2279③	—	—
90 ②	1997	18-2277	18-2326	—	155 Comm ⑤	1990	18-9219	—	—
100	1991	18-2277	—	—	155 Comm	1991	18-9219	—	—
100	1992-94	18-2277	18-2326	—	155 Comm	1992	18-9219	18-2326	—
100 Comm	1991	18-9219	—	—	175	1990	18-9219	—	—
100 Comm	1992-97	18-9219	18-2326	—	175	1991	18-9219	—	—
112	1994-96	18-2277	18-2326	—	175	1992-97	18-9219	18-2327	18-2330
115	1991	18-2277	—	—	185	1990	18-9219	—	—
115	1992-97	18-2277	18-2326	—	185	1991	18-9219	—	—
115 ① ②	1995-96	—	18-2327	—	185	1992-94	18-9219	18-2326	—
115 ② ③	1995-96	18-9219	—	18-2330	200	1990	18-9219	—	—
115 ②	1997	18-2277	18-2326	—	200	1991	18-9219	—	—
120	1991-93	18-2277	—	—	200	1992-97	18-9219	18-2326	—
120 ④	1993	18-9219	—	—	200 Comm	1990	18-9219	—	—
120 TL	1994	18-2277	18-2326	—	225	1990	18-9219	—	—
120 TX	1994	18-9219	—	—	225	1991	18-9219	—	—
125 Comm	1991-95	18-9219	18-2326	—	225	1992-97	18-9219	18-2326	—
125	1992-93	18-2277	—	—	250	1991-95	18-2279	—	—
125 ④	1993	18-9219	—	—	250	1997	18-2279	—	—
125	1994	18-2277	18-2326	—	300	1990	18-2279	—	—
130	1995-97	18-9219	18-2326	—	300	1991-95	18-2279	—	—

① 20" Models ② 60 Degree V Models ③ 25" Models ④ F Suffix Only ⑤ WTP Models Only

18-1725
PROP SHAFT
Replaces: 436834
For: V4 60HP



18-2187
PROP SHAFT
Replaces: 395209, 391472



18-2250
PROP SHAFT
Replaces: 387879



18-2251
PROP SHAFT
Replaces: 435022, 433017, 436740



18-2252
PROP SHAFT
Replaces: 387818, 436888



18-2355
PROP SHAFT
Replaces: 386659
For: 35, 40, 48, 50, 55, 60, 70, 75 HP 2 & 3 cyl. outboards (1975-1987)



18-2288
PROP SHAFT
Replaces: 397541, 439138



PROP SHAFT APPLICATION BEGINS ON PAGE 338



18-1287
FORWARD GEAR & BUSHING
Replaces: 392475
For: 25-35HP (1975-88)



18-1291
GEAR SET
For: Commercial V4 gearcases
—CONTAINS—

Part #	Desc.	O.E.#
NSS	Forward Gear	435123
NSS	Reverse Gear	336574
18-2216	Clutch	337774



18-1292
GEAR SET
For: Late model V-6 150-225 H.P. with large reverse gear
—CONTAINS—

Part #	Desc.	O.E.#
NSS	Forward Gear	5004216
NSS	Reverse Gear	336561



18-1293
GEAR SET
For: 20HP (1984-98), 25HP(1985-02),
30HP (1984-02) 35HP (1984-01)
—CONTAINS—

Part #	Desc.	O.E.#
18-1287	Forward Gear	392475
18-1289	Reverse Gear	327655
18-1288	Pinion	328313
18-1290	Clutch	337020



18-1288
PINION GEAR
Replaces: 328313
For: 25-35HP (1984-96)



18-2208
REVERSE GEAR
Replaces: 318304



18-2209
SLIDING CLUTCH
Replaces: 318303



18-2216
SLIDING CLUTCH
Replaces: 337772, 337774, 334516,
336562, 910995



18-2217
GEAR SET
—CONTAINS—

Part #	Desc.	O.E.#
NSS	Forward Gear	435020
NSS	Reverse Gear	910994
18-2216	Sliding Clutch	337772



18-2218
FORWARD GEAR SET
Replaces: 434063, 989966,
985050, 436746
Includes: Forward & Pinion Gears



18-2219
REVERSE GEAR
Replaces: 333077, 317838, 340490



18-2220
SLIDING CLUTCH
Replaces: 323664, 320630



18-2221
GEAR SET
—CONTAINS—

Part #	Desc.	O.E.#
18-2218	Forward Gear	434063
18-2219	Reverse Gear	333077
18-2220	Sliding Clutch	323664



18-2287
CLUTCH DOG
Replaces: 319895



18-2308
SLIDING CLUTCH
Replaces: 332491



18-1289
REVERSE GEAR
Replaces: 327655
For: 25-35HP (1984-96)



18-2309
REVERSE GEAR
Replaces: 332489



18-2290
GEAR SET
— CONTAINS —

Part #	Desc.	O.E.#
NSS	Forward Gear Set	435020, 434026, 983141, 391289
NSS	Reverse Gear	336561
18-2216	Sliding Clutch	337774, 334516, 336562, 910795, 337772



18-1290
CLUTCH DOG
Replaces: 337020
For: 25-35HP (1992-98)



18-2310
FORWARD GEAR SET
Replaces: 397627
Includes: Forward & Pinion Gears



18-2315
GEAR SET
— CONTAINS —

Part #	Desc.	O.E.#
18-2310	Forward Gear Set	397627
18-2309	Reverse Gear	332489
18-2308	Sliding Clutch	332491



18-1729
COVER & BUSHING ASSEMBLY
Replaces: 434588
For: 40HP (1993-02), 48HP (1993-96), 50HP (1993-02)



18-1500
INTAKE WATER SCREEN
Replaces: 337778
For: 100, 120, 125, 140, 150, 175, 200, 225 (1993) (OMC Cobra & V-6)



18-79989
TRAILERING STICKS
Fits: Most outboards over 150hp with three ram intrigrel tilt/trim.



18-1343
BEARING CARRIER RETAINING BAR
Replaces: 333957
For: 100, 120, 125, 140, 150, 175, 200, 225, (1988-92) (Cobra Drives)



18-1712
BEARING RETAINER
Replaces: 980014
For: 100, 120, 140, 165, 175, 190, 225, 235 (1968-77)



18-4807
DRIVESHAFT BEARING RETAINER CAP
Replaces: 439476
To replace bearing use **18-1344**



18-3766
SHIFT CRADLE
Replaces: 334163
For: V-4/V-6, Cobra, Stringer



18-3765
HOUSING PIN
Replaces: 331880
For: 18-3767 bearing housing



18-71102
CONTROL BOX REPAIR KIT
For: OMC 397272 + 390610



18-2243
18-2243-9①
DETENT BALL
Replaces: 316506
9.9 - 35 HP



18-2398
RETAINING SPRING
Replaces: 320311
For: 2 & 3 CYL.



18-2399
RETAINING SPRING
Replaces: 324369
For: V-4 & V-6

ALL FORWARD GEARS INCLUDE PINION GEARS

HP	Year	Model	Prop Shaft	Gear Set	Fwd. Gear	Rev. Gear	Clutch
20	1985-95	ALL		18-1293	18-1287 ⑩	18-1289	18-1290
25	1985-95	ALL		18-1293	18-1287 ⑩	18-1289	18-1290
25D	1989-95	ALL	18-2288	18-2315	18-2310	18-2309	18-2308
30	1984-96	ALL		18-1293	18-1287 ⑩	18-1289	18-1290
35	1984-94	ALL ①		18-1293	18-1287 ⑩	18-1289	18-1290
35	1987	AE, AR, AT	—	—	—	—	18-2287
40	1984-88	ALL	—	—	—	—	18-2287
40	1989-97	ALL	18-2288	18-2315	18-2310	18-2309	18-2308
48	1987-88	ALL	—	—	—	—	18-2287
48	1989-96	ALL	18-2288	18-2315	18-2310	18-2309	18-2308
50	1975	ALL	—	—	—	—	18-2287
50	1979-88	ALL	—	—	—	—	18-2287
50	1989-97	2 Cyl.	18-2288	18-2315	18-2310	18-2309	18-2308
50	1997	3 Cyl.	18-2250	—	—	18-2208	18-2209
55	1976-78	ALL	—	—	—	—	18-2287
60	1980-85	Electric Start	—	—	—	—	18-2287
60	1986-87	⑥	18-2250	—	—	18-2208	18-2209
60 ⑧	1986-87	3 Cyl.	—	—	—	—	18-2287
60	1988-97	ALL	18-2250	—	—	18-2208	18-2209
65	1984	ALL	18-2250	—	—	18-2208	18-2209
65	1987	ALL	18-2250	—	—	18-2208	18-2209
65	1990-91	ALL	18-2250	—	—	18-2208	18-2209
65 COMM	1985-97	ALL	18-2250	—	—	18-2208	18-2209
65 COMM Remote	1992-95	ALL	18-2250	—	—	18-2208	18-2209
65 COMM Rope	1992-95	ALL	18-2250	—	—	18-2208	18-2209
70	1975	①	N/A	—	—	18-2208	18-2209
70	1976	ALL	N/A	—	—	18-2208	18-2209
70	1977-85	⑥	18-2250	—	—	18-2208	18-2209
70 ⑧	1979-85	ALL	—	—	—	—	18-2287
70	1986-97	ALL	18-2250	—	—	18-2208	18-2209
70TTL	1992-95	ALL	18-2250	—	—	18-2208	18-2209
75 ⑧	1975-87	ALL	—	—	—	—	18-2287
75	1976	⑥	N/A	—	—	18-2208	18-2209
75	1977	⑥	18-2250	—	—	18-2208	18-2209
75	1978-80	□	18-2250	—	—	18-2208	18-2209
75	1982-87	⑥	18-2250	—	—	18-2208	18-2209
75	2000-01	FPX & FX	18-2251	18-1291	—	—	18-2216
85	1973-77	ALL	—	—	—	18-2219	—
85	1978-80	ALL	18-2252	18-2221	18-2218	18-2219	18-2220
85	1991-95	ALL	18-2252	18-2221	18-2218	18-2219	18-2220
88	1987-96	ALL	18-2252	18-2221	18-2218	18-2219	18-2220
90	1981-98 ②	ALL	18-2252	18-2221	18-2218	18-2219	18-2220
90	1995-01	25" Transoms	18-2251	18-1291	—	—	18-2216
90	1999	ALL	18-1725	18-2221	18-2218	18-2219	18-2220
100	1979-80,90-95	ALL	18-2252	18-2221	18-2218	18-2219	18-2220
100 COMM	1984-90	ALL	18-2187	—	—	—	18-2216
100 COMM	1989-90,1998	③	18-2252	18-2221	18-2218	18-2219	18-2220
100 COMM	1993-01	ALL	18-2251	18-1291	—	—	18-2216
105 JET	1992	ALL	18-2251	18-2217	—	—	18-2216
105	1997-99	ALL	18-2251	18-1291	—	—	18-2216
105 COMM	2000-01	ALL	18-2251	18-1291	—	—	18-2216
110	1986-89	ALL	18-2252	18-2221	18-2218	18-2219	18-2220

① Models with "E" suffix only ⑤ All models except "ESX"
 ② Models with " WTP" only ⑥ 20" Transom only
 ③ Models with "S" prefix only ⑦ All models except 140TX
 ④ Models "ESX" only ⑧ 15" Models
 ⑨ 1993 Models "ESX" "F" suffix only
 ⑩ Except 1999 "FCX" Models
 ⑪ Except 1998 "FSX" Models
 ⑫ Models with "F" suffix only
 ⑬ Models with "S" suffix only
 ⑭ Fits new style reverse gear with 6 clutch ears only
 ⑮ Except AE, AR & AT models
 ⑯ Pinion 18-1288 sold separately

ALL FORWARD GEARS INCLUDE PINION GEARS

HP	Year	Model	Prop Shaft	Gear Set	Fwd. Gear	Rev. Gear	Clutch
112	1994-96	ALL	18-2252	18-2221	18-2218	18-2219	18-2220
115	1973-76	ALL	—	—	—	18-2219	—
115	1977	ALL	18-2252	—	—	18-2219	18-2220
115	1978-85, 1990-98	ALL	18-2252	18-2221	18-2218	18-2219	18-2220
115	1995-01	25" Transoms	18-2251	18-1291	—	—	18-2216
115	1999	20" 60 degree V4	18-2252	18-2221	18-2218	18-2219	18-2216
115	1999	25" 60 degree V4	18-2251	—	—	—	18-2216
120	1985	ALL	—	—	—	—	18-2216
120	1986-92	ALL	18-2252	18-2221	18-2218	18-2219	18-2220
120	1993-94	TL & TX ⑦	18-2252	18-2221	18-2218	18-2219	18-2220
120	1993-94	TX ⑥	18-2251	18-1291	—	—	18-2216
125 COMM	1989-90	④	18-2252	18-2221	18-2218	18-2219	18-2200
125 COMM	1989-90	⑤	18-2187	—	—	—	18-2216
125 COMM	1992-94, 1996	⑤	18-2251	—	—	—	18-2216
125	1991	②	18-2251	—	—	—	18-2216
125	1991-95	④ ⑧	18-2252	18-2221	18-2218	18-2219	18-2220
125	1993-95	⑥	18-2251	18-1291	—	—	18-2216
125	1996-98	ALL	18-2251	18-1291	—	—	18-2216
130	1995-01	TL & TX & 25"	18-2251	18-1291	—	—	18-2216
135	2001	ALL	18-2251	18-1291	—	—	18-2216
140	1977	ALL	18-2252	—	—	—	18-2220
140	1978-84, 1986-87	ALL	18-2252	18-2221	18-2218	18-2219	18-2220
140	1985	ALL	18-2187	—	—	—	18-2216
140	1988-94	⑦	18-2252	18-2221	18-2218	18-2219	18-2220
140	1988-90	TX	18-2187	—	—	—	18-2216
140	1993-94	TX ⑥	18-2251	18-1291	N/A	N/A	18-2216
150	1978-79	ALL	—	—	—	—	18-2216 □
150	1980-87	CHECK O.E.	18-2187	18-2217	—	—	18-2216
150	1988-89,90	ALL	18-2187	18-2217	—	—	18-2216
150	1991-99 ①	ALL	18-2251	18-2290	—	—	18-2216
150	2004	ALL	18-2251	18-1292	N/A	N/A	18-2216
150 COMM	1993-96	ALL	18-2251	18-2290	—	—	18-2216
155 COMM	1984-88	ALL	18-2187	—	—	—	18-2216
155 COMM WTP	1986-88	ALL	18-2187	—	—	—	18-2216
155 COMM							
WTL & WTX	1989-90	ALL	18-2187	—	—	—	18-2216
155 COMM	1989-90	②	18-2187	18-2217	—	—	18-2216
155 COMM	1991-92	ALL	18-2251	18-2290	—	—	18-2216
175	1977	ALL	—	N/A	N/A	N/A	18-2220
175	1978-83	ALL	—	—	—	—	18-2216 □
175	1985-90	ALL	18-2187	18-2217	—	—	18-2216
175/185	1991-99 ①	ALL	18-2251	18-2290	—	—	18-2216
185	1984-85	ALL	18-2187	18-2217	—	—	18-2216
200	1979-86	ALL	—	18-2217	—	—	18-2216
200	1988-90	ALL	18-2187	18-2217	—	—	18-2216
200	1991-99	ALL	18-2251	18-2290	—	—	18-2216
200	2002-03	ALL	18-2251	18-1292	N/A	N/A	18-2216
220	1987	ALL	18-2187	18-2217	—	—	18-2216
225	1986-87	ALL	—	18-2217	—	—	18-2216
225	1988-89	ALL	18-2187	18-2217	—	—	18-2216
225	1991-99	ALL	18-2251	18-2290	—	—	18-2216
225	2002-04	ALL	18-2251	18-1292	N/A	N/A	18-2216

② Models with "WTP" only
 ③ Models with "S" prefix only
 ④ Models "ESX" only
 ⑤ All models except "ESX"

⑥ 20" Transom only
 ⑦ All models except 140TX
 ⑧ 15" Models
 ⑨ 1993 Models "ESX" "F" suffix only

① Except 1999 "FCX" Models
 ② Except 1998 "FSX" Models
 ③ Models with "F" suffix only
 ④ Models with "S" suffix only

⑤ Fits new style reverse gear with 6 clutch ears only
 ⑥ Except AE, AR & AT models
 ⑦ Pinion 18-1288 sold separately

ALL FORWARD GEARS INCLUDE PINION GEARS

HP	Year	Model	Prop Shaft	Gear Set	Fwd. Gear	Rev. Gear	Clutch
235	1979-85	ALL	—	18-2217	—	—	18-2216
250	1991-99	ALL	18-2251	—	—	—	18-2216
250	2002-03	ALL	18-2251	18-1292	N/A	N/A	18-2216
275	1985-88	ALL	18-2251	—	—	—	18-2216
3.6L	1985-87	ALL	18-2251	—	—	—	18-2216
300	1988-95	ALL	18-2251	—	—	—	18-2216

- ① Models with "E" suffix only
- ② Models with "WTP" only
- ③ Models with "S" prefix only
- ④ Models "ESX" only
- ⑤ All models except "ESX"
- ⑥ 20" Transom only
- ⑦ All models except 140TX
- ⑧ 15" Models
- ⑨ 1993 Models "ESX" "F" suffix only
- ⑩ Except 1999 "FCX" Models
- ⑪ Except 1998 "FSX" Models
- ⑫ Models with "F" suffix only
- ⑬ Models with "S" suffix only
- ⑭ Fits new style reverse gear with 6 clutch ears only
- ⑮ Except AE, AR & AT models
- ⑯ Pinion 18-1288 sold separately

SEA DRIVE SHAFTS AND GEARS

HP	Year	Model	Prop Shaft	Gear Set	Fwd. Gear	Rev. Gear	Clutch
1.6	1990 ①	ALL	18-2252	18-2221	18-2218	18-2219	18-2220
2	1990 ②	ALL	18-2187	—	—	—	18-2216
2	1990 ①	ALL	18-2187	—	—	—	18-2216
3	1990 ①	ALL	18-2187	18-2217	—	—	18-2216
3	1990	ALL	18-2187	18-2217	—	—	18-2216
4	1990	ALL	18-2187	—	—	—	18-2216
1.6	1989	ALL	18-2252	18-2221	18-2218	18-2219	18-2220
2	1989	ALL	18-2187	—	—	—	18-2216
3	1989	ALL	18-2187	18-2217	—	—	18-2216
4	1989	ALL	18-2187	—	—	—	18-2216
1.6	1988	ALL	18-2252	18-2221	18-2218	18-2219	18-2220
2	1988	ALL	18-2187	—	—	—	18-2216
3	1988	ALL	18-2187	18-2217	—	—	18-2216
1.6	1987	ALL	18-2252	18-2221	18-2218	18-2219	18-2220
1.8	1987	ALL	18-2252	18-2221	18-2218	18-2219	18-2220
2.7	1987	ALL	18-2187	18-2217	—	—	18-2216
3.6	1987	ALL	18-2187	—	—	—	18-2216
1.6	1986	ALL	18-2252	18-2221	18-2218	18-2219	18-2220
2.6	1986	ALL	18-2187	18-2217	—	—	18-2216
1.6 V-4	1985 ③	ALL	18-2252	18-2221	18-2218	18-2219	18-2220
2.6 V-6	1985 ④	ALL	18-2187	—	—	—	18-2216
2.5/2.6	1985 ③	ALL	18-2187	—	—	—	18-2216
1.6 V-4	1984 ③	ALL	18-2252	18-2221	18-2218	18-2219	18-2220
2.6 V-6	1984 ④	ALL	18-2187	—	—	—	18-2216
2.5/2.6	1984 ③	ALL	18-2187	—	—	—	18-2216
1.6	1983	ALL	18-2252	18-2221	18-2218	18-2219	18-2220
2.6	1983	ALL	N/A	—	—	—	18-2216
2.5/2.6	1982	ALL	—	—	—	—	18-2216

- ① Models with "E" suffix only
- ② Models with "WTP" only
- ③ Models with "S" prefix only
- ④ Models "ESX" only



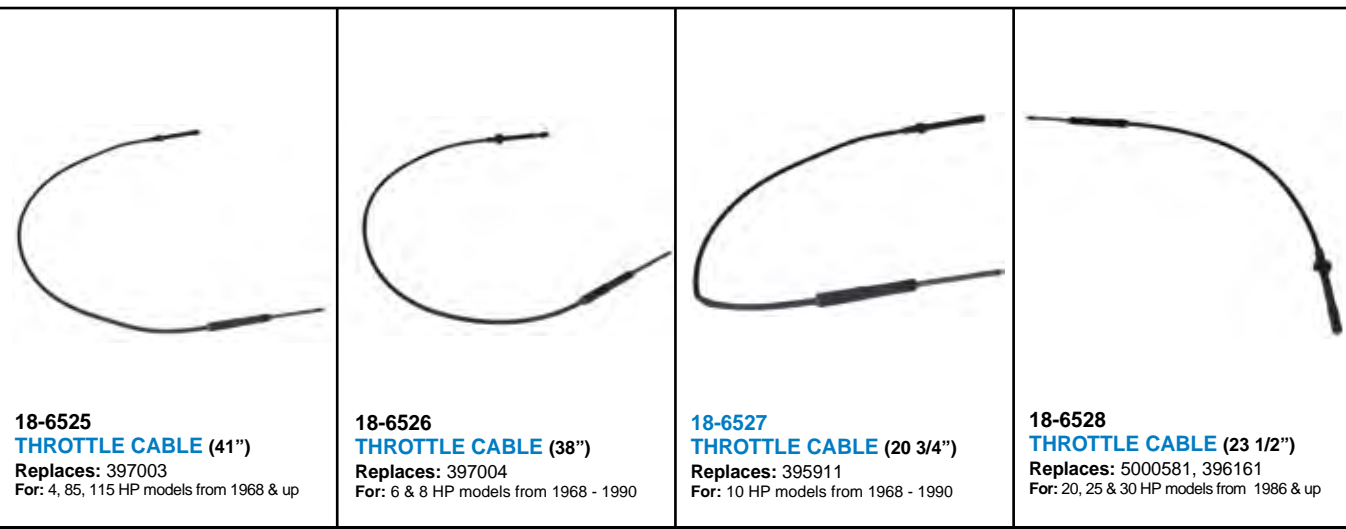

18-6525
THROTTLE CABLE (41")
 Replaces: 397003
 For: 4, 85, 115 HP models from 1968 & up

18-6526
THROTTLE CABLE (38")
 Replaces: 397004
 For: 6 & 8 HP models from 1968 - 1990

18-6527
THROTTLE CABLE (20 3/4")
 Replaces: 395911
 For: 10 HP models from 1968 - 1990

18-6528
THROTTLE CABLE (23 1/2")
 Replaces: 5000581, 396161
 For: 20, 25 & 30 HP models from 1986 & up

THROTTLE CABLE APPLICATION

HP	Year Start	Year Stop	Throttle Cable	HP	Year Start	Year Stop	Throttle Cable
4	1987	1996	18-6525	25	1986	1989	18-6528
6	1985	1990	18-6526	25	1999	2005	18-6528
8	1985	1990	18-6526	30	1986	1989	18-6528
9.9	1986	1992	18-6527	30	1999	2005	18-6528
14	1988	1989	18-6526	35	1986	1989	18-6528
15	1986	1992	18-6527	85	1991	1995	18-6525
20	1986	1989	18-6528	115	1994	1995	18-6525

SHIMS

	Part #	Desc.	O.E. #	I.D.	Part #	Desc.	O.E. #	I.D.
	18-1718 ^②	Kit	-		18-2229 ^{① ③}	.003 Shim	323362	1.24
	18-2224 ^③	.003 Shim	320166	1.58	18-2230	.004 Shim	323361	1.24
	18-2225 ^③	.004 Shim	320167	1.56	18-2231	.005 Shim	314745	1.24
	18-2226 ^③	.005 Shim	320168	1.53	18-2232	.003 Shim	323889	1.22
	18-2227 ^③	.006 Shim	320169	1.53	18-2233	.004 Shim	323890	1.22
	18-2228	.007 Shim	320170	1.53	18-2234 ^{① ③}	.005 Shim	317232	.22

HP	Year	0.003 Shim	0.004 Shim	0.005 Shim	0.006 Shim	0.007 Shim
60	1980-1987	18-2224	18-2225	18-2226	18-2227	18-2228
60	1988-95	18-2232	18-2233	18-2234	—	—
60SST	1989-1990	18-2224	18-2225	18-2226	18-2227	18-2228
60TTL	1992	18-2232	18-2233	18-2234	—	—
65C	1984-91,93-95	18-2232	18-2233	18-2234	—	—
65C	1992	18-2232	18-2233	18-2234	—	—
70	1975-76	18-2232	18-2233	18-2234	—	—
70	1977-85	18-2224	18-2225	18-2226	18-2227	18-2228
70	1986-95	18-2232	18-2233	18-2234	—	—
70TTL	1992	18-2232	18-2233	18-2234	—	—
75	1975-1988	18-2224	18-2225	18-2226	18-2227	18-2228

① STD PKG OF 2 ② Includes 1 each of 18-2229, 18-2230 & 18-2231
 ③ This product is priced per piece. To order priced per package, please add -9 to the part number

APPLICATION CONTINUED ON NEXT PAGE

HP	Year	0.003 Shim	0.004 Shim	0.005 Shim	0.006 Shim	0.007 Shim
85	1975-79	18-2229	18-2230	18-2231	—	—
85	1980,91	18-2229	18-2230	18-2231	—	—
85TTL	1992-95	18-2229	18-2230	18-2231	—	—
88	1987-95	18-2229	18-2230	18-2231	—	—
90	1981-95	18-2229	18-2230	18-2231	—	—
100	1979	18-2229	18-2230	18-2231	—	—
100	1980,90-95	18-2229	18-2230	18-2231	—	—
100C	1984-87,89-95	18-2229	18-2230	18-2231	—	—
100PLY	1989	18-2229	18-2230	18-2231	—	—
105JET	1992-93	18-2229	18-2230	18-2231	—	—
110	1986-89	18-2229	18-2230	18-2231	—	—
115	1980-85,90-95	18-2229	18-2230	18-2231	—	—
115	1975-79	18-2229	18-2230	18-2231	—	—
120	1985-95	18-2229	18-2230	18-2231	—	—
125, 125C	1989-95	18-2229	18-2230	18-2231	—	—
125ESX	1989-90	18-2229	18-2230	18-2231	—	—
125WTPL	1990	18-2229	18-2230	18-2231	—	—
135	1975-76	18-2229	18-2230	18-2231	—	—
140	1977-79	18-2229	18-2230	18-2231	—	—
140	1980-95	18-2229	18-2230	18-2231	—	—
150	1979-95	18-2229	18-2230	18-2231	—	—
150C	1986-91,95	18-2229	18-2230	18-2231	—	—
155C	1984-87,89-95	18-2229	18-2230	18-2231	—	—
175	1977	18-2229	18-2230	18-2231	—	—
175	1978-88,90-95	18-2229	18-2230	18-2231	—	—
185	1984-85,90-95	18-2229	18-2230	18-2231	—	—
200	1976-77	18-2229	18-2230	18-2231	—	—
200	1978-83,86-95	18-2229	18-2230	18-2231	—	—
200C	1990	18-2229	18-2230	18-2231	—	—
225	1986-93	18-2229	18-2230	18-2231	—	—
235	1978-85	18-2229	18-2230	18-2231	—	—
1600cc	1988	18-2229	18-2230	18-2231	—	—
2500cc	1988	18-2229	18-2230	18-2231	—	—

① STD PKG OF 2 ② Includes 1 each of 18-2229, 18-2230 & 18-2231

③ This product is priced per piece. To order priced per package, please add -9 to the part number

Zinc is for saltwater only applications.
Magnesium is for fresh water only applications.
Aluminum is for brackish water, or if boat is used in both fresh and salt environments.



③ **18-6115**
ANODE TRANSOM BRACKET
Replaces: 433580
For: 60-225 (1991-93)
For use on Stern Bracket



③ **18-6017**
① **18-6017A**
② **18-6100**
ANODE
Replaces: 173029, 123009
(1981-91) 9.9-115 HP
For use on gearcase and transom bracket assembly



18-6018
ANODE
Replaces: 327606
1983-89 2HP, For Motor Leg



③ **18-6024**
① **18-6024A**
ANODE
Replaces: 393023, 436745
(1982-87) 60-300 HP
For use on gearcases



③ **18-6025**
ANODE
Replaces: 433458, 398331
(1987-92) 60-300HP
For use on Stern Bracket



② **18-6026**
ANODE
Replaces: 392462
For exhaust housing,
2 & 3 Cyl. (1984-99)



③ **18-6095**
① **18-6095A**
ANODE
Replaces: 431708
(1988-90) 45-300 HP
For use on Prop Shaft Bearing Carrier



③ **18-6020**
ANODE
Replaces: 976669
(1969-89)
Kit for V4 & V6



③ **18-6027**
ANODE
Replaces: 392123
(1982-98) 40-300 HP
Front Lower Leg Extension

① Aluminum ② Magnesium ③ Zinc

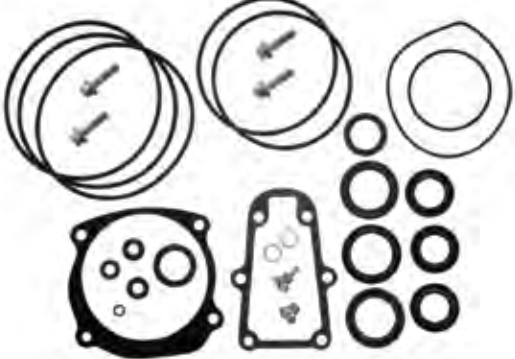

18-2623
LOWER UNIT SEAL KIT
Replaces: 439141

— CONTAINS —

Part #	Desc.	O.E. #	Qty.
18-0110	Shift Housing Gasket	314082	1
18-2001	Seal	330137	2
18-2002	Seal	320862	2
18-2026	Seal	321453	2
18-2061	Seal	329922	1
18-2062	Seal	329923	1
18-2377	Screw	316563	4
18-2378	Magnetic Drain Screw	318544	1
18-2536	O-Ring	315788	1
18-2557	Impeller Gasket	338484	1
18-4248	Washer	311598	2
18-7109	O-Ring	317178	1
18-7120	O-Ring	307853	1
18-7127	O-Ring	313446	1
18-7130	O-Ring	314728	1
18-7133	O-Ring	305123	2
18-7137	O-Ring	318372	2
18-7142	O-Ring	322119	1
18-7144	O-Ring	333572	3
18-7145	O-Ring	332584	1
18-7475	Washer	328743	4
18-8300	Seal	341280	1
18-8301	Seal	341281	1



18-2656
LOWER UNIT SEAL KIT
Replaces: 396350

— CONTAINS —

Part #	Desc.	O.E. #	Qty.
18-2025	Oil Seal	318971	1
18-2028	Oil Seal	321480	2
18-2029	Oil Seal	321481	2
18-4248	Washer	311598	2
18-7100	O-Ring	301877	1
18-7104	O-Ring	308627	1
18-7120	O-Ring	307853, 322598	1
18-7139	O-Ring	319085	1
18-7145	O-Ring	333572	2

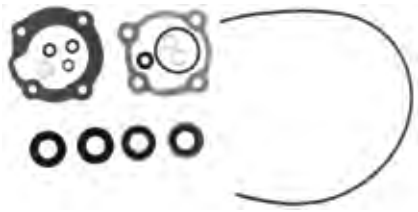

18-2657
LOWER UNIT SEAL KIT
Replaces: 396352

— CONTAINS —

Part #	Desc.	O.E. #	Qty.
18-0882	Shift Rod Gasket	304764	1
18-0108	Lower Gearcase Gasket	324449	1
18-3360	Impeller Housing Gasket	329390	1
18-7411	O-Ring	—	1
18-2027	Oil Seal	321459	2
18-2031	Oil Seal	321787	1
18-2063	Oil Seal	330327	1
18-4248	Washer	311598	2
18-7100	O-Ring	301877	1
18-7145	O-Ring	333572	2
18-7475	Quad Ring	332583	1

18-2658
LOWER UNIT SEAL KIT
 Replaces: 396351



— CONTAINS —

Part #	Desc.	O.E. #	Qty.
18-0124	Impeller Plate Gasket	325537	1
18-2026	Oil Seal	321453	2
18-2033	Oil Seal	321928	1
18-2065	Oil Seal	332261	1
18-2539	Rubber Seal	328753	1
18-4248	Washer	311598	2
18-7100	O-Ring	301877	1
18-7105	O-Ring	311338	2
18-7108	O-Ring	313893	1
18-7109	O-Ring	317178	3
18-7145	O-Ring	333572	2
18-7146	O-Ring	554545	1
18-7180	O-Ring	303347	1
18-2030	Oil Seal	321786	1
18-2027	Oil Seal	321459	1

18-2659
LOWER UNIT SEAL KIT
 Replaces: 396355



— CONTAINS —

Part #	Desc.	O.E. #	Qty.
18-0969	Impeller Housing Gasket	319586	1
18-2059	Oil Seal	321466	1
18-2060	Oil Seal	321467	2
18-2064	Oil Seal	332205	1
18-2532	Foam Seal	305762	1
18-2537	Rubber Seal	324937	1
18-2855	Shift Housing Cover to Gear Case Gasket	314082	1
18-4248	Washer	311598	2
18-7115	O-Ring	302588	1
18-7120	O-Ring	307853	1
18-7137	O-Ring	318372	1
18-7140	O-Ring	320303	1
18-7145	O-Ring	333572	2
18-7475	Quad Ring	332584	3

18-2660
LOWER UNIT SEAL KIT
 Replaces: 396349

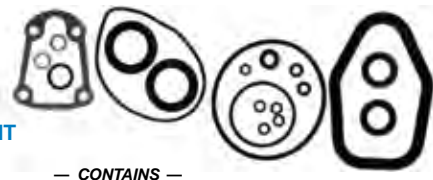

— CONTAINS —

Part #	Desc.	O.E. #	Qty.
18-2059	Oil Seal	321466	1
18-2064	Oil Seal	332205	1
18-2537	Rubber Seal	324937	1
18-2855	Shift Housing Cover to Gearcase Gasket	314082	1
18-4248	Washer	311598	2
18-7120	O-Ring	307853	1
18-7127	O-Ring	313446	1
18-7128	O-Ring	313754	1
18-7137	O-Ring	318372	1
18-7145	O-Ring	333572	2
18-7475	Quad Ring	332584	4
18-7174	O-Ring	910582, 326649	1
18-2001	Oil Seal	330137	2

18-2679
LOWER UNIT SEAL KIT



— CONTAINS —

Part #	Desc.	O.E. #	Qty.
18-2022	Oil Seal	303345	1
18-2035	Oil Seal	327031	1
18-2891	Bearing Housing Gasket	303339	1
18-4248	Washer	311598	2
18-7100	O-Ring	301877	1
18-7117	O-Ring	303360	1
18-7120	O-Ring	307853	1
18-2534	Spaghetti Seal	309044	1

18-2680
LOWER UNIT SEAL KIT



— CONTAINS —

Part #	Desc.	O.E. #	Qty.
18-2023	Oil Seal	313282	1
18-2035	Oil Seal	327031	1
18-2891	Bearing Housing Gasket	303339	1
18-4248	Washer	311598	2
18-7100	O-Ring	301877	1
18-7117	O-Ring	303360	1
18-7120	O-Ring	307853	1
18-2534	Spaghetti Seal	309044	1

18-2681
LOWER UNIT SEAL KIT



— CONTAINS —

Part #	Desc.	O.E. #	Qty.
18-2023	Oil Seal	313282	1
18-2024	Oil Seal	314167	1
18-2891	Bearing Housing Gasket	303339	1
18-4248	Washer	311598	2
18-7100	O-Ring	301877	1
18-7117	O-Ring	303360	1
18-7120	O-Ring	307853	1
18-2534	Spaghetti Seal	309044	1

18-2682
LOWER UNIT SEAL KIT

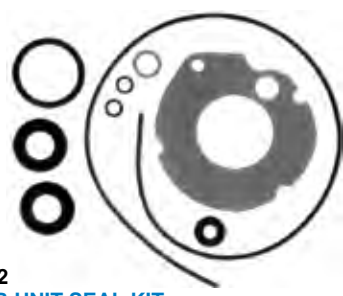

— CONTAINS —

Part #	Desc.	O.E. #	Qty.
18-2022	Oil Seal	303345	2
18-2891	Bearing Housing Gasket	303339	1
18-4248	Washer	311598	2
18-7100	O-Ring	301877	1
18-7117	O-Ring	303360	1
18-7120	O-Ring	307853	1
18-2534	Spaghetti Seal	309044	1

18-2683
LOWER UNIT SEAL KIT



— CONTAINS —

Part #	Desc.	O.E. #	Qty.
18-2023	Oil Seal	313282	2
18-2891	Bearing Housing Gasket	303339	1
18-4248	Washer	311598	2
18-7100	O-Ring	301877	1
18-7117	O-Ring	303360	1
18-7120	O-Ring	307853	1
18-2534	Spaghetti Seal	309044	1

18-2684
LOWER UNIT SEAL KIT



— CONTAINS —

Part #	Desc.	O.E. #	Qty.
18-0882	Shift Rod Gasket	304764	1
18-2032	Oil Seal	321788	1
18-4248	Washer	311598	2
18-7100	O-Ring	301877	1
18-7120	O-Ring	307853	1
18-2031	Oil Seal	321787	1
18-2534	Spaghetti Seal	309044	1

18-2685
LOWER UNIT SEAL KIT



— CONTAINS —

Part #	Desc.	O.E. #	Qty.
18-2030	Oil Seal	321786	3
18-2031	Oil Seal	321787	1
18-4248	Washer	311598	2
18-7100	O-Ring	301877	1
18-7112	O-Ring	302493	1
18-7120	O-Ring	307853	1
18-2534	Spaghetti Seal	309044	1
18-0882	Shift Rod Gasket	304764	1



18-2686
LOWER UNIT SEAL KIT

— CONTAINS —

Part #	Desc.	O.E. #	Qty.
18-0882	Shift Rod Gasket	304764	1
18-2005	Oil Seal	313284	1
18-2021	Oil Seal	302564	1
18-4248	Washer	311598	2
18-7100	O-Ring	301877	1
18-7115	O-Ring	302588	1
18-7120	O-Ring	307853, 322598	1

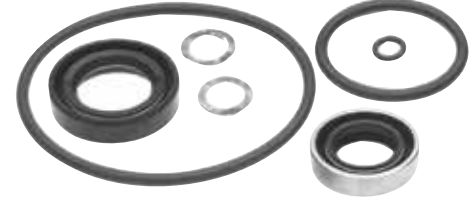

18-2687
LOWER UNIT SEAL KIT

— CONTAINS —

Part #	Desc.	O.E. #	Qty.
18-2005	Oil Seal	313284	1
18-4248	Washer	311598	2
18-7120	O-Ring	307853, 322598	1
18-7152	O-Ring	307082	1
18-2027	Oil Seal	321459	1
18-7143	O-Ring	322501	1
18-0173	Oil Seal	313283	1
18-7428	Rubber Seal	307103	1



18-2688
LOWER UNIT SEAL KIT

— CONTAINS —

Part #	Desc.	O.E. #	Qty.
18-2027	Oil Seal	321459	2
18-2855	Shift Housing Cover to Gearcase Gasket	314082	1
18-4248	Washer	311598	2
18-7100	O-Ring	301877	1
18-7109	O-Ring	317178	4
18-7127	O-Ring	313446	1
18-7128	O-Ring	313754	1
18-2001	Oil Seal	330137	2
18-7129	O-Ring	314491	1

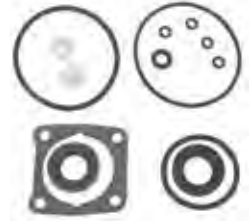

18-2689
LOWER UNIT SEAL KIT

— CONTAINS —

Part #	Desc.	O.E. #	Qty.
18-0173	Oil Seal	313283	1
18-0174	Oil Seal	326716	1
18-0886	Lower Gearcase Gasket	307099	1
18-4248	Washer	311598	2
18-7115	O-Ring	302588	1
18-7118	O-Ring	305242	1
18-7120	O-Ring	307853, 322598	4
18-7152	O-Ring	307082	1
18-7428	O-Ring	307103	1



18-2690
LOWER UNIT SEAL KIT

— CONTAINS —

Part #	Desc.	O.E. #	Qty.
18-2855	Shift Housing Cover to Gearcase Gasket	314082	1
18-2874	Solenoid Cover Gasket	314876	1
18-4248	Washer	311598	2
18-7120	O-Ring	307853, 322598	4
18-7127	O-Ring	313446	1
18-7129	O-Ring	314491	1
18-7130	O-Ring	314728	1
18-7126	O-Ring	313340	1

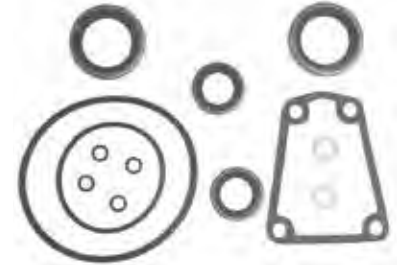

18-2691
LOWER UNIT SEAL KIT

— CONTAINS —

Part #	Desc.	O.E. #	Qty.
18-2874	Solenoid Cover Gasket	314876	1
18-4248	Washer	311598	2
18-7109	O-Ring	317178	4
18-7127	O-Ring	313446	1
18-2001	Oil Seal	330137	2
18-7130	O-Ring	314728	1
18-2059	Oil Seal	321466	2



18-2692
LOWER UNIT SEAL KIT

— CONTAINS —

Part #	Desc.	O.E. #	Qty.
18-0110	Shift Housing Gasket	324670	1
18-2026	Oil Seal	321453	2
18-2874	Solenoid Cover Gasket	314876	1
18-4248	Washer	311598	2
18-7109	O-Ring	317178	4
18-7120	O-Ring	322598	1
18-7127	O-Ring	313446	1
18-7130	O-Ring	314728	1
18-7137	O-Ring	318372	1
18-2001	Oil Seal	330137	2



18-2694
LOWER UNIT SEAL KIT
Replaces: 433550

— CONTAINS —

Part #	Desc.	O.E. #	Qty.	Part #	Desc.	O.E. #	Qty.
18-2709	Wear Plate Gasket	336530	1	18-7481	Seal	315788	1
18-7115	O-Ring	302588	1	18-2708	Seal	333758	1
18-7127	O-Ring	313446	1	18-2059	Oil Seal	321466	2
18-7120	O-Ring	307853, 322598	1	18-2018	Oil Seal	0767970	2
18-7172	O-Ring	553126	1	18-2064	Oil Seal	332205	1
18-7137	O-Ring	318372	1	18-2705	Seal	315748	1
18-7475	O-Ring	332584	1	18-4248	Washer	311598	1
				18-7173	O-Ring	310327, 910582	1



**18-8383
SEAL KIT**

Replaces: 5000309
For: E-Tec 40, 50, 60 HP



**18-8384
SEAL KIT**

Replaces: E-Tec
5006373
For: E-Tec 75/90/115/150/175/200/225/250 HP



**18-8387
LOWER UNIT SEAL KIT**

Replaces: 5007987
For: E-Tec 15, 25, 30 (2010 & Up)



**18-8337
LOWER UNIT SEAL KIT**

Replaces: 5031456
For: 40/50 HP 4 stroke (1999-2003)

— CONTAINS —

Part #	Desc.	O.E. #	Qty.
18-0461	Water Pump Gasket	—	1
18-7151	O-Ring	—	1
18-7413	O-Ring	303191	2
18-8331	Drain Plug Gasket	—	3
18-8334	Shift Shaft Seal	—	1
18-8345	Seal	—	2



**18-74108
GEAR HOUSING SEAL KIT**

Replaces: 5030973
Fits: Johnson Evinrude 60/70 4-Stroke

GEAR HOUSING SEAL KITS APPLICATION

Model	Year	Seal Kit	Model	Year	Seal Kit		
5.5	⑧	1955-67	18-2679	85	1991-95	18-2623	
6	⑧	1955-67	18-2679	88	1985-Up	18-2623	
6	⑨	1967-68	18-2680	90 (Elect.)	1964-65	18-2689	
6	⑩	1968-79	18-2681	90 (V-4)	1973-83	18-2692	
7.5	⑧	1955-67	18-2679	90	1985-Up	18-2623	
9.5 (M Suffix)		1964-67	18-2682	100 (Large Prop Shaft)	1971-72	18-2691	
9.5 (B Suffix)		1967-73	18-2683	100 (V-4)	1973-83	18-2692	
9.9/15		1974-Up	18-2656	100 (Comm)	1984-90	18-2623	
9.9/15 (4 Stroke)		1974-Up	18-2656	100 (Comm)	1991-95	18-2623	
10		1958-67	18-2682	100	③	1991-92	18-2623
18		1958-73	18-2684	110 (V-4)	1973-83	18-2692	
20		1966-73	18-2684	110	1985-89	18-2623	
20		1979-82	18-2684	115 (Small Prop Shaft)	1969-71	18-2690	
20		1985-Up	18-2658	115 (V-4)	1973-83	18-2692	
25		1955-59	18-2686	115	1985-Up	18-2623	
25		1968-78	18-2684	120	1985	18-2623	
25		1979-82	18-2685	120	1986-92	18-2623	
25		1984	18-2657	120	1993	18-2623	
25		1985-Up	18-2658	125 (Large Prop Shaft)	1971-72	18-2691	
25	①	1990-95	18-2694	125	④	1991-92	18-2623
25 (Comm)		1985-Up	18-2657	125	1993	18-2623	
28		1962-70	18-2686	125 (Comm)	1991-93	18-2623	
28		1985-98	18-2657	135 (V-4)	1973-83	18-2692	
30		1955-59	18-2686	140 (V-4)	1973-83	18-2692	
30		1976-95	18-2658	140	1985	18-2623	
33		1962-70	18-2686	140	⑤	1986-92	18-2623
35		1955-59	18-2686	140	⑥	1992-93	18-2623
35		1977-92	18-2658	140	①	1992-95	18-2623
40 (Manual Shift)		1960-73	18-2686	150 (V-6)	1978-86	18-2623	
40 (Elect. Shift)		1962-70	18-2687	150	⑦	1991	18-2623
40		1976-88	18-2659	150		1991-95	18-2623
40		1989-Up	18-2694	155 (Comm)	1984-90	18-2623	
48		1976-88	18-2659	155 (Comm)	1991-93	18-2623	
48		1989-96	18-2694	175 (V-6)	1977-86	18-2623	
50		1971-74	18-2688	175	②	1991	18-2623
50		1976-88	18-2659	175	⑦	1992	18-2623
50		1989-Up	18-2694	175		1991-95	18-2623
50 (3 cyl.)		1995-Up	18-2660	185		1991-93	18-2623
55		1968-69	18-2690	200 (V-6)	1976-86	18-2623	
55		1976-88	18-2659	200	1991-95	18-2623	
60 (Manual/Elect.)		1960-68	18-2689	225	1991-95	18-2623	
60		1970-71	18-2690	235 (V-6)	1977-86	18-2623	
60 (2 cyl.)		1976-88	18-2659	V-8	⑦	1985-91	18-2623
60 (3 cyl.)		1978-Up	18-2660	250 (V-8)	1991-95	18-2623	
65 (Manual/Elect.)		1960-68	18-2689	300 (V-8)	1991-95	18-2623	
65		1978-Up	18-2660				
70		1978-Up	18-2660				
75 (Manual/Elect.)		1960-68	18-2689	OMC SEA DRIVE			
75		1978-91	18-2660	1.6L	1985-90	18-2623	
75 (Small Gearcase)		1976-88	18-2659	1.8L	1987	18-2623	
V-4		1978-84	18-2623	2.0L	1988-90	18-2623	
85 (Manual/Elect.)		1968	18-2689	2.5L	1984-85	18-2623	
85 (Small Prop Shaft)		1969-71	18-2690	2.6L	1984-86	18-2623	
85 (Large Prop Shaft)		1971-72	18-2691	2.7L	1987	18-2623	
85 (V-4)		1973-83	18-2692	3.0L	1988-90	18-2623	
				3.6L	1987	18-2623	
				4.0L	1989-90	18-2623	

① "D" Suffix Only
② Models "GL" & "EX" only
③ 1992 Models except WTLNE, WTXENE
④ 1992 ESX Models only

⑤ 1992 TL Models only
⑥ CX Models only
⑦ 1992 Counter Rotation
⑧ 1967 "D" Suffix Only

⑨ 1967 "S" Suffix Only
1968 "C" Suffix Only
⑩ 1968 "A" & "R" Suffixes Only
① TX & Counter Rotation Models



18-2595
SHIFT ROD & WEAR PLATE GASKET SET
 Replaces: 982132

18-2595 SHIFT ROD & WEAR PLATE GASKET SET APPLICATION					
HP	YEARS	HP	YEARS	HP	YEARS
85	1978-80	120	1985-90	200	1976-90
88	1987-90	125	1989-90	225	1986-90
90	1981-90	140	1977-90	235	1978-85
100	1979-90	150	1978-90	275	1985-90
100C	1984-89	155C	1984-90	3.6L	1985-90
110	1986-89	175	1977-90	300	1985-90
115	1978-90	185	1984-90		

OIL SEALS



Part #	O.E. #	Shaft Size	Dimensions (in)		Part #	O.E. #	Shaft Size	Dimensions (in)	
			O.D.	Width				O.D.	Width
18-0173	313283	0.795	1.320	0.307	18-2059	318223, 321466	0.750	1.126	0.200
18-0174	326716	0.750	1.382	0.242	18-2060	303804, 321467	1.000	1.375	0.250
18-0542	321831, 315288	0.750	1.253	0.186	18-2061	329922	0.822	1.375	0.195
18-0543	321895,	1.540	1.926	0.243	18-2062	329923	0.875	1.375	0.207
	313507				18-2063	330327	0.625	1.124	0.188
18-0559	332585	0.285	0.357	0.940	18-2064	332205	0.730	1.130	0.194
18-2000	309989	1.375	2.000	0.313	18-2065	332261	0.625	1.375	0.195
18-2001	330137	1.125	1.624	0.250	18-2066	911019	1.000	1.375	0.435
18-2002	320862	1.188	1.692	0.250	18-2067	911685	2.000	2.509	0.315
18-2005	313284	0.625	1.128	0.250	18-2068	911701	0.500	0.905	0.250
18-2012	310599	1.000	1.499	0.250	18-2068	915702	0.500	0.905	0.250
18-2016	313992	1.187	1.875	0.250	18-2068	916058	0.500	0.905	0.250
18-2018	305987	1.000	1.375	0.250	18-2068	3853655	.500	.905	.250
18-2020	310649	2.500	3.000	0.250	18-2071	981195	1.500	2.125	0.250
18-2021	313258	0.750	1.375	0.250	18-2072	981196	1.750	2.502	0.250
18-2022	303345	0.554	1.000	0.375	18-2073	981268	1.625	2.502	0.250
18-2023	313282	0.554	1.062	0.312	18-2074	318451, 339620	1.625	2.125	0.250
18-2024	314167	0.425	0.937	0.312	18-2075	353076, 326751	1.562	2.062	0.300
18-2025	318972	0.500	0.875	0.250	18-8300	341280	0.866	1.378	0.280
18-2026	317843, 321453	0.875	1.250	0.188	18-8301	341281	1.220	1.693	0.280
18-2027	305306, 321459	0.625	1.125	0.250	18-8304	321830	20.37mm	31.8mm	6.35mm
18-2028	318973	0.500	1.250	0.188	18-8307	331103	1.100	1.628	0.448
18-2029	319256, 321481	0.687	1.250	0.250	18-8325	342786	28mm	41.5mm	7/11
18-2030	321786	0.625	1.125	0.188	18-8326	342787	18mm	29mm	8/12
18-2031	321787	0.625	1.125	0.312		911795			
18-2032	321788	0.500	1.000	0.188	18-8349	3852548	1.375	2.186	0.500
18-2033	321928	0.625	1.375	0.250	18-8350	328603	1.100	1.690	0.320
18-2034	324639	0.437	0.937	0.188	18-8351	321504, 308500	1.110	1.570	0.320
18-2035	300599, 327031	0.425	0.875	0.313	18-8367	334950	1.250	1.687	0.250
18-2058	313353	1.938	2.438	0.250					

OIL SEAL APPLICATION

HP	YEARS	PROPSHAFT	QTY.	DRIVESHAFT	QTY.	UPPER CRANKCASE	QTY.	LOWER CRANKCASE	QTY.
1.5,2,2.5,3	1958-68	-	1	18-2035	1	-	-	-	-
1.5,2	1968-90	18-2035	1	18-2035	1	-	-	-	-
2.5,4	② 1973-80	18-2035	1	18-2035	2	-	-	-	-
2.5	1987	18-2034	2	18-2035	2	-	-	-	-
2.5,4	② 1981-95	-	1	18-2035	2	-	-	-	-
3 Weedless	1958-68	18-2035	1	-	-	-	-	-	-
3,4,6 Weedless	1968-82	18-2024	1	18-2024	1	-	-	-	-
4	1981-90	18-2034	2	-	-	-	-	-	-
4	1984, 1986-95	-	-	18-2034	2	-	-	-	-
4.5,7.5	1980-87	-	1	18-2034	2	-	-	-	-
5,5.5,6,7.5	① 1957-64	18-2022	1	18-2035	1	-	-	-	-
5,6,8	1980-87	-	-	18-2034	2	-	-	-	-
6	1965-67	-	1	18-2023	1	-	-	-	-
6	1968-79	18-2023	1	18-2024	1	-	-	-	-
9.5	1964-73	18-2022	1	18-2022	1	-	-	-	-
9.9	1974-83	18-2029	1	18-2028	1	18-8304	-	18-0542	1
9.9	1984-95	18-2029	1	18-2028	1	18-8304	-	18-0542+18-2032	1
10	1957-58	18-2005	1	18-2032	1	-	-	-	-
10	1959-63	18-2022	1	18-2022	1	-	-	-	-

① 1968 Models 5802M,3M,6802C,3C ② Standard Gearcase

OIL SEAL APPLICATION (Cont.)

HP	YEARS	PROPSHAFT	QTY.	DRIVESHAFT	QTY.	UPPER CRANKCASE	QTY.	LOWER CRANKCASE	QTY.
10	1981	18-2023 (inner)	1	-	-	18-8304	-	18-0542	1
10	1989	18-2031+18-2027	1	18-2063+18-2027	1	18-8304	-	18-0542+18-2032	1
14	1988-90	18-2031+18-2027	1	18-2063+18-2027	1	18-8304	-	18-0542+18-2032	1
15	1974-83	18-2029	2	18-2028	1	18-8304	-	18-0542	1
15	1984-95	18-2029	2	18-2028	1	18-8304	-	18-0542+18-2032	1
18	1957	18-2005	1	18-2032	1	18-2060	1	-	-
18	1958-73	18-2005	1	18-2032	1	18-2018	1	-	-
20	1981-82	18-2031+18-2030	1	18-2030	1	18-8351	-	-	-
20	1983	18-2031+18-2030	1	18-2027+18-2030	1	18-8351	-	-	-
20	1984	18-2025+18-2027	1	18-2063+18-2030	1	18-8351	-	-	-
20	1985-86	18-2026	1	18-2033	1	18-8350	-	-	-
20	1987-95	18-2026	1	18-2033+18-2065	1	18-8350	-	-	-
25	1969-76	18-2005	1	18-2032	1	18-2018	1	-	-
25	1977-78	18-2005	1	18-2032	1	18-8351	-	-	-
25	1979-82	18-2031+18-2030	1	18-2030	1	18-8351	-	-	-
25	1983	18-2031+18-2030	1	18-2027+18-2030	1	18-8351	-	-	-
25	1984	18-2031+18-2027	1	18-2063+18-2030	1	18-8351	-	-	-
25	1985-86	18-2026	1	18-2033	2	18-8351	-	-	-
25	1987-95	18-2026	1	18-2033+18-2065	1	18-8351	-	-	-
25C	1982	18-2030	1	18-2030	1	18-8351	-	-	-
25C	1983	18-2031+18-2027	1	18-2027+18-2030	1	18-8350	-	-	-
25C	1984-90	18-2031+18-2027	1	18-2063+18-2027	1	18-8350	-	-	-
28	1962-64	18-2021	1	18-2005	1	18-8351	-	-	-
28	1987-90	18-2031+18-2027	1	18-2063+18-2027	1	18-8350	-	-	-
30	1984-86	18-2026	1	18-2033	1	18-8350	-	-	-
30	1987-95	18-2026	1	18-2033 (Inner)	1	18-8350	-	-	-
33	1965-76	18-2021	1	18-2005	1	18-8351	-	-	-
35	1957-59	18-2021	1	18-2005	1	18-2018	1	-	-
35	1976	18-2026	1	18-2027	2	18-8351	-	-	-
35	1977-86	18-2026	2	18-2033	2	18-8351	-	18-2093	-
35	1987-90	18-2026	2	18-2033 (Inner)	1	18-8350	-	18-2093	-
40	1960-61	18-2021	1	18-2005	1	18-2018	1	-	-
40	1962-73	18-2021	1	18-2005	1	18-8351	-	-	-
40	1974-76	18-2021	1	18-2029	1	18-0543	1	18-2001	1
40C	1981-86	18-2021	1	18-2029	2	18-0543	1	18-2001	2
40	1984-85	18-2060	2	18-2059	2	18-0543	1	18-2001	1
40 (AR,AE,AT)	1988	18-2001	1	18-2063+18-2027	1	18-0543	1	18-8307	-
40	1986-89	18-2060	2	18-2064+18-2059	1	18-0543	1	18-8307	-
45C	1985	18-2001	2	18-2063+18-2027	1	18-0543	1	18-8307	-
45C	1986	18-2001	2	18-2064+18-2059	1	18-0543	1	18-8307	-
45C	1987	18-2001	2	18-2063+18-2027	1	18-0543	1	18-8307	-
45C	1988-94	18-2001	2	18-2063+18-2027	1	18-0543	1	18-2001	-
45C	1995	18-2001	2	18-2064+18-2059	1	18-0543	1	-	-
48	1988-95	18-2060	2	18-2064+18-2059	1	18-0543	1	18-2063 (Inner)	1
50	1971-74	18-2001 (Manual)	2	18-2027	2	18-0543	1	18-2001	1
50	1975	18-2060	2	18-2059	1	18-0543	1	18-2001	1
50	1979	18-2001	2	18-2027	2	18-0543	1	18-2001	1
50	1980	18-2060	2	18-2059	1	18-0543	1	18-2001	1
50/60 (rope start)	1981-83	18-2001	2	18-2027	1	18-0543	1	18-2001	1
50/60 (Electric)	1981-83	18-2060	2	18-2059	1	18-0543	1	18-2001	1
50/60	1984-85	18-2060	2	18-2059	1	18-0543	1	18-2001	1
50/60 Small Gearcase	1986-87	18-2060	2	18-2064+18-2059	1	18-0543	1	18-2001	1
50/60 Large Gearcase	1986-87	18-2001	2	18-2064+18-2059	1	18-0543	1	18-2001	1
50/60	1988-89	18-2001	2	18-2064+18-2059	1	18-0543	1	18-2001	1
50	1990-95	18-2060	2	18-2064+18-2059	1	18-0543	1	18-2063 (Inner)	1
55	1968-69	18-2012	2	18-2059	2	18-0543	1	18-2001	1
55	1976-77	18-2060	2	18-2059	2	18-0543	1	18-2001	1
55	1978	18-2059	1	18-2059	2	18-0543	1	18-2001	1
55	1979-83	18-2001	2	18-2027	1	18-0543	1	18-2001	1
55 (Electric)	1980-83	18-2012	2	18-2059	2	18-0543	1	18-2001	1
55C	1984	18-2001	2	18-2063+18-2027	1	18-0543	1	18-2001	1
55C	1985	18-2001	2	18-2063	1	18-0543	1	18-2001	1
55C	1986	18-2001	2	18-2064+18-2059	1	18-0543	1	18-8307	-
55C	1987-94	18-2001	2	18-2063+18-2027	1	18-0543	1	18-8307	-
55C	1995	18-2001	2	18-2064+18-2059	1	18-0543	1	-	-
60 (Manual Shift)	1964-68	18-0173	1	18-0174	1	-	-	-	-
60	1970	18-2012	1	18-2059	2	18-0543	1	18-2001	1
60 (3 Cylinder)	1971	18-2001	2	18-2059	2	18-0543	1	18-2001	1
60 (Rope)	1980-83	18-2001	2	18-2027	2	18-0543	1	18-2001	1
60 (Electric)	1980-83	18-2001	2	18-2059	2	18-0543	1	18-2001	1

OIL SEAL APPLICATION (Cont.)

HP	YEARS	PROPSHAFT	QTY.	DRIVESHAFT	QTY.	UPPER CRANKCASE	QTY.	LOWER CRANKCASE	QTY.
60	1984-85	18-2060	2	18-2059	2	18-0543	1	18-2001	1
60SST	1989	18-2060	2	18-2064+18-2059	1	18-0543	1	18-2001	1
60SST	1990	18-2060	2	18-2064+18-2059	1	18-0543	1	18-8307	-
60 (3 Cylinder)	1987-95	18-2001	2	18-2064+18-2059	1	18-0543	1	18-8307	-
65 (Manual Shift)	1968	18-0173	1	18-0174	1	18-0543	1	-	-
65 (3 Cylinder)	1972-73	18-2001	2	18-2059	2	18-0543	1	18-2001	1
65C	1984-85	18-2001	2	18-2059	2	18-0543	1	18-2001	1
65C	1986-89	18-2001	2	18-2064+18-2059	1	18-0543	1	18-2001	1
70 (Large Gearcase)	1974-85	18-2001	2	18-2059	2	18-0543	1	18-2001	1
70 (Large Gearcase)	1986-95	18-2001	2	18-2064+18-2059	1	18-0543	1	18-8307	-
70 (Small Gearcase)	1977-85	18-2060	2	18-2059	2	18-0543	1	18-8307	-
75 (Manual Shift)	1960-62	18-0173	1	18-0174	1	-	-	-	-
75 (Large Gearcase)	1975-84	18-2001	2	18-2059	2	18-0543	1	18-2001	1
75 (Large Gearcase)	1986-87	18-2001	2	18-2064+18-2059	1	18-0543	1	18-8307	-
75 (Small Gearcase)	1975-84	18-2060	2	18-2059	2	18-0543	1	18-2001	1
80	1966-68	18-0173	1	18-0174	1	-	-	-	-
85	1969-70	18-2012	2	18-2059	2	18-2074	1	18-2001	1
85	1971-72	18-2001	2	18-2059	2	18-2074	1	18-2001	1
85	1973-80	18-2001	2	18-2026	2	18-2074	2	18-2001	1
88	1987-94	18-2001	2	18-2061+18-2062	1	18-2074	2	18-8307	-
90	1981-83	18-2001	2	18-2026	2	18-2074	2	18-2001	1
90	1984-94	18-2001	2	18-2061+18-2062	1	18-2062	1	18-8307	-
90 Seadrive	1985-90	18-2001	2	18-2061+18-2062	1	18-2074	2	18-2001	1
100	1971-72	18-2001	2	18-2059	2	18-2074	1	18-2001	1
100	1979-80	18-2001	2	18-2026	2	18-2074	2	18-2001	1
100C	1984-90	18-2002	2	18-2061+18-2062	1	18-2074	2	18-8307	-
110	1986-88	18-2001	2	18-2061+18-2062	1	18-2074	2	18-2001	1
115	1969-70	18-2012	2	18-2059	2	18-2074	1	18-2001	1
115	1973-83	18-2001	2	18-2026	2	18-2074	1	18-2001	1
115	1984-85	18-2001	2	18-2061+18-2062	1	18-2074	2	18-2001	1
115	1990-94	18-2001	2	18-2061+18-2062	1	18-2074	2	18-8307	-
120	1985	18-2002	2	18-2061+18-2062	1	18-2074	2	18-2075	2
120	1986-88	18-2001	2	18-2061+18-2062	1	18-2074	2	18-2075	2
120	1989	18-2002	2	18-2061+18-2062	1	18-2074	2	18-2075	2
120	1990-94	18-2001	2	18-2061+18-2062	1	18-2074	2	18-2075	2
125	1971-72	18-2001	2	18-2059	2	18-2074	1	18-2001	1
125C	1989	18-2002	2	18-2061+18-2062	1	18-2074	2	18-2075	1
125C (ESX models)	1989	18-2001	2	18-2061	1	18-2062	1	18-2075	1
135	1973-76	18-2001	2	18-2026	2	18-2074	2	18-2001	1
140	1977-83	18-2001	2	18-2026	2	18-2074	2	18-2001	1
140	1984	18-2001	2	18-2026	2	18-2074	2	18-2001	1
140	1985	18-2002	2	18-2061+18-2062	1	18-2074	2	18-2075	2
140	1986-94	18-2001	2	18-2061+18-2062	1	18-2074	2	18-2075	2
140TX	1989	18-2002	1	18-2061+18-2061	1	18-2074	2	18-2075	2
150	1978-83	18-2002	2	18-2026	2	18-2074	2	18-2075	2
150	1984	18-2002	2	18-2061+18-2062	1	18-2074	2	18-2075	2
150	1985-90	18-2002	2	18-2061+18-2062	1	18-2074	2	18-8307	-
155C	1984-85	18-2002	2	18-2061+18-2062	1	18-2074	2	18-2001	1
155C	1986-90	18-2002	2	18-2061+18-2062	1	18-2074	2	18-8307	-
175	1977-85	18-2002	2	18-2026	2	18-2074	2	18-2001	1
175	1986-90	18-2002	2	18-2061+18-2062	1	18-2074	2	18-8307	-
185	1984-85	18-2002	2	18-2061+18-2062	1	18-2074	2	18-2001	1
185	1990	18-2002	2	18-2061+18-2062	1	18-2074	2	18-2075	1
200	1976-83	18-2002	2	18-2026	2	18-2074	2	18-2001	1
200	1984-85	18-2002	2	18-2061+18-2062	1	18-2074	2	18-8307	-
200,225	1986-90	18-2002	2	18-2061+18-2062	1	18-2074	2	18-2075	2
235	1978-83	18-2002	2	18-2026	2	18-2074	2	18-2001	1
235	1984-85	18-2002	2	18-2061+18-2062	1	18-2074	2	18-2001	1
275	1985-88	18-2002	2	18-2061+18-2062	1	18-2074	2	18-2075	2

OIL SEAL APPLICATION - DRIVESHAFT HOUSING

HP	Years	Sierra Oil Seal	Qty.	Desc.	HP	Years	Sierra Oil Seal	Qty.	Desc.
5/6/6.5/8 ①	1987-90	18-2034	1	EH,L	75/80/85	1961-68	18-2060	1	PS
45/55 ①	1990	18-2063	1	EH A	90/100	1964-68	18-2060	1	PS
50/60/65	1958-68	18-2060	1	PS					

① Commercial models also
PS Pivot shaft

EH A Exhaust housing to adapter
EH,L Driveshaft to exhaust housing

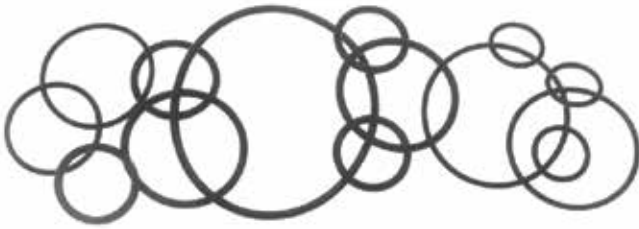

O-RINGS

Part #	O.E. #	Dimensions (in)	
		I.D.	Width
18-7100 ②⑤	301877	.245	.155
18-7101 ②⑤	305739	.250	.065
18-7102 ②⑤	307450	.430	.065
18-7103 ②⑤	308624	.924	.103
18-7104 ②⑤	308627	2.210	.135
18-7105 ②⑤	311338	.750	.065
18-7107 ②⑤	313175	4.750	.135
18-7108 ②⑤	313893	2.550	.100
18-7108 ②⑤	338518	2.550	.100
18-7109 ②⑤	317178	.214	.048
18-7111 ①	301824	.197	.113
18-7112 ①	302493	1.170	.135
18-7114 ②	302540	1.000	.135
18-7115 ①	302588	1.735	.135
18-7116 ①	303067	.360	.100
18-7117 ①	303360	1.060	.135
18-7118 ②⑤	305242	.300	.135
18-7120 ①	307853	.215	.065
18-7121 ①	308621	3.100	.135
18-7123 ①	308876	2.235	.100
18-7126 ①	313340	1.690	.100
18-7127 ①	313446	3.315	.135
18-7128 ①	313754	1.835	.100
18-7129 ②⑤	314491	.970	.065
18-7130 ①	314728	2.125	.100
18-7133 ②⑤	305123	3.780	.135
18-7133 ②⑤	322119	3.780	.135
18-7134 ②⑤	303059	.500	.100
18-7135 ①	310584	.750	.135
18-7137 ②⑤	318372	0.320	.155
18-7138 ②⑤	318717	1.500	.210
18-7139 ②⑤	319085	1.080	.210
18-7140 ②⑤	320303	2.750	.135
18-7141 ②⑤	321117	.180	.065
18-7142 ②	322119,	3.940	.135
18-7143 ②⑤	322501,		
	331188	1.310	.100
18-7144 ②⑤	326849	4.250	.135
18-7145 ②⑤			
18-7146 ②⑤			
18-7150 ③⑤			
18-7150 ③⑤			
18-7150 ③⑤			
18-7152 ②⑤			
18-7153 ②⑤			
18-7153 ②⑤			
18-7155 ②⑤			
18-7156 ②⑤			
18-7158 ②⑤			
18-7158 ②⑤			
18-7162 ②⑤			
18-7164 ②⑤			
18-7165 ②⑤			
18-7167 ②⑤			
18-7168 ②⑤			
18-7169 ②⑤			
18-7170 ②⑤			
18-7172 ②⑤			
18-7173 ②⑤			
18-7174 ②⑤			
18-7174 ②⑤			
18-7178 ②⑤			
18-7180 ②⑤			
18-7198 ②⑤			
18-7400 ②⑤			
18-7401 ②⑤			
18-7403 ②⑤			
18-7404 ②⑤			
18-7406 ②⑤			
18-7407 ②⑤			
18-7407 ⑤			
18-7408 ②⑤			
18-7409 ②⑤			
18-7411 ②⑤			
18-7413 ②⑤			
18-7416 ②⑤			
18-7417 ②⑤			
18-7418 ②⑤			
18-7440-1 ④			
18-7457 ①			
18-7461 ①			
18-7475 ①⑤			
■18-7477 ②⑤			
18-7510 ⑤			

① PKG. OF 1 ② PKG. OF 5 ③ PKG. OF 10 ④ PKG. OF 2 ■ Indicates quad rings rather than O-Rings
 ⑤ This product is priced per piece. To order priced per package, please add -9 to the part number.

POWERHEAD				
HP	YEAR	O RING	QTY	DESC
5.5	1959	18-7180	1	L C
9.5	1964-73	18-7156	1	U C
18	1957-72	18-7114	1	CCH
18/25	1957-76	18-7164	1	LL C
20/25 ①	1977,79-90	18-7174	1	L C
20/25	1990-95	18-7146	1	CCH O
25/35	1957,69-76	18-7114	1	CCH
25/18	1971-76	18-7164	1	U C
25 ⑥	1989-90	18-7123	1	CCH
25 ⑥	1989-90	18-7457	1	U C
25/35	1978	18-7134	1	L C
28	1962-64	18-7164	1	LL C
28/30/35	1976-77,79-90	18-7174	1	L C
28/30/35	1990-95	18-7146	1	CCH O
33/35/40	1957-75	18-7164	1	LL C
35	1987	18-7128	1	U C
35	1987	18-7123	1	CCH
40/45 ①	1976,81-95	18-7123	1	CCH
40) ①	1976,81-95	18-7128	1	U C
45/45SS ①	1985-95	18-7128	1	U C
45SS/48	1987-95	18-7123	1	CCH
48/50/55 ①	1971-95	18-7128	1	U C
50	1958-59	18-7133	1	CCH
50/55 ①	1968-90	18-7123	1	CCH
55/60	1968-71	18-7117	1	CCH O
60/65/75/80	1960-68	18-7133	2	CCH
60/SST60	1970-71,81-95	18-7128	1	U C
60/SST60	1970-95	18-7123	1	CCH
60/SST60	1989-90	18-7158	1	L C
65 ①	1972-73,85-95	18-7123	1	CCH
65 ①	1972-73,85-95	18-7128	1	U C
65/70 ①	1989-90	18-7158	1	L C
70	1974-90	18-7123	1	CCH
70	1974-90	18-7128	1	U C
75	1975-88	18-7128	1	U C
75	1975-88	18-7123	1	CCH
V-4	1969-71	18-7117	1	CCH O
85)	1968-80	18-7133	4	CCH
88/90/100 ①	1964,81-95	18-7133	4	CCH
100	1966	18-7120	4	CCHS
110/115	1969-95	18-7133	4	CCH
125/135/140	1971-84	18-7133	4	CCH
150/155/175 ①	1977-90	18-7133	4	CCH
200/235/185	1976-85	18-7133	4	CCH

CCH S Crankcase Head Screw
 L C Lower Crankshaft
 LL C Large Lower Crankshaft
 ① Commercial Models Only

CCH O Crankcase Head Outer
 U C Upper Crankshaft
 CCH Crankcase Head
 ⑥ 89 Models DR, DE, DT

POWERHEAD				
HP	YEAR	O RING	QTY	DESC
4	1969-90	18-7111	1	FC
5 THRU 300 ①	1957-90	18-7111	2	FC
20/25/30	1984-86	18-7101	1	EPMV
35/40	1984-86	18-7101	1	EPMV
45 ①	1986-87	18-7101	1	EPMV
50	1985-86	18-7101	1	EPMV
55 ①	1986-88	18-7101	1	EPMV
60/65/70 ①	1985-86	18-7101	1	EPMV
75	1983-86	18-7101	1	EPMV
V-4/6 ①	1980-86	18-7101	1	EPMV
200/225	1986-88	18-7115	1	EPP
V-8	1985-86	18-7115	1	EPP

① Commercial Models Also
 EPMV Electric Fuel Primer Manual Valve
 FC Fuel Connector
 EPP Electric Primer Pump

POWER TILT AND TRIM				
HP	YEAR	O RING	QTY	DESC
35/40/45 ①	1986-89	18-7168	1	LA
45SS	1988-90	18-7134	1	TEC
45SS	1988	18-7141	4	OL
50/55/60 ①	1981-89	18-7168	1	LA
60/70/75	1981-90	18-7174	2	MVS,L
60/70/75	1981-90	18-7141	4	OL
60/70/75	1981-90	18-7165	2	MVS,S
60/70/75	1981-90	18-7102	1	FP
70/75	1981	18-7174	1	TR
V-4/6 ①	1977-79	18-7168	3	RV
V-4/6 ①	1977-90	18-7174	1	TR
V-4/6/8	1977-90	18-7174	2	MVS,L
V-4/6/8 ①	1977-90	18-7102	1	FP
V-4/6/8 ①	1977-90	18-7165	2	MVS,S
V-4/6/8 ①	1977-90	18-7141	4	OL
85	1976-79	18-7168	1	LA
115/135	1974-77	18-7168	1	LA
200	1976	18-7168	3	RV
200/300	1990	18-7168	3	RV

① Commercial Models Also
 TEC Trim End Cap to Rod
 LA Line Assembly
 RV Relief Valve
 MVS,L Manifold Valve Seat, Large
 MVS,S Manifold Valve Seat, Small
 TR Trim rod
 OL Oil Line
 FP Fill Plug

POWER STEERING				
HP	YEAR	O RING	QTY	DESC
60/70/75	1981-90	18-7168	4	CP
V-4/6/8	1980-90	18-7168	4	CP
V-6/8	1986-90	18-7129	2	SC
V-6/8	1986	18-7135	3	PVHT

CP Pump Control Piston
 RV Pump Hsg. Relief Valve
 SV Spoon Valve
 SC Steering Cylinder
 PVHT Piston to Valve Hsg. Tube Seal

DRIVESHAFT HOUSING				
HP	YEAR	O RING	QTY	DESC
2.5	1987-88	18-7101	1	SS
4	③ 1981-90	18-7101	1	SS
4	② 1984,86-90	18-7168	1	K&S
4	④ 1984,86-90	18-7146	2	SB
4.5	1980-84,86-87	18-7168	1	K&S
4.5	1980-87	18-7146	2	SB
4.5	1980	18-7146	1	EHC
5	1984-90	18-7168	1	K&S
5	1984-90	18-7146	2	SB
6	1984-90	18-7168	1	K&S
6	1984-90	18-7146	2	SB
6.5 ①	1989-90	18-7168	1	K&S
6.5 ①	1989-90	18-7146	2	SB
7.5	1980-83	18-7146	2	SB
7.5	1980-83	18-7168	1	K&S
7.5	1980	18-7146	1	EHC
8	1984-90	18-7146	2	SB
8	1984-90	18-7168	1	K&S
28	1962-64	18-7115	1	SB
33	1965-70	18-7115	1	SB
35	1959	18-7114	1	PS
40	1960-70	18-7102	1	SS
40	1961-70	18-7114	1	PS
40 ⑤	1971-76,81-90	18-7115	1	SB
45SS	1987,88	18-7115	1	SB
60	1964-67	18-7180	4	SA
65	1968	18-7180	4	SA
75	1960-61,64-65	18-7180	4	SA
80	1966-67	18-7180	4	SA

DRIVESHAFT HOUSING (Cont.)				
HP	YEAR	O RING	QTY	DESC
85	1968	18-7180	4	SA
90	1964-65	18-7180	4	SA
100	1966-68	18-7180	4	SA

① Commercial K&S Knob & Shaft to Swivel Bracket
 ② "RD" Models Only PS Pivot Shaft
 ③ "BR" "RL" "RC" "RE" Models Only SS Shift Shaft
 ④ "R" "RD" Models Only SA Shock Absorber
 ⑤ '82-'90 Commercial SB Swivel Bracket
 EHC Exhaust Housing Cover

GEARCASE

HP	YEAR	O RING	QTY	DESC
1.5/2	1968-90	18-7173	1	PBH
2/2.5/4	1988-90	18-7145	1	D&F S
3/4	1957-79	18-7168	1	DS CC
3/4 Std. Gearcase	1964-80	18-7173	1	PBH
4 ☆	1981-95	18-7162	1	PBH
4 RD Models	1984,86-95	18-7118	1	SR
4.5	1980-87	18-7118	1	SR
5/5.5	1957-68	18-7180	1	DS BH
5	1965-68	18-7173	1	PBH
5/6/108	1984-95	18-7118	1	SR
5/6/6.5/8 6.5 HP Comm	1988-95	18-7145	2	D&F S
5/6/108	1989-95	18-7168	1	WT E
5.5/6	1957-79	18-7100	1	SR
5.5/6/7.5	1957-79	18-7117	1	PBH
5.5	1964	18-7120	1	SR PP
6/7.5	1957-79	18-7180	1	DS BH
6	1965-79	18-7120	1	SR PP
6.5/7.5 7.5 HP Comm	1980-90	18-7118	1	SR
6.5 Comm	1989-90	18-7168	1	WT E
7.5/9.5	1957-73	18-7100	1	SR
9.5/10	1958-73	18-7117	1	PBH
9.5	1964-73	18-7120	1	SR PP
9.5	1965-66,68,70-73	18-7168	1	WT E
9.5/9.9/15	1974-84	18-7116	1	DS CC
9.9/15	1974-95	18-7100	1	SR
9.9/15	1974-95	18-7168	1	WT E
9.9/15	1974-90	18-7104	1	PBH
9.9/15	1974-90	18-7139	1	IH
9.9/15	1984-85	18-7120	1	SR PP
9.9/15	1986-95	18-7475	1	SR PP
9.9/15	1988-92	18-7145	2	D&F S
9.9/15	1993-96	18-4248	2	D&F S
10	1957	18-7112	1	PBH
10/14 ☆	1957-63,88-90	18-7100	1	SR
10/18/25	1957-77	18-7116	1	DS CC
10/14 Comm	1988-90	18-7145	2	D&F S
14 Comm	1988-89	18-7475	1	SR PP
15A	1987-90	18-7174	1	WT
18/25	1957-76	18-7112	1	PBH
18/20/25 ☆	1957-95	18-7100	1	SR
18/20/28	1964-85	18-7120	1	SR PP
20/25	1977,85-95	18-7105	2	IH S
20/25	1985-90	18-7146	1	IH
20/25	1985-95	18-7180	1	SR S
20/25	1985-95	18-7108	1	PBH
20/25 ☆	1986-95	18-7475	1	SR PP
20/25/30	1987-95	18-7475	2	PBH S
20/25/28 ☆	1988-95	18-7145	2	D&F S
20/25	1988-95	18-7100	1	IH
20/30	1990	18-7475	1	BS
25 ☆	1969-86	18-7120	1	SR PP
25	1977	18-7109	2	PBH S
25	1978	18-7134	1	DS CC
25	1989-95	18-7475	1	BS
25 ⑥	1989-90	18-7172	1	PBH
25 ⑥	1989-90	18-7109	1	SR PP
25 ⑥	1989-90	18-7173	1	DS BH

GEARCASE (Cont.)				
HP	YEAR	O RING	QTY	DESC
25 ⑥	1989-90	18-7137	1	SR
28/33	1962-63,65-67	18-7165	1	WT E
28/33	1962-70	18-7134	1	DS CC
28/33/35	1962-70	18-7115	1	PBH
28	1963-64	18-7100	1	SR
28	1987-95	18-7475	1	SR PP
30/35/33	1965-70,84-85	18-7120	1	SR PP
30/33	1965-95	18-7100	1	SR
30/35	1976-86	18-7109	2	PBH S
30/35 ①	1976-95	18-7108	1	PBH
30/35	1976-95	18-7105	2	IH S
30/35 ①	1983-95	18-7180	1	SR S
30	1984-90	18-7146	1	IH
30/35	1986-95	18-7475	1	SR PP
30/35 ①	1986-95	18-7100	1	IH
30/35 ①	1987-95	18-7145	2	D&F S
35	1957-58	18-7165	1	WT E
35 ④	1957-59,87	18-7134	1	DS CC
35/40 ⑩	1957-90	18-7100	1	SR
35	1976-77	18-7174	1	DS CC
35 ⑤	1983-84,86-90	18-7146	1	IH
35 ⑩	1987	18-7140	1	PBH
35 ⑩	1987	18-7137	1	SR
35 ⑩	1987	18-7115	1	DS BH
35 ④	1987,90	18-7475	1	BS
35 ④	1987-90	18-7475	2	PBH S
40 ②	1960-85,89-90	18-7115	1	PBH
40/48	1960-88	18-7134	1	DS CC
40 *	1962-70	18-7152	1	PBH
40 ☆	1965-66,71,73-85	18-7120	1	SR PP
40 ☆	1966,70	18-7120	4	PBH S
40	1971,73-76,81-85	18-7165	1	WT E
40	1984	18-7109	4	PBH S
40/45 ☆	1984-86	18-7120	1	BS
40/48	1984-88	18-7140	1	PBH
40/48	1984-88	18-7115	1	DS BH
40/45 45 HP Comm	1984-95	18-7137	1	SR
40/45 45 HP Comm	1987-95	18-7475	1	BSS
40/50 ☆	1988-95	18-7145	2	D&F S
40/48/50	1989-90	18-7109	1	SR PP
40 Comm	1989-90	18-7165	1	WT E
40 Comm	1989-90	18-7475	1	SR PP
40/48/50	1989-95	18-7172	1	PBH
40/48/50	1989-95	18-7173	1	DS BH
45 Comm	1985-88	18-7134	1	IH
45 Comm	1985-95	18-7128	1	DS BH
45 Comm	1985-95	18-7127	1	PBH
45/48 45 HP Comm	1987-95	18-7145	2	D&F S
45SS	1987-90	18-7134	2	DS CC
45 Comm	1995	18-7475	4	PBH S
48	1987-88	18-7475	3	PBH S
48/50	1987-95	18-7475	1	BS
48	1987-95	18-7137	1	SR
50/60	1958-67	18-7118	1	SR
50/60/65	1958-68	18-7174	1	WT E
50/55	1958-69	18-7174	1	DS CC
50/55/60	1968-71	18-7126	1	DS BH
50/55	1968-72	18-7129	1	PS OP
50	1971	18-7100	1	SR
50 ⑧	1971-74,79,81	18-7127	1	PBH
50 ⑨	1971-81	18-7128	1	DS BH
50/55/60	1971-84	18-7109	4	PBH S
50/55 ☆	1971-88	18-7134	1	DS CC
50 ☆	1973-74	18-7156	2	SA,L
50 ☆	1973-74	18-7146	1	SA,S
50/55 ☆	1973-95	18-7137	1	SR
50 ⑧	1975,79,81,			

GEARCASE (Cont.)					GEARCASE (Cont.)				
HP	YEAR	O RING	QTY	DESC	HP	YEAR	O RING	QTY	DESC
	82-88	18-7115	1	DS BH	V-4	1966-68	18-7118	1	SR
50	⑧ 1975,79,81-88	18-7140	1	PBH	V-4	1966-68	18-7120	1	SR PP
50/60	1981-86	18-7120	1	BSS	80	1967	18-7120	4	PBH S
55	① 1968-69,79-81, 83-95	18-7127	1	PBH	V-4	1968-95	18-7127	1	PBH
55	⑩ 1976-82	18-7140	1	PBH	V-4	1969-72	18-7129	1	PS OP
55	⑩ 1976-82	18-7115	1	DS BH	V-4/6/8	1969-95	18-7130	1	DS BH
55	⑨ 1979-81,83-95	18-7128	1	DS BH	V-4	1971-86	18-7109	4	PBH S
55	⊕ 1981-88	18-7120	1	BS	V-4	1973-74	18-7146	1	SA,S
55 Comm	1988,90-95	18-7475	4	PBH S	V-4	1973-77	18-7156	2	SA,L
55 Comm	1989-95	18-7475	1	BS	V-4/6/8	1973-95	18-7137	1	SR
55 Comm	1989-95	18-7145	2	D&F S	V-4,6,8	1973-90	18-7158	1	DS CC
60 71 "E" Models	1964,66-67, 70-71	18-7120	4	PBH S	V-4	1975-77	18-7178	1	SA,S
60	⑦ 1964-67,80-87	18-7115	1	DS BH	V-4	1981-86	18-7120	1	BS
60/65/75 Std. Gearcase	1964-68	18-7152	1	PBH	V-4/6	1987-95	18-7475	4	PBH S
60	1964-71,86-88	18-7174	1	DS CC	V-4/6/8	1987-95	18-7475	1	BS
60 67 Std. Gearcase	1966-67	18-7120	1	SR PP	V-4/6/8	1987-95	18-7145	2	D&F S
60/65	1968-71	18-7129	1	PS OP	85/90	1964-68	18-7152	1	PBH
60	③ 1970-81,86-95	18-7127	1	PBH	100	1966-68	18-7167	1	PBH
60	③ 1980-81,86-95	18-7128	1	DS BH	100	⑦ 1984-90	18-7142	1	PBH
60	1980-85	18-7134	1	DS CC	100 Comm	1986-90	18-7475	1	BS
60	② 1980-87	18-7140	1	PBH	100 Comm	1987	18-7109	4	PBH S
60/SST60	1980-95	18-7137	1	SR	120	1985	18-7142	1	PBH
60/SST60/					125	1971	18-7173	1	PBH
65 65 HP Comm	1987-95	18-7475	1	BS	125 Comm	1989-90	18-7142	1	PBH
60/SST60/					125 Comm	1990	18-7174	1	WT
65 65 HP Comm	1987-95	18-7145	2	D&F S	140	1985,88-90	18-7142	1	PBH
SST60	1989-90	18-7140	1	PBH	V-6	1976-78	18-7178	1	SA,S
SST60	1989-90	18-7174	1	DS CC	V-6	1976-78	18-7156	2	SA,L
60/65/70 65 HP Comm	1989-90	18-7158	1	DS CC	V-6	1976-85	18-7109	4	PBH S
SST60	1989-90	18-7115	1	DS BH	V-6	1976-90	18-7142	1	PBH
65/75	1960-68	18-7118	1	SR	V-6	1986	18-7120	1	BS
65 Std. Gearcase	1968	18-7120	1	SR PP	155	⑧ 1984,89-90	18-7142	1	PBH
65 Std. Gearcase	1968	18-7115	1	DS BH	155	③ 1984-90	18-7144	3	PBH
65	⊕ 1968-73, 85-88,90	18-7174	1	DS CC	200/225	1987	18-7120	1	BS
65	⊕ 1971,73,85-86	18-7109	4	PBH S	V-8	1985-86	18-7120	1	BS
65	⊕ 1972-73,85-95	18-7127	1	PBH	V-8	1985-90	18-7144	3	PBH
65	⊕ 1973,85-95	18-7137	1	SR	V-8	1985-90	18-7174	1	WT
65	⊕ 1973,85-95	18-7128	1	DS BH					
65/70 75 "B" Models	1973-75	18-7156	2	SA,L					
65/70 75 "B" Models	1973-75	18-7146	1	SA,S					
65 Comm	1985-86	18-7120	1	BS					
65/70 65 HP Comm	1988-95	18-7475	4	PBH S					
70/75	1960-65,74-88	18-7174	1	DS CC					
70/75	1974-85	18-7109	4	PBH S					
70/75	1974-95	18-7137	1	SR					
70	⑦ 1974-95	18-7128	1	DS BH					
70	⑦ 1974-95	18-7127	1	PBH					
70 15" Transom	1977-85	18-7115	1	DS BH					
70 15" Transom	1977-85	18-7140	1	PBH					
70	1981-87	18-7120	1	BS					
70	1988-95	18-7475	1	BS					
70	1988-95	18-7145	2	D&F S					
75	1960,63-65	18-7120	4	PBH S					
75	1961-65	18-7174	1	WT E					
75	⑤ 1964-65,75-88	18-7115	1	DS BH					
75	1965	18-7120	1	SR PP					
75	⑥ 1975-87	18-7127	1	PBH					
75 20" Transom	1975-87	18-7128	1	DS BH					
75 15" Transom	1975-88	18-7140	1	PBH					
75	1981-86	18-7120	1	BS					
75	1987-88	18-7475	1	BS					
75	1987-88	18-7145	2	D&F S					
V-4	1964-66,68-70	18-7120	4	PBH S					
V-4	1964-67	18-7174	1	WT E					
V-4	1964-68	18-7115	1	DS BH					
V-4	1964-72	18-7174	1	DS CC					

- ① 35 hp '87 Models RC, RL
- ② '62-'70 w/o Selectric Shift/'89-'90 Comm.
- ③ '65 Std Gearcase/'75-'87 15" Transom
- ④ '76-'87 20" Transom
- ⑤ '77-'85 20" Transom
- ⑥ '79-'81 Electric Start
- ⑦ '79-'81 Rope Start
- ⑧ '79-'81 Rope Start/'82 Comm.
- ⑨ '79-'81 Rope Start/'83-'90 Comm.
- ⑩ '80-'81 Electric Start/'86-'87 — 15" Transom
- ⑪ '80-'81 Rope Start/'86,'87 — 20" Transom
- ⑫ '87 Models AR, AE
- ⑬ '87 Models RC, RL
- ⑭ '89 Models DR, DE, DT
- ⑮ '89 WTLZ, WTXZ Models '90 WTESM, WTXESM Comm.
- ⑯ '89 WTLZ, WTXZ / '90 WTLES, WTESM Comm.
- ⑰ '89 WTPLY, WTALY, WTPXY, WTAXY, '90 WTPLA, WTALA, WTPXA/Comm.
- ⑱ AR, AE Models
- ⊕ B, BR Models
- ⊕ Comm. Models Also
- ★ Electric Start
- * Selectric Shift

- BS Bearing Setscrew
- DS BH Driveshaft Bearing Hsg.
- DS CC Driveshaft to Crankcase
- D & F S Drain & Fill Screw
- WT E 5" Gearcase Extension, Water Tube
- GC 1 Gearcase (11 7/16")
- GC 2 Gearcase (12 7/8")
- GC3 Gearcase (19 1/2")
- IH Impeller Hsg.
- IHS Impeller Hsg. Spacer
- PBH Prop Bearing Hsg.
- PBH S Prop Bearing Hsg. Screw
- PS OP Prop Shaft Oil Pump
- SA,L Shift Assembly, Large
- SA,S Shift Assembly, Small
- SR Shift Rod
- SR PP Shift Rod Pivot Pin
- SR S Shift Rod Scraper
- WT Water Tube



**18-5225
SPARK PLUG WIRE KIT**
Kit includes 25 ft Roll of Hypalon Ignition Wire With a Copper Conductor and a Large Assortment of Three Different End Fittings to Fit McCulloch Motors Wire available in 100' Spool **18-5226**



**18-5226
IGNITION WIRE**
Metallic Core
100' Spool
7mm Hypalon



**18-5153
CONTACT SET**
Replaces: 75101A, 1340135, 36550135



**18-5241
CONDENSER**
Replaces: 38850115

HP	Years	Contact Set	Condenser	HP	Years	Contact Set	Condenser
3.6	1953-57	18-5153	—	7.5	1961-68	18-5153 ②	—
6	1960-62	18-5153 ②	—	10	1958	—	18-5241 ②
7.5	1952-87	18-5153 ②	—	25	1959	18-5153 ② ③	—
7.5	1958	18-5153 ② ③	—	30 - 33	1955-56	18-5153 ②	—
7.5	1960	18-5153 ②	—	40	1957-59	18-5153 ② ③	—

② Two Required ③ REPCO Magneto Only

8' LENGTH COMPLETE FUEL LINE ASSEMBLIES

5/16" FUEL LINE ASSEMBLY 18-8013EP-2 SILVERADO 4000 Premium





**18-8004EP-1
PRIMER
BULB**



FUEL LINE ASSEMBLY COMPONENTS

8' LENGTH COMPLETE FUEL LINE ASSEMBLIES

3/8" FUEL LINE ASSEMBLY 18-8015EP-2 SILVERADO 4000 Premium





**18-8005EP-1
PRIMER
BULB**



FUEL LINE ASSEMBLY COMPONENTS

12' LENGTH COMPLETE FUEL LINE ASSEMBLIES

5/16" FUEL LINE ASSEMBLY 18-8032EP-2 SILVERADO 4000 Premium





**18-8004EP-1
PRIMER
BULB**



FUEL LINE ASSEMBLY COMPONENTS



PRIMER BULB ASSEMBLY
Comes complete with two Hose Clamps

Part #	Description
18-8002EP-1	For 1/4" I.D. Hose
18-8004PE-1	For 5/16" I.D. (large capacity bulb)
18-8005EP-1	For 3/8" I.D. (large capacity bulb)



**18-7852-1
FUEL WATER SEPARATOR KIT**
Includes:
18-7845 Filter - 18-7853-1 Bracket
18-4256 1/4" (2) Brass Plugs
18-9004 Pipe Sealant with Teflon® is recommended for use on filter bracket fitting threads



FUEL FILTERS

Part #	Description
18-7828-1	(1/4" Small)
18-7829	(1/4" Large)
18-7830	(5/16")
18-7831	(3/8")



**18-79989
TRAILERING STICKS**
Fits: Most outboards over 150hp with three ram intrigrel tilt/trim.

***** Tanks and Engines for picture purpose only.

MERCURY OUTBOARD

HP	CYL	BEG. S/N	YEAR	HP	CYL	BEG. S/N	YEAR	HP	CYL	BEG. S/N	YEAR
2.2	1	8075603	1984	8	2	C221500	1990	35	2	1755799	1965
2.2	1	8087123	1985	9.8	2	5206550	1979	35	2	1960827	1966
2.2	1	A800761	1986	9.8	2	5541280	1980-81	35	2	2097800	1967
2.2	1	A805221	1987	9.8	2	5965263	1982	35	2	2300972	1968
2.2	1	A817421	1988	9.8	2	6263906	1983	35	2	2487558	1969
2.2	1	A837101	1989	9.8	2	6438338	1984	35	2	6445653	1984
3	1	A855097	1990	9.8	2	6620196	1985	35	2	6626696	1985
3.4 L	6	6436883	1984	9.8 (100)	2	1397581	1961	35	2	A922171	1986
3.4 L	6	A129445	1985	9.8 (110)	2	1455240	1962	35	2	B110789	1987
3.4 L	6	A912426	1986	9.8 (110)	2	1474328	1963	35	2	B238644	1988
3.5	1	6202173	1983	9.8 (110)	2	1607083	1964	35	2	B393190	1989
3.5	1	6434771	1984	9.8 (110)	2	1742746	1965	35 (300)	4	1271885	1960
3.5	1	6594744	1985	9.8 (110)	2	1865779	1966	40	2	2874704	1970
3.6	1	5404657	1980-81	9.8 (110)	2	2098352	1967	40	2	3043031	1971
3.6	1	5910968	1982	9.8 (110)	2	2290663	1968	40	2	3219678	1972
3.9	1	1655013	1964	9.8 (110)	2	2508759	1969	40	2	3474578	1973
3.9	1	1738941	1965	9.8 (110)	2	2798057	1970	40	2	3859435	1974
3.9	1	1865633	1966	9.8 (110)	2	3002814	1971	40	2	4118385	1975
3.9	1	2098037	1967	9.8 (110)	2	3263263	1972	40	2	4362215	1976
3.9	1	2278851	1968	9.8 (110)	2	3482753	1973	40	2	4564002	1977
4	1	2498136	1969	9.8 (110)	2	3795658	1974	40	2	4860103	1978
4	1	2771662	1970	9.8 (110)	2	4079675	1975	40	2	5174089	1979
4	1	3028361	1971	9.8 (110)	2	4304785	1976	40	2	5556230	1980-81
4	1	3296137	1972	9.8 (110)	2	4605112	1977	40	2	5991215	1982
4	1	3529446	1973	9.8 (110)	2	4839254	1978	40	2	6228285	1983
4	1	3764825	1974	9.9	2	A918999	1986	40	4	C159200	1989
4	2	5589202	1980-81	9.9	2	B114231	1987	40	4	C221500	1990
4	2	9075839	1976	9.9	2	B233200	1988	40 350	2	1356948	1961
4	2	9172806	1978	9.9	2	B385500	1989	45	4	1476510	1962
4	1	A818721	1988	9.9	2	C221500	1990	45	4	A914859	1986
4	1	A837101	1989	10	2	1290910	1960	45	4	B110789	1987
4	1	A855097	1990	15	2	1288910	1960	45	4	B238644	1988
4	1	A906702	1986	15	2	1346448	1961	45	4	B393190	1989
4	1	B114109	1987	15	2	B293117	1988	45 (400)	4	1279685	1960
4.5	1	4108120	1975	15	2	B385500	1989	45 (400)	4	1384806	1961
4.5	1	4377557	1976	15	2	C221500	1990	50	4	1421113	1961
4.5	1	4597262	1977	18	2	5860332	1980-81	50	4	1477910	1962
4.5	1	4869518	1978	18	2	5954911	1982	50	4	1552535	1963
4.5	1	5270784	1979	18	2	6171607	1983	50	4	1605952	1964
4.5	1	5595532	1980-81	18	2	6443973	1984	50	4	1755549	1965
4.5	1	6025119	1982	18	2	6617631	1985	50	4	1870389	1966
4.5	1	6232381	1983	20	2	1558310	1963	50	4	2097445	1967
4.5	1	6428076	1984	20	2	1606903	1964	50	4	2305101	1968
4.5	1	6608536	1985	20	2	1755849	1965	50	4	2514919	1969
5	1	A819951	1988	20	2	1866496	1966	50	4	2736807	1970
5	1	A837101	1989	20	2	1997990	1967	50	4	3009934	1971
5	1	A855097	1990	20	2	2296267	1968	50	4	3235063	1972
6	2	1408611	1961	20	2	2550065	1969	50	4	3478003	1973
6	2	1485612	1962	20	2	2827677	1970	50	4	3816308	1974
6	2	1551443	1963	20	2	2991679	1971	50	4	4141450	1975
6	2	1607513	1964	20	2	3226958	1972	50	4	4357650	1976
6	2	1745521	1965	20	2	3537531	1973	50	4	4576237	1977
6	2	1958278	1966	20	2	3755885	1974	50	4	4962056	1978
6	2	2096171	1967	20	2	4103290	1975	50	4	5193259	1979
6	2	2284857	1968	20	2	4293920	1976	50	4	5531630	1980-81
6	2	A910596	1986	20	2	4580036	1977	50	4	5949386	1982
6	2	B114231	1987	20	2	4819249	1978	50	4	6275323	1983
6	2	B233200	1988	20	2	5183393	1979	50	4	6448808	1984
6	2	B385500	1989	20	2	5606492	1980-81	50	4	6586624	1985
7.5	2	2529895	1969	20	2	A910971	1986	50	3	A912478	1986
7.5	2	2810637	1970	20	2	B114231	1987	50	3	B110789	1987
7.5	2	3016581	1971	20	2	B238464	1988	50	3	B239242	1988
7.5	2	3274633	1972	20	2	B385500	1989	50	3	B396036	1989
7.5	2	3488153	1973	20	2	C221500	1990	50	3	C221500	1990
7.5	2	3801458	1974	22 (200)	2	1292910	1960	60	3	1303411	1960
7.5	2	4087015	1975	22 (200)	2	1339948	1961	60	3	6428681	1984
7.5	2	4314385	1976	25	2	1467499	1962	60	3	6609651	1985
7.5	2	4691222	1977	25	2	5705532	1980-81	60	3	A197392	1986
7.5	2	4851693	1978	25	2	5942041	1982	60	3	B110789	1987
7.5	2	5226935	1979	25	2	6185159	1983	60	3	B239242	1988
7.5	2	5524660	1980-81	25	2	6453343	1984	60	3	B396036	1989
7.5	2	5936301	1982	25	2	6593849	1985	60	3	C221500	1990
7.5	2	6239857	1983	25	2	A911346	1986	65	4	1542745	1963
7.5	2	6430041	1984	25	2	B114231	1987	65	4	1606282	1964
7.5	2	6611886	1985	25	2	B238464	1988	65	4	1765044	1965
8	2	A197112	1986	25	2	B385500	1989	65	4	1869564	1966
8	2	B114231	1987	25	2	C221500	1990	65	4	2119749	1967
8	2	B233200	1988	35	4	1570507	1963	65	4	2309311	1968
8	2	B385500	1989	35	2	1628795	1964	65	4	2503991	1969

MERCURY OUTBOARD

HP	CYL	BEG. S/N	YEAR	HP	CYL	BEG. S/N	YEAR	HP	CYL	BEG. S/N	YEAR
65	4	2803562	1970	90	3	B110054	1987	150	6	3752620	1974
65	4	2997339	1971	90	3	B240451	1988	150	6	4125985	1975
65	3	3293184	1972	90	3	C100000	1989	150XS	6	4319880	1976
65	3	3547987	1973	90	3	C221500	1990	150XS	6	4602012	1977
65	3	3807833	1974	90cc	2	A907702	1986	150XS	6	4868648	1978
65	3	4136685	1975	90cc	2	B114221	1987	V-150	6	4868998	1978
65	3	4382057	1976	95	6	1869776	1966	V-150	6	5129480	1979
70	3	1296411	1960	95	6	2097280	1967	V-150	6	5503247	1980-81
70	3	1413611	1961	100	6	1503332	1962	V-150	6	5944791	1982
70	3	1503459	1962	100	6	1518384	1963	V-150	6	6220254	1983
70	3	4382057	1976	100	6	1665002	1964	V-150	6	6443213	1984
70	3	4571652	1977	100	6	1755459	1965	V-150	6	6616991	1985
70	3	4825249	1978	100	6	2318586	1968	V-150	6	A904646	1986
70	3	5128280	1979	100	6	2484633	1969	V-150	6	B116662	1987
70	3	5579017	1980-81	100	4	B209468	1988	V-150	6	B242881	1988
70	3	5974683	1982	100	4	C100000	1989	V-150	6	C100861	1989
70	3	6279960	1983	100	4	C221500	1990	V-150	6	C221500	1990
70	3	B110054	1987	102cc	2	A819211	1988	V-150XR2	6	A905191	1986
70	3	B240451	1988	102cc	2	A837101	1989	V-150XR2	6	B289430	1988
70	3	C100000	1989	110	6	1870204	1966	V-150XR4	6	B242885	1988
75	4	6432901	1984	110	6	2097385	1967	V-175	6	4301235	1976
75	4	6613221	1985	115	6	2836019	1970	V-175	6	4563802	1977
75	4	A197882	1986	115	6	3023086	1971	V-175	6	4838074	1978
75	3	C100000	1989	115	6	3270480	1972	V-175	6	5180109	1979
75	3	C221500	1990	115	6	3525441	1973	V-175	6	5488752	1980-81
80	4	1335465	1960	115	6	3761035	1974	V-175	6	6618751	1985
80	4	1398630	1961	115	6	4112635	1975	V-175	6	A918329	1986
80	4	2559001	1969	115	6	4310785	1976	V-175	6	B116662	1987
80	4	2783253	1970	115	6	4567952	1977	V-175	6	B241881	1988
80	4	2986444	1971	115	6	4855153	1978	V-175	6	C100861	1989
80	4	3186263	1972	115	6	5168574	1979	V-175	6	C221500	1990
80	4	4831999	1978	115	6	5600967	1980-81	V-200	6	4839034	1978
80	4	5141097	1979	115	6	6006834	1982	V-200	6	5158929	1979
80	4	5582562	1980-81	115	6	6262961	1983	V-200	6	5464486	1980-81
80	4	5987161	1982	115	6	6440183	1984	V-200	6	6073192	1982
80	4	6232941	1983	115	6	6630171	1985	V-200	6	6203991	1983
80	3	A966142	1987	115	6	A907777	1986	V-200	6	6435503	1984
80	3	B240451	1988	115	6	B117567	1987	V-200	6	6625221	1985
80	3	C100000	1989	115	6	B239242	1988	V-200	6	A913228	1986
85	6	1460999	1963	115	4	C100000	1989	V-200	6	B116662	1987
85	6	1648888	1964	115	4	C221500	1990	V-200	6	B241881	1988
85	4	3493913	1973	125	6	2314956	1968	V-200	6	C100861	1989
85	4	3865695	1974	125	6	2536210	1969	V-200	6	C221500	1990
85	4	4092965	1975	135	6	2839369	1970	210cc	2	A918999	1986
85	4	4590512	1977	135	6	3036066	1971	210cc	2	B114231	1987
85XS	4	4366802	1976	V-135	6	A909997	1986	210cc	2	B233405	1988
90	6	1755444	1965	V-135	6	B116662	1987	210cc	2	B385500	1989
90	6	4854301	1978	V-135	6	B241881	1988	V-220	6	B241881	1988
90	6	5160324	1979	V-135	6	C100861	1989	V-225	6	5615282	1980-81
90	6	5594657	1980-81	V-135	6	C221500	1990	V-250	6	C139860	1989
90	6	5996390	1982	140	6	3293234	1972	V-250	6	C221500	1990
90	6	6246856	1983	140	6	4865678	1978	V-275	6	C139860	1989
90	6	6436123	1984	140	6	5189788	1979	V-275	6	C221500	1990
90	6	6623151	1985	140	6	5625108	1980-81	V-300	6	5611648	1980-81
90	6	A902436	1986	150	6	3502806	1973	V-300	6	6239853	1983



18-5007
TUNE-UP KIT

—CONTENTS—

Part #	O.E. #	Description
18-5153	398-174	Contact Set
18-5206	398-693	Condenser



18-5012
TUNE-UP KIT

—CONTENTS—

Part #	O.E. #	Description
18-5148	394-1100A3	Contact Set
18-5169	394-1130A1	Condenser



18-5139
CONTACT SET

Replaces: 336-4318A2, 336-4318A4, 336-4318A3, 336-3948A3, 336-3948A2
(2) 18-5139 = (1) 336-4318A2



18-5140
CONTACT SET
Replaces: 398-2202

18-5148
CONTACT SET
Replaces: 394-1100A3, 394-1100A2,
394-352A1

18-5153
CONTACT SET
Replaces: 398-174



18-5169
CONDENSER
Replaces: 394-1130A1, 394-1130,
397-741, 397-359



18-5206
CONDENSER
Replaces: 398-693



18-5207
CONDENSER
Replaces: 398-713

HP	Model	Beginning Serial No	Ending Serial No	Contact Set	Condenser	Tune-Up Kit
3.9		1655013	2498155	18-5140	18-5212	18-5008
4		2498136	2693114	18-5140	18-5212	18-5008
4	⑧	2771622	A809600	18-5139	—	—
4.5		4107220	& UP	18-5139	—	—
6		1610265	2529894	18-5140	18-5212	18-5008
7.5	⑤	214324	& UP	18-5153	18-5207	—
7.5		2529895	2721150	18-5140	18-5212	18-5008
7.5		3274633	3801457	18-5139	—	—
9.8		1470349	1865778	18-5153	18-5206	18-5007
9.8		1865776	2708898	18-5140	18-5212	18-5008
9.8		2798057	3263262	18-5139	—	—
9.8		3263263	3795657	18-5139	—	—
10		1120828	112327	18-5153	18-5206	18-5007
10		595628	112327	18-5153	18-5206	18-5007
10		595628	& UP	18-5153	18-5206	18-5007
15		1200114	1499331	18-5153	18-5206	18-5007
20		860979	& UP	18-5153	18-5206	18-5007
20		2827677	3226957	18-5139	—	—
20		3226958	3537530	18-5139	—	—
22		1158546	1499331	18-5153	18-5206	18-5007
25 KF9		377150	379008	18-5148	18-5169	18-5012
25 KG9		377150	379008	18-5148	18-5169	18-5012
25 MARK40		377150	379008	18-5148	18-5169	18-5012
35	350	1271884	1448139	18-5148	18-5169	18-5012
35		1571114	2874703	18-5140	18-5212	18-5008
40		831021	1279684	18-5148	18-5169	18-5012
45		1139538	& UP	18-5148	18-5169	18-5012
30	MK 30 55			—	18-5169	—
30		1271884	1448139	—	18-5169	—
35	35A	1271884	1448139	—	18-5169	—
40		1279685	1476509	—	18-5169	—
45		1476510	1531958	—	18-5169	—
50		1421113	2305100	—	18-5169	—
50		1770179	2116317	—	18-5169	—
50	⑥	2116318	2305100	—	18-5169	—
65 (4CYL)		1542745	2309310	—	18-5169	—

⑤ Phelon Magneto only ⑥ Manual start only ⑧ Except "Gnat"



18-5187
IGNITION COIL

Replaces: 339-856991A1, 339-850227
For: Mariner 200DFI, 225DFI, V135DFI (2.5L), V150DFI (2.5L) and Mercury 3.0DFI

①18-5181D



18-5181
IGNITION COIL

Replaces: 802371A1

①18-5186D



18-5186
IGNITION COIL

Replaces: 339-7370A13, 339-832757A4

18-5158
IGNITION COIL

Replaces: 8M0077471, 879984T01, 879984A1, 879984T00

For: 40-60 EFI 4 Cylinder (0T409000-1C453839) USA (0P153500-1C453839) Belgium, 30-40 EFI 3 Cylinder (0T409000-1B226999) USA (0P153500-0P400999) Belgium, 30-40 EFI 3 Cylinder (1C000001-Up), 75-115 DFI 3 Cylinder (0T980000-Up), 80 JET 3 Cylinder (1B586067-Up), 200-225 DFI 3.0L (1B504989-1B912785), 200 Pro XS DFI 3.0L (1B504989-1B912785), 250 DFI 3.0L (1B528615-Up), 115 Pro XS 3 Cylinder (1B751825-Up), 125 DFI 3 Cylinder (1B736885-Up), 240 EFI SportJet (0E406400-Up), 600 SCi (0M952908-0M962885), 662 SCi (0M956580-Up), 700 SCi (0M962886-Up), 850 SCi (0M952900-Up), 1025 SCi (0M962886-Up), 1075 SCi (0M957032-Up), 1200 SCi (0M956534-Up)



18-5159
IGNITION COIL

Replaces: 339-8M0077473, 339-883778A02, 339-883778A01

For: 1650 (0M965309-Up), 1550 (0M973231-Up), 1100 (0M965965-Up), 1350 (0M965309-Up), 110 Jet (2.5L) (1B690542-Up), 150 Pro XS (2.5L) (1B690542-Up), 200 (DFI) 3.0L (1B504989-Up), 200 (3.0L-DFI)(DTS) (1B504989-Up), 200 Pro XS (DFI) 3.0L (1B504989-Up), 225 (DFI) 3.0L (1B504989-Up), 225 (3.0L-DFI)(DTS) (1B504989-Up), 250 (DFI) 3.0L (1B528615-Up), V-135 (DFI) 2.5L (1B417702-Up), V-150 (DFI) 2.5L (1B417702-Up), V-175 (DFI) 2.5L (1B417702-Up), 2.5XS (2.5L DFI) (0T997974-1E000796)



18-5433
IGNITION COIL

Replaces: 32193A2, 38547, 392-806529A1, 898253T24
(Uses External Resistor)



18-5182
IGNITION COIL

Replaces: 823033
For: 2.5/3/3.3 HP



18-23205
IGNITION COIL

Replaces: 339-859738T1
Fits: Mercury 25 4-Stroke(G590000-P016999), 40 4-Stroke 4 cyl(T178500-T598999), 50 4-Stroke 4cyl(T178500-T598999), 60 4-Stroke 4cyl(T178500-T598999)



18-25400
PULSER COIL

Replaces: 16066004
Fits: Mercury 8/9.9 4-Stroke(R042475 & Up)



18-5154
PENCIL COIL

Replaces: 339-880615T01

Fits: 350SCi Verado (1B716557-2B143542), 200-275 Verado (6 Cyl) (0T980000-2B578935), 300 Verado (0P520553-2B578935), 200 Pro Verado (6 Cyl) (2B034840-2B577715), 250-300 Pro Verado (1B830170-2B577715), 75-115 EFI (1B366823-2B094995), 135-175 Verado (1B227000-2B576734), 200 Verado (4 Cyl) (1B517159-2B578935), 350 Verado (2B141617 & Up), 350 Pro Verado (2B141124 & Up), 400 Verado (2B141124 & Up)



18-25513
COIL, CHARGE

Replaces: 803844T01
Fits: Mercury 8/9.9 4-Stroke(R042475 & Up)



18-5776
SWITCH BOX

Replaces: 339-7452A3, 339-7452A2, 339-7452A1



18-5777
SWITCH BOX

Replaces: 339-7452A15, 339-7452A19, 339-7452A9, 339-7452A7



18-5778
SWITCH BOX

Replaces: 339-7452A14, 339-7452A21, 339-7452A11, 339-7452A8



18-5775
SWITCH BOX

Replaces: 332-7778A6, 332-7778A9, 332-7778A12, 332-7778A7, 332-7778A3, 332-7778A1, 332-5524A1, F7778A9, F749301



18-5787
SWITCH BOX ASSEMBLY

Replaces: 332-4911A8
For: 40 HP



① Items ending in "D" are Display Packaged - Regular number is Non-Display



18-5788
SWITCH BOX ASSEMBLY
Replaces: 339-6222A8
For: 4 HP

18-5790
SWITCH BOX ASSEMBLY
Replaces: 18495A26, 18495A19, 18495A12
For: 75-90 HP

18-5791
SWITCH BOX ASSEMBLY
Replaces: 19052A8, 19052A5, 19052A3
For: 50-60 HP

18-5792
SWITCH BOX ASSEMBLY
Replaces: 16061T
For: 4/5 HP

18-5793
SWITCH BOX ASSEMBLY
Replaces: 823034, 823034T
For: 2.5/3.3 HP

18-5881
SWITCH BOX
Replaces: 332-5772A7, 332-5772A5, 332-5772A3, 332-5772A2, 332-5772A1, F720301

18-1151
DISTRIBUTOR ROTOR SHAFT BEARING
Replaces: 30-20066
SKF France R822T

18-1152
DISTRIBUTOR ROTOR SHAFT BEARING
Replaces: 30-26379
SKF France 6002-2 RSI/HT

4-STROKE ENGINES

HP	Model	Beginning Serial No	Ending Serial No	Coil	Switch Box
30EFI (3 Cyl.)	USA	0T409000	1B226999	18-5158	N/A
30EFI (3 Cyl.)	Belgium	0P153500	0P400999	18-5158	N/A
30EFI (3 Cyl.)	Belgium	1C000001	& Up	18-5158	N/A
40EFI (3 Cyl.)	USA	0T409000	1B226999	18-5158	N/A
40EFI (3 Cyl.)	Belgium	0P153500	0P400999	18-5158	N/A
40EFI (3 Cyl.)	Belgium	1C000001	& Up	18-5158	N/A
40EFI (4 Cyl.)	USA	0T409000	1C453839	18-5158	N/A
40EFI (4 Cyl.)	Belgium	0P153500	1C453839	18-5158	N/A
50EFI (4 Cyl.)	USA	0T409000	1C453839	18-5158	N/A
50EFI (4 Cyl.)	Belgium	0P153500	1C453839	18-5158	N/A
60EFI (4 Cyl.)	USA	0T409000	1C453839	18-5158	N/A
60EFI (4 Cyl.)	Belgium	0P153500	1C453839	18-5158	N/A
75EFI (4 Cyl.)	USA	1B366823	2B094995	18-5154	N/A
90EFI (4 Cyl.)	USA	1B366823	2B094995	18-5154	N/A
115EFI (4 Cyl.)	USA	1B366823	2B094995	18-5154	N/A
135 Verado (4 Cyl.)	USA	1B227000	2B576734	18-5154	N/A
150 Verado (4 Cyl.)	USA	1B227000	2B576734	18-5154	N/A
175 Verado (4 Cyl.)	USA	1B227000	2B576734	18-5154	N/A
200 Verado (4 Cyl.)	USA	1B517159	2B578935	18-5154	N/A
200 Verado (6 Cyl.)	USA	0T980000	2B578935	18-5154	N/A
200 Pro Verado (6 Cyl.)	USA	2B034840	2B577715	18-5154	N/A
225 Verado (6 Cyl.)	USA	0T980000	2B578935	18-5154	N/A
250 Verado (6 Cyl.)	USA	0T980000	2B578935	18-5154	N/A
250 Pro Verado	USA	1B830170	2B577715	18-5154	N/A
275 Verado (6 Cyl.)	USA	0T980000	2B578935	18-5154	N/A
275 Pro Verado	USA	1B830170	2B577715	18-5154	N/A
300 Verado	USA	0P520553	2B578935	18-5154	N/A
300 Pro Verado	USA	1B830170	2B577715	18-5154	N/A
350 Verado	USA	2B141617	& Up	18-5154	N/A
350SCi Verado	USA	1B716557	2B143542	18-5154	N/A
350 Pro Verado	USA	2B141124	& Up	18-5154	N/A
400 Verado	USA	2B141124	& Up	18-5154	N/A

① Two Required ② Three Required ③ Four Required ④ Six Required

2-STROKE ENGINES

HP	Model	Beginning Serial No	Ending Serial No	Coil	Switch Box
4 (2 cyl.prod. of USA)		5589202	& UP	—	18-5788
4		G710613	& UP	—	18-5792
6		A197112	G760299	18-5186 ①	18-5777
6		G760300	T800749	18-5186	—
8		A197112	G760299	18-5186 ①	18-5777
8		A760300	& UP	18-5186	18-5777
210CC	Sail Power	A918999	& UP	18-5186 ①	18-5777
9.9		A197112	G760299	18-5186 ①	18-5777
9.9		G760300	& UP	18-5186	18-5777
10		D038000	G760299	—	18-5777
15		B292414	G760299	18-5186 ①	18-5777
15		G760300	& UP	18-5186	18-5777
15	Sea-Pro	G044027	G437999	18-5186	—
15		G438000	G760299	18-5186	18-5777
15		G760300	& UP	18-5186	—
15	Comm.	G760300	& UP	18-5186	—
15	Non-Comm.	G760300	& UP	18-5186	—
15XD	Comm	G760300	& UP	18-5186	—
15XD	Non-Comm.	760300	& UP	18-5186	—
18		5837437	6443972	18-5186 ①	18-5776
18		6443973	& UP	18-5186 ①	—
18 BULLET	Comm.	6443973	&UP	18-5186	—
20		3537531	3755884	18-5186	—
20		6443973	G044026	18-5186 ①	18-5777
20		G044027	G437999	18-5186	—
20		G438000	G760299	18-5186 ①	18-5777
20	Comm.	G760300	T800999	18-5186	—
20 NON	Comm.	G760300	T800999	18-5186	—
20 JET		G044027	G760299	18-5186	—
20 JET		G760300	& UP	18-5186	—
25		5705532	6443972	18-5186 ①	18-5776
25	Uses Nut Connection	6443973	& UP	18-5186 ①	18-5776
25	Uses Bullet Connection	6443973	& UP	18-5186	18-5777
25		B238464	G044026	18-5186 ①	18-5777
25		G04027	G437999	18-5186	—
25		G438000	G760299	18-5186	—
25	Comm	G760300	& UP	18-5186	—
25	Non-Comm.	G760300	& UP	18-5186	—
30	Jet	C159200	G589999	18-5186 ①	18-5881
35	Uses Nut Connection	6445653	B110788	18-5186 ①	18-5776
35	Uses Bullet Connection	6445653	B110788	18-5186 ①	18-5778
35		B110789	& UP	18-5186	18-5778
40		3336258	3859434	18-5186	—
40 (2 cyl.)		3859435	5823917	18-5186	—
40 (2 cyl.)		5823918	6443973	18-5186 ①	18-5776
40 (4 Cyl.)		C159200	& UP	18-5186 ③	18-5881
45/50 (4 Cyl.)		5531630	& UP	18-5186 ③	18-5881
45 (3 Cyl.)	Jet	G290584	G589999	18-5186	—
50 (4 Cyl.)		5193259	5531629	18-5186	18-5881
50 (4 Cyl.)		5531630	& UP	18-5186	18-5881
50/60 (3 Cyl.)		6428681	D000749	18-5186 ②	18-5775
50/55/60 (3 Cyl.)		D000750	G589999	18-5186 ②	18-5791
55 (3 Cyl.)		D000750	G589999	18-5186	—
60 (3 Cyl.)		6428681	D000749	18-5186	18-5775
60 (3 Cyl.)		D000750	G589999	18-5186	—

① Two Required ② Three Required ③ Four Required ④ Six Required

2-STROKE ENGINES (CONT.)

HP	Model	Beginning Serial No	Ending Serial No	Coil	Switch Box
65 (3 Cyl.)		4382057	4571651	—	18-5775
65 jet		D283222	G437999	18-5186	—
70	MK75,78	1110600	& UP	18-5433	N/A
70 (6 Cyl.)		1296411	1566239	18-5433	N/A
Mercury 70		4571652	5128279	—	18-5775
Mariner70		5128280	& UP	18-5186 ②	18-5775
70		1296411	1566239	18-5433 ①	N/A
70		5579016	6428680	18-5186 ②	18-5775
70/75 (3 Cyl.)		C272000	D283221	18-5186 ②	18-5775
75 (3 cyl)		D283222	G437999	18-5186 ③	18-5790
75 (4 Cyl.)		6432901	& UP	18-5186 ③	18-5881
75 (3 Cyl.)		C222000	D283221	18-5186 ②	18-5775
75 (3 Cyl.)		D283222	G437999	18-5186 ②	18-5790
75DFI (3 Cyl.)		0T980000	& Up	18-5158	N/A
800 (6 Cyl.)		1335465	1566239	18-5433 ①	N/A
Mariner 80 (4 Cyl.)		5144547	& UP	18-5186 ③	—
Merc 80 (4 Cyl.)		5582562	6432900	18-5186 ③	—
80 (4 Cyl.)		4831999	5141096	—	18-5881
80 (4 Cyl.)		5141097	6432900	18-5186	18-5881
80 (3 Cyl.)		A996142	& UP	18-5186 ②	18-5775
80 Jet		D283222	G437999	—	18-5881
80 Jet (3 Cyl.)		1B586067	& Up	18-5158	N/A
85 (6 Cyl.)		1460999	1766823	18-5433 ①	N/A
85 (4 Cyl.)		4366802	4831998	—	18-5881
90		1766824	1869775	18-5433 ①	N/A
90 (6 cyl.)		5299506	& UP	18-5186 ④	18-5775 ①
90 (3 Cyl.)		A996142	D283221	18-5186 ②	18-5775
90 (3 Cyl.)		D283222	G437999	18-5186	18-5790
90 (Powerhead)	Sport Jet	E023150	E095087	—	18-5775
90DFI (3 Cyl.)		0T980000	& Up	18-5158	N/A
95		1869776	1935100	18-5433 ①	N/A
100 (6 cyl.)		1464949	2318585	18-5433 ①	N/A
100 (4 Cyl.)		B209468	G437999	18-5186 ③	18-5881
105 Jet		D082000	G303045	18-5186 ④	18-5775 ①
110		1870204	2314955	18-5433 ①	N/A
110 Jet	2.5L		1B490865	18-5187	N/A
110 Jet	2.5L	1B690542	& Up	18-5158	N/A
115 (6 Cyl.)		5314656	& Up	18-5186 ④	18-5775 ①
115 (6 Cyl.)		5314656	& Up	18-5186	—
115 (4 Cyl.)		B209468	6437999	18-5186 ③	—
115 (3 Cyl.)		C100000	G437999	—	18-5881 ①
115 DFI (3 Cyl.)		0T980000	& Up	18-5158	N/A
115 Pro XS (3 Cyl.)		1B751825	& Up	18-5158	N/A
125 (4 Cyl.)		D283222	G437999	18-5186	18-5881 ①
125 DFI (3 Cyl.)		1B736885	& Up	18-5158	N/A
V-135		A904646	G960499	18-5186 ④	18-5775 ①
V-135 DFI	2.5L	G590000	1B417701	18-5187	N/A
V-135 DFI	2.5L	1B417702	& Up	18-5158	N/A
140		5327663	& Up	18-5186 ④	18-5775 ①
140 Jet		D082000	G960499	18-5186 ④	18-5775 ①
150		A904646	G960499	18-5186	18-5775
V-150	Orange Coil	4868998	A904645	—	18-5775 ①
V-150	Blue Coil	4868998	A904645	18-5186	18-5775 ①
V-150		5129480	G960499	18-5186 ④	18-5775 ①
V-150 XR2		6616991	A904645	18-5186 ④	18-5775 ①

① Two Required ② Three Required ③ Four Required ④ Six Required

2-STROKE ENGINES (CONT.)

HP	Model	Beginning Serial No	Ending Serial No	Coil	Switch Box
V-150 XR4		B242885	D819999	18-5186 ④	18-5775 ①
V-150 DFI	2.5L	G590000	1B417701	18-5187	N/A
V-150 DFI	2.5L	1B417702	& Up	18-5158	N/A
150 Pro XS	2.5L	1B690542	& Up	18-5158	N/A
V-175		4301235	5180108	—	18-5775 ①
V-175,EFI, XR1		5180109	G960499	18-5186 ④	18-5775 ①
V-175 EFI		D000750	G960499	18-5186	—
V-175 DFI	2.5L	T178500	1B417701	18-5187	N/A
V-175 DFI	2.5L	1B417702	& Up	18-5158	N/A
V-200, XR1		5363918	G960499	18-5186 ④	18-5775 ①
V-200 EFI		C100861	G960499	18-5186	—
V-200 DFI		G590000	1B504988	18-5187	—
200 DFI		G960500	T800999	18-5187	N/A
200 DFI	3.0L	T801000	1B504988	18-5187	N/A
200 DFI	3.0L	1B504989	1B912785	18-5158	N/A
200 DFI (DTS)	3.0L	T980000	1B504988	18-5187	N/A
200 DFI (DTS)	3.0L	1B504989	& Up	18-5158	N/A
200XS DFI	2.5L	T235000	1E002110	18-5187	N/A
200 Pro XS	3.0L	1B504989	& Up	18-5158	N/A
200 Sport XS	3.0L	1E000797	1E002583	18-5187	N/A
V-220		B117316	& Up	18-5186 ④	18-5775 ①
V-225	2.4L	5628028	& Up	18-5186 ④	18-5775 ①
V-225 DFI		G590000	B504988	18-5187	—
V-225 PRO XS		B104549	B426650	18-5187	—
225 DFI	3.0L	G590000	1B504988	18-5187	N/A
225 DFI	3.0L	1B504989	1B912785	18-5158	N/A
225 DFI (DTS)	3.0L	T980000	1B504988	18-5187	N/A
225 DFI (DTS)	3.0L	1B504989	& Up	18-5158	N/A
240 EFI SportJet		E406400	& Up	18-5158	N/A
V-250	3.4L	C101891	& Up	18-5186	—
250XS	3.0L	T651945	1E002341	18-5187	N/A
250 DFI	3.0L	1B528615	& Up	18-5158	N/A
V-275	3.4L	C101891	& Up	18-5186	—
V-300	3.4L	5611648	& Up	18-5186	—

① Two Required ② Three Required ③ Four Required ④ Six Required

PREMIUM MARINE SPARK PLUG WIRE LEADS

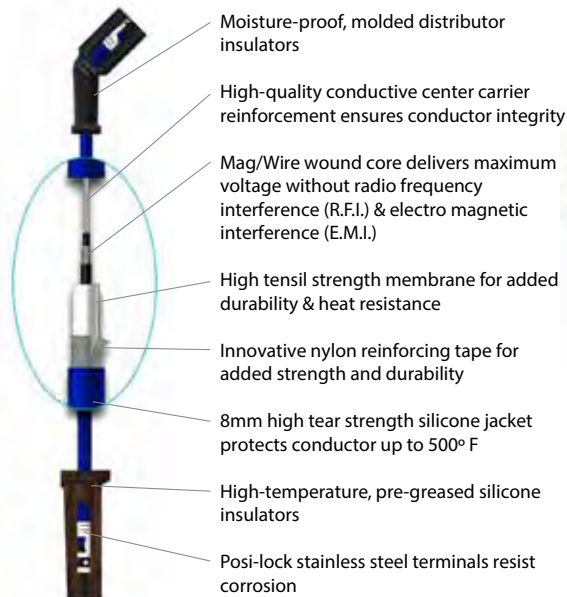

Sierra's MAGFORCE Ignition Wires are "Electronics Friendly" protecting all of your electronic devices and electronic engine controls from RFI and EMI while delivering the maximum amount of voltage. Exact fit design ensures easy installation and years of trouble - free service.



Part #	OEM #	Description
18-8819-1	—	7" Spark Plug Wire (8mm)
18-5228-1	—	9" Spark Plug Wire (8mm)
18-5228-1D③	84-813715A1	9" Spark Plug Wire (8mm)
★ 18-5227-1	—	9" Spark Plug Wire (7mm)
18-5227-1D②③	84-813715A1	9" Spark Plug Wire (7mm)
18-5229-9-1①②	—	22" Spark Plug Wire (7mm)
18-5230-9-1①②	—	10" Spark Plug Wire (7mm)

★ Metallic core wire ① PKG. OF 5 ② 7mm copper core wire
 ③ Items ending in "D" are Display Packaged - Regular number is Non-Display



**18-5225
SPARK PLUG WIRE KIT**
Replaces:
84-99215A26, 84-813706A26, 84-93475A26, 84-93212A1,
84-90816A26
Kit includes 25 ft. Roll of 7 MM Hypalon Ignition Wire With a Metallic Core and a Large Assortment of Three Different End Fittings to Fit Outboard Motors.



**18-5226
IGNITION WIRE**
Metallic Core
100' Spool
7mm Hypalon



PKG. OF 10
**18-5224
18-5224-9①
SPARK PLUG WIRE TERMINAL**
Replaces: 20121, 8M0084600



PKG. OF 10
**18-5750
18-5750-9①
UNIVERSAL SPARK PLUG BOOTS**
Supplied complete w/ Terminal Connector



**18-5752
UNIVERSAL SPARK PLUG BOOT**
8mm



**18-28080
WIRE SET**
Replaces: 84-821945A56
Fits: 225(3.0L Carb) and 225/250(3.0L EFI) (G303045 & Below)



**18-28081
WIRE SET**
Replaces: 84-813706A56
Fits: 225(3.0L Carb) and 225/250(3.0L EFI) w/CDM Modules (G303045 & Up)



**18-28082
WIRE SET**
Replaces: 84-813715A8
Fits: 100, 115, 125 & 80 Jet(4 cyl) (0G301750 & Below)



**18-28083
PLUG WIRE**
Replaces: 84-881908T
(1 WIRE)
Fits: Mercury V6 EFI/DFI/DTS



**18-28084
PLUG WIRE SET**
Replaces: 84-881908T
(3 WIRES)
Fits: Mercury 30-40 EFI 4-stroke(3 cyl)



**18-28085
PLUG WIRE SET**
Replaces: 84-881908T
(4 WIRES)
Fits: Mercury 40-6- EFI 4-stroke (4cyl)



**18-28086
PLUG WIRE SET**
Replaces: 84-881908T
(6 WIRES)
Fits: Mercury V6 EFI/DFI/DTS



**MP41000
IGNITION SWITCH**
Push to Choke — 3 Position — 6 Terminal
Replaces: 87-88107, 87-88107A5
See ELECTRICAL PRODUCTS - Ignition Switches section for wiring diagram.



**MP41070-2
IGNITION SWITCH**
Push to Choke — 3 Position — 6 Wire Sealed Polyester
Replaces: 87-17009A2



**MP51090 (Display Pkg.)
MP51092
IGNITION SWITCH**
3 Position Magneto – OFF- RUN- START PUSH to Choke
Replaces: 87-17009A5



**MP52000 (Display Pkg.)
MP52002
IGNITION SWITCH**
3 Position Magneto – OFF- RUN- START PUSH to Choke – 8 Wire
Replaces: 87-88107A5



**18-6751
MANUAL RELEASE VALVE**
Replaces: 893929A01, 813442A2, 813442A1, 811618A1, 811618, 812843A1, 99660A1
Fits: Most 2 & 4 Stroke Outboards with Integral tilt and trim



**18-6771
TILT/TRIM RESERVOIR**
Replaces: 18525A1

① Priced per package



18-6778
TILT/TRIM RESERVOIR
 Replaces: 883166A1, 883166A2
 For: Motors with 4 screw attachments

(2 Wire w/ Relays)



18-6273-1
TILT/TRIM MOTOR
 High Performance Cartridge Pump
 w/Replaceable Motor
 Replaces: 99186, 99186-1, 99186-T
 Fits: 35-220 HP (1985-93) Mercury/Mariner Outboards
 w/ Design I, 3 Ram, 3 Wire Tilt/Trim Units w/ Side Fill Reservoir. Integral Trim/Tilt System
 Uses relay **18-5737**



18-6757
TILT/TRIM MOTOR
 Fits: Mercury 35-220 HP (1985-92) w/ Design I, 3-Ram Side Fill Integral Trim/Tilt System w/ Square Style Eaton Motor and **18-6273-1** Tilt/Trim Motor Pump Assy
 Uses wire harness **18-6823**

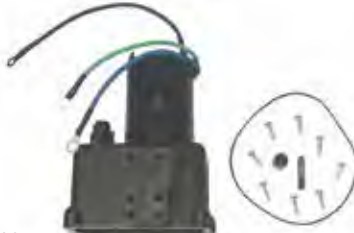

18-6763
TILT/TRIM MOTOR
 Replaces: 92975A28, A32
 To 1984 for Most Mercury Outboards
(Motor and Reservoir Only)



18-6765
TILT/TRIM ASSEMBLY
 Replaces: 823653A5, 92459A4, 823653A9
 Fits: 250,275 HP & V-3.4L,
 Serial No.5611648-UP
(Motor Only)
 Replaces: 17649A02



18-6773
TRIM MOTOR
 Replaces: 828708, 878265A4
 For most late model Mercury/Mariner 1996 & UP (135,150, XR6 Mag III, 175, 200, 225, 250 HP — 105 - 140 HP Jet)



18-6774
TRIM MOTOR
 Replaces: 811628, 828708A1, 878265A6
 High-performance cartridge, replaceable motor. Design II, Ram 3, 2 wire, tilt/trim units. Squared style Eaton
 Uses wire harness **18-6823**

18-6775
TILT/TRIM MOTOR
 Reference OE reservoir **811673 1**
 Contains: All parts necessary, a new 3-wire motor/reservoir, drive shaft coupler, oil seal, O-ring and hardware.
 Yellow fill plug.
 For:

Models	Models
65 Jet	100 4-Cyl.
75 3-Cyl.	115 4-Cyl.
80 Jet	125 4-Cyl.
90 3-Cyl.	

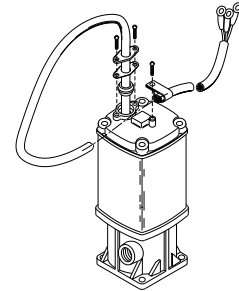

If you have this 3-wire single ram system, use **18-6775**

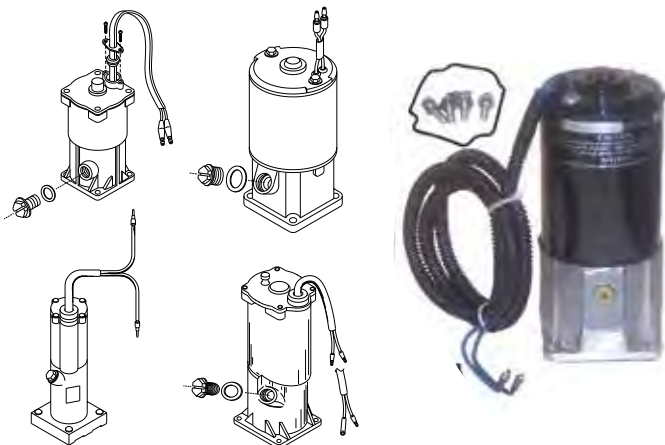

18-6777
TILT/TRIM MOTOR
 Replaces: 818903A1, 819762A4-A7, 819479A1, 819480A1, 81977A8-A9, 822870A1, 830250A3-T3, 832021A1-T4-A2-T2, 855654A1-T2, 19217A1-A5, 854472A2, A3, A4
 Contains: All parts necessary, a new 2-wire motor/reservoir, drive shaft coupler, oil seal, O-ring and hardware. Yellow fill plug. Square base O-ring.

For:

Models	Models
30 Jet	60 3-Cyl., Bigfoot
30 4-Stroke	65 Jet
35	75 3-Cyl.
40 2, 3, 4-Cyl.	75 4-Stroke
40 4-Stroke, Bigfoot	80 Jet
45 4-Stroke, Bigfoot, Bodensee	90 3-Cyl.
50 3-Cyl.	90 4-Stroke
50 4-Stroke, Bigfoot	100 4-Cyl.
55 3-Cyl.	115 4-Cyl.
	125 4-Cyl.

If you have any of the 2-wire single systems, use **18-6777**

18-6448
ELECTRIC START CONVERSION KIT
 Fits: Mercury 30 HP



18-6274
TILT/TRIM MOTOR
 Replaces: 14336A20, 865380A13
 Low pressure / high flow



BATTERY CABLES

Gauge Cable with soldered lug terminals on each end to accept a 3/8" stud.

Part No.	Size	Color	Gauge	Part No.	Size	Color	Gauge
BC88523	2'	red	4	BC88563	6'	red	2
BC88533	2'	black	4	BC88573	6'	black	2
BC88543	4'	red	2	BC88583	8'	red	1
BC88553	4'	black	2	BC88593	8'	black	1

18-9800
COMPRESSION TESTER
 Perfect for hard to reach bottom spark plug holes on older Mercury models.



18-9801
MULTI METER/DVA TESTER
 Replaces: 91-99750A1
 A must for testing Mercury ignition systems.



18-9802
TIMING LIGHT
 Replaces: 91-99379
 Self-powered accurate up to 10,000 RPM's.



18-5864
STATOR
 Replaces: 86617A20
 For: 6-25 HP



18-5865
STATOR
 Replaces: 398-5704A7
 For: 50-70 HP



18-5867
STATOR
 Replaces: 398-9873A4
 For: 135-200 V-6



18-5870
STATOR
 Replaces: 398-832075A4-A21
 For: 30-125 HP
 Replacement for the 18-5873 & 18-5874 kits



18-5871
STATOR
 Replaces: 398-5454A32
 For: 135-300 V6



18-5873
STATOR KIT
 Replaces: 398-832075A6
 For: 100, 115, 125 HP
 Includes 18-5870 stator



18-5874
STATOR KIT
 Replaces: 398-832075A14, 398-832075A20, 398-818535A15, 398-5919A8, 398-5919A6, 398-5919A2, 398-5454A63, 398-5454A25, 398-5454A21
 For: 30-50 HP
 Includes 18-5870 stator



18-5876
STATOR
 Replaces: 398-9610A19
 For: 135 -200 HP





18-5866
STATOR
Replaces: 398-5919A4, 76314A3
For: Mercury 45-50 4 cyl.



18-5854
STATOR
Replaces: 398-5454A17
*Note: Extra black lead goes to engine ground.



18-5855
STATOR
Replaces: 336-3996A7



18-5856
STATOR
Replaces: 398-5255



18-5857
STATOR
Replaces: 398-5454A7



18-5859
STATOR
Replaces: 398-5454A26, 398-5454A22, 398-5919A7, 398-5919A3



18-5860
STATOR
Replaces: 398-5454A35



18-5796
TRIGGER ASSEMBLY
Replaces: 96455A15
For: 6 cyl.



18-5797
TRIGGER ASSEMBLY
Replaces: 96455A8, 96455A1, 68162A6, 68162A3
For: 3 cyl.



18-5798
TRIGGER ASSEMBLY
Replaces: 96455A9, 96455A6, 68162A8, 68162A5, 68162A1
For: 6 cyl.

STATOR & TRIGGER APPLICATIONS

HP	Beg. S/N	End S/N	Trigger	Stator	HP	Beg. S/N	End S/N	Trigger	Stator
6	A197112	G760299	—	18-5864	18XD	6443973	B238463	—	18-5864
7.5	2810637	3274632	—	18-5855	20	2827677	3226957	—	18-5855
8	A197112	G760299	—	18-5864	20	6443973	G044026	—	18-5864
9.8	2798057	3263262	—	18-5855	20, 20 JET	G044027	G437999	—	18-5863
9.9	A197112	G760299	—	18-5864	20, 20 JET	G438000	G760299	—	18-5864
XR10,10 MAG & SEA PRO	D038000	G760299	—	18-5864	20XD	6443973	B238463	—	18-5864
15	A197112	G760299	—	18-5864	25	5705532	6443972	—	18-5864
15 SEA PRO, SUPER 15	G044365	G437999	—	18-5863	25, 25 SEA PRO & MARATHON	B238464	G044026	—	18-5864
15 SEA PRO, SUPER 15	G438000	G760299	—	18-5864	25, 25 SEA PRO & MARATHON	G044027	G437999	—	18-5863
18	5837437	6443972	—	18-5864	25, 25 SEA PRO & MARATHON	G438000	G760299	—	18-5864

APPLICATION CONTINUED ON NEXT PAGE

STATOR & TRIGGER APPLICATIONS

HP	Beg. S/N	End S/N	Trigger	Stator	HP	Beg. S/N	End S/N	Trigger	Stator
25XD	5705532	G044026	—	18-5864	V150	A904646	C100860	18-5798	18-5860 ②
30 2 cyl electric models	G055314	& UP	—	18-5870 **	V150	A904646	C100860	18-5798	18-5871
30 JET 3 cyl electric models	G590000	T408999	—	18-5870 **	V150	C100861	C239552	18-5798	—
30 Jet 4 cyl electric models	C159200	D055047	—	18-5874 **	V150	C239553	D081999	18-5798	18-5860 ③
35 2 cyl	6445653	B110788	—	18-5864	V150	C239553	D081999	18-5798	— †
40 2 cyl	3859435	5823917	—	18-5856 ①	V150	C239553	D081999	18-5798	18-5867 ③⑥
40 2 cyl electric start	G055314	& UP	—	18-5870 **	V150	D082000	G960499	18-5798	18-5876
40 3 cyl electric start	G531301	& UP	—	18-5870 **	V150 EFI	D082000	G960499	18-5798	18-5876
40 3 cyl electric start (Belgium)	9973100	& UP	—	18-5874 **	V150 XRI EFI	D082000	G303045	18-5798	18-5876
40 4 cyl electric start	C159200	D055047	—	18-5874	150 XR-4	B242885	C100860	18-5798	18-5860
40 JET electric start	T178500	& UP	—	18-5874 **	150 XR-4	C100861	C239552	18-5798	—
45 4 cyl manual start only	5531630	B110788	—	18-5866	150 XR-4	C239553	D081999	18-5798	18-5860 ③
45 4 cyl electric models	5531630	& UP	—	18-5870	150 XR-4	C239553	D081999	18-5798	— †
45 JET electric models	G590000	T129554	—	18-5874 **	150 XR-4	C239553	D081999	18-5798	18-5867 ③⑥
50 4 cyl manual start only	4357640	& UP	—	18-5866	150 XR-4, MAG II	C239553	D081999	18-5798	—
50 4 cyl electric models	4357640	& UP	—	18-5870	150 XR-4, MAG II	C239553	D081999	18-5798	18-5867 ③⑥
50 3 cyl	6428681	D000749	18-5797	18-5865	150 XR-6, MAG III	D082000	G960499	18-5798	18-5876
50, 55 3 cyl electric start	G590000	& UP	—	18-5870	V175	4301235	6618750	18-5798	18-5857
50 3 cyl electric models (Belgium)	9973100	& UP	—	18-5870	V175	6618751	C100860	18-5798	18-5871 ④
55 3 cyl electric models	D000750	G589999	—	18-5870	V175	6618751	C100860	18-5798	18-5857 ④
55 3 cyl electric models (Belgium)	9741042	9973088	—	18-5870	V175	6618751	C100860	18-5798	18-5860 ⑤
60 3 cyl	6428681	D000749	18-5797	18-5865	V175	C100861	C239552	18-5798	—
60 3 cyl electric models	G590000	& UP	—	18-5870 **	V175	C239553	D081999	18-5798	18-5860 ③
60 3 cyl electric models (Belgium)	9973100	& UP	—	18-5870 **	V175	C239553	D081999	18-5798	18-5867 ③⑥
60 3 cyl Bigfoot	G590000	G760299	—	18-5874 **	V175	C239553	D081999	18-5798	— †
65 (650) 3 cyl	4382057	4571651	—	18-5865	V175	D082000	G960499	18-5798	18-5876
70 3 cyl	4571652	A996141	18-5797	18-5865	V175 MAG, EFI	D000750	D081999	18-5798	—
75 4 cyl	6432901	& UP	—	18-5859	V175 EFI	D303046	G960499	18-5798	18-5876
75 3 cyl electric models	G438000	& UP	—	18-5870	V175 XRI EFI	D000750	D081999	18-5798	—
80 (80, 800) 4 cyl	4831999	6432900	—	18-5859	V175 XRI EFI	D082000	G303045	18-5798	18-5876
80 JET	G438000	& UP	—	18-5870 **	V200	4839034	6625220	18-5798	18-5857 ④
85 (850) 4 cyl	4366802	4831998	—	18-5859	V200	6618751	C100860	18-5798	18-5860
90 6 cyl	5299506	& UP	18-5798	18-5854	V200	C100861	D081999	18-5798	18-5860 ③
90 3 cyl electric models	G438000	& UP	—	18-5870	V200	C100861	C291519	18-5798	— †
90 3 cyl (Belgium) electric models	9927000	& UP	—	18-5870	V200	C100861	C291519	18-5798	18-5867 ③⑥
100 4 cyl	G438000	& UP	—	18-5870 **	V200	D082000	G960499	18-5798	18-5876
100 4 cyl	9927000	& UP	—	18-5870 **	V200 EFI	C100861	OD081999	18-5798	—
100 4 cyl with voltage reg.	B209468	G437999	—	18-5873 **	V200 EFI	G303046	G960499	18-5798	18-5876
100 4 cyl with voltage reg. (Belgium)	9523024	9926999	—	18-5873 **	V200 XRI EFI	C291520	D081999	18-5798	— †
105 JET	D082000	G960499	18-5798	18-5876	V200 XRI EFI	D082000	G960499	18-5798	18-5876
115 6 cyl	5314656	& UP	18-5798	18-5854	V220	B117316	& UP	—	18-5860
115 4 cyl electric models	G438000	& UP	—	18-5870 **	V225	5628028	& UP	18-5798	18-5857
115 4 cyl electric models (Belgium)	9927000	& UP	—	18-5870 **	SPORTJET MODELS				
115 4 cyl with voltage reg.	C10000	G437999	—	18-5873 **	90	ALL W/RED STATOR		—	18-5870
115 4 cyl with voltage reg. (Belgium)	9559771	9926999	—	18-5873 **	95XR	ALL W/RED STATOR		—	18-5870
125 4 cyl	G438000	& UP	—	18-5870 **	120XR	ALL W/RED STATOR		—	18-5870
125 4 cyl (Belgium)	9927000	& UP	—	18-5870 **	175XR2	ALL		18-5796	—
125 4 cyl with voltage reg.	D283222	G437999	—	18-5873 **					
125 4 cyl with voltage reg. (Belgium)	9793577	9926999	—	18-5873 **					
V135	A904646	C100860	18-5798	18-5860 ②					
V135	A904646	C100860	18-5798	18-5871					
V135	C100861	C239552	18-5798	—					
V135	C239553	D081999	18-5798	18-5860 ③					
V135	C239553	D081999	18-5798	—					
V135	C239553	D081999	18-5798	18-5867 ③⑥					
V135	D082000	G960499	18-5798	18-5876					
140	5327663	& UP	18-5798	18-5854					
140 JET	UP TO	G760299	18-5798	18-5876					
V150	4868998	A904645	18-5798	18-5857					

- ① Electric start models only
- ② Stators with 5/8" laminations only
- ③ Applications with 16 amp Stator and non-louvered flywheel cover
- ④ Applications not using a voltage regulator
- ⑤ Stators with 5/8" laminations and used with 15 amp voltage regulator
- ⑥ Flywheel without screws
- ** May require the purchase of voltage regulator if not currently equipped
- † Applications with clear 40 amp stator with louvered flywheel cover

All Voltage Regulators have built-in capacitors that provide high voltage spike protection.



18-5741

VOLTAGE REGULATOR

Replaces: 815279A2, 815279-1
For: Mercury engines with 16 amp or 40 amp charging system model/years 1989-91

18-5743

VOLTAGE REGULATOR

Replaces: 815279-3, 815279-5, 883072T
For: Mercury engines with 16 amp or 40 amp charging system model/years 1992 to present
*Note: Black wire (not pictured) goes to engine ground.

BLACK
BROWN
RED
YELLOW
GRAY



18-5732

VOLTAGE REGULATOR

Replaces: 893640T01
Fits: 30/40/50/60 EFI 4 Stroke



18-5707

RECTIFIER

Replaces: 62351A1, 62351A2, 816770, 816770T
All applications with square, 3 post rectifier



①**18-5802D**

Display Package

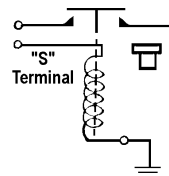

18-5802 SOLENOID

Replaces: 65057A1, 65057T1, 65057, 54981

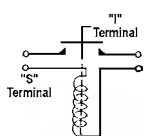

①**18-5808D**

Display Package



18-5808

SOLENOID

Replaces: 47886, 47886T

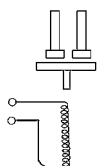

①**18-5810D**

Display Package



18-5810

SOLENOID

Horizontal Post



18-5811

STARTER SOLENOID

Replaces: 809463A1, 8094631, 809463, 8094621, 809462
For: PG260 Series Starters, (Verado 200-275 HP), (75/95 1.5L DFI), (115/135/150/175/200 2.5L DFI), (225 3.0L DFI)

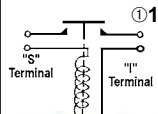

①**18-5815D**

Display Package



18-5815

SOLENOID

Replaces: 89-68258A4, 89-853654A1, 89-76545, 89-76545T, 89-65258, 89-61053, 89-15857

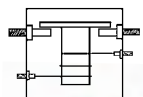

①**18-5816D**

Display Package



18-5816

SOLENOID

Replaces: 89-96054, 89-96054T, 89-91975
Flat Bracket

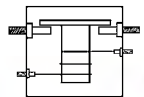

①**18-5817D**

Display Package



18-5817

SOLENOID

Replaces: 89-96158, 89-96158T, 94318, 846070
Vertical Post, Angled Bracket

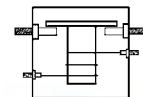

18-5818

SOLENOID

Replaces: 89-818864, 89-818864T

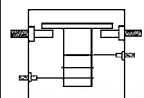

18-5819

SOLENOID

Replaces: 89-818997A1, 89-818997T1, 89-818997A2

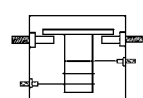

18-5820

SOLENOID

Replaces: 89-818999A2, 89-825842A1, 89-850188T1



18-5821

STARTER SOLENOID

Replaces: 89-825096T, 825096T01
Fits: 9.9 4-Stroke(1999 & Up), 15 4-stroke (1999 & Up), 30 4-stroke(2002 & Up), 40/50/60 4-stroke(2001 & Up), 75/90 4-stroke(2000 & Up)

①**18-5822D**

Display Package



18-5822

CHOKE SOLENOID

Replaces: 54293A13, 54293A10, 54293A4
Fits: 75 4cyl (1984 & Up), V150 (1978 & Up), V150 Magnum (1978-85), V150 Marathon (1978-85), V150 XR 2 (1978-85), V1500 (1978-85), V175 (1976-99), V1750 (1976-88), V200 (1978 & Up), V2000 (1978-88)

APPLICATION ON NEXT PAGE

① Items ending in "D" are Display Packaged - Regular number is Non-Display



18-5834
SOLENOID
Replaces: 89-817109A2
For: 75 HP (3 cyl.) S/N G127500 & UP



18-5836
SOLENOID
Replaces: 25661, 256611, 25661T1



18-5729
POWER TRIM RELAY
Replaces: 87-18211
For: 35 (2 cyl.) (with Ram Trim)
OC159200 & UP
60 (3 cyl.) (with Ram Trim)
OB122920 - OD000749



18-5737
POWER TRIM RELAY
Replaces: 87-19761
For: 40 (4 cyl.) (with Relays)
OC159200 & UP



18-5849
RELAY, SHROUDED, TRIM
Replaces: 882751A1,
828151A1, 828151, 882751A2
Fits: Power Trim Relay used on most
2-stroke and 4-stroke (non-Verado®)
engines.



18-5850
RELAY, SHROUDED
Replaces: 882751A04
Fits: 135hp. - 350hp Verado (2005 - Current);
496Mag & 496HO (2004 - Current);
8.1HO (2004 - Current)



18-5851
RELAY, SHROUDED
Replaces: 865202T,
807057T, 807057



18-5852
RELAY, SHROUDED
Replaces: 821509T01, 821509,
853292
Fits: Four-Stroke: 45hp
(OG231123-OG472132); 50hp.
(OG231123-OT178499)

① Items ending in "D" are Display Packaged - Regular number is Non-Display

SOLENOID APPLICATION

HP	Beg. S/N	End. S/N	Starter Solenoid/Relay	Power Trim Solenoid	Power Trim Relay
4-Stroke					
9.9 (4-Stroke)(323cc)	0G760300	0T979999	18-5821	—	—
15 (4-Stroke)(323cc)	0G760300	1B727495	18-5821	—	—
30 (4-Stroke) Carb	0G760300	& Up	—	—	18-5849
30 (4-Stroke) EFI	0T409000	1B226999	18-5821	—	18-5849
40 (4-Stroke)(3 cyl) Carb	0G760300	& Up	—	—	18-5849
40 (4-Stroke)(3 cyl) EFI	0T409000	& Up	18-5821	—	18-5849
40 (4-Stroke)(4 cyl) Carb	0T228405	0T598999	18-5821	—	18-5849
40 (4-Stroke)(4 cyl) EFI	0T409000	& Up	18-5821	—	18-5849
45 (4-Stroke) Bodensee	0G231123	0G472132	18-5821	—	18-5852
45 (4-Stroke) Bodensee	0G472133	0T178499	18-5821	—	18-5849
50 (4-Stroke)	0G231123	0T178499	18-5821	—	18-5852
50 (4-Stroke)(4 cyl) Carb 996cc	0T178500	0T598999	18-5821	—	18-5849
50 (4-Stroke)(4 cyl) EFI 996cc	0T409000	& Up	18-5821	—	18-5849
60 (4-Stroke)(4 cyl) Carb 996cc	0T178500	0T598999	18-5821	—	18-5849
60 (4-Stroke)(4 cyl) EFI 996cc	0T409000	& Up	18-5821	—	18-5849
75 (4-Stroke) Carb 1596cc	0G960500	1B226999	18-5821	—	—
75 (4-Stroke) EFI 1596cc	1B366823	& Up	18-5834	—	—
90 (4-Stroke) Carb 1596cc	0G960500	1B226999	18-5821	—	—
90 (4-Stroke) EFI 1731cc	1B366823	& Up	18-5821	—	—
115 (4-Stroke) EFI w/ 2 relay trim	0T178500	0T800999	—	—	18-5849
115 (4-Stroke) EFI 1731cc	0T809000	1B366822	—	—	18-5849
115 (4-Stroke) EFI 1731cc	1B366823	& Up	18-5821	—	—
135 (4-Stroke) Verado	1B227000	& Up	18-5850	—	18-5850
150 (4-Stroke) Verado	1B227000	& Up	18-5850	—	18-5850
175 (4-Stroke) Verado	1B227000	& Up	18-5850	—	18-5850
200 (4-Stroke)(4 cyl) Verado	1B517159	& Up	18-5850	—	18-5850
200 (4-Stroke)(6 cyl) Verado	0T980000	& Up	18-5850	—	18-5850
225 (4-Stroke)(6 cyl) Verado	0T980000	& Up	18-5850	—	18-5850
250 (4-Stroke)(6 cyl) Verado	0T980000	& Up	18-5850	—	18-5850
275 (4-Stroke)(6 cyl) Verado	0T980000	& Up	18-5850	—	18-5850
300 (4-Stroke)(6 cyl) Verado	1B517434	& Up	18-5850	—	18-5850
350 (4-Stroke)(6 cyl) Verado	1B716557	& Up	18-5850	—	18-5850
2-Stroke					
HP	Beg. S/N	End. S/N	Starter Solenoid	Power Trim Solenoid	Power Trim Relay
6/8/9.9	A197112	OD280999	18-5816	—	—
15	A197112	OD280999	18-5816	—	—
18	5837437	& UP	18-5816	—	—
20	4709593	6443972	18-5815	—	—
20	6443973	0G044026	18-5816	—	—
25	5705532	G044026	18-5816	—	—
30 (2 cyl) 644cc	G053314	& UP	—	—	18-5849
30 JET non-handle	C159200	G589999	18-5816	—	—
35 2 cyl (w/ 3 Ram Trim)	6445653	C159199	18-5817	18-5817	—

① Use 18-5817 for applications with circuit breaker and fuse. ③ For units with 10-32, 5/16-18 terminals. ⑤ For design II applications use 18-5820.
② For units with 8-32, 1/4-20 terminals. ④ Use 18-5818 if off white solenoid is needed. ⑥ w/rubber bushing solenoid

SOLENOID APPLICATION

HP	Beg. S/N	End. S/N	Starter Solenoid	Power Trim Solenoid	Power Trim Relay
35 2 cyl (w/ 1 Ram Trim)	C159200	& UP	18-5817	—	18-5729
40 2 cyl	2874704	5556229	18-5836	—	—
40 2 cyl	5556230	5823917	18-5815	—	—
40 2 cyl	5823918	G053313	18-5817	—	—
40	G053314	& UP	18-5816 ⑤	—	—
40 4 Cyl.(w/solenoids)	C159200	& UP	18-5816	18-5820	—
40 4 Cyl.(w/relays)	C159200	& UP	18-5816	—	18-5737
45 4 Cyl.(w/o circuit breaker)	5531630	6146848	18-5815	18-5815	—
45 4 Cyl.(w/circuit breaker)	5531630	6146848	18-5815	18-5817	—
45 4 Cyl.(w/o circuit breaker)	6146849	B110788	18-5817	18-5815 ①	—
45 4 Cyl.(w/circuit breaker)	6146849	B110788	18-5817	18-5817	—
45 4 Cyl.	B110789	& UP	18-5817	18-5817	—
45 JET (w/flush mount solenoid)	D000750	G290584	18-5816	—	—
45 JET	G290585	G589999	18-5820	—	—
50	3008819	4140999	18-5836	—	—
50	4141000	5531629	18-5815	—	—
50 4 Cyl.(w/circuit breaker)	5531630	6146848	18-5815	18-5815 ①	—
50 4 Cyl.(w/circuit breaker)	5531630	6146848	18-5815	18-5817	—
50 4 Cyl.(w/o circuit breaker)	6146849	& UP	18-5817	18-5815 ①	—
50 4 Cyl.(w/circuit breaker)	6146849	& UP	18-5817	18-5817	—
50 3 Cyl.	6428681	B122929	18-5816	18-5817	—
50 3 Cyl. (w/ 3 Ram Trim)	B122930	C160935	18-5817	18-5817	—
50 3 Cyl. (w/ 1 Ram Trim)	B122930	D000749	18-5817	—	18-5729
50 3 Cyl.	D000750	G290584	18-5816	—	18-5849
50 3 cyl	G290585	G589999	18-5820	—	18-5849
50 3 cyl	G590000	& UP	—	—	18-5849
55 3 Cyl.	D000750	G290584	18-5816 ⑤	—	18-5849
55 3 Cyl.	G290585	G589999	18-5820	—	18-5849
60 3 Cyl.	6428681	B122929	18-5816	18-5817	—
60 3 Cyl. (w/solenoids)	B122930	D000749	18-5817	18-5817	—
60 3 Cyl. (w/relays)	B122930	D000749	18-5817	—	18-5729
60 3 Cyl.	D000750	G290584	18-5816 ⑤	—	18-5849
60 3 Cyl.	G290585	G589999	18-5820	—	18-5849
65 4 Cyl.	2446775	3293183	18-5836	—	—
65 3 Cyl.	3547987	4571651	18-5815	—	—
65 JET	G127500	& UP	18-5834	—	—
70 3 Cyl.	4571652	5579016	18-5815	—	—
70 3 Cyl.	5579017	6104369	18-5815	18-5815 ①	—
70 3 Cyl.	6104370	6428680	18-5816	18-5815 ①	—
70 3 Cyl.	A996147	& UP	18-5817	18-5817	—
75 4 Cyl.	6432901	& UP	18-5816	18-5817	—
75 3 cyl w/ 1 Ram Trim	C222000	D252460	—	—	18-5849
75 3 Cyl.	D252461	G127499	18-5817	18-5819	—
75 3 Cyl.	G127500	G360002	18-5834	18-5819	—
75 3 Cyl.	G360003	& UP	18-5834	—	18-5849
75 Optimax 3 cyl (1.5L)	T801000	& UP	18-5834	—	18-5849
80	2559001	3493912	18-5836	—	—
80 4 Cyl.	4831999	5582561	18-5815	—	—
80 4 Cyl.	5582562	6030903	18-5815	18-5815 ①	—
80 4 Cyl.	6030904	6432900	18-5816	18-5815 ①	—
80 3 Cyl.	A996142	& UP	18-5817	18-5817	—
80 JET 4 cyl	D283222	& UP	18-5834	—	—
80 JET 3 cyl	B586067	& UP	18-5834	—	18-5849
85 4 Cyl.	3493913	3865694	18-5836	—	—
85 4 Cyl.	3865695	4831998	18-5815	—	—
90	4845301	5299505	18-5815	18-5815	—
90	5299506	6026608	18-5815	18-5815 ①	—
90	6026609	6436122	18-5816	18-5815 ①	—
90	6436123	& UP	18-5816	18-5817	—
90 3 Cyl.	A996142	C221999	18-5817	18-5817	—
90 3 Cyl. w/ 1 Ram Trim	C222000	D252460	—	—	18-5849
90 3 Cyl.	D252461	G127499	—	18-5819	—
90 3 Cyl.	G127500	G360002	18-5834	18-5819	—
90 3 Cyl.	G360003	& UP	18-5834	—	18-5849
90 Optimax 3 cyl (1.5L)	T801000	& UP	18-5834	—	18-5849
100 6 Cyl.	2318586	3253111	18-5836	—	—
100 4 Cyl. w/ 1 Ram Trim & 5/16-18 starter terminal	B209468	D252460	18-5834	—	18-5849
100 4 Cyl. w/ 3 Ram Trim & 5/16-18 starter terminal	B209468	D252460	18-5834	—	—
100 4 Cyl.	D252461	G359967	18-5834	18-5819	—
100 4 Cyl.	G359968	& UP	18-5834	—	18-5849
105 JET w/ flush mounted starter solenoid	D082000	G303045	18-5815	—	—
105 JET w/ rubber mounted starter solenoid	D082000	G303045	18-5834	—	—
105 JET	G303046	& UP	18-5834	—	—
110 6Cyl.	1870204	2314955	18-5836	—	—
115	2836019	4112634	18-5836	18-5836	—
115	4112635	5600966	18-5815	18-5815	—
115	5600967	6051525	18-5815	18-5815 ①	—
115	6051526	6436122	18-5816	18-5817 ①	—
115	6436123	& UP	18-5816	18-5817	—
115 4 Cyl. w/ 3 Ram Trim & 5/16-18 starter terminal	C100000	D252460	18-5834	—	—
115 4 Cyl. w/ 1 Ram Trim & 5/16-18 starter terminal	C100000	D252460	18-5834	—	18-5849
115 4 Cyl.	D252461	G359967	18-5834	18-5819	—
115 4 Cyl.	G359968	& UP	18-5834	—	18-5849
115 Optimax 3 cyl (1.5L)	T801000	& UP	18-5834	—	18-5849

① Use 18-5817 for applications with circuit breaker and fuse.

③ For units with 10-32, 5/16-18 terminals.

⑤ For design II applications use 18-5820.

② For units with 8-32, 1/4-20 terminals.

④ Use 18-5818 if off white solenoid is needed.

⑥ w/rubber bushing solenoid

SOLENOID APPLICATION

HP	Beg. S/N	End. S/N	Starter Solenoid	Power Trim Solenoid	Power Trim Relay
115 Pro XS	B751825	& UP	18-5834	—	18-5849
125	2314956	3253111	18-5836	—	—
125 4 Cyl.	D283222	G359967	18-5834	18-5819	—
125 4 Cyl.	G359968	& UP	18-5834	—	18-5849
125 Optimax 3 cyl (1.5L)	B736885	& UP	18-5834	—	18-5849
135	2839369	3293233	18-5836	—	—
V135	A904646	C100860	18-5815 ③	18-5817	—
V135	A904646	C100860	18-5816 ②	18-5817	—
V135	C100861	C239552	18-5815	18-5817	—
V135	C239553	D081999	18-5815 ④	18-5817	—
V135 (w/flush mounted solenoid)	D082000	G201874	18-5815	18-5819	—
V135 (w/rubber bushing solenoid)	D082000	G201874	18-5834	18-5819	—
V135 (w/flush mounted solenoid)	G201875	G303045	18-5815	—	18-5849
V135 (w/rubber bushing solenoid)	G201875	G303045	18-5834	—	18-5849
V135	G303046	& UP	18-5834	—	18-5849
V135 DFI	G590000	& UP	18-5834	—	18-5849
140	3293234	3502805	18-5836	18-5836	—
140	4865678	& UP	18-5815	18-5815	—
140 JET	G303046	T178499	18-5834	—	18-5849
150	3502806	4121434	18-5836	18-5836	—
150	4121435	4865677	18-5815	18-5836	—
150 XS	4868648	5327662	18-5815	18-5815	—
V150	4868998	6042945	18-5815	18-5817	—
V150	6042946	A904645	18-5816	18-5817	—
V150	A904646	C100860	18-5815 ③	18-5817	—
V150	A904646	C100860	18-5817 ②	18-5817	—
V150	C100861	C239552	18-5815	18-5817	—
V150	C239553	D081999	18-5815 ④	18-5817	—
V150, 150 EFI w/flush mounted solenoid	D082000	G201874	18-5815	18-5819	—
V150, 150EF w/rubber mount solenoid	D082000	G201874	18-5834	18-5819	—
V150, 150 EFI w/flush mounted solenoid	G201875	G303045	18-5815	—	18-5849
V150, 150EF w/rubber mount solenoid	G201875	G303045	18-5834	—	18-5849
V150, 150 EFI	G303046	& UP	18-5834	—	18-5849
V150 DFI	G590000	& UP	18-5834	—	18-5849
150 XR-4/Magnum II	B242885	C239552	18-5815	18-5817	—
150 XR-4/Magnum II w/standard color solenoid	C239553	D081999	18-5815	18-5817	—
150 XR-4/Magnum II w/off white color solenoid	C239553	D081999	18-5815	18-5818 ⑥	—
150 XR-6/Magnum III w/flush mounted solenoid	D082000	G201874	18-5815	18-5819	—
150 XR-6/Magnum III w/rubber mounted solenoid	D082000	G201874	18-5834	18-5819	—
150 XR-6/Magnum III	G201875	G303045	18-5815	—	—
150 XR-6/Magnum III w/flush mounted solenoid	G201875	G303045	18-5815	—	18-5849
150 XR-6/Magnum III w/rubber mounted solenoid	G201875	G303045	18-5834	—	18-5849
150 XR-6/Magnum III	G303046	& UP	18-5834	—	18-5849
V175	4301235	6618750	18-5815	18-5815	—
V175	6618751	C239552	18-5816 ②	18-5817	—
V175	6618751	C239552	18-5815 ③	18-5817	—
V175	C100861	C239552	18-5815	18-5817	—
V175	C239553	D081999	18-5815 ④	18-5817	—
V175, 175 EFI w/ flush mounted solenoid	D082000	G201874	18-5815	18-5819	—
V175, 175 EFI w/ rubber mounted solenoid	D082000	G201874	18-5834	18-5819	—
V175, 175 EFI w/ flush mounted solenoid	G201875	G303045	18-5815	—	18-5849
V175, 175 EFI w/ rubber mounted solenoid	G201875	G303045	18-5834	—	18-5849
V175, 175 EFI	G303046	& UP	18-5834	—	18-5849
V175 DFI	G590000	& UP	18-5834	—	18-5849
V175 Pro XS	B516339	& UP	18-5834	—	18-5849
V200	4839034	6073191	18-5815	18-5815	—
V200	6073192	6225220	18-5816	18-5817	—
V200	6625221	C100860	18-5816 ②	18-5817	—
V200	6625221	C100860	18-5815 ③	18-5817	—
V200	C100861	C291519	18-5815	18-5817	—
V200 (2.5L)	C291520	D081999	18-5815 ④	18-5817	—
V200 w/ flush mounted solenoid	D082000	G201874	18-5815	18-5819	—
V200 w/ rubber mounted solenoid	D082000	G201874	18-5834	18-5819	—
V200, 200 EFI (w/flush mounted solenoid)	D082000	G201874	18-5815	18-5819	—
V200, 200 EFI (w/rubber bushing solenoid)	D082000	G201874	18-5834	18-5819	—
V200, 200 EFI (w/flush mounted solenoid)	G201875	G303045	18-5815	—	18-5849
V200, 200 EFI (w/rubber bushing solenoid)	G201875	G303045	18-5834	—	18-5849
V200, 200 EFI	G303046	& UP	18-5834	—	18-5849
V200 DFI	G386496	& UP	18-5834	—	18-5849
V220 (Laser)	B117316	& UP	18-5815	18-5817	—
V225 2.4L	5628028	& UP	18-5815	18-5815	—
V225 3.0L	D280813	G129221	18-5834	18-5819	—
V225 3.0L	G129222	G303045	18-5834	18-5819	—
V225 3.0L	G129222	G303045	18-5834	—	18-5849
V225 3.0L	G303046	& UP	18-5834	—	18-5849
V225 DFI	G590000	& UP	18-5834	—	18-5849
V225 Sea Pro / Marathon	G245605	& UP	18-5834	—	18-5849
V225 Pro XS	B104549	& UP	18-5834	—	18-5849
V225/250 EFI	G129222	& UP	18-5834	—	18-5849
V250XB	G980600	& UP	18-5834	—	18-5849
V250 Pro XS	B426561	& UP	18-5834	—	18-5849
V250/275 (3.4L)	C101891	& UP	18-5815	18-5817	—
300 (3.4L)	5611648	& UP	18-5815	18-5817	—

① Use 18-5817 for applications with circuit breaker and fuse.

③ For units with 10-32, 5/16-18 terminals.

⑤ For design II applications use 18-5820.

② For units with 8-32, 1/4-20 terminals.

④ Use 18-5818 if off white solenoid is needed.

⑥ w/rubber bushing solenoid



18-5929
ALTERNATOR
 Replaces: 892940T
 All Verado's



18-6454
ALTERNATOR
 Replaces: 875285T1, 8M0064021,
 889955A03, 834832, 881248T, 857006T
5S/I 50 amp Spool mount
 Fits: 2.5L



18-6455
ALTERNATOR
 Replaces: 875286T,
 875286A1, 881247A1
5S/I 50 amp
 Fits: 1.5L and 3.0L
 For: 200 DFI, 200 DFI/DTS, 225 EFI, 225 EFI, Sea Pro, 225 DFI/DTS, 250 EFI



18-6840
ALTERNATOR
 Replaces: 50-897755T, 897755T
 Fits: 75-115HP EFI (4-Stroke)



18-18000
SERPENTINE BELTS
 Replaces: 57-892318
 For: 75 DFI (2005-06),
 90 DFI (2005-06), 15 DFI (2004-06)

18-18100
SERPENTINE BELTS
 Replaces: 57-828507Q4
 For: 135 DFI (1998-Up),
 150 DFI (1998-Up), 175 DFI (2001-Up)



18-15128
SERPENTINE BELTS
 Replaces: 57-880566014
 Fits: All Verados-135-275HP

18-15129
SERPENTINE BELTS
 Replaces: 57-828507 1
 Fits: 200 DFI (1997 & Up), 225 DFI (1998 & Up)

18-6500
SERVICE END ALTERNATOR HARNESS
 Replaces: 84-881262A2
 Fits: Optimax (1998-01) For: Delco Alternators



ALL STARTERS ARE COUNTER CLOCKWISE ROTATION



18-6435
STARTER
 Replaces: 50-888161T,
 50-884044T, 50-859377T, 50-893888T
 Fits: 40,50,60 HP 4 Stroke 4 Cyl, 0P094500 & UP;
 50,60 HP EFI 4 Stroke 4 Cyl, 0P153500-UP



18-6436
STARTER
 Replaces: 50-859171T, 50-834749,
 50-898265001
 Fits: 40HP Italy 4 Stroke 0G760300-UP: 45HP
 Bodensee 0G760300-UP: 50HP 4 Stroke
 0G760300-UP: 50HP Bigfoot 4 Stroke 0G760300-UP



18-6437
STARTER
Replaces: 50-888151T, 50-830308T, 50-859169T, 50-893886T
Fits: 25HP 4 Stroke OG760300 & UP



18-6438
STARTER
Replaces: 50-888160T, 50-884045T, 50-859170T, 50-854636T, 50-893887T
Fits: 30,40HP 3 Cyl 4 Stroke OG760300 & UP



18-6425
STARTER
Replaces: 50-804312T1
For: 4 Stroke 75 HP, and 90HP except Verado



18-6440
STARTER
Replaces: 50-892339T, 50-853329T
Fits: 90, V135, V150, V175, V200, 2.5L DFI, 0T178500 & UP; 200, 250HP, 3.0L, 0T467442 & UP, and Inline 4 and 6 cyl. Verados. Models with solenoid operated bendix.



18-5601
STARTER
Replaces: 50-55601, 50-55601A2, 50-38890A1
Fits: 35-50 HP models



18-5602
STARTER
Replaces: 50-67341, 50-58788A3, 50-893891T, 50-44369A1
Fits: 35-40 HP, 2 cyl. & 50 HP, 4 cyl. models



18-5642
STARTER
Replaces: 50-66015, 50-66015T, 50-893891T, 50-44369A1
Fits: 50-90 HP models (1976-99), 10 Tooth Drive Gear



18-6282
STARTER
Replaces: 50-8329972, 50-832997003
Fits: Mercury V6 Jet (1996 and up), 8 Tooth Drive Gear



18-6283
STARTER
Replaces: 50-8331535, 50-898265008
For: Mercury 2.5 DFI(1999 and up), 200HP V6 DFI(1996-99), 225HP V6 DFI(1998 and up), 3.0L V6(1999 and up) 9 Tooth Drive Gear
Uses Drive Kit 18-5658



18-5605
STARTER
Replaces: 50-73521, 50-73521T, 50-898265005
Fits: 40-50 HP models



18-5606
STARTER
Replaces: 50-44369, 50-60315, 50-44369A1
Fits: 50-70 HP models (1976-94)



18-5608
STARTER
Replaces: 50-44415, 50-77141, 50-79472, 50-44414, 50-79472 1, 50-893893
Fits: 2.5L, 3.4L & 135 Jet models

ALL STARTERS ARE COUNTER CLOCKWISE ROTATION



18-5610
STARTER
 Replaces: 50-66015T, 50-660151, 50-660153, 50-893892T, 50-893892T
(8 Tooth)
 Fits: 1.7L, 1.9L & 1.4L (1988-2008)



18-5611
STARTER
 Replaces: 50-90983A-1, 50-90983T1, 50-8M0033984
 For: 6-15 HP (1986-96), 18-25 HP (1980-87), 10 tooth drive gear



18-5620
STARTER
 Replaces: 50-818445-3, 50-818445-2, 50-818445 5, 50-898265009
 Fits: 2.5L, 3.0L & 225-250 HP models (1993-2000)



18-5621
STARTER
 Replaces: 50-822462, 50-822462T1, 50-893890T
 Fits: 30-60 HP models



18-5636
STARTER
 Replaces: 50-57465A1, 50-57867, 50-64975, 50-72467, 50-58788A3
Length: 11 1/2"
 Fits: 65-175 HP models (1973-88)



18-6824
OUTBOARD STARTER
 Replaces: 50-60594A, A1, T01
 Fits: 2.0, 2.4, and 2.5L Racing Engines



18-6825
STARTER
 Replaces: 50-86976
(9 Tooth)
 Fits: 200-225HP V6 engines



18-6828
STARTER
 Replaces: 50-41583
 Fits: 35, 35 (2 CYL.), 402, 40 (2 CYL.)



18-6829
STARTER
 Replaces: 50-852570, T, 50-857065, 50-859168, T, 859168, T
 Fits: Mercury, Mariner 9.9-15HP 4-Stroke Engines



18-6864
STARTER
 Replaces: 50-819271, 50-820193A1
 Fits: Mercury 40-50HP Engines



18-6940
STARTER
 Replaces: 50-825991A2
 Fits: 9.9HP 4-Stroke Engines



18-6943
STARTER
 Replaces: 50-893894
 Fits: 9.9-15HP Engines

APPLICATION ON NEXT PAGE

ALL STARTERS ARE COUNTER CLOCKWISE ROTATION



**18-6250
STARTER REPAIR KIT**
Prestolite
2 Brush



**18-6251
STARTER REPAIR KIT**
Prestolite
4 Brush



**18-5697
DRIVE BRUSH KIT**
Replaces: 75384
See chart below for additional application



**18-5650
DRIVE ASSEMBLY**
Replaces: 57380
See chart below for additional application



**18-5656
DRIVE ASSEMBLY**
Replaces: 68575
(10 Tooth)
See chart below for additional application



**18-5658
DRIVE ASSEMBLY**
Replaces: 86177, 86177 1
(9 Tooth)
See chart below for additional application



**18-5674
DRIVE ASSEMBLY**
Replaces: 75661, 13310T1
(8 Tooth)
See chart below for additional application

MERCURY

H.P.	Beg. Serial #	Ending Serial#	O.E.M #	Starter #	O.E. #	Drive Assembly	O.E. #	Drive Tooth Count	Brush Kit	O.E. #
6	A197112	& Up	50-8M0033984/50-90983A1	18-5611	96562		—	10	—	—
7.5	3801458	4851692	50-73531	⑥	96562		96562/75427	10	18-5697	75384
7.5	4851693	& Up	50-78011	⑥	96562		96562/75427	10	18-5697	75384
8/9.9/15	A197112	& Up	50-8M0033984/50-90983A1	18-5611	96562		—	10	—	—
18	5837437	& Up	50-8M0033984/50-90983A1	18-5611	96562		—	—	—	—
20	4709593	6443973	50-76275	⑥	96562		96562/75427	10	—	—
20	6443973	& Up	50-8M0033984/50-90983A1	18-5611	96562		—	10	—	—
25	5705532	& Up	50-8M0033984/50-90983A1	18-5611	96562		—	10	—	—
30 2 cyl.	G053314	& Up	50-893890T/50-822462	18-5621	N.L.A.	18-5656	68575	10	18-5697	75384
30 JET	G159200	G589999	50-898265005/50-73521	18-5605	68575 3	18-5656	68575	10	18-5697	75384
30 JET 3 cyl.	G590000	T408999	50-893890T/50-822462	18-5621	90643	18-5656	68575	10	18-5697	75384
35/40 2 cyl.	6445653	& Up	50-41583T/50-41583	⑥	N.L.A.		43076/ 43076T	10	18-5697	75384
35/40 2 cyl.	6445652	& DOWN	50-55601A2/50-55601	18-5601	N.L.A.	18-5650	57380	9	18-5697	75384
40 2 cyl.	G053314	& Up	50-893890T/50-822462	18-5621	68575 3	18-5656	68575	10	18-5697	75384
40H.P. 3 cy.	G590000	G760299	50-893890T/50-822462	18-5621	68575 3	18-5656	68575	10	18-5697	75384
40 3 cyl.	G760300	& Up	50-893890T/50-822462	18-5621	68575 3	18-5656	68575	10	18-5697	75384
40 4 cyl.	C159200	& Up	50-898265005/50-73521	18-5605	68575 3	18-5656	68575	10	18-5697	75384
40 JET	T178500	& Up	50-893890T/50-822462	18-5621	68575 3	18-5656	68575	10	18-5697	75384
45 4 cyl.	5531630	& Up	50-898265005/50-73521	18-5605	68575 3	18-5656	68575	10	18-5697	75384
45 JET	D000750	G589999	50-44369A1/50-65436/50-60315	18-5606 ⑧	68575 3	18-5656				
45 JET	G590000	T129554	50-893890T/50-822462	18-5621	68575 3	18-5656	68575	10	18-5697	75384
50 4 cyl.	4357639	& Below	50-55601A2/50-38890A1	18-5601	N.L.A.	18-5650	57380	9	18-5697	75384
50 4 cyl.	4357640	& Up	50-898265005/50-73521	18-5605	68575 3	18-5656	68575	10	18-5697	75384
50 3 cyl.	B122930	G589999	50-44369A1	18-5606 ⑧	68575 3	18-5656	—	—	—	—
50 3 cyl.	G590000	& Up	50-893890T/50-822462	18-5621	68575 3	18-5656	68575	10	18-5697	75384
55 3 cyl.	D000750	G589999	50-44369A1	18-5606 ⑧	68575 3	18-5656	—	—	—	—
55 3 cyl.	G590000	& Up	50-893890T/50-822462	18-5621	68575 3	18-5656	68575	10	18-5697	75384
60 3 cyl.	6428681	G589999	50-44369A1/50-65436/50-60315	18-5606 ⑧	68575 3	18-5656				
60 3 cyl.	G590000	& Up	50-893890T/50-822462	18-5621	68575 3	18-5656	68575	10	18-5697	75384
60 3 cyl. Bigfoot	G590000	G760299	50-893890T/50-822462 T 1	18-5621	68575 3	18-5656	68575	10	18-5697	75384
65 4 cyl.	2803822	3293183	50-57867A1/50-58788	18-5636	68575 3	18-5656	68575	10	18-5697	75384
65 3 cyl.	3293184	4571651	50-44369A1/50-65436/50-60315	18-5606	68575 3	18-5656				
65 Jet	D283222	& Up	50-893891T/50-66015	18-5642	68575 3	18-5656	68575	10	18-5697	75384
70 3 cyl.	457165	A996142	50-44369A1/50-65436/50-60315	18-5606	68575	18-5656				
80 4 cyl.	2783253	3493912	50-57867A1/50-58788	18-5636	N.L.A.		68575	10	18-5697	75384
80 4 cyl.	4831999	& Up	50-893891T/50-66015	18-5642 ⑦	68575 3	18-5656	68575	10	18-5697	75384
85 4 cyl.	3865694	& Below	50-58788A3/50-58788	18-5636	N.L.A.	18-5656	68575	10	18-5697	75384
85 4 cyl.	3865695	4366801	50-67341	18-5602	68575 3	18-5656	68575	10	18-5697	75384
80 Jet	D283222	& Up	50-893892T/50-66015-1	18-5610	68575 3	18-5656	75660/13310T1	8	18-5697	75384
90	② 4845301	& Up	50-72467/50-64975/50-57465A1	18-5636	68575 3	18-5656	68575	10	18-5697	75384
90 3 cyl.	A996142	& Up	50-893891T/50-66015	18-5642	68575 3	18-5656	68575	10	18-5697	75384
100 4 cyl.	B209468	G965520	50-893892T/50-66015-1	18-5610	68575-3	18-5674	75660/13310T1	8	18-5697	75384
105 JET	G760299	& Below	50-893893/50-44414/50-44415/50-79472/50-77141	18-5608	13310T 1	18-5674	75660/13310T1	8	18-5697	75384
115 6 cyl. ②	4855153	& Up	50-72467/50-64975/50-57465A1	18-5636	68575 3	18-5656	68575	10	18-5697	75384
115 4 cyl.	C100000	& Up	50-893892T/50-66015-1	18-5610	68575 3	18-5674	75660/13310T1	8	18-5697	75384
125 4 cyl.	D283222	& Up	50-893892T/50-66015-1	18-5610	68575 3	18-5674	75660/13310T1	8	18-5697	75384
135 V-6	A904646	G960499	50-893893/50-79472/50-77141/50-44414/50-44415	18-5608	13310T 1	18-5674	75660/13310T1	8	18-5697	75384

Note: Some starters will replace Prestolite versions however replacement parts are for Bosch versions only.
 ② Inline 6 cylinder
 ④ With 8 tooth pinion
 ⑤ With 9 tooth pinion
 ⑥ No replacement starter available, drive parts only
 ⑦ Bosch models only
 ⑧ Some applications require Mercury adapter #44368 (prior to S/N 0D000750)

MERCURY

H.P.	Beg. Serial #	Ending Serial #	O.E.M #	Starter #	O.E. #	Drive Assembly	O.E. #	Drive Tooth Count	Brush Kit	O.E. #
140 6 cyl. Inline ②	4865678	& UP	50-72467/50-64975/50-57465A1	18-5636	68575 3	18-5656	68575	10	18-5697	75384
140 JET	G960499	& Below	50-893893/50-44414/50-44415/50-79472/50-77141	18-5608	1310T 1	18-5674	75660/13310T1	8	18-5697	75384
150 ②	4121435	& Up	50-72467/50-64975/50-57465A1	18-5636	68575 3	18-5656	68575	10	18-5697	75384
V150	4868998	G960499	50-793793/50-79472/50-77141	18-5608	13310T 1	18-5674	75660/13310T1	8	18-5697	75384
150 XR2	4868998	A904645	50-44414,50-44415	18-5608	N.L.A.	18-5674	75660/13310T1	8	18-5697	75384
150 XR4	B242885	D819999	50-893893/50-79472/50-77141/50-44414/50-44415	18-5608	13310T 1	18-5674	75660/13310T1	8	18-5697	75384
150 XR6	D082000	G960499	50-893893/50-79472/50-77141/50-44414/50-44415	18-5608	13310T 1	18-5674	75660/13310T1	8	18-5697	75384
150 EFI	G303046	T408999	50-893893/50-79472/50-77141/50-44414/50-44415	18-5608	13310T 1	18-5674	75660/13310T1	8	18-5697	75384
V175	4301235	G960499	50-893893/50-79472/50-77141	18-5608	13310T 1	18-5674	75660/13310T1	8	18-5697	75384
175 EFI, XRI, MAG	D000750	G960499	50-893893/50-44414/50-44415	18-5608	N.L.A.	18-5674	75660/13310T1	8	18-5697	75384
200	4839034	G960499	50-893893/50-79472/50-77141	18-5608	13310T 1	18-5674	75660/13310T1	8	18-5697	75384
200 EFI, XRI	C100861	G960499	50-893893/50-44414/50-44415	18-5608	N.L.A.	18-5674	75660/13310T1	8	18-5697	75384
2.4EFI/2.5EFI/	ALL	—	50-893893/50-79472/50-77141/50-44414/50-44415	18-5608	13310T 1	18-5674	75660/13310T1	8	18-5697	75384
2.5 Carb/	ALL	—	50-893893/50-79472/50-77141/50-44414/50-44415	18-5608	13310T 1	18-5674	75660/13310T1	8	18-5697	75384
3.4L/MOD VP ④	ALL	—	50-893893/50-79472/50-77141/50-44414/50-44415	18-5608	13310T 1	18-5674	75660/13310T1	8	18-5697	75384
V200 ⑤	5363918	6435503	50-86976	18-6825	8677 1	18-5658	86177/86177 1	9	18-5697	75384
V225	5628028	D280812	50-86976	18-6825	8677 1	18-5658	86177/86177 1	9	18-5697	75384
225 3.0L Carb	D280813	T408999	50-898265009/50-818445-3/50-818445-2	18-5620	13310T 1	18-5674	75661/13310T1	8	18-5697	75384
225/250 EFI 3.0L	G129222	& Up	50-898265009/50-818445-3/50-818445-2	18-5620	13310T 1	18-5674	75661/13310T1	8	18-5697	75384
250XB	G980600	& Up	50-898265009/50-818445-3/50-818445-2	18-5620	13310T 1	18-5674	75661/13310T1	8	18-5697	75384

Note: Some starters will replace Prestolite versions however replacement parts are for Bosch versions only. ② Inline 6 cylinder ③ With 8 tooth pinion ④ Above Prop Exhaust ⑤ 4 cyl. only ⑥ With 9 tooth pinion ⑦ Bosch models only ⑧ Some applications require Mercury adapter #44368 (prior to S/N OD000750)



**18-4915
STARTER ROPE**
Replaces: 50-12066A9, 50-12066Q9, 50-45093, 50-28985A2, 50-22791A1, 50-12066A1



**18-6506
REWIND SPRING**
Replaces: 24-29340A1, T1

REWIND SPRING APPLICATION

Model/HP	Beg. S/N	End S/N	Rewind Spring	Model/HP	Beg. S/N	End S/N	Rewind Spring
Merc 4	2498136	4107219	18-6506	Merc 35	1217222	1271884	18-6506
Merc 4.5	4107220	& UP	18-6506	Merc 35	1356948	1448139	18-6506
Merc 6	1408611	2387383	18-6506	Merc 35	1571114	1960826	18-6506
Merc 7.5	2529895	& UP	18-6506	Merc 35	1960827	2097279	—
Mar 8	M-677-000101	& UP	—	Merc 35	2097832	2258863	—
Merc 9.8		ALL	18-6506	Merc 35	2300962	2453068	—
Mar 9.9	M-682-000551	M-682-032885	—	Merc 35	2487558	2874703	—
Mark (10) 10		ALL	18-6506	Merc 35	6445653	& UP	—
Merc 10	1290910	1455239	18-6506	Mark (55) 40	831021	& UP	18-6506
Mark (15) 15		ALL	18-6506	Merc 40	1279685	1476509	18-6506
Merc 15	1288910	1349697	18-6506	Mar 40		ALL	—
Mar 15	M-684-000101	& UP	—	Merc 40	2874704	3336257	—
Merc 20	3537531	6443972	18-6506	Merc 40	3326258	& UP	—
Merc 20	1292910	3537530	18-6506	Merc 40	C159200	& UP	—
Mar 20	M-653-07615	& BELOW	—	Mark (58) 45	1139538	& UP	18-6506
Mar 20	M-653-07616	& UP	—	Merc 45	1476510	1531568	18-6506
Mar 20	M-6A9-000101	& UP	—	Merc 50	1421113	2116317	18-6506
Mark (28) 22		ALL	18-6506	Merc 50	5531630	& UP	— ②
Merc 25	1467499	1499331	18-6506	Merc 50	1770179	& UP	—
Mar 25	M-648-19025	& BELOW	& BELOW	Mark (75) 60		ALL	18-6506
Mar 25	M-695-000101	& UP	& UP	Merc 60		ALL	18-6506
Mar 28		ALL	—	Merc 65	1542745	1765043	18-6506
Merc 30	1271885	1356947	18-6506	Mark (78) 70		ALL	18-6506
Mar 30		ALL	18-6521	Merc 70		ALL	18-6506

① Above Prop Exhaust ② 4 cyl. only



18-7354
CARB KIT
 Replaces: 1395-8506
 V-175 outboards
 Serial Number 4301235 thru OC100860



18-7355
CARB KIT
 Replaces: 1395-811691 2



18-7356
CARB KIT
 Replaces: 1395-811691 3



18-7004
CARB KIT
 Replaces: 1395-6200



18-7005
CARB KIT
 Replaces: 1395-6452



18-7006-1
CARB KIT
 Replaces: 1399-1717,
 1399-2015, 1399-3523, 1395-4808,
 1395-8791994024, 879194024



18-7007
CARB KIT
 Replaces: 1399-5135, 1399-5198



18-7013
CARB KIT
 For: AJ, KA, KB, KC, KD Carburetor



18-7021
CARB KIT
 For: WM, WMK



18-7211-1
CARB KIT
 Replaces: 1395-8112231



18-7212
CARB KIT
 Replaces: 1395-97611, 1395-9761,
 1395-9803, 1395-9725, 1395-9645,
 1395-9377, 1395-9179, 1395-811357



18-7213
CARB KIT
 Replaces: 8107492



18-7214
CARB KIT
 Replaces: 8107493



18-7215
CARB KIT
 Replaces: 1395-9024



18-7226
CARB KIT
 Replaces: 1395-9650
 Fits: 30 JET, 40/45 4 CYL 4 Stroke,
 Carb models WMA-7B,9,10,13



18-7290
CARB KIT
 Replaces: 84419M



18-7291
CARB KIT
 Replaces: 84475M



18-7293
CARB KIT
 Replaces: 92520M



18-7738
CARB KIT
 Replaces: 802706A1
 For: 9.9 4 Stroke (323cc) (1999 & up)
 and 15 4 Stroke (1998 & up)



18-7743
CARB KIT
 Replaces: 804346T1
 For: 75 4 Stroke (2000 & up), 90 4 Stroke
 (2000 & up)

 <p>18-7750-1 CARB KIT Replaces: 1395-8236354, 1395-8236353, 1395-8236352, 1395-8236351, 1395-823635, 1395-811222, 1395-9599 Fits: WME-1, 1A, 1B, 4, 5, 6, 6A, 7, 7B, 8, 9, 10, 10A, 11, 14, 15, 15A, 17, 18, 20, 20A, 21, 21A, 22, 22B, 23, 24, 26, 27, 28, 32, 32B, 33, 34, 35, 36, 36A, 37, 37A, 38, 39A, 40, 40A, 42, 42A, 43, 44, 45, 50, 52, 53, 57, 58, 63, 64, 65, 66, 67, 68, 69, 79, 81</p>	 <p>18-7765 CARB KIT Replaces: 11502M</p>	 <p>18-7769 CARB KIT Replaces: 814481M</p>	 <p>18-7770 CARB KIT Replaces: 84456M</p>	 <p>18-7815 CARB KIT Replaces: 1399-5137</p>
 <p>18-7062 INLET VALVE Replaces: 1395-95951 Fits: WME-1, 1A, 1B, 4, 5, 6, 6A, 7, 7B, 8, 9, 10, 10A, 11, 14, 15, 15A, 17, 18, 20, 20A, 21, 21A, 22, 22B, 23, 24, 26, 27, 28, 32, 32A, 33, 34, 35, 36, 36A, 37, 37A, 38, 39A, 40, 40A, 42, 42A, 43, 44, 45, 50, 52, 53, 57, 58, 63, 64, 65, 66, 67, 68, 69, 79, 81</p>	 <p>18-7057 NEEDLE & SEAT Replaces: 1399-1473, 1395-9258, 1399-1138, 1399-9258 1 .078 Bore</p>	 <p>18-0715 FLOAT CHAMBER GASKET Replaces: 809086, 25-809086</p>	 <p>18-7061 NEEDLE & SEAT Replaces: 1395-8318, 1395-83181 .065 Bore</p>	 <p>18-7295 NEEDLE VALVE Replaces: 1395-9022</p>
 <p>18-7233 NEEDLE & SEAT Replaces: 1395-7824</p>	 <p>18-36850 NEEDLE & SEAT Replaces: 1395-8116901 Fits: Mercruiser 2.5 & 3.0L Carbs</p>	 <p>18-7380 FLOAT Replaces: 809569 15 (4-Stroke) All, 50 (4-Stroke)</p>	 <p>18-7381 FLOAT Replaces: 16253 4 (SN A855097 & Up), 5 (SN A855097 & Up)</p>	 <p>18-7382 FLOAT Replaces: 804184 75 (4-Stroke) All, 90 (4-Stroke) All</p>
 <p>18-7208 FLOAT Replaces: 1395-8983, 1395-8673</p>	 <p>18-72000 FLOAT Replaces: 1395-9594 Fits: WME1, 1A, 1B, 4, 5, 6, 6A, 7, 7B, 8, 9, 10, 10A, 11, 14, 15, 15A, 17, 18, 20, 20A, 21, 21A, 22, 22B, 23, 24, 26, 27, 28, 32, 32A, 33, 34, 35, 36, 36A, 37, 37A, 38, 39A, 40, 40A, 42, 42A, 43, 44, 45, 50, 52, 53, 57, 58, 63, 64, 65, 66, 67, 68, 69, 79, 81</p>	 <p>18-7249 FLOAT KIT Replaces: 19273 Fits: WM-3, 5, 6, 8, 9, 10, 11, 12, 13, 13A, 14, 15, 15A, 16, 16A, 17, 18</p>	 <p>18-7209 FLOAT Replaces: 1395-9293</p>	 <p>18-36956 FLOAT Replaces: 1395-9267 Fits: Mercury V6 w/ Dual Float Carbs</p>

MARINER CARBURETOR KIT APPLICATION

HP	Year/Serial No.	Carb Kit	HP	Year/Serial No.	Carb Kit	HP	Year/Serial No.	Carb Kit
6 C-D	Ser.No.Code 6H8 & 6H6	18-7765	25A	M-648-24991 & Up ML-648-64046 & Up E-648-27056 & Up EL-648-56526- & Up	18-7770	30A	M-689-230100 & Up ML-689-530100 & Up E-689-250100 & Up EL-689-550100 & Up	18-7770
8C	Ser.No.Code 6G1	18-7765						
9.9C	M-682-070796 & Up ML-682-368040 & Up E-682-251511 & Up EL-682-55146 & Up	18-7769	25C	Ser.No.Code 695	18-7770	48	M-670-02641 & Up ML-670-34581 & Up	18-7290
15C	M-684-052848 & Up ML-684-332302 & Up E-684-252381 & Up EL-684-553251 & Up	18-7769	28	M-664-05306 & Up ML-664-41686 & Up E-664-26236 & Up EL-664-57421 & Up	18-7770	W48	Ser.No.Code 670	18-7290
			55	Ser.No.Code 663		18-7290		
			W55	Ser.No.Code 663		18-7290		
			60	Ser.No.Code 675		18-7290		

MERCURY CARBURETOR KIT APPLICATION

HP	Year — S/N	Carburetor Model	Carburetor Kit	Gasket Kit	Needle & Seat	Float
3.9	1964-68	KB-7A,KB-7B	18-7013	18-7006-1	18-7057	18-7208
4 (1 cyl.)	1969-74	—	—	—	—	—
	80-81,86-87	KB-10A	18-7013	18-7006-1	18-7057	18-7208
4 (1 cyl.)	—	WMD-1	—	18-7006-1	18-7061	18-7208
4.5	1980-85	KD-10A	18-7013	18-7006-1	18-7057	18-7208
4.5	1980-85	WMD-1	18-7021	18-7006-1	18-7061	18-7208
6	1961-68	KB-6A,6B,7B,AJ57A	18-7013	18-7006-1	18-7057	18-7208
6	S/N A197112-Up	WMC-5.5A,5B,7.7A,	—	—	—	—
		17,17B,17C,18,18A,	—	—	—	
		18B,19,19A,20,20A,	—	—	—	
		20B,23,28,34,	—	—	—	
		39,41,47,49	—	18-7212	—	—
7.5	1969-73	KB-9A,KB-12A	18-7013	18-7006-1	18-7057	18-7208

APPLICATION CONTINUED ON NEXT PAGE

MERCURY CARBURETOR KIT APPLICATION (Cont.)

HP	Year — S/N	Carburetor Model	Carburetor Kit	Gasket Kit	Needle & Seat	Float
7.5	1972-85	BB-2A, BB-2B, BB-2C, BB-4A, BB-5A, BB-5B, BB-5C, BB-5D, BB-7A, BB-7C	—	—	—	—
7.5		WMB-2, 4	—	18-7007	18-7295	18-7209
8	S/N A197112-Up	WMC-5.5A, 5B, 7.7A, 17, 17B, 17C, 18, 18A, 18B, 19, 19A, 20, 20A, 20B, 23, 28, 34, 39, 41, 47, 49, 57	—	—	18-7295	18-7209
9.8	1962-73	KB-5A, 8A, 11A	18-7013	18-7006-1	18-7057	18-7208
9.8	1972-85	BB-1B, BB-1C, BB-3A, BB-3B, BB-3C, BB-6A, BB-6C	—	—	—	—
9.8		WMB-1, 3	—	18-7007	18-7295	18-7209
9.9 (2 stroke)	S/N A197112-Up	WMC-5.5A, 5B, 7.7A, 17, 17B, 17C, 18, 18A, 18B, 19, 19A, 20, 20A, 20B	—	18-7212	—	—
9.9 (2 stroke)		WMC-23, 28, 34, 39, 41, 41A, 47, 47A, 49, 49A, 57	—	18-7212	—	—
9.9 (4 stroke) (4 Stroke) (323cc)	S/N OG590000-Up	—	—	—	—	—
10	1957-61	AJ-52A	18-7013	18-7006-1	18-7057	18-7208
10		AJ-56AB	—	18-7006-1	18-7057	18-7208
10		KB-1A, 4A	—	18-7006-1	18-7057	18-7208
10 Seapro/ Marathon	All	WMC-33, 33A, 40, 42, 50, 50A, 55, 55A	—	18-7212	—	—
XB-10	All	WMC-23, 48, 48A, 49, 49A	—	18-7212	—	—
MAG 10	All	WMC-23, 48, 48A, 49, 49A	—	18-7212	—	—
15	1959-61	AJ-52A, AJ-56A	18-7013	18-7006-1	18-7057	18-7208
15(150)		KB-1A, 4A	—	18-7006-1	18-7057	18-7208
15	S/N A197112-Up	WMC-5.5A, 5B, 7.7A, 17, 17B, 17C, 18, 18A, 18B, 19, 19A, 20, 20A, 20B	—	18-7212	—	—
15		WMC-23, 28, 34, 39, 41, 41A, 47, 47A, 49, 49A, 57	—	18-7212	—	—
15	S/N OG590000-Up	—	18-7738	—	—	—
15 Seapro/ Marathon	All	WMC-33, 33A, 40, 42, 50, 50A, 55, 55A	—	18-7212	—	—
Super 15	S/N 6443973-Up	WMC-1, 2, 3, 4, 9, 10, 11, 12, 13, 13A, 14, 14A, 15A, 16A, 24, 25, 26, 27, 29, 30, 31, 31A, 32, 32A, 35, 35A, 35B, 36, 37, 44, 45, 46, 46A, 50, 53, 54, 56	—	—	—	—
Seapro/ Marathon	S/N 6443973-Up	WMC-1, 2, 3, 4, 9, 10, 11, 12, 13, 13A, 14, 14A, 15A, 16A, 24, 25, 26, 27, 29, 30, 31, 31A, 32, 32A, 35, 35A, 35B, 36, 37, 44, 45, 46, 46A, 50, 53, 54, 56	—	18-7212	—	—
15 (4-Stroke)	S/N OG590000-Up	—	18-7738	—	—	—
18	S/N 6443973-Up	WMC-1, 2, 3, 4, 9, 10, 11, 12	—	18-7212	—	—
18		WMC-13, 13A, 14, 14A, 15A, 16A, 24, 25, 26, 27, 29, 30, 31, 31A	—	18-7212	—	—
20	S/N 6443973-Up	WMC-1, 2, 3, 4, 9, 10, 11, 12	—	18-7212	—	—
20		WMC-13, 13A, 14, 14A, 15A, 16A, 24, 25, 26, 27, 29, 30, 31, 31A	—	18-7212	—	—
20 (200)	1963-72	KA-20A, 22A, 22B, 22C, 23A, 25A	18-7013	18-7006-1	18-7057	18-7208
20	1973-80	BA-1A, BA-2A, BA-2C, BA-2D, BA-2E	—	18-7007	—	18-7209
Jet 20	S/N 6443973-Up	WMC-1, 2, 3, 4, 9, 10, 11, 12, 13, 13A, 14, 14A, 15A, 16A, 24, 25, 26, 27, 29, 30, 31, 31A, 32, 32A, 35, 35A, 35B, 36, 37, 44, 45, 46, 46A, 50, 53, 54, 56	—	—	—	—
22	1958-59	KA-KC	18-7013	18-7006-1	18-7057	18-7208
25 (2 cyl)	S/N 6443973-Up	WMC-1, 2, 3, 4, 9, 10, 11, 12	—	18-7212	—	—
25 (2 cyl)		WMC-13, 13A, 14, 14A, 15A, 16A, 24, 25, 26, 27, 29, 30, 31, 31A, 32, 32A, 35, 35A, 35B, 36, 37, 44, 45, 46, 46A, 50, 53, 54, 56	—	18-7212	—	—
30 (2 cyl.) (644cc)	S/N G053314-Up	WMC-36, 36A, 37, 37A, 38, 39A, 42, 42A, 63, 64, 65, 66, 67	—	—	—	—
30 (300) 4-cyl		AJ-54A	18-7750-1	18-7211-1	—	18-72000
30 (300) 4-cyl		KB-2A	—	17-7006-1	18-7057	18-7208
30 JET (3 cyl)		WMC-53, 68, 69	18-7750-1	18-7211-1	—	18-72000
30 JET (4 cyl)		WMA-10, 13	18-7226	—	—	—
35	1984-89	KC-4A, 8A, 9A, 9B, 9C, 13A	18-7013	18-7006-1	18-7061	18-7208
35	1963-69	KB-2A	18-7013	18-7006-1	18-7057	18-7208
35	1984-89	WMC-38	18-7021	18-7006-1	18-7061	18-7208

APPLICATION CONTINUED ON NEXT PAGE

MERCURY CARBURETOR KIT APPLICATION (Cont.)























HP	Year — S/N	Carburetor Model	Carburetor Kit	Gasket Kit	Needle & Seat	Float
35		AJ-54A	—	—	18-7057	18-7208
40	1960-61	KA-7A,KD-5A, KA-2A,KA-9A	18-7013	18-7006-1	18-7057	18-7208
40	1954-59	AJ	18-7013	18-7006-1	18-7057	18-7208
40	1970-74	WMK-1,WMK-8	18-7021	18-7006-1	18-7061	18-7208
40	1975-83	WME-21,WMK-24, WMK-31	18-7021	18-7006-1	18-7061	18-7208
40 (2 cyl.)	S/N G053314-Up	WME-36,36A,37,37A, 38,39A,42,42A,63, 64,65,66,67	—	—	—	—
40 (3 cyl.)		WME-53, 68, 69	18-7750-1	18-7211-1	—	18-72000
40 (4 cyl.)		WMA-4	—	18-7215	18-7295	18-7209
40 (4 cyl.)		WMA-7B	18-7226	—	—	18-7209
40 (4 cyl.)		WMA-9, 10, 13	18-7226	—	—	—
45	1958-62	KA-2A	18-7013	18-7006-1	18-7057	18-7208
45	1958-62	AJ-54A	18-7013	18-7006-1	18-7057	18-7208
45 (4 cyl.)	1986	Tillotson/Walbro	—	18-7007	—	18-7209
45 (4 cyl.)	1987-Up	WMA-4	—	18-7215	18-7295	18-7209
45 (4 cyl.)		KA-17A	18-7013	—	18-7057	18-7208
45 (4 cyl.)		WMA-7B	18-7226	—	—	18-7208
45 (4 cyl.)		WMA-9, 10, 13	18-7226	—	—	—
45 JET (3 cyl.)		WME-57, 58	18-7750-1	18-7211-1	—	18-72000
50 (4 cyl.)	1961-75	KA-13A,18A,19A, 21A,21B,21C,21D, 24A,26A,26B,27A	18-7013	18-7006-1	18-7057	18-7208
50	1976-85	BA-3B,BA-3C,BA-3D	—	18-7007	—	18-7209
50 (3 cyl.)	1986-90	WM-13, 13A, 15, 15A, 16, 16A, 18	—	18-7004	—	18-7249
50 (3 cyl.)		WME-22,22B,23,24,26, 27, 28, 35, 43, 44, 45, 53, 68, 69	18-7750-1	18-7211-1	—	18-72000
50 (4cyl.)	1986-Up	WMA-1.3	—	18-7215	18-7295	18-7209
50 (4cyl.)		BA-3A, 3B, 3C, 3D, 4A	—	18-7007	18-7295	18-7209
50 (4cyl.)		WMK-8	18-7021	18-7006-1	18-7061	18-7208
55 (3 cyl.)		WM-13, 13A, 15, 15A, 16, 16A, 18	—	18-7004	—	—
55		WME-22, 22B, 23, 24, 26, 27, 28, 35, 43, 44, 45, 57, 58	18-7750-1	18-7211-1	—	18-72000
60 (3 cyl.)	S/N D000750-Up	WME-22,22B,23,24,26, 27, 28, 35, 43, 44, 45, 57, 58	18-7750-1	18-7211-1	—	18-72000
60 (3 cyl.)	1984-90	WM-13,13A, 15, 15A, 16, 16A, 18	—	18-7004	—	18-7249
60	1957-60	AJ-53A,AJ-55A,KB	18-7013	18-7006-1	18-7057	18-7208
60,600 (6 cyl.)		KB-3A	—	18-7006-1	18-7057	18-7208
65 650 (4 cyl.)	1963-71	KC-2A,5A,5B,5C, 11A,15A	18-7013	18-7006-1	18-7057	18-7208
65 650 (3 cyl.)	1972-75	WMK-5,WMK-12, WMK-13,WMK-20	18-7021	18-7006-1	18-7061	18-7208
65	1976	WM-2,WM-4	—	18-7004	18-7061	18-7208
Jet 65 (3 cyl.)	S/N A996142-Up	WME-1,1A,1B,4,5,6,6A, 7, 7B, 8, 9, 10, 10A, 15, 15A, 17, 18, 19, 25, 29, 30, 31, 41, 46, 47, 48, 49, 59, 60, 61, 62, 75, 76, 77	18-7750-1	18-7211-1	—	18-72000
70	1958-62	KC,KA-2A	18-7013	18-7006-1	18-7057	18-7208
70 700 (6 cyl.)		KA-8A, 12A	18-7013	18-7006-1	18-7057	18-7208
70	1977-83	WM-6,8, 9, 11	—	18-7004	18-7061	18-7249
70 (3 cyl.)	S/N A996142-Up	WME-1,1A,1B,4,5, 6,6A,7,7B,8,9,10, 10A,15,15A,17,18, 19,25,29,30,31,41, 46,47,48,49,59, 60,61,62	—	—	—	—
		60,61,62	18-7750-1	18-7211-1	—	18-72000
75 (4 cyl.)	1984-86	WM-14, 17	—	18-7004	—	18-7249
75 (3 cyl.)	S/N A996142-Up	WME-1,1A,1B,4,5, 6,6A,7,7B,8,9,10, 10A,15,15A,17,18, 19, 25,29,30,31,41, 46,47,48,49,59, 60,61,62	—	—	—	—
		60,61,62	18-7750-1	18-7211-1	—	18-72000
75 (4 Stroke)	S/N QG960500-Up	—	18-7743	—	—	—
80 (3 cyl.)	S/N A996142-Up	WME-1,1A,1B,4,5, 6,6A,7,7B,8,9,10, 10A,15,15A,17,18, 19,25,29,30,31,41, 46,47,48,49,59, 60,61,62	—	—	—	—
		60,61,62	18-7750-1	18-7211-1	—	18-72000
80 (4 cyl.)	1960-61	KD-4A	18-7013	18-7006-1	18-7061	18-7208
80 (4 cyl.)	1969-72	WMK-2	18-7021	18-7006-1	18-7061	18-7208
80 (4 cyl.)	1978-83	WM-5,10,12, 14, 17	—	18-7004	18-7061	18-7249
80 800 (6 cyl.)		KA-10A, 11A, 14A, 16A, KC-3A	—	18-7006-1	18-7057	18-7208
Jet 80 (4 cyl.)	S/N B209468-Up	WME-11,14,20,20A, 21,21A,32,32A,33, 34,40,40A,50,51,52,79	18-7750-1	18-7211-1	—	18-72000
85	1973-75	WMK-4,WMK-16, WMK-17	18-7021	18-7006-1	18-7061	18-7208
85 850 (6 cyl.)	1963-65	KA,KC	18-7013	18-7006-1	18-7057	18-7208
85	1976-77	WM-3,WM-5	—	18-7004	18-7061	18-7249
90 (3 cyl.)	S/N A996142-Up	WME-1,1A,1B,4,5,6, 6A,7,7B,8,9,10,10A, 15,15A,17,18,19,25, 29,30,31,41,46,47, 48,49,59,60,61,62	—	—	—	—
		48,49,59,60,61,62	18-7750-1	18-7211-1	—	18-72000
90 (4 Stroke)	S/N QG960500-Up	—	18-7743	—	—	—
90 (6 cyl.)	1965	KC-6A	18-7013	18-7006-1	18-7057	18-7208
90 (6 cyl.)	1978-86	WMK-23,WMK-27, WMK-30,WMK-35, WMK-39	18-7021	18-7006-1	18-7061	18-7208
95	1966-67	KC-6A	18-7013	18-7006-1	18-7057	18-7208
100 (4 cyl.)	S/N B209468-Up	WME-11,14,20,20A, 21,21A,32,32A,33,34,	—	—	—	—

APPLICATION CONTINUED ON NEXT PAGE

MERCURY CARBURETOR KIT APPLICATION (Cont.)

HP	Year — S/N	Carburetor Model	Carburetor Kit	Gasket Kit	Needle & Seat	Float
		40,40A,50,51,52,79	18-7750-1	18-7211-1	—	18-72000
100 (6 cyl.)	1962-69	KC-1A,7A,10A,14A	18-7013	18-7006-1	18-7057	18-7208
100 (6 cyl.)		KD-1A, 1B, 2A, 3A	18-7013	18-7006-1	18-7061	18-7208
V-105 Jet	1994-95 S/N OD082000-OG303045	WMH-13, 13B, 23, 31	18-7355	18-7213	—	—
V-105 Jet	1996 & Up S/N OG303046 & Up	WMV-2, 2A	18-7356	18-7214	—	—
110		KC-1A, 7A, 7B, 10A, 14A	18-7013	18-7006-1	18-7057	18-7208
115 (4 cyl.)	S/N B209468-Up	WME-11,14,20,20A, 21,21A,32,32A,33,34,	—	—	—	—
		40,40A,50,51,52	18-7750-1	18-7211-1	—	18-72000
115 (6 cyl.)	1970-77	KD-6A,KD-6B	18-7013	18-7006-1	18-7061	18-7208
115 (6 cyl.)	1970-88	WMK-3,10,15, 18, 26, 28, 32, 36, , 40, 41, 41-1A, 41-1B, 41-3A, 41-3B	18-7021	18-7006-1	18-7061	18-7208
125	1968-69	KD-1A,1B,2A, 3A	18-7013	18-7006-1	18-7057	18-7208
125 (4 cyl.)	S/N B209468-Up	WME-11,14,20,20A, 21,21A,32, 32A,33, 34,40,40A,50,51,52, 81	—	—	—	—
		40,40A,50,51,52, 81	18-7750-1	18-7211-1	—	18-72000
135	1970-71	KD-7A,KD-7B	18-7013	18-7006-1	18-7057	18-7208
135	1970-71	WMK-4	18-7021	18-7006-1	18-7061	18-7208
V-135	1986-88 S/N OA904646-OC100860	WH-33, 40	18-7354	18-7005	18-7233	—
V-135	1986-88 S/N OA904646-OC100860	WH-32, 35, 38	18-7354	18-7005	—	—
V-135	1989-90 S/N OC100861-OC239552	WH-35, 38	—	18-7005	18-7233	—
V-135	1989-90 S/N OC100861-OC239552	WH-40, 48	18-7354	18-7005	18-7233	—
V-135	1991 S/N OC239553-OD081999	WMH-8, 8A	18-7355	18-7213	—	—
V-135	1992-95 S/N OD082000-OG303045	WMH-12A, 12B, 28, 30	18-7355	18-7213	—	—
V-135	1996-98 S/N OG303046-OG760299	WMV-1, 1A	18-7356	18-7214	—	—
V-135	1999 & Up S/N OG760300 & Up	WMV-1A, 15, 15A	18-7356	18-7214	—	—
140	1972	WMK-7,WMK-9	18-7021	18-7006-1	18-7061	18-7208
140	1978-80	WMK-25,WMK-29	18-7021	18-7006-1	18-7061	18-7208
V-140 Jet	1994-95 S/N OG082000-OG303045	WMH-16, 21, 34, 39	18-7355	18-7213	—	—
V-140 Jet	1996-98 S/N OG303046-OG760299	WMV-5, 5A	18-7356	18-7214	—	—
V-140 Jet	1999 & Up S/N OG760300 & Up	WMV-5A	18-7356	18-7214	—	—
150	1973-77	WMK-11	18-7021	18-7006-1	18-7061	18-7208
150	1973-78	WMK-14,WMK-19, WMK-22	18-7021	18-7006-1	18-7061	18-7208
3.4L	1984-86	WQ-3	—	—	18-7233	—
V150	1978-90	WH-2,12,21,23,27, 29,35,38,40,48	—	—	—	—
		29,35,38,40,48	—	18-7005	18-7233	—
V-150	1979-85 S/N OA904645 & Below	WH-9	—	18-7005	—	—
V-150	1979-85 S/N OA904645 & Below	WH-12	—	18-7005	18-7233	—
V-150	1979-85 S/N OA904645 & Below	WH-29	18-7354	18-7005	18-7233	—
V-150	1986-90 S/N OA904646-OC239552	WH-35, 38	—	18-7005	18-7233	—
V-150	1986-90 S/N OA904646-OC239552	WH-40, 48	18-7354	18-7005	18-7233	—
V-150	1990-91 S/N OC239553-OD081999	WMH-1, 7	18-7355	18-7213	—	—
V-150	1992-95 S/N OD082000-OG303045	WMH-13, 13B, 23, 31	18-7355	18-7213	—	—
V-150	1996-98 S/N OG303046-OG760299	WMV-2, 2A	18-7356	18-7214	—	—
V-150	1999 & Up S/N OG760300 & Up	WMV-3A, 16, 16A	18-7356	18-7214	—	—
V-150 (XR4, MAGII)	1988 S/N OB242885-OC100860	WH-41A	18-7354	18-7005	18-7233	—
V-150 (XR4, MAGII)	1989 S/N OC100861-OC239552	WH-41	18-7354	18-7005	18-7233	—
V-150 (XR4, MAGII)	1989 S/N OC100861-OC239552	WH-41A	18-7354	18-7005	18-7233	—
V-150 (XR4, MAGII)	1990-91 S/N OC239553-OD081999	WMH-6	18-7355	18-7213	—	—
V-150 (XR6, MAGIII)	1996-98 S/N OG303046-OG760299	WMV-3, 3A	18-7356	18-7214	—	—
V-150 (XR6, MAGIII)	1999 & Up S/N OG760300 & Up	WMV-3A, 16, 16A	18-7356	18-7214	—	—
V-150 (XR6, MAGIII)	1992-95 S/N OD082000-OG303045	WMH-14A, 25, 32A	18-7355	18-7213	—	—
V-175	1976-88 S/N 4301235-OC100860	WH-1, 4, 7, 7A, 13, 17, 28, 39, 46	—	18-7005	18-7233	—
V-175	1976-88 S/N 4301235-OC100860	WH-17R, 30, 34	18-7354	18-7005	18-7233	—
V-175	1990 S/N OC100861-OC239552	WH-34	18-7354	18-7005	18-7233	—
V-175	1991 S/N OC239553-OD081999	WMH-2, 11	18-7355	18-7213	—	—
V-175	1992-95 S/N OD082000-OG303045	WMH-15, 22, 33	18-7355	18-7213	—	—
V-175	1996-98 S/N OG303046-OG760299	WMV-4, 4A	18-7356	18-7214	—	—
V-175	1999 & Up S/N OG760300 & Up	WMV-4A	18-7356	18-7214	—	—
V200	1978-90 □	WH-3,14,18,20, 22,26,28,31,39,46	—	—	—	—
		22,26,28,31,39,46	—	18-7005	18-7233	—
V-200	1991 S/N OC291520-OD081999	WMH-3	18-7355	18-7213	—	—
V-200	1992-95 S/N OD082000-OG303045	WMH-16, 21, 34, 39	18-7355	18-7213	—	—
V-200	1996-98 S/N OG303046-OG760299	WMV-5, 5A	18-7356	18-7214	—	—
V-200	1999 & Up S/N OG760300 & Up	WMV-5A	18-7356	18-7214	—	—
V200	1980-82 S/N 4839034-OC100860	WH-3A,11	—	18-7005	—	—
V-225 (2.4L)	1981 & Up 5628028 & Up	WH-5, 20	—	18-7005	18-7233	—
225	S/N D280813 thru G303045	WMH-19,45,46,47	18-7355	18-7213	—	—
V225	1980-81	WH-15	—	18-7005	18-7233	—
V-225 (3.0L)	S/N OD280813-OG303045	WMH-19, 46, 47	18-7355	18-7213	—	—
V-225 (3.0L)	S/N OG303046-OG760299	WMV-7, 13	18-7356	18-7214	—	—
V-225 (3.0L)	S/N OG303046 & Up	WMV-13, 13A	18-7356	18-7214	—	—
V-225 (3.0L)	S/N OG245605-OG303045	WMH-45	18-7355	18-7213	—	—
Seapro/Marathon						
V-225 (3.0L)	S/N OG303046-OG760299	WMH-6, 11A	18-7356	18-7214	—	—
Seapro/Marathon						
V-225 (3.0L)	S/N ALL & Up	WMV-11, 11A, 13, 13A, 19	18-7356	18-7214	—	—
Seapro/Marathon						
V250	1989-90	WD-8A-1,2,3,4,5,6	—	—	18-7061	—
V275	1989-91	WD-9/9A-1,2,3,4,5,6	—	—	18-7061	—
V300	1980 & Up S/N 5611648 & Up	WD-3, 5	—	—	18-7061	—
XR2	S/N C239553-Up	WHM-1,2,3B,5,7,8, 8A,11A,12,12A,12B, 13,13B,14A,15,16, 18A,21,22,23,24,25, 28,30,31,32,33,34	—	—	—	—
		13,13B,14A,15,16, 18A,21,22,23,24,25, 28,30,31,32,33,34	18-7213	—	—	—
XR4	1988-90	WH-41,WH-41A	—	18-7005	—	—
XR6/ MAGIII	S/N C239553-Up	WHM-1,2,3B,5,7,8, 8A,11A,12,12A,12B, 13,13B,14A,15,16, 18A,21,22,23,24,25, 28,30,31,32,33,34	—	—	—	—
		13,13B,14A,15,16, 18A,21,22,23,24,25, 28,30,31,32,33,34	18-7213	—	—	—

① Except EFI, XRI

 <p>18-8957 CHECK VALVE Replaces: 22-8189941, 22-818994</p>	<p>PKG. OF 2</p>  <p>18-8956 COUPLER Couples 3/8" to 5/16" Hose Replaces: 22-8M0001721</p>	 <p>18-8958 FITTING Replaces: 22-424254</p>	 <p>18-8866 FUEL PUMP Replaces: 899106T01, 892874T01 Fits: Mercury 4 stroke outboard</p>
 <p>18-7804 FUEL PUMP KIT Replaces: 23014A1</p>	 <p>18-7806-1 FUEL PUMP KIT</p>	 <p>18-7807 FUEL PUMP KIT Replaces: 55278A1</p>	 <p>18-7808 FUEL PUMP KIT Replaces: 55278A5</p>
 <p>18-7809 FUEL PUMP KIT Replaces: 55278A4, 55278A3</p>	 <p>18-7810 FUEL PUMP KIT Replaces: 90363A1</p>	 <p>18-7811 FUEL PUMP KIT Replaces: 89031A1, 66599A1</p>	 <p>18-7812 FUEL PUMP KIT Replaces: 89031A2, 66599A2</p>
 <p>18-7813 FUEL PUMP KIT Replaces: 89031A3, 66599A3</p>	 <p>18-7814 FUEL PUMP KIT Replaces: 89031A4</p>	 <p>18-7817 FUEL PUMP KIT Replaces: 21-42990A7, A8, A9, A10, 21-857005A1</p>	 <p>18-7818-1 FUEL PUMP KIT Replaces: 42909A1, 42909A2, 42909A3, 42909A4</p>
 <p>18-7833 FUEL PUMP DIAPHRAGM Replaces: 11497M</p>	 <p>18-7834 FUEL PUMP DIAPHRAGM Replaces: 91748M</p>	 <p>18-7837 FUEL PUMP DIAPHRAGM Replaces: 84262M</p>	 <p>18-7838 FUEL PUMP DIAPHRAGM Replaces: 84265M</p>
 <p>18-7839 FUEL PUMP DIAPHRAGM Replaces: 80606M</p>	 <p>18-7840 FUEL PUMP DIAPHRAGM Replaces: 84141M</p>	 <p>18-7847 FUEL PUMP DIAPHRAGM</p>	

DIAPHRAGM APPLICATION ON NEXT PAGE

MERCURY FUEL PUMP KITS

HP	Beginning	Ending	Fuel Pump Kit	HP	Beginning	Ending	Fuel Pump Kit
7.5	3488153	& UP	18-7815 ②	115 (4 CYL)	B209468	& UP	18-7817 ⑦
8	A197112	& UP	18-7212	115 (115, 1150) SQUARE F/P	6436123	& UP	18-7817
9.8	3482753	& UP	18-7815 ②	115 (4 CYL)	D283222	& UP	18-7817
9.9	A197112	& UP	18-7212	115 (6 CYL) DFI	G960500	T178999	18-7817
10	1057994	1455239	18-7804	115 (3 CYL) DFI	T801000	& UP	18-7817
15	1200114	1349667	18-7804	115 PRO XS	B751825	& UP	18-7817
15	B292414	& UP	18-7212	120	ALL		18-7806-1
20	1866496	2296266	18-7804	120XR	ALL		18-7806-1
20	3537531	A910970	18-7815 ②	125 (1250) 6 CYL	2314956	2839386	18-7804
20	6443973	T800749	18-7212	125 (4 Cyl.)	D283222	& UP	18-7817
20 JET	G044027	& UP	18-7212	125 (1250BP) 6 CYL	2400058	2641954	18-7817
22	1158546	1499331	18-7804	125 (3 CYL) DFI	B736885	& UP	18-7817
25	1467499	1499331	18-7804	135	2839369	3293233	18-7807
25	6443973	& UP	18-7212	V-135	C100860	& Below	18-7812 ①
30	950250	1448139	18-7804	V-135	A904646	& UP	18-7817 ⑤
30 JET	C159200	T408999	18-7817	V-135 TRIANGULAR F/P	A904646	C100860	18-7813
35	6445652	& BELOW	18-7804	V-135 SQUARE F/P	A904646	D081999	18-7817
35	6445653	B110788	18-7809	V-135	D082000	T178499	18-7817
35	B110789	& UP	18-7817	V-135 DFI (DESIGN II)	G590000	G760299	18-7817
40 (2 cyl.)	831021	1476509	18-7804	V135 DFI	G760300	& UP	18-7817
40 (2 CYL)	2874704	5556229	18-7807	140	3293234	3502805	18-7807
40 (2 CYL)	C159200	& UP	18-7817	140	4865678	5327662	18-7811
40 (2 CYL)	G053314	& UP	18-7817	140 JET	ALL		18-7817
40 (3 CYL)	G590000	T999999	18-7817	150	3502806	4865677	18-7807
40 FOUR STROKE JET 2 CYCLE	G760300	& UP	18-7817	150 EFI	G303046	& UP	18-7817
45	1139538	1531958	18-7804	V-150	C100860	& Below	18-7812 ①
45 (4 cyl.)	B110789	& UP	18-7817	V-150	A904646	C100860	18-7817 ⑤
45/50 (4 cyl.)	3478003	B110788	18-7815 ②	V-150 XR2	ALL		18-7812
45 JET	6428681	& UP	18-7817	V-150 (150HP)	4868998	A904645	18-7812
45 JET	D000750	T129554	18-7817	V-150 SQUARE F/P	A904646	C100860	18-7817
50 (4 cyl.)	2116318	4357639	18-7804	V-150	C100861	D081999	18-7817
50 (3 cyl.)	6428681	B122929	18-7809	V-150 CARB & EFI	D082000	B226999	18-7817
50 (3 cyl.)	B122930	T999999	18-7817	V-150 DFI (DESIGN I)	G590000	G760299	18-7817
50/55 (3 cyl.)	D000750	& UP	18-7817	V-150 DFI (DESIGN II)	G590000	G760299	18-7817
60	1072997	1542744	18-7804	V-150 DFI	G760300	& UP	18-7817
60	6428681	B122929	18-7809	V-175	C100860	& Below	18-7812 ①
60 (3 cyl.)	B122930	& UP	18-7817	175 EFI	G303046	G589999	18-7817
60 (3 cyl.)	D000750	& UP	18-7817	V-175	6618751	& UP	18-7817 ⑤
65	1542745	2803561	18-7804	V-175 TRIANGULAR F/P	4301235	C100860	18-7812
65	ALL 3 CYL		18-7807	V-175 SQUARE F/P	4301235	& UP	18-7817
65 JET	D283222	& UP	18-7817	V-175	C100861	D303045	18-7817
65 (650) 4 CYL	2119749	2803561	18-7804	V-175	D303046	G960499	18-7817
70	1143038	1566239	18-7804	V-175 EFI	D000750	D081999	18-7817
70 (3 cyl.)	4571652	6428680	18-7809	V-175 EFI	D082000	T408999	18-7817
70 (3 cyl.)	A996142	C221999	18-7818-1	V-175 EFI	T409000	T800999	18-7817
75 (4 CYL) SQUARE F/P	6432901	& UP	18-7817	V-175 DFI	T178500	& UP	18-7817
75 (3 CYL) 90 DEGREE OIL CHECK VALVE	C222000	D283221	18-7818-1	V-175 PRO XS	B516339	& UP	18-7817
75 (3 CYL) INLINE OIL CHECK VALVE	C222000	D283221	18-7817	200 EFI	G303046	G589999	18-7817
75 (3 CYL)	D283222	& UP	18-7817	V-200	6073192	6357229	18-7810
75 (3 CYL) DFI	T980000	& UP	18-7817	V-200	6357230	6625220	18-7814 ①
75 (4 cyl.)	6432901	& UP	18-7808 ①	V-200	4839034	6073191	18-7812
75 (4 cyl.)	6432901	& UP	18-7817 ⑤	V-200	6625221	& UP	18-7817 ⑤
75 (3 cyl.)	A996142	D283221	18-7818-1	V-200	6625221	C291519	18-7817
80	1335465	2670574	18-7804 ③	V-200	C291520	B226999	18-7817
80	2783253	2856331	18-7807 ③	V-200 EFI	C100861	D081999	18-7817
80	2559001	2670574	18-7808 ④	V-200	D082000	T408999	18-7817
80	4831999	6432900	18-7808	V-200 (2.5L) EFI	T409000	& UP	18-7817
80 (3 CYL)	A966142	C221999	18-7818-1	V-200 (3.0L) EFI	T750164	& UP	18-7817
80 JET (3 CYL)	0D283222	& UP	18-7817	V-200 DFI	G590000	T598999	18-7817
80 JET (4 CYL)	B586067	& UP	18-7817	V-200 DFI	T599000	T5800999	18-7817
85	1460999	1766823	18-7804	V-200 DFI	T801000	& UP	18-7817
85	3493913	4831998	18-7808	V-200 PRO XS	B504989	& UP	18-7817
90 (6 cyl.)	1766824	4845300	18-7804	V-220 LASER	B117316	& UP	18-7817
90 (6 CYL)	5299506	6436122	18-7811 ①	V-225	5628028	& UP	18-7810
90 (6 CYL)	6436123	& UP	18-7817 ⑤	V-225 SEA PRO/MARATHON (3.0L)	D208813	& UP	18-7817
90 (3 CYL)	A996142	D283221	18-7818-1	V-225 (3.0L) EFI	G129222	& UP	18-7817
90 (3 CYL) INLINE OIL CHECK VALVE	C222000	D283221	18-7817	V-225 (3.0L) DFI	G590000	T598999	18-7817
90 (3 CYL) 90 DEGREE OIL CHECK VALVE	C222000	D283221	18-7818-1	V-225 DFI	T599000	T800999	18-7817
90 (3 CYL)	D283222	& UP	18-7817	V-225 DFI	T801000	& UP	18-7817
90 (3 CYL) DFI	T801000	& UP	18-7817	V-225 DTS	T599000	B417701	18-7817
95 (950) 6 CYL	1869776	2318585	18-7804	V-225 DTS	B417702	& UP	18-7817
95XR	ALL		18-7806-1	V-225 PRO XS	B104549	& UP	18-7817
100	2318586	3253111	18-7804	V-250 (3.4L)	C101891	& UP	18-7817
100 (4 CYL) 90 DEGREE OIL CHECK VALVE	B209468	D283221	18-7818-1 ⑥	V-250 (3.0L) EFI	G129222	& UP	18-7817
100 (4 CYL) INLINE OIL CHECK VALVE	B209468	D283221	18-7817 ⑦	V-250XB	G980600	T800999	18-7817
100 (4 CYL)	D283222	G965520	18-7817	V-250 DFI	B528615	& UP	18-7817
105 JET	ALL		18-7817	V-250 PRO XS	B426561	& UP	18-7817
110	1870204	2314955	18-7804	V-275 (3.4L)	C101891	& UP	18-7817
115	3761034	& BELOW	18-7807	V-300 (3.4L)	5611648	& UP	18-7812
115 (6 CYL)	5314656	6436122	18-7813 ①	XR4/XR6	C100860	& Below	18-7817
115 (6 CYL) TRIANGULAR F/P	6436123	& UP	18-7817 ⑤	Magnum II	ALL		18-7817
115 (4 CYL)	B209468	& UP	18-7818-1 ⑥				

① Except models with square fuel pump ④ Single fuel pump applications ⑥ Use with white fuel pump body
 ② Models equipped with Tillotson BA, BB, BD carburetors ⑤ Models with square fuel pumps ⑦ Use with black fuel pump body
 ③ Dual fuel pump applications

MARINER DIAPHRAGMS (Japanese Models)

Model	S/N Code	S/N	Diaphragms	Model	S/N Code	S/N	Diaphragms
5C	6E3	ALL	18-7834	28	644	M-664-151346 & UP	②
6C	6H8	ALL	18-7833	30	689	ALL	②
6D	6H6	ALL	18-7833	40 TC	6E9	ALL	②
8B	677	ML-677-316416 & UP	18-7837	40A APE	676	M-676-A00346 — 001990	18-7839
8B	677	M-677-012921 & UP	18-7837	40A APE	676	M-676-A001991 & UP	②
8C	6G1	ALL	18-7833	40A APE	676	ML-676-A41356 — 302250	18-7839
9.9C	682	ALL	①	40A APE	676	ML-676-A302251 & UP	②
15A	651	ALL	18-7839	40A APE	676	E-676-A10121 — 100355	18-7839
15C	684	ALL	①	40A APE	676	E-676-A100356 & UP	②
20A APE	653	ALL	18-7839	40A APE	676	EL-676-A50631 — 400940	18-7839
20C TPE	6A9	ALL	②	40A APE	676	EL-676-A400941 & UP	②
25A	648	EL-648-550230 & BELOW	18-7839	40B TPE	676	ALL	②
25A	648	EL-648-550231 & UP	②	40C TC	6E9	ALL	②
25A	648	E-648-26825 & BELOW	18-7839	48	670	ML-670-302510 & BELOW	18-7839
25A	648	E-648-26826 & UP	②	48	670	ML-670-302511 — 311995	②
25A	648	ML-648-304174 & BELOW	18-7839	48	670	M-670-02640 & BELOW	18-7839
25A	648	ML-648-304174 & UP	②	48	670	M-670-02641 — 002160	②
25A	648	M-648-19025 & BELOW	18-7839	W48	670	ML-670-311996 & UP	18-7839
25A	648	M-648-19026 & UP	②	W48	670	M-670-002161 & UP	18-7839
25C TPE	695	EL-695-550101 — 555959	②	55	663	EL-663-315379 — 317710	18-7839
25C TPE	695	EL-695-555960 & UP	18-7839	55	663	EL-663-317711 & UP	②
25C TPE	695	E-695-250101 — 253861	②	55	663	E-663-004041 — 004317	18-7839
25C TPE	695	E-695-253862 & UP	18-7839	55	663	E-663-004318 & UP	②
25C TPE	695	ML-695-300101 — 318173	②	55	663	ML-663-36475 & BELOW	18-7839
25C TPE	695	ML-695-318174 & UP	18-7839	55	663	M-663-02730 & BELOW	18-7839
25C TPE	695	M-695-000101 — 023895	②	W55	663	ML-663-578278 — 583880	18-7839
25C TPE	695	M-695-023896 & UP	18-7839	W55	663	ML-663-583881 & UP	②
28	644	EL-664-570795 & BELOW	18-7839	60 2 CYL	6F0	ALL	18-7839
28	644	EL-664-570796 & UP	②	60 2 CYL	675	EL-675-30101 — 300280	18-7839
28	644	E-664-270310 & BELOW	18-7839	60 2 CYL	675	EL-675-300281 — 304180	②
28	644	E-664-270311 & UP	②	60 2 CYL	675	EL-675-304180 & UP	18-7839
28	644	ML-664-451125 & BELOW	18-7839	60 2 CYL	675	E-675-00101 — 000180	18-7839
28	644	ML-664-451126 & UP	②	60 2 CYL	675	E-675-00181 — 001170	②
28	644	M-664-151345 & BELOW	18-7839	60 2 CYL	675	E-675-001171 & UP	18-7839

① Requires the use of both 18-7837 and 18-7838

② Requires the use of both 18-7839 and 18-7840

8' LENGTH COMPLETE FUEL LINE ASSEMBLIES



3/8"
FUEL LINE ASSEMBLY

18-8010EP-2 *SILVERADO 4000 Premium*



18-8068
18-8082
TANK
CONNECTOR
(SOLD SEPARATELY)



18-8084
FUEL
CONNECTOR



18-8005EP-1
PRIMER
BULB

18-8083
FUEL
CONNECTOR



FUEL LINE ASSEMBLY COMPONENTS

8' LENGTH COMPLETE FUEL LINE ASSEMBLIES



3/8"
FUEL LINE ASSEMBLY

18-8012EP-2 *SILVERADO 4000 Premium*

OE# 32-858114Q08,
32-858114K08



18-8074
HOSE BARB



18-8005EP-1
PRIMER
BULB



18-8073
HOSE BARB



FUEL LINE ASSEMBLY COMPONENTS

Has 1/4" NPT threaded fitting on engine end and 1/4" NPT threaded fitting on the tank end. Primer bulb is included in this 8ft. (2.44 m) assembly. Fits various applications using the older style twist type disconnects at the engine end and either a bayonet or thread-in fitting on the tank end.

8' LENGTH COMPLETE FUEL LINE ASSEMBLIES



3/8"
FUEL LINE ASSEMBLY

18-8024EP-2 *SILVERADO 4000 Premium*

OE# 32-858104Q08,
32-858104K08



18-8074
HOSE BARB



18-8005EP-1
PRIMER
BULB



18-8076
FUEL
CONNECTOR



FUEL LINE ASSEMBLY COMPONENTS

Has standard quick connect type fitting on engine end and 1/4" NPT threaded fitting on the tank end. Primer bulb is included in this 8 ft. (2.44 m) assembly.

Fits Force 40 HP and larger (1993 & Newer), Force 9.9/15/25HP (1998), and all Mercury/Mariner outboards using clip on type disconnect at engine ends and a tank with threaded fuel pickup fitting.

* Tanks and Engines for picture purpose only.

8' LENGTH COMPLETE FUEL LINE ASSEMBLIES

3/8"
FUEL LINE ASSEMBLY

18-8025EP-2 *SILVERADO 4000 Premium*

OE# 32-858105Q08,
32-858105K08



*

*

FUEL LINE ASSEMBLY COMPONENTS

Has standard quick connect type fitting on engine end and bayonet style fitting on the tank end. Primer bulb is included in this 8 ft. (2.44 m) assembly.
Fits Force 40 HP and larger (1993 & Newer), Force 9.9/15/25HP (1998) , and all Mercury/Mariner outboards using clip-on type disconnect at the engine end and an older style tank with bayonet type connection.

8' LENGTH COMPLETE FUEL LINE ASSEMBLIES

3/8"
FUEL LINE ASSEMBLY

18-8016EP-2 *SILVERADO 4000 Premium*

OE# 32-858109Q12,
32-858109K12



*

*

FUEL LINE ASSEMBLY COMPONENTS

Has double sealed quick connect type fitting on tank end and clip-on type quick connect on engine end. Primer bulb is included in this 8ft. (2.44m) assembly.
Fits Force 40 HP and larger (1993 & Newer), Force 9.9/15/25HP (1998) and all Mercury Mariner outboards using clip-on type disconnects at both tank and engine ends

* Tanks and Engines for picture purpose only.

PRIMER BULBS



18-8002EP-1
18-8002EP-1-10①
PRIMER BULB
1/4"

18-8005EP-1
18-8005EP-1-10①
PRIMER BULB
3/8"

Replaces: 13330A3,
13330Q, 13330Q5
Large capacity bulb

18-8004EP-1
18-8004EP-1-10①
PRIMER BULB
5/16"

Replaces: 89396A38,
89396Q38
Large capacity bulb

HOSE BARB APPLICATION



PART #	MERCURY OE #	BARB	NPT	CONN. TYPE
18-8054	22-63186	5/16"	1/8"	Male
18-8055	22-63187	5/16"	1/4"	Male
18-8073	-	3/8"	1/8"	Male
18-8074	-	3/8"	1/4"	Male



18-7599
FUEL LOCK

Protect your outboard from theft, disconnect fuel line and simply install fuel lock. Designed to fit clip on style fuel connectors. Fits: Johnson Evinrude, Mercury/Mariner, Yamaha and Honda.

① Discount shop pack of 10 - Priced per package



18-7083
PRIMER BULB
 Replaces: 858763, 8168773, 8168772, 8168771, 816877, 684311
 Fits: 30 2cyl(All), 30 JET 3cyl(All), 40 2cyl(All), 40 3cyl(All), 40 JET(All), 50 3cyl(G590000 & Up), 55 3cyl(G590000 & Up), 60 3cyl(G590000 & Up), 60 3cyl Bigfoot(All), 65 JET (All), 75 3cyl(D283222 & Up), 90 3cyl(D283222 & Up)



18-80410-1
FUEL CONNECTOR
 Replaces: 22-13563T3
Female Hose connector
 3/8"
 Fits: 4/5 2-Stroke (1999 & Up)
 Mates with **18-80412**



18-80412
FUEL CONNECTOR
 Replaces: 22-816856T2
Male Hose connector
 5/16"
 Fits: 100 4-cyl. (1988-99), 115 4-cyl. (1989 & up), 125 4-cyl. (1994 & up), 65 Jet (1994 & up), 75 3-cyl. (1987 & up), 80 Jet (1994 & up), 90 3-cyl. (1987 & up)
 Mates with **18-80410-1**



18-8068
TANK CONNECTOR
 (1/4" NPT)
 (Female)



18-8069
FUEL CONNECTOR
 5/16"
 Replaces: 22831Q3, 22831A3, 22831A4, 22831B3, 22831A1
 (Female)



18-8070
FUEL CONNECTOR
 5/16"
 Replaces: 30185A3, 30185Q3, 30185B3, 30185A1, 29196, 16610M
 (Male)



18-8075
FUEL CONNECTOR
 (1/4")
 Replaces: 22-14213M, 2214213Q, 22-81042M
 Mates with **18-8077-1**



18-8076
18-8076-10
FUEL CONNECTOR
 (3/8")
 Replaces: 22-13563A3, 22-13563Q3
 Mates with **18-8077-1**



18-8077-1
18-8077-1-10
TANK CONNECTOR
 (1/4" NPT)
 Mates with **18-8075, 18-8076, 18-8085**



18-8082
TANK CONNECTOR
 Mercury Straight Fitting
 (1/4" NPT)
 (Female)



18-8083
FUEL CONNECTOR
 3/8"
 (Female)



18-8084
FUEL CONNECTOR
 3/8"
 Replaces: 30185A3, 30185Q3, 30185B3, 30185A1, 29196, 22-16610M
 (Male)



18-8085
18-8085-10
FUEL CONNECTOR
 (5/16")
 Mates with **18-8077-1**



18-8091
FUEL CONNECTOR
 (3/8")
 Replaces: 22-13563Q7, 22-13563T7, 22-13563A7, 22-13563A6
 Mates with **18-80402**



18-80402
FUEL CONNECTOR
 (1/4" NPT)
 Mates with **18-8091**

**- UNIVERSAL DESIGN -
DIRECT REPLACEMENT FOR MERCURY AND YAMAHA
FUEL WATER SEPARATOR BRACKETS**



Bracket Type	Part #	Replaces	Bracket Type	Part #	Replaces
1/4" Stainless Steel	18-7777		1/4" Aluminum	18-7853-1	Mercury 89876A3, 89876, 55481
3/8" Stainless Steel	18-7776		3/8" Aluminum	18-7775	

FUEL WATER SEPARATOR KITS

**21 MICRON FILTER
KITS FOR
CARBURETED
ENGINES**



Kit Type	Part #	Micron Rating	Contents	Replaces
1/4" Aluminum (Short Filter)	18-7848-1 •	21	1 - 18-7844 filter & 1 18-7853-1 bracket 2 - 18-4256 1/4" pipe plugs	35-807172A4, Q4, 35-60494A4, 35-805369A4, 35-57250A1, 35-55501A1, 35-52456A1, 35-60494A1, 52444
1/4" Aluminum Bonus Pack Contains spare filter	18-7848-2	21	2 - 18-7844 filter & 1 18-7853-1 bracket 2 - 18-4256 1/4" pipe plugs	
1/4" Aluminum (Tall Filter)	18-7852-1	21	1 - 18-7845 filter & 1 18-7853-1 bracket 2 - 18-4256 1/4" pipe plugs	
1/4" Aluminum Bonus Pack Contains spare filter	18-7852-2 •	21	2 - 18-7845 filter & 1 18-7853-1 bracket 2 - 18-4256 1/4" pipe plugs	
3/8" Aluminum (Tall Filter)	18-7775-1	21	1 - 18-7845 filter & 1 18-7775 bracket 2 - 18-4264 3/8" pipe plugs	
1/4" Stainless Steel (Tall Filter)	18-7777-1 •	21	1 - 18-7845 filter & 1 18-7777 bracket 2 - 18-4256 1/4" pipe plugs	
3/8" Stainless Steel (Tall Filter)	18-7776-1	21	1 - 18-7845 filter & 1 18-7776 bracket 2 - 18-4264 3/8" pipe plugs	

• Display Packaged

10 MICRON FILTER KITS FOR FUEL INJECTED ENGINES

• Display Packaged



Kit Type	Part #	Micron Rating	Contents
1/4" Aluminum (Short Filter)	18-7983-1 •	10	1 - 18-7944 filter & 1 18-7853-1 bracket • 2 - 18-4256 1/4" pipe plugs
1/4" Aluminum Bonus Pack (Contains spare filter)	18-7983-2 •	10	2 - 18-7944 filter & 1 18-7853-1 bracket • 2 - 18-4256 1/4" pipe plugs
1/4" Aluminum (Tall Filter)	18-7982-1 •	10	1 - 18-7945 filter & 1 18-7853-1 bracket • 2 - 18-4256 1/4" pipe plugs
1/4" Aluminum Bonus Pack (Contains spare filter)	18-7982-2 •	10	2 - 18-7945 filter & 1 18-7853-1 bracket • 2 - 18-4256 1/4" pipe plugs
1/4" Aluminum (High Capacity Filter)	18-7966-1 •	10	1 - 18-7866 filter & 1 18-7853-1 bracket • 2 - 18-4256 1/4" pipe plugs
3/8" Aluminum (Tall Filter)	18-7986-1	10	1 - 18-7945 filter & 1 18-7775 bracket • 2 - 18-4264 3/8" pipe plugs
1/4" Stainless Steel (Tall Filter)	18-7984-1 •	10	1 - 18-7945 filter & 1 18-7777 bracket
3/8" Stainless Steel (Tall Filter)	18-7985-1 •	10	1 - 18-7945 filter & 1 18-7776 bracket • 2 - 18-4264 3/8" pipe plugs
1/4" Aluminum (Tall Filter)	18-79912	10	1 - 18-79911 & 1 - 18-7853-1



10 MICRON FILTER KITS WITH DRAIN BOWLS

Sierra AquaVue™ and metal bowl separator filters allow water to be drained from the filter to extend service life. Use the AquaVue™ bowl for outboard, above deck installations. USCG regulations require the use of the flame resistant metal bowl below deck.

Kit Type	Part #	Micron Rating	Contents
1/4" Aluminum w/ AquaVue™ bowl	18-7932-1 •	10	1 - 18-7919 filter & 1 18-7853-1 bracket 1 - 18-7922-1 AquaVue™ bowl 2 - 18-4256 1/4" pipe plugs
1/4" Aluminum w/ metal drain bowl	18-7951 •	10	1 - 18-7919 filter & 1 18-7853-1 bracket 1 - 18-7924 metal bowl 2 - 18-4256 1/4" pipe plugs
1/4" Stainless Steel w/ AquaVue™ bowl	18-7937-1 •	10	1 - 18-7919 filter & 1 18-7777 bracket 1 - 18-7922-1 AquaVue™ bowl 2 - 18-4256 1/4" pipe plugs
1/4" Stainless Steel w/ metal drain bowl	18-7938 •	10	1 - 18-7919 filter & 1 18-7777 bracket 1 - 18-7924 metal bowl 2 - 18-4256 1/4" pipe plugs

• Display Packaged

COMPACT BRACKET AND SEPARATOR KIT FOR SMALL OUTBOARDS AND FRESH WATER APPLICATIONS



18-7774
COMPACT ALUMINUM BRACKET



18-7965-1
10 MICRON COMPACT SEPARATOR KIT

Contains:
1 - 18-7774 bracket
1 - 18-7865 filter



REPLACEMENT FILTERS



UNIVERSAL DESIGN - DIRECT REPLACEMENT FOR MERCURY AND YAMAHA

10 MICRON REPLACEMENT FILTERS		
Part #	Description	Replaces
18-7944	Short - 3.875"	35-807172, 35-802893Q, 35-806771, 35-8053691, 35-805369, 35-604941, 35-60494, 35-57250, 35-55501, 35-52456,
18-7945	Long - 4.35"	35-802893Q, 35-806771, 35-8053691, 35-805369, 35-604941, 35-60494, 35-57250, 35-55501, 35-52456
18-7866	High Capacity - 6"	
18-7865	Compact 10 Micron	
18-7967	Early model with sensor	35-18458Q3, 35-18458A3, 35-18458A2, 35-17808A1, 35-14571A1
18-7968	Late model with sensor	35-18458Q4, 35-184585

10 MICRON REPLACEMENT FILTERS		
Part #	Description	Replaces
18-79911	Long - 8.5"	35-8M0079962

21 MICRON REPLACEMENT FILTERS		
Part #	Description	Replaces
18-7844	Short - 3.875"	35-807172, 35-807172, 35-806771,
18-7845	Long - 4.35"	35-8053691, 35-60494A4, 35-604941, 35-57250, 35-55501



10 MICRON REPLACEMENT FILTERS AND KITS WITH DRAIN BOWLS
(SEE CHART BELOW)

- Display Packaged



18-8955 FUEL WATER SEPARATOR COVER
Fits: 18-7944 & 18-7945 sized filter

REPLACEMENT FILTERS		
Part #	Description	Replaces
18-7919	Spin on replacement	35-809097, 35-8M0103095 Racor S3213
18-7920	Spin on replacement	35-809099 Racor S3214
18-7948	Spin on replacement Fits - 320RRAC01	35-886638 Racor S3227

REPLACEMENT BOWLS		
Part #	Description	
18-7922-1	AquaVue™ Collection Bowl	
18-7924	Metal Collection Bowl	

FILTER & BOWL KITS	
Part #	Description
18-7928-1	• Filter & AquaVue™ Bowl Mercury Style Contains: 18-7919 filter, 18-7922-1 bowl
18-7929	• Filter & Metal Bowl Mercury Style Contains: 18-7919 filter, 18-7924 bowl
18-7969	• Filter & Metal bowl Contains: 18-7948 filter, 18-7924 bowl
18-7994-1	• Filter & AquaVue™ Bowl Contains: 18-7948 filter, 18-7922-1 bowl



18-7936 FUEL FILTER ELEMENT
Replaces: 35-888289T2
Fits: 225 EFI (2003-06) (SN 0T653945 & Up)



18-7712 FUEL FILTER (INLINE)
Replaces: 35-16248
Fits: 4/5 2 cyl (1999 & Up), 4/5/6 4 stroke (1999 & Up), 8/9.9 4-stroke (2005 & Up)



18-7713 FUEL FILTER (INLINE)
Replace: 35-80365M
Fits: Mercury/Mariner 9.9 4-Stroke(1995-98), 15 4-Stroke (1998 & Up), Yamaha 6 (1989, 1992-99), 8 (1989-99, 2001-02), F4 (1999-02), F9.9 (1989-95, 1997-99, 2001-02), FT 9.9 (1988-90)



18-7714 FUEL FILTER (INLINE)
Replaces: 35-877565T1
Fits: 25 4-Stroke (1998 & Up), 30 4-Stroke (1999-01), 30 3 cyl 4-Stroke (1999-01), 40 4-Stroke (1998-01), 40 4-Stroke 4 cyl (2001-02), 40 Carb 3-cyl 4-Stroke (2002 & Up), 50 4-Stroke 4 cyl (2001-02), 60 4-Stroke 4 cyl (2001-02), 75 4-Stroke (2000 & Up), 90 4-Stroke (2000 & Up)



18-7718 FUEL FILTER (INLINE)
5/16"
Replaces: 35-879885T
For: 135/150/175 4-Stroke Verado (S/N 1B227000 & Up), 200/225 4-Stroke Verado (S/N OT980000 & Up), 250/275 4-Stroke Verado (S/N OT801000 & Up)



18-7802 FUEL FILTER
Replaces: 35-87946A3, 35-87946-Q3, Q4
For: 6 HP thru 25 HP



18-7832 FUEL FILTER
Replaces: 1399-3938, 1399-1754, 1399-1136
For: AJ, KA, KB, KC, KD, WM, WMC Carb.



18-7979 FUEL FILTER
Replaces: 881540
Fits: 115 EFI (4 Stroke), 75HP (4 Stroke), 75HP (4 Stroke) (Bodensee), 90HP (4 Stroke)



18-7981
FUEL FILTER
Replaces: 35-884380T, 35-8M0020349
Fits: All Verados, 90HP (DFI) (3 cyl), 115 DFI (3 cyl) / 200HP (DFI) / 225HP (DFI) (including 3.0L DFI)

FUEL FILTERS



Part #	Application
18-7828-1	1/4" small capacity (For 1/4" fuel line)
18-7829	1/4" large capacity (For 1/4" fuel line) Replaces: 35-16494, 35-816296, 35-816296T, 35-816296K03
18-7830	5/16" Replaces: 35-164941, 35-816296-1, 35-816296T1, 35-8162961, 35-816396Q1 35-816296B2, 35-816296B1, 35-134301
18-7831	3/8" Replaces: 802128A1



18-7997
AIR FILTER
Replaces: 35-853333T, 35-853333
Fits: V115 DFI (2.5L) (2000), V-135 DFI (2.5L) (1998 & Up), V-150 DFI (2.5L) (1998 & Up), V-175 DFI (2.5L) (2001 & Up), 200 DFI (1998-02), 225 DFI (1998-02)



18-7999
AIR FILTER
Replaces: 35-896247
For: 135/150/175 4-Stroke Verado (S/N 1B227000 & Up)

PKG. OF 10



18-7113-9Ⓜ
O-RING
Replaces: 25-897536, 25-98277
Fits: 18-7802 Filter Element (35-87946Q3)



18-3605
THERMOSTAT KIT
Fits: V-135 DFI (2.5L)(1998 & Up), V-150 DFI (2.5L)(1998 & Up), V-175 DFI (2.5L)(2000 & Up)

① **18-3606D**



18-3606
THERMOSTAT KIT 130°
Fits: 200 3.0L DFI DTS (ALL), 200 3.0L EFI (2003 & Up) (OT750164 & Up), 200 DFI (1997 & Up)(OG386496 & Up), 225 3.0L EFI (1999 & Up)(OG760300 & Up), 225 3.0L EFI SeaPro (2004 & Up)(OT801000 & Up), 225 3.0L DFI DTS (2003 & Up)(OT599000 & Up), 225 DFI (1998 & Up) (OG590000 & Up), 250 3.0L EFI (1999 & Up) (OG760300 & Up), 250 Long 3.0L EFI (OT861319 & Up)



18-43175
THERMOSTAT KIT 130°
Replaces: 855676002
Fits: Mercury 15 Carb(2cyl) 4-Stroke(R235949 & Up), 15 SeaPro 4-Stroke(R051685 & Up), 20 Carb(2cyl) 4-Stroke(R235168 & Up), 25 EFI(3cyl)4-Stroke(R106999 & Up), 25 Jet EFI(3cyl)4-Stroke(R165086 & Up), 25 SeaPro 4-Stroke(R051710 & Up), 30 EFI(3cyl)4-Stroke(T409000-1B226999), 8 4-Stroke(209cc)(R042475 & Up), 9.9 4-Stroke(209cc)(R042475 & Up)



① **18-3672D**



18-3672
THERMOSTAT KIT

— CONTAINS —

Part #	Desc.	O.E. #
18-3553	Thermostat, Brass	75692
18-0182	Thermostat Gasket	27-62386

HP	Beg. S/N	End S/N	HP	Beg. S/N	End S/N
V135	A904646	& UP	V150 MAGI	C239553	4571651
V150	A904646	& UP	V150 MAGIII	D082000	4825248
V150 XR4	C239553	C159199	V175	C100861	& UP
V150 XR6	D082000	& UP	V200	6435503	& UP



18-3569
THERMOSTAT KIT
Replaces: 803061T1
 Includes **18-3549** thermostat

HP	Beg. S/N	End S/N	HP	Beg. S/N	End S/N
70 3 cyl.	A996142	& UP	100 4 cyl.	B209468	& UP
75 3 cyl.	C222000	& UP	115 4 cyl.	C100000	& UP
80 3 cyl.	A996142	& UP	125 4 cyl.	D283222	& UP
90 3 cyl.	A996142	& UP			



18-43052
THERMOSTAT KIT
Replaces: 14586A3, 75962A9, 75962A10, 75962A11
Fits: Mercury 6-25 hp 2-Stroke



18-3535
THERMOSTAT 130°
Replaces: 885599004
Fits: 200 3.0L DFI DTS (ALL), 200 3.0L EFI (2003 & Up) (OT750164 & Up), 200 DFI (1997 & Up)(OG386496 & Up), 225 3.0L EFI (1999 & Up)(OG760300 & Up), 225 3.0L EFI SeaPro (2004 & Up)(OT801000 & Up), 225 3.0L DFI DTS (2003 & Up)(OT599000 & Up), 225 DFI (1998 & Up)(OG590000 & Up), 250 3.0L EFI (1999 & Up) (OG760300 & Up), 250 Long 3.0L EFI (OT861319 & Up)



18-3536
THERMOSTAT 143°
Replaces: 833072003
Fits: V135 DFI 2.5L (1998 & Up)(OG590000 & Up), V150 DFI 2.5L (1998 & Up)(OG590000 & Up), V175 DFI 2.5L (2001 & Up)(OT178500 & Up)



18-3537
THERMOSTAT 143°
Replaces: 833072002, 833072004
Fits: 75 3 cyl DFI 1.5L (2006 & Up)(OT980000 & Up), 90 3 cyl DFI 1.5L (2004 & Up)(OT801000 & Up), 115 3 cyl DFI 1.5L (2004 & Up)(OT801000 & Up)

① Items ending in "D" are Display Packaged - Regular number is Non-Display

② Priced per package



18-3631
THERMOSTAT W/ HOUSING
 Replaces: 892864T04
 Fits: 135-300 Verado



18-3633
THERMOSTAT
 Replaces: 8M0090819
 Fits: 75-115HP, 115 Pro XS (2B094996 & Up)



18-3635
THERMOSTAT
 Replaces: 892864T06
 Fits: 75-115HP (1B366823-2B094995), 150 EFI (1B905505 & Up)



18-3638
THERMOSTAT
 Replaces: 804540
 Fits: 2.5-3.5HP (0R131842 & Up), 4-6HP (0R411838 & Up)



18-3640
THERMOSTAT
 Replaces: 8M0117413
 Fits: 40-60HP (1C050252 & Up)



18-3642
THERMOSTAT
 Replaces: 855676A1
 Fits: 40HP (3Cyl) (1C049739 & Up)



Display Package

18-3553
THERMOSTAT
 Replaces: 62981, 66850, 75692
 143°

18-3553 THERMOSTAT APPLICATION					
HP	Beg. S/N	End. S/N	HP	Beg. S/N	End. S/N
7.5	5226935	& UP	V150	A904646	& UP
9.8	5206550	& UP	V175	C100861	& UP
40	3336258	C159199	V200	6435503	& UP
50/60	D000750	& UP	V220	B117316	& UP
65	3547987	4571651	V225	5628028	& UP
70	4571652	4825248	V300/3.4L	5611648	& UP
70/75/80/90	A996142	& UP	XR4	C239553	D081999
100/115	B209468	& UP	Magnum II	C239553	D081999
V135	A904646	& UP			



18-3549
THERMOSTAT
 Replaces: 14586
 For: 6, 7, 8, 9.9 & 15 HP
 Mercury/Mariner A197112 & Later
 120°

18-3549 THERMOSTAT APPLICATION		
MARINER		
HP	Serial #	
6,8,9,9 (2 cyl.)	A197112	Later
Sea Pro 10	D038000	Later
15 (2 cyl.)	B292414	Later
18XD, 20XD, 25XD	B114231	Later
25 (2 cyl.) 25 Sea Pro	B238464	Later
30 (2 cyl.)	G055314	Later
45 Jet, 50, 55, 60 (3 cyl.)	G290585	Later
MERCURY		
Sea Pro 10	D038000	Later
15 (2 cyl.)	B292414	Later
18XD, 20XD, 25XD	B114231	Later
25 (2 cyl.) 25 Sea Pro	B238464	Later
30 (2 cyl.)	G055314	Later
45 Jet, 50, 55, 60 (3 cyl.)	G290585	Later



18-3556
THERMOSTAT
 Replaces: 895338
 3/4" - 130°



18-43051
THERMOSTAT COVER KIT
 Fits: Mercury V6



18-5896
SENDER
 Replaces: 12415
 1/8" - 27NPT Threads



18-3007
18-3007-10¹
IMPELLER
 Replaces: 47-89983,
 47-89983T



18-3008
IMPELLER
Replaces: 47-20813, 47-25287



18-3012
IMPELLER
Replaces: 47-22748



18-3017
18-3017-10Ⓢ
IMPELLER
Replaces: 47-89984, 47-899842, 47-89984T3, 47-89984T4, 47-899844, 47-30221, 47-65960, 47-85460



18-3039
IMPELLER
Replaces: 47-65957, 47-89981, 47-39074
• .456" ID



18-3052
IMPELLER
Replaces: 47-56780, 47-65958, 47-89982



18-3054
IMPELLER
Replaces: 47-68988, 47-89980
• .438" ID



18-3056
18-3056-10Ⓢ
IMPELLER
Replaces: 47-430261, 47-430262, 47-43026T2, 47-430264



18-3057
IMPELLER
Replaces: 47-85089-3



18-3062
IMPELLER
Replaces: 47-420381, 47-420382, 47-42038Q02



18-3063
IMPELLER
Replaces: 47-95611M, 47-81242M



18-3066
IMPELLER
Replaces: 47-11590M



18-3067
IMPELLER
Replaces: 47-84797M, 47-81604M



18-3069
IMPELLER
Replaces: 47-81423M, 47-97108M, 47-82824M



18-3072
IMPELLER
Replaces: 47-80395M



18-3073
IMPELLER
Replaces: 47-96305M



18-3074
IMPELLER
Replaces: 47-84027M, 47-84027T, 47-96619M



18-3098
IMPELLER
Replaces: 47-161543, 47-16154

APPLICATION BEGINS ON PAGE 399

Ⓢ Discount shop pack of 10 - Priced per package

 <p>18-45312 IMPELLER Replaces: 47-95289, 47-952892 Fits: Mercury 2(T884302 & Up), 2.5(A855097 & Up), 3.3(G710613 & Up)</p>	 <p>18-8900 IMPELLER Replaces: 47-19453</p>	 <p>18-3293 IMPELLER KEY Replaces: 28-43037 Also large O/B's</p>	 <p>18-3294 IMPELLER KEY Replaces: 28-81603M</p>	
 <p>18-3300 IMPELLER KEY Replaces: 28-83444M For models: 40A, 40B, 40C</p>	 <p>18-3305 IMPELLER KEY Replaces: 28-81912M, 28-83701M For models: 6C-D, 8C, 9.9C, 15C</p>	 <p>New 18-1838 SEAL, SHORT (1 3/4") Replaces: 43023 25 (4-Stroke), 30 (2 Cyl.), 30 (4-Stroke), 40 (2 Cyl.), 40 (3 Cyl.), 40 (4-Stroke), 50 (3 Cyl.), 50 (4-Stroke), 50 Bigfoot (4-Stroke)</p>	 <p>New 18-1839 SEAL, LONG (2 1/4") Replaces: 8235471 25 (4-Stroke), 30 (2 Cyl.), 30 (4-Stroke), 40 (2 Cyl.), 40 (3 Cyl.), 40 (4-Stroke), 50 (3 Cyl.), 50 (4-Stroke), 50 Bigfoot (4-Stroke)</p>	
 <p>18-3109 WATER TUBE GUIDE Replaces: 23-29804, 23-29804T, 23-52928 (Use with 18-3116 Housing)</p>	 <p>18-3013 UPPER WATER PUMP SEAL Replaces: 26-821309 For: 4-Stroke O/B's, 25/30/40/45/50 HP s/n OG760300 & UP</p>	 <p>18-3110 WATER PUMP HOUSING WITH BUSHING Replaces: 26-38970, 26-36557A1, 26-29677 (Part of 18-3116 Housing)</p>	 <p>18-3014 LOWER WATER PUMP SEAL Replaces: 26-821310 For: 4-Stroke O/B's, 25/30/40/45/50 HP s/n OG760300 & UP</p>	 <p>18-3151 WATER COUPLING ASSEMBLY Replaces: 816597</p>
 <p>18-3154 WATER COUPLING ASSEMBLY Replaces: 826763A</p>	<p>PKG. OF 5</p>  <p>18-3227 18-3227-9 WATER PUMP DOWEL PIN Replaces: 17-35973 For: 20-225HP S/N 1866496-Up</p>	 <p>18-1730 COUPLING Replaces: 43585 For: 200, 225, 250 & 275 Verado's</p>	 <p>18-3113 INSERT CUP Replaces: 70977</p>	 <p>18-3114 INSERT CUP Replaces: 48752, 48752T</p>
 <p>18-3115 INSERT CUP Replaces: 48753</p>	 <p>18-3435 INSERT CUP</p>	 <p>18-3107 IMPELLER PLATE Replaces: 54705, 32768</p>	 <p>18-3117 IMPELLER PLATE Replaces: 32435, 324351, 30605</p>	 <p>18-3122 IMPELLER PLATE Replaces: 817276, 8172761, 8172763</p>
 <p>18-3139 IMPELLER PLATE Replaces: 46895</p>	 <p>18-3436 IMPELLER PLATE</p>	<p>New</p>  <p>18-4577 WEAR PLATE Replaces: 8213542</p>	 <p>18-3116 WATER PUMP HOUSING Replaces: 46-96148, 46-96148A1, 46-96148T1, 46-64141A1, 46-48743A1</p>	 <p>18-3118 WATER PUMP HOUSING Replaces: 46-48746A1, 46-77822A1, 46-48746A3</p>



18-3414
WATER PUMP BASE
Replaces: 46-96146A5, 46-73804A1



18-3416
WATER PUMP BASE
Replaces: 46-96146A6, 46-96146A2, 46-78400A1, 46-73802A2



18-3419
WATER PUMP BASE
Replaces: 46-42579A3



18-3422
WATER PUMP BASE
Replaces: 46-77516A1, 46-73842A2, 46-68390A1, 46-65498A1, 46-48745A1



18-3423
WATER PUMP BASE
Replaces: 46-73640A1



18-3424
WATER PUMP BASE
Replaces: 46-77177A1



18-3445
WATER PUMP BASE
Replaces: 46-812966A7, 46-812996A3, 46-812996A9
For: 40-60 HP



18-43212
WATER PUMP HOUSING
Replaces: 46-803750A02, 46-8037502
Fits: Mercury 8/9.9 4-Stroke(209cc)



① **18-3207D**



18-3207
IMPELLER REPAIR KIT
Replaces: 47-89983T2, 47-89983Q1

— CONTAINS —

Part #	Desc.	O.E. #	Qty.
18-3007	Impeller	47-89983	1
18-2945	Drain Gasket	12-20260,12-19183	2
18-2823	Low. Water Pump Base to Face Plate Gasket	27-32769, 27-19553	1
18-2824	Upper Face Plate to Pump Body Gasket	27-32770	1
18-2825	Water Pump Base Gasket	27-32771,27-19551	1
18-2841	Water Pump Base Gasket	27-77417,27-19552	1
18-2948	Rubber Washer	12-49221-1	1
18-3107	Plate	54705	1
18-7155	O-Ring	25-26855	1
18-7174	O-Ring	25-45711	1
18-7115	O-Ring	25-26722	1



① **18-3214D**



18-3214
IMPELLER REPAIR KIT
Replaces: 47-43026T6, 47-43026T8, 47-43026T11

— CONTAINS —

Part #	Desc.	O.E. #	Qty.
18-2564	Water Pump Base to Face Plate Gasket	27-43033-1	1
18-2565	Water Pump Base to Gear Housing Gasket	27-43047-1	1
18-2566	Face Plate to Water Pump Cover Gasket	27-817277	1
18-2944	Seal Ring	26-45577	1
18-3056	Impeller	47-43026-1	1
18-3122	Impeller Plate	817276	1
18-7420	O-Ring	25-21836	2



① **18-3215D**



18-3215
IMPELLER REPAIR KIT
Replaces: 47-85089T7

— CONTAINS —

Part #	Desc.	O.E. #	Qty.
18-2560	Impeller Washer Gasket	12-86645	2
18-2561	Gear Housing to Face Plate Gasket	27-85087	1
18-2562	Gear Housing to Face Plate Gasket	27-99326-1	1
18-3057	Impeller	47-85089-3	1
18-7419	O-Ring	25-69202	1



18-3149-2
WATER PUMP KIT
Replaces: 46-42040A1, 46-42040A3, 46-42040A5, 46-42040T5
For: 10 Magnum, Marathon, Sea Pro, Viking
15 Marathon, Sea Pro 6, 8, 9.9HP, XR10

APPLICATION BEGINS ON PAGE 399

① Items ending in "D" are Display Packaged - Regular number is Non-Display



18-3265
IMPELLER REPAIR KIT

Replaces: 47-43026Q06, 47-43026T11, 47-8M0100526
For: 135/150/175 4-Stroke Verado (S/N 1B227000 & Up), 200/225 4-Stroke Verado (S/N OT980000 & Up), 250/275 4-Stroke Verado (S/N OT801000 & Up)



①18-3217D



18-3217
IMPELLER KIT

Similar to: 46-96148A5 without base or housing

— CONTAINS —

Part #	Desc.	O.E. #	Qty.
18-3109	Water Tube	23-29804	1
18-3017	Impeller	47-89984	1
18-2919	Water Pump Gasket	27-42631-1	1
18-3110	Grommet	26-38970	1
18-2945	Drain Gasket	12-20260,12-19183	2
18-2826	Water Pump Base to Gear Housing Gasket	27-85610	1
18-2914	Water Pump Gasket	27-85608-1	1
18-2915	Water Pump Gasket	27-85609-1	1
18-2944	Seal Ring	26-45577	1
18-3117	Plate	32435	1
18-7158	O-Ring	25-30613	1
18-7162	O-Ring	25-33145	1
18-7173	O-Ring	25-30224	1
18-7176	O-Ring	25-90011	1
18-2801	Water Pump Gasket	27-32438	1
18-7426	O-Ring	35-30271	1

①18-3239D



18-3239
IMPELLER REPAIR KIT

— CONTAINS —

Part #	Desc.	O.E. #	Qty.
18-3039	Impeller	47-89981	1
18-3139	Impeller Plate	46895	1
18-7409	O-Ring	—	1



18-3252
IMPELLER REPAIR KIT

Replaces: 47-89982T1

— CONTAINS —

Part #	Desc.	O.E. #	Qty.
18-2004	Oil Seal	26-20070	2
18-2006	Oil Seal	26-897154	1
18-2827	Upper Face Plate to Water Pump Body Gasket	27-39623	1
18-2828	Lower Water Pump Base to Face Plate	27-39625	1
18-3052	Impeller	47-89982	1
18-7164	O-Ring	25-33466	1



18-3406
UPPER WATER PUMP REPAIR KIT

Replaces: 817275A08
For: 135/150/175 4-Stroke Verado (S/N 1B227000 & Up), 200/225 4-Stroke Verado (S/N OT980000 & Up), 250/275 4-Stroke Verado (S/N OT801000 & Up)



18-3407
UPPER WATER PUMP REPAIR KIT

Replaces: 817275A09
For: 135/150/175 4-Stroke Verado (S/N 1B227000 & Up), 200/225 4-Stroke Verado (S/N OT980000 & Up), 250/275 4-Stroke Verado (S/N OT801000 & Up)

APPLICATION BEGINS ON PAGE 399

① Items ending in "D" are Display Packaged - Regular number is Non-Display



18-3314
WATER PUMP KIT

— CONTAINS —

Part #	Desc.	O.E. #	Qty.
18-3109	Water Tube Guide	23-29804	1
18-3017	Impeller	47-89984	1
18-3116	Housing	46-96148A1	1
18-3414	Base	46-96146A5	1
18-2919	Water Pump Gasket	27-42631-1	1
18-3110	Grommet	26-38970	1
18-2945	Drain Gasket	26-20260, 12-19183	2
18-2826	Water Pump Base to Gear Housing Gasket	27-85610-1	1
18-2914	Water Pump Gasket	27-85608-1	1
18-2915	Water Pump Gasket	27-85609-1	1
18-2944	Seal Ring	26-45577	1
18-3117	Plate	32435	1
18-7158	O-Ring	25-30613	1
18-7162	O-Ring	25-33145	1
18-7173	O-Ring	25-30224	1
18-7176	O-Ring	25-90011	1
18-2801	Gasket	27-32438	1
18-7426	O-Ring	35-30271	1

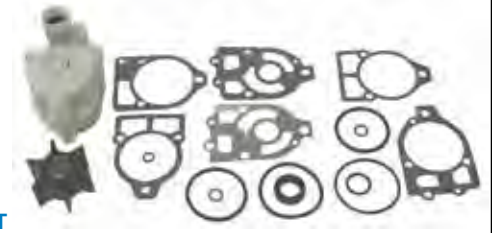

18-3316
WATER PUMP KIT

Replaces: 46-78400A2, 46-96148A8, 46-32437A3
— CONTAINS —

Part #	Desc.	O.E. #	Qty.
18-3109	Water Tube Guide	23-29804	1
18-3017	Impeller	47-89984	1
18-3116	Housing	46-96148A1	1
18-3416	Base	46-96146A6	1
18-2919	Water Pump Gasket	27-42631-1	1
18-3110	Grommet	26-38970	1
18-2945	Drain Gasket	26-20260, 12-19183	2
18-2826	Water Pump Base to Gear Housing Gasket	27-85610-1	1
18-2914	Water Pump Gasket	27-85608-1	1
18-2915	Water Pump Gasket	27-85609-1	1
18-2944	Seal Ring	26-45577	1
18-3117	Plate	32435	1
18-7158	O-Ring	25-30613	1
18-7162	O-Ring	25-33145	1
18-7173	O-Ring	25-30224	1
18-7176	O-Ring	25-90011	1
18-2801	Gasket	27-32438	1
18-7196	O-Ring	25-38099	1
18-7426	O-Ring	35-30271	1



18-3319
WATER PUMP KIT

Replaces: 46-42579A4
— CONTAINS —

Part #	Desc.	O.E. #	Qty.
18-3109	Water Tube Guide	23-29804	1
18-3017	Impeller	47-89984	1
18-3116	Housing	46-96148A1	1
18-3419	Base	46-42579A3	1
18-2919	Water Pump Gasket	27-42631-1	1
18-3110	Grommet	26-38970	1
18-2945	Drain Gasket	26-20260, 12-19183	2
18-2826	Water Pump Base to Gear Housing Gasket	27-85610-1	1
18-2914	Water Pump Gasket	27-85608-1	1
18-2915	Water Pump Gasket	27-85609-1	1
18-2944	Seal Ring	26-45577	1
18-3117	Plate	32435	1
18-7158	O-Ring	25-30613	1
18-7162	O-Ring	25-33145	1
18-7173	O-Ring	25-30224	1
18-7176	O-Ring	25-90011	1
18-2801	Gasket	27-32438	1
18-7426	O-Ring	35-30271	1

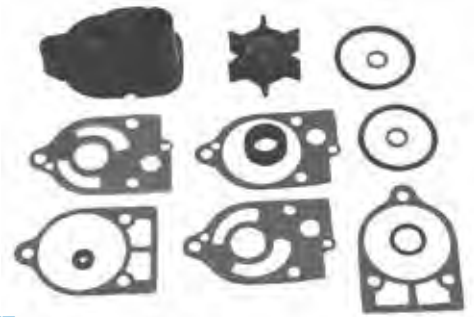

18-3507
WATER PUMP KIT (Without Base)

Replaces: 46-60366A1
— CONTAINS —

Part #	Desc.	O.E. #	Qty.
18-3007	Impeller	47-89983	1
18-3118	Upper Pump Housing	46-77822A1	1
18-2945	Drain Gasket	12-20260, 12-19183	2
18-2823	Lower Water Pump Base to Face Plate Gasket	27-32769, 27-19553	1
18-2824	Upper Face Plate To Body Gasket	27-32770, 27-19551	1
18-2825	Water Pump Base Gasket	27-32771	1
18-2841	Water Pump Base Gasket	27-77417, 27-19552	1
18-2948	Drain Plug	12-49221-1	1
18-3107	Plate	54705	1
18-7155	O-Ring	25-26855	1
18-7174	O-Ring	25-45711	1
18-7115	O-Ring	25-26722	1



18-3517
WATER PUMP KIT (Without Base)

Replaces: 46-96148A5, 46-96148A8, 46-78400A2, 46-73804A3, 46-73802A3, 46-69222A3, 46-64141A11, 46-60367A4, 46-58618A4, 46-57234A3, 46-48747A3, 46-42579A4, 46-44292A4, 46-32437A1
— CONTAINS —

Part #	Desc.	O.E. #	Qty.
18-3109	Water Tube	23-29804	1
18-3017	Impeller	47-89984	1
18-3116	Housing	46-96148A1	1
18-2919	Water Pump Gasket	27-42631-1	1
18-3110	Grommet	26-38970	1
18-2945	Drain Gasket	26-20260, 12-19183	2
18-2826	Water Pump Base to Gear Housing Gasket	27-85610-1	1
18-2914	Water Pump Gasket	27-85608-1	1
18-2915	Water Pump Gasket	27-85609-1	1
18-2944	Seal Ring	26-45577	1
18-3117	Plate	32435	1
18-7158	O-Ring	25-30613	1
18-7162	O-Ring	25-33145	1
18-7173	O-Ring	25-30224	1
18-7176	O-Ring	25-90011	1
18-2801	Water Pump Gasket	27-32438	1
18-7426	O-Ring	35-30271	1



18-3322
WATER PUMP KIT

Replaces: 46-77516A3
— CONTAINS —

Part #	Desc.	O.E. #	Qty.
18-3007	Impeller	47-89983	1
18-3118	Upper Pump Housing	46-77822A1	1
18-3422	Water Pump Base	46-77516A1	1
18-2945	Drain Gasket	12-20260, 12-19183	2
18-2823	Lower Water Pump Base to Face Plate Gasket	27-32769, 27-19553	1
18-2824	Upper Face Plate To Body Gasket Plate To Body	27-32770, 27-19551	1
18-2825	Water Pump Base Gasket	27-32771	1
18-2841	Water Pump Base Gasket	27-77417, 27-19552	1
18-2948	Drain Plug	12-49221-1	1
18-3107	Plate	54705	1
18-7155	O-Ring	25-26855	1
18-7174	O-Ring	25-45711	1
18-7115	O-Ring	25-26722	1



18-3323
WATER PUMP KIT
 Replaces: 46-73640A2

— CONTAINS —

Part #	Desc.	O.E. #	Qty.
18-3007	Impeller	47-89983	1
18-3118	Upper Pump Housing	46-77822A1	1
18-3423	Water Pump Base	46-73640A1	1
18-2945	Drain Gasket	12-20260, 12-19183	2
18-2823	Lower Water Pump Base to Face Plate Gasket	27-32769, 27-19553	1
18-2824	Upper Face Plate To Body Gasket	27-32770, 27-19551	1
18-2825	Water Pump Base Gasket	27-32771	1
18-2841	Water Pump Base Gasket	27-77417, 27-19552	1
18-2948	Drain Plug	12-49221-1	1
18-3107	Plate	54705	1
18-7155	O-Ring	25-26855	1
18-7174	O-Ring	25-45711	1
18-7115	O-Ring	25-26722	1

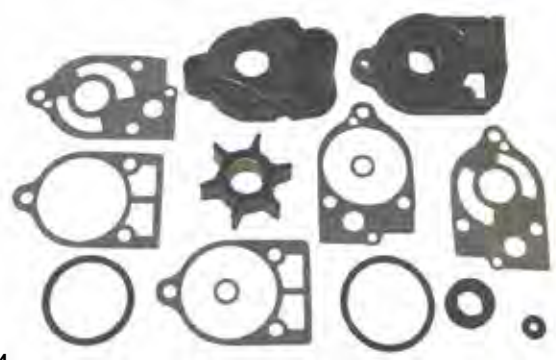

18-3324
WATER PUMP KIT
 Replaces: 46-77177A3

— CONTAINS —

Part #	Desc.	O.E. #	Qty.
18-3007	Impeller	47-89983	1
18-3118	Upper Pump Housing	46-77822A1	1
18-3424	Water Pump Base	46-77177A1	1
18-2945	Drain Gasket	12-20260, 12-19183	2
18-2823	Lower Water Pump Base to Face Plate Gasket	27-32769, 27-19553	1
18-2824	Upper Face Plate To Body Gasket	27-32770, 27-19551	1
18-2825	Water Pump Base Gasket	27-32771	1
18-2841	Water Pump Base Gasket	27-77417, 27-19552	1
18-2948	Drain Plug	12-49221-1	1
18-3107	Plate	54705	1
18-7155	O-Ring	25-26855	1
18-7174	O-Ring	25-45711	1
18-7115	O-Ring	25-26722	1



18-3571
WATER PUMP HOUSING KIT
 Replaces: 817275A1
 V-6 outboard



18-3572
WATER PUMP HOUSING KIT
 Replaces: 46-43024A3, 817275A2



18-3148
WATER PUMP REPAIR KIT
 Without Housing
 Replaces: 46-84277M, 46-84277T

— CONTAINS —

Part #	Desc.	O.E. #	Qty.
18-0768	Wear Plate Gasket	—	1
18-3074	Impeller	47-84027M	1
18-3305	Woodruff Key	28-8192M	1



18-3446
WATER PUMP KIT
 Replaces: 46-70941A3
 For: 4/4.5 HP

— CONTAINS —

Part #	Desc.	O.E. #	Qty.
18-3039	Impeller	47-89981	1
18-3139	Impeller Plate	46895	1



18-3448
WATER PUMP KIT
Replaces: 46-48744A3
For: 20 HP 1967-80

— CONTAINS —

Part #	Desc.	O.E. #	Qty.
18-3052	Impeller	47-89982	1
18-2827	Upper Face Plate Gasket	27-39623	1
18-2828	Lower Face Plate Gasket	27-39625	1
18-2829	Water Pump Base Gasket	27-39626	1



18-4531
WATER PUMP REPAIR KIT
Without Housing

Replaces: 821354A2
Fits: 25 (4-Stroke), 30 (2 Cyl.), 30 (4-Stroke), 40 (2 Cyl.), 40 (3 Cyl.), 40 (4-Stroke), 50 (3 Cyl.), 50 (4-Stroke), 50 Bigfoot (4-Stroke)

— CONTAINS —

Part #	Desc.	O.E.#	Qty.
18-1838	Seal, Short 1 3/4"	43023	1
18-1839	Seal, Long 2 1/4"	8235471	1
18-2560	Washer	12-866451	2
18-0345	Gasket, Upper Water Pump	27-822189	1
18-99155	Gasket, Lower Water Pump	27-822217	1
18-4577	Plate, Wear	8213542	1
18-3057	Impeller	47-850893	1



18-3570
WATER PUMP KIT

— CONTAINS —

Part #	Desc.	O.E. #	Qty.
NSS	Water Pump Housing	—	1
18-3056	Impeller	47-430262	1
18-2599	Face Seal & Tool	26-816575A2	1
18-3122	Impeller Plate	817276	1



18-3425
WATER PUMP KIT
Without Housing

Replaces: 84188M, 84188T

— CONTAINS —

Part #	Desc.	O.E.#	Qty.
18-0292	Wear Plate to Pump Housing Gasket	27-81417M	1
18-3435	Insert Cup	—	1
18-0294	Wear Plate to Pump Base Gasket	—	1
18-3069	Impeller	47-81423M, 47-97108M	1
18-0256	Bolt	—	2
18-3436	Impeller Plate	—	1
18-3297	Impeller Key	—	1

HP	Beg. S/N	End. S/N	HP	Beg. S/N	End. S/N
817275A2 APPLICATION					
40 (4 stroke)			817275A2 APPLICATION (Cont.)		
(4 cyl.) Bigfoot	OT228405	& UP	80 Jet	OD283222	& UP
50 (4 stroke)			90 (3 cyl.)	OA996142	& UP
935cc Big Foot	OG231123	OT178499	90 (4 stroke)	OG960500	& UP
50 (4 stroke)			100 (4 cyl.)	OB209468	& UP
996cc Big Foot	OT178500	& UP	115 (4 cyl.)	OC100000	& UP
60 (3 cyl.)			125 (4 cyl.)	OD283222	& UP
Bigfoot	OD000750	& UP	817275A1 APPLICATION		
60 (4 stroke)			45 (4 stroke)		
Bigfoot	OT178500	& UP	Bigfoot Bodensee	OG231123	& UP
65 Jet	OC283222	& UP	V-200 DFI (3.0L)	OG386496	OG589999
70 (3 cyl.)	OA996142	& UP	V-200 DFI (3.0L)	OG590000	& UP
75 (3 cyl.)	OC222000	& UP	V-225 (3.0L)		
75 (4 stroke)	OG960500	& UP	Carb & EFI	OD280813	& UP
80 (3 cyl.)	OA996142	& UP	V-225 DFI	OG590000	& UP
			V-250 (3.0L) EFI	OG129222	& UP



18-3426
WATER PUMP KIT
With Housing
Replaces: 42431M, 84829M, 97793M, 97793T

— CONTAINS —

Part #	Desc.	O.E.#	Qty.
18-3067	Impeller	47-84797M	1
18-3294	Impeller Key	28-81603M	1



18-3427
WATER PUMP KIT
With Housing
Replaces: 81242M, 95661M

— CONTAINS —

Part #	Desc.	O.E.#	Qty.
18-0773	Wear Plate Gasket	—	1
18-3067	Impeller	47-84797M	1
18-3294	Impeller Key	28-81603M	1



18-48317
COMPLETE WATER PUMP KIT
Replaces: 46-803750A03
Fits: Mercury 8-9.9 4-Stroke(209cc)(R042475 & Up)

MARINER COOLING SYSTEM APPLICATION

Mariner Models	S/N Code	S/N	Impeller	Plate	Impeller Cup	Impeller Repair Kit	Complete Kit
2A	646	All	18-3072	—	—	—	—
2B	6A1	All	18-3072	—	—	—	—
4A	6E0	All	18-3073	—	—	—	—
5C	6E3	All	18-3073	—	—	—	—
6C	6H8	All	18-3066	—	—	—	—
6D	6H6	All	18-3066	—	—	—	—
8A(M)	655	000000-000300	18-3063	—	—	—	—
8A(ML)	655	000000-300101	18-3063	—	—	—	—
8B(M)	677	000101 & Up	18-3063	—	—	—	—
8B(ML)	677	300101 & Up	18-3063	—	—	—	—
8C	6G1	All	18-3066	—	—	—	—
9.9C	682	All	18-3074	—	—	18-3148	—
15A(M)	651	000285 & Below	18-3063	—	—	—	—
15A(ML)	651	3000100 & Below	18-3063	—	—	—	—
15C	684	All	18-3074	—	—	18-3148	—
20C(M)	6A9	000101-005810	18-3067	18-3436	—	18-3426	—
20C(ML)	6A9	300101-306542	18-3067	18-3436	—	18-3426	—
20C(E)	6A9	250101-250819	18-3067	18-3436	—	18-3426	—
20C(EL)	6A9	550101-550693	18-3067	18-3436	—	18-3426	—
20C(M)	6A9	010112 & Up	18-3067	—	—	—	18-3427
20C(ML)	6A9	306543 & Up	18-3067	—	—	—	18-3427
20C(E)	6A9	250820 & Up	18-3067	—	—	—	18-3427
20C(EL)	6A9	550694 & Up	18-3067	—	—	—	18-3427
25C(M)	695	000101-014870	18-3067	18-3436	—	—	18-3426
25C(ML)	695	000000-312185	18-3067	18-3436	—	—	18-3426
25C(E)	695	000000-252290	18-3067	18-3436	—	—	18-3426
25C(EL)	695	000000-553575	18-3067	18-3436	—	—	18-3426
25C(M)	695	014871 & Up	18-3067	—	—	—	18-3427
25C(ML)	695	312186 & Up	18-3067	—	—	—	18-3427
25C(E)	695	252291 & Up	18-3067	—	—	—	18-3427
25C(EL)	695	553576 & Up	18-3067	—	—	—	18-3427
28	664	All	18-3067	—	—	—	—
30	689	All	18-3067	—	—	—	—
30A(M)	689	000366-014805	18-3067	18-3436	—	—	18-3426
30A(ML)	689	301911-315315	18-3067	18-3436	—	—	18-3426
30A(E)	689	100251-103275	18-3067	18-3436	—	—	18-3426
30A(EL)	689	401216-407815	18-3067	18-3436	—	—	18-3426
30A(M)	689	022059 & Up	18-3067	—	—	—	18-3427
30A(ML)	689	321377 & Up	18-3067	—	—	—	18-3427
30A(E)	689	105325 & Up	18-3067	—	—	—	18-3427
30A(EL)	689	411947 & Up	18-3067	—	—	—	18-3427
48/48W	670	All	18-3069	18-3436	18-3435	18-3425	—
55/W55	663	All	18-3069	18-3436	18-3435	18-3425	—
60	675,6F0	All	18-3069	18-3436	18-3435	18-3425	—

MERCURY COOLING SYSTEM APPLICATION

Horsepower	Beginning Serial #	Ending Serial #	Impeller	Impeller Plate	Insert Cup	Upper Housing	Base	Impeller Repair Kit	Thermostat	Upper Kit	Complete Kit
3.3 (with shift)	D901217	& UP	18-3098								
3.5	358136	6202172	18-3012								
3.5	6202173	& UP	18-3054								
3.6	5404657	& UP	18-3054								
3.9	14 1655013	2498135	18-3012	18-3139							
4 (1 cyl.)	2498136	4107219	18-3039	18-3139				18-3239			
4 (2 cyl.)	5589202	& UP	18-3054	—							
4 (made in USA)	5595532	A809600	18-3054	18-3139							
4 (made in USA)	5595532	& UP	18-3039	18-3139		18-3446		18-3239			18-3446
4 (1 cyl.)	A809601	& UP	18-3098							—	
4.5	4107220	5595531	18-3039	18-3139				18-3239			18-3446
4.5	5595532	& UP	18-3054	18-3139							
4.5	5595532	& UP	18-3039	18-3139				18-3239			18-3446
5	574128	786612	18-3012								
5 (1 cyl.)	A809601	& UP	18-3098								
5 4-STROKE	R000001	& UP	18-3098								
6	888005	1916138	18-3012								
6	1916139	2193817	18-3039	18-3139				18-3239			
6	A197112	OT800749	18-3062								
6	1582403	1916138	18-3039								
6	1916139	2193817	18-3039								
6	2193818	2529894	18-3039								
6	2385673	2387383	18-3039								
7.5	2529895	4131609	18-3039	18-3139							
7.5	4131610	5226934	18-3039	18-3139				18-3239			18-3446
7.5	5206550	& UP	18-3054								
7.5	5206550	& UP	18-3039	18-3139				18-3239			18-3446

1 Models with aluminum upper pump housings
 2 Models with aluminum water pumps
 3 Models with plastic upper pump housings
 4 Models with plastic water pumps
 5 Pump screws without insulators
 6 Pump screws with insulators
 7 Models with driveshaft retaining nut
 8 Models without driveshaft retaining nut
 9 Models with flush hole
 10 Models without flush hole
 11 Models having plastic upper housing use #48752 inset cup
 12 Units already having a complete pump replacement using 46-46893A 6 should use the 2193818-2529894 serial group for components
 13 Units already having a complete pump replacement using 46-46893A 6 should use USA 3795658-4126549 serial group for components
 14 Units which have already had a complete pump replacement with the 46-46893A 6 pump should use the "Early Mariner Impellers" chart for components

MERCURY COOLING SYSTEM APPLICATION

Horsepower	Beginning Serial #	Ending Serial #	Impeller	Impeller Plate	Insert Cup	Upper Housing	Base	Impeller Repair Kit	Thermostat	Upper Kit	Complete Kit
8	A197112	& UP	18-3062								
8 (4-stroke Bodensee)	G760300	& UP	18-3062								
110 (9.8)	1865779	2196388	18-3039								
110 (9.8)	2196389	3795657	18-3039								
110 (9.8)	3795658	4126459	18-3039								
110 (9.8) 3	4126460	5206549	18-3039	18-3139				18-3239			
110	5206550	& UP	18-3054								—
9.8	5206550	& UP	18-3039	18-3139				18-3239	18-3553		18-3446
9.9	A197112	& UP	18-3062								
9.9 (4 Stroke) STANDARD CASE	G760300	T979999	18-3062								
XR10 SeaPro	D038000	& UP	18-3062						18-3549		
10	500022	1057993	18-3008								
15	B292414	& UP	18-3062						18-3549		
15 SeaPro	G044365	& UP	18-3062								
16	700000	& UP	18-3008								
18	5837437	& UP	18-3057								
20	860970	1292909	18-3008								
20	2827677	6443972	18-3052					18-3252			18-3448
20	6443973	T800749	18-3057					18-3215			
22	1158546	1238089	18-3008								
25,25XD,25 Sea Pro	5705532	& UP	18-3057					18-3215			
25 (3 cyl.)	E268781	& UP	18-3057					18-3215			
30	950250	1260724	18-3008					—			
30	1271884	1448139	18-3007	18-3107				18-3207		18-3507	—
30 Jet	C159200	G589999	18-3007	18-3107	18-3115	18-3118	18-3424	18-3207		18-3507	18-3324
30 Jet	G590000	& UP	18-3057								
30 (2 cyl)	G053314	T598999	18-3057								
35	1217222	1448139	18-3007	—			—	—		—	—
35	1571114	1960826	18-3007	18-3107				18-3207		18-3507	—
35	1960827	2453068	18-3007	18-3107				18-3207		18-3507	—
35	6445653	& UP	18-3007	18-3107	18-3115	18-3118	18-3424	18-3207		18-3507	18-3324
40	941751	1224480	18-3008	—	—	—	—	—		—	—
40	1224481	1476509	18-3007	—	—	—	—	—		—	—
40	2874704	4362214	18-3007	18-3107	18-3115	18-3118	18-3422	18-3207		18-3507	18-3322
40 (2 cyl) thru 1983	4860103	& UP	18-3057	18-3107	18-3115	18-3118	18-3424	18-3207		18-3507	18-3324
40 (3 cyl)	G531301	& UP	18-3057	—	—	—	—	—		18-3507	—
40 (4 cyl)	C159200	& UP	18-3007	18-3107	18-3115	18-3118	18-3424	18-3207			
40 (4-stroke) 2:1 ratio	G760300	T408999	18-3057								
40 (EFI 4-stroke) 1.83:1 ratio	T409000	& UP	18-8900				18-3445				
40 (EFI 4-stroke) 2.31:1 ratio	T409000	B344398	18-3056					18-3214			
40 (4-stroke, 4 cyl.) 2.31:1 ratio	T228405	T598999	18-3056					18-3214			
40 (4-stroke,Std)	G231123	T178499	18-3057								
40 4-stroke Carb BIG FOOT	C033811	& UP	18-3056								
40	1279685	1476509	18-3007							18-3507	
45	5531630	& UP	18-3007	18-3107	18-3115	18-3118	18-3424	18-3207			
45 Jet (3 cyl)	D000750	& UP	18-8900								
45 (4-stroke, std) Bodensee	G231123	& UP	18-3057								
45 (4-stroke, bigfoot) Bodensee	G231123	& UP	18-3056					18-3214			
50	1421113	1460498	18-3007							18-3507	
50	1477910	1521913	18-3007								
50	1521914	2305100	18-3007	18-3107				18-3207		18-3507	
50 aluminum w/p	2305101	2478119	18-3007								
50 plastic w/p	2305101	2478119	18-3007								
500	2514919	4357639	18-3007	18-3107	18-3115	18-3118	18-3422	18-3207		18-3507	
50 (4cyl)	4357640	5531629	18-3007	18-3107	18-3115	18-3118	18-3423	18-3207		18-3507	
50 (4cyl)	5531630	& UP	18-3007			18-3118					
50 (4 cyl)	4962056	& UP	18-3007	18-3107	18-3115	18-3118	18-3424	18-3207		18-3507	
50 (3 cyl)	6428681	D000749	18-3007	18-3107	18-3115	18-3118	18-3424	18-3207			
50 (3 cyl)	D000750	G589999	18-8900				18-3445		18-3553		
50 (3 cyl)	G590000	& UP	18-3057								
50 (4-stroke,Std)	G231123	T178499	18-3057								
50 (4-stroke, 4 cyl.) STANDARD	T178500	T598999	18-8900				18-3445				
50 (4-stroke, 4 cyl.) BIG FOOT	T178500	& UP	18-3056			18-3572		18-3214			
50 (EFI 4-stroke) STANDARD	T409000	B344398	18-8900				18-3445				
50 (EFI 4-stroke) BIG FOOT	T409000	B344398	18-3056					18-3214			
55 (3 cyl)	D000750	& UP	18-8900				18-3445				
60	6428681	D000749	18-3007	18-3107	18-3115	18-3118	18-3424	18-3207			18-3324
60 (3cyl) standard	D000750	& UP	18-3056	18-3122				18-3214	18-3553		
60 Marathon	D000750	& UP	18-3056	18-3122				18-3214			
60 Big Foot	D000750	& UP	18-3056	18-3122				18-3214	18-3553		
60 (3 cyl)	D000750	& UP	18-8900						18-3553		
60 4-STROKE STANDARD	OT178500	T598999	18-8900				18-3445	18-3214			
60 4-STROKE, BIG FOOT	OT178500	T598999	18-3056					18-3214			
60 4-STROKE EFI BIG FOOT	T409000	B344398	18-3056								

- 1 Models with aluminum upper pump housings
- 2 Models with aluminum water pumps
- 3 Models with plastic upper pump housings
- 4 Models with plastic water pumps
- 5 Pump screws without insulators
- 6 Pump screws with insulators
- 7 Models with driveshaft retaining nut

- 8 Models without driveshaft retaining nut
- 9 Models with flush hole
- 10 Models without flush hole
- 11 Models having plastic upper housing use #48752 inset cup
- 12 Units already having a complete pump replacement using 46-46893A 6 should use the 2193818-2529894 serial group for components
- 13 Units already having a complete pump replacement using 46-46893A 6 should use USA 3795658-4126549 serial group for components
- 14 Units which have already had a complete pump replacement with the 46-46893A 6 pump should use the "Early Mariner Impellers" chart for components

MERCURY COOLING SYSTEM APPLICATION

Horsepower	Beginning Serial #	Ending Serial #	Impeller	Impeller Plate	Insert Cup	Upper Housing	Base	Impeller Repair Kit	Thermostat	Upper Kit	Complete Kit
65(4 cyl) aluminum w/p	1542745	280351	18-3017	18-3117	18-3114			18-3217		18-3507	
65 (4cyl) plastic w/p	1542745	280351	18-3017			18-3116					
65 (4cyl)	2803562	2874263	18-3017			18-3116					
65 (4cyl)	2997439	3293183	18-3017			18-3116					
65(3 cyl)	3293184	4382056	18-3007	18-3107	18-3115	18-3118	18-3422	18-3207		18-3507	
65(3 cyl)	4382057	4571651	18-3007	18-3107	18-3115	18-3118	18-3424	18-3207			
65 Jet	0D283222	& UP	18-3056	18-3122				18-3214			
70	1413611	1436114	18-3017	18-3117				18-3217		18-3507	
70 (6cyl)	1482212	1503458	18-3017								
700 E-2 (6cyl)	1503459	1503958	18-3017								
700 EL-2 (6cyl)	1503459	1566239	18-3017								
700 E-2 (6cyl) 11	1503959	1566239	18-3017			18-3116					
700 EL-2 (6cyl) 11	1505111	1566239	18-3017			18-3116					
70 (3 cyl)	4571652	4977156	18-3007	18-3107	18-3115	18-3118	18-3423	18-3207	18-3553	18-3507	
70	4977157	6428680	18-3007	18-3107	18-3115	18-3118	18-3424	18-3207			—
70	B110054	& UP	18-3056					18-3214			18-3517
70 (3cyl) 6	A996142	C221999	18-3056			18-3572			18-3553		
70 (3cyl) 5	A996142	C221999	18-3056			18-3572			18-3553		
75 (4 cyl)	6432901	& UP	18-3017	18-3117	18-3114	18-3116	18-3414	18-3217			
75 (3 cyl)	A996142	C221999	18-3056					18-3214	18-3553		
75 (3 cyl)	C222000	& UP	18-3056					18-3214	18-3569		
75 (3 cyl)	C222000	& UP	18-3056	18-3122				18-3214	18-3569		
75 (3cyl) Optimax	T980000	& UP	18-3056			18-3572					
75 4-STROKE	G960500	B366822	18-3056					18-3214			
75 4-STROKE	B366823	& UP	18-3056			18-3572					
80	1355468	3493912	18-3017	18-3117				18-3217			18-3517
80 (6cyl)	1335465	1398629	18-3017								
80 (4 cyl)	4831999	6432900	18-3017	18-3117	18-3114	18-3116	18-3414	18-3217			
80 (3 cyl) 6	A996142	C221999	18-3056					18-3214	18-3553		
80 (3 cyl) 5	A996142	C221999	18-3056			18-3572			18-3553		
80 Jet	D283222	& UP	18-3056	18-3122				18-3214			
850 E & EL (6cyl)	1460999	1567039	18-3017	18-3117				18-3217			18-3517
850 E-1, EL-1 (6cyl) 11	1566240	1766823	18-3017								
85 (4 cyl)	4590512	& UP	18-3017	18-3117	18-3114	18-3116	18-3414	18-3217			
85 XS (4cyl)	3493913	4831998	18-3017			18-3116					
850 XS (4cyl)	3493913	4831998	18-3017			18-3116					
850, 850 XS (4cyl)	3493913	4590511	18-3017			18-3116					
900 (90hp) (6 cyl) 11	1766824	1869775	18-3017	18-3117				18-3217			18-3517
90 (6 cyl)	4845301	& UP	18-3017	18-3117	18-3114	18-3116	18-3414	18-3217			
90 (3 cyl)	B110054	C221999	18-3056					18-3214			
90 (3 cyl)	A996142	& UP	18-3056					18-3214	18-3553		
90 (3 cyl)	A996142	& UP	18-3056	18-3122				18-3214	18-3553		
90 4-STROKE	G960500	B366822	18-3056			18-3572		18-3214			
90 4-STROKE	B366823	& UP	18-3056			18-3572		18-3214			
95	1869776	2318585	18-3017	18-3117				18-3217			
115 (3CYL) Optimax	T801000	& UP	18-3056			18-3572					
950 (95hp) (6 cyl) 11	1869776	2318585	18-3017								
1000(6 cyl)	1464949	1503331	18-3017	18-3117				18-3217			
1000 (6cyl)	1503332	2318585	18-3017			18-3116					
100 (4 cyl)	B209468	& UP	18-3056					18-3214	18-3553		
100 (4 cyl)	B209468	& UP	18-3056	18-3122				18-3214	18-3553		18-3517
1000 SS (6cyl) 1	2318586	2413843	18-3017			18-3116					
1000 SS (6cyl) 3	2318586	2413843	18-3017			18-3116					
1000 SS E-1 1	2484633	2836018	18-3017			18-3116					
1000 SS E-1 3	2484633	2836018	18-3017			18-3116					
1000 BP (6cyl)	2399698	3253111	18-3017			N.L.A.					
105 Jet	0D182000	& UP	18-3017	18-3117	18-3114	18-3116	18-3419	18-3217			
110 1	1870204	2314955	18-3017	18-3117				18-3217			
110 3	1870204	2314955	18-3017			18-3317					
115 (6cyl)	2836019	4112634	18-3017	18-3117				18-3217			18-3517
115 (6cyl)	4112635	4394236	18-3017								
115 (6 cyl)	4394237	& UP	18-3017	18-3117	18-3114	18-3116	18-3414	18-3217			
115 (4 cyl) 6	C100000	& UP	18-3056					18-3214	18-3569		
115 (4cyl) 5	C100000	& UP	18-3056			18-3572			18-3569		
115 (4 cyl)	B209468	& UP	18-3056	18-3122				18-3214			
115 4-STROKE	T178500	B366822	18-3056					18-3214			
115 4-STROKE	B366823	& UP	18-3056			18-3572					
115 (3cyl) Optimax	T801000	& UP	18-3056			18-3572					
115 Pro XS	B751825	& UP	18-3056			18-3572					
125 (6cyl) 2	2314956	2839368	18-3017	18-3117				18-3217			
125 (6cyl) 4	2314956	2839368	18-3017								
125 (4 cyl) 6	D283222	& UP	18-3056						18-3569		
125 (4cyl) 5	D283222	& UP	18-3056			18-3572					
125 (3cyl) Optimax	B736885	& UP	18-3056			18-3572					

1 Models with aluminum upper pump housings
 2 Models with aluminum water pumps
 3 Models with plastic upper pump housings
 4 Models with plastic water pumps
 5 Pump screws without insulators
 6 Pump screws with insulators
 7 Models with driveshaft retaining nut

8 Models without driveshaft retaining nut
 9 Models with flush hole
 10 Models without flush hole

11 Models having plastic upper housing use #48752 inset cup
 12 Units already having a complete pump replacement using 46-46893A 6 should use the 2193818-2529894 serial group for components
 13 Units already having a complete pump replacement using 46-46893A 6 should use USA 3795658-4126549 serial group for components
 14 Units which have already had a complete pump replacement with the 46-46893A 6 pump should use the "Early Mariner Impellers" chart for components

MERCURY COOLING SYSTEM APPLICATION

Horsepower	Beginning Serial #	Ending Serial #	Impeller	Impeller Plate	Insert Cup	Upper Housing	Base	Impeller Repair Kit	Thermostat	Upper Kit	Complete Kit
135	2839369	3293233	18-3017	18-3117				18-3217			18-3517
V 135	904646	& UP	18-3017	18-3117	18-3114	18-3116	18-3419	18-3217			—
135 4-STROKE VERADO	B227000	& UP	18-3056			18-3572					18-3407
140	3293234	3502805	18-3017	18-3117				18-3217			18-3517
140	4865678	& UP	18-3017	18-3117	18-3114	18-3116	18-3414	18-3217			18-3517
140 Jet	D082000	& UP	18-3017	18-3117	18-3114	18-3116	18-3419	18-3217			—
150	3502806	4121434	18-3017	18-3117				18-3217			18-3517
150 (6cyl) 9	4121435	4865677	18-3017	18-3117	18-3114	18-3116	18-3414	18-3217			18-3517
150 (6cyl) 10	4121435	4865677	18-3017				18-3414				
1500 XS (6cyl)	4868648	5327662	18-3017								
V 150	A904646	& UP	18-3017	18-3117	18-3114	18-3116	18-3419	18-3217			18-3517
V 150	A904645	& BELOW	18-3017	18-3117	18-3114	18-3116	18-3416	18-3217			18-3517
V-135 DFI	G590000	& UP	18-3017								
V-150 Carb 8	4868998	A904645	18-3017								
V-150 Carb 7	4868998	A904645	18-3017								
V-150 Carb, EFI, DFI	A904646	& UP	18-3017								
V-150XR2,4,6 - MAGNUM II, III	4868998	& UP	18-3017								
V150XR2,4,6 - MAGNUM II, III	7	4868998	& UP	18-3017							
150 4-STROKE VERADO (4cyl)	B227000	& UP	18-3056			18-3572				18-3406	18-3407
V 175	6618751	& UP	18-3017	18-3117	18-3114	18-3116	18-3419	18-3217			18-3517
V 175	4301235	6618750	18-3017	18-3117	18-3114	18-3116	18-3416	18-3217			18-3517
V-175 Carb, EFI, DFI	6618751	& UP	18-3017								
175 4-STROKE VERADO (4cyl)	B227000	& UP	18-3056			18-3572				18-3406	18-3407
V 200	6625221	& UP	18-3017	18-3117	18-3114	18-3116	18-3419	18-3217			18-3517
V-200 8	4839034	6625220	18-3017	18-3117	18-3114	18-3116	18-3416	18-3217			—
V-200 7	4839034	6625220	18-3017								
V-200 DFI (3.0L)	G386496	G589999	18-3056					18-3214			18-3517
V-200 EFI (3.0L)	T750164	B504988	18-3056								
V-200 Carb, & EFI (2.5L)	6625221	& UP	18-3017								
V-200 DFI (3.0L)	G590000	T598999	18-3056			18-3572					
V-200 DFI (3.0L)	T590000	B504988	18-3056			18-3572					
V-200 DFI (3.0L)	B504989	& UP	18-3056			18-3572					18-3407
200 4-STROKE VERADO (4cyl)	B517159	& UP	18-3056			18-3572				18-3406	18-3407
200 4-STROKE 4.8 INCH TORPEDO	T980000	& UP	18-3056			18-3572				18-3406	18-3407
V 220 LASER	B117316	& UP	18-3017	18-3117	18-3114	18-3116	18-3419	18-3217			18-3517
V-225 (2.4L) 8	5628028	& UP	18-3017								
V-225 (2.4L) 7	5628028	& UP	18-3017								
V-225 (3.0L) CARB & EFI	D280813	G760299	18-3056								
V-225 (3.0L) CARB & EFI	G760300	T408999	18-3056			18-3571					
V-225 (3.0L) EFI	T409000	B504988	18-3056			18-3571					
V-225 DFI	G590000	T598999	18-3056			18-3571					
V-225 DFI	T599000	B504988	18-3056			18-3571					
V-225 DFI	B504989	& UP	18-3056			18-3571					18-3407
V-225 Pro XS	B104549	B752546	18-3056			18-3571					
V-225 Pro XS	B752547	& UP	18-3056			18-3571					18-3407
225 4-STROKE VERADO 4.8 INCH TORPEDO	T980000	& UP	18-3056			18-3572					18-3407
V-250 (3.0L) EFI	G129222	T408999	18-3056			18-3571					
V-250 (3.0L) EFI	T409000	B504988	18-3056			18-3572					
V-250 DFI	B528615	& UP	18-3056			18-3572					18-3407
V-250 Pro XS	B426561	B752546	18-3056			18-3571					
V-250 Pro XS	B752547	& UP	18-3056			18-3572					18-3407
250 4-STROKE VERADO 4.8 INCH TORPEDO	T980000	& UP	18-3056			18-3572					18-3407
275 4-STROKE VERADO 4.8 INCH TORPEDO	T980000	& UP	18-3056			18-3572					18-3407
300 4-STROKE VERADO 4.8 INCH TORPEDO	B517434	& UP	18-3056			18-3572					18-3407
MARK 5	574128	786612	18-3012								
MARK 6, 6A	888005	& UP	18-3012								
MARK 50	ALL	& UP	18-3007								
MARK 55	831021	& UP	18-3007								
MARK 55A	1227131	& UP	18-3007								
MARK 58 E, MARK 58A (M&E)	1139538	& UP	18-3007								
9	OG129222	& UP	18-3056	18-3117	18-3114	18-3116	18-3419	18-3214			18-3517
XR4/Magnum II	ALL		18-3017					18-3217			

1 Models with aluminum upper pump housings
 2 Models with aluminum water pumps
 3 Models with plastic upper pump housings
 4 Models with plastic water pumps
 5 Pump screws without insulators
 6 Pump screws with insulators
 7 Models with driveshaft retaining nut

8 Models without driveshaft retaining nut
 9 Models with flush hole
 10 Models without flush hole
 11 Models having plastic upper housing use #48752 inset cup
 12 Units already having a complete pump replacement using 46-46893A 6 should use the 2193818-2529894 serial group for components
 13 Units already having a complete pump replacement using 46-46893A 6 should use USA 3795658-4126549 serial group for components
 14 Units which have already had a complete pump replacement with the 46-46893A 6 pump should use the "Early Mariner Impellers" chart for components

ALL PISTONS ARE SUPPLIED COMPLETE WITH PISTON RINGS, WRIST PIN AND CIRCLIPS.

MARINER (JAPANESE MODELS)

Sierra Piston Kit Contents (See Application Charts for Specific Applications)

Model / HP	Cyl.	Bore Size	Piston	OEM Part #	Piston Ring	OEM Part #
9.9 / 15	2	std	18-4135	761-7982M, 761-7982T, 761-7134M, 761-7133M, 761-7131M	18-3976	39-15320M, 39-15320T
48	2	std	18-4138	761-8484M, 761-7198M, 761-7197M, 761-7196M	—	—

MARINER PISTON RINGS - JAPANESE MODELS

.25mm O.S.	O.E. #	.25mm O.S.	O.E. #	.25mm O.S.	O.E. #	.50mm O.S.	O.E. #
18-3977	39-18939M, 39-18939T	18-3986	39-81096M	18-3992	39-83196M	18-3978	39-15322M

MARINER PISTON AND RINGS APPLICATION - JAPANESE MODELS

Model	Ser# Code	Ser #	Standard Piston	.25mm Piston	.50mm Piston	Standard Rings	.25mm Rings	.50mm Rings	Qty. Req'd
9.9	682	ALL	18-4135	—	—	18-3976	18-3977	18-3978	2
15C	684	ALL	18-4135	—	—	18-3976	18-3977	18-3978	2
30A	689	ALL	18-4138	—	—	—	—	—	2
20C, 25A	6A9	ALL	—	—	—	—	18-3986	—	2
25C	695	ALL	—	—	—	—	18-3986	—	2
28	664	ALL	—	—	—	—	18-3986	—	2
48	670	S-02441 & Up / L33132 & UP	—	—	—	—	18-3992	—	2
W48	670	M 002731 & Up / ML 314101 & Up	—	—	—	—	18-3992	—	2
60	675	E 00101-001170 / EL 30101-304180	—	—	—	—	18-3992	—	2

MERCURY / MARINER

Sierra Piston Kit Contents (See Application Charts for Specific Applications)

Model / HP	Cyl.	Bore Size	Piston	OEM Part #	Piston Ring	OEM Part #	Circlips	OEM Part #
2 RING PISTONS - HIGH DOME								
35-140	2 - 6	2.875 / Std.	—	774-9137A12	18-3918	39-817096A6	18-4294 ④	40-52035
35-140	2 - 6	2.890 / .015	—	774-9137A13	18-3919	39-817096A16	18-4294 ④	40-52035
35-140	2 - 6	2.905 / .030	18-4535	774-9137A14	18-3920	39-817096A26	18-4294 ④	40-52035
2 RING PISTONS - LOW DOME								
35-140	2 - 6	2.875 / Std.	—	774-9137A9	18-3918	39-817096A6	18-4294 ④	40-52035
35-140	2 - 6	2.890 / .015	18-4515	774-9137A10	18-3919	39-817096A16	18-4294 ④	40-52035
35-140	2 - 6	2.905 / .030	—	774-9137A11	18-3920	39-817096A26	18-4294 ④	40-52035
3 RING PISTONS - HIGH DOME								
35-140	2 - 6	2.875 / Std.	—	776-8896A3	① 18-3902	39-78816A12, 39-45155A12	18-4294 ④	40-52035
35-140	2 - 6	2.890 / .015	—	776-8897A2	18-3916	39-78811A12, 39-45204A12	18-4294 ④	40-52035
35-140	2 - 6	2.905 / .030	18-4535	776-8898A2	① 18-3917	39-88392A12, 39-88392	18-4294 ④	40-52035
3 RING PISTONS - LOW DOME								
35-140	2 - 6	2.875 / Std.	—	776-8600A9	② 18-3902	39-78816A12	18-4294 ④	40-52035
35-140	2 - 6	2.890 / .015	—	776-9095A1	② 18-3916	39-78811A12, 39-45204A12	18-4294 ④	40-52035
35-140	2 - 6	2.905 / .030	18-4156	776-9096A1	18-3917	39-88392A12, 39-88392	18-4294 ④	40-52035
2 RING PISTONS - CROSSFLOW								
40-50	4	2.565 / Std.	18-4620	780-9229A7, 743-5172A6, 743-3193A4, 743-3193A2	18-3966	39-18653A12	18-4294 ④	40-52035
40-50	4	2.580 / .015	18-4621	780-9229A10, 743-3366A2, 743-3366A1	18-3967	39-18653A1	18-4294 ④	40-52035
40-50	4	2.595 / .030	18-4622	780-9229A11, 743-7716A2	18-3968	39-18653A2	18-4294 ④	40-52035
50-60	3	2.875 / Std.	—	783-9613A1	18-4019	39-19721A6	18-4294 ④	40-52035
50-60	3	2.890 / .015	18-4017	783-9613A2, 783-9613T2	18-4020	39-19721A1	18-4294 ④	40-52035
50-60	3	2.905 / .030	18-4018	783-9613A3, 783-9613T3	18-4021	39-19721A2	18-4294 ④	40-52035
70-115	3-4	3.375 / Std.	18-4623	777-815965T4, 777-815965A4	18-3979	39-96170A12	18-4294 ④	40-52035
70-115	3-4	3.390 / .015	18-4624	777-815965A5	—	39-96170A3	18-4294 ④	40-52035
70-115	3-4	3.405 / .030	18-4625	777-815965A6	18-3981	39-96170A4	18-4294 ④	40-52035
75-125	3-4	3.500 / Std.	18-4626	2704-826191T4, 2704-826191A4, 2704-826191A6, 2704-821896A6, 2704-812896A2	18-3982	39-822321A12, 39-824905A12	18-4294 ④	40-52035
75-125	3-4	3.515 / .015	18-4627	2704-821896A3	—	39-822321A1	18-4294 ④	40-52035
75-125	3-4	3.530 / .030	18-4628	2704-821896A4	18-3984	39-822321A2	18-4294 ④	40-52035

3 RING PISTON AND RINGS APPLICATION (REFERENCE ONLY ③)

HP	Cyl.	Beginning Serial No.	Ending Serial No.	Std. Cyl. Dia. (Bore)	Std. Piston	.015 O.S. Piston	.030 O.S. Piston	Std. Rings	.015 O.S. Rings	.030 O.S. Rings
3.5	1	6202173	& UP	2	—	—	—	—	—	—

APPLICATION CONTINUED ON NEXT PAGE

① 3 ring high dome NLA, 2 ring piston are now substituted ② 3 ring low dome NLA, 2 ring piston are now substituted

③ Chart is for referencing only, pistons received will be 2 ring version

④ This product is priced per piece. To order priced per package, please add -9 to the part number.

3 RING PISTON AND RINGS APPLICATION (REFERENCE ONLY ③)

HP	Cyl.	Beginning Serial No.	Ending Serial No.	Std. Cyl. Dia. (Bore)	Std. Piston	.015 O.S. Piston	.030 O.S. Piston	Std. Rings	.015 O.S. Rings	.030 O.S. Rings
3.6	1	5404657	& UP	2	—	—	—	—	—	—
3.9	1	1655013	2498135	2	—	—	—	—	—	—
4 (1CYL)	1	2498136	A809600	2	—	—	—	—	—	—
4.5	1	4107220	& UP	2	—	—	—	—	—	—
7.5	2	2529895	& UP	2	—	—	—	—	—	—
9.8	2	1470349	& UP	2	—	—	—	—	—	—
20	2	1922910	5942040	2.562	—	—	—	—	—	—
25	2	1467499	149931	2.562	—	—	—	—	—	—
30 Jet (40 HP)	4	0C159200	& UP	2.562	18-4620	18-4621	18-4622	18-3966	18-3967	18-3968
30 Jet (40 HP)		0C159200	& UP	2.562	18-4620	18-4621	18-4622	18-3966	18-3967	18-3968
35	2	6445653	& UP	2.875	—	—	18-4535	18-3918	18-3916	18-3920
40 (4 cyl)	4	1279085	1476509	2.562	—	—	—	—	—	—
40	2	2045260	C159199	2.875	—	—	18-4535	18-3918	18-3916	18-3920
40, 402	2	3336258	6445652	2.875	—	—	18-4535	18-3918	18-3916	18-3920
40	4	0C159200	& UP	2.562	18-4620	18-4621	18-4622	18-3966	18-3967	18-3968
45	4	1476510	& UP	2.562	18-4620	18-4621	18-4622	18-3966	18-3967	18-3968
45	4	5531630	0B110788	2.562	18-4620	18-4621	18-4622	18-3966	18-3967	18-3968
45	4	0B110789	& UP	2.562	18-4620	18-4621	18-4622	18-3966	18-3967	18-3968
45 JET	3	D000750	G589999	2.955	—	18-4017	18-4018	18-4019	18-4020	18-4021
50,500	4	2116318	6428680	2.562	18-4620	18-4621	18-4622	18-3966	18-3967	18-3968
50	3	6428681	B122929	2.875	18-4500	18-4515	—	18-3918	18-3916	18-3920
50	3	B122930	D000749	2.875	18-4500	—	—	18-3918	18-3916	18-3920
50	3	D000750	G589999	2.955	—	18-4017	18-4018	18-4019	18-4020	18-4021
55	3	6428681	B122929	2.875	18-4500	18-4515	—	18-3918	18-3916	18-3920
55	3	B122930	D000749	2.875	18-4500	18-4515	—	18-3918	18-3916	18-3920
55	3	D000750	G589999	2.955	—	18-4017	18-4018	18-4019	—	18-4021
60	6	1303411	1542744	2.562	—	—	—	—	18-4020	—
60	3	6428681	B122929	2.875	—	—	18-4535	18-3918	18-3916	18-3920
60	3	B122930	D000749	2.875	—	—	18-4535	18-3918	18-3916	18-3920
60	3	D000750	G589999	2.955	—	18-4017	18-4018	18-4019	18-4020	18-4021
65,650	3	3293184	4382056	2.875	—	—	18-4535	18-3918	18-3916	18-3920
65,650	3	4382057	4571651	2.875	—	—	18-4535	18-3918	18-3916	18-3920
70	3	4571652	A996141	2.875	—	—	18-4535	18-3918	18-3916	18-3920
70 (3 cyl.) w/Rod #646-8188461	3	A996142	& UP	3.375	18-4623	18-4624	18-4625	18-3979	—	—
75	4	6432901	& UP	2.875	—	—	18-4535	18-3918	18-3916	18-3920
75 (3 cyl.) w/Rod #646-818846	3	C222000	D283221	3.375	18-4623	18-4624	18-4625	18-3979	—	18-3981
75 (3 cyl.)	3	D283222	& UP	3.5	18-4626	18-4627	18-4628	18-3982	—	—
80,800	4	2559001	3493912	2.875	—	—	18-4535	18-3918	18-3916	18-3920
80,800	4	4831999	6432900	2.875	—	—	18-4535	18-3918	18-3916	18-3920
80 Jet	3	D283222	& UP	3.5	18-4626	18-4627	18-4628	18-3982	—	—
85,850	4	3493913	4831998	2.875	—	—	18-4535	18-3918	18-3916	18-3920
85,850	4	4366802	4831998	2.875	—	—	18-4535	18-3918	18-3916	18-3920
85 Mar.	4	4731898	4842728	2.875	—	—	18-4535	18-3918	18-3916	18-3920
90,900	6	4845301	& UP	2.875	—	—	18-4535	18-3918	18-3916	18-3920
90 (3 cyl.) w/Rod #646-818846	3	A996142	D283221	3.375	18-4623	18-4624	18-4625	18-3979	—	18-3981
90 (3 cyl.)	3	D283222	& UP	3.5	18-4626	18-4627	18-4628	18-3982	—	—
95	6	1869776	2318585	2.875	—	—	—	18-3918	18-3916	18-3920
100 SS	6	2318586	2836018	2.875	—	—	—	18-3918	18-3916	18-3920
100 BP	6	2399698	3253111	2.875	—	—	—	18-3918	18-3916	18-3920
100 (4 cyl.) w/Rod #646-818846	4	B209468	D283221	3.375	18-4623	18-4624	18-4625	18-3979	—	18-3981
100 (4cyl)	4	D283222	& UP	3.5	18-4626	18-4627	18-4628	18-3982	—	—
115 1150	6	2836019	5829643	2.875	—	—	18-4535	18-3918	18-3916	18-3920
115 Merc.	6	5829644	B209467	2.875	18-4500	18-4515	—	18-3918	18-3916	18-3920
115 Mar.	6	5738891	5861526	2.875	—	—	18-4535	18-3918	18-3916	18-3920
115 Mar.	6	5861527	C100000	2.875	18-4500	18-4515	—	18-3918	18-3916	18-3920

APPLICATION CONTINUED ON NEXT PAGE

3 RING PISTON AND RINGS APPLICATION (REFERENCE ONLY ③)										
HP	Cyl.	Beginning Serial No.	Ending Serial No.	Std. Cyl. Dia. (Bore)	Std. Piston	.015 O.S. Piston	.030 O.S. Piston	Std. Rings	.015 O.S. Rings	.030 O.S. Rings
115 (4 cyl) w/Rod #646-818846	4	C100000	D283221	3.375	18-4623	18-4624	18-4625	18-3979	—	18-3981
115 (4cyl)	4	D283222	& UP	3.5	18-4626	18-4627	18-4628	18-3982	—	—
125 BP	6	2641855	3253111	2.875	—	—	18-4535	18-3918	18-3916	18-3920
135	6	2839369	3293233	2.875	—	—	18-4535	18-3918	18-3916	18-3920
140 1400	6	3293234	3502805	2.875	—	—	18-4535	18-3918	18-3916	18-3920
140 1400	6	4865678	& UP	2.875	18-4500	18-4515	—	18-3918	18-3916	18-3920
150 1500	6	3502806	5327622	2.875	18-4500	18-4515	—	18-3918	18-3916	18-3920

③ Chart is for referencing only, pistons received will be 2 ring version

2 RING INLINE PISTON & RINGS APPLICATION													
HP	Cyl.	Beginning Serial No.	Ending Serial No.	Dia. (Bore)	Pistons		Port		Port		Piston Rings		
					Std. (Port)	Stbd.	.015" O.S.	Stbd.	.030 O.S.	Stbd.	Std.	.015" O.S.	.030 O.S.
105 JET	V-6	D082000	& UP	3.125	—	—	—	18-4013	18-4014	—	18-3921	18-3922	18-3923
V-135	V-6	A904646	C239552	3.125	—	—	—	18-4560	—	18-4575	18-3921	18-3922	18-3923
V-135 (w/ rod 644-8141)	V-6	C239553	G960499	3.125	—	—	—	18-4013	18-4014	—	18-3921	18-3922	18-3923
V-135 (2.5L) (w/o rod 636-8141)	V-6	C239553	G960499	3.125	—	—	—	18-4560	—	18-4575	18-3921	18-3922	18-3923
V-140 JET	V-6	D082000	G960499	3.5	18-4635	18-4636	18-4637	18-4638	NA	NA	18-3982	—	18-3984
V-140 JET	V-6	G960500	UP	3.5	18-4635	18-4636	18-4637	18-4638	NA	NA	18-3982	—	18-3984
V-150 MAR	V-6	5600162	6038680	3.125	—	—	—	18-4560	—	18-4575	18-3921	18-3922	18-3923
V-150 MAR	V-6	6038681	C239552	3.125	—	—	—	18-4560	—	18-4575	18-3921	18-3922	18-3923
V-150, 150,1500	V-6	4868998	6042945	3.125	—	—	—	18-4560	—	18-4575	18-3921	18-3922	18-3923
V-150	V-6	6042946	C239552	3.125	—	—	—	18-4560	—	18-4575	18-3921	18-3922	18-3923
V-150 (w/ rod 644-8141)	V-6	C239553	G960499	3.125	—	—	—	18-4013	18-4014	—	18-3921	18-3922	18-3923
V-150 (2.5L) (w/o rod 636-8141)	V-6	C239553	G960499	3.125	—	—	—	18-4560	—	18-4575	18-3921	18-3922	18-3923
V-150 EFI XR6 MAGIII	V-6	D082000	G960499	3.5	18-4635	18-4636	18-4637	18-4638	NA	NA	18-3982	—	—
V-150 XR4 MAGIII	V-6	B242885	C239552	3.375	—	—	18-4565	18-4570	—	—	18-3924	18-3925	—
V-150 XR4 MAGIII	V-6	C239553	D081999	3.375	—	—	18-4565	—	—	—	18-3924	18-3925	—
V-175,175, 1750	V-6	4301235	6618750	3.125	—	—	—	18-4560	—	18-4575	18-3921	18-3922	18-3923
V-175	V-6	6618751	C239552	3.375	—	—	—	—	—	—	18-3927 ④	—	—
V-175	V-6	C239553	D081999	3.375	—	—	18-4565	—	—	—	18-3924	18-3925	—
V-175	V-6	D082000	G960499	3.5	18-4635	18-4636	18-4637	18-4638	NA	NA	18-3982	—	18-3984
V-175	V-6	G960500	& UP	3.5	18-4635	18-4636	18-4637	18-4638	NA	NA	18-3982	—	18-3984
V-175 I XRI EF	V-6	D000750	D081999	3.5	18-4635	18-4636	18-4637	18-4638	NA	NA	18-3982	—	18-3984
V-175	V-6	D000750	D081999	3.5	18-4635	18-4636	18-4637	18-4638	NA	NA	18-3982	—	18-3984
V-175 XRI EFI	V-6	D082000	G303045	3.5	18-4635	18-4636	18-4637	18-4638	NA	NA	18-3982	—	18-3984
V-175 XRI EFI	V-6	G303046	& UP	3.5	18-4635	18-4636	18-4637	18-4638	NA	NA	18-3982	—	18-3984
V-200, 2,002,000	V-6	4839034	6203990	3.375	—	—	—	—	—	—	18-3927 ④	—	—
V-200 (2.4L)	V-6	6203991	C291519	3.375	—	—	—	—	—	—	18-3927 ④	—	—
V-200 (2.5L) (w/ rod #644-818141)	V-6	C291520	D081999	3.5	18-4635	18-4636	18-4637	18-4638	NA	NA	18-3982	—	18-3984
V-200 (2.5L)	V-6	D082000	& UP	3.5	18-4635	18-4636	18-4637	18-4638	NA	NA	18-3982	—	18-3984
V-200 XRI EFI	V-6	C100861	C291519	3.375	—	—	—	—	—	—	18-3927 ④	—	—
V-200 XRI EFI	V-6	C291520	G960499	3.5	18-4635	18-4636	18-4637	18-4638	NA	NA	18-3982	—	18-3984
V-220	V-6	B117316	UP	3.375	—	—	—	—	—	—	18-3927 ④	—	—
V-225	V-6	5628028	D280812	3.375	—	—	—	—	—	—	18-3927 ④	—	—
V-225 (3.0L)	V-6	D280813	UP	3.625	18-4639	18-4640	18-4641	18-4642	—	18-4644	18-4050	18-4051	18-4052

SIERRA V-6 PISTON KIT CONTENTS (SEE APPLICATION CHARTS FOR SPECIFIC APPLICATIONS)

Model / HP	Cyl.	Bore Size	Piston	OEM Part #	Piston Ring	OEM Part #	Wrist Pin	Circlips
135, 150 2 Liter	V-6	3.125 / Std. (port)	—	765-7442T32	18-3921	39-93481A12	18-4287	N.S.S.
135, 150 2 Liter	V-6	3.125 / Std. (stbd)	—	765-7441T32	18-3921	39-93481A12	18-4287	N.S.S.
135, 150 2 Liter	V-6	3.140 / .015 (port)	—	765-7444A11	18-3922	39-78918A4	18-4287	N.S.S.
135, 150 2 Liter	V-6	3.140 / .015 (stbd)	18-4013	765-7443A11	18-3922	39-78918A4	18-4287	N.S.S.
135, 150 2 Liter	V-6	3.155 / .030 (port)	18-4014	765-7446A11	18-3923	39-85636A4	18-4287	N.S.S.

- | | | | |
|---------------------------------|----------------------------------|---------------------------------|----------------------------------|
| 4 of — = 1 of 39-21665A12 | 3 of 18-3919 = 1 of 39-817096A16 | 6 of 18-3924 = 1 of 39-18487A12 | 3 of 18-4019 = 1 of 39-19721A6 |
| 4 of 18-3902 = 1 of 39-78816A12 | 3 of 18-3920 = 1 of 39-817096A26 | 2 of 18-3925 = 1 of 39-815267A4 | 6 of 18-3982 = 1 of 39-822321A12 |
| 4 of 18-3916 = 1 of 39-78811A12 | 6 of 18-3921 = 1 of 39-93481A12 | 6 of 18-3966 = 1 of 39-18653A12 | 6 of 18-4050 = 1 of 39-827179A12 |
| 4 of 18-3917 = 1 of 39-88392A12 | 2 of 18-3922 = 1 of 39-78918A4 | 6 of 18-3968 = 1 of 39-18653A2 | 6 of 18-3927 = 1 of 39-813011A12 |
| 3 of 18-3918 = 1 of 39-817096A6 | 2 of 18-3923 = 1 of 39-85636A4 | 6 of 18-3967 = 1 of 39-18653A1 | |

APPLICATION CONTINUED ON NEXT PAGE

SIERRA V-6 PISTON KIT CONTENTS (SEE APPLICATION CHARTS FOR SPECIFIC APPLICATIONS)

Model / HP	Cyl.	Bore Size	Piston	OEM Part #	Piston Ring	OEM Part #	Wrist Pin	Circlips
135, 150 2 Liter	V-6	3.155 / .030 (stbd)	—	765-7445T11	18-3923	39-85636A4	18-4287	N.S.S.
135-175	V-6	3.125 / Std. (port)	—	765-7442A3, A36	18-3921	39-93481A12	18-4287	N.S.S.
135-175	V-6	3.125 / Std. (stbd)	18-4545	765-7441A3, A36	18-3921	39-93481A12	18-4287	N.S.S.
135-175	V-6	3.140 / .015 (port)	—	765-7442A2, A12	18-3922	39-78918A4	18-4287	N.S.S.
135-175	V-6	3.140 / .015 (stbd)	18-4560	765-7443A2, A12	18-3922	39-78918A4	18-4287	N.S.S.
135-175	V-6	3.155 / .030 (port)	—	N/A	18-3923 ④	39-85636A4	18-4287	N.S.S.
135-175	V-6	3.155 / .030 (stbd)	18-4575	N/A	18-3923 ④	39-85636A4	18-4287	N.S.S.
175-225	V-6	3.375 / Std. (port)	—	766-8667A41/ T41	18-3927 ④	39-813011A12	18-4287	N.S.S.
175-225	V-6	3.375 / Std. (stbd)	—	766-8666A41/ T41	18-3927 ④	39-813011A12	18-4287	N.S.S.
175-225	V-6	3.390 / .015 (port)	—	766-8667A36/ A43	18-3925	39-815267A4	18-4287	N.S.S.
175-225	V-6	3.390 / .015 (stbd)	—	766-8666A36/ A43	18-3925	39-815267A4	18-4287	N.S.S.
175-225	V-6	3.405 / .030 (port)	—	NLA	—	NLA	18-4287	N.S.S.
150 XR4/MAG II	V-6	3.375 / Std. (port)	—	766-8667A42/ T42	18-3924	39-18487A12	18-4287	N.S.S.
150 XR4/MAG II	V-6	3.375 / Std. (stbd)	—	766-8666A42/ T42	18-3924	39-18487A12	18-4287	N.S.S.
150 XR4/MAG II	V-6	3.390 / .015 (port)	18-4565	766-8667A36/ A43	18-3925	39-815267A4	18-4287	N.S.S.
150 XR4/MAG II	V-6	3.390 / .015 (stbd)	—	766-8666A36/ A43	18-3925	39-815267A4	18-4287	N.S.S.
150 XR4/MAG II	V-6	3.405 / .030 (port)	18-4580	NLA	—	NLA	18-4287	N.S.S.
140-200, XR6/MAG III	V-6	3.500 / Std. (port)	18-4635	785-9737T9	18-3982	39-822321A12	18-4287	N.S.S.
140-200, XR6/MAG III	V-6	3.500 / Std. (stbd)	18-4636	785-9738T9	18-3982	39-822321A12	18-4287	N.S.S.
140-200, XR6/MAG III	V-6	3.515 / .015 (port)	18-4637	785-9737A10	—	39-822321A1	18-4287	N.S.S.
140-200, XR6/MAG III	V-6	3.515 / .015 (stbd)	18-4638	785-9738T10	—	39-822321A1	18-4287	N.S.S.
225 (3.0L)	V-6	3.6265 / Std. (port)	18-4639	700-858294T1	18-4050	39-827179A12	18-4287	N.S.S.
225 (3.0L)	V-6	3.6265 / Std. (stbd)	18-4640	700-858295T1	18-4050	39-827179A12	18-4287	N.S.S.
225 (3.0L)	V-6	3.6415 / .015 (port)	18-4641	700-878571A2	18-4051	39-826293A12	18-4287	N.S.S.
225 (3.0L)	V-6	3.6415 / .015 (stbd)	18-4642	700-878572A2	18-4051	39-826293A12	18-4287	N.S.S.
225 (3.0L)	V-6	3.6565 / .030 (port)	18-4643	700-878573A2	18-4052	39-826297A12	18-4287	N.S.S.
225 (3.0L)	V-6	3.6565 / .030 (stbd)	18-4644	700-878574A2	18-4052	39-826297A12	18-4287	N.S.S.

4 of — = 1 of 39-21665A12
 4 of 18-3902 = 1 of 39-78816A12
 4 of 18-3916 = 1 of 39-78811A12
 4 of 18-3917 = 1 of 39-88392A12
 3 of 18-3918 = 1 of 39-817096A6

3 of 18-3919 = 1 of 39-817096A16
 3 of 18-3920 = 1 of 39-817096A26
 6 of 18-3921 = 1 of 39-93481A12
 2 of 18-3922 = 1 of 39-78918A4
 2 of 18-3923 = 1 of 39-85636A4

6 of 18-3924 = 1 of 39-18487A12
 2 of 18-3925 = 1 of 39-815267A4
 6 of 18-3966 = 1 of 39-18653A12
 6 of 18-3968 = 1 of 39-18653A2
 6 of 18-3967 = 1 of 39-18653A1

3 of 18-4019 = 1 of 39-19721A6
 6 of 18-3982 = 1 of 39-822321A12
 6 of 18-4050 = 1 of 39-827179A12
 6 of 18-3927 = 1 of 39-813011A12

④ For chrome bore blocks

<p>PKG. OF 200</p>  <p>NEEDLE BEARINGS</p> <table border="1"> <thead> <tr> <th>Part #</th> <th>Replaces:</th> <th>Description</th> </tr> </thead> <tbody> <tr> <td>18-4036 ①</td> <td>29-47270</td> <td>Piston End</td> </tr> <tr> <td>18-4037 ①</td> <td>29-71422</td> <td>Main Bearing</td> </tr> </tbody> </table>	Part #	Replaces:	Description	18-4036 ①	29-47270	Piston End	18-4037 ①	29-71422	Main Bearing	<p>NEEDLE BEARINGS</p>  <table border="1"> <thead> <tr> <th>Part #</th> <th>Replaces</th> <th>Description</th> </tr> </thead> <tbody> <tr> <td>18-4038</td> <td>31-62596A1, 31-63075A1, 31-61424A2, 31-58859A1, 31-55332A1, 31-47245A1</td> <td>Crank End - w/o Cage</td> </tr> <tr> <td>18-4039</td> <td>31-17514A2, 31-8M0045430</td> <td>Crank End - w/o Cage</td> </tr> </tbody> </table> <p>16 Needles - Must re-use cage</p>	Part #	Replaces	Description	18-4038	31-62596A1, 31-63075A1, 31-61424A2, 31-58859A1, 31-55332A1, 31-47245A1	Crank End - w/o Cage	18-4039	31-17514A2, 31-8M0045430	Crank End - w/o Cage	 <p>18-1186 NEEDLE BEARINGS WITH RETAINERS Replaces: 29-88258 + 12-88263 (2 pieces) For: Merc V-6 200/225/250 HP 3.0 & 3.4L</p>
Part #	Replaces:	Description																		
18-4036 ①	29-47270	Piston End																		
18-4037 ①	29-71422	Main Bearing																		
Part #	Replaces	Description																		
18-4038	31-62596A1, 31-63075A1, 31-61424A2, 31-58859A1, 31-55332A1, 31-47245A1	Crank End - w/o Cage																		
18-4039	31-17514A2, 31-8M0045430	Crank End - w/o Cage																		
 <p>18-1194 ROD BEARING Replaces: 31-17514A1, 8M004528, 31-17514A2, 31-8M0045428, 31-17514, 31-67526A1, 31-67526A2, 31-67526, 31-821146A1, 31-814337A1, 879366 For: 30-60HP 2&3 Cyl., Mag II, V-135-200 & XR4</p>	 <p>18-1195 ROD BEARING Replaces: 31-43012A1 For: 70, 75, 80, 90, 100, 115, L3, L4, 3.0L</p>	 <p>18-1153 BALL BEARING Replaces: 30-63326, 30-63326T, 30-49313, 30-54215, 30-20464</p>																		
 <p>18-1154 BALL BEARING Replaces: 30-63742</p>	 <p>18-1196 UPPER MAIN BEARING Replaces: 31-74248T, 31-74248 For: V135, 150, 175, 200 (carb)</p>	 <p>18-1345 BALL BEARING Replaces: 30-67923T, 30-67923, 30-41421 For: 135-225 HP V-6</p>																		

① This product is priced per piece. To order priced per package, please add -9 to the part number.

18-1346
BALL BEARING

Replaces: 30-43011T, 30-43011
For: 75-125 3 & 4 cyl.



18-1398
BALL BEARING

Replaces: 30-72961, 30-20861
For: 3.5-9.8 HP & Mercruiser
belt driven water pump



HP	Cyl.	Beg. S/N	End S/N	Center Main Bearing	Con. Rod Crank End	Main Valve Block	Con. Rod Piston End	Lower Main Bearing	Lower O-ring	Lower Oil Seal	Lower Oil Seal 2	Upper O-ring	Upper Main Bearing	Upper Oil Seal	Upper Roller Bearing
3.5		6202173	& UP	—	—	—	—	—	—	—	—	18-7152	18-1398	—	—
3.6		5404657	& UP	—	—	—	—	18-1398	—	—	—	18-7152	18-1398	—	—
3.9	1	1655013	2498135	—	—	—	—	18-1398	—	—	—	18-7152	18-1398	—	—
4 (40)	1	2498136	4107219	—	—	—	—	18-1398	—	—	—	18-7152	18-1398	—	—
4	1	5595532	& UP	—	—	—	—	18-1398	—	—	—	18-7152	18-1398	—	—
4 (40)	2	5589202	& UP	—	—	—	—	18-1398	18-7102	—	—	—	—	18-0515	—
4.5 (4.5, 45)	1	4107220	& UP	—	—	—	—	18-1398	—	—	—	18-7152	18-1398	—	—
4.5	1	5595532	& UP	—	—	—	—	18-1398	—	—	—	18-7152	18-1398	—	—
6 (60)		1916139	2529894	—	—	—	—	18-1398	—	—	—	18-7459	18-1398	—	—
6		A197112	T800749	—	—	—	—	—	—	—	—	—	—	—	—
7.5 (75)		2529895	5226934	—	—	—	—	18-1398	—	—	—	18-7152	18-1398	—	—
10 (100)		1290910	& UP	—	—	—	—	—	—	—	—	—	—	—	—
10 (MARATHON, XR10, SEAPRO)		D038000	& UP	—	—	—	—	—	—	—	—	—	—	—	—
15 (150)		1290910	1499331	—	—	—	—	—	—	18-2026	18-2026	—	—	18-1153	—
15		B292414	& UP	—	—	—	—	—	—	—	—	—	—	—	—
15 (EXPORT SEAPRO)		G044365	G202749	—	—	—	—	—	—	18-0537	—	—	—	—	—
15 (SEAPRO)		G438000	& UP	—	—	—	—	—	—	—	—	—	—	—	—
15 (SUPER)		B238464	G202749	—	—	—	—	—	—	18-0537	—	—	—	—	—
18		5837437	6239752	—	—	—	—	—	—	18-0537	—	—	—	—	—
20		1558310	2296266	—	—	—	—	—	—	18-2026	18-2026	—	—	18-1153	—
20 (200, 20)		2296267	& UP	—	—	—	—	—	—	—	—	—	—	—	—
25 (KF 9)	4	377150	495761	—	—	—	—	—	—	—	—	—	—	—	—
10 (MK10)	2	1057994	1122327	—	—	—	—	—	—	—	—	—	—	—	—
15 (MK15)	2	1200114	1287384	—	—	—	—	—	—	—	—	—	—	—	—
16 (MK20)	2		ALL	—	—	—	—	—	—	—	—	—	—	—	—
20 (MK25)	2	860979	& UP	—	—	—	—	—	—	—	—	—	—	—	—
22 (MK28)	2	1158546	1238089	—	—	—	—	—	—	—	—	—	—	—	—
30 (MK30)	4		ALL	—	—	—	—	—	—	—	—	—	—	—	—
35 (MK35)	4	1217222	1271884	—	—	—	—	—	—	—	—	—	—	—	—
25 (MK40)	4	711400	& UP	—	—	—	—	—	—	—	—	—	—	—	—
40 (MK50)	4		ALL	—	—	—	—	—	—	—	—	—	—	—	—
40(MK55)	4	831021	& UP	—	—	—	—	—	—	—	—	—	—	—	—
45 (MK58)	4	1139538	& UP	—	—	—	—	—	—	—	—	—	—	—	—
60 (MK75)	6		ALL	18-4037	—	—	—	—	—	—	—	—	—	—	—
70 (MK78)	6	1143038	& UP	18-4037	—	—	—	—	—	—	—	—	—	—	—
3.5 / 3.6 / 3.9	1		ALL	—	—	—	—	18-1398	—	—	—	—	—	18-1398	—
9.8	2	1865779	& UP	—	—	—	—	18-1398	—	—	—	—	—	18-1398	—
20	2	1292910	6443972	—	—	—	—	18-1153	—	—	—	—	—	18-1153	—
20 (20 XD)	2	6443973	B114230	—	—	—	—	—	—	18-0537	—	—	—	—	—
25	2	1467499	1499331	—	—	—	—	—	—	—	—	—	—	—	—
25	2	5705532	6241936	—	—	—	—	—	—	18-0537	—	—	—	—	—
25 (250)		1290910	1499331	—	—	—	—	—	—	—	—	—	—	—	—
30 (300)	4	1271885	1448139	—	—	—	—	18-1154	18-7151	—	18-2016	18-7151	18-1154	—	—
30 (644cc)	2	G053314	D589999	—	18-4039	—	18-4036	18-1154	18-7176	18-2016	—	—	—	—	—
30 (644cc)	2	G590000	T598999	—	18-1194	—	18-4036	—	—	—	—	—	—	—	—
30 JET	4	C159200	& UP	18-4037	—	—	—	18-1154	—	—	—	—	18-1154	—	—

APPLICATION CONTINUED ON NEXT PAGE

HP	Cyl.	Eng. S/N	End S/N	Center Main Bearing	Con. Rod Crank End	Main Valve Block	Con. Rod Piston End	Lower Main Bearing	Lower O-ring	Lower Oil Seal	Lower Oil Seal 2	Upper O-ring	Upper Main Bearing	Upper Oil Seal	Upper Roller Bearing
30 JET	3	G590000	& UP	—	—	—	18-4036	18-1154	—	—	—	—	—	—	—
35 (350, 35A)	4	121722	1448139	—	—	—	—	18-1154	—	—	—	—	18-1154	—	—
35 (350)	2	1571114	1898815	—	—	—	—	18-1154	18-7151	—	—	—	18-1154	—	—
35	2	6445653	B110788	—	—	18-4038	—	18-4036	18-1154	—	—	—	—	—	—
40 (400E, 400M)	4	1279685	1367697	—	—	—	—	18-1154	—	—	—	—	18-1154	—	—
40 (400E, 400M)	4	1384806	1476509	—	—	—	—	—	—	—	—	—	—	—	—
40 (400)	2	2874704	3045259	—	—	18-4038	—	18-4036	18-1154	18-2016	18-2016	—	18-2016	—	—
40 (400)	2	3045260	3336257	—	—	18-4038	—	18-4036	—	—	—	—	—	—	—
40 (402)		3336258	4117709	—	—	18-4038	—	18-4036	—	—	—	—	—	—	—
40 (402, 40)		4117710	5556229	—	—	18-4038	—	18-4036	—	18-2016	18-2016	—	18-2016	—	—
40	2	5556230	6443972	—	—	18-4038	—	18-4036	—	—	—	—	—	—	—
40	2	G053314	& UP	—	—	18-1194	—	18-4036	18-1154	18-2016	—	—	—	—	—
40	3	G531301	& UP	—	—	18-1194	—	18-4036	18-1154	18-2016	—	—	—	—	—
40	4	C159200	& UP	18-4037	—	—	—	18-1154	18-7161	18-2016	—	18-7151	18-1154	—	—
45 (450)	4	1476510	1531568	—	—	—	—	18-1154	—	18-2016	18-7151	18-1154	18-1154	—	—
45	4	5531630	& UP	18-4037	—	—	—	18-1154	18-7151	18-2016	18-7151	18-1154	18-1154	—	—
45 JET		D000750	D589999	—	—	18-4039	—	18-4036	18-1154	18-7176	18-2016	—	—	—	18-2016
45 JET (59 CID)	3	G590000	& UP	—	—	18-1194	—	18-4036	18-1154	18-7176	18-2016	—	—	—	—
50 (500)	4	1421113	1755548	—	—	—	—	18-1154	18-7151	—	18-2016	18-7151	18-1154	18-2016	—
50 (500)		1770179	2305100	—	—	—	—	—	—	—	—	—	—	—	—
50 (500, 50)		2305151	5193253	—	—	—	—	—	—	—	—	—	—	—	—
50	4	5193259	5531629	18-4037	—	—	—	18-1154	—	—	—	—	18-1154	—	—
50	4	5531630	& UP	18-4037	—	—	—	—	—	—	—	—	—	—	—
50	3	6428681	D000749	18-4037	18-4038	—	18-4036	—	18-7161	18-2016	18-2016	18-7415	—	18-2016	—
50	3	D000750	G589999	—	—	18-4039	—	18-4036	18-1154	18-7176	18-2016	—	—	—	18-2016
50	3	G590000	& UP	—	—	18-1194	—	18-4036	18-1154	18-7176	18-2016	—	—	—	—
55	3	D000750	G589999	—	—	18-4039	—	18-4036	18-1154	18-7176	18-2016	—	—	—	18-2016
55	3	G590000	& UP	—	—	18-1194	—	18-4036	18-1154	18-7176	18-2016	—	—	—	—
60 (600)	4	1303411	1542744	18-4037	—	—	—	18-1154	18-7151	—	18-2016	18-7151	18-1154	18-2016	—
60	3	6428681	D000749	18-4037	18-4038	—	18-4036	—	18-7161	18-2016	18-2016	18-7415	—	18-2016	—
60	3	D000750	G589999	—	—	18-4038	—	18-4036	18-1154	18-7176	18-2016	—	—	—	18-2016
60 (59 CID)	3	G590000	& UP	—	—	18-1194	—	18-4036	18-1154	—	—	—	—	—	—
65 (650)	4	1545745	1765043	18-4037	—	—	—	18-1154	18-7151	—	18-2016	—	—	—	18-2016
65 (650)	4	1765044	2119748	18-4037	—	—	—	—	—	—	—	—	—	—	—
65 (650)	4	2119749	2309310	18-4034	—	—	—	—	—	—	—	—	—	—	—
65 (650)	4	2309311	3293183	18-4037	—	—	—	—	—	—	—	—	—	—	—
65 (650)	3	3293184	4571651	18-4037	18-4038	—	18-4036	—	18-7161	18-2016	18-2016	18-7961	—	18-2016	—
65 (650)	3	8006640	8042349	18-4037	18-4038	—	18-4036	—	—	—	—	—	—	—	—
65 (650)	3	9020074	9135824	18-4037	18-4038	—	18-4036	—	—	—	—	—	—	—	—
65 (650)	3	7013633	7087822	18-4037	18-4038	—	18-4036	—	—	—	—	—	—	—	—
65 JET		D283222	& UP	—	—	—	—	18-1346	—	18-2016	—	18-7414	—	18-0523	—
70 (700)	6	1296411	1566239	18-4037	—	—	—	18-1154	18-7151	—	18-2016	18-7151	18-1154	18-2016	—
70	3	4571652	5579016	18-4037	18-4038	—	18-4036	—	18-7161	18-2016	18-2016	18-7415	—	18-2016	—
70	3	5579017	6428680	18-4037	18-4038	—	18-4036	—	—	—	—	—	—	—	—
70 CONNECTING ROD #638-8532-1	3	A996142	C221999	—	—	—	—	18-1346	—	18-2016	—	18-7414	—	18-0523	—
75	4	6432901	& UP	18-4037	18-4038	—	18-4036	18-1154	18-7161	18-2016	18-2016	18-7961	—	18-2016	—
75 CONNECTING ROD #638-8532-1	3	C222000	& UP	—	—	—	—	18-1346	—	18-2016	—	18-7414	—	18-0523	—
75 DFI (1.5L)		T980000	B189548	—	—	—	—	18-1346	—	18-2016	—	—	—	—	—
80 (800)	6	1335465	1566239	18-4037	—	—	—	18-1154	18-7151	—	18-2016	18-7151	18-1154	18-2016	—
80 (800)	4	2559001	2670574	18-4037	18-4038	—	18-4036	18-1154	18-2016	18-2016	18-2016	18-7961	—	18-2016	—
80 (800)	4	2783253	3493912	18-4037	18-4038	—	18-4036	—	—	—	—	—	—	—	—
80 (800, 80)	4	4831999	5582561	18-4037	18-4038	—	18-4036	18-1154	18-7161	18-2016	18-2016	18-7961	—	18-2016	—

APPLICATION CONTINUED ON NEXT PAGE

HP	Cyl.	Beg. S/N	End S/N	Center Main Bearing	Con. Rod Crank End	Main Valve Block	Con. Rod Piston End	Lower Main Bearing	Lower O-ring	Lower Oil Seal	Lower Oil Seal 2	Upper O-ring	Upper Main Bearing	Upper Oil Seal	Upper Roller Bearing
80 (80)	4	5582562	6422900	18-4037	18-4038	—	18-4036	—	—	—	—	—	—	—	—
80 CONNECTING ROD #638-8532-1	3	A996142	C221999	—	—	—	—	18-1346	—	18-2016	—	18-7414	—	18-0523	—
80 JET		D283222	& UP	—	—	—	—	18-1346	—	18-2016	—	18-7414	—	18-0523	—
85 (850, 76 CID)	6	1460999	1464848	18-4037	—	—	—	18-1154	18-7151	—	18-2016	18-2016	—	18-2016	—
85 (850, 90 CID)	6	1566240	1766823	18-4037	—	—	—	18-1345	18-2016	—	18-2016	—	—	18-2016	—
85 (850)	4	3493913	3865694	18-4037	18-4038	—	18-4036	18-1154	18-7161	18-2016	18-2016	18-7961	—	18-2016	—
85 (850)	4	3865695	4831998	18-4037	18-4038	—	18-4036	—	—	—	—	—	—	—	—
90 (900)	6	1766824	1850448	18-4037	—	—	—	18-1154	18-2016	—	18-2016	—	—	18-2016	—
90 (900)	6	1850449	1869775	18-4037	—	—	—	—	—	—	—	—	—	—	—
90 (900, 90)	6	4845301	5594656	18-4037	18-4038	—	18-4036	18-1154	18-7161	18-2016	18-2016	—	—	18-2016	—
90 (90)	6	5594657	& UP	18-4037	18-4038	—	18-4036	—	—	—	—	—	—	—	—
90 (90) CONNECTING ROD #638-8532-1	3	A996142	D283221	—	—	—	—	18-1346	—	18-2016	—	18-7414	—	18-0523	—
95 (950E)	6	1869776	2318585	18-4037	—	—	—	18-1154	18-7151	—	18-2016	—	—	18-2016	—
95 (950E-SS)		1869776	2318585	18-4037	—	—	—	18-1154	18-2016	—	18-2016	—	—	18-2016	—
95 (950E-SS-1)		1869776	2318585	18-4037	—	—	—	—	—	—	—	—	—	—	—
100 (1000)	6	1464949	2318585	18-4037	—	—	—	18-1154	18-7151	—	18-2016	—	—	18-2016	—
100 (1000SS)		2318586	2836018	18-4037	—	—	—	18-1154	18-7151	—	18-2016	—	—	18-2016	—
100 (1000BP)		2399698	2641854	18-4037	—	—	—	—	—	—	—	—	—	—	—
100 (1000BP)		2641855	3253111	18-4037	18-4038	—	18-4036	18-1154	18-7151	18-2016	18-2016	18-7961	—	18-2016	—
100	4	B209468	& UP	—	—	—	—	18-1346	—	—	—	—	—	—	—
105 JET		D820000	& UP	—	18-1194	—	—	18-1345	—	—	—	—	—	—	—
110 (1100E)		1870204	2314955	18-4037	—	—	—	18-1154	18-7151	—	18-2016	—	—	18-2016	—
110 (1100-SS)	6	1870204	2314955	18-4037	—	—	—	18-1154	18-2016	—	18-2016	—	—	18-2016	—
110 (1100E-SS-1)	6	1870204	2314955	18-4037	—	—	—	—	—	—	—	—	—	—	—
115 (1150)	6	2836019	3525440	18-4037	18-4038	—	18-4036	18-1154	18-7151	18-2016	18-2016	18-7961	—	18-2016	—
115 (1150, 115)		3525441	5600966	18-4037	18-4038	—	18-4036	—	—	—	—	—	—	—	—
115	6	5600967	6262960	18-4037	18-4038	—	18-4036	—	—	—	—	—	—	—	—
115	6	6262961	C099999	18-4037	18-4038	—	18-4036	—	—	—	—	—	—	—	—
115 CONNECTING ROD #638-8532-1	4	C100000	D283221	—	—	—	—	18-1346	—	18-2016	—	18-7414	—	18-0523	—
115 OPTIMAX	6	G960500	T178499	—	18-1194	—	—	—	—	—	—	—	—	—	—
125 (1250, 1250BP)	6	2314956	2641954	18-4037	18-4038	—	18-4036	18-1154	18-2016	—	—	18-7961	—	18-2016	—
125 (1250BP)		2641955	3253111	18-4037	18-4038	—	—	—	—	—	—	—	—	—	—
125	4	D283222	& UP	—	—	—	—	18-1346	—	18-2016	—	18-7414	—	18-0523	—
135 (1350)		2839369	3293233	18-4037	18-4038	—	18-4036	18-1154	18-7151	18-2016	18-2016	18-7961	—	18-2016	—
1400		3293234	3502805	18-4037	18-4038	—	18-4036	18-1154	—	—	—	—	—	—	—
1400-140		4865678	& UP	18-4037	18-4038	—	18-4036	—	—	—	—	—	—	—	—
140 JET	V-6	D082000	& UP	—	18-4039	—	—	18-1345	18-0860	18-2016	18-2016	18-0858	—	18-2016	—
V-135 W/ METAL CAGED MAIN BRG	V-6	A904646	C239552	—	18-1194	—	—	—	—	—	—	—	—	—	—
V-135 W/ PLASTIC CAGED MAIN BRG	V-6	A904646	C239552	—	18-1194	—	—	—	—	—	—	—	—	—	—
V-135 CONNECTING ROD #636-8118	V-6	C239553	D082000	—	18-1194	—	—	—	—	—	—	—	—	—	—
V-135	V-6	D082000	& UP	—	18-1194	—	—	—	—	—	—	—	—	—	—
V-135 DFI	V-6	D082000	G760299	—	18-4039	—	—	18-1345	—	—	—	—	—	—	—
V-135 DFI	V-6	G760300	& UP	—	18-1194	—	—	—	—	—	—	—	—	—	—

APPLICATION CONTINUED ON NEXT PAGE

HP	Cyl.	Beg. S/N	End S/N	Center Main Bearing	Con. Rod Crank End	Main Valve Block	Con. Rod Piston End	Lower Main Bearing	Lower O-ring	Lower Oil Seal	Lower Oil Seal 2	Upper O-ring	Upper Main Bearing	Upper Oil Seal	Upper Roller Bearing
1500-1500XS	V-6	3502806	5327662	18-4037	18-4038	—	18-4036	18-1154	18-7161	18-2016	18-2016	18-7961	—	18-2016	—
1500-1500XS	V-6	8005615	8052649	18-4037	18-4038	—	18-4036	—	—	—	—	—	—	—	—
1500-1500XS	V-6	7010533	7112772	18-4037	18-4038	—	18-4036	—	—	—	—	—	—	—	—
V-150 (V-1500)	V-6	4868998	C100860	—	18-4039	—	—	18-1345	—	18-2016	18-2016	—	—	18-2016	18-1196
V-150	V-6	C100861	C239552	—	18-1194	—	—	18-1345	18-0860	18-2016	18-2016	18-0858	—	18-2016	—
V-150 CONNECTING ROD #636-8118	V-6	C239553	D081999	—	18-1194	—	—	18-1345	18-0860	18-2016	18-2016	18-0858	—	18-2016	—
V-150 CONNECTING ROD #644-818141	V-6	C239553	D081999	—	18-1194	—	—	—	—	—	—	—	—	—	—
V-150 DFI	V-6	D082000	& UP	—	18-1194	—	—	18-1345	18-0860	18-2016	18-2016	18-0858	—	18-2016	—
V-150 EFI	V-6	D082000	& UP	—	18-4039	—	—	18-1345	—	—	—	—	—	—	—
150	V-6	4868998	D081999	—	18-1194	—	—	—	—	—	—	—	—	—	—
XR-4	V-6	G760300	& UP	—	18-1194	—	—	—	—	—	—	—	—	—	—
XR-4	V-6	B242885	C239552	—	18-1194	—	—	—	—	—	—	—	—	—	—
XR-4	V-6	C239553	D081999	—	18-1194	—	—	—	—	—	—	—	—	—	—
XR-6	V-6	D082000	& UP	—	18-4039	—	—	18-1345	—	—	—	—	—	—	—
V-175 (1750)	V-6	4301235	6618750	—	18-4039	—	—	18-1345	—	18-2016	18-2016	—	—	18-2016	18-1196
V-175	V-6	6618751	C239552	—	18-1194	—	—	18-1345	18-0860	18-2016	18-2016	18-0858	—	18-2016	—
V-175	V-6	C239553	D081999	—	18-1194	—	—	18-1345	18-0860	18-2016	18-2016	18-0858	—	18-2016	—
V-175	V-6	D082000	& UP	—	18-1194	—	—	—	—	—	—	—	—	—	—
V-175 XRI	V-6	D000750	D081999	—	18-1194	—	—	18-1345	18-0860	18-2016	18-2016	18-0858	—	18-2016	—
V-175 EFI	V-6	D082000	& UP	—	18-4039	—	—	18-1345	—	—	—	—	—	—	—
V-175	V-6	T178500	& UP	—	18-1194	—	—	18-1345	18-0860	18-2016	18-2016	18-0858	—	18-2016	—
DFI & PRO XS															
175 (1750)	V-6	8058870	& UP	—	18-1194	—	—	—	—	—	—	—	—	—	—
V-200 (V2000)	V-6	4839034	5363917	—	18-1194	—	—	18-1345	—	—	—	—	—	—	—
V-200 (V2000)	V-6	5363918	6073191	—	18-1194	—	—	18-1345	—	18-2016	18-2016	—	—	18-2016	18-1196
V-200 (2.4L)	V-6	6073192	C291519	—	18-1194	—	—	18-1345	18-0860	18-2016	18-2016	18-0858	—	18-2016	—
V-200 (2.5L) CONNECTING ROD #636-8118	V-6	C291520	D081999	—	18-1194	—	—	—	—	—	—	—	—	—	—
V-200 (2.5L) CONNECTING ROD #644-818141	V-6	C291520	D081999	—	18-1194	—	—	—	—	—	—	—	—	—	—
V-200	V-6	D082000	& UP	—	18-4039	—	—	18-1345	—	—	—	—	—	—	—
V-200 EFI	V-6	C100861	C291519	—	18-1194	—	—	18-1345	18-0860	18-2016	18-2016	18-0858	—	18-2016	—
V-200 EFI CONNECTING ROD #644-818141	V-6	C291520	D081999	—	18-1194	—	—	—	—	—	—	—	—	—	—
V-200 EFI CONNECTING ROD #636-8118	V-6	C291520	D081999	—	18-1194	—	—	—	—	—	—	—	—	—	—
V-200 EFI (2.5L)	V-6	D082000	B226999	—	18-4039	—	—	18-1345	—	—	—	—	—	—	—
V-220	V-6	B117316	& UP	—	18-1194	—	—	—	—	—	—	—	—	—	—
V-225	V-6	5628028	D280812	—	18-1194	—	—	18-1345	18-0860	18-2016	18-2016	—	—	18-2016	—
V-225 (225, SEAPRO)	V-6	D280813	& UP	—	18-4039	—	—	18-1345	—	—	—	—	—	—	—
V-225 DFI	V-6	G590000	T325116	—	—	—	—	18-1345	18-0860	—	—	18-7414	—	—	—
V-225	V-6	G129222	& UP	—	—	—	—	18-1345	18-0860	—	—	18-7414	—	—	—
V-250 EFI	V-6	G129222	T325116	—	—	—	—	18-1345	18-0860	—	—	18-7414	—	—	—
V-250	V-6	C101891	& UP	—	18-4039	—	—	18-1345	—	—	—	18-7414	—	18-2016	—
V-250 DFI & PRO XS	V-6	B528615	& UP	—	—	—	—	18-1345	18-0860	—	—	18-7414	—	—	—
V-275	V-6	C101891	& UP	—	—	—	—	—	—	—	—	18-7414	—	—	—
V-3.4L	V-6	5611648	& UP	—	18-4039	—	—	18-1345	—	—	—	18-7414	—	—	—

 <p>18-2143 MOTOR MOUNT Replaces: 67210, 78249 Large Diameter Lower Motor Mount Includes: (1) Lower Motor Mount and (2) 1 1/4" O.D. x 1/2" I.D. Stainless Steel Washers</p>	 <p>18-2144 MOTOR MOUNT Replaces: 67209, 77326, 78687, 78687T Small Diameter Upper Motor Mount Includes: (1) Upper Motor Mount and (1) 1 1/4" O.D. x 1/2" I.D. Stainless Steel Washer</p>	 <p>18-7901 OIL FILTER Replaces: 825467A1, T1 For: 9.9HP S/N OH000058-OH017099 (1995-98)</p>	 <p>18-7758 OIL FILTER Replaces: 35-877761K01, 35-877761Q01 For: 75/90/115 hp. (S/N 1B366823 (2006) & Up)</p>
 <p>18-7918 OIL FILTER Replaces: 35-883701K01, 35-877769K01 For: Verado 200-300 HP, Inline 6 cylinder</p>	 <p>18-7921 OIL FILTER Replaces: 35-896546T, 35-877767K01 For: Verado 135-200 HP, Inline 4 cylinder</p>	 <p>18-7906-1 OIL FILTER Replaces: 35-822626T7, 35-822626Q15, 35-8226267 Fits: 225 HP (Non-Verado)</p>	
 <p>18-7913 OIL FILTER Replaces: 35-822626Q1 For: 8 HP (323cc) 2001-2004 / 9.9 HP (323cc) 1999-2004 / 15 HP. (323cc) 1998 and NEWER / 20 HP. 2008 and NEWER / 30 HP (492cc) 2006 and NEWER</p>	 <p>18-7914 OIL FILTER Replaces: 35-822626Q2, 35-822626Q04, 35-877768K01, 35-822626K04, 35-822626T2, 35-8M0064104, 35-8M0008397 For: 25 HP. (498cc) 1998-2005 / 30 HP. (747cc) 1999-2005 / 40, 50, 60 HP. 1995 and NEWER / 75, 90 Carbureted 2000-2005 / 115 EFI (S/N 1B366822 and BELOW)</p>	 <p>New 18-1800 OIL RESERVIOR FLOAT SWITCH Replaces: 12886A6</p>	

new **TIMING BELTS**

Sierra Timing Belts provide extended durability and smoother performance characteristics required by today's marine engines.

FEATURES:

- Neoprene or Nitrile construction for maximum durability based on application
- Positive Slip Proof engagement
- Fiberglass tension member for excellent flex and elongation behavior
- Chemical and Contaminant Resistance for Long Life
- Meets or Exceeds OEM belt specifications
- Modified Curvilinear or Trapezoidal tooth profile for direct OE fitment/replacement
- Recommended periodic maintenance interval of 5 years or 1000 hours of use (Note: Timing belt should be inspected every 100 hours and replaced as necessary.)
- Inexpensive insurance to prevent catastrophic engine failure



Part No.	Replaces	Fits
18-15146	8M0072670	25 HP EFI (3 CYL) Fourstroke 0R106999 and Above; 25 HP JET EFI (3 CYL) 0R165086 and Above; 30 HP EFI (3 CYL) Fourstroke 0R106999 and Above
18-15147	835392Q	9.9 HP Fourstroke 0G760300-1B226999; 15 HP Fourstroke 1B227000-1B727495; 15 HP Fourstroke 0G760300-1B226999
18-15148	8M0065179	40 HP (3 CYL) Fourstroke 1C049739 and Above; 40-50-60 HP Fourstroke 1C050252 and Above
18-15149	57-895120	8 HP Fourstroke 0R042475 and Above; 9.9 HP Fourstroke 0R042475 and Above
18-15150	57-895120002	10 HP Carb (2 CYL) Fourstroke 0R575531-0R833819; 15 HP Carb (2 CYL) Fourstroke 0R235949-0R833819; 15 HP Carb Fourstroke JCI 0R558208-0R833819; 15 HP SEAPRO Fourstroke 0R051685-0R123564; 15 HP SEAPRO Fourstroke 0R123565 and Above; 20 HP Carb (2 CYL) Fourstroke 0R235168-0R833819



18-0663
PLENUM GASKET KIT
 Fits: Mercury 75 4-Stroke (2000-03),
 90 4-Stroke (2000 & Up),



18-4334
POWERHEAD GASKET SET
 Replaces: 27-41499A87
 For: 15HP, 18HP, 20HP & 25HP outboards

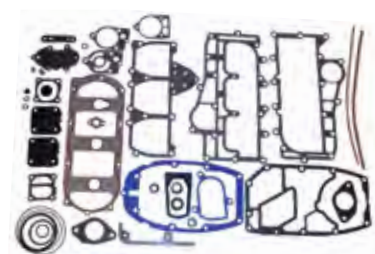

18-4326
POWERHEAD GASKET SET
 Replaces: 27-43779A87
 For: 50,55,60 HP, 3 cyl.

— CONTAINS —

Part #	Desc.	O.E.#	Qty.
18-4261	Fiber Washer	19643	1
18-0320	Gasket	27-13937-6	6
18-0324	Gasket	27-15172-3	3
18-0670	Gasket	27-43007 5	1
18-2565	Gasket	27-43047-1	1
18-2945	Washer	12-20260	3
18-7164	O-Ring	25-33466	1
18-7198	O-Ring	25-45710	1
18-7167	O-Ring	25-45254	1
18-0182	Gasket	27-62386	1
18-2740	Cylinder Block Gasket	27-43005 7	1
18-2741	Gasket	27-43004 7	2
18-0339	Thermostat Gasket	27-43006-2	1
18-0341	Exhaust Gasket	27-43008, 27-430082, 27-430083, 27-430085	1
18-2563	Gasket	27-43034-1	1
18-2564	Gasket	22-43033-1	1
18-2566	Impeller Gasket	27-817277	1
18-7105	O-Ring	25-62705	2
18-7414	O-Ring	25-64067	1
18-0858	O-Ring	25-54029	1
18-7803	Diaphragm Kit	21-857005A1	1

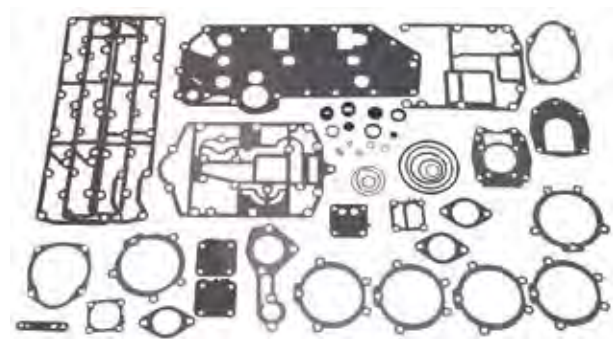

18-4336
POWERHEAD GASKET SET
 Replaces: 27-43004A99, 27-43004A90, 27-43004A86
 For: 70, 80, 90HP 3 cyl outboards

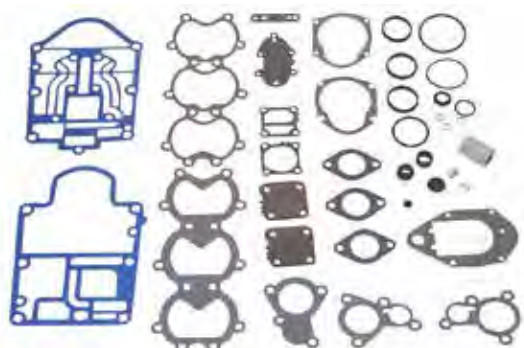

18-4337
POWERHEAD GASKET SET
 Replaces: 27-812867A97, 27-812867A96, 27-812867A91
 For: 45 Jet, 50HP, 55HP, 60HP, 3 cyl outboards

CONTAINS —

Part #	Desc.	O.E.#	Qty.
18-7152	O-Ring	25-20863	1
18-2244	Washer	10-79953A2	3
18-7173	O-Ring	25-30224	1
18-0182	Thermostat Gasket	27-62386	1
18-2719	Induction Manifold Gasket	27-812869	1
18-2721	Adapter Plate Gasket	27-827284	1
18-2729	Thermostat Cover Gasket	27-812867 2	1
18-2749	Thermostat Gasket	27-812867 1	1
NSS	Exhaust Gasket	27-812866	1
18-0319	Exhaust Cover Gasket	27-828533	1
18-0622	Lower Wear Plate Gasket	27-19701	1
18-0345	Water Pump Gasket	27-722189	1
18-2593	Water Pump Gasket	N/A	1
18-2566	Impeller Gasket	27-817277	1
18-7176	O-Ring	25-90011	1
18-7950	O-Ring	25-45258	1
18-7817	Diaphragm Kit	21-857005A1	1

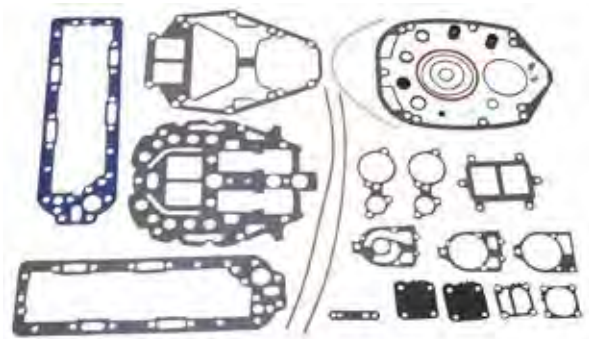

18-4338
POWERHEAD GASKET SET
 Replaces: 27-814754A00
 For: V-135, V-150 DFI outboards

CONTAINS —

Part #	Desc.	O.E.#	Qty.
18-2506-1	Exhaust Plate Gasket	27-99176-3	1
18-0860	O-Ring	25-62700	1
18-0858	O-Ring	25-54029	1
18-0182	Thermostat Gasket	27-62386	2
18-0642	Divider Plate Gasket	27-19050-3	1
18-2735	Divider Plate Gasket	27-190506	1
18-0936	Gasket	27-78690	2
18-2511	Gasket	27-99173-2	1
18-0643	Powerhead Base Gasket	27-183071	1
18-2919	Gasket	27-42631-1	1
18-7176	O-Ring	25-90011	1
18-2914	Water Pump Gasket	27-85608-1	1
18-2915	Water Pump Gasket	27-85609-1	1
18-7159	O-Ring	25-31534	1
18-7153	O-Ring	25-25439	1
18-7174	O-Ring	25-45711	2
18-0970	Fuel Pump Gasket	27-98769-1	1
18-0135	Adapter Cover Gasket	27-78246	1
18-2514	Crankcase Gasket	27-53650	2

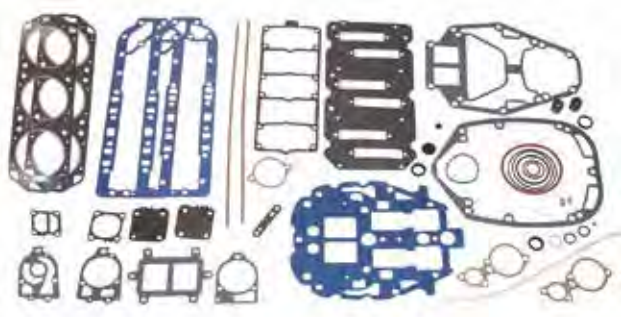

18-4339
POWERHEAD GASKET SET

Replaces: 27-14697A87
For: V200EFI and V220 outboards

CONTAINS —			
Part #	Desc.	O.E.#	Qty.
18-3862	Head Gasket	27-41246-1	2
18-7153	O-Ring	25-21836	1
18-7164	O-Ring	25-33466	1
18-7159	O-Ring	25-31534	1
18-0135	Gasket	27-78246	1
18-7426	Slinger	25-30271	1
18-0182	Gasket	27-62386	2
18-0860	O-Ring	25-62700	1
18-0936	Gasket	27-78690	2
18-2919	Gasket	27-42631-1	1
18-2915	Gasket	27-85609-1	1
18-2506-1	Exhaust Plate Gasket	27-99176-3	1
18-2503	Drive Shaft Gasket	27-99177-1	1
18-2513	Cork	27-11338	2
18-0644	Reed Plate Gasket	27-14697-2	1
18-0645	Gasket	27-16737-1	1
18-2502	Gasket	27-90484-1	2
18-2511	Gasket	27-99173-2	1
18-2914	Gasket	27-85608-1	1
18-3110	Grommet	26-38970	2
18-7174	O-Ring	25-45711	2
18-7176	O-Ring	25-90011	1
18-8305	Divider Plate Seal	26-814754	1
18-0858	O-Ring	25-54029	1
18-0952	Gasket	27-88907	1
18-7421	O-Ring	25-20415	1
18-0970	Fuel Pump Gasket	27-98769-1	1
18-7817	Diaphragm Kit	21-857005A1	1

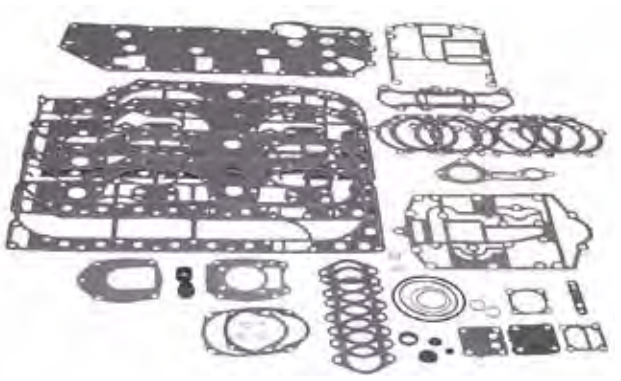

18-4340
POWERHEAD GASKET SET

Replaces: 27-13461A99, 27-13461A90, 27-13461A89, 27-13461A88
For: 80 Jet, 100HP, 115HP, and 125HP 4 cyl outboards

CONTAINS —			
Part #	Desc.	O.E.#	Qty.
18-4261	Fiber Washer	19643	1
18-7961	O-Ring	25-47254	1
18-0320	Gasket	27-13937-6	8
18-0324	Gasket	27-15172-4	8
18-0670	Gasket	27-43007-5	1
18-2565	Gasket	27-43047-2	1
18-2945	Washer	12-19183	3
18-7198	O-Ring	25-45710	1
18-0182	Gasket	27-62386	1
NSS	Gasket	27-13461-2	2
18-2943	Cylinder Block Gasket	27-44328-4	1
18-2621	Outer Exhaust Plate Gasket	27-13958-1	2
18-2610	Baffle Plate Gasket	27-812775-4	1
18-2611	Inner Exhaust Plate Gasket	27-812775-5	1
18-0339	Thermostat Gasket	27-43006-2	1
18-0341	Exhaust Gasket	27-43008-6, 27-43008, 27-430082, 27-430083, 27-430085	1
18-2563	Gasket	27-43034-1	1
18-2564	Gasket	27-43033-1	1
18-2566	Impeller Gasket	27-817277	1
18-7105	O-Ring	25-62705	1
18-7414	O-Ring	25-64067	1
18-0858	O-Ring	25-54029	1
18-0970	Fuel Pump Gasket	27-98769-1	1
18-7817	Diaphragm Kit	21-857005A1	1

— CONTAINS —			
Part #	Desc.	O.E.#	Qty.
18-0182	Thermostat Gasket	27-62386	2
18-0858	O-Ring	254029	1
18-0860	O-Ring	25-62700	1
18-0129	Reed Block Gasket	27-65744-3	6
18-0135	Adapter Cover Gasket	27-78246	1
18-0936	Relief Valve Plate Gasket	27-78690	2
18-0952	Relief Valve Plate Gasket	27-88907	2
18-7421	O-Ring	25-20415	2
18-7411	O-Ring	25-35480	1
18-2501	Reed Block Housing Gasket	27-93536-1	1
18-2502	Divider Plate Gasket	27-90484-1	2
18-2503	Drive Shaft Hsg. to Exhaust Plate Gasket	27-99177-1	1
18-2506	Exhaust Plate Gasket	27-99176-3	1
18-2508	Exhaust Plate Gasket	27-99776-1	2
18-2509	Carb. Mtg. Gasket	27-67751	3
18-2510	Reed Block Housing Gasket	27-96761-1	1
18-2511	Drive Shaft Housing to Plate Gasket	27-99173-2	1
18-2513	Cyl Block Sealing Gasket	27-11338	2
18-2803	Carb. Mounting Gasket	27-90430	3
18-2808	Cyl. Cover	27-96278	2
18-2826	Water Pump Base to Gear Housing Gasket	27-85610-1	1
18-2914	Water Pump Gasket	27-85608-1	1
18-2915	Water Pump Gasket	27-85609-1	1
18-3110	Bushing	26-38970	2
18-7153	O-Ring	25-25439	1
18-7157	O-Ring	25-29976	1
18-7159	O-Ring	25-31534	1
18-7162	O-Ring	25-33145	1
18-7164	O-Ring	25-33466	1
18-7168	O-Ring	25-48171	4
18-7174	O-Ring	25-45711	2
18-7176	O-Ring	25-90011	1
18-7812	Fuel Pump Kit	89031A2	1
18-3863	Head Gasket	27-96542-1	2
18-0359	Induction Silencer Cover Gasket	27-67275-1	1
18-0384	Carburetor Gasket	27-89221-1	3
18-2919	Water Pump Gasket	27-42631-1	1
18-7406	O-Ring	—	1

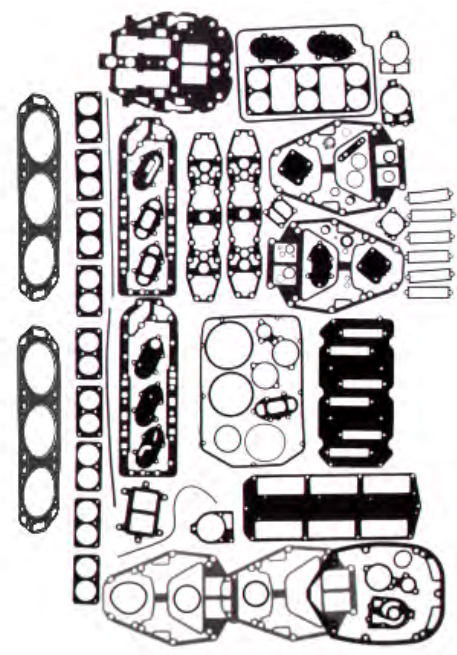

18-4317
POWERHEAD GASKET SET
Replaces: 27-90484A88, 27-90484A86, 27-90484A32

GASKET SET APPLICATION BEGINS ON PAGE 418
***POWERHEAD GASKET SETS DO NOT INCLUDE HEAD GASKETS**

— CONTAINS —

Part #	Desc.	O.E.#	Qty.
18-0182	Thermostat Gasket	27-62386	2
18-0858	O-Ring	254029	1
18-0860	O-Ring	25-62700	1
18-0129	Reed Block Gasket	27-65744-3	6
18-0135	Adapter Cover Gasket	27-78246	1
18-0936	Relief Valve Plate Gasket	27-78690	2
18-0952	Relief Valve Plate Gasket	27-88907	2
18-7421	O-Ring	25-20415	2
18-7411	O-Ring	25-35480	1
18-2501	Reed Block Hsg. Gasket	27-93536-1	1
18-2502	Divider Plate Gasket	27-90484-1	2
18-2503	Drive Shaft Hsg. to Exhaust Plate Gasket	27-99177-1	1
18-2506	Exhaust Plate Gasket	27-99176-3	1
18-2508	Exhaust Plate Gasket	27-99776-1	2
18-2509	Carb. Mtg. Gasket	27-67751	3
18-2510	Reed Block Hsg. Gasket	27-96761-1	1
18-2511	Drive Shaft Hsg. to Plate Gasket	27-99173-2	1
18-2513	Cyl Block Sealing Gasket	27-11338	2
18-2803	Carb. Mtg. Gasket	27-90430	3
18-2808	Cyl. Cover	27-96278	2
18-2826	Water Pump Base to Gear Housing Gasket	27-85610-1	1
18-2914	Water Pump Gasket	27-85608-1	1
18-2915	Water Pump Gasket	27-85609-1	1
18-3110	Bushing	26-38970	2
18-7153	O-Ring	25-25439	1
18-7157	O-Ring	25-29976	1
18-7159	O-Ring	25-31534	1
18-7162	O-Ring	25-33145	1
18-7164	O-Ring	25-33466	1
18-7168	O-Ring	25-48171	4
18-7174	O-Ring	25-45711	2
18-7176	O-Ring	25-90011	1
18-7812	Fuel Pump Kit	89031A2	1
18-3862	Head Gasket	27-41246-1	2
18-0359	Induction Silencer Cover Gasket	27-67275-1	1
18-0384	Carburetor Gasket	27-89221-1	3
18-2919	Water Pump Gasket	27-42631-1	1
18-7406	O-Ring	—	1
18-7176	O-Ring	25-90011	1

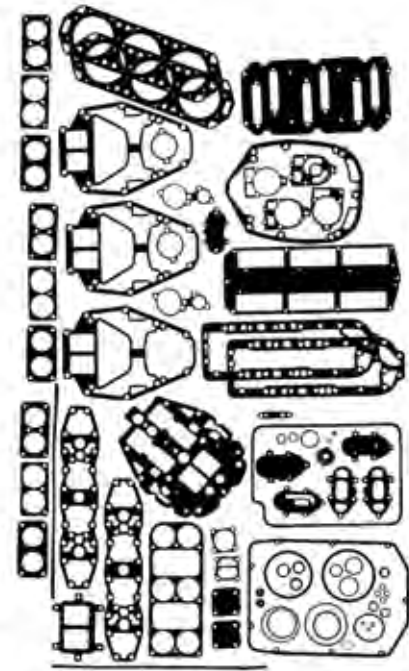

18-4319
POWERHEAD GASKET SET

Replaces: 27-11338A88, 27-89221A88, 27-89221A85, 27-89221A84, 27-89221A32, 27-11338A85

— CONTAINS —

Part #	Desc.	O.E.#	Qty.
18-0940	Baffle Plate to Exhaust Gasket	27-85488-2	1
18-0879	Adapter Plate Gasket	27-38501-1	1
18-2810	Block Cover Gasket	27-43777-2	1
18-0103	Powerhead to Ext. Plate Gasket	27-79650-1	2
18-0137	Baffle Plate Gasket	27-85492-2	1
18-2800	Carb. Flange Gasket	27-75791-1	2
18-0870	Transfer Port Cover Gasket	27-27936-1	2
18-0539	Rubber Seal Gasket	37721	1
18-7161	O-Ring	25-32546	1
18-2844	Thermostat Gasket	27-48818-1	1
18-2823	Lower Water Pump Base to Face Plate Gasket	27-19553	1
18-0938	Water Inlet Tube Gasket	27-79797-1	1
18-2825	Water Pump Base Gasket	27-32771	1
18-7153	O-Ring	25-25439	1
18-7151	O-Ring	25-20081	1



***18-4325**
POWERHEAD GASKET SET

Replaces: 27-85491A90, 25-85491A87

— CONTAINS —

Part #	Desc.	O.E.#	Qty.
18-0912	Drive Shaft Hsg. Plate Gasket	27-66102-1	1
18-0133	Water Jacket Cover Gasket	27-73665	1
18-0944	Water Jacket Cover Gasket	27-85496-1	1
18-0107	Exhaust Cover Gasket	27-85498-1	1
18-7421	O-Ring	25-20415	1
18-3110	Grommet	26-38970	2
18-7411	O-Ring	25-35480	1
18-2500	VC Gasket	27-85493	1
18-2514	Crankcase to Cyl Block Gasket	27-53650	2
18-2802	Carb. Flange Gasket	27-48164-1	2
18-2826	Water Pump Base to Gear Housing Gasket	27-85610	1
18-2835	Powerhead Gasket	27-69238	1
18-2914	Water Pump Gasket	27-85608	1
18-2915	Water Pump Gasket	27-85609-1	1
18-7153	O-Ring	25-25439	1
18-7157	O-Ring	25-29976	1
18-7161	O-Ring	25-32546	1
18-7162	O-Ring	25-33145	1
18-7167	O-Ring	25-47254	2
18-7807	Fuel Pump Kit	55278A1	1
18-0351	Distributor Cap Gasket	27-55896	1
18-7426	O-Ring	25-30271	1
18-4261	Washer	19643	1

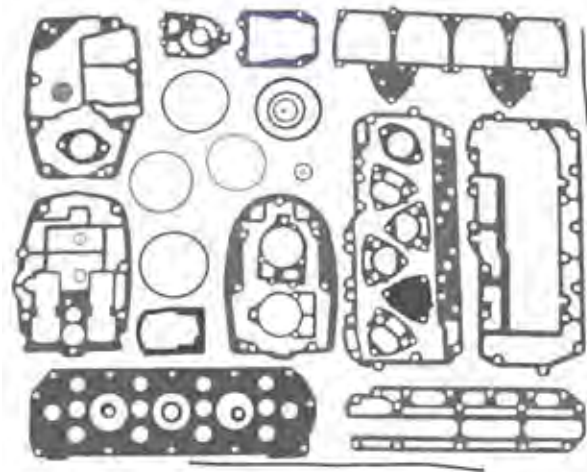

***18-4351**
POWERHEAD GASKET SET

Replaces: 27-64203A75, 27-64203A74, 27-64203A73

— CONTAINS —

Part #	Desc.	O.E.#	Qty.
18-0870	Transfer Port Cover Gasket	27-27936-1	2
18-0879	Adapter Plate Gasket	27-30501-1	1
18-0103	Powerhead to Ext. Plate Gasket	27-79650-1	2
18-0938	Water Inlet Tube Gasket	27-79797-1	1
18-0942	Baffle Plate Gasket	27-85491-2	1
18-0137	Baffle Plate Gasket	27-85492-2	1
18-7421	O-Ring	25-20415	1
18-2507	Cyl Block Cover Gasket	27-85487	1
18-2800	Carb. Flange Gasket	27-75791-1	2
18-2810	Block Cover Gasket	27-43777-2	1
18-2823	Lower Water Pump Base to Face Plate Gasket	27-32769, 27-19553	1
18-2824	Upper Face Plate to Pump Body Gasket	27-32770, 27-19551	1
18-2825	Water Pump Base Gasket	27-32771	1
18-2841	Water Pump Base Gasket	27-77417, 27-19552	1
18-7151	O-Ring	25-20081	2
18-7153	O-Ring	25-25439	1
18-7115	O-Ring	25-26722	1
18-7155	O-Ring	25-26855	1
18-7160	O-Ring	25-31986	1
NSS	O-Ring	25-29619	1
18-7413	O-Ring	25-62702	2
18-7804	Fuel Pump Kit	23014A1	1
18-2571	Carb Flange Gasket	27-31402	2



***18-4353 POWERHEAD GASKET SET**
 Replaces: 27-72486A32, 27-72486A79, 27-72486A78, 27-72486A76, 27-46110A72, 27-46110A2, 27-46110A1

— CONTAINS —

Part #	Desc.	O.E.#	Qty.
18-0912	Drive Shaft Hsg. Plate Gasket	27-66102-1	1
18-0926	Transfer Port Cover Gasket	27-73645	1
18-0133	Water Jacket Cover Gasket	27-73665	1
18-0101	Carb. Plate Gasket	27-76952	2
18-0944	Baffle to Exchange Cover Gasket	27-85496-1	1
18-0107	Exhaust Cover Gasket	27-85498-1	1
18-7421	O-Ring	25-20415	1
18-3110	Grommet	26-38970	1
18-7411	O-Ring	25-35480	2
18-2500	Exhaust Cover Gasket	27-85493	1
18-2505	Cyl Block Cover Gasket	27-96171-1	1
18-2514	Crankcase to Cyl Block Gasket	27-53650	2
18-2804	Carb. Flange Gasket	27-73377-1	2
18-2826	Water Pump Base to Gear Housing Gasket	27-85610-1	1
18-2835	Powerhead Gsk	27-69238-1	1
18-2914	Water Pump Gasket	27-85608-1	1
18-2915	Water Pump Gasket	27-85609-1	1
18-7153	O-Ring	25-25439	1
18-7157	O-Ring	25-29976	1
18-7161	O-Ring	25-32546	2
18-7162	O-Ring	25-33145	1
18-7164	O-Ring	25-33466	1
18-7167	O-Ring	25-47254	2
18-7413	O-Ring	25-62702	2
18-7808	Fuel Pump Kit	55278A5	1
18-7426	O-Ring	25-30271	1
18-4261	Washer	19643	1

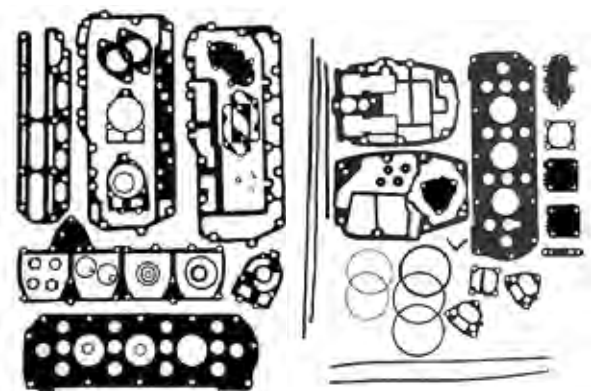

***18-4354 POWERHEAD GASKET SET**
 Replaces: 27-73645A87, 27-73645A76, 27-73645A32

— CONTAINS —

Part #	Desc.	O.E.#	Qty.
18-0182	Thermostat Gasket	27-62386	1
18-0879	Adapter Plate Gasket	27-38501-1	1
18-0988	Powerhead to Plate Gasket	27-62860-1	1
18-0914	Thermostat Cover Gasket	27-66847	1
18-0938	Water Inlet Tube Gasket	27-79797-1	1
18-0940	Baffle Plate to Exhaust Gasket	27-85488-2	1
18-0105	Baffle Plate to Block Gasket	27-85489-2	1
18-7421	O-Ring	25-20415	1
18-7411	O-Ring	25-35480	1
18-2802	Carb Flange Gasket	27-48164-1	1
18-2805	Block Cover Gasket	27-85490-2	1
18-2823	Lower Water Pump Base to Face Plate Gasket	27-19553	1
18-2824	Upper Face Plate to Pump Body Gasket	27-19551	1
18-2825	Water Pump Base Gasket	27-32771	1
18-2838	Transfer Port Cover Gasket	27-55279-1	1
18-2841	Water Pump Base Gasket	27-19552	1
18-7115	O-Ring	25-26722	1
18-7143	O-Ring	25-65936	2
18-7145	O-Ring	25-64068	3
18-7153	O-Ring	25-25439	1
18-7155	O-Ring	25-26855	1
18-7160	O-Ring	25-31986	1
18-7167	O-Ring	25-47254	1
18-7413	O-Ring	25-62702	3
18-7414	O-Ring	25-64067	1
18-7807	Fuel Pump Kit	55278A1	1
18-4261	Washer	19643	1



***18-4355 POWERHEAD GASKET SET**
 Replaces: 27-78028A78, 27-55306A75, 27-55306A74, 27-55306A73, 27-55306A72

GASKET SET APPLICATION BEGINS ON PAGE 418
 *POWERHEAD GASKET SETS DO NOT INCLUDE HEAD GASKETS

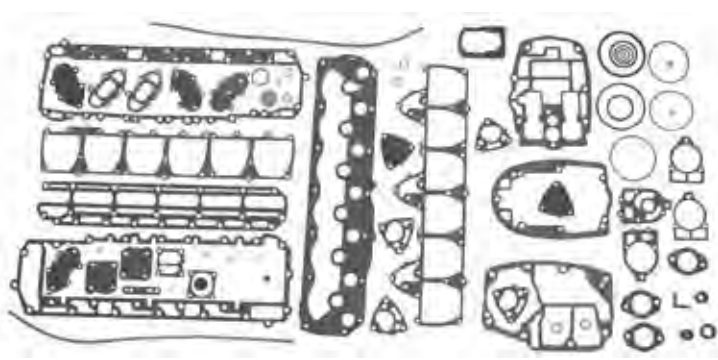

***18-4356**
POWERHEAD GASKET SET
 Replaces: 27-85653A87, 27-85653A79, 27-85653A32, 27-60476A75, 27-60476A74, 27-60476A73, 27-60476A72

— CONTAINS —

Part #	Desc.	O.E.#	Qty.
18-7153	O-Ring	25-25439	1
18-7120	O-Ring	25-38933	1
18-3110	Bushing	26-38970	2
18-7164	O-Ring	25-33466	1
18-7167	O-Ring	25-47254	1
18-2802	Carb. Flange Gasket	27-48164-1	3
18-7413	O-Ring	25-62702	2
18-7161	O-Ring	25-32546	2
18-7173	O-Ring	25-30224	1
18-3110	Grommet	26-38970	1
18-7421	O-Ring	25-20415	1
18-7162	O-Ring	25-33145	1
18-7157	O-Ring	25-29976	1
18-2914	Water Pump Gasket	27-85608-1	1
18-2915	Water Pump Gasket	27-85609-1	1
18-2801	Water Pump Gasket	27-32438	1
18-2826	Water Pump Base to Gear Housing Gasket	27-85610-1	1
18-0912	Drive Shaft Hsg. Gasket	27-66102-1	1
18-2573	Water Jacket Cover Gasket	27-72142-1	1
18-2574	Exhaust Cover Gasket	27-85495-2	1
18-0946	Transfer Port Gasket	27-85653-1	1
18-2513	Crankcase to Cyl. Block Gasket	27-53862	2
18-2807	Block Cover Gasket	27-98185	1
18-2835	Powerhead Gasket	27-69238-1	1
18-2839	Exhaust Cover	27-85497-2	1
18-7807	Fuel Pump Kit	55278A1	2
18-7813	Fuel Pump Kit	89031A3	1
18-7426	O-Ring	25-30271	1

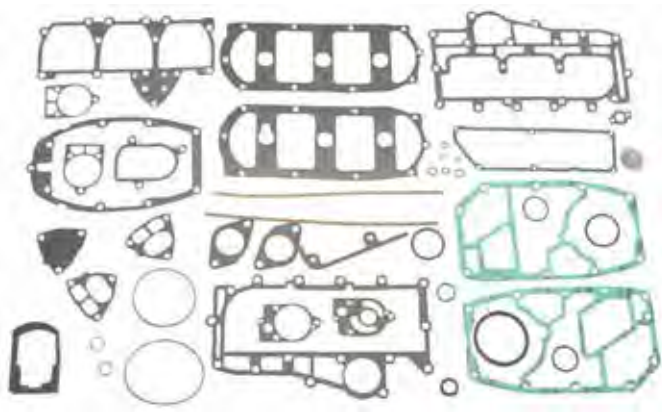

***18-4357**
POWERHEAD GASKET SET
 Replaces: 27-88449A32, 27-88449A80, 27-76589A79, 27-76589A78, 27-76589A77, 27-73440A76

— CONTAINS —

Part #	Desc.	O.E.#	Qty.
18-0182	Thermostat Gasket	27-62386	1
18-0879	Adapter Plate Gasket	27-38501-1	1
18-0904	Powerhead to Exhaust Gasket	27-60317	1
18-0918	Plate to Exhaust Manifold Gasket	27-69524-2	1
18-0131	Baffle Plate Gasket	27-69525-2	1
18-0922	Baffle Plate Gasket	27-70335-1	1
18-0932	Transfer Passage Cover Gasket	27-76862-1	1
18-0938	Water Inlet Tube Gasket	27-79797-1	1
18-0139	Powerhead to Exhaust Plate Gasket	27-88451-1	1
18-7421	O-Ring	25-20415	1
18-2945	Drain Gasket	12-20260	2
18-7411	O-Ring	25-35480	1
18-2504	Block Cover Gasket	27-88449	1
18-2512	Crankcase to Cyl. Block Gasket	27-60286	2
18-2804	Carb. Flange Gasket	27-73377-1	2
18-2809	Block Cover Gasket	27-43779-2	1
18-2823	Lower Water Pump Base to Face Plate Gasket	27-19553	1
18-2824	Upper Face Plate to Pump Body Gasket	27-19551	1
18-2825	Water Pump Base Gasket	27-32771	1
18-2841	Water Pump Base Gasket	27-19552	1
18-7143	O-Ring	27-77417	1
18-7153	O-Ring	25-25439	1
18-7115	O-Ring	25-26722	1
18-7155	O-Ring	25-26855	1
18-7160	O-Ring	25-31986	1
18-7161	O-Ring	25-32546	1
18-7413	O-Ring	25-62702	2
18-7415	O-Ring	25-64966	1
18-7809	Fuel Pump Kit	55278A4	1
18-4261	Washer	19643	1

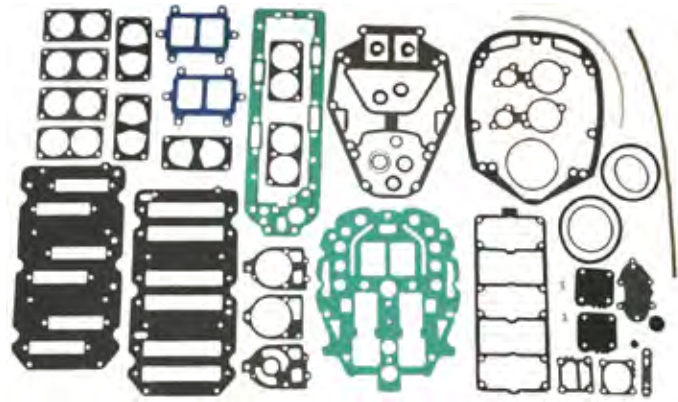

***18-4359**
POWERHEAD GASKET SET
 Replaces: 27-815791A92, 27-815792A90, 27-815810A90, 27-815809A90

— CONTAINS —

Part #	Desc.	O.E.#	Qty.
18-0135	Gasket, Adapter	27-78246	1
18-0182	Gasket, Thermostat	27-62386	2
18-0384	Gasket, Carburetor	27-89221-1	3
18-0641	Gasket, Carb Mounting	27-828292	3
18-0642	Gasket, Divider Plate	27-19050-3	1
18-0643	Gasket, Exh. Plate	27-18307-1	1
18-0644	Gasket, Reed Plate	27-14697-2	1
18-0645	Gasket, Adapter Plate	27-16737-1	1
18-0646	Gasket, Reed Plate	27-813859	1
18-0838	O-Ring	—	1
18-0858	O-Ring	25-54029	1
18-0860	O-Ring	25-62700	1
18-0936	Gasket, Relief Valve	27-78690	2
18-2506	Gasket, Pwr Head	27-99176-3	1
18-2509	Gasket, Carb Mounting	27-67751	3
18-2511	Gasket, Drive Shaft To Hsg Plate	27-99173-2	1
18-2513	Gasket, Crankcase Cvr.	27-11338	2
18-2914	Gasket, Water Pump	27-85608-1	1
18-2915	Gasket, Water Pump	27-85609-1	1
18-2919	Gasket, Water Pump	27-42631-1	1
18-3110	Seal	26-38970	2
18-7153	O-Ring	25-25439	1
18-7157	O-Ring	25-29976	1
18-7159	O-Ring	25-31534	1
18-7174	O-Ring	25-45711	1
18-7176	O-Ring	25-90011	1
18-8305	Seal, Divider Plate	26-814754	1



18-64217
POWERHEAD GASKET SET
Replaces: 27-815791A00
Fits: Mercury 150/175 EFI(G960500-T408999)



18-64221
POWERHEAD GASKET SET
Replaces: 3V1-87121-0
Fits: F8/F9.8

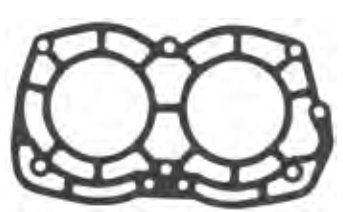

18-2736
HEAD GASKET
Replaces: 27-863895,
27-863891, 27-863893
For: 15-25HP 2 cyl



18-3804
HEAD GASKET
Replaces: 27-19138M,
19138, 27-84733M
For: Model 30A; S/N Code 689



18-3828
HEAD GASKET
Replaces: 27-18937M,
27-18937, 27-98990M,
27-83899M
For: Model 9.9C; S/N Code 682 &
Model 15C, S/N Code 684



18-3861
HEAD GASKET
Replaces: 27-187851,
27-187853, 27-18785T
For: Model 135, 150 and XR4



18-3862
HEAD GASKET
Replaces: 27-41246-1
For: Model 175, 200, XR4



18-3844
HEAD GASKET
Replaces: 27-803508
For: 4-Stroke O/B's, 4/5/6 HP
S/N OR000001 & Up



18-3871
HEAD GASKET
Replaces: 27-18786-1
For: Model 175, XR4, Mag II



18-3863
HEAD GASKET
Replaces: 27-96542-1
For: Model 150



18-3864
HEAD GASKET
Replaces: 27-822844-1
For: Model 175, 200 and XR6



18-3872
HEAD GASKET
Replaces: 27-41245-1
For: 200 and 225 HP



18-3845
HEAD GASKET
Replaces: 27-825032
For: 4-Stroke O/B's, 40/45/50 HP S/N
OG760300 & Up



18-3827
HEAD GASKET
Replaces: 27-8254821, 27-825482
For: 8, 9.9 HP 4-Stroke



18-60916
CYLINDER HEAD GASKET
Replaces: 27-850836001
Fits: Mercury 8/9.9 (R042475 & Up)



PKG. OF 5
18-7400
18-7400-9
O-RING HEAD GASKET
Replaces: 25-818573
1 per cylinder, 3 per cylinder head

① Priced per Package
GASKET SET APPLICATION ON NEXT PAGE
***POWERHEAD GASKET SETS DO NOT INCLUDE HEAD GASKETS**

HEAD GASKET/GASKET SET APPLICATION













Model	Cyl.	Beg. S/N	End S/N	Gasket Set	Head O-Rings	Head Gasket	Head Seals
4/5/6 (4 stroke)	1 CYL	R000001	& UP	—	—	18-3844	—
8 FOUR STROKE (232cc)		H000058	H017349	—	—	18-3827	—
8 FOUR STROKE (232cc)		G760300	T178499	—	—	18-3827	—
9.9 FOUR STROKE (232cc)		H000058	H017349	—	—	18-3827	—
18 (18XD)	2	6416713	6443972	18-4334	—	—	—
20 (20,20XD, 200)	2	6443973	OT800999	18-4334	—	—	—
20 JET	2	G044027	& UP	18-4334	—	—	—
30 JET (40 HP)	4 CYL	C159200	& UP	18-4325	—	—	—
35	2 CYL	6445653	B110788	18-4355	—	—	—
40,402	2 CYL	3336258	G053313	18-4355	—	—	—
40	4 CYL	C159200	& UP	18-4325	—	—	—
40 FOUR STROKE (232cc)	3 CYL	G231123	T178499	—	—	18-3845	—
45	4 CYL	5531630	0B110788	18-4353	—	—	—
45	4 CYL	B110789	& UP	18-4325	—	—	—
45 Jet	3 CYL	D000750	& UP	18-4337	—	—	—
45 FOUR STROKE (BODENSEE)		G231123	T178499	—	—	18-3845	—
50,500	4 CYL	2116318	& UP	18-4353	—	—	—
50, 60	4 CYL	6428681	B122929	18-4357	—	—	—
50	3 CYL	D000750	OG589999	18-4337	—	—	—
50	3 CYL	B122930	D000749	18-4326	—	—	—
50 FOUR STROKE		G231123	T178499	—	—	18-3845	—
55	3 CYL	6428681	B122929	18-4357	—	—	—
55	3 CYL	D000750	& UP	18-4337	—	—	—
65 (650)	3 CYL	3293184	4382056	—	—	—	—
65 (650)	3 CYL	4382057	4571651	18-4357	—	—	—
70	3 CYL	4571652	A996141	18-4357	—	—	—
70	3 CYL	A996142	& UP	18-4336	—	—	—
75	4 CYL	6432901	& UP	18-4354	—	—	—
80	3 CYL	A996142	& UP	18-4336	—	—	—
80 Jet	4 CYL	D283222	& UP	18-4340	—	—	—
80,800	4 CYL	2559001	3493912	18-4350	—	—	—
80,800	4 CYL	4831999	6432900	18-4354	—	—	—
85,850	4 CYL	3493913	4366801	18-4351	—	—	—
85,850	4 CYL	4366802	4831998	18-4354	—	—	—
90,900	6 CYL	4845301	& UP	18-4356	—	—	—
90	3 CYL	A996142	& UP	18-4336	—	—	—
100	4 CYL	B209468	& UP	18-4340	—	—	—
105 JET	6 CYL	D082000	& UP	18-4359	—	18-3864②	— 1
115	4 CYL	C100000	& UP	18-4340	—	—	—
125	4 CYL	D283222	& UP	18-4340	—	—	—
140 (140, 1400)	6 CYL	3293234	3502805	18-4356	—	—	—
140 (140, 1450)	6 CYL	4865678	& UP	18-4356	—	—	—
140 (140, 1400)	6 CYL	4865678	& UP	18-4356	—	—	—
150 (1500)	6 CYL	3502806	5327622	18-4356	—	—	—
V-135	V-6	A904646	C239552	18-4317 □	—	18-3863	—
V-135	V-6	C239553	G960499	18-4359	—	18-3861	— 1
V-135 DFI	V-6	G590000	G960499	18-4338	—	—	— 1
140 JET	V-6	D082000	G960499	18-4359	—	18-3864	— 1
V-150 (150, 1500)	V-6	4868998	6042945	18-4315	—	—	—
V-150	V-6	6042946	C239552	18-4317□	—	18-3863	—
V-150	V-6	C239553	G960499	18-4359	—	18-3861	— 1
V-150	V-6	G960500	& UP	18-4338	—	—	— 6
V-150 (XR/MAGNUM II)	V-6	B242885	C239552	18-4319□	—	—	—
V-150 XR4	V-6	C239553	D081999	18-4359	—	18-3871	— 1
V-150 (XR6/MAGNUM III)	V-6	D082000	G960499	18-4359	—	18-3864②④	— 1
V-150 (EFI)		D082000	G960499	18-4359	N/A	—	— 1

① Gasket set includes head gasket ④ Used on a 2.5L with a 3.5" bore 2 Cyl head o-rings & seal not included in gskt kit
 ② 2 head gaskets required ⑤ Requires 3 per cylinder head 3 Cyl head o-rings not included in gskt kit 6 Cyl head gaskets & seal not included in gskt set
 ③ Used on a 2.4L with a 3.38" bore 1 head gaskets not included in gskt set

HEAD GASKET/GASKET SET APPLICATION























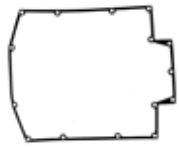
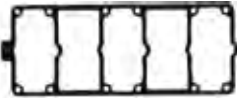



Model	Cyl.	Beg. S/N	End S/N	Gasket Set	Head O-Rings	Head Gasket	Head Seals
150 MAR	V-6	5600162	6038680	18-4315	—	—	—
150 MAR	V-6	6038681	C239553	18-4317 ①	—	18-3863②	—
150 MAR	V-6	C239554	& UP	18-4359	—	18-3861②	—
V-175 (175, 1750)	V-6	4301235	6618750	18-4315	—	—	—
V-175	V-6	6618751	C239552	18-4319 ①	—	18-3862	—
V-175	V-6	C239553	D081999	18-4359	—	18-3871②③	—1
V-175	V-6	D082000	G960499	18-4359	—	18-3864③④	—
V-175 (EFI)	V-6	D000750	D081999	18-4359	—	18-3871②③	—1
V-175 XRI EFI	V-6	D000750	D081999	18-4359	—	18-3864②④	—
V-175 (EFI)	V-6	D082000	G303045	18-4359	—	18-3864②④	—1
V-200 (200,2000)	V-6	4839034	6073191	—	—	18-3872②	—
V-200	V-6	6073192	6203990	—	—	18-3872②	—
V-200	V-6	6203991	C291519	18-4319 ①	—	18-3862②③	—
V-200	V-6	C291520	D081999	18-4359	—	18-3864②④	—1
V-200	V-6	D082000	G960499	18-4359	—	—	—1
V-200 (EFI)	V-6	C100861	OC291519	18-4339	—	18-3862	—
V-200 (EFI)	V-6	C291520	G960499	18-4359	—	18-3864	—1
V-200 (DFI) 3.0L	V-6	G386496	G589999	—	18-7400	—	—
V-200 (DFI) 3.0L	V-6	G590000	G960499	18-4335	18-7400	—	—2
V-200 (DFI) 3.0L	V-6	G960500	T178499	—	18-7400	—	—3
V-200 XRI EFI	V-6	C100861	C291519	—	—	18-3862②	—
V-200 XRI EFI	V-6	C291520	& UP	18-4359	—	18-3864②④	—
V-220	V-6	B117316	& UP	18-4339	—	18-3862②	—
V-225 SEA PRO	V-6	G245605	OT408999	—	18-7400 ⑤	—	—
V-225 (EFI) 3.0L	V-6	G129222	T408999	—	18-7400 ⑤	—	—
V-225 DFI (3.0L)	V-6	G590000	OG960499	18-4335	18-7400 ⑤	—	—3
V-225 DFI (3.0L)	V-6	G960500	T178499	—	18-7400 ⑤	—	—3
V-250 (EFI) 3.0L	V-6	G129222	T408999	—	18-7400 ⑤	—	—

- ① Gasket set includes head gasket ④ Used on a 2.5L with a 3.5" bore 2 Cyl head o-rings & seal not included in gsckt kit
 ② 2 head gaskets required ⑤ Requires 3 per cylinder head 3 Cyl head o-rings not included in gsckt kit 6 Cyl head gaskets & seal not included in gsckt set
 ③ Used on a 2.4L with a 3.38" bore 7 head gaskets not included in gsckt set

 18-0101 CARB TO SILENCER BOX GASKET Replaces: 27-76952, 27-73397 4 Cyl.	 18-0324 CARB TO MANIFOLD GASKET Replaces: 27-15172 3, 27-151724, 27-15172, 27-93214	 18-0384 CARB GASKET Replaces: 27-892211, 27-817533, 27-89221, 27-8M0027781 200/225 HP	 18-0633 CARB MOUNTING GASKET Replaces: 27-192061, 27-42178, 27-19206, 27-414491, 27-41449	
 18-0641 CARB MOUNTING GASKET Replaces: 27-828292	PKG. OF 3  18-2509 18-2509-9⑥ CARB MOUNTING GASKET Replaces: 27-67751 V-6	PKG. OF 2  18-2571 18-2571-9⑥ CARB FLANGE GASKET Replaces: 27-31402	PKG. OF 2  18-2572 18-2572-9⑥ CARB FLANGE GASKET Replaces: 27-63309, 27-22023	
PKG. OF 2  18-2800 18-2800-9⑥ CARB MOUNTING GASKET Replaces: 27-757911, 27-75791, 27-69659, 27-26891 20-45-50 HP	PKG. OF 2  18-2802 18-2802-9⑥ CARB FLANGE GASKET Replaces: 27-48164, 27-481641	PKG. OF 3  18-2803 18-2803-9⑥ CARB MOUNTING GASKET Replaces: 27-90430, 27-904301 V-6	PKG. OF 4  18-2804 18-2804-9⑥ CARB MOUNTING GASKET Replaces: 27-733771, 27-73377 3-4 Cyl.	PKG. OF 2  18-2568 18-2568-9① STRAINER COVER SCREW GASKET Replaces: 27-25848

SEE PAGES 201-202 FOR OUR COMPLETE LINE OF GASKET SEALANTS





















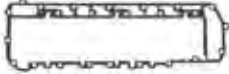



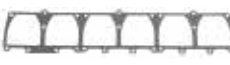
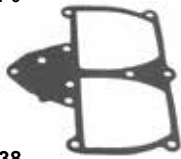

⑥ Priced per Package

 <p>18-2569 18-2569-9^① FILTER COVER GASKET Replaces: 27-25849</p>	 <p>18-2570 18-2570-9^① STRAINER COVER GASKET Replaces: 27-25851, 27-34614</p>	 <p>18-2575 18-2575-9^① CARB BOWL GASKET Replaces: 1399-99</p>	 <p>18-0970 18-0970-9^① FUEL PUMP GASKET Replaces: 27-987691, 27-98769</p>	 <p>18-0740-1 THROTTLE BODY GASKET Replaces: 27-805396</p>															
 <p>18-0359 INDUCTION SILENCER COVER GASKET Replaces: 27-672751, 27-67275</p>	 <p>18-2737 REED BLOCK GASKET Replaces: 27-850283 For: 200 DFI, 225 DFI</p>	 <p>18-0129 REED BLOCK GASKET Replaces: 27-657443, 27-657442, 27-657441, 27-65744 V-6</p>	 <p>18-0320 REED BLOCK GASKET Replaces: 27-13937-6</p>	 <p>18-0644 REED PLATE GASKET Replaces: 27-146972</p>															
 <p>18-0646 REED PLATE GASKET Replaces: 27-813859</p>	 <p>18-2501 18-2501-9^① REED BLOCK HOUSING GASKET Replaces: 27-935361, 27-93536, 27-67738 V-6</p>	 <p>18-2510 18-2510-9^① REED BLOCK HOUSING GASKET Replaces: 27-967611, 27-96761 V-200</p>	 <p>18-0624 ATTENUATOR GASKET Replaces: 27-188891</p> <table border="1" data-bbox="885 892 1412 997"> <thead> <tr> <th colspan="3">PKG. OF 5 CRANKCASE GASKETS</th> </tr> <tr> <th>Part #</th> <th>Replaces:</th> <th>Description</th> </tr> </thead> <tbody> <tr> <td>18-2512 ②</td> <td>27-60286</td> <td>Crankcase to Cyl. Block 3 Cyl.</td> </tr> <tr> <td>18-2513 ②</td> <td>27-11338, 27-67208</td> <td>Cyl. Block Sealing V-6</td> </tr> <tr> <td>18-2514 ②</td> <td>27-53650</td> <td>Crankcase to Cyl. Block 4 Cyl.</td> </tr> </tbody> </table>		PKG. OF 5 CRANKCASE GASKETS			Part #	Replaces:	Description	18-2512 ②	27-60286	Crankcase to Cyl. Block 3 Cyl.	18-2513 ②	27-11338, 27-67208	Cyl. Block Sealing V-6	18-2514 ②	27-53650	Crankcase to Cyl. Block 4 Cyl.
PKG. OF 5 CRANKCASE GASKETS																			
Part #	Replaces:	Description																	
18-2512 ②	27-60286	Crankcase to Cyl. Block 3 Cyl.																	
18-2513 ②	27-11338, 27-67208	Cyl. Block Sealing V-6																	
18-2514 ②	27-53650	Crankcase to Cyl. Block 4 Cyl.																	
 <p>18-0645 ADAPTER PLATE GASKET Replaces: 27-167371</p>	 <p>18-0105 BAFFLE GASKET Replaces: 27-85489-2</p>	 <p>18-0107 EXHAUST COVER GASKET Replaces: 27-85498-1, 27-85498, 27-64203, 27-72510 4 Cyl.</p>	 <p>18-0131 BAFFLE GASKET Replaces: 27-695252, 27-695251, 27-69525, 27-64857 3 Cyl.</p>	 <p>18-0133 WATER JACKET GASKET Replaces: 27-73665, 27-52892 4 Cyl.</p>															
 <p>18-0137 BAFFLE GASKET Replaces: 27-85492-2 50 HP</p>	 <p>18-0371 BAFFLE GASKET Replaces: 27-78409, 27-39316, 27-72915 20 HP</p>	 <p>18-0373 BAFFLE GASKET Replaces: 27-78411, 27-45088, 27-72917 20 HP</p>	 <p>18-0918 PLATE TO EXHAUST MANIFOLD GASKET Replaces: 27-695242, 27-695241, 27-69524 3 Cyl.</p>	 <p>18-2712 ADAPTER PLATE GASKET Replaces: 27-414181, 27-41418, 27-85979 For: 15-25 2 cyl</p>															
 <p>18-2621 BAFFLE GASKET Replaces: 27-139581 For: 100HP 4 cyl, 115HP 4 cyl</p>	 <p>18-2710 REED BLOCK GASKET Replaces: 27-414172, 27-414171, 27-41417, 27-85978 For: 15-25HP 2 cyl</p>	 <p>18-0380 THERMOSTAT GASKET Replaces: 27-83940M</p>	 <p>18-2721 THERMOSTAT GASKET Replaces: 27-827284 For: 30-60HP 3 cyl outboards</p>	 <p>18-2729 THERMOSTAT GASKET Replaces: 27-8128672 For: 30-40HP 2 cyl, 45 Jet, 50-60 3 cyl</p>															

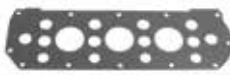
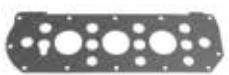
SEE PAGES 201-202 FOR OUR COMPLETE LINE OF GASKET SEALANTS

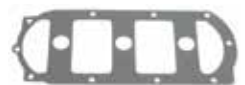

















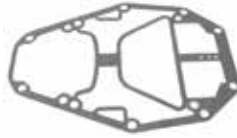

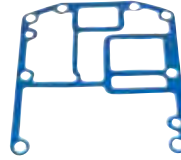

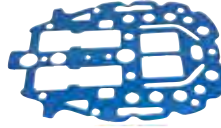





① Priced per Package

② This product is priced per piece. To order priced per package, please add -9 to the part number

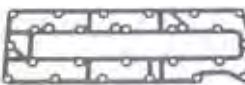
 <p>18-2749 THERMOSTAT GASKET Replaces: 27-8128671, 27-812867 For: 45 Jet, 50-60 HP 3 cyl</p>	 <p>18-3675 THERMOSTAT GASKET Replaces: 27-850318, 27-8503181 For: 200-250HP 3.0L, (DFI and EFI)</p>	<p>PKG. OF 2</p>  <p>18-0922 18-0922-9① BAFFLE GASKET Replaces: 27-703351, 27-70335 3 Cyl.</p>	 <p>18-0940 BAFFLE GASKET Replaces: 27-854882, 27-854881, 27-85488, 27-78027, 27-55308</p>	 <p>18-0942 BAFFLE GASKET Replaces: 27-85491-2, 27-854913, 27-854911, 27-85491, 27-72486, 27-46110 45/50 HP</p>
 <p>18-0944 BAFFLE GASKET Replaces: 27-854961, 27-85496, 27-64204, 27-72508</p>	 <p>18-0232 COVER GASKET Replaces: 27-81031M</p>	<p>PKG. OF 2</p>  <p>18-2573 18-2573-9① WATER JACKET GASKET Replaces: 27-721421, 27-72142, 27-60475 6 Cyl.</p>	<p>PKG. OF 2</p>  <p>18-2574 18-2574-9① EXHAUST COVER GASKET Replaces: 27-854952, 27-854951, 27-85495, 27-72507, 27-60476 6 Cyl.</p>	<p>PKG. OF 2</p>  <p>18-2836 18-2836-9① BAFFLE GASKET Replaces: 27-78035, 27-72919, 27-46233, 27-31439 7.5-10 HP</p>
<p>PKG. OF 2</p>  <p>18-2839 18-2839-9① EXHAUST COVER GASKET Replaces: 27-854972, 27-854971, 27-85497, 27-72509, 27-60477</p>	 <p>18-0151 DIVIDER PLATE GASKET Replaces: 27-76636, 27-75952 V-6</p>	 <p>18-0642 DIVIDER PLATE GASKET Replaces: 27-190503, 27-19050, 27-190502, 27-190505</p>	<p>PKG. OF 2</p>  <p>18-2502 18-2502-9① DIVIDER PLATE GASKET Replaces: 27-904841, 27-90484, 27-87396 V-6</p>	 <p>18-0870 TRANSFER PORT COVER GASKET Replaces: 27-279361, 27-27936</p>
 <p>18-0926 TRANSFER PORT COVER GASKET Replaces: 27-73645</p>	 <p>18-0932 TRANSFER PASSAGE COVER GASKET Replaces: 27-768621, 27-76862 3 Cyl.</p>	 <p>18-0946 TRANSFER PORT GASKET Replaces: 27-85653-1, 27-856730, 27-85653 6 Cyl.</p>	<p>PKG. OF 3</p>  <p>18-2838 18-2838-9① TRANSFER PORT COVER GASKET Replaces: 27-552791, 27-55279</p>	 <p>18-0372 CYLINDER BLOCK GASKET Replaces: 27-78410, 27-52579, 27-72916 20 HP</p>
 <p>18-2740 CYLINDER BLOCK GASKET Replaces: 27-430057, 27-430056, 27-430055, 27-430053, 27-430052, 27-430051 For: 65 Jet, 75HP 3 cyl, 90HP 3 cyl</p>	 <p>18-2943 CYLINDER BLOCK GASKET Replaces: 27-443281, 27-443282, 27-443283, 27-443284 For: 80 Jet, 100HP, 115HP, and 125HP 4 cyl outboards</p>	<p>PKG. OF 2</p>  <p>18-2500 18-2500-9① EXHAUST COVER GASKET Replaces: 27-85493, 27-72505, 27-52893 80 HP</p>	<p>PKG. OF 2</p>  <p>18-2505 18-2505-9① CYLINDER BLOCK GASKET Replaces: 27-961711, 27-96171 75-80 HP</p>	<p>PKG. OF 2</p>  <p>18-2507 18-2507-9① CYLINDER BLOCK GASKET Replaces: 27-85487, 27-78026, 27-72487, 27-37816 40-50 HP</p>
<p>PKG. OF 2</p>  <p>18-2805 18-2805-9① BLOCK COVER GASKET Replaces: 27-85490-2 35-40 HP</p>	<p>PKG. OF 2</p>  <p>18-2504 18-2504-9① BLOCK COVER GASKET Replaces: 27-88449, 27-76401, 27-74511, 27-60310 3 Cyl.</p>	<p>PKG. OF 2</p>  <p>18-2806 18-2806-9① CYLINDER COVER GASKET Replaces: 27-65788 V-6</p>	<p>PKG. OF 2</p>  <p>18-2807 18-2807-9① BLOCK COVER GASKET Replaces: 27-981853, 27-9818512, 27-981851, 27-98185, 27-85494, 27-72506, 27-64940, 27-53863 90-115 HP</p>	<p>PKG. OF 2</p>  <p>18-2808 18-2808-9① CYLINDER COVER GASKET Replaces: 27-96278 V-6</p>

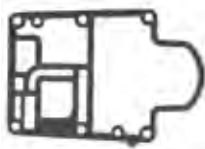











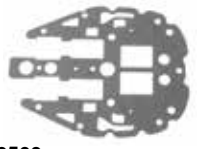

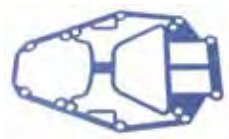

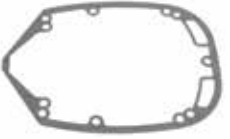
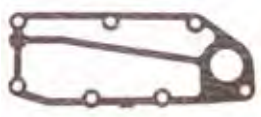





SEE PAGES 201-202 FOR OUR COMPLETE LINE OF GASKET SEALANTS

① Priced per Package

 <p>18-60917 CYLINDER COVER GASKET Replaces: 27-803508017 Fits: Mercury 8/9.9 (R042475 & Up)</p>	<p>PKG. OF 2</p>  <p>18-2810 18-2810-9① BLOCK COVER GASKET Replaces: 27-437772, 27-437771, 27-43777, 27-96483 45-50 HP</p>	<p>PKG. OF 2</p>  <p>18-2837 18-2837-9① BLOCK COVER GASKET Replaces: 27-41382, 27-78087, 27-72918, 27-66358, 27-31436</p>	 <p>18-0333 POWERHEAD BASE GASKET Replaces: 27-39401</p>	 <p>18-0334 MOUNTING PLATE TO DRIVESHAFT HOUSING GASKET Replaces: 27-39402</p>
 <p>18-0336 ADAPTER PLATE GASKET Replaces: 27-41670-3, 27-41670-5 18 HP</p>	 <p>18-0649 SHIFT ROD HOUSING GASKET Replaces: 27-858935 For: 200 HP T801000 & UP, 200 HP OPTIMAX DFI G438000 & UP, 225 HP EFI G438000 & UP, 225 HP OPTIMAX DFI G590000-G960499, 250 HP EFI G438000 & UP, (MODELS WITH "C-3 CASTING": 200 HP OPTIMAX DFI G386496-G437999, 225 HP D280813-G437999, 225 HP EFI G129222-G437999, 250 HP EFI G129222-G437999)</p>	 <p>18-0341 EXHAUST PLATE GASKET Replaces: 27-430086, 27-43008, 27-430082, 27-430083, 27-430085 For: 70-90, 100, 115 & 125 HP</p>	 <p>18-0791 SHIFT SHAFT COVER GASKET Replaces: 27-880729 For: All Verado's 135/150/175/200 225/250/275</p>	
 <p>18-0369 POWERHEAD BASE GASKET Replaces: 27-75909 V-6</p>	 <p>18-0378 POWERHEAD BASE GASKET Replaces: 27-823142, 27-823142 2</p>	 <p>18-0670 POWERHEAD BASE GASKET Replaces: 27-430075, 27-430073, 27-43007</p>	 <p>18-0385 POWERHEAD BASE GASKET Replaces: 27-89937, 27-31557, 27-30803, 27-45748 4.5-9.8 HP</p>	 <p>18-0643 POWERHEAD BASE GASKET Replaces: 27-18307-1, 27-183076</p>
 <p>18-0879 ADAPTER PLATE GASKET Replaces: 27-385011, 27-38501, 27-37724</p>	 <p>18-0904 POWERHEAD BASE GASKET Replaces: 27-60317 65 HP</p>	 <p>18-0135 ADAPTER COVER GASKET Replaces: 27-78246, 27-78246 1</p>	 <p>18-0103 POWERHEAD BASE GASKET Replaces: 27-796501, 27-79650, 27-37725, 27-72496</p>	 <p>18-0139 POWERHEAD BASE GASKET Replaces: 27-884511, 27-88451, 27-78623, 27-76589</p>
 <p>18-2735 DIVIDER PLATE GASKET Replaces: 27-190506 For: 140 Jet, 115-200HP (2.5L), XR-6</p>	 <p>18-2713 DRIVESHAFT HOUSING GASKET Replaces: 27-433374, 27-43337, 27-43337A1, 27-433371, 27-433372, 27-433373, 27-96286 For: 15-25 2 cyl</p>	 <p>18-2714 EXHAUST COVER GASKET Replaces: 27-414995, 27-414994, 27-414993, 27-414992, 27-892157 For: 15-25 HP, 2 Cyl.</p>	 <p>18-2716 EXHAUST COVER GASKET Replaces: 27-414991, 27-41499, 27-92332 For: 18XD, 20XD (2 cyl), 25XD</p>	 <p>18-2741 EXHAUST COVER PLATE GASKET Replaces: 27-430047, 27-430045, 27-430043, 27-430042, 27-430041, 27-4300409 For: 65 Jet, 75HP 3 cyl, 90HP 3 cyl</p>
 <p>18-2717 EXHAUST MANIFOLD GASKET Replaces: 27-414758, 27-414757, 27-414756, 27-414755, 27-414754, 27-414753, 27-414752, 27-414751, 27-41475, 27-92331, 27-892158 For: 15-25HP 2 cyl</p>	 <p>18-0319 POWERHEAD BASE GASKET Replaces: 27-828553 For: 30-60HP 2 cyl and 3 cyl</p>	 <p>18-2610 OUTER EXHAUST PLATE GASKET Replaces: 27-8127754, 27-812755 For: 80 Jet, 100HP, 115HP, and 125HP 4 cyl outboards</p>	 <p>18-2739 EXHAUST PLATE GASKET Replaces: 27-8329335, 27-8329334, 27-8329333, 27-8329332, 27-8329331, 27-832933006 For: 250XS (3.0L) DFI</p>	 <p>18-2611 INNER EXHAUST PLATE GASKET Replaces: 27-8127551, 27-8127755, 27-812755A01 For: 80 Jet, 100HP, 115HP, and 125HP 4 cyl outboards</p>















SEE PAGES 201-202 FOR OUR COMPLETE LINE OF GASKET SEALANTS

① Priced per Package

 <p>18-0912 DRIVE SHAFT HOUSING PLATE GASKET Replaces: 27-661021, 27-66102, 27-60945</p>	 <p>18-0934-1 POWERHEAD BASE GASKET Replaces: 27-78069</p>	 <p>18-0988 POWERHEAD BASE GASKET Replaces: 27-628601, 27-62860, 27-37976</p>	 <p>PKG. OF 2 18-2503 18-2503-9① DRIVE SHAFT HOUSING TO EXHAUST PLATE GASKET Replaces: 27-991771, 27-991772, 27-99177, 27-78068 V-6</p>	 <p>PKG. OF 2 18-2506-1 18-2506-1-9① EXHAUST PLATE GASKET Replaces: 27-991763, 27-991764, 27-991762, 27-99176 V-175/V-200</p>
 <p>PKG. OF 2 18-2508-1 18-2508-1-9① EXHAUST PLATE GASKET Replaces: 27-997761, 27-99776, 27-96440 V-135/V-150</p>	 <p>PKG. OF 2 18-2809 18-2809-9① BLOCK COVER GASKET Replaces: 27-437792, 27-437791, 27-43779, 27-96485 50-60-HP</p>	 <p>PKG. OF 2 18-2511 18-2511-9① DRIVE SHAFT HOUSING TO EXHAUST PLATE GASKET Replaces: 27-99173-2 V-6</p>	 <p>18-60919 EXHAUST COVER GASKET Replaces: 27-834952001 Fits: Mercury 8/9.9 (R042475 & Up)</p>	 <p>PKG. OF 2 18-2835 18-2835-9① POWERHEAD BASE GASKET Replaces: 27-692381, 27-69238, 27-66101, 27-64173, 27-60479 75-90-115-140 Hp</p>
 <p>18-0982-1 POWERHEAD GASKET Replaces: 27-56304, 27-48713</p>	 <p>18-60918 ENGINE BASE GASKET Replaces: 27-835427003 Fits: Mercury 8/9.9 (R042475 & Up)</p>	 <p>PKG. OF 2 18-0182 18-0182-9① THERMOSTAT GASKET Replaces: 27-62386</p>	 <p>18-0323 THERMOSTAT GASKET Replaces: 27-14318-2, 27-14318 3</p>	 <p>18-0339 THERMOSTAT GASKET Replaces: 27-43006-2, 27-430066 70-90 HP</p>
 <p>18-0835 THERMOSTAT GASKET Replaces: 27-824853, 27-8248531 Fits: Mercury 9.9-60 H.P., 4-Stroke</p>	 <p>PKG. OF 2 18-0914 THERMOSTAT GASKET Replaces: 27-66847</p>	 <p>18-60920 THERMOSTAT GASKET Replaces: 27-853702005 Fits: Mercury 8/9.9 (R042475 & Up)</p>	 <p>PKG. OF 2 18-0936 18-0936-9① RELIEF VALVE PLATE GASKET Replaces: 27-78690 V-6</p>	 <p>PKG. OF 2 18-0952 18-0952-9① RELIEF VALVE PLATE GASKET Replaces: 27-88907 V-6</p>
 <p>PKG. OF 2 18-2558 18-2558-9① IMPELLER GASKET Replaces: 27-19204-2 6/8/9.9/15</p>	 <p>18-0292 WEAR PLATE TO PUMP HOUSING GASKET Replaces: 27-81417M</p>	 <p>PKG. OF 2 18-0294 18-0294-9① WEAR PLATE TO PUMP BASE GASKET Replaces: 27-81421M</p>	 <p>PKG. OF 2 18-2559 18-2559-9① IMPELLER GASKET Replaces: 27-42206, 27-19202 6/8/9.9/15</p>	 <p>PKG. OF 2 18-2561 18-2561-9① IMPELLER GASKET Replaces: 27-85087 18/25 S/N 6443972 & Below</p>





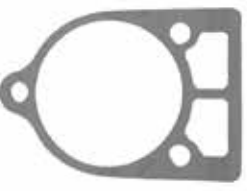















SEE PAGES 201-202 FOR OUR COMPLETE LINE OF GASKET SEALANTS

① Priced per Package

<p>PKG. OF 2</p>  <p>18-2564 18-2564-9① IMPELLER GASKET 70/75/80/90/100/115 Replaces: 27-430331, 27-43033</p>	<p>PKG. OF 2</p>  <p>18-2565 18-2565-9① IMPELLER GASKET 70/75/80/90/100/115 Replaces: 27-430472, 27-430471, 27-43047</p>	<p>PKG. OF 2</p>  <p>18-2566 18-2566-9① IMPELLER GASKET 75/90/100/115 Replaces: 27-817277, 27-8172771</p>	<p>PKG. OF 2</p>  <p>18-2562 18-2562-9① IMPELLER GASKET 18/20/25 S/N 6443973 & Above Replaces: 27-993261, 27-99326</p>
<p>PKG. OF 2</p>  <p>18-2563 18-2563-9① IMPELLER GASKET 70/75/80/90/100/115 Replaces: 27-430341, 27-43034</p>	<p>PKG. OF 2</p>  <p>18-2801 18-2801-9① WATER PUMP GASKET Replaces: 27-32438 4-6 Cyl.</p>	<p>PKG. OF 2</p>  <p>18-2823 18-2823-9① LOWER, WATER PUMP GASKET Replaces: 27-32769, 27-19553 40-50-70 HP</p>	<p>PKG. OF 2</p>  <p>18-2824 18-2824-9① UPPER, WATER PUMP GASKET Replaces: 27-32770, 27-19551</p>
<p>PKG. OF 2</p>  <p>18-2825 18-2825-9① WATER PUMP BASE GASKET Replaces: 27-32771 40-50-70</p>	<p>PKG. OF 2</p>  <p>18-2826 18-2826-9① WATER PUMP BASE GASKET Replaces: 27-85610 1, 27-85670 4</p>	<p>PKG. OF 2</p>  <p>18-2827 18-2827-9① UPPER FACE PLATE GASKET Replaces: 27-39623 20 HP</p>	<p>PKG. OF 2</p>  <p>18-2828 18-2828-9① LOWER WATER PUMP GASKET Replaces: 27-39625 20 HP</p>
<p>18-0622 LOWER WEAR PLATE GASKET Replaces: 27-19701</p> 	<p>18-2593 WATER PUMP GASKET Replaces: 27-194541 For: 45 Jet, 50HP, 55HP, 60HP 3 cyl outboards</p> 	<p>18-0345 WATER PUMP GASKET Replaces: 27-822189 For: 25-60HP outboards, 2, 3 cyl. & 4 stroke models</p> 	<p>PKG. OF 2</p> <p>18-2841 18-2841-9① WATER PUMP BASE GASKET Replaces: 27-77417, 27-19552</p> 

SEE PAGES 201-202 FOR OUR COMPLETE LINE OF GASKET SEALANTS

① Priced per Package

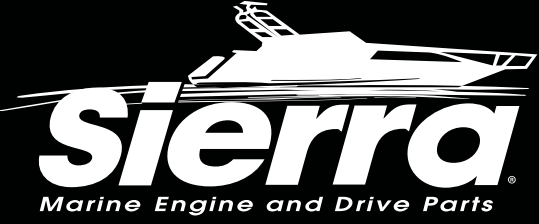
<p>PKG. OF 2</p>  <p>18-2914 18-2914-9① WATER PUMP GASKET Replaces: 27-856081, 27-85608, 27-32433, 27-30603, 27-8M0090319</p>	<p>PKG. OF 2</p>  <p>18-2915 18-2915-9① WATER PUMP GASKET Replaces: 27-856091, 27-858524, 27-85609, 27-32434, 27-30604</p>	<p>PKG. OF 2</p>  <p>18-2919 18-2919-9① WATER PUMP GASKET Replaces: 27-426311, 27-42631</p>	 <p>18-0514 WATER TUBE RUBBER SEAL Replaces: 26-25329</p>
 <p>18-0521 WATER TUBE RUBBER SEAL Replaces: 26-36557</p>	 <p>18-0563 WATER TUBE RUBBER SEAL Replaces: 26-36556</p>	 <p>18-0539 EXHAUST LEG RUBBER SEAL Replaces: 37721</p>	 <p>18-2728 WATER TUBE SEAL Replaces: 26-42102, 26-421021</p>
<p>PKG. OF 2</p>  <p>18-2560 18-2560-9① IMPELLER GASKET Replaces: 12-86645, 12-866451, 8M0027721 18/20/25</p>	<p>PKG. OF 5</p>  <p>18-2430 18-2430-9① 18-24301-9① (PKG. OF 50) DRAIN SCREW GASKET Replaces: 26-830749 For: All Verado</p>	<p>PKG. OF 2</p>  <p>18-2945 18-2945-9① DRAIN SCREW GASKET Replaces: 12-20260, 12-19183, 12-191832, 191833, F50556, F8077, F8186 Used in most lower units and sea water pumps</p>	<p>PKG. OF 2</p>  <p>18-2948 18-2948-9① RUBBER WASHER Replaces: 12-492211, 12-49221, 12-23245 For plastic flush screw and fuel tank vent</p>
 <p>18-4261 WASHER Replaces: 19643</p>	<p>PKG. OF 4</p>  <p>18-0568-9③ INSULATOR BUSHING Replaces: 23-43045</p>	 <p>18-8305 DIVIDER PLATE SEAL Replaces: 26-814754, 428381, 42838, 69668, 88726</p>	 <p>18-4698 18-46981-9① (PKG. OF 50) DRAIN FILL WASHER Replaces: 27-81987, 27-81987M</p>
 <p>18-4275 WASHER Replaces: 12-29245, 12-824793, 12-38753, 12-32733, 12-25945, 12-22388</p>	<p>PKG. OF 2</p>  <p>18-4858-9① WASHER Replaces: 12-45176 Fits: Mercury Outboard 25 H.P. and Up, Mercruiser #1, R, MR, Alpha I Gen II and Bravo Drive Units</p>	 <p>18-8309 WATER COOLED REGULATOR SEAL Replaces: 18717</p>	<p>PKG. OF 2</p>  <p>18-2730-9① GROMMET Replaces: 26-80239M</p>
 <p>18-2731 GROMMET Replaces: 26-81607M For: 28 HP</p>			

SEE PAGES 201-202 FOR OUR COMPLETE LINE OF GASKET SEALANTS

① Priced per Package

35 & 40 2 Cylinder

Serial # 2736807-G053313

50, 60, 65 3 Cylinder

Serial # 3293184-D000749

70 3 Cylinder

Serial # 4571652-6428680

40, 45, 50 4 Cylinder

Serial # 4357640 & later

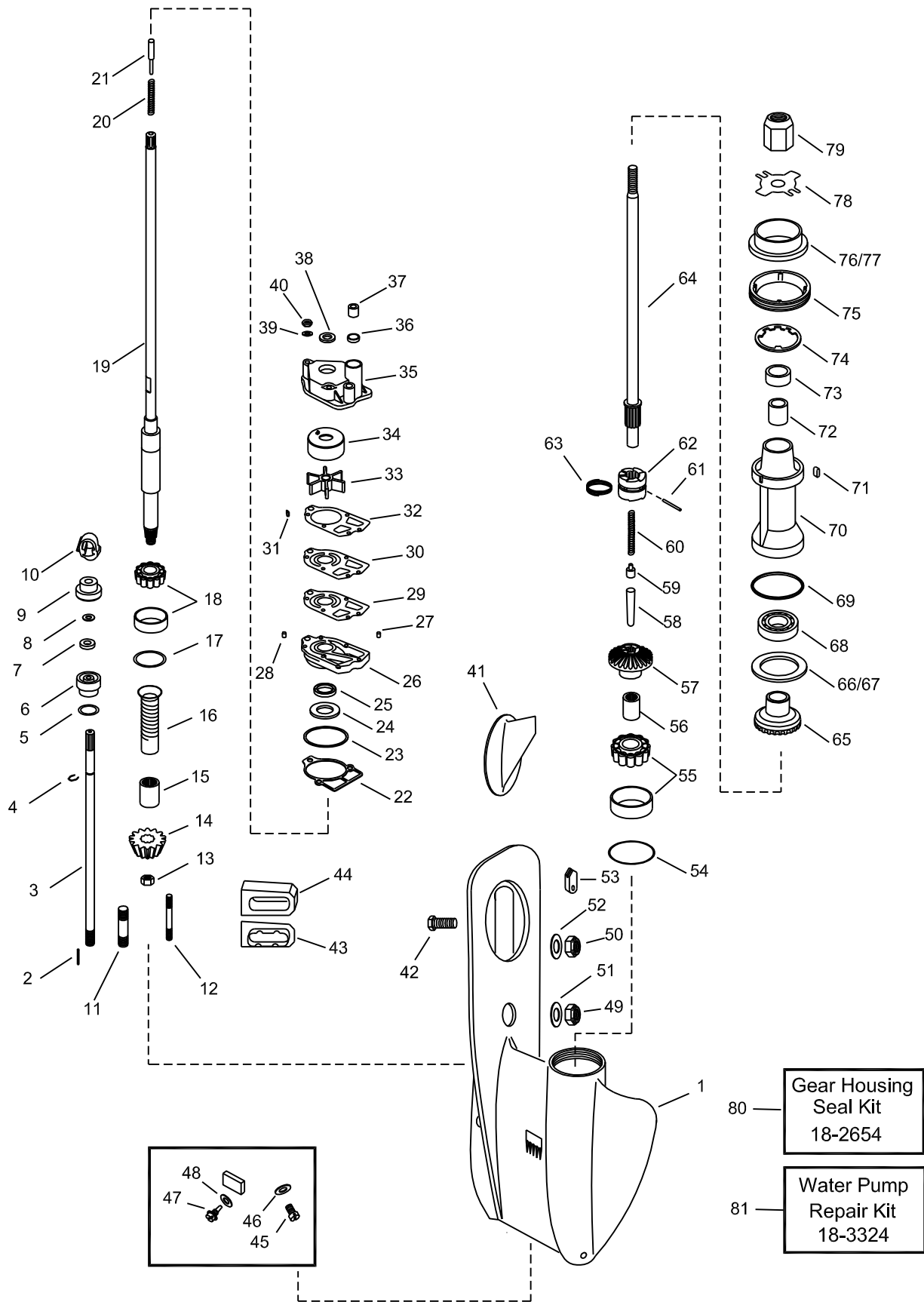

Figure #	Description	Part #	O.E.M. #	Qty.	Figure #	Description	Part #	O.E.M. #	Qty.
1	Gear Housing	—	1643-9539A1	1	48	Flush Plug Washer	18-2948	12-492211	1
2	Dowel Pin	—	17-85500	2	49	Nut	18-2361	11-34933	1
3	Shift Shaft	—	76163A1	1	50	Nut	—	1134863	1
4	E-Clip	18-4295	53-29641	1	51	Washer	—	12-65791	1
5	O-Ring	18-7153	25-25439	1	52	Washer	—	12-45175	1
6	Shift Shaft Bushing	18-2155	23-77631A2	1	53	Shift Cam	—	76039	1
7	Seal	18-2054	26-816461	1	54	Shim Set	—	15-38374A1	AR
8	Washer	18-2316	12-77674	1	55	Tapered Roller Bearing	18-1162	31-38356A1	1
9	Reverse Lock Base	—	78036	1	56	Roller Bearing	18-1096	31-21739	1
10	Reverse Lock Cam	—	433081	1	57	Forward Gear	—	43-55608A4	1
11	Stud	—	16-33778	3	58	Cam Follower	—	38441	1
12	Stud	—	16-57933	2	59	Slide	—	20843	1
13	Pinion Nut	—	11-55910	1	60	Spring	—	24-38114	1
14	Pinion Gear	—	43-98097	1	61	Cross Pin	—	17-38113	1
15	Roller Bearing	—	31-62091	1	62	Clutch	—	52-92911	1
16	Sleeve	—	88181	1	63	Spring	—	24-39845	1
17	Shim Set	—	15-92881A1	AR	64	Prop Shaft	—	44-75365	1
18	Tapered Bearing	—	31-77420A1	1	65	Reverse Gear	—	43-79158	1
19	Drive Shaft	—	45-981801	1	66	Thrust Washer	—	12-32004	1
20	Spring	—	24-20254	1	67	Shim Set	—	15-20927A1	AR
21	Pin	—	17-30545	1	68	Ball Bearing	18-1190	30-20839T	1
22	Gasket	18-2841	27-19552	1	69	O-Ring	18-7160	2531986	1
23	O-Ring	18-7115	25-26722	1	70	Bearing Carrier	—	69386A1	1
24	Seal	18-2055	26-79831	1	71	Key	—	28-30281	1
25	Seal	18-2011	26-90562	1	72	Roller Bearing	—	3121700	1
26	Water Pump Base	18-3424	46-77177A1	1	73	Seal	18-2051, 18-2052	26-69188, 26-619189	1
27 & 28	Pin, Dowel	—	17-35973	1					
29	Gasket	18-2823	27-19553	1	74	Tab Washer	—	14-53012	1
30	Face Plate	18-3107	54705	1	75	Cover Nut	—	11-87763	1
31	Key	—	28-56662	1	76	Thrust Hub	18-4233	73345A1	1
32	Gasket	18-2824	27-19551	1	77	Thrust Hub	18-3204	14-76281	1
33	Impeller	18-3007	47-89983	1	78	Tab Washer	18-3204	14-76281	1
34	Insert	18-3115	48753	1	79	Nut	18-3702	11-69578A	1
35	Water Pump body	18-3118	46-77822A1	1	80	Gear Housing Seal Kit	18-2654	26-79831A1	1
36	Nylon Washer	—	12-38453	1	81	Water Pump Repair Kit	18-3324	46-77177A3	1
37	Seal	—	26-38452	1					
38	Slinger	—	25-20273	1					
39	Washer	18-4275	12-29245	3					
40	Nut	—	11-13438	3					
41	Trim Tab	18-6011	31640A1	1					
42	Screw	—	10-66024	1					
43	Support Plate	—	92815	1					
44	Exhaust Tube Seal	18-0539	37721	1					
45	Drain Plug	18-2244	10-79953	2					
46	Washer	18-2945	12-19183	2					
47	Flush Plug	—	19-48750	1					

AR As required

Figure #	Description	Part #	O.E.M. #	Qty.	Figure #	Description	Part #	O.E.M. #	Qty.
1	Gear Housing	—	1667-9011A73	1	49	Spring	—	24-30622	1
2	Screw	—	10-8248327	4	50	Clutch	18-2236	52-822539	1
3	Washer	18-4275	12-29245	4	51	Cross Pin	18-2357	17-30632	1
4	Insulator	18-0568	23-43045	4	52	Spring	18-2348	24-30893	1
5	Water Pump Housing	18-3572	817275A2	1	53	Prop Shaft	—	44-12238T	1
6	Impeller	18-3056	47-430262	1	54	Reverse Gear	—	43-12635	1
7	Impeller Key	18-3293	28-43037	1	55	O-Ring	18-7961	25-97386	1
8	Gasket	18-2566	27-817277	1	56	Thrust Bearing	18-1112	31-12576	1
9	Face Plate	18-3122	817276	1	57	Thrust Washer	18-1191	12-12577	1
10	Gasket	18-2564	27-430331	1	58	Roller Bearing	18-1113	31-12578	1
11	Screw	—	10-824832-6	6	59	Bearing Carrier	—	12596A2	1
12	Washer	18-4275	12-29245	6	60	Washer	—	12-70132	2
13	Pump Base	—	43055A4	1	61	Nut	—	11-401198	2
14	Seal	18-0583	26-43035	1	62	Roller Bearing	18-1158	31-30956	1
15	Seal	18-0522	26-43036	1	63	Seal	18-2002	26-76868	1
16	Gasket	18-2565	27-430472	1	64	Seal	18-2053	26-70081	1
17	Carrier w/Bearing	—	43040A1	1	65	Thrust Washer	18-4221	13191A1	1
18	Tube, Oiler	—	43046	1	66	Tab Washer	18-3200	14-31210	1
19	Sleeve	—	42461A1	1	67	Prop Nut	18-3700	11-52707	1
20	Ring	—	42461A1	1					
21	Drive Shaft	—	45-43031A1	1					
22	Shim Assembly	—	15-44492A1	AR					
23	Race (sold with #24)	18-1118	31-42677A1	1					
24	Bearing (sold with #23)	18-1118	31-42677A1	1					
25	Pinion Gear	—	43-44484	1					
26	Pinion Nut	18-3719	11-35921	1					
27	Seal	18-2054	26-8164641	1					
28	Bushing Assembly	—	23-43052A4	1					
29	Screw	—	10-824832-6	2					
30	O-Ring	18-7198	25-45710	1					
31	E-Ring	18-4295	53-29641	1					
32	Shift Shaft	—	43048A1	1					
33	Gasket	18-2945	12-19183	3					
34	Plug	—	10-28653	1					
35	Plug	18-2244	10-79953	1					
36	Plug	18-2375	22-67892A1	1					
37	Trim Tab	18-6011	31640A1	1					
38	Bolt, Anode Mounting	18-6245	10-15942	1					
39	Washer, Anode Mounting	18-4858-9	12-45176	1					
40	Shim Cam	—	76039	1					
41	Shim Assembly	—	15-44491A1	AR					
42 & 43	Bearing & Race	18-1156	13-30894A1	1					
44	Roller Bearing	18-1157	31-30895	1					
45	Forward Gear	—	43-12634A2	1					
46 & 47	Cam Follower Assembly	—	12239A1	1					
48	Ball Bearing	—	30-44530	3					

AR As required

V-150

Serial # A904645 & earlier

V-175

Serial # 6648750 & earlier

V-200

Serial # 6625220 & earlier

86 — Gear Housing Seal Kit
18-2653

87 — Water Pump Repair Kit
(with housing)
18-3217

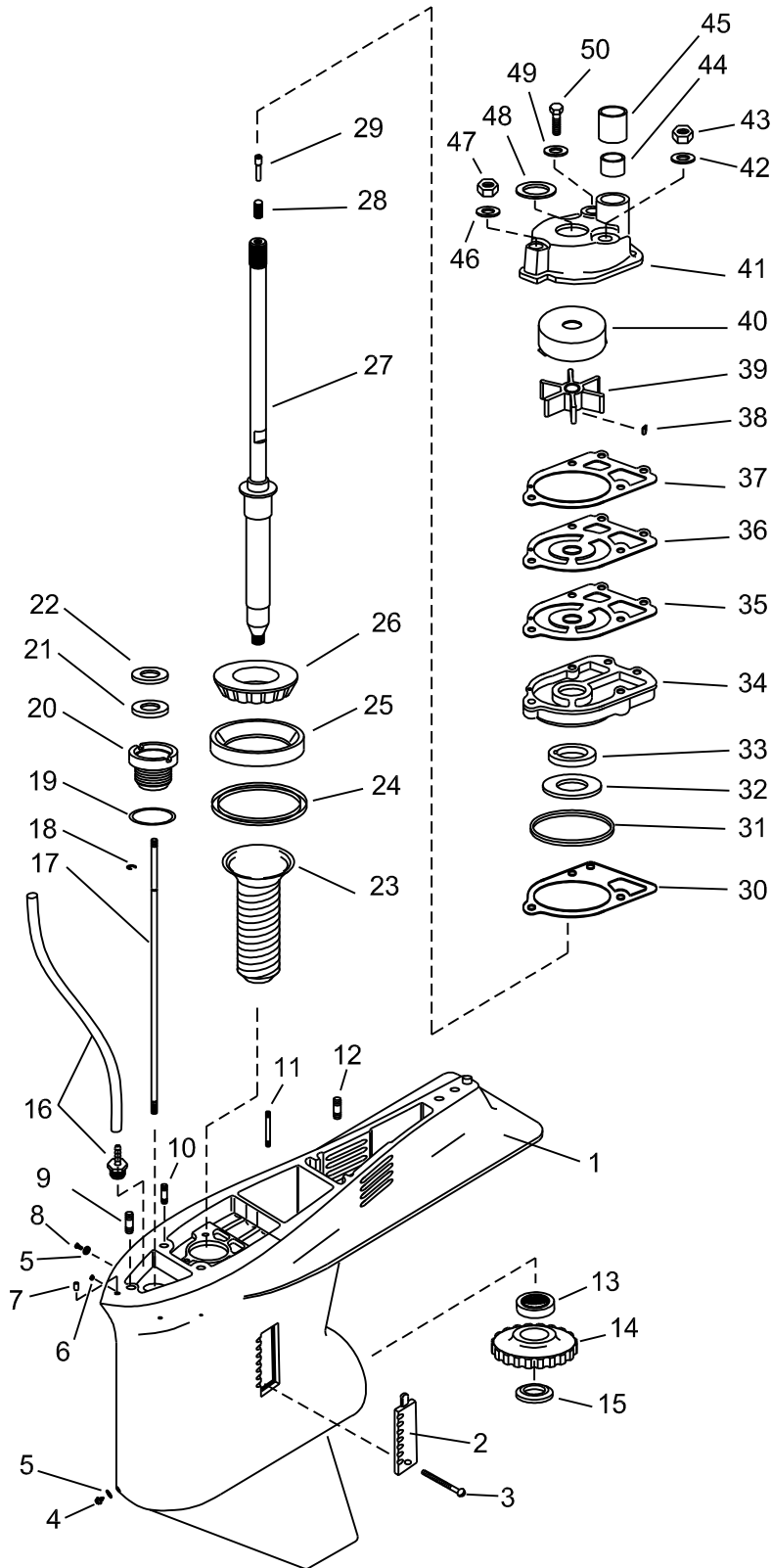

Complete Gear Housings Listed on Page 437

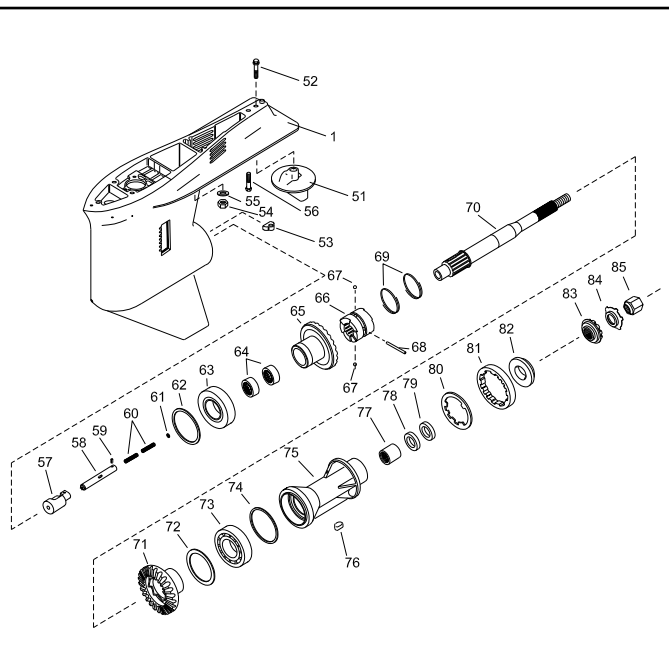





















Figure #	Description	Part #	O.E.M. #	Qty.
34	Water Pump Base	18-3416	46-96146A6	1
35	Gasket	18-2914	27-856081	1
36	Face Plate	18-3117	32435	1
37	Gasket	18-2915	27-856091	1
38	Key	~	28-56654	1
39	Impeller	18-3017	47-899842	1
40	Insert	18-3114	48752	1
41	Water Pump Body	18-3116	43-96148A1	1
42	Washer	18-4275	12-29245	3
43	Nut	18-3722	11-20361	2
44	Seal	18-3110	26-38970	1
45	Guide Sleeve	18-3109	23-29804	1
46	Washer	18-4270	12-36001	1
47	Nut	18-3722	11-45592	1
48	Slinger	18-7426	25-30271	1
49	Washer	18-4275	12-29245	3
50	Screw	~	10-96411	1
51	Trim Tab	18-6011	3164A1	1
52	Screw	~	10-66024	1
53	Shift Cam	~	78956	1
54	Nut	18-3721	11-34933	1
55	Washer	~	12-45176	2
56	Screw	~	10-65210	1
57	Cam Follower	~	89594A1	1
58	Actuator Rod	~	79911 1	1
59	Locating Pin	~	17-78906	1
60	Spring	~	24-749910	2
61	Washer	~	12-78910	1
62	Shim Assembly	18-2285	15-47397A1	AR
63	Bearing	18-1166	31-78172A1	1
64	Forward Gear	~	43-78082A3	1
65	Roller Bearing	18-1122	31-73363	2
66	Clutch	~	52-823174	1
67	Detent Pin	~	17-78909	2
68	Cross Pin	~	17-78905	1
69	Retaining Spring	~	24-78962	2
70	Prop Shaft	18-2239	44-94148	1
71	Reverse Gear	~	43-85462	1
72	Thrust Ring	~	68100 1	1
73	Ball Bearing	18-1155	30-88957	1
74	O-Ring	18-7159	25-31534	1
75	Bearing Carrier	18-1567	43567T1	1
76	Key	~	28-30281	1
77	Roller Bearing	18-1158	31-30956	1
78	Seal (Inner)	18-2002	26-76868	1
79	Seal (Outer)	18-2053	26-70081	1
80	Tab Washer	18-2299	14-79447	1
81	Cover Nut	18-3751	79448	1
82	Thrust Hub	18-4220	13171	1
83	Spline Washer	18-3714	12-31211A2	1
84	Tab Washer	18-3200	14-31210	1
85	Prop Nut	18-3700	11-52707	1

Figure #	Description	Part #	O.E.M. #	Qty.
1	Gear Housing	~	1647-9148A65	1
2	Water Insert (Starboard)	~	66885	1
	Water Insert (Port)	~	66884	1
3	Screw	18-3197	10-76156	1
4	Drain Screw	18-2375	22-67892A1	1
5	Washer	18-2945	12-19183	2
6	Nut	18-2344	11-45812	1
7	Dowel Pin	~	17-43044	2
8	Vent Screw	18-2244	10-79953	1
9	Stud	~	16-78638	1
10	Stud	~	16-56297	1
11	Stud	~	16-30667	2
12	Stud	~	16-579201	2
13	Roller Bearing	~	31-35934A1	1
14	Pinion Gear	~	43-780811	1
15	Pinion Nut	18-3719	11-35921	1
16	Speedometer Tube	~	22-85822A10	1
17	Shift Shaft	~	78902 2	1
18	E-Clip	18-4295	53-29641	1
19	O-Ring	18-7153	25-25439	1
20	Shift Shaft Bushing	18-2155	23-77631A2	1
21	Seal	18-2054	26-816461	1
22	Rubber Washer	18-2316	12-77674	1
23	Sleeve	~	23-98621	1
24	Shim Assembly	18-2295	15-57007A1	AR
25	Roller Bearing	~	31-53079A1	1
26	Roller Bearing	~	31-53079A1	1
27	Drive Shaft Assembly	~	45-98682A1	1
28	Spring	~	24-34576	1
29	Pin	~	17-30545	1
30	Gasket	18-2826	27-856101	1
31	O-Ring	18-7162	25-33145	1
32	Seal	18-2014	26-89238	1
33	Seal	18-2013	26-16977	1

AR As required

 <p>18-1190 BALL BEARING Replaces: 30-20839T, 30-20839, 30-62699, FI000034 Reverse gear for Force, Mercury, Mariner from 25-60HP (2, 3 cylinders, & 4-stroke) including 30Jet - 45Jet</p>	 <p>18-1191 THRUST WASHER Replaces: 12-12577 30-125HP</p>	 <p>18-1111 REVERSE GEAR BEARING Replaces: 31-62799A1</p>	 <p>18-1112 REVERSE GEAR THRUST BEARING Replaces: 31-12576</p>
 <p>18-1113 REVERSE GEAR BEARING Replaces: 31-12578, 31-12578T</p>	 <p>18-1115 PINION BEARING Replaces: 31-32898, 31-32898T, 31-29982</p>	 <p>18-1117 PINION BEARING Replaces: 31-42647A1, 31-42647, 31-F694057</p>	 <p>18-1118 DRIVE SHAFT BEARING Replaces: 31-42677A1</p>
 <p>18-1122 INSIDE FORWARD GEAR BEARING Replaces: 31-73363, 31-73363T</p>	 <p>18-1143 TAPERED ROLLER BEARING Replaces: 31-36387A1</p>	 <p>18-1144 BEARING ASSEMBLY Replaces: 31-48939A2</p>	 <p>18-1153 BALL BEARING Replaces: 30-63326, 30-63326T, 30-49313, 30-54215, 30-20464</p>
 <p>18-1154 BALL BEARING Replaces: 30-63742, 30-63742T</p>	 <p>18-1155 BALL BEARING Replaces: 30-88957A1, 30-88957T, 30-35914, 30-17927, 30-88957</p>	 <p>18-1347 MAIN BEARING Replaces: 31-88269T For: 250/275/3.4L</p>	 <p>18-1156 FORWARD GEAR BEARING Replaces: 31-30894A1</p>
 <p>18-1197 TAPERED FORWARD GEAR BEARING Replaces: 31-828439A2 For: Alpha One Gen II (1996-97) (s/n 0F680000-0K999999)</p>	 <p>18-1157 FORWARD GEAR INNER BEARING Replaces: 31-30895, 31-30895T</p>	 <p>18-1158 CARRIER BEARING Replaces: 31-30956, 31-30956T, 31-F523058</p>	 <p>18-1159 TAPERED ROLLER BEARING Replaces: 31-35928A1, 31-35928T1</p>

APPLICATION BEGINS ON NEXT PAGE

Model	Serial Number	Bearing (Drive Shaft)	Bearing Pinion	Inside Bearing Forward Gear	Outside Bearing Forward Gear	Bearing Reverse Gear	Thrust Bearing Reverse Gear	Bearing Model Carrier
30 (4-stroke, Bigfoot)	G760300 & Up	18-1118	—	18-1157	18-1156	18-1113	18-1112	18-1158
30 (4-stroke, non-Bigfoot)	G760300 & Up	—	—	—	18-1107	—	—	—
30 EFI (4-stroke, Bigfoot)	T409000 & Up	18-1118	—	18-1157	18-1156	18-1113	18-1112	18-1158
30 EFI (4-stroke, non-Bigfoot)	T409000 & Up	—	—	—	18-1107	—	—	—
35 (2 cyl.)	6445653 & Up	—	—	—	18-1162	—	N/A	—
350	1960827 - 2874703	—	—	18-1162	—	N/A	—	—
400 (2 cyl.)	2874704 - 3336257	—	—	—	18-1162	—	N/A	—
402	3336258 - 4117709	—	—	—	18-1162	—	N/A	—
402	4117710 - 4860102	—	—	—	18-1162	—	N/A	—
402/40 (2 cyl.)	4860103 - 5556229	—	—	—	18-1162	—	N/A	—
40 (2 cyl.)	5556230 - G053313	—	—	—	18-1162	—	N/A	—
40 (4 cyl.)	C159200 & Up	—	—	—	18-1162	—	N/A	—
40 (4-stroke, Bigfoot)	G231123 & Up	18-1118	—	18-1157	18-1156	18-1113	18-1112	18-1158
40 (4-stroke, non-Bigfoot)	G231123 & Up	—	—	—	18-1107	—	—	—
40 (4-stroke, 4 cyl. Bigfoot)	T228405 & Up	18-1118	—	18-1157	18-1156	18-1113	18-1112	18-1158
40 (4-stroke, 4 cyl. non-Bigfoot)	T228405 & Up	—	—	—	18-1170	—	—	—
40 EFI (4-stroke, 3 cyl. non-Bigfoot)	T409000 & Up	—	—	—	18-1103	18-1190	—	—
40 EFI (4-stroke, 3 cyl. Bigfoot)	T409000 & Up	18-1118	—	18-1157	18-1156	18-1113	18-1112	18-1158
40 EFI (4-stroke, 4 cyl. non-Bigfoot)	T409000 & Up	—	—	—	18-1170	—	—	—
45 (4 cyl.)	5531630 & Up	—	—	—	18-1162	—	N/A	—
45 (Bodensee 4-stroke, Bigfoot)	G231123 - T178499	18-1118	—	18-1157	18-1156	18-1113	18-1112	18-1158
45 (Bodensee 4-stroke, non-Bigfoot)	G231123 - T178499	—	—	—	18-1103	—	—	—
500	2305101 - 2858813	—	—	—	18-1162	—	N/A	—
500	2858814 - 4140999	—	—	—	18-1162	—	N/A	—
500	4141000 - 4357639	—	—	—	18-1162	—	N/A	—
500 / 50	4357640 - 4962055	—	—	—	18-1162	—	N/A	—
500 / 50	4962056 - 5531629	—	—	—	18-1162	—	N/A	—
50 (4 cyl.)	5531630 & Up	—	—	—	18-1162	—	N/A	—
50 (3 cyl.)	6428681 - D000749	—	—	—	18-1162	—	N/A	—
50 (3 cyl.)	D000750 - G589999	—	—	—	18-1170	—	N/A	—
50 (4-stroke, Bigfoot)	G231123 & Up	18-1118	—	18-1157	18-1156	18-1113	18-1112	18-1158
50 (4-stroke, non-Bigfoot)	G231123 & Up	—	—	—	18-1107	—	—	—
50 EFI (4-stroke, non-Bigfoot)	T409000 & Up	—	—	—	18-1107	—	—	—
50 EFI (4-stroke, Bigfoot)	T409000 & Up	18-1118	—	18-1157	18-1156	18-1113	18-1112	18-1158
55 (3 cyl.)	D000750 - G589999	—	—	—	18-1170	—	N/A	—
55 Seapro, Marathon, Pontoon	D000750 & Up	18-1118	—	18-1157	18-1156	18-1113	18-1112	18-1158
60 (3 cyl.)	6428681 - D000749	—	—	—	18-1162	—	N/A	—
60 (3 cyl.)	D000750 - G589999	—	—	—	18-1170	—	N/A	—
60 EFI (4-stroke, non-Bigfoot)	T409000 & Up	—	—	—	18-1103	—	—	—
60 EFI (4-stroke, Bigfoot)	T409000 & Up	18-1118	—	18-1157	18-1156	18-1113	18-1112	18-1158
650 (4 cyl.)	1542745 - 1765403	18-1153	—	18-1157	18-1156	—	N/A	18-1158
650 (4 cyl.)	2119749 - 2309310	18-1153	—	18-1157	18-1156	—	N/A	18-1158
650 (4 cyl.)	2309311 - 2452709	18-1153	—	18-1157	18-1156	—	N/A	18-1158
650 (4 cyl.)	2503991 - 2803561	18-1153	—	18-1157	18-1156	—	N/A	18-1158
650 (4 cyl.)	2803562 - 2874263	—	—	18-1157	18-1156	—	N/A	18-1158
650 (4 cyl.)	2997339 & Up	—	—	18-1157	18-1156	—	N/A	18-1158
650 (3 cyl.)	3293184 - 3525440	—	—	—	18-1162	—	N/A	—
650 (3 cyl.)	3547987 - 4571651	—	—	—	18-1162	—	N/A	—
70 (3 cyl.)	4571652 - 4977156	—	—	—	18-1162	—	N/A	—
70 (3 cyl.)	4977157 - 5579016	—	—	—	18-1162	—	N/A	—
70 (3 cyl.)	5579017 - 6428680	—	—	—	18-1162	—	N/A	—
70 (3 cyl.)	A996142 - & Up	18-1118	N/A	18-1157	18-1156	18-1113	18-1112	18-1158
75 (4 cyl.)	6432901 & Up	—	—	18-1157	18-1156	N/A	N/A	18-1158
75 (3 cyl.)	A996142 - & Up	18-1118	N/A	18-1157	18-1156	18-1113	18-1112	18-1158
800 (4 cyl.)	2559001 - 3144218	18-1153	—	18-1157	18-1156	—	N/A	18-1158
800 (4 cyl.)	3144219 - 3493912	—	—	18-1157	18-1156	—	N/A	18-1158
80 (4 cyl.)	4831999 - 6432900	—	—	18-1157	18-1156	N/A	N/A	18-1158
80 (3 cyl.)	A996142 & Up	18-1118	N/A	18-1157	18-1156	18-1113	18-1112	18-1158
850 (4 cyl.)	3493913 - 4831998	—	—	18-1157	18-1156	—	N/A	18-1158
900 (6 cyl.)	1766824 - 1869775	18-1153	—	18-1157	18-1156	—	N/A	18-1158
900/90 (6 cyl.)	4845301 - & Up	—	—	18-1157	18-1156	N/A	N/A	18-1158
90 (3 cyl.)	A996142 & Up	18-1118	N/A	18-1157	18-1156	18-1113	18-1112	18-1158

① Standard Rotation Only.

③ For Units With A Casting Number Of 1655-9572C Only.

④ For Units With A Casting Number Of 1674-814247C Only.

⑤ Two Bearings Required.

⑥ For 5/8 Dual Bearing Application.

⑦ Use 18-1155 For Counter Rotation Applications.

⑧ Using pinion stamped 43-19672.

Model	Serial Number	Bearing (Drive Shaft)	Bearing Pinion	Inside Bearing Forward Gear	Outside Bearing Forward Gear	Bearing Reverse Gear	Thrust Bearing Reverse Gear	Bearing Model Carrier
100 (4 cyl.)	B209468 - & Up	18-1118	N/A	18-1157	18-1156	18-1113	18-1112	18-1158
1150	2836019 - 2933900	18-1153	—	18-1157	18-1156	—	N/A	18-1158
1150	2933901 - 3525440	18-1153	—	18-1157	18-1156	—	N/A	18-1158
1150	3525441 - 4112634	18-1153	—	18-1157	18-1156	—	N/A	18-1158
1150	4112635 - 4855152	—	—	18-1157	18-1156	—	N/A	18-1158
1150 / 115	4855153 - 5314655	—	—	18-1157	18-1156	N/A	N/A	18-1158
115 (6 cyl.)	5314656 - 5600966	—	—	18-1157	18-1156	N/A	N/A	18-1158
115 (6 cyl.)	5600967 - 6436122	—	—	18-1157	18-1156	N/A	N/A	18-1158
115 (6 cyl.)	6436123 & Up	—	—	18-1157	18-1156	N/A	N/A	18-1158
115 (4 cyl.)	C100000 & Up	18-1118	N/A	18-1157	18-1156	18-1113	18-1112	18-1158
125 (4 cyl.)	0T627234 & Below ⑥	18-1118	N/A	18-1157	18-1156	18-1113	18-1112	18-1158
1250	2314956 - 2839368	18-1153	—	18-1157	18-1156	—	N/A	18-1158
1350	2839369 - 2940020	18-1153	—	18-1157	18-1156	—	N/A	18-1158
1350	2940021 - 3293233	18-1153	—	18-1157	18-1156	—	N/A	18-1158
1400	3293234 - 3502805	18-1153	—	18-1157	18-1156	—	N/A	18-1158
140	4865687 & Up	—	—	18-1157	18-1156	N/A	N/A	18-1158
1500	3502806 - 4121434	18-1153	—	18-1157	18-1156	—	N/A	18-1158
1500	4121435 - 4865677	—	—	18-1157	18-1156	—	N/A	18-1158
V-135	A904646 & Up	18-1143	18-1117	18-1122 ⑤	18-1166	18-1155	N/A	18-1158
V-135	C100861 & Up	18-1143	18-1117	18-1122 ⑤ ①	18-1166 ① ⑦	18-1155 ①	N/A	18-1158
V-135	C239553 & Up	18-1143	18-1117	18-1122 ⑥ ①	18-1166 ① ⑦	18-1155 ①	N/A	18-1158
V-135	D082000 & Up	18-1143	18-1117	18-1115 ①	18-1166 ① ⑦	18-1155 ①	N/A	18-1158
V-150	4868998 - 5432021	—	—	18-1122 ⑤	18-1166	18-1155	N/A	18-1158
V-150	5432022 - 6042945	—	—	18-1122 ⑤	18-1166	18-1155	N/A	18-1158
V-150	6042946 - 6443212	—	—	18-1122 ⑤	18-1166	18-1155	N/A	18-1158
V-150	6443213 - 6616990	—	—	18-1122 ⑤	18-1166	18-1155	N/A	18-1158
V-150	6616991 - A904645	—	—	18-1122 ⑤	18-1166	18-1155	N/A	18-1158
V-150	A904646 & Up	18-1143	18-1117	18-1122 ⑤	18-1166	18-1155	N/A	18-1158
V-150	C100861 & Up	18-1143	18-1117	18-1122 ⑤ ①	18-1166 ①	18-1155	N/A	18-1158
V-150	C239553 & Up	18-1143	18-1117	18-1122 ⑤ ①	18-1166 ① ⑦	18-1155 ①	N/A	18-1158
V-150	D082000 & Up	18-1143	18-1117	18-1115 ①	18-1166 ① ⑦	18-1155 ①	N/A	18-1158
V-150XRI (EFI)	D082000 & Up	18-1143	—	18-1157	18-1156 ①	N/A	N/A	18-1158
V-150XRI (EFI)	D082000 & Up	18-1143	18-1117	18-1115 ⑤ ①	18-1166 ① ⑦	18-1155 ①	N/A	18-1158
V-150XRI (EFI)	D082000 & Up	18-1143	18-1117	18-1115 ⑤ ①	18-1166 ① ⑦	18-1155 ①	N/A	18-1158
V-175	4301235 - 5393736	—	—	18-1122 ⑤	18-1166	18-1155	N/A	18-1158
V-175	5393737 - 6618750	—	—	18-1122 ⑤	18-1166	18-1155	N/A	18-1158
V-175	6618751 & Up	18-1143	18-1117	18-1122 ⑤	18-1166	18-1155	N/A	18-1158
V-175	C100861 & Up	18-1143	18-1117	18-1122 ⑤ ①	18-1166 ① ⑦	18-1155 ①	N/A	18-1158
V-175	C239553 & Up	18-1143	18-1117	18-1122 ⑥ ①	18-1166 ① ⑦	18-1155 ①	N/A	18-1158
V-175	D082000 & Up	18-1143	18-1117	18-1115 ①	18-1166 ① ⑦	18-1155 ①	N/A	18-1158
V-175XRI (EFI)	D000750 & Up	18-1143	18-1117	18-1122 ⑤ ⑥	18-1166	18-1155	N/A	18-1158
V-175XRI (EFI)	D000750 & Up	18-1143	18-1117	18-1122 ⑤ ⑥	18-1166	18-1155	N/A	18-1158
V-175XRI (EFI)	D082000 & Up	18-1143	—	18-1157	18-1156 ①	N/A	N/A	18-1158
V-175XRI (EFI)	D082000 & Up	18-1143	18-1117	18-1115 ⑤ ①	18-1166 ① ⑦	18-1155 ①	N/A	18-1158
V-175XRI (EFI)	D082000 & Up	18-1143	18-1117	18-1115 ⑤ ①	18-1166 ① ⑦	18-1155 ①	N/A	18-1158
V-200	4839034 - 5363917	—	—	18-1122 ⑤	18-1166	18-1155	N/A	18-1158
V-200	5363918 - 6073191	—	—	18-1122 ⑤	18-1166	18-1155	N/A	18-1158
V-200	6073192 - 6203990	—	—	18-1122 ⑤	18-1166	18-1155	N/A	18-1158
V-200	6203991 - 6435502	—	—	18-1122 ⑤	18-1166	18-1155	N/A	18-1158
V-200	6435503 - 6625220	—	—	18-1122 ⑤	18-1166	18-1155	N/A	18-1158
V-200	6625221 - C100860	18-1143	18-1117	18-1122 ⑤	18-1166	18-1155	N/A	18-1158
V-200/								
V-200 (EFI)	C100861 - C291519	18-1143	18-1117	18-1122 ⑤	18-1166	18-1155	N/A	18-1158
V-200 (2.5L)	C291520 - D081999	18-1143	18-1117	18-1122 ⑥ ①	18-1166 ① ⑦	18-1155 ①	N/A	18-1158
V-200	D082000 & Up	18-1143	18-1117	18-1115 ①	18-1166 ① ⑦	18-1155 ①	N/A	18-1158
V-200XRI (EFI)	C291520 & Up	18-1143	18-1117	18-1122 ⑤	18-1166	18-1155	N/A	18-1158
V-200XRI (EFI)	D082000 & Up	18-1143	—	18-1157	18-1156 ①	N/A	N/A	18-1158
V-200XRI (EFI)	D082000 & Up	18-1143	18-1117	18-1115 ⑤ ①	18-1166 ① ⑦	18-1155 ①	N/A	18-1158
V-200XRI (EFI)	D082000 & Up	18-1143	18-1117	18-1115 ⑤ ①	18-1166 ① ⑦	18-1155 ①	N/A	18-1158
V-220	B117316 & Up	18-1143	18-1117	18-1122 ⑤	18-1166	18-1155	N/A	18-1158
V-225	5628028 & Up	—	—	18-1122 ⑤	18-1166	18-1155	N/A	18-1158
225	D280813 & Up	18-1143	18-1117	18-1157 ①	18-1159 ①	18-1155 ①	N/A	18-1158
XR-4 ③	B242885 & Up	18-1143	—	18-1157	18-1156	N/A	N/A	18-1158
XR-4	B242885 & Up	18-1143	—	18-1157	18-1156	N/A	N/A	18-1158
XR-4 ③	C100861 & Up	18-1143	—	18-1157	18-1156	N/A	N/A	18-1158
XR-4 ④	C100861 & Up	18-1143	—	18-1157	18-1156	N/A	N/A	18-1158
XR-4	C239553 & Up	18-1143	—	18-1157	18-1156	N/A	N/A	18-1158
XR-6	D082000 & Up	18-1143	—	18-1157	18-1156	N/A	N/A	18-1158

① Standard Rotation Only.

③ For Units With A Casting Number Of 1655-9572C Only.

④ For Units With A Casting Number Of 1674-814247C Only.

⑤ Two Bearings Required.

⑥ For 5/8 Dual Bearing Application.

⑦ Use 18-1155 For Counter Rotation Applications.

⑧ Using pinion stamped 43-19672.



18-2244
18-22441-9①
(PKG. OF 50 WITHOUT GASKET)
DRAIN PLUG
• 3/8" -16 thread
Replaces: 10-20259, 10-28634, 10-28634A1, 10-79953A2, 10-79953Q2, 10-79953, 10-79953Q04, 816610A1, 816610A2, F40109, 10-F50109
Includes gasket **18-2945**



② 18-2375D
18-2375
18-23751-9①
(PKG. OF 50 WITHOUT GASKET)
DRAIN PLUG
• 3/8" -16 thread
Replaces: 10-14834, 10-14834A1, 22-67892, 22-67892A1, 22-67892A05, 22-67892A06, 28-8M0058389
Includes gasket **18-2945**



18-2155
SHIFT SHAFT HOUSING BUSHING
Replaces: 23-37428A1, 23-55419A1, 23-77631A2 35-200 HP

① Priced per Package

② Items ending in "D" are Display Packaged - Regular number is Non-Display



18-3719
PINION NUT
Replaces: 11-35921, 11-47411,
 11-826375, 11-F694188
 5/8" - 18 thread • 1 1/16" wrench



18-2359
DRIVE SHAFT NUT SET
 — INCLUDES —

Sierra #	Description	Replaces:
18-3719	Pinion Nut	11-35921
18-2343	Pinion Nut Washer	12-92721
18-2343-9 ②	Pinion Nut Washer	12-92721

② Priced per Package



18-1736
DRIVESHAFT ASSEMBLY
Replaces: 45-43031A1
Fits: 100 4 cyl (1988 & Up), 115 4 cyl (1989 & Up),
 125 4 cyl (1994 & Up)



18-1737
DRIVESHAFT (32 1/4" long)
Replaces: 45-440001
Fits: V-115 DFI 2.5L (2000), V-135 (1986 & Up), V-135 DFI 2.5L (1998 & Up), V-150 (1978 & Up), V-150 EFI (1996-01), V-150 Mag/EFI (1993-95), V-150 DFI 2.5L (1998 & Up), V-150 Mag (1980-85), V-175 (1976-99), V-175 EFI (1996 & Up), V-175 Mag/EFI (1991-95), V-175 DFI 2.5L (2001 & Up), V-175 XRI EFI (1991-95), V-200 (1978 & Up), V-200 EFI (1989-01), V-200 Mag/EFI (1992-95), V-200 DFI 2.5L (2002 & Up), V-200 XRI/EFI (1991-95), XR-4 (1988-91), XR-6 (1992 & Up)



18-2239
PROP SHAFT
Replaces: 44-94148



18-2254
PROP SHAFT
Replaces: 44-850308



18-2260
PROP SHAFT
Replaces: 44-17915



18-2236
SLIDING CLUTCH
Replaces: 52-12777, 52-34239, 52-814756,
 52-822539, 52-822539T



18-1550
COMPLETE GEAR SET
Replaces: 43-850036T,
 43-881260A3, 52-850048T
 Forward, Pinion, Reverse and Clutch for 4 cyl.: Fits: 100 4 cyl with 6 JAW reverse clutch(1988-98), 115 4 cyl with 6 JAW reverse clutch(1989-98), 125 4 cyl with 6 JAW reverse clutch(1994-98) (2.07:1 Ratio)



18-1551
COMPLETE GEAR SET
Replaces: 43-803615T2,
 52-859340T, 43-828175A1
 Forward, Pinion, Reverse and Clutch for V-6:
Fits: V-150 (XR6, Mag III)(1997 & Up), V-150 EFI (1997 & Up), V150 DFI (1998 & Up), V-175 (1997 & Up), V-175 EFI (1997 & Up), V-175 DFI (2001 & Up), V-200 (1997 & Up), V-200EFI 2.5L (1997 & Up) (1.87:1 Ratio)



18-1560
REVERSE GEAR
Replaces: 43-850036T, 43-850036
Fits: 75 4-Stroke (2000-02), 90 4-Stroke (2000-02), 100 4 cyl with 6 JAW Rev Clutch (1988 & Up), 115 4 cyl with 6 JAW Rev Clutch (1989 & Up), 115 4-Strk EFI (2001 & Up), 125 4 cyl with 6 JAW Rev Clutch (1994 & Up) (2.07:1 Ratio)



18-1562
CLUTCH
Replaces: 52-850048T, 53-850048
Fits: 40 4-Stroke 4cyl Bigfoot(2001 & Up), 50 4-Stroke Bigfoot (1995 & Up), 60 3 cyl with 6 JAW Rev (1998 & Up), 60 4-Stroke Bigfoot (2001 & Up), 70 3 cyl with 6 JAW Rev Clutch (1987 & Up), 75 3 cyl with 6 JAW Clutch (1990-98), 75 3 cyl (1999 & Up), 75 4-Stroke 1596cc (2000-03), 80 3 cyl with 6 JAW Rev Clutch (1987 & Up), 90 3 cyl with 6 Jaw Rev Clutch (1987-98), 90 3 cyl (1999 & Up), 90 4-Stroke 1596cc (2000-03), 100 4 cyl w 6 JAW Rev Clutch (1988-98), 100 4 cyl (1999 & Up), 115 4 cyl with 6 JAW Rev Clutch (1989-98), 115 4 cyl (1999 & Up), 115 4-Stroke 1741cc (2001-03), 125 4 cyl with 6 JAW Rev Clutch (1994-98), 125 4 cyl (1999 & Up)



18-1564
GEAR SET
Replaces: 43-803615T2, 43-803615T1
Fits: V-150 (1978 & Up), V-150 EFI (1996-01), V-150 DFI 2.5L (1998 & Up), V-150 EFI 2.5L (2002 & Up), V-175 EFI (1996-01), V-175 DFI 2.5L (2001 & Up), V-175 EFI 2.5L (2002-03), V-200 (1978 & Up), V-200 EFI (1989-01), V-200 EFI 2.5L (2002 & Up) (1.87:1 Ratio)

18-1565
CLUTCH

Replaces: 52-859340T

Fits: V-115 DFI 2.5L (2000), V-135 (1986 & Up), V-135 DFI 2.5L (1998 & Up), V-150 (1978 & Up), V-150 EFI (1996-01), V-150 Mag/EFI (1993-95), V-150 DFI 2.5L (1998 & Up), V-150 Mag (1980-85), V-175 (1976-99), V-175 EFI (1996 & Up), V-175 Mag/EFI (1991-95), V-175



18-1566
REVERSE GEAR

Replaces: 43-828175A1

Fits: V-150 (1978 & Up), V-150 EFI (1996-01), V-150 DFI 2.5L (1998 & Up), V-175 (1976-99), V-175 EFI (1996-01), V-175 DFI 2.5L (2001 & Up), V-200 (1978 & Up), V-200 EFI (1989-01), V-200 EFI 2.5L (2002 & Up), XR-6 (1992-99) **(1.87:1 Ratio)**



18-4830
GEAR HOUSING ASSEMBLY

Replaces: 1667-9011G59

Fits: 100 4cyl (1988-99), 115 4cyl (1989 & Up), 115 3cyl DFI (2004 & Up), 115 EFI 4-Stroke(2001 & Up), 125 4cyl (1994 & Up), 30 4-Stroke (1999-01), 30 Carb 3cyl 4-Stroke (2002 & Up), 40 4-Stroke (1998-01), 40 4-Stroke 4cyl (2001-02), 40 Carb 3cyl 4-Stroke (2002 & Up), 40 EFI 4cyl 4-Stroke (2002 & Up), 40 Jet (2001 & Up), 45 Jet (1994-98), 50 4-Stroke (1995-00), 50 4cyl 4-Stroke (2001-02), 50 Bigfoot 4-Stroke(1995-00), 50 EFI 4cyl 4-Stroke (2002 & Up), 55 3cyl (1996 & Up), 60 3cyl (1984 & Up), 60 3cyl Bigfoot (1998), 60 4cyl 4-Stroke (2001-02), 60 EFI 4cyl 4-Stroke (2002 & Up), 65 Jet (1994 & Up), 75 3cyl (1987 & Up), 75 4-Stroke (2000 & Up), 75 3cyl 1.5L DFI (1995 & Up), 80 Jet (1994 & Up), 90 3cyl (1987 & Up), 90 4-Stroke (2000 & Up), 90 3cyl 1.5L DFI (2004 & Up) with 6 Jaw Clutch (Design II)



18-4832
GEAR HOUSING ASSEMBLY

Replaces: 1647-9148T93

Fits: 140 Jet (All), Magnum III (1992-99), V-115 DFI 2.5L (2000), V-135 (1986 & Up), V-135 DFI 2.5L (1998 & Up), V-150 (1978 & Up), V-150 EFI (1996-01), V-150 DFI 2.5L (1998 & Up), V-175 (1976-99), V-175 EFI (1996-01), V-175 DFI 2.5L (2001 & Up), V-200 (1978 & Up), V-200 EFI (1989-01), V-200 EFI 2.5L (2002 & Up), XR6 (1992 & Up)



18-4850
COMPLETE GEARCASE

Replaces: 1667-9011G77, 1667-9011G78, 1667-9011G10, 1667-9011G11, 1667-9011G51, 1667-9011J6, 1667-9011R6

Fits: 100/115/125 4-cyl with 6 Jaw Clutch (Design II) (2.07:1 Ratio)



18-4851
COMPLETE GEARCASE

Replaces: 1647-6693A3, 1647-7350A5, 1647-7350A26, 1647-8688A1, 1647-9148A69, 1647-9148A8, 1647-9148A84, 1647-9148T84, 1647-9148R84

Fits: 135/150/200/225 V6 (1.87:1 Ratio)



MERCURY OUTBOARD LOWER UNIT APPLICATIONS

Model	Serial Number	Drive Shaft	Pinion Nut	Propeller Shaft	Clutch
40 Four Stroke - BigFoot	0T178500 - 1B226999		18-3719	18-2254	18-1562
50 Four Stroke - BigFoot	0G231123 - 1B226999		18-3719	18-2254	18-1562
60 Sea Pro/Marathon/BigFoot	0G590000 & UP		18-3719	18-2254	18-1562 ④
60 Four Stroke - BigFoot	0T178500 - 1B226999		18-3719	18-2254	18-1562
650 (4 cyl.)	1542745 - 1765403	N.L.A.	—	—	18-2236
650 (4 cyl.)	2119749 - 2309310	—	—	—	18-2236
650 (4 cyl.)	2309311 - 2452709	—	18-3719	—	18-2236
650 (4 cyl.)	2503991 - 2803561	—	18-3719	—	18-2236
650 (4 cyl.)	2803562 - 2874263	—	18-3719	—	18-2236
650 (4 cyl.)	2997339 & Up	—	18-3719	—	18-2236
70 (3 cyl.)	A996142 - & Up	—	18-3719	—	18-2236 ⑤
70 (3 cyl.)	A996142 - & Up	—	18-3719	18-2254	18-1562
75 (4 cyl.)	6432901 & Up	—	18-3719	—	18-2236
75 (3 cyl.)	A996142 - & Up	—	18-3719	—	18-2236 ⑤
75 (3 cyl.)	A996142 - 0G760299	—	18-3719	18-2254	18-1562
75 (3 cyl.)	0G760300 & Up	—	18-3719	18-2254	18-1562
75 DFI	0T980000 & Up	—	18-3719	18-2254	18-1562
75 Four Stroke	0G960500 - 0T800999	—	18-3719	18-2254	18-1562
800 (4 cyl.)	2559001 - 3144218	—	18-3719	—	18-2236
800 (4 cyl.)	3144219 - 3493912	—	18-3719	—	18-2236
80 (4 cyl.)	4831999 - 6432900	—	18-3719	—	18-2236
80 (3 cyl.)	A996142 & Up	—	18-3719	—	18-2236 ⑤
80 (3 cyl.)	A996142 & Up	—	18-3719	18-2254	18-1562 ④
850 (4 cyl.)	3493913 - 4831998	—	18-3719	—	18-2236
900 (6 cyl.)	1766824 - 1869775	N.L.A.	—	—	18-2236
900/90 (6 cyl.)	4845301 - & Up	—	18-3719	—	18-2236
90 (3 cyl.)	A996142 - 0G760299	—	18-3719	—	18-2236 ⑤
90 (3 cyl.)	A996142 - 0G760299	—	18-3719	18-2254	18-1562 ④
90 (3 cyl.)	0G760300 & Up	—	18-3719	18-2254	18-1562
90 DFI	0T801000 & Up	—	18-3719	18-2254	18-1562
90 Four Stroke	0G960500 - 0T800999	—	18-3719	18-2254	18-1562

① Long shaft only ③ Offshore only ⑤ 3 Jaw reverse clutch N.L.A. No longer available
 ② Standard rotation only ④ 6 Jaw reverse clutch ⑥ Pre-load pin, w/o driveshaft nut

APPLICATION CONTINUED ON NEXT PAGE

MERCURY OUTBOARD LOWER UNIT APPLICATIONS

Model	Serial Number	Drive Shaft	Pinion Nut	Propeller Shaft	Clutch
100 (4 cyl.)	B209468 - 0G760299	—	18-3719	—	18-2236 ⑤
100 (4 cyl.)	B209468 - 0G760299	—	18-3719	18-2254	18-1562 ④
100 (4 cyl.)	0G760300 & Up	—	18-3719	18-2254	18-1562
1150	2836019 - 2933900	—	18-3719	—	18-2236
1150	2933901 - 3525440	—	18-3719	—	18-2236
1150	3525441 - 4112634	—	18-3719	—	18-2236
1150	4112635 - 4855152	—	18-3719	—	18-2236
1150 / 115	4855153 - 5314655	—	18-3719	—	18-2236
115 (6 cyl.)	5314656 - 5600966	—	18-3719	—	18-2236
115 (6 cyl.)	5600967 - 6436122	—	18-3719	—	18-2236
115 (6 cyl.)	6436123 & Up	—	18-3719	—	18-2236
115 (4 cyl.)	C100000 - 0G760299	—	18-3719	—	18-2236 ⑤
115 (4 cyl.)	C100000 - 0G760299	—	18-3719	18-2254	18-1562 ④
115 (4 cyl.)	0G760300 & Up	—	18-3719	18-2254	18-1562
115 DFI	0T801000 & Up	—	18-3719	18-2254	18-1562
115 Four Stroke	0T178500 - 0T800999	—	18-3719	18-2254	18-1562
1250	2314956 - 2839368	—	18-3719	—	18-2236
125 (4 cyl.)	0D283222 - 0G760299	—	18-3719	—	18-2236 ⑤
125 (4 cyl.)	0D283222 - 0G760299	—	18-3719	18-2254	18-1562 ④
125 (4 cyl.)	0G760300 & Up	—	18-3719	18-2254	18-1562
1350	2839369 - 2940020	—	18-3719	—	18-2236
1350	2940021 - 3293233	—	18-3719	—	18-2236
1400	3293234 - 3502805	—	18-3719	—	18-2236
140	4865687 & Up	—	18-3719	—	18-2236
1500	3502806 - 4121434	—	18-3719	—	18-2236
1500	4121435 - 4865677	—	18-3719	—	18-2236
V-135	0A904646 - 0G437999	18-1737	18-3719	18-2239	—
V-135	0G438000 - 0T178499	18-1737	18-3719	18-2239 ②	—
V135 DFI	G590000 - 1B417701	18-1737	18-3719	18-2239	18-1565
V140	T178500 & Up	—	18-3719	18-2239	—
V-150 (Casting # 1647-6670C)	4868998 - 0A904645	—	18-3719	—	—
V-150 (Casting #1647-8675C)	4868998 - 0A904645	—	18-3719	18-2239	—
V-150	4868998 - 0A904645	18-1737	18-3719	18-2239	—
V-150	0A904646 - 0G437999	18-1737	18-3719	18-2239	—
V-150	0G438000 & Up	18-1737	18-3719	18-2239	18-1565
V-150 XR-4 (Casting #1655-9572C)	B242885 - 0D081999	—	18-3719	—	18-2236
V-150 XR-4 (Casting #1674-814247C)	B242885 - 0D081999	—	18-3719	—	18-2236
V-150 XR-6	D082000 - 0G303045	18-1737	18-3719	18-2239	18-2236
V-150 XR-6	0G438000 & Up	18-1737	18-3719	18-2239	18-1565
V-150XRI (EFI)	D082000-0G437999	18-1737	18-3719	— ②	18-2236 ②
V-150XRI (EFI)	0G438000 & Up	18-1737	18-3719	18-2239 ②	18-1565
V150 DFI	G590000 & Up	18-1737	18-3719	18-2239	—
V-175	4301235 - 5393736	— ⑥	18-3719	—	—
V-175	5393737 - 6618750	— ⑥	18-3719	18-2239	—
V-175	6618751 - 0G437999	18-1737	18-3719	18-2239	—
V-175	0G438000 & Up	18-1737	18-3719	18-2239	18-1565
V-175XRI (EFI)	D000750 - 0G437999	18-1737	18-3719	18-2239	—
V-175XRI (EFI)	0G438000 & Up	18-1737	18-3719	18-2239	18-1565
V-200	4839034 - 6625220	— ⑥	18-3719	18-2239	—
V-200	6625221 - 0G437999	18-1737	18-3719	18-2239	—
V-200	0G438000 & Up	18-1737	18-3719	18-2239	18-1565
V-200 (EFI)	C100861 - 0G437999	18-1737	18-3719	18-2239	—
V-200 (EFI)	0G438000 & Up	18-1737	18-3719	18-2239	18-1565
V-200 (2.5L)	C291520 - D081999	—	18-3719	18-2239 ②	—
V-200 DFI	0G438000 & Up	—	18-3719	—	18-1565
V-220	B117316 & Up	—	18-3719	18-2239	—
V-225	5628028 & Up	— ①	18-3719	18-2239	—
225	D280813 & Up	—	18-3719	—	—
HIGH PERFORMANCE MODELS					
2.4 EFI	B290010 & Up	—	18-3719	18-2260 ② ③	—
XR-2	B290314 - C276429	—	18-3719	18-2260 ②	—
MOD-VP	B290066 - C276379	—	18-3719	18-2260	—

- ① Long shaft only ③ Offshore only ⑤ 3 Jaw reverse clutch N.L.A. No longer available
 ② Standard rotation only ④ 6 Jaw reverse clutch ⑥ Pre-load pin, w/o driveshaft nut

PKG. OF 10

18-0202-9®
INSERT

Replaces: 8227731
Fits: Mercury/Mariner
25-125hp Outboards



18-3751
SPANNER NUT
Replaces: 79448
For: V-6



18-2298
TAB WASHER
Replaces: 14-18323, 14-17460



18-2299
TAB WASHER
Replaces: 14-79447, 14-52833



STAINLESS STEEL
LOCKNUTS

Part #	O.E. #	Thread Size	Std. Pkg.
*18-3720 ⑦	11-34932	3/8" - 24	1
*18-3721 ⑦	11-34933, 11-95702, 11-82671015, 11-46355, 11-33962, 11-29241, 11-24648, 11-22178, 11-21298	7/16" - 20	6
*18-3722 ⑦	11-35888, 11-20361, 11-8267089	1/4" - 28	5
*18-3723 ⑦	11-45592	5/16" - 24	1

*To order locknuts in packages of 5, add -9 to end of part number

⑦ Priced per package

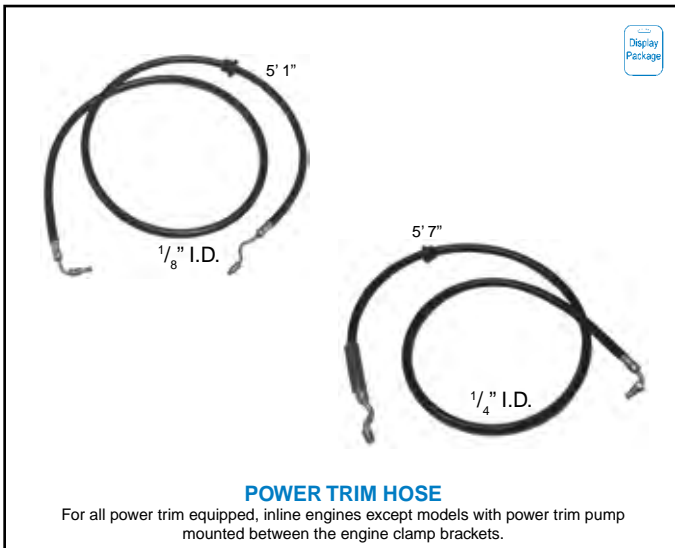

POWER TRIM HOSE

For all power trim equipped, inline engines except models with power trim pump mounted between the engine clamp brackets.

Part #	Replaces:	Description
18-2110	32-45327, 32-88005, 32-97153A1	Small Diameter 2 required per engine
18-2111	32-88006, 32-45959, 32-97154A1	Large Diameter 2 required per engine



**18-3701
PROP NUT KIT**
Replaces: 11-52707A1, 11-52707A2, 11-52707Q1
—CONTAINS—

Part #	O.E. #	Description
18-3200 (2)	14-31210, 14-816629	Tab Washer
18-3700	11-52707	Prop Nut



**18-3200
18-3200-9②
TAB WASHER**
Replaces: 14-31210, 14-816629, 14-816629Q, 14-F697140



**18-3702
PROP NUT KIT**
Replaces: 11-69578A1, T1, Q1
—CONTAINS—

Part #	O.E. #	Description
18-3204 (2)	14-76281	Tab Washer
18-3704	11-69578	Prop Nut



**18-3204
18-3204-9②
TAB WASHER**
Replaces: 14-76281



**18-3700
PROP NUT**
Replaces: 11-52707, 11-52707A1, 11-52707Q1, 11-52707A2, 11-827614 F7040



**18-3704
PROP NUT**
Replaces: 11-69578



**18-3703
PROP NUT**
Replaces: 11-88228
For: 9.9-25 HP 1986-Up



**18-3714
BRASS CASTLE WASHER**
Replaces: 12-31211A2, 12-31211, 12-31211A3, 12-31211Q03
For: 135-275 HP (V6 2 cycle)

TAB WASHER/PROP NUT/PROP NUT KIT APPLICATION

HP	Beg. S/N	End. S/N	Tab Washer	Prop Nut	Prop Nut Kit	HP	Beg. S/N	End. S/N	Tab Washer	Prop Nut	Prop Nut Kit
9.9 ④	G760300	& UP	—	18-3703	—	80	2559001	& UP	18-3200	18-3700	18-3701
15 ④	G590000	& UP	—	18-3703	—	85	1460999	3493912	18-3200	—	—
18	5837437	& UP	—	18-3703	—	85	3493913	4831998	18-3200	18-3700	18-3701
20	6443973	& UP	—	18-3703	—	90	1766824	4845300	18-3200	—	—
25	6416713	& UP	—	18-3703	—	90	4845301	& UP	18-3200	18-3700	18-3701
35	— ③	—	18-3204	18-3704	18-3702	95	1869776	2318585	18-3200	—	—
40	— ③	—	18-3204	18-3704	18-3702	100	1464949	2484632	18-3200	—	—
50	— ③	—	18-3204	18-3704	18-3702	100	2484633	2836018	18-3200	18-3700	18-3701
60	— ③	—	18-3204	18-3704	18-3702	100	B209468	& UP	18-3200	18-3700	18-3701
65	1542745	2503990	18-3200	—	—	110	1870204	2314955	18-3200	—	—
65	2503991	3293183	18-3200	18-3700	18-3701	115	2836019	& UP	18-3200	18-3700	18-3701
70	1482212	1566239	18-3200	—	—	125	2314956	2536209	18-3200	—	—
70	— ③	A996141	18-3204	18-3704	18-3702	125	2536210	2839368	18-3200	18-3700	18-3701
70	A996142	& UP	18-3200	18-3700	18-3701	135	2839369	3293233	18-3200	18-3700	18-3701
75	6432901	& UP	18-3200	18-3700	18-3701	140	3293234	& UP	18-3200	18-3700	18-3701
80	1405637	1566239	18-3200	—	—	150(Inline)	3502806	& UP	18-3200	18-3700	18-3701
③ Fits most applications ④ 4-Stroke Bigfoot						V-6	All	—	18-3200	18-3700	18-3701



**18-4444
PROP WRENCH**
Replaces: 91-95830A1, 91-95830, 91-38277A1



**18-4446
PROP WRENCH KIT**
— CONTAINS —

Part #	Desc.	O.E. #	Qty.
18-3200	Tab Washer	14-31210, 14-816629	2
18-3700	Prop Nut	11-52707	1
18-4444	Prop Wrench	91-95830A1	1



**18-4459
PROP WRENCH**
Replaces: 91-821887A1, 91-859046Q4, 91-859046T4

① Items ending in "D" are Display Packaged - Regular number is Non-Display
② Priced per Package



**18-9075
SPACER**
Replaces: 23-888690
For: 2-Stroke: 115hp. - 300hp. (1993-Current)
4-Stroke: 115hp. - 225hp. (2002-Current)



**18-9076
COLLAR**
Replaces: 23-888690-1
For: 2-Stroke: 115hp. - 300hp. (1993-Current)
4-Stroke: 115hp. - 225hp. (2002-Current)



**18-9077
WAVE WASHER**
Replaces: 13-888363-2
For: 2-Stroke: 115hp. - 300hp. (1993-Current) 4-Stroke: 115hp. - 225hp. (2002-Current)



**18-9079
WAVE WASHER KIT**
Replaces:
Fits: Yamaha 2-stroke 115-300hp (1993 & Up); Yamaha 4-stroke 115-225hp (2002 & Up); Mercury 4-stroke 225 EFI S/N 0T653945 & Up



**18-9078
STAINLESS STEEL WASHER**
Replaces: 12-855682-2
For: 2-Stroke: 115hp. - 300hp. (1993-Current)
4-Stroke: 115hp. - 225hp. (2002-Current)



**18-4220D
THRUST WASHER**

Part #	Replaces
18-4220	12-13171, 12-77987, 12-8354671, 12-77987A1, 12-835467, 12-835467Q01 V-6 Outboards & Mercuriser Sterndrives
18-4221	13191A1, 75282A1 4 & 6 Inline - 75-150 HP



**18-4233
THRUST WASHER**
Replaces: 73345, 73345A1, 12-92647M 35-70 HP



**18-9010
MOTOR FLUSHER
Heavy Duty**



**18-3607
RETAINER BRACKET**
Replaces: 893409
For: 200/225 4-Stroke Verado (S/N OT980000 & Up), 250/275 4-Stroke Verado (S/N OT801000 & Up)



**18-2700
STEERING CYLINDER SEAL KIT**
Replaces: 896173A01, 8M0045604
For: 200/225 4-Stroke Verado (S/N OT980000 & Up), 250/275 4-Stroke Verado (S/N OT801000 & Up)



**18-79989
TRAILING STICKS**
Fits: Most outboards over 150hp with three ram intrigrel tilt/trim.

Zinc is for saltwater only applications.
Magnesium is for fresh water only applications.
Aluminum is for brackish water or salt water environments.



**18-6156A
18-6156M
ANODE KIT**
Verado 4 cyl. All Models



**18-6157A
18-6157M
ANODE KIT**
Replaces: 8M0058677
Verado 6 cyl. All Models



② **18-6241**
③ **18-6011**
① **18-6011A**
ANODE
Replaces:
31640, 31640A1, 97-31640Q4, 97-31640B4, 31640A4, 31640A2, 316404, 316403, 72436A1
Use on inline 3, 4 & 6 Cyl, V6



③ **18-6014**
① **18-6014A**
ANODE
Replaces:
46399A1, 822777A1, 822777Q1, 822777A4, 822777A3, 8227772, 822777, 463999A2
For use with 225 (3.0L Carb.) models



③ **18-6016**
④④ **18-60161**
③⑤ **18-60161-9**
① **18-6016A**
② **18-6244**
ANODE
Replaces:
76214, 97-76214Q5, 97-762145, 76214A5, 786214A2, 762142, 762142A1
200, 225, 250HP, V-155-V-200, & All Bravos



③ **18-6068**
ANODE
Replaces: 826134, 826134A1, 97-826134Q

① Aluminum ② Magnesium ③ Zinc
④ Standard package of 10 priced per piece ⑤ Standard package of 10 priced per package



③ 18-6249
① 18-6249A
ANODE

Replaces: 43396A2, 818298A1, Q1
For use on transom mount bracket:
175HP/150EFI/200EFI
(S/N OG303046 & Up)



① 18-6245D Display Package

18-6245
ANODE MOUNTING BOLT

Replaces: 10-32470
For use with: 18-6011, 18-6014, 18-6016
7/16" X 1 3/4" Allen Head Cap Screw



18-2599
FACE SEAL AND TOOL

Replaces: 26-816575A2



18-2742
SHIFT SHAFT BOOT

Replaces: 85552

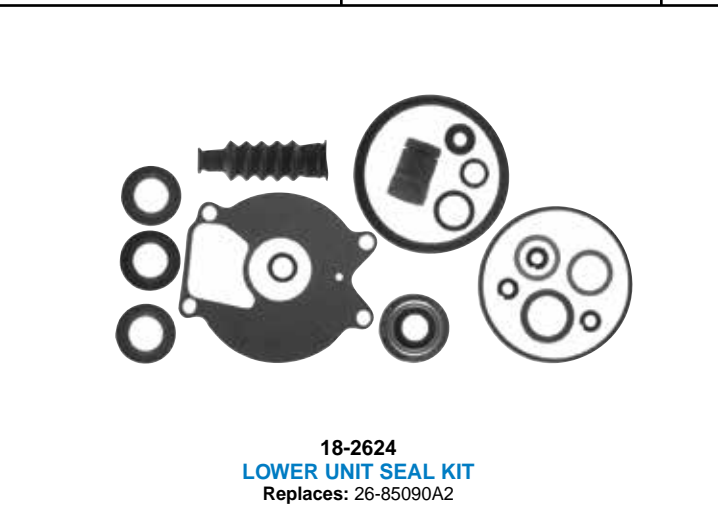

18-2624
LOWER UNIT SEAL KIT
Replaces: 26-85090A2

— CONTAINS —

Part #	Desc.	O.E.#	Qty.
18-0579	Oil Seal	26-41131	1
18-0580	Oil Seal	26-41132	1
18-0586	Seal	26-99325	2
18-7419	O-Ring	25-69202	1
18-2562	Gear Hsg to Face Plate Gasket	27-99326-1	1
18-2945	Washer	12-20260	2
18-2742	Boot	85552	1
18-2560	Washer	12-86645	2
18-7135	O-Ring	25-35276	1
18-7188	O-Ring	25-805726	2
18-7956	O-Ring	25-85549	1
18-7100	O-Ring	25-85594	1

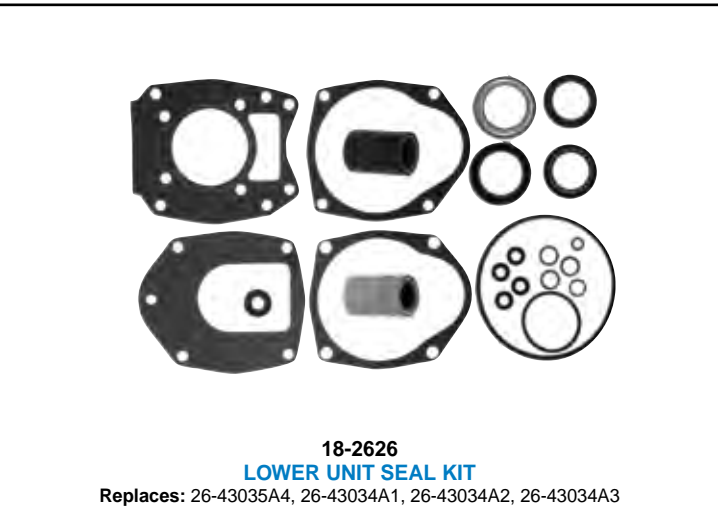

18-2626
LOWER UNIT SEAL KIT
Replaces: 26-43035A4, 26-43034A1, 26-43034A2, 26-43034A3

— CONTAINS —

Part #	Desc.	O.E.#	Qty.
18-0522	Oil Seal	26-43036	1
18-0583	Oil Seal	26-43035	1
18-2002	Oil Seal	26-30550, 26-76868	1
18-2053	Oil Seal	26-70081	1
18-2054	Oil Seal	26-8164641	1
18-2563	Face Plate to Water Pump Cover Gasket	27-43034-1	1
18-2564	Water Pump Base to Face Plate Gasket	27-43033-1	1
18-2565	Water Pump Base to Gear Housing Gasket	27-43047-2	1
18-2566	Face Plate to Water Pump Cover Gasket	27-817277	1
18-2945	Washer	12-19183	3
18-4261	Washer	19643	1
18-7188	O-Ring	25-805726	1
18-7198	O-Ring	25-45710	1

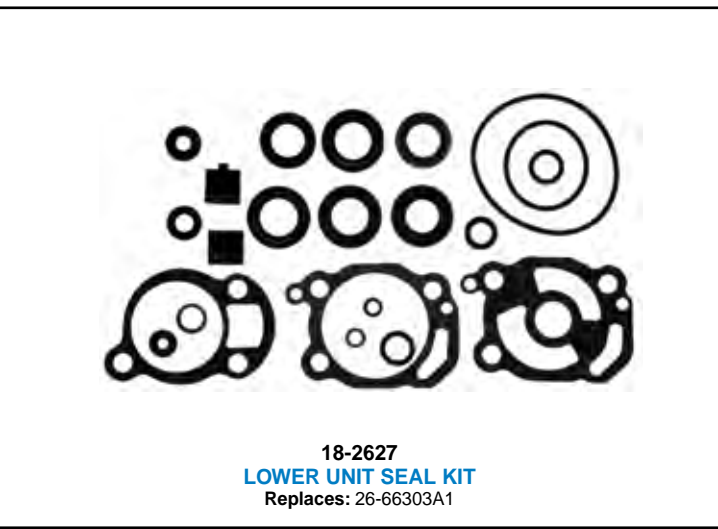

18-2627
LOWER UNIT SEAL KIT
Replaces: 26-66303A1

— CONTAINS —

Part #	Desc.	O.E.#	Qty.
18-0595	Seal	26-66303	2
18-2004	Seal, Water Pump Base	26-20070	2
18-2006	Seal, Water Pump Base	26-897154	1
18-2019	Seal	26-26805	1
18-2827	Upper Face Plate to Water Pump Gasket	27-39623	1
18-2828	Lower Water Pump Base to Face Gasket	27-39625	1
18-2945	Washer	12-20260	1
18-4261	Washer	12-20262	1
18-7120	O-Ring	25-38933	1
18-7163	O-Ring	25-33465	1
18-7164	O-Ring	25-33466	1
18-7180	O-Ring	25-26802	2

① Aluminum

③ Zinc

— CONTAINS —

Part #	Desc.	O.E.#	Qty.
18-0584	Oil Seal, Prop Shaft	26-66022	1
18-2010	Seal, Wtr Pump Base	26-897153	1
18-2945	Washer, Fill Screw	12-20260	1
18-4261	Washer, Fill Screw	12-20262	1
18-7116	O-Ring	25-62704	1
18-7120	O-Ring	25-38933	1
18-7156	O-Ring	25-29439	1
18-7168	O-Ring	25-48171	1
18-7171	O-Ring	25-30529	1
18-7180	O-Ring	25-26802	1
18-8308	Seal, Shift Shaft	26-30696	1
18-8310	Seal, Water Pump Base	26-30900T	1

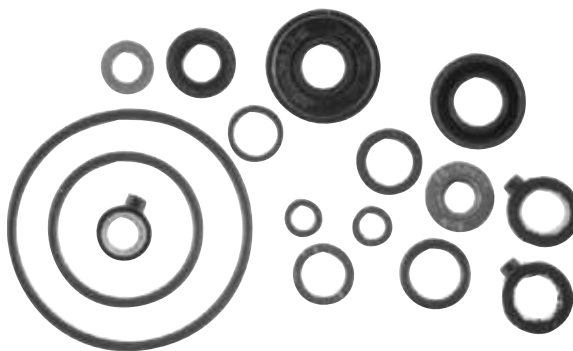

18-2628
LOWER UNIT SEAL KIT
 Replaces: 26-77066A1

— CONTAINS —

Part #	Desc.	O.E.#	Qty.
18-2006	Seal	26-897154	2
18-2560	Washer	12-86645	2
18-2562	Gear Housing to Face Plate Gasket	27-99326-1	1
18-2742	Boot	85552	1
18-2945	Washer	12-20260	2
18-7135	O-Ring	25-35276	1
18-7419	O-Ring	25-69202	1
18-7956	O-Ring	25-85549	1
18-7100	O-Ring	25-85594	1
18-8348	Slinger	25-86203	1



18-2629
LOWER UNIT SEAL KIT
 Replaces: 26-85090A1

— CONTAINS —

Part #	Desc.	O.E.#	Qty.
18-0500	Seal	26-817472	1
18-0622	Gasket, Lower Wear Plate	27-19701	1
18-2051	Seal	26-69188	1
18-2052	Seal	26-69189	1
18-2945	Washer	12-19183	3
18-7168	O-Ring	25-48171	2
18-7173	O-Ring	25-30224	1
18-7950	O-Ring	25-45258	1



18-2635
LOWER UNIT SEAL KIT
 Replaces: 26-814669A2

— CONTAINS —

Part #	Desc.	O.E.#	Qty.
18-2563	Face Plate to Water Pump Gasket	27-43034-1	1
18-2564	Water Pump Base to Face Plate Gasket	22-43033-1	1
18-2945	Drain Screw Gasket	12-19183,12-20260	2
18-2599	Face Seal & Tool	26-816575A2	1
18-2014	Oil Seal	26-89238	1
18-2013	Oil Seal	26-16977	1
18-2054	Oil Seal	26-8164641	1
18-7159	O-Ring	25-31534	1
18-7176	O-Ring	25-90011	1
18-7420	O-Ring	25-21836	2
18-7440-1	O-Ring	25-36318	2



18-2642
LOWER UNIT SEAL KIT
 Replaces: 26-816575A5



18-2646-1
LOWER UNIT SEAL KIT
 Replaces: 26-816575A3, 26-816575A1

--- CONTAINS ---			
Part #	Desc.	O.E.#	Qty.
18-2599	Face Seal and Tool	26-818575A2	1
18-2564	Water Pump Base To Face Plate Gasket	27-43033-1	1
18-2566	Face Plate to Water Pump Cover Gasket	27-817277	1
18-2945	Sealing Washer	12-19183	1
18-2944	Seal	26-45577	1
18-2002	Oil Seal	26-30550, 26-76868	1
18-2009	Oil Seal	26-892361	1
18-2013	Oil Seal	26-16977	1
18-2014	Oil Seal	26-89238	1
18-2056	Oil Seal	26-965031	2
18-2076	Oil Seal	26-12224	1
18-2077	Oil Seal	26-14077	1
18-7159	O-Ring	25-31534	1
18-7168	O-Ring	25-48171	2
18-7176	O-Ring	25-90011	1
18-7420	O-Ring	25-21836	2
18-7440-1	O-Ring	25-36318	2
18-2056	Oil Seal	26-66302	2
18-7413	O-Ring	25-62702	2
18-2009	Oil Seal	26-892361	1
18-2430	Drain Screw Casket	26-830749	1



18-2653
LOWER UNIT SEAL KIT
 Replaces: 26-55682A1

--- CONTAINS ---			
Part #	Desc.	O.E.#	Qty.
18-3110	Grommet	26-38970	1
18-2002	Oil Seal	26-30550, 26-76868	2
18-2007	Oil Seal	26-94038	1
18-2009	Oil Seal	26-892361	1
18-2013	Oil Seal	26-16977	1
18-2014	Oil Seal	26-89238	1
18-2048	Oil Seal	26-24590	1
18-2050	Oil Seal	26-55682	1
18-2053	Oil Seal	26-70081	1
18-2826	Water Pump Base to Gear Housing Gasket	27-85610-1	1
18-2914	Water Pump Gasket	27-85608-1	1
18-2915	Water Pump Gasket	27-85609-1	1
18-2948	Rubber Washer	12-49221-1	1
18-7153	O-Ring	25-25439	1
18-7157	O-Ring	25-29976	1
18-7158	O-Ring	25-30613	1
18-7159	O-Ring	25-31534	1
18-7161	O-Ring	25-32546	1
18-7162	O-Ring	25-33145	1
18-7173	O-Ring	25-30224	1
18-2801	Water Pump Gasket	27-32438	1
18-7426	O-Ring	25-30271	1
18-2945	Drain Screw Gasket	12-20260, 12-19183	2

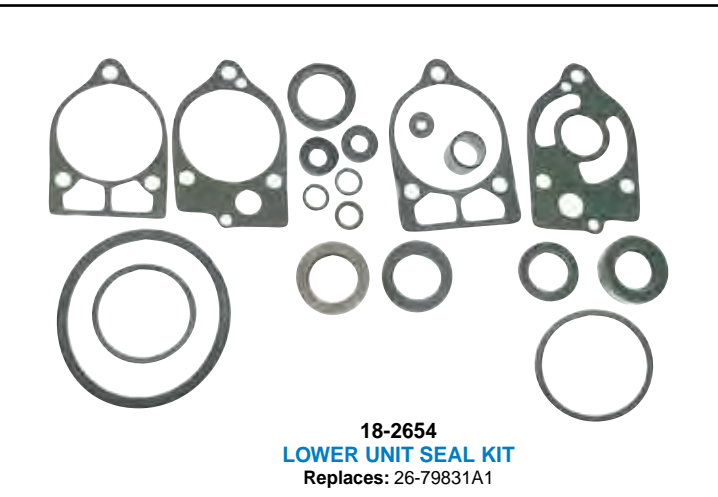

18-2654
LOWER UNIT SEAL KIT
 Replaces: 26-79831A1

--- CONTAINS ---			
Part #	Desc.	O.E.#	Qty.
18-2008	Oil Seal	26-56788	1
18-2011	Oil Seal	26-90562	1
18-2048	Oil Seal	26-24590	1
18-2051	Oil Seal	26-69188	1
18-2052	Oil Seal	26-69189	1
18-2054	Oil Seal	26-816464	1
18-2055	Oil Seal	26-79831	1
18-2823	Lower Water Pump Base to Face Plate Gasket	27-32769	1
18-2824	Upper Face Plate to Pump Body Gasket	27-19551	1
18-2825	Water Pump Base Gasket	27-32770	1
18-2841	Water Pump Base Gasket	27-19552, 27-77417	1
18-2948	Rubber Washer	12-49221-1	1
18-7153	O-Ring	25-25439	1
18-7155	O-Ring	25-26855	1
18-7160	O-Ring	25-31986	1
18-7115	O-Ring	25-26722	1
18-2945	Drain Screw Gasket	12-20260, 12-19183	2

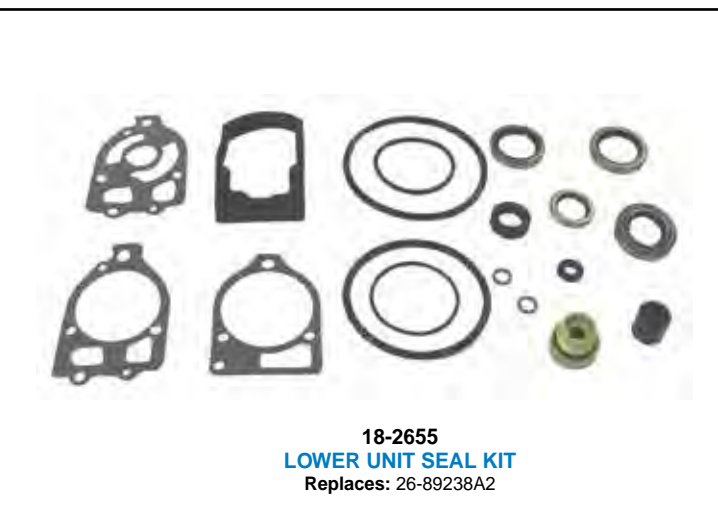

18-2655
LOWER UNIT SEAL KIT
 Replaces: 26-89238A2

--- CONTAINS ---			
Part #	Desc.	O.E.#	Qty.
18-2155	Bushing Gasket	23-77631A2	1
18-2919	Gasket	27-42631-1	1
18-2002	Oil Seal	26-30550, 26-76868	2
18-2013	Oil Seal	26-16977	1
18-2014	Oil Seal	26-89238	1
18-2914	Water Pump Gasket	27-85608-1	1
18-2915	Water Pump Gasket	27-85609-1	1
18-3110	Bushing	26-38970	1
18-7159	O-Ring	25-31534	1
18-7176	O-Ring	25-90011	1
18-7157	O-Ring	25-29976	1
18-7153	O-Ring	25-25439	1
18-2009	Oil Seal	26-89236	1
18-7426	O-Ring	25-30271	1
18-2945	Drain Screw Gasket	12-20260, 12-19183	2



18-2697-1
LOWER UNIT SEAL KIT
 Replaces: 26-41365A3

— CONTAINS —

Part #	Desc.	O.E.#	Qty.
18-0581	Oil Seal	26-413651	2
18-0584	Oil Seal	26-66022	1
18-0585	Oil Seal	26-821928	1
18-0586	Oil Seal	26-99325	1
18-2728	Water Tube Seal	26-42102-1	1
18-2945	Washer	12-19183	2
18-3149-2	Water Pump Base	46-42040A5	1
18-4261	Washer	19643	1
18-7162	O-Ring	25-33145	1



18-74501
GEAR HOUSING SEAL KIT
 Replaces: 27-99049M
 Fits: Mariner 9.9C & 15C models



18-2725
LOWER UNIT SEAL KIT
 Replaces: 26-830749A01

For: 135/150/175 4-Stroke Verado (S/N 1B227000 & Up), 200/225 4-Stroke Verado (S/N OT980000 & Up), 250/275 4-Stroke Verado (S/N OT801000 & Up)

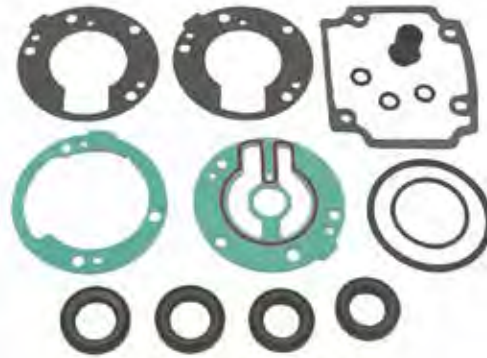

18-2785
LOWER UNIT SEAL KIT
 Replaces: 27-41899M

— CONTAINS —

Part #	Desc.	O.E.#	Qty.
18-4698	Drain or Fill Washer Gasket	27-81987M	3
18-0554	Oil Seal	26-84813M	1
18-0296	Oil Seal	26-854017M	2



18-2787
LOWER UNIT SEAL KIT
 Replaces: 27-92648M

— CONTAINS —

Part #	Desc.	O.E.#	Qty.
18-4698	Drain or Fill Washer Gasket	27-81987M	3
18-0296	Oil Seal	26-854017M	2
18-0297	Oil Seal	26-82234M	2
18-0298	O-Ring	25-82275M	1
18-0299	O-Ring	25-82289M	1
18-0292	Wear Plate to Pump Housing Gasket	27-81417M	1
18-0267	Oil Seal	26-82257M	1
18-0294	Wear Plate to Pump Base Gasket	27-81421M	1



18-8382
LOWER UNIT SEAL KIT
 Replaces: 26-816575A4

For: 200 HP (T801000 & UP), 200 HP OPTIMAX DFI (G438000 & UP), 225 HP EFI (G438000 & UP), 225 HP OPTIMAX DFI (G590000-G960499), 250 HP EFI (G438000 & UP), MODELS WITH "C-3 CASTING": 200 HP OPTIMAX DFI (G386496-G437999), 225 HP (D280813-G437999), 225 HP EFI (G129222-G437999), 250 HP EFI (G129222-G437999)

GEAR HOUSING SEAL KIT APPLICATION

HP	Beg. Serial #	End. Serial #	Part #	HP	Beg. Serial #	End. Serial #	Part #
4 (1cyl)	5595532	A809600	18-2628	60 (3 cyl)	6428681	D000749	18-2654
4.5 (1 cyl)	4107220	& UP	18-2628	60 (3 cyl)			
6	A197112	& UP	18-2697-1	non-Bigfoot	D000750	& UP	18-2635
7.5	4851693	& UP	18-2628	60 (3 cyl)			
8	A197112	& UP	18-2697-1	Bigfoot	D000750	& UP	18-2626
8 Bodensee (4-stroke)	G760300	T178499	18-2697-1	60 (4-stroke) Bigfoot	T178500	& UP	18-2626
9.8	4839254	& UP	18-2628	60 (4-stroke)			
9.9	A197112	& UP	18-2697-1	non-Bigfoot	T178500	& UP	18-2635
9.9 (4-stroke) non-Bigfoot	G760300	& UP	18-2697-1	60 Seapro/ Marathon/ Big Foot (3 cyl)	D000750	& UP	18-2626
9.9 (4-stroke) Bigfoot	G760300	& UP	18-2624	70	4571652	A996141	18-2654
Seapro/XR10	D038000	& UP	18-2697-1	70	A996142	& UP	18-2626
15	A197112	& UP	18-2697-1	75 (4 cyl)	6432901	& UP	18-2653
15 (4-stroke) non-Bigfoot	G760300	& UP	18-2697-1	75 (3 cyl)	A996142	& UP	18-2626
15 (4-stroke) Bigfoot	G760300	& UP	18-2624	75 (4-stroke)	G960500	& UP	18-2626
Magnum/ Marathon 15XD/ Super 15	ALL		18-2624	80 (4 cyl)	4831999	6432900	18-2653
18	5837437	6443972	18-2629	80 (3 cyl)	A966142	& UP	18-2626
18	6443973	& UP	18-2624	90 (6 cyl)	4845301	& UP	18-2653
20	4709593	6443972	18-2627	90 (3 cyl)	A996142	& UP	18-2626
20	6443973	& UP	18-2624	90 (4-stroke)	G960500	& UP	18-2626
25	5705532	6443972	18-2629	100 (4 cyl)	B209468	& UP	18-2626
25	6443973	& UP	18-2624	115 (6 cyl)	4855153	B209467	18-2653
25 Lightning (3 cyl)	E268781	& UP	18-2624	115 (4 cyl)	C100000	& UP	18-2626
30 (4-stroke) (3 cyl) Bigfoot	G760300	& UP	18-2626	115EFI (4-stroke)	T178500	& UP	18-2626
35	6445653	& UP	18-2654	125 (4 cyl)	D283222	& UP	18-2626
40 (2 cyl)	4860103	G053313	18-2654	V-135	A904646	& UP	18-2655
40 (4 cyl)	C159200	& UP	18-2654	V-135 DFI	G590000	& UP	18-2655
40 (4-stroke) (3 cyl) Bigfoot	G760300	& UP	18-2626	140 (6 cyl)	4865678	& UP	18-2653
45	5531630	& UP	18-2654	V-150	4868648	A904645	18-2653
50 (4 cyl)	4357640	& UP	18-2654	V-150 (carb)	A904646	& UP	18-2655
50 (3 cyl)	6428681	D000749	18-2654	V-150 XR4, XR6, MAGII, III	B242885	& UP	18-2655
50 (3 cyl)	D000750	G589999	18-2635	V-150 EFI	D820000	& UP	18-2655
50 (4-stroke) (4 cyl) Bigfoot	G760300	& UP	18-2626	V-150 DFI	G590000	& UP	18-2655
50 (4-stroke) Bigfoot	G231123	& UP	18-2626	V-175	4301235	6618750	18-2653
50 (4-stroke) non-Bigfoot	T178500	& UP	18-2635	V-175 (carb)	6618751	& UP	18-2655
55 (3 cyl)	D000750	& UP	18-2635	V-175 XRI(EFI)	D000750	& UP	18-2655
				V-200	4839034	6625220	18-2653
				V-200 (carb)	6625221	& UP	18-2655
				V-200 XRI(EFI)	C100861	& UP	18-2655
				V-200 DFI (3.0L)	G386496	G960499	18-2642
				V-220	B117316	& UP	18-2655
				V-225	5628028	& UP	18-2653
				V-225	D280813	& UP	18-2646-1
				V-225/225 DFI	G386496	& UP	18-2642
				V-250	G386496	& UP	18-2642

MARINER LOWER UNIT SEAL KITS (Japanese Models)

Model	Serial #	O.E. Kit #	Part #
20C	(6A9-) ALL	27-41899M/27-95660M	18-2785
25C	(695-) ALL	27-41899M/27-95660M	18-2785
30A	(689-) ALL	27-41899M/27-95660M	18-2785
W48	(670-) ALL	27-92648M	18-2787
55/W55	(663-) ALL	27-92648M	18-2787
60	(675-) ALL (6F0-) ALL	27-92648M	18-2787

OIL SEALS



Part #	O.E. #	Shaft Size (in.)	Dimensions (in.)	
			O.D.	Width
18-0531	26-72785	0.790	1.880	0.248
18-0537	26-85107	1.020	1.507	0.251
18-0554	26-84813M	0.787	1.339	0.260
18-0560 ③	26-888483	1.250	1.690	0.256
18-0564 ④	26-888483	1.250	1.690	0.256
18-0579	26-41131	1.141	1.313	0.344
18-0580	26-41132	0.750	1.250	0.312
18-0581	26-413651	0.500	0.984	0.200
18-0583	26-43035	1.063	1.496	0.197
18-0584	26-66022	0.056	1.000	0.312
18-0585	26-821928	0.687	1.125	0.312
18-0586	26-99325	0.675	1.125	0.250
18-0595	26-66303	0.688	1.125	0.250
18-2002	26-76868, 26-30550	1.188	1.692	0.250
18-2004	26-20070	0.625	1.000	0.250
18-2006	26-897154	0.625	1.125	0.312
18-2008	26-56788	0.875	1.250	0.375
18-2010	26-897153	0.437	0.875	0.250
18-2053	26-70081	1.185	1.754	0.360
18-308	26-30696	0.297	0.625	0.156
18-8310	26-30900T	0.453	0.828	0.172
18-8347	26-8164641	0.375	0.750	0.243
18-0172	26-97530	0.845	1.500	0.315
18-0267	26-82257M	0.354	0.748	0.197
18-0296	26-854017M	0.866	1.417	0.236
18-0297	26-82234M	0.906	1.457	0.236
18-0515	26-30530	0.540	1.004	0.303
18-0516	26-30913	0.500	0.839	0.187
18-0517	26-32911	1.100	1.260	0.127
18-0518 ②	26-34217	0.282	0.394	0.083
18-0519	26-14240	3.792	4.536	0.482
18-0522	26-43036	1.045	1.474	0.187
18-0523	26-43993	1.640	2.132	0.282
18-0525	26-45587	0.390	0.628	0.124
18-0526	26-48443	0.750	1.379	0.256
18-0527	26-56397	0.750	1.127	0.343
18-0529	26-62818	1.640	2.256	0.319

① Line Cutter Seal ② Pkg. of 4 ③ Metal ④ Rubber

POWERHEAD SEALS APPLICATION

HP	Cyl.	Beginning Serial No.	Ending Serial No.	Upper Crankshaft	Qty.	Lower Crankshaft	Qty.
3.5	1	6202173	UP	—	—	18-0527	1
3.6	1	5404657	UP	—	—	18-0527	1
4	1	2771622	4107219	—	—	18-0527	1
4	1	5589202	UP	18-0515	1	—	—
4.5	1	4107220	UP	—	—	18-0527	1
7.5/9.8/110	2	2810637	3274633	—	—	18-0527	1
10/15/20/25	2	1290910	1499331	—	—	18-2013	1
20	2	1558310	2031773	—	—	18-2013	2
20	2	2031774	2827677	—	—	18-2013	2
18,20,25XD	2	6443973	UP	—	1	18-0537	1
20 JET	2	G053314	UP	—	1	18-0537	1
30	2	1271885	1356947	18-2016	1	18-2016	1
30JET	2	C159200	UP	18-2016	1	18-2016 ①	2
MK 35 A	2	1217222	1271884	18-2016	1	18-2016	1
35	2	1356948	1571113	18-2016	1	18-2016	1
35	2	1571114	2874703	—	—	18-2016 (lower)	1
35	2	6445653	UP	18-2016	1	18-2016	2
40	4	1279685	2874703	18-2016	1	18-2016	1
40	2	2874704	3336257	18-2016	1	18-2016	2
40	2	3336258	4117709	18-2016	1	18-2016	1
40	2	4117710	5556229	18-2016	1	18-2016	1
40	2	5556230	6445653	18-2016	1	18-2016	2
40	4	C159200	UP	18-2016	1	18-2016 ①	2
45	4	1476510	1531568	18-2016	1	18-2016	1
45	4	5531630	UP	18-2016	1	18-2016	2
45 JET	3	ALL	—	—	—	18-2016 (inner)	1
50	4	1421113	2858813	18-2016	1	18-2016 (inner)	1
50	4	2855514	UP	18-2016	1	18-2016	2
50/60	3	6428681	D000750	18-2016	1	18-2016	2
50/55/60	3	D000750	UP	—	—	18-2016 (inner)	1
60	6	1303411	1542744	18-2016	1	18-2016	1
65	4	1542745	2803561	18-2016	1	18-2016 (inner)	1
65	4	2803562	3293183	18-2016	1	18-2016	2
65	3	3293184	3547986	18-2016	1	18-2016	2
65	3	3547987	4571651	18-2016	1	18-2016	2
65 JET	3	D283222	UP	18-0523	1	18-2016	1

① Fits most models

POWERHEAD SEALS APPLICATION

HP	Cyl.	Beginning Serial No.	Ending Serial No.	Upper Crankshaft	Qty.	Lower Crankshaft	Qty.
70	6	1296411	1566239	18-2016	1	18-2016 (inner)	1
70	3	4571652	6428680	18-2016	1	18-2016	2
70	3	A996142	UP	18-0523	1	18-2016	1
75	4	6432901	A996141	18-2016	1	18-2016	2
75	3	A996142	D283221	18-0523	1	18-2016	1
75	3	D283222	UP	18-0523	1	18-2016	1
80	6	1335465	1566239	18-2016	1	18-2016	1
80	4	2559001	4831998	18-2016	1	18-2016	2
80	4	4831999	UP	18-2016	1	18-2016	2
80	3	A996142	UP	18-0523	1	18-2016	1
80 JET	4	D283222	UP	18-0523	1	18-2016	1
85	6	1460999	1766823	18-2016	1	18-2016	1
85	4	3493913	4831998	18-2016	1	18-2016	2
90	6	1766824	1869775	18-2016	1	18-2016 (outer)	1
90	6	4845301	A996141	18-2016	1	18-2016	2
90	3	A996142	D283221	18-0523	1	18-2016	1
90	3	D283221	UP	18-0523	1	18-2016	1
95	6	1869776	2318585	18-2016	1	18-2016 (inner)	1
100	6	1464949	2836018	18-2016	1	18-2016	1
100BP	6	2641855	3253111	18-2016	1	18-2016	2
100	4	B209468	D283221	18-0523	1	18-2016	1
100	4	D283222	UP	18-0523	1	18-2016	1
105JET	V-6	D082000	UP	18-2016	1	18-2016	2
110	6	1870204	2314955	18-2016	1	18-2016	1
115	6	2836019	3525440	18-2016	1	18-2016	2
115	6	3525441	C100000	18-2016	1	18-2016	2
125	6	2314956	3253111	18-2016	1	18-2016 (inner)	1
135	6	2839369	3293233	18-2016	1	18-2016	2
135	V-6	A904646	UP	18-2016	1	18-2016	2
140	6	3293234	UP	18-2016	1	18-2016	2
140JET	V-6	D082000	UP	18-2016	1	18-2016	2
150	6	3502806	5327662	18-2016	1	18-2016	2
150	V-6	4868998	6042945	18-2016	1	18-2016	2
150	V-6	6042946	UP	18-2016	1	18-2016	2
175	V-6	4301235	5875203	18-2016	1	18-2016	2
175	V-6	5875204	6618751	18-2016	1	18-2016	2
175	V-6	6618751	UP	18-2016	1	18-2016	2
200	V-6	4839034	5875303	18-2016	1	18-2016	2
200	V-6	5875303	6073191	18-2016	1	18-2016	2
200	V-6	6073192	UP	18-2016	1	18-2016	2
220	V-6	B117316	UP	18-2016	1	18-2016	2
225	V-6	5628028	UP	18-2016	1	18-2016	2

① Fits most models

LOWER UNIT SEALS APPLICATION

HP	Beginning Serial No.	Ending Serial No.	Prop Shaft Inner/Outer	Water Pump Base Upper/Lower	Water Pump Housing	Shift Shaft
3.5/3.6	5404657	UP	-	18-2010	18-0516	-
3.9	1655013	2498135	18-0515	-	18-0516	-
4	2498136	5589201	18-0515	-	18-0516	-
4	5589202	5595531	-	18-2010	18-0516	-
4/4.5	5589203	A809601	-	18-2010	② 18-0516	-
6	1408611	2529894	18-0515	-	18-0516	-
7.5	2529895	3801457	18-0515	-	18-0516	-
7.5	3801458	5206549	-	-	18-0516	-
7.5	5206550	UP	-	18-2010	② 18-0516	-
9.8	1470349	3795657	18-0515	-	18-0516	-
9.8	3795658	5206549	-	-	18-0516	-
9.8	5206550	UP	-	18-2010	② 18-0516	-
18	5837437	6443972	-	18-2006/18-2006	-	-
20	1558310	1866494	18-2019/18-2019	18-2006	18-2004	-
20	1866495	6443972	18-2019/18-2019	18-2004/18-2006	18-2004	-
25	5705532	6443972	-	18-2006/18-2006	-	-
30	1271885	1356947	18-2011	18-2011	18-2015	18-2009
30	G055314	UP	18-2051/18-2052	-	-	-
MK 35A	1217222	1271884	18-2011	18-2011	18-2015	18-2009
35	1356948	1448139	18-2011	18-2011	18-2015	18-2009
35	1571114	1960826	18-2011	18-2011	18-2017	18-2009
35	1960827	2874703	18-2011/18-2015	18-2011/18-2055	18-2017	18-2009
35	6445653	UP	18-2051/18-2052	18-2011/18-2055	-	18-2054
40	1279685	2874703	18-2011	18-2011	18-2015	18-2009
40	2874704	3336257	18-2008	18-2011/18-2055	18-2017	18-2009
40	3336258	4117709	18-2008	18-2011/18-2055	18-2017	18-2048
40	4117710	4860102	18-2051/18-2052	18-2011/18-2055	-	18-2009/18-2048

② .438 ID ONLY

LOWER UNIT SEALS APPLICATION (Cont.)

HP	Beginning Serial No.	Ending Serial No.	Prop Shaft Inner/Outer	Water Pump Base Upper/Lower	Water Pump Housing	Shift Shaft
40	4860103	6445652	18-2051/18-2052	18-2011/18-2055	-	18-2054
40 4cyl	C159200	G053313	18-2051/18-2052	18-2011/18-2055	-	18-2054
40 2cyl	G055314	UP	18-2051/18-2052	-	-	-
45	1476510	1531568	18-2011	18-2011	18-2017	18-2009
45 4cyl	5531630	UP	18-2051/18-2052	18-2011/18-2055	-	18-2054
50	1421113	1639472	18-2011	18-2011	18-2017	18-2009
50	1639473	1770178	18-2011	18-2011	18-2017	18-2009
50	1770179	2305100	18-2011/18-2015	18-2011/18-2055	18-2017	18-2009
50	2305101	2858813	18-2011/18-2015	18-2011/18-2055	18-2017	18-2048
50	2858814	4140999	18-2008	18-2011/18-2055	18-2017	18-2009/18-2048
50	4141000	4962055	18-2051/18-2052	18-2011/18-2055	-	18-2009/18-2048
50	4962056	5531630	18-2051/18-2052	18-2011/18-2055	-	18-2054
50 3cyl	6428681	D000750	18-2051/18-2052	18-2011/18-2055	-	18-2054
50/55/60 3 cyl	D000751	UP	18-2051/18-2052	-	-	18-2054
60	1303411	1542744	-	18-2011	18-2015	-
60	6428681	D000750	18-2051/18-2052	18-2011/18-2055	-	18-2054
65	1542745	2874263	18-2002/18-2002	18-2007	18-2013	18-2009
65	2874263	3293183	18-2002/18-2002	18-2007/18-2050	18-2013	18-2009/18-2048
65 3cyl	3293184	4136684	18-2008	18-2011/18-2055	18-2017	18-2009/18-2048
65 3cyl	4136685	4571651	18-2051/18-2052	18-2011/18-2055	18-2017	18-2009/18-2048
70	1296411	1413610	18-2011	-	18-2015	-
70	1413611	1566239	18-2002/18-2002	18-2007	18-2013	18-2009
70 3cyl	4571652	4977156	18-2051/18-2052	18-2011/18-2055	-	18-2009/18-2048
70 3cyl	4977157	5579016	18-2051/18-2052	18-2011/18-2055	-	18-2054
70 3cyl	5579017	A996142	18-2051/18-2052	18-2011/18-2055	-	18-2009
70/75 3cyl	A996142	UP	18-2002/18-2053	18-0522 (lower)	-	-
75 4cyl	6432901	A996142	18-2002/18-2053	18-2013/18-2007	-	18-2054
80	1335465	1398629	18-2002/18-2002	18-2007	18-2013	18-2009
80	1398630	1566239	18-2002/18-2002	18-2007	18-2013	18-2009
80 4cyl	2559001	3144218	18-2002/18-2002	18-2013/18-2007	18-2013	18-2009/18-2048
80 4cyl	3144219	4831998	18-2002/18-2002	18-2050/18-2007	18-2013	18-2009/18-2048
80 4cyl	4831999	5582561	18-2002/18-2002	18-2013/18-2007	-	18-2054
80 4cyl	5582562	A996142	18-2002/18-2053	18-2013/18-2007	-	18-2054
80 3cyl	A996142	UP	18-2002/18-2053	18-0522 (lower)	-	-
85	1460999	1766823	18-2002/18-2002	18-2007	18-2013	18-2009
85 4cyl	3493913	4590511	18-2002/18-2002	18-2050/18-2007	-	18-2009/18-2048
85 4cyl	4590512	4831998	18-2002/18-2002	18-2013/18-2007	-	18-2009/18-2048
90	1766824	1869775	18-2002/18-2002	18-2013/18-2007	18-2013	18-2009
90	4845301	5594656	18-2002/18-2002	18-2013/18-2007	-	18-2054
90	5594657	A996142	18-2002/18-2053	18-2013/18-2007	-	18-2054
90 3cyl	A996142	UP	18-2002/18-2053	18-0522 (lower)	-	-
95	1869776	2318585	18-2002/18-2002	18-2013/18-2007	18-2013	18-2009/18-2048
100,100SS	1464949	2836018	18-2002/18-2002	18-2013/18-2007	18-2013	18-2009
100BP	2399698	2641854	18-2002/18-2002	18-2013/18-2007	18-2013	18-2009/18-2048
100 4cyl	B209468	UP	18-2002/18-2053	18-0522 (lower)	-	-
110	1870204	2314955	18-2002/18-2002	18-2013/18-2007	18-2013	18-2009/18-2048
115	2836019	3525440	18-2002/18-2002	18-2013/18-2007	18-2013	18-2009/18-2048
115	3525440	4112634	18-2002/18-2002	18-2013/18-2007	-	18-2009/18-2048
115	4112635	4855152	18-2002/18-2002	18-2013/18-2007	-	18-2009/18-2048
115	4855153	5600966	18-2002/18-2002	18-2013/18-2007	-	18-2054
115	5600967	C100000	18-2002/18-2053	18-2013/18-2007	-	18-2054
115 4cyl	C100000	UP	18-2002/18-2053	18-0522 (lower)	-	-
125	2314956	2839368	18-2002/18-2002	18-2013/18-2007	18-2013	18-2009
135	2839369	3293233	18-2002/18-2002	18-2013/18-2007	18-2013	18-2009
140	3293234	3502805	18-2002/18-2002	18-2013/18-2007	18-2013	18-2009/18-2048
140	4865678	UP	18-2002/18-2002	18-2013/18-2007	-	18-2054
150	3502806	4121434	18-2002/18-2002	18-2013/18-2007	-	18-2009/18-2048
150	4121434	5327662	18-2002/18-2002	18-2013/18-2007	-	18-2009/18-2048

V-6'S

150/150XR2	4868998	5432021	18-2002/18-2002	18-2013/18-2014	-	18-2054
150/150XRS	5432021	A904646	18-2002/18-2002	18-2013/18-2014	-	18-2054
135/150/XR2	A904646	UP	18-2002/18-2002	18-2013/18-2014	-	18-2054
175	4301235	6618750	18-2002/18-2002	18-2013/18-2014	-	18-2054
175	6618751	UP	18-2002/18-2002	18-2013/18-2014	-	18-2054
200	4839034	6073191	18-2002/18-2002	18-2013/18-2014	-	18-2054
200	6073192	UP	18-2002/18-2002	18-2013/18-2014	-	18-2054
220	B117316	UP	18-2002/18-2002	18-2013/18-2014	-	18-2054
225	5628028	D280813	18-2002/18-2002	18-2013/18-2014	-	18-2054
250/275	C101891	UP	18-2002/18-2002	-	-	18-2054
3.4	5611648	UP	18-2002/18-2002	-	-	18-2054

POWER TRIM OIL SEAL

H.P.	Beginning S/N	Ending S/N	Oil Seals	Qty.	Desc.
115	2836019	3525440	18-2048	1	Starboard Mounting Bracket
140	3293234	UP	18-2048	1	Starboard Mounting Bracket
150	3502806	4865677	18-2048	1	Starboard Mounting Bracket
150 XS	4868648	5327662	18-2048	1	Starboard Mounting Bracket

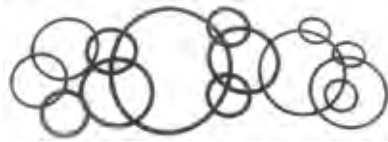

O-RINGS

Part #	O.E. #	DIMENSIONS (in.)		Part #	O.E. #	DIMENSIONS (in.)	
		O.D.	Width			O.D.	Width
18-0175 ③④	25-26543	0.22	0.103	18-7165 ②④	25-32509	0.5	0.065
18-0858 ③④	25-54029	2.800	0.103	18-7166 ②④	25-45254	0.615	0.065
18-0860 ③④	25-62700	3.237	0.103	18-7167 ②④	25-861844	3.609	0.139
18-7102 ②④	25-62706	0.426	0.07	18-7168 ②④	25-20587, 25-21720, 25-26834, 25-48171, 25-801334436	0.37	0.065
18-7103 ②④	25-29845	0.924	0.103	18-7169 ②④	25-35984, 25-70937	3.5	0.135
18-7105 ②④	25-62705, 25-F7848342	0.75	0.065	18-7170 ②④	25-33504	1.365	0.135
18-7107 ②④	25-67202	4.75	0.135	18-7171 ②④	25-30529	1.92	0.1
18-7114 ②④	25-23145, 25-843315, 25-F702736	1	0.135	18-7172 ②④	25-31305	3.25	0.135
18-7115 ①	25-26722	1.735	0.135	18-7173 ②④	25-27018, 25-30224Q	1.875	0.135
18-7116 ①	25-20633, 25-22174, 25-62704, 25-85148, 25-F24342, 802206	0.36	0.1	18-7174 ②④	25-45711	0.62	0.1
18-7117 ①	25-35027	1.046	0.139	18-7175 ②④	25-62817	3.75	0.27
18-7120 ①	25-38933	0.215	0.065	18-7176 ②④	25-896523, 25-F74305, F74305-1, F74305, F694555	2.16	0.1
18-7121 ①	25-35029, 25-882613, 802231	3.1	0.135	18-7177 ②④	25-53421, 25-59712	2.625	0.065
18-7124		2.5	0.103	18-7180 ②④	12-31060, 25-26802, 25-8M2000926	0.445	0.09
18-7125		2.3	0.103	18-7188 ②	25-805726	0.361	0.0635
18-7135 ①	25-20365, 25-35276	0.75	0.135	18-7195 ②	25-8M0027717	2.75	0.07
18-7143 ②④	27-58025, 25-65936, 391-5081	1.31	0.1	18-7198 ②④	25-45710	1.43	0.1
18-7145 ②④	25-64068	0.25	0.1	18-7410 ②④	25-36390	0.676	0.07
18-7146 ②④	25-47632	1.12	0.1	18-7411 ②④	25-35480, 25-47386, 25-8M2000816	1.25	0.1
18-7151 ②④	25-20081, 25-39572	3	0.135	18-7413 ②④	22-22175, 25-62702, 25-F50342-1, F50342, F17510	0.301	0.07
18-7152 ②④	25-20863	2.625	0.135	18-7414 ②④	25-62384, 25-823683	1.989	0.07
18-7153 ②④	25-25439, 25-20679, 25-F53795-1, F53795	0.862	0.103	18-7415 ②④	25-64966	3.739	0.07
18-7155 ②④	25-26855	1.62	0.135	18-7419 ②④	25-69202	2.675	0.103
18-7156 ②④	25-29439	1.185	0.1	18-7420 ②④	25-21836	0.796	0.139
18-7157 ②④	25-29976	3.5	0.21	18-7421 ②④	25-16524	0.15	0.065
18-7158 ②④	25-30613, 25-846357	0.74	0.1	18-7426 ③④	25-30271	0.74	0.31
18-7159 ②④	25-31534, 25-48451	3.855	0.21	18-7440-1 ③	25-36318	0.799	0.103
18-7160 ②④	25-31986	2.635	0.21	18-7445 ③④	25-55801	0.801	0.07
18-7161 ②④	25-32546	3.25	0.07	18-7449 ①	25-97387	4.487	0.103
18-7162 ②④	25-32424, 25-33145	2.025	0.135	18-7459 ①	20311, 25-20826	2.234	0.139
18-7163 ②④	25-33465, 25-853220, 25-807149	2.415	0.1	18-7464 ①	25-39695, 25-846361	4.234	0.139
18-7164 ②④	25-33466, 25-67675, 25-846356, 27-898101789	1.375	0.1	18-7467 ②④	25-54030, 25-F523555, F532555	2.987	0.103
18-7165 ②④	25-45253, 25-806809, 25-F461342	0.5	0.065	18-7474 ①	25-94288	1.239	0.07
				18-7956 ③④	25-85549	2.48	0.1969
				18-7100 ②④	25-85594	0.2362	0.1575
				18-7961	25-47254	3.65	0.135
				18-76895	25-803513007	1.220	.095

① Pkg. of 1 ② Pkg. of 5 ③ Pkg. of 2

MARINER O-RINGS (Japanese Models)

Part No.	O.E. No.	Dimensions		Part No.	O.E. No.	Dimensions	
		I. D.	Width (mm)			I. D.	Width (mm)
18-0298	25-82275M	41.50	3.0	18-0299	25-82289M	66.04	5.33

POWERHEAD SEALS & O-RING APPLICATION

Model	Beginning Serial #	Ending Serial #	Lower O-Ring	Lower Oil Seal	Upper O-Ring	Upper Oil Seal
3.5 (1cyl)	6202173	& UP	N/A	N.L.A.	18-7152	N/A
3.9 (39) (1cyl)	1655013	2498135	N/A	N.L.A.	18-7152	N.L.A.
4 (1cyl)	1655013	2498135	N/A	N/A	18-7152	N/A
4 (40) (1cyl)	2498136	2693114	N/A	N.L.A.	18-7152	N.L.A.
4 (1cyl)	2771622	4107219	N.L.A.	N/A	18-7152	N.L.A.
4 (40) (2cyl)	5589202	& UP	18-7102	N/A	N/A	18-0515
4.5 (4.5, 45) (1cyl)	4107220	4597261	N/A	N/A	18-7152	N.L.A.
4.5 (4.5, 45) (1cyl)	4597262	5595531	N/A	N.L.A.	18-7152	N/A
4.5 (4.5, 45) (1cyl)	5595532	& UP	N/A	N.L.A.	18-7152	N/A
6 (60)	1916139	2529894	N/A	N.L.A.	18-7459	N.L.A.
6 (2cyl)	1408611	2529894	N/A	N/A	18-7152	N/A
7.5 (75)	2529895	2721150	N/A	N.L.A.	18-7152	N.L.A.

④ This product is priced per piece. To order priced per package, please add -9 to the part number.

POWERHEAD SEALS & O-RING APPLICATION

Model	Beginning Serial #	Ending Serial #	Lower O-Ring	Lower Oil Seal	Upper O-Ring	Upper Oil Seal
7.5 (2cyl)	2810637	3801457	N/A	N.L.A	18-7152	N/A
7.5 (75) (2cyl)	3274633	& UP	N/A	N/A	18-7152	N/A
7.5 (7.5, 75)	3801458	& UP	N/A	N/A	18-7152	N/A
9.8 (110)	1865779	2798056	N/A	N.L.A	18-7152	N.L.A
9.8 (110)	2798057	3795657	N/A	N.L.A	18-7152	N/A
9.8 (2cyl)	2810637	3274633	N/A	N/A	18-7152	N/A
9.8 (9.8, 110)	3795658	& UP	N/A	N/A	18-7152	N/A
9.8 (2cyl)	3274633	& UP	N/A	N/A	18-7152	N/A
10 (100)	1290910	1499331	N/A	18-2026	N.L.A.	N.L.A
110 (2cyl)	2810637	3274633	N/A	N/A	18-7152	N/A
110 (2cyl)	3274633	& UP	N/A	N/A	18-7152	N/A
15 (150)	1290910	1499331	N/A	18-2026	N.L.A.	N.L.A
15 (SEA PRO)	G044365	G437999	N/A	18-0537	N/A	N/A
15 (SEA PRO)	G438000	& UP	N/A	26-12566 1	N/A	N/A
15 (SUPER)	B238464	& UP	N/A	18-0537	N/A	N/A
15 (18, 18XD)	5837437	& UP	N/A	18-0537	N/A	N/A
20 (200)	1290910	1499331	N/A	18-2026	N.L.A.	N.L.A
20 (200)	1558310	2031773	N/A	18-2026	N.L.A.	N/A
20 (2cyl)	2031774	2827677	N/A	N/A	18-7151	N/A
20 (20, 200)	2827677	6443972	N/A	18-2056	18-7151	N/A
20 (20, 20XD)	6443973	T800749	N/A	18-0537	N/A	N/A
20 JET	G044027	& UP	N/A	18-0537	N/A	N/A
25 (250)	1290910	1499331	N/A	18-2026	N.L.A.	N.L.A
25 (25, 25XD) (2cyl)	5705532	& UP	N/A	18-0537	N/A	N/A
30 (2cyl)	1271885	1448139	18-7151	N.L.A	18-7151	18-2016
30 (2cyl) 644cc	G053314	& UP	18-7176	18-2016	N/A	N/A
30 (2cyl) 430cc	G575500	& UP	N/A	18-2016	N/A	N/A
30 JET (4cyl)	C159200	D279349	18-7161	18-2016	18-7151	18-2016
30 JET (4cyl)	D279350	& UP	18-7161	18-2016	18-7151	18-2016
30 JET (3cyl)	G531301	& UP	18-7176	18-2016	N/A	N/A
MK 35A (2cyl)	1217222	1271884	18-7151	N/A	18-7151	N/A
35 (350)	1271884	1448139	18-7151	N.L.A	18-7151	18-2016
35 (2cyl)	1356948	1571113	18-7151	N/A	18-7151	N/A
35 (2cyl)	1571114	2874703	18-7151	N/A	18-7172	N.L.A
35 (2cyl)	6445653	& UP	18-7414	18-2016	18-7167	18-2016
40 (402) (2cyl)	1279685	1476509	18-7151	N/A	18-7151	18-2016
40 (4cyl)	1279685	2874703	18-7151	N/A	18-7151	N/A
40 (2cyl)	2874704	3336257	N/A	18-2016	18-7167	18-2016
40 (2cyl)	3336258	3346479	N/A	18-2016	18-7961	18-2016
40 (2cyl)	3336258	4117709	N/A	N/A	18-7167	N/A
40 (2cyl)	4117710	& UP	18-7414	18-2016	18-7167	18-2016
40 (2cyl)	5556230	6445653	18-7414	N/A	18-7167	N/A
40 (4cyl)	C159200	D279349	18-7161	18-2016	18-7151	18-2016
40 (402) (2cyl)	3477010	4117709	N/A	18-2016	N/A	18-2016
40 (2cyl) 644cc	G053314	& UP	18-7176	18-2016	N/A	N/A
40 (4cyl)	D279350	& UP	18-7161	18-2016	18-7151	18-2016
40 (3cyl)	G531301	& UP	18-7176	18-2016	N/A	N/A
45 (450) (4cyl)	1476510	1531568	18-7151	N.L.A	18-7151	18-2016
45 (4cyl)	5531630	& UP	18-7151	18-7151	18-7151	18-2016
45 JET	D000750	G589999	18-7176	18-2016	18-7176	N/A
45 JET	G590000	& UP	18-7176	18-2016	N/A	N/A
50 (500) (4cyl)	1421113	1639472	18-7151	18-7151	18-7151	18-2016
50 (500) (4cyl)	1639473	2858813	18-7151	N/A	18-7151	18-2016
50 (50, 500) (4cyl)	2855514	& UP	18-7151	18-2016	18-7151	18-2016
50 (3cyl)	D000750	G589999	18-7176	18-2016	N/A	N/A
50 (3cyl)	6428681	D000750	18-7161	18-2016	18-7415	18-2016
50 (3cyl)	D000750	& UP	18-7176	N/A	N/A	N/A
50 (3cyl)	G590000	& UP	18-7176	18-2016	N/A	N/A
55 (3cyl)	D000750	G589999	18-7176	18-2016	N/A	N/A
55 (3cyl)	G590000	& UP	18-7176	18-2016	N/A	N/A
60 (3cyl)	6428681	D000749	18-7161	18-2016	18-7415	18-2016
60 (3cyl)	D000750	& UP	18-7176	N/A	N/A	N/A
60 (600) (4cyl)	1303411	1542744	18-7151	N/A	18-7151	18-2016
60 (3cyl)	D000750	G589999	18-7176	18-2016	N/A	N/A
65 (650) (4cyl)	1542745	2803561	18-7151	N/A	18-7172	18-2016
65 (650) (4cyl)	2803562	3203183	18-7151	18-2016	18-7172	18-2016
65 (650) (3cyl)	3293184	4571651	18-7161	18-2016	18-7167	18-2016
65 (3cyl)	3547987	4571651	18-7161	N/A	18-7415	N/A
65 JET	D283222	& UP	N/A	18-2016	18-7414	18-0523
70 (700) (6cyl)	1296411	1566239	18-7151	N/A	18-7151	18-2016
70 (3cyl)	4571652	6428680	18-7161	18-2016	18-7415	18-2016
70 (3cyl)	A996142	B240450	N/A	18-2016	18-7414	18-0523

APPLICATION CHART CONTINUES ON NEXT PAGE

POWERHEAD SEALS & O-RING APPLICATION (Cont.)

Model	Beginning Serial #	Ending Serial #	Lower O-Ring	Lower Oil Seal	Upper O-Ring	Upper Oil Seal
70 (3cyl)	B240451	& UP	18-0858	18-2016	18-7414	18-0523
75 (4cyl)	6432901	& UP	18-7161	18-2016	18-7961	18-2016
75 (3cyl)	C222000	& UP	N/A	18-2016	18-7414	18-0523
80 (800) (6cyl)	1335465	1566239	18-7151	N/A	18-7151	18-2016
80 (800) (4cyl)	2559001	3493912	18-7151	18-2016	18-7961	18-2016
80 (80, 800) (4cyl)	4831999	6432900	18-7161	18-2016	18-7961	18-2016
80 (3cyl)	A996142	B240450	N/A	18-2016	18-7414	18-0523
80 (3cyl)	B240451	& UP	18-0858	18-2016	18-7414	18-0523
80 JET	D283222	G760299	N/A	18-2016	18-7414	18-0523
80 JET w/ROUND UPPER O-RING	G760300	& UP	N/A	18-2016	18-7414	18-0523
80 JET w/SQUARE UPPER O-RING	G760300	& UP	N/A	18-2016	N/A	18-0523
85 (850) (6cyl)	1460999	1464848	18-7151	N/A	18-7151	18-2016
85 (850) (6cyl)	1566240	1766823	18-7151	N/A	N.L.A.	18-2016
85 (850) (4cyl)	3493913	4831998	18-7161	18-2016	18-7961	18-2016
90 (900) (6cyl)	1766824	1869775	18-7151	N/A	N.L.A.	18-2016
90 (90, 900) (6cyl)	4845301	& UP	18-7161	18-2016	18-7961	18-2016
90 (3cyl)	A996142	B240450	N/A	18-2016	18-7414	18-0523
90 (3cyl)	B240451	C221999	18-0858	18-2016	18-7414	18-0523
90 (3cyl)	C222000	& UP	N/A	18-2016	18-7414	18-0523
95 (950) (6cyl)	1869776	2318585	18-7151	N/A	N.L.A.	18-2016
100 (1000) (6cyl)	1464949	2318585	18-7151	N/A	N.L.A.	18-2016
100 (1000SS) (6cyl)	2318586	2413847	18-7151	N/A	N.L.A.	18-2016
100 (1000SS) (6cyl)	2484633	2836018	18-7151	18-2016	N.L.A.	18-2016
100 (1000BP) (6cyl)	2399698	2641854	18-7151	18-2016	N.L.A.	18-2016
100 (1000BP) (6cyl)	2641855	3253111	18-7151	18-2016	18-7961	18-2016
100 (4cyl)	B209468	G760299	N/A	18-2016	18-7414	18-0523
100 w/ROUND UPPER O-RING (4cyl)	G760300	& UP	N/A	18-2016	18-7414	18-0523
100 w/SQUARE UPPER O-RING (4cyl)	G760300	& UP	N/A	18-2016	25-858225	18-0523
110 (1100)	1870201	2314955	18-7151	N/A	N.L.A.	18-2016
115 (1150) (6cyl)	2836019	3525440	18-7151	18-2016	18-7961	18-2016
115 (115, 1150) (6cyl)	3525441	& UP	18-7161	18-2016	18-7961	18-2016
115 (4cyl)	C100000	G760299	N/A	18-2016	18-7414	18-0523
115 w/ROUND UPPER O-RING (4cyl)	G760300	& UP	N/A	18-2016	18-7414	18-0523
115 w/SQUARE UPPER O-RING (4cyl)	G760300	& UP	N/A	18-2016	N/A	18-0523
115 DFI (1.5L)	T801000	& UP	N/A	18-2016	N/A	N/A
115 PRO XS	B751825	& UP	N/A	18-2016	N/A	N/A
125 (1250) (6cyl)	2314956	2839368	18-7151	N/A	18-7961	18-2016
125 (4cyl)	D283222	G760299	N/A	18-2016	18-7414	18-0523
125 w/ROUND UPPER O-RING (4cyl)	G760300	& UP	N/A	18-2016	18-7414	18-0523
125 w/SQUARE UPPER O-RING (4cyl)	G760300	& UP	N/A	18-2016	N/A	18-0523
135 (1350) (6cyl)	2839369	3293233	18-7151	18-2016	18-7961	18-2016
140 (140, 1400) (6cyl)	3293234	& UP	18-7161	18-2016	18-7961	18-2016
150 (1500) (6cyl)	3502806	4865677	18-7161	18-2016	18-7961	18-2016
150 (1500XS) (6cyl)	4868648	5327662	18-7161	18-2016	18-7961	18-2016
V-105 JET	D082000	& UP	18-0860	18-2016	18-0858	18-2016
V-135 CARB w1.50 ID UPPER BRG	A904646	C100860	18-0860	18-2016	18-0858	18-2016
V-135 CARB w1.37 ID UPPER BRG	A904646	C100860	18-0860	18-2016	18-0858	18-2016
V-135 CARB	C100861	& UP	18-0860	18-2016	18-0858	18-2016
V-135 CARB	C239553	& UP	18-0860	18-2016	18-0858	18-2016
V-135 DFI	G590000	& UP	18-0860	18-2016	18-0858	18-2016
V-140 JET	D082000	& UP	18-0860	18-2016	18-0858	18-2016
V-150 (V-1500) CARB	4868998	A904645	N/A	18-2016	N/A	18-2016
V-150 w1.50 ID UPPER BRG	A904646	C100860	18-0860	18-2016	18-0858	18-2016
V-150 w1.37 ID UPPER BRG	A904646	C100860	18-0860	18-2016	18-0858	18-2016
V-150 CARB	C100861	C239552	18-0860	18-2016	18-0858	18-2016
V-150 XR4 / MAGNUM II	B242885	C239552	18-0860	18-2016	18-0858	18-2016
V-150 CARB	C239553	& UP	18-0860	18-2016	18-0858	18-2016
V-150 XR4 / 6 MAG II, III	C239553	& UP	18-0860	18-2016	18-0858	18-2016
V-150 EFI	D082000	& UP	18-0860	18-2016	18-0858	18-2016
V-150 DFI	G590000	& UP	18-0860	18-2016	18-0858	18-2016
V-175 (V-175, 1750) CARB	4301235	5393736	N/A	18-2016	N/A	18-2016
V-175 CARB	5393737	6618750	N/A	18-2016	N/A	18-2016
V-175 CARB	6618751	C239552	18-0860	18-2016	18-0858	18-2016
V-175 CARB	C239553	& UP	18-0860	18-2016	18-0858	18-2016
V-175 EFI	D000750	& UP	18-0860	18-2016	18-0858	18-2016
V-175 DFI	T178500	& UP	18-0860	18-2016	18-0858	18-2016
V-175 PRO XS	B516339	& UP	18-0860	18-2016	18-0858	18-2016
V-200 (V-200, 2000) CARB	4839034	5363917	25-67207	18-2016	N/A	18-2016
V-200 CARB	5363918	6073191	N/A	18-2016	N/A	18-2016
V-200 CARB	6073192	C291519	18-0860	18-2016	18-0858	18-2016
V-200 CARB	C291520	& UP	18-0860	18-2016	18-0858	18-2016
V-200 EFI	C100861	C291519	18-0860	18-2016	18-0858	18-2016

APPLICATION CHART CONTINUES ON NEXT PAGE

POWERHEAD SEALS & O-RING APPLICATION

Model	Beginning Serial #	Ending Serial #	Lower O-Ring	Lower Oil Seal	Upper O-Ring	Upper Oil Seal
V-200 EFI (2.5L)	C291520	& UP	18-0860	18-2016	18-0858	18-2016
V-200 DFI	G386496	& UP	18-0860	N/A	18-7414	N/A
V-200 PRO XS	B504989	& UP	18-0860	N/A	18-7414	N/A
V-200 LASER	B117316	& UP	18-0860	18-2016	18-0858	18-2016
V-225 (2.4L)	5628028	& UP	18-0860	18-2016	N/A	18-2016
V-225 (3.0L) SEA PRO / MARATHON CARB	G245605	G303045	18-0860	N/A	18-7414	N/A
V-225 (3.0L) SEA PRO / MARATHON CARB	G303046	& UP	18-0860	N/A	18-7414	N/A
V-225 DFI	G590000	& UP	18-0860	N/A	18-7414	N/A
V-225 PRO XS	B104549	& UP	18-0860	N/A	18-7414	N/A
V-225 EFI	G129222	G303045	18-0860	N/A	18-7414	N/A
V-225 EFI	G303046	& UP	18-0860	N/A	18-7414	N/A
V-250 w/o UPPER BEARING FITTING	C101891	& UP	N/A	N.L.A	18-7414	18-2016
V-250 w/UPPER BEARING FITTING	C101891	& UP	N/A	N.L.A	18-7414	18-2016
V-250 EFI	G129222	G303045	18-0860	N/A	18-7414	N/A
V-250 EFI	G303046	& UP	18-0860	N/A	18-7414	N/A
V-250 DFI	B528615	& UP	18-0860	N/A	18-7414	N/A
V-250 PRO XS	B426561	& UP	18-0860	N/A	18-7414	N/A
V-275 CARB w/o UPPER BEARING FITTING	C101891	& UP	N/A	N.L.A	18-7414	N/A
V-275 CARB w/UPPER BEARING FITTING	C101891	& UP	N/A	N.L.A	18-7414	N/A
V-300 (3.4L)	5611648	& UP	N/A	N.L.A	18-7414	N/A

① Requires 2 ② Shift Shaft Retainer ④ Fits most applications

LOWER UNIT O-RING APPLICATION

HP	Beg. S/N	End S/N	Bearing Carrier	Water Pump Base	Shift Shaft	Drive Shaft
3.9	1655013	2498135	18-7121	18-7156	18-7180	18-7168
4	2498136	5589201	18-7121	18-7156	18-7180	18-7168
4/4.5	5589203	A809601	18-7171	18-7156	18-7180	-
6	1408611	2529894	18-7171	18-7156	18-7180	18-7168
6	A197112	UP	18-7162	-	-	-
7.5	2529895	3801457	18-7171	18-7156	18-7180	18-7168
7.5	3801458	5206549	18-7171	18-7156	18-7180	-
7.5	5206550	UP	18-7171	18-7156	18-7180	18-7116
8	A197112	UP	18-7162	-	-	-
9.8	1470349	3795657	18-7171	18-7156	18-7180	18-7168
9.8	3795658	5206549	18-7171	18-7156	18-7180	-
9.8	5206550	UP	18-7171	18-7156	18-7180	18-7116
9.9/15	A197112	UP	18-7162	-	-	-
18	5837437	6443972	-	18-7419	-	-
20	1558310	1866494	18-7163	18-7164	18-7180	18-7180
20	1866495	6443972	18-7163	18-7164	18-7180	18-7180
25	5705532	6443972	-	18-7419	-	-
18/20/25XD	6443973	UP	-	18-7419	18-7135 ②	-
30	1271885	1356947	18-7152	18-7115	18-7153	-
30	G055314	UP	-	-	18-7155 ②	-
MK 35A	1217222	1271884	18-7152	18-7115	18-7153	-
35	1356948	1448139	18-7152	18-7115	18-7153	-
35	1571114	1960826	18-7160	18-7155	18-7153	-
35	1960827	2874703	18-7160	18-7155	18-7153	-
35	6445653	UP	18-7160	18-7115	18-7153	-
40	1279685	2874703	18-7152	18-7115	18-7153	-
40	2874704	3336257	18-7160	18-7155	18-7153	-
40	3336258	4117709	18-7160	18-7155	18-7153	-
40	4117710	4860102	18-7160	18-7155	18-7153	-
40	4860103	6445652	18-7160	18-7115	18-7153	-
40 4cyl	C159200	G053313	18-7160	18-7115	18-7153	-
40 2cyl	G055314	UP	-	-	18-7155 ②	-
45	1476510	1531568	18-7160	18-7155	18-7153	-
45 4cyl	5531630	UP	18-7160	18-7115	18-7153	-
50	1421113	1639472	18-7152	18-7155	18-7153	-
50	1639473	1770178	18-7160	18-7155	18-7153	-

① Requires 2 ② Shift Shaft Retainer ④ Fits most applications

LOWER UNIT O-RING APPLICATION

HP	Beg. S/N	End S/N	Bearing Carrier	Water Pump Base	Shift Shaft	Drive Shaft
50	1770179	2305100	18-7160	18-7155	18-7153	-
50	2305101	2858813	18-7160	18-7155	18-7153	-
50	2858814	4140999	18-7160	18-7155	18-7153	-
50	4141000	4962055	18-7160	18-7155	18-7153	-
50	4962056	5531630	18-7160	18-7155	18-7153	-
50 3cyl	6428681	D000750	18-7160	18-7155	18-7153	-
50/55/60 3 cyl	D000751	UP	-	18-7173	-	-
60	1303411	1542744	-	18-7115	-	-
60	6428681	D000750	18-7160	18-7155	18-7153	-
65	1542745	2874263	18-7157	18-7173	18-7153	18-7158
65	2874263	3293183	18-7157	18-7162	18-7153	18-7158
65 3cyl	3293184	4136684	18-7160	18-7155	18-7153	-
65 3cyl	4136685	4571651	18-7160	18-7155	18-7153	-
70	1296411	1413610	18-7114	18-7155 ①	-	-
70	1413611	1566239	18-7157	18-7173	18-7153	18-7158
70 3cyl	4571652	4977156	18-7160	18-7155	18-7153	-
70 3cyl	4977157	5579016	18-7160	18-7115	18-7153	-
70 3cyl	5579017	A996142	18-7160	18-7115	18-7153	-
70/75 3cyl	A996142	UP	-	-	18-7198	-
75 4cyl	6432901	A996142	18-7157	18-7162	18-7153	-
80	1335465	1398629	18-7157	18-7155	18-7153	18-7158
80	1398630	1566239	18-7157	18-7173	18-7153	18-7158
80 4cyl	2559001	3144218	18-7157	18-7173	18-7153	18-7158
80 4cyl	3144219	4831998	18-7157	18-7162	18-7153	-
80 4cyl	4831999	5582561	18-7157	18-7162	18-7153	-
80 4cyl	5582562	A996142	18-7157	18-7162	18-7153	-
80 3cyl	A996142	UP	-	-	18-7198	-
85	1460999	1766823	18-7157	18-7173	18-7153	18-7158
85 4cyl	3493913	4590511	18-7157	18-7162	18-7153	-
85 4cyl	4590512	4831998	18-7157	18-7162	18-7153	-
90	1766824	1869775	18-7157	18-7162	18-7153	18-7158
90	4845301	5594656	18-7157	18-7162	18-7153	-
90	5594657	A996142	18-7157	18-7162	18-7153	-
90 3cyl	A996142	UP	-	-	18-7198	-
95	1869776	2318585	18-7157	18-7173	18-7153	18-7158
100,100SS	1464949	2836018	18-7157	18-7173	18-7153	18-7158
100BP	2399698	2641854	18-7157	18-7173	18-7153	18-7158
100 4cyl	B209468		-	-	18-7198	-
110	1870204	2314955	18-7157	18-7173	18-7153	18-7158
115	2836019	3525440	18-7157	18-7173	18-7153	18-7158
115	3525440	41122634	18-7157	18-7173	18-7153	-
115	41122635	4855152	18-7157	18-7162	18-7153	-
115	4855153	5600966	18-7157	18-7162	18-7153	-
115	5600967	C100000	18-7157	18-7162	18-7153	-
115 4cyl	C100000	UP	-	-	18-7198	-
125	2314956	2839368	18-7157	18-7173	18-7153	18-7158
135	2839369	3293233	18-7157	18-7173	18-7153	18-7158
140	3293234	3502805	18-7157	18-7173	18-7153	-
140	4865678	UP	18-7157	18-7162	18-7153	-
150	3502806	4121434	18-7157	18-7173	18-7153	-
150	4121434	5327662	18-7157 ④	18-7162	18-7153	-

V-6

HP	Beg. S/N	End S/N	Bearing Carrier	Water Pump	Shift Shaft	Drive Shaft
150/150XR2	4868998	5432021	18-7159	18-7162	18-7153	-
150/150XRS	5432021	A904646	18-7159	18-7176	18-7153	-

① Requires 2

② Shift Shaft Retainer

④ Fits most applications

V-6 (Cont.)

HP	Beg. S/N	End S/N	Bearing Carrier	Water Pump	Shift Shaft	Drive Shaft
135/150/XR2	A904646	UP	18-7159	18-7176	18-7153	-
175	4301235	6618750	18-7159	18-7162	18-7153	-
175	6618751	UP	18-7159	18-7176	18-7153	-
200	4839034	6073191	18-7159	18-7162	18-7153	-
200	6073192	UP	18-7159	18-7176	18-7153	-
220	B117316	UP	18-7159	18-7176	18-7153	-
225	5628028	D280813	18-7159	18-7162	18-7153	-
250/275	C101891	UP	18-7159	-	18-7153	-
3.4	5611648	UP	18-7159	-	18-7153	-

SWIVEL BRACKET ASSEMBLY O-RING APPLICATION

HP	Beg. S/N	End S/N	O-Ring	Qty	Desc	HP	Beg. S/N	End S/N	O-Ring	Qty	Desc
3.9	1655013	2498135	18-7153	2	SB	V 135	A904646	UP	18-7174	1	TT
4	2498136	3529445	18-7153	1	SB	V 150	4868998	UP	18-7164	1	SB
6	1436115	2529894	18-7153	2	SB	V 150	5432022	6606990	18-7168	2	TLL
7.5	2529895	3488152	18-7153	2	SB	V 150	6443213	UP	18-7174	1	TT
9.9	1470349	3482752	18-7153	2	SB	V 175	4301235	UP	18-7164	1	SB
35 ①	B110789	C159199	18-7164	1	SB,U	V 175	5488752	6618750	18-7168	2	TLL
35 ①	B110789	C159199	18-7174	1	TT	V 175	6618751	UP	18-7174	1	TT
45 4 Cyl ①	B110789	UP	18-7174	1	TT	V 200	4839034	UP	18-7164	1	SB
45 4 Cyl ①	B110789	UP	18-7164	1	SB,U	V 200	5464486	6625220	18-7168	2	TLL
50 3 Cyl ①	B122930	C160935	18-7164	1	SB,U	V 200	6625221	UP	18-7174	1	TT
50 3 Cyl ①	B122930	C160935	18-7174	1	TT	V 200 EFI	C100861	UP	18-7174	1	TT
60 3 Cyl ①	B122930	C160935	18-7174	1	TT	V 200 EFI	C100861	UP	18-7164	1	SB
60 3 Cyl ①	B122930	C160935	18-7164	1	SB,U	V 220	B117316	UP	18-7174	1	TT
70	A996142	UP	18-7174	2	TT	V 220	B117316	UP	18-7164	1	SB
70	A996142	UP	18-7164	1	SB	V 225	5628028	UP	18-7164	1	SB
75	6432901	UP	18-7174	2	TT	V 225	5628028	UP	18-7168	2	TLL
75	6432901	UP	18-7164	1	SB	V 250	C101891	UP	18-7168	2	TLL
80	A996142	UP	18-7164	1	SB	V 250	C101891	UP	18-7174	1	TT
80	A996142	UP	18-7174	2	TT	V 275	C101891	UP	18-7174	1	TT
90	6436123	UP	18-7164	1	SB	V 275	C101891	UP	18-7168	2	TLL
90	6436123	UP	18-7174	2	TT	3.4 LT	5611648	UP	18-7168	2	TLL
100	B209468	UP	18-7164	1	SB	3.4 LT	5611648	UP	18-7174	1	TT
100	B209468	UP	18-7174	1	TT	3.4 LT	5611648	UP	18-7164	1	SB
115	6436123	UP	18-7164	1	SB	XR-4/Magnum II	B242885	UP	18-7174	1	TT
115	6436123	UP	18-7174	2	TT	XR-4/Magnum II	B242885	UP	18-7164	1	SB
V 135	A904646	UP	18-7164	1	SB						

① Models with power trim only TLL Tilt Lock Lever
 SB,U Swivel Bracket, Upper TT Tilt Tube
 SB Swivel Bracket





18-5225
SPARK PLUG WIRE KIT
 Kit includes 25 ft. Roll of 7 MM Hypalon Ignition Wire With a MetAllic Core and a Large Assortment of Three Different End Fittings to Fit Outboard Motors.



18-5226
IGNITION WIRE
 MetAllic Core
 100' Spool
 7mm Hypalon

PKG. OF 10



18-5224
18-5224-9①
SPARK PLUG WIRE TERMINAL

PKG. OF 10



18-5750
18-5750-9①
UNIVERSAL SPARK PLUG BOOTS
 Supplied complete w/Terminal Connector



18-5752
UNIVERSAL SPARK PLUG BOOT
 8mm



18-5133
IGNITION COIL
 Replaces: 3A0060401M, 3A0060481M
 Fits: 2002 and Prior M and NS Model 25C2, C3, 30A3, A4; 2003 25C3, A4; 2005 25C3



18-5134
CDI
 Replaces: 3G2060602M
 Fits: 2002 and Prior M and NS Model 15D2, 18E, E2, 9.9D, D2; 2003 15D2, 18E2, 9.9D2



18-5143
EXCITER COIL
 Replaces: Tohatsu 369060210M
 Fits: 4C, 5B, 5BS (2003)



18-5165
EXCITER COIL
 Replaces: Nissan 3G3060211M
 Fits: 9.9D(2002 and below)/9.9D2(2003 and below), 15D(2002 and below), 15D2(2003 and below), 18E(2002 and below), 18E2(2003 and below)



18-5166
IGNITION COIL
 Replaces: Nissan/Tohatsu 3M3060482M, 3G2-06040-2
 Fits: 9.9D(2002 and below)/9.9D2(2003 and below), 15D(2002 and below), 15D2(2003 and below), 18E(2002 and below), 18E2(2003 and below)



18-5182
IGNITION COIL
 Replaces: 3F0-06153-0, 3F0060491M, 3F0061530M
 For: 2.5/3/3.3 HP



18-23207
IGNITION COIL
 Replaces: Tohatsu 3V1060400M
 Fits: Tohatsu F8/9.8 (2003 & Up)

① Priced per Package

NISSAN/TOHATSU IGNITION APPLICATION

Model	Year Start	Year Stop	Ignition Coil	CDI	Exciter Coil
FS8	2003	2014	18-23207	-	-
M15	1997	2002	-	18-5134	18-5165
M15	2003	2003	18-5166	18-5134	18-5165
M18	1997	2003	18-5166	18-5134	18-5165
M2.5	1997	2005	18-5182	-	-
M25	1997	2005	18-5133	-	-
M3.5	1997	2005	18-5182	-	-
M30	1997	2003	18-5133	-	-
M4	2003	2003	-	-	18-5143

APPLICATION CONTINUES ON NEXT PAGE

NISSAN/TOHATSU IGNITION APPLICATION

Model	Year Start	Year Stop	Ignition Coil	CDI	Exciter Coil
M5	2003	2003	-	-	18-5143
M9.9	1997	2003	18-5166	18-5134	18-5165
MFS8	2006	2014	18-23207	-	-
MFS8	2003	2004	18-23207	-	-
MFS9.8	2003	2014	18-23207	-	-
NS2.5	1997	2005	-	-	-
NS3.5	1997	2005	-	-	-
NS15	1997	2002	-	18-5134	-
NS18	1997	2002	-	18-5134	-
NS9.9	1997	2002	-	18-5134	-
NSF8	2004	2004	18-23207	-	-
NSF8	2010	2014	18-23207	-	-
NSF9.8	2005	2005	18-23207	-	-
NSF9.8	2010	2014	18-23207	-	-



18-6418
OUTBOARD STARTER

Replaces: Tohatsu 353760104M
Fits: M45A2, M50C, M60A, M70A2, M90A, M140A, NS45A2, NS50C, NS60A, NS70A2, NS90A, NSD90A, NS120A, NS140A
(9 Tooth)



18-6430
OUTBOARD STARTER

Replaces: Tohatsu B29A-90500A
Fits: 1981-on 2WT60A



18-6431
OUTBOARD STARTER

Replaces: Tohatsu 346760100M
Fits: 2cyl Engines 40C, 50C & 50A, 70A, NS25C, NS30A, NS35C, NS40C



18-6432
OUTBOARD STARTER

Replaces: Tohatsu 3C8760101M
Fits: M50D, M60B, M60C, MD40D, MD50A MFS25A, MFS30A, NS40D, NS50D, NS60C, NS70B, NS70C, NSD25A, NSD30A, NSD50A



18-6823
WIRING HARNESS

Replaces: Universal
Converts 3-wire Tilt and Trim motors to 2-Wire design



18-6448
ELECTRIC START CONVERSION KIT

Fits: Tohatsu 25 & 30 HP



18-56001
BRUSH
HOLDER ASSEMBLY

Fits: 90-140 HP 2 Stroke
Use with **18-6418** Starter Assembly



18-56002
BRUSH
HOLDER ASSEMBLY

Replaces: 3C8750140M
Fits: 25-70 HP 2 Stroke
Use with **18-6432** Starter Assembly



18-7712
FUEL FILTER (INLINE)
 Replaces: 369022300M
 Fits: 2 stroke, 5 HP thru 9.8 HP/4 stroke, 4 HP thru 30 HP



18-7828-1
(1/4" Small) Small Capacity
 (For 1/4" Fuel Line)

FUEL FILTERS



18-7830 (5/16")
18-7831 (3/8")

18-7829
(1/4" Large) Large Capacity
 (For 1/4" Fuel Line)

FUEL WATER SEPARATORS



Sierra offers a complete line of 10 and 21 micron fuel water separating filters including drainable bowl filters to protect your carbureted and fuel injected engine.

Refer to pages 136-140 for a complete listing of OEM and universal applications.

Sierra fuel water separators remove over 99.8% of emulsified water from your gasoline. Sierra's 10 micron filters are over 90% efficient at removing particles as small as 10 micron. All filters flow @ 90 GPH to feed even the hungriest motor. Sierra 10 micron filters are recommended to prevent damage to sensitive inboard and outboard fuel injection systems.



18-8002EP-1
18-8002EP-1-10②
PRIMER BULB
 1/4"

18-8004EP-1
18-8004EP-1-10②
PRIMER BULB
 5/16"
 Large capacity bulb

18-8005EP-1
18-8005EP-1-10②
PRIMER BULB
 3/8"
 Large capacity bulb



18-8078
TANK CONNECTOR
 1/4" N.P.T .508 O.D.
 Nissan Tank Large Inlet
 Fits: All models
 Mates with 18-8079
 (Male)



18-80410-1
FUEL CONNECTOR
 Replaces: 394-70250-0
 Female Hose connector
 3/8"
 Fits: 4HP-30HP 4-stroke



18-8079
FUEL CONNECTOR
 (Tank End, Quick Connect)
 Replaces: 3B2702810M,
 65750-95500
 Fits: All models
 Mates with 18-8078
 Female to 3/8" hose barb



18-8088
FUEL CONNECTOR
 (Engine End)
 Replaces: 3B2702501M
 3/8" Hose
 Fits: 5-90HP 2-stroke and TLD1 models
 Mates with 18-8089



18-8089
FUEL CONNECTOR
 (Engine End)
 Replaces: 3B2-70260-O
 (Metric Threads)
 3/8" Hose
 Fits: 5-90HP 2-stroke and TLD1 models
 Mates with 18-8088

PKG. OF 10



SNAPPER CLAMPS
18-8020 **18-8021**
18-8020-9① **18-8021-9①**
 #8 For 5/16" Hose #10 For 3/8" Hose



18-7290
CARB KIT
 Replaces: 345871224M
 Kit contains enough components
 to rebuild 2 carburetors
 For: All 35/40C HP (1 per engine)



18-7291
CARB KIT
 Replaces: 346871220M
 For: All 25/30 HP (1 per engine);
 All 45A2, 50C, 60C, 70A2 (2 per engine)



18-7765
CARB KIT
 Replaces: 369871221M
 For: All 4/5 HP (1 per engine)



18-8920
IMPELLER
Replaces: 3B2650211M
Fits: 8 (8B models), 9.8 (9.8B model), 8 4-Stroke (All), 9.8 4-Stroke (All)



18-8921
IMPELLER
Replaces: 334650210M
Fits: 9.9 (All), 15 (All), 18 (All), 9.9 4-Stroke (All B Models), 15 4-Stroke (All B Models), 18 4-Stroke(All)



18-8922
IMPELLER
Replaces: 3C8650212M
Fits: 40 3-cyl (D models), 40 TLDI 2-Stroke(All) 50 3-cyl (D models), 50 TLDI 2-Stroke (All), 70 TLDI 2-Stroke (All), 90 TLDI 2-Stroke



18-8923
IMPELLER
Replaces: 345650210M
Fits: 25 (25C model), 25 4-Stroke (All A Models, B Models with white bushing), 30 (30A model), 30 4-Stroke (All A Models, B models with white bushing), 40 2-cyl (40C model)



18-8924
IMPELLER
Replaces: 3C7650211M, 3B7650212M
Fits: 60 3-cyl (B & C models), 70 3-cyl (B & C models), MD 70, MD 90(TLDI), 115, 140, 90 2-Stroke



18-45404
IMPELLER
Replaces: 353650210M
Fits: Nissan/Tohatsu NS50C, NS60A, NS70A2(2002 & Up)



18-43175
THERMOSTAT KIT
Replaces: 3R3010300M
Fits: Nissan/Tohatsu 9.9-30 HP 4-Strokes



18-43212
WATER PUMP HOUSING
Replaces: 3B2650160M
Fits: 8/9.9 4-Stroke(209cc)



18-48317
COMPLETE WATER PUMP KIT
Replaces: 3B2873222M
Fits: F8/9.8



18-7911-1
OIL FILTER
Replaces: 3R0-07615-0
Fits: 9.9-30HP

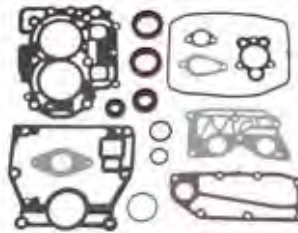

18-64221
POWERHEAD GASKET SET
Replaces: 3V1-87121-0
Fits: F8/F9.8

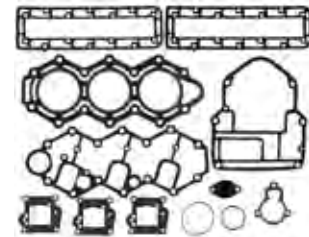

18-4434
POWERHEAD GASKET SET
Replaces: 3C8-87121-4
Fits: All 40-50 HP

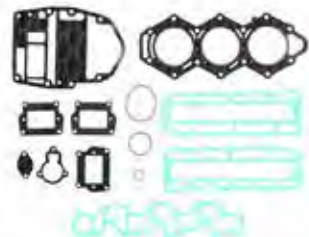

18-4435
POWERHEAD GASKET SET
Replaces: 3F3871210M
Fits: All 60-70 HP

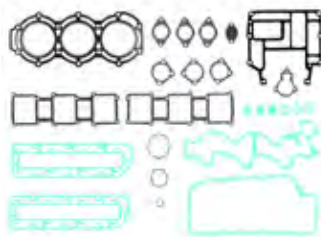

18-4436
POWERHEAD GASKET SET
Replaces: 3B7871218M
Fits: All 90 HP



18-74610
LOWER UNIT SEAL KIT
Replaces: 398873213M
Fits: 18 & 15 (1997-08); 9.9 (1997-04)



18-74611
LOWER UNIT SEAL KIT
Replaces: 346873217M
Fits: 25 (1997-05); 30 (1997-03)

① Priced per Package

② Discount shop pack of 10 - Priced per package



18-3850
HEAD GASKET
Replaces: 3C8010055M
Fits: All 40-50 HP



18-3886
HEAD GASKET
Replaces: 3T9010050M
Fits: All 90 HP



18-4299
HEAD GASKET
Replaces: 3F3010051M
Fits: All 60-70 HP



18-51000
RECOIL STARTER SPRING
Replaces: 3AA050040M
Fits: Tohatsu 8 4-Stroke(2004-12), 9.8 4-Stroke(2004-12)



18-60103
DRAIN PLUG GASKET
Replaces: 332600060M
Fits: All Nissan/Tohatsu models



18-60103-50
DRAIN PLUG GASKET
Fits: All Nissan/Tohatsu models



18-60916
CYLINDER HEAD GASKET
Replaces: 3V1010050M
Fits: F8/9.8



18-60917
CYLINDER COVER GASKET
Replaces: 3V1010240M
Fits: F8/9.8



18-60918
ENGINE BASE GASKET
Replaces: 3V1013030M
Fits: F8/9.8



18-60919
EXHAUST COVER GASKET
Replaces: 3V1023050M
Fits: F8/9.8



18-60920
THERMOSTAT GASKET
Replaces: 346-01032-0
Fits: F8/9.8



18-2448
LOWER UNIT FILL/DRAIN KIT
M8 - 1.25 thread
Fits: Yamaha, Nissan/Tohatsu, & Honda Lower Units



18-72656
DRAIN PLUG & GASKET
Replaces: Nissan-Tohatsu 332600052M, 332600060M
M8 - 1.25 thread
Fits: Nissan/Tohatsu - All Models



18-73964
PROP NUT KIT
Fits: Nissan/Tohatsu F8/9.8



18-79989
TRAILERING STICKS
Fits: Most outboards over 150HP with three ram intrigrel tilt/trim.









18-76695
O-RING
Replaces: Nissan-Tohatsu 3R0074220M
Fits: 8/9.9 s/n 0r042475 and Up

Suzuki Model Identification

Model Description	Horsepower	Model Variation Length	Shaft Year	Model
DT = 2-cycle DF = 4-cycle PU = Jet Drive	Examples: 9.9 40 115 250	E - Elec. Start w/Tiller Handle R - Elec. Start w/Remote Control C - Oil Injection G - Counter Rotation N - High Thrust Propeller T - Power Tilt & Trim w/Elec. Start w/Remote Control H - Power Tilt & Trim w/Elec. Start w/Tiller Handle SF - Super Four SS - Super Six M - Manual Start w/Tiller Handle V - Comlink Voice Caution System	S = 15" L = 20" X = 25"	D = 1983 E = 1984 F = 1985 G = 1986 H = 1987 J = 1988 K = 1989 L = 1990 M = 1991 N = 1992 P = 1993 R = 1994 S = 1995 T = 1996 V = 1997 W = 1998 X = 1999 Y = 2000 K1 = 2001 K2 = 2002 K3 = 2003 K4 = 2004 K5 = 2005 K6 = 2006 K7 = 2007 K8 = 2008

EXAMPLE: DT40CRSN - 2-cycle, 40 HP, Oil Injection, Elec. Start w/remote control, 15", 1992 Model Year

<p>PKG. OF 10</p>  <p>18-5224 18-5224-9^① SPARK PLUG WIRE TERMINAL</p>	 <p>18-5225 SPARK PLUG WIRE KIT Kit includes 25 ft. Roll of 7 MM Hypalon Ignition Wire With a Metallic Core and a Large Assortment of Three Different End Fittings to Fit Outboard Motors.</p>	 <p>18-5226 IGNITION WIRE Metallic Core 100' Spool 7mm Hypalon</p>
<p>PKG. OF 10</p>  <p>18-5750 18-5750-9^① UNIVERSAL SPARK PLUG BOOTS Supplied complete w/Terminal Connector</p>	 <p>18-5752 UNIVERSAL SPARK PLUG BOOTS 8mm</p>	 <p>18-5151 IGNITION COIL Replaces: 33410-94400, 33410-92L10 Fits: DT40C(1986-98)</p>
 <p>18-5152 IGNITION COIL Replaces: 32140-93900 Fits: DT 9.9(1983-87), DT15 (1983-88)</p>	 <p>18-5144 CDI Replaces: 32900-93911 Fits: DT15</p>	 <p>MP51010 (CLAMSHELL) MP51012 (BULK 100 PCS/CTN) IGNITION SWITCH Replaces: 37110-99E00 Colors on wires match factory color codes Suzuki 2 & 4 Stroke Outboards</p>

① Priced per Package



18-6414
OUTBOARD STARTER
 Replaces: 31100-95600
 Fits: 75 HP



18-6416
OUTBOARD STARTER
 Replaces: 31100-94610
 Fits: 115, 140 H.P. (9 Tooth) (1984-UP)



18-6417
OUTBOARD STARTER
 Replaces: 31100-92E00
 Fits: 150, 200, 225 H.P. (1985-UP)



18-6419
OUTBOARD STARTER
 Replaces: 31100-89J00
 Fits: 4 Stroke DF40 (1999-01) (9 tooth)



18-6827
STARTER
 Replaces: 31100-94600, 31100-94601,
 31100-94610
 Fits: 115, 140HP engines



18-6428
OUTBOARD STARTER
 Replaces: 31100-95313
 Fits: 50/60 HP (1984-85), 75/85 HP (1984-87)



18-6429
OUTBOARD STARTER
 Replaces: 31100-94702
 Fits: DT 55/65 (1985-88)



18-6831
STARTER
 Replaces: Suzuki 31100-90J00
 Hitachi S114-837, A
 Fits: Suzuki 90-115HP 2001-08



18-6941
STARTER
 Replaces: 31100-93J00, 96J00, 96J01
 Fits: 70-300HP 2004-up



18-6945
STARTER
 Replaces: 31100-95J00, 95J01
 Fits: Johnson, Suzuki 25HP 2006-11



18-56008
BRUSH HOLDER ASSEMBLY
 Replaces: 31173-95310
 Fits: 90-100, 150-225 HP 2 Stroke
 Use with **18-6414** Starter



18-56009
BRUSH HOLDER ASSEMBLY
 Replaces: 31173-99E00
 Fits: 115-140 HP 2 Stroke
 Use with **18-6416** Starter

18-9802
TIMING LIGHT

Self-powered accurate up to 10,000 RPM's



18-18303
POWER TRIM MOTOR

Replaces: 38100-92J02, 38100-92J10, 38100-93J01, 38100-93J02, 38100-96J00
(O-Ring included)
Fits: DF60-300(2001-07)



18-18304
POWER TRIM MOTOR

Replaces: 37100-87J00-0EP, 38100-87J0EP
(O-Ring included)
Fits: DF40(1999-00), DF50(1999-00)



18-6785
TILT/TRIM MOTOR

Replaces: 38100-87E10-0ED, 38100-87000-0IT, 38100-87E20-0ED
(O-Ring included)
For: V-4 & V-6 1986-1990
V-6/3 wire hook-up 3 bolt flange



18-6786-1
TILT/TRIM MOTOR

Replaces: 38100-87D10-0ED, 38100-87D10-35J, 38100-87D10-0IT, 38100-92E00-0ED
For: V4 & V6 (1990-up), DT90 (1991-97), DT100 & DT200 (1991-2000), DT150 & DT225 (1991-2003), DT175 (1991-92)
3 Bolt flange 2 wire connection



18-6793
TRIM MOTOR

Replaces: 38100-87J11, 38100-87J20
(O-Ring included)
Fits: DF40, DF50 (2001-08)



18-6823
WIRING HARNESS

Replaces: Universal
Converts 3-wire Tilt and Trim motors to 2-Wire design



18-5731
RELAY, STARTER

Replaces: 38860-76F01
Fits: DF9.9 2005-2010, DF15 2005-2010, DF25 2006-2010, DF40 2003-2010, DF50 2003-2010, DF60 2003-2010, DF70 2003-2010, DF80 2009-2010, DF90 2003-2010, DF100 2009-2010, DF115 2003-2010, DF140 2003-2010, DF150 2006-2010, DF175 2006-2010, DF200 2004-2010, DF225 2004-2010, DF250 2004-2010, DF300 2007-2010



4-STROKE FUEL SYSTEM KITS

18-7761
CARBURETOR REBUILD KIT

Fits: Suzuki DF4-DF6 (2005 & Up)



18-7773
CARB KIT

Replaces: 13910-89J01
Fits: DF 25/30 (All Years)

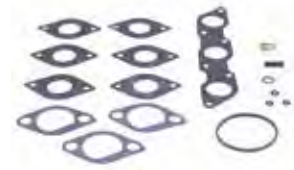

18-3495
DIAPHRAGM KIT

Replaces: 15170-93911
Fits: DT8(All 1988-97), DT9.9(All 1988-97), DT15(All 1988-97)



18-3496
DIAPHRAGM KIT

Replaces: 15170-94320
Fits: DT25(All 1989-99), DT30(All 1989-99), DT40(All 1986-98), DT55(All 1988-97), DT65(All 1988-97)



18-3497
DIAPHRAGM KIT

Replaces: 15170-91J00
DF4-DF6 (2003 & UP)



18-3498
DIAPHRAGM KIT

Replaces: 15170-94J00, 15170-94J0V
DF9.9-DF15 HP(2005 & UP)



18-3499
DIAPHRAGM KIT

Replaces: 15170-99E00
DF9.9,DF15 (1997-2004), DF25 (2000-2006) (Non-V twin), DF40,DF50 (1999-2006), DF60,DF70 (1998-2007),



2-STROKE FUEL SYSTEM KITS

18-7752
CARB KIT
Replaces: 13910-87D00



18-7753
CARB KIT
Replaces: 13910-94400



18-7754
CARB KIT
Replaces: 13910-94701



18-7755
CARB KIT
Replaces: 13910-95D00



CARBURETOR KIT APPLICATION

HP/Model	Year	Part #	HP/Model	Year	Part #	HP/Model	Year	Part #
DT25C	1989-98	18-7755	DT65	1985-97	18-7753	DT100	1989-98	18-7752
DT30C	1988-97	18-7755	DT75	1985-97	18-7754	DT115	1986-98	18-7754
DT40C	1984-98	18-7753	DT85	1985-98	18-7753	DT140	1986-98	18-7753
DT55	1985-97	18-7754	DT90	1989-97	18-7752	V-6	ALL	18-7752

FUEL WATER SEPARATORS



Sierra offers a complete line of 10 and 21 micron fuel water separating filters including drainable bowl filters to protect your carbureted and fuel injected engine.

Refer to pages 136-140 for a complete listing of OEM and universal applications.

Sierra fuel water separators remove over 99.8% of emulsified water from your gasoline. Sierra's 10 micron filters are over 90% efficient at removing particles as small as 10 micron. All filters flow @ 90 GPH to feed even the hungriest motor. Sierra 10 micron filters are recommended to prevent damage to sensitive inboard and outboard fuel injection systems.

Sierra #	Suzuki #	Description
18-7953	15410-87J30	Fuel Filter Fits: DF25, DF70, DF90, DF115, DF140 (Incl. 140T & 140Z) (2006 & Newer)
18-7936	15412-93J00	Fuel Filter Element
18-7947	99105-20006	Spin on Replacement Filter
18-7987	99105-20006-BWL	AquaVue™ Mini Collection Bowl
18-7948	99105-20005	Spin on Replacement Filter
18-7922-1	99105-20004BWL	AquaVue™ Collection Bowl
18-7735	15410-94400	Fuel Filter Kit
18-7711	15410-96J00	Fuel Filter (Inline)
18-7716	15410-87J10	Fuel Filter
18-7719	15410-98500	Fuel Filter

• Retail Packaged Item



18-32154
OXYGEN SENSOR
Replaces: 18213-98J00
Fits: DF100A, DF115A, DF140A, DF250A, (2011-Up), DF300 (2007-Up)

PRIMER BULBS



18-8002EP-1
18-8002EP-1-10^①
PRIMER BULB
 1/4"

18-8004EP-1
18-8004-10EP-1^①
PRIMER BULB
 5/16"
 Large capacity bulb

18-8005EP-1
18-8005-10PE-1^①
PRIMER BULB
 3/8"
 Large capacity bulb

18-80409
FUEL CONNECTOR
 • 1/4" barb
Motor Side
Replaces: 65720-94401
Fits: DT4-DT65
Mates with 18-80418



18-80418
FUEL CONNECTOR
 • 1/4" barb
Replaces: 65750-94404
Fits: DT4-DT140
Mates with 18-80409 & 18-809



18-80419
FUEL CONNECTOR
Replaces: 65750-87J10,
 65750-87J11
Fits: DF25-DF140 (5/16" version of
18-80404)
Mates with 18-80425



18-80425
FUEL CONNECTOR
Replaces: 65720-986B0
Fits: DF25-DF140
Mates with 18-80404 & 18-80419



18-8062
FUEL CONNECTOR
 • 3/8" barb
Replaces: 65750-98505
Mates with 18-8071



18-8071
TANK CONNECTOR
 1/4" NPT .432 O.D.
Replaces: 99105-00192
Mates with 18-8062
(Male)



18-8078
TANK CONNECTOR
 1/4" N.P.T .508 O.D.
Replaces: 65740-95500,
 99105-00193
Fits: All models
Mates with 18-8079
(Male)



18-8079
FUEL CONNECTOR
Tank End, Quick Connect
Replaces: 65750-95510,
 65750-95500
Fits: All models
Mates with 18-8078
Female to 3/8" hose barb



18-8087
FUEL CONNECTOR
 • 5/16" barb
Motor Side
Replaces: 65720-94411
Fits: DT75-DT140



18-80404
FUEL CONNECTOR
 3/8"
Fits: DF25-DF140 HP
Mates with 18-80425



18-80405
FUEL CONNECTOR
Female to 3/8" hose barb
Mates with 18-8078



18-8090
FUEL CONNECTOR
(1/4" NPT)
Mates with 18-80418



18-3000
IMPELLER
Replaces: 17461-92D02
Fits: DT 8C/9.9C (1989-97)



18-3035
IMPELLER
Replaces: 17461-93J00
For: DF200, DF225, DF250 (2004-05)



18-3049
IMPELLER
Replaces:
 17461-87E11, 17461-87E12
Fits: DF 60/70 (1998-01),
 DF 90-100 (1989-01)



18-3023
IMPELLER
Replaces:
 17461-90J00, 17461-90J01,
 17461-94500, 17461-94501,
 17461-94502, 17461-94503,
 17461-94504, 17461-94505,
 17461-94506, 17461-94510,
 17461-94511, 17461-94520
Fits: 2 Stroke DF90, DF115, DF140 (2000-
 05), DT115 (1981-01), DT140 (1981-01),
 DT150 (1986-01), DT200 (1986-00)



18-3092
IMPELLER
Replaces: 17461-93001,
 17461-93003, 17461-93004





18-3094
IMPELLER
Replaces: 17461-94700,
17461-94701



18-3095
IMPELLER
Replaces: 17461-95300,
17461-95301, 17461-95302



18-3096
IMPELLER
Replaces: 17461-96301,
17461-96311, 17461-96312



18-3097
IMPELLER
Replaces: 17461-98501,
17461-98502, 17461-98503,
17461-985M0



18-3099
IMPELLER
Replaces: 17461-93902,
17461-93901, 17461-93903
For: DT 9.9, 15 (1983-97), DF 9.9, 15 (1997-05)



18-3291
IMPELLER KEY
Replaces: 09420-05006,
09420-05009
Fits: V-6 2-Stroke (1986-03),
DF90 /115/140(2001-04)



18-3292
IMPELLER KEY
Replaces: 17462-93990,
09420-03005
Fits: DT 8C/9.9C (1989-97), DF 9.9/15
(1997-04), DT 9.9 (1985-87), DT 15
(1983-88), DT 15C (1989-97)



18-3296
IMPELLER KEY
Replaces: 09420-05005
Fits: DT 115/140 (1983-01)



18-3404
IMPELLER KEY
Replaces: 09420-04009
Fits: DF 60/70 (1998-01),
DF 90-100 (1989-01)



18-3188
IMPELLER PLATE
Replaces: 17471-98503
Fits: DT 6 (1984-02), DT 8 (1986-97)



18-3189
IMPELLER PLATE
Replaces: 17471-87D01
Fits: V-6 2-Stroke (1986-03)



18-3190
IMPELLER PLATE
Replaces: 17471-93902
Fits: DF 9.9/15 (1997-04), DT 9.9 (1985-87),
DT 15 (1983-88), DT 15C (1989-97)



18-3191
IMPELLER PLATE
Replaces: 17471-94501
Fits: DT 115/140 (1983-01)



18-3192
IMPELLER PLATE
Replaces: 17471-87E01, 17471-92J00
Fits: DF 60/70 (1998-01), DF 90-100
(1989-01), DF 90/115/140 (2001-04)



18-3193
IMPELLER PLATE
Replaces: 17471-92D10
Fits: DT 8C/9.9C (1989-97)



18-3242

IMPELLER REPAIR KIT

Replaces: 17400-96350, 17400-96351, 17400-96353

— CONTAINS —			MODEL	YEAR	MODEL	YEAR
Part #	Description	O.E. #				
18-3096	Impeller	17461-96311	DT20	1986-88	DT35	1987-89
18-0461	Gasket	17472-96301	DT25	1984-88	DT40C	1984-88
			DT30	1984-87		



18-3243

IMPELLER REPAIR KIT

Replaces: 17400-94700, 17400-94701

— CONTAINS —			MODEL	YEAR	MODEL	YEAR
Part #	Description	O.E. #				
18-3094	Impeller	17461-94700	DT55	1985-95	DT65	1985-95
18-0460	Gasket	17472-95310				



18-3244

IMPELLER REPAIR KIT

Replaces: 17400-95550, 17400-95350, 17400-95351
Fits: DT75, DT85 (1985-95)

— CONTAINS —		
Part #	Description	O.E. #
18-3095	Impeller	17461-95300
18-0459	Gasket	17472-95200



18-3253

WATER PUMP KIT

Replaces: 17400-87D11
Fits: V6 2-Stroke (1986-03)



18-3254

WATER PUMP KIT

Replaces: 17400-87E03, 17400-87E04
Fits: DF 60/70 (1998-06), DT 90-100 (1989-01)



18-3255

WATER PUMP KIT

Replaces: 17400-92D01
Fits: DT 8C/9.9C (1989-97)



18-3256

WATER PUMP KIT

Replaces: 17400-93951
Fits: DF 9.9/15 (1997-06), DT 9.9 (1985-87), DT 15 (1983-88), DT 15C (1989-97)



18-3257

WATER PUMP KIT

Replaces: 17400-94611
Fits: DT 115/140 (1983-01)



18-3258

WATER PUMP KIT

Replaces: 17400-90J11, 17400-90J20
Fits: DF 90/115/140 (2001-05)



18-3259

WATER PUMP KIT

Replaces: 17400-98551
Fits: DT 6 (1984-02), DT8 (1986-97)



18-3260

WATER PUMP KIT





Replaces: 17400-98652
Fits: DT 4 (1984-98), DT 5 (1999-02)











18-3264

WATER PUMP REPAIR KIT

Replaces: 17400-93J00, 17400-93J02
For: DF200, DF225, DF250 (2004-09)

 <p>18-3266 WATER PUMP REPAIR KIT Replaces: 17400-98661 For: DF4, DF6 (2003-07)</p>	 <p>18-3267 WATER PUMP KIT Replaces: 17400-98J00, 17400-98J01 Fits: DF300 (2007-Current)</p>	 <p>18-3480 WATER PUMP HOUSING Replaces: 17411-93901 Fits: DT9.9(1983-87, 2004-10), DT15(1983-97, 2004-10)</p>	 <p>18-3481 WATER PUMP HOUSING Replaces: 17411-94421 Fits: DF25(All models 2000-05) DF25(models DF25Q, DF25Q(QR), DF25T 2006-07), DF30(All 2000-07), DT40C(1986-98), DF40(All 2000-07), DF50(All 1999-10)</p>
---	--	---	---

 <p>18-0761 PUMP CASE GASKET Replaces: 17472-91J00 For: DF4 (2003-05), DF6 (2003-05)</p>	 <p>18-0778 PUMP CASE GASKET Replaces: 17472-93J00 For: DF150(2006-10), DF175(2006-10), DF200(2004-10), DF225(2004-10), DF250(2004-10)</p>	 <p>18-0459 WATER PUMP GASKET Replaces: 17472-95200</p>	 <p>18-0460 WATER PUMP GASKET Replaces: 17472-95310</p>	 <p>18-0461 WATER PUMP GASKET Replaces: 17472-96301</p>
---	---	--	--	--

<p>PKG. OF 5</p>  <p>18-0477-9 WATER PUMP GASKET Replaces: 17472-98503 Fits: DT 6 (1984-02), DT8 (1986-97)</p>	 <p>18-0478 WATER PUMP GASKET Replaces: 17472-93911 Fits: DF 9.9/15 (1997-04), DT 9.9 (1985-87), DT 15 (1983-88), DT 15C (1989-97)</p>	 <p>18-0479 WATER PUMP GASKET Replaces: 17472-92D10 Fits: DT 8C/9.9C (1989-97)</p>	 <p>18-0480 WATER PUMP GASKET Replaces: 17472-98611 Fits: DT 4 (1984-98), DT 5 (1999-02)</p>	 <p>18-0792 THERMOSTAT GASKET Replaces: 13119-91J00</p>
---	---	---	---	--

 <p>18-0793 THERMOSTAT GASKET Replaces: 17582-93J00</p>	 <p>18-0794 THERMOSTAT GASKET Replaces: 17685-97J00</p>	 <p>18-0795 THERMOSTAT GASKET Replaces: 17685-89J00</p>	 <p>18-0796 THERMOSTAT GASKET Replaces: 17685-99E00</p>	 <p>18-0797 THERMOSTAT GASKET Replaces: 17685-87D10</p>
--	--	--	--	--

HP/Model	Year	Impeller	Gasket	Water Pump Kit	HP/Model	Year	Impeller	Gasket	Water Pump Kit
DT2/2.2	1983-97	18-3097	—	—	DT50M	1980-84	18-3094	18-0460	18-3243
DT3.5	1983-84	18-3097	—	—	DF50	1999-09	18-3096	18-0461	18-3242
DT4	1984-98	18-3097	18-0480	18-3260	DF50	2010	18-3096	18-0461	—
DF4	2003-10	18-3097	18-0761	18-3266	DT55	1985-97	18-3094	18-0460	18-3243
DT5	1977-83, 1999-02	18-3097	18-0480	18-3260	PU55 (jet)	1989-94	18-3094	18-0460	—
DT6	1984-02	18-3097	18-0477-9	18-3259	DT60	1983	18-3094	18-0460	18-3243
DF6	2003-10	18-3097	18-0761	18-3266	DT60	1984	18-3095	18-0460	—
DT8	1980-87	18-3097	18-0477-9	18-3259	DF60	1998-09	18-3049	—	—
DT8	1988-97	18-3000	18-0479	18-3255	DF60	2010	18-3096	18-0461	—
DF8	2010	18-3099	—	—	DT65	1982-prior	18-3094	18-0459	—
DT9.9	1977-82	18-3092	—	—	DT65	1985-97	18-3094	18-0460	18-3243
DT9.9	1983-87	18-3099	18-0478	18-3256	DF70	1998-09	18-3049	—	—
DT9.9	1988-97	18-3000	18-0479	18-3255	DF70	2010	18-3096	18-0461	—
DF9.9	1997-10	18-3099	18-0478	18-3256	DT75	1983-97	18-3095	18-0459	18-3244
DT14	1977-80	18-3092	—	—	DF80	2009-10	18-3049	—	—
DT15	1983-97	18-3099	18-0478	18-3256	DT85	1983-00	18-3095	18-0459	18-3244
DT15C	1989-97	18-3099	18-0478	—	PU85 (jet)	1989-97	18-3095	18-0459	—
DF15	1997-10	18-3099	18-0478	18-3256	DT90	1989-97	18-3049	—	18-3254
DT16	1977-82	18-3092	—	—	DF90	2001-08	18-3023	—	—
DT20	1986-88	18-3096	18-0461	18-3242	DF90	2009-10	18-3049	—	—
DT25	1980-82	18-3092	—	—	DT100	1987-01	18-3049	—	18-3254
DT25	1983-88	18-3096	18-0461	18-3242	DF100	2009-10	18-3023	—	—
DF25	2000-06	18-3096	18-0461	18-3242	DT115	1986-01	18-3023	—	18-3257 **
DF25 V-Twin	2006-10	18-3096	18-0461	—	DF115	2001-10	18-3023	—	18-3258 *
DT30	1983-87	18-3096	18-0461	18-3242	DT140	1986-01	18-3023	—	18-3257
DT30	1988-97	—	18-0461	—	DF140	2002-10	18-3023	—	—
DF30	2000-07	18-3096	18-0461	18-3242	DT150	1986-03	18-3023	—	18-3253
DT35	1980-82	18-3094	18-0459	—	DF150	2006-10	18-3023	18-0778	—
DT35	1987-89	18-3096	18-0461	18-3242	DT175	1987-92	18-3023	—	18-3253
DT40	1980-82	18-3094	18-0459	—	DF175	2006-10	18-3023	18-0778	—
DT40	1983	18-3094	18-0460	—	DT200	1986-00	18-3023	—	18-3253
DT40/DT40C	1984-98	18-3096	18-0461	18-3242	DF200	2004-10	18-3035	18-0778	18-3264
DF40	1999-09	18-3096	18-0461	18-3242	DT225	1990-03	18-3023	—	18-3253
DF40	2010	18-3096	18-0461	—	DF225	2004-10	18-3035	18-0778	18-3264
PU40 (jet)	1989-94	18-3096	18-0461	—	DF250	2004-10	18-3035	18-0778	18-3264
DT50	1982-prior	18-3094	18-0459	—	DF300	2007-10	18-3035	18-0651	18-3267
DT50	1983-84	18-3094	18-0460	18-3243					





① Priced per Package

* SN 681517 & earlier

** SN 812175 & Later





		O.E. INTERCHANGE		
		Part #	Description	O.E. #
		18-39480	Piston Rings	12140-93121
		18-39530	Piston Rings	12140-96351-050
		18-39540	Piston Rings	12140-94400
		18-40110	Piston Kit	12110-94400
		18-40140	Piston Kit	12110-93120
		18-42850	Piston Pin	12151-94400
		18-42860	Wrist Pin	12151-93100
		18-42870	Wrist Pin	12151-92502
		18-42940-9 ① ②	Circlips	09381-14001
		18-42950-9 ① ②	Circlips	09381-18002
		18-42960-9 ① ②	Circlips	09381-20003

HP/Model	Years	PISTON		RINGS		WRIST PIN		CIRCLIP	
		Std.	.50mm	Std.	.50mm	Std.	.50mm	Std.	.50mm
DT9.9	1983-87	18-40140	—	18-39480	—	18-42860	—	18-42940-9	—
DT15	1983-88	18-40140	—	18-39480	—	18-42860	—	18-42940-9	—
DT25	1983-88	—	—	—	18-39530	—	18-42870	—	18-42950-9
DT30	1983-87	—	—	—	18-39530	—	18-42870	—	18-42950-9
DT40	1984-98	18-40110	—	18-39540	—	18-42850	—	18-42960-9	—

 <p>18-1757 CONNECTING ROD Replaces: 12161-93902 Fits: DT9.9, DT15 (1983-97)</p>	 <p>18-1758 CONNECTING ROD Replaces: 12161-96300, 12161-91L00 Fits: DT25 (1983-88), DT30 (1983-87)</p>	 <p>18-1759 CONNECTING ROD Replaces: 12161-94400, 12161-92L00 Fits: DT 40 (1984-98)</p>	 <p>18-1757K CONNECTING ROD KIT Replaces: 12161-93902 Fits: DT9.9 (1983-87), DT15 (1983-97)</p>
--	---	---	--

 <p>18-1759K CONNECTING ROD KIT Replaces: 12161-94400 Fits: DT40 (1986-98)</p>	 <p>18-1412 ROD BEARING Replaces: 09263-20051 Fits: DT9.9 (1983-87), DT15 (1983-97)</p>	 <p>18-1414 ROD BEARING Replaces: 09263-14022 Fits: DT9.9 (1983-87), DT15 (1983-97), DT14/16 (1980-82)</p>	 <p>18-1415 ROD BEARING Replaces: 09263-18016 Fits: DT25 (1983-88), DT30 (1983-87)</p>
---	---	---	--

 <p>18-1416 ROD BEARING Replaces: 09263-27005 Fits: 40 (1984-98)</p>	 <p>18-1417 WRIST PIN BEARING Replaces: 09263-20072 Fits: 40 (1984-98)</p>	 <p>18-3806 HEAD GASKET Replaces: 11141-98401, 11141-98411</p>	 <p>18-3807 HEAD GASKET Replaces: 11141-98101, 11141-98130</p>
--	---	--	---

 <p>18-3808 HEAD GASKET Replaces: 11141-93901, 11141-93960</p>	 <p>18-3809 HEAD GASKET Replaces: 11141-96303, 11141-96344</p>	 <p>18-3810 HEAD GASKET Replaces: 11141-94401, 11141-94450</p>	 <p>18-3813 HEAD GASKET Replaces: 11141-95305, 11141-95320</p>
--	---	--	---



18-3814
HEAD GASKET
Replaces: 11141-95505, 11141-95512



18-3816
HEAD GASKET
Replaces: 11141-98504, 11141-98510, 11141-98522

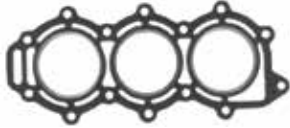

18-3819
HEAD GASKET
Replaces: 11141-95D90, 11141-95D10

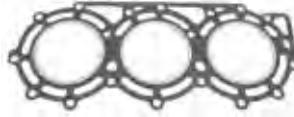

18-3820
HEAD GASKET
Replaces: 11141-94701, 11141-94702, 11141-94720

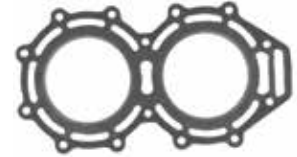

18-3822
HEAD GASKET
Replaces: 11141-87E90, 11141-87E10



18-3823
HEAD GASKET
Replaces: 11141-94506, 11141-94620



18-3824
HEAD GASKET
Replaces: 11141-94600, 11141-94620



18-3825
HEAD GASKET
Replaces: 11141-87D90, 11141-87D60

Model	Year	Cyl	Head Gasket	Model	Year	Cyl	Head Gasket	Model	Year	Cyl	Head Gasket
2	1983-89	1	18-3806	25	1989	3	18-3819	85	1983-87	3	18-3814
5	1983	2	18-3816	30	1983-87	2	18-3809	90	1989	V-4	18-3822
6	1984-89	2	18-3807	30	1988-89	3	18-3819	100	1989	V-4	18-3822
8	1983-87	2	18-3807	35	1987-89	2	18-3810	115	1983-85	4	18-3823
8	1988-89	2	-	40	1984-89	2	18-3810	115	1986-89	4	18-3824
9.9	1983-87	2	18-3808	50	1984	2	18-3813	140	1983-85	4	18-3823
9.9	1988-89	2	-	55	1985-89	3	18-3820	140	1986-89	4	18-3824
15	1983-89	2	18-3808	65	1985-89	3	18-3820	150	1986	V-6	18-3825
25	1983-88	2	18-3809	75	1983-87	3	18-3814	200	1986	V-6	18-3825



18-7895
OIL FILTER
Replaces: 16510-93J00
Thread Spec: 3/4" x 16NPT



18-7896
OIL FILTER
Replaces: 16510-61A20-MHL
Fits: DF70A, DF80A, DF90A, DF90-DF115



18-7897
OIL FILTER
Replaces: 16510-82703
Fits: DF140



18-7903
OIL FILTER
Replaces: 16510-05240
For: DF9.9, DF15 (1996-06)



18-7905-1
OIL FILTER
Replaces: 16510-96J00
Fits: DF150-DF300



18-7915-1
OIL FILTER
Replaces: 16510-87J00
Fits: DF25-DF70



18-8870
OIL FILTER
Replaces: 16510-45H10
Fits: F9.9 Type T/TH(Sn 110001 & Newer), F15(SN 110001 & Newer)



18-0650
OIL SEAL HOUSING GASKET
 Replaces: 56132-95J00
 Fits: F 25 V-Twin (2006-07)



18-0651
PUMP CASE PANEL GASKET
 Replaces: 17472-98J00
 Fits: F300 (2007)

PKG. OF 5



18-8331
18-8331-9①
DRAIN PLUG GASKET
 Replaces: 09168-10022



18-8334
SHIFT SHAFT SEAL
 Replaces: 25223-94400

PKG. OF 10



COTTER PINS

Part #	Replaces
18-3737 ②	09204-02004 For: DT9.9 & 15C, DF9.9 & 15, 8 & 9.9C Oil Injected
18-3735 ②	09204-03003, 09204-03004 For: DT20, 25C, 30C



18-3726
PROP NUT
 Replaces: 09141-18005



18-3710
PROP NUT
 Replaces: 09141-14008



18-3774
PROP NUT KIT
 Replaces: 57630-94500
 For: DT75/85/90/100/115, 140 with V-Style, DF60/70 with V Style

— CONTAINS —		
Part #	O.E. #	Desc.
18-3726	09141-18005	Prop Nut
18-3735	09204-03003, 09204-03004	Cotter Pin
—	09160-18028	Washer
—	57633-94500	Spacer



18-3775
PROP NUT KIT
 Replaces: 57630-92E00
 For: V-6

— CONTAINS —		
Part #	O.E. #	Description
18-3726	09141-18005	Prop Nut
18-3735	09204-03003, 09204-03004	Cotter Pin
—	09160-18019	Washer
18-3795	57633-87D30	Spacer



18-3777
PROP NUT KIT
 Replaces: 57630-94300
 For: DT40/55/65

— CONTAINS —		
Part #	O.E. #	Description
18-3726	09141-18005	Prop Nut
18-3735	09204-03003, 09204-03004	Cotter Pin
—	09160-18028	Washer



18-3778
PROP NUT KIT
 Replaces: 57630-96300
 For: DT20/25C/30C

— CONTAINS —		
Part #	O.E. #	Description
18-3735	09204-03003, 09204-03004	Cotter Pin
—	09160-14028	Washer
18-3710	09141-14008	Prop Nut
—	57633-96300	Spacer



③ **18-6032**
ANODE
 Replaces: 55320-95310
 55-140 HP



③ **18-6033**
ANODE
 Replaces: 55125-87D00
 150-200 HP



③ **18-6098**
ANODE
 Replaces: 55125-96310
 DF25, DF30, DT20, DT25, DT25C, DT30, DT30C, DT35



⑤ **18-6161A**
 ④ **18-6161M**
ANODE KIT
 Fits: Suzuki 90-140HP Engines



18-79989
TRAILERING STICKS
 Fits: Most outboards over 150hp with three ram intrigrel tilt/trim.



18-8380
LOWER UNIT SEAL KIT
 Replaces: 25700-93J00
 For: All DF150/DF175/DF200/DF225/DF250



18-8381
LOWER UNIT SEAL KIT
 Replaces: 25700-99E00
 For: DF 60(2001 & Up), DF70(2001 & Up)

① Priced per Package ② This product is priced per piece. To order priced per package, please add -9 to the part number
 ⑤ Aluminum ④ Magnesium ③ Zinc



18-8335
LOWER UNIT SEAL KIT
 Replaces: 25700-87D00

— CONTAINS —

Part #	Description	O.E. #	Qty.
18-7118	O-Ring	09280-08008	1
18-7183	O-Ring	09280-69001	1
18-8331	Drain Plug Gasket	09168-10022	2
18-7440-1	O-Ring	—	1
18-0544	Oil Seal	09282-24004	2



18-8337
LOWER UNIT SEAL KIT
 Replaces: 25700-94400

— CONTAINS —

Part #	Description	O.E. #	Qty.
18-0461	Water Pump Gasket	17472-96301	1
18-7151	O-Ring	09280-75001	1
18-7413	O-Ring	09280-08005	2
18-8331	Drain Plug Gasket	09168-10022	3
18-8334	Shift Shaft Seal	25223-94400	1
18-8345	Seal	09289-22007	2
18-7180	O-Ring	—	1

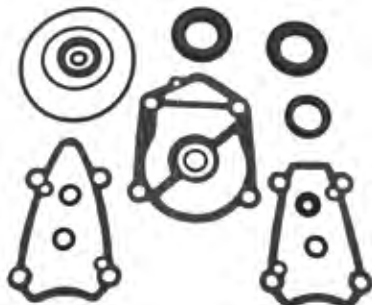

18-8338
LOWER UNIT SEAL KIT
 Replaces: 25700-94500

— CONTAINS —

Part #	Description	O.E. #	Qty.
18-7118	O-Ring	09280-08008	1
18-8331	Drain Plug Gasket	09168-10022	3
18-7182	Oil Seal	—	1
18-7133	O-Ring	—	1



18-8339
LOWER UNIT SEAL KIT
 Replaces: 25700-94700

— CONTAINS —

Part #	Description	O.E. #	Qty.
18-0460	Water Pump Gasket	17472-95310	1
18-7151	O-Ring	09280-76006	1
18-7180	O-Ring	—	1
18-7413	O-Ring	09280-08005	1
18-8329	Seal	09289-17005	1
18-8331	Drain Plug Gasket	09168-10022	3
18-8334	Shift Shaft Seal	25223-94400	1
18-8345	Seal	09289-22007	2



18-8340
LOWER UNIT SEAL KIT
 Replaces: 25700-95500

— CONTAINS —

Part #	Description	O.E. #	Qty.
18-0459	Water Pump Gasket	17472-95200	1
18-8331	Drain Plug Gasket	09168-10022	3
18-8334	Shift Shaft Seal	25223-94400	1
18-7180	O-Ring	—	1
18-7413	O-Ring	09280-08005	1
18-7127	O-Ring	—	1



18-8341
LOWER UNIT SEAL KIT
 Replaces: 25700-95D00

— CONTAINS —

Part #	Description	O.E. #	Qty.
18-0461	Water Pump Gasket	17472-96301	1
18-7118	O-Ring	09280-50005	1
18-7413	O-Ring	09280-08005	1
18-7140	O-Ring	09282-17006	1
18-8331	Drain Plug Gasket	09168-10022	3



18-8373
LOWER UNIT SEAL KIT
 Replaces: 25700-90J01
 Fits: DF 90/115 (All Years)



18-8374
LOWER UNIT SEAL KIT
 Replaces: 25700-92J00
 Fits: DF140 (All Years)



**18-8385
SEAL KIT**

Replaces: 25700-95J00
Fits: DF25 V-Twin (2006-07)

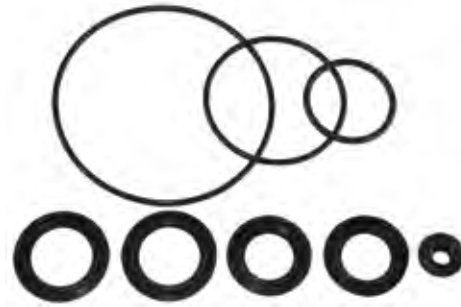

**18-8386
SEAL KIT**

Replaces: 25700-98J00
Fits: DF300 (2007)

SEAL KIT APPLICATION

HP/MODEL	YEAR	PART #	HP/MODEL	YEAR	PART #
DT25C	All	18-8341	DT115	All	18-8338
DF25	All	18-8341	DF115	All	18-8373
DF25 V-Twin	2006-07	18-8385	DT140	All	18-8338
DT30C	All	18-8341	DF140	All	18-8374
DF30	All	18-8341	DT150	All	18-8335
DT40C	All	18-8337	DF150	All	18-8380
DF40	All	18-8337	DT175	All	18-8335
DF50	All	18-8337	DF175	All	18-8380
DT55	All	18-8339	DT200	All	18-8335
DF60	2001-07	18-8381	DF200	All	18-8380
DT65	All	18-8339	DT225	All	18-8335
DF70	2001-07	18-8381	DF225	All	18-8380
DT75	All	18-8340	DF250	All	18-8380
DT85	All	18-8340	DF300	All	18-8386
DF90	All	18-8373			

PKG. OF 2



OIL SEALS

PKG. OF 5

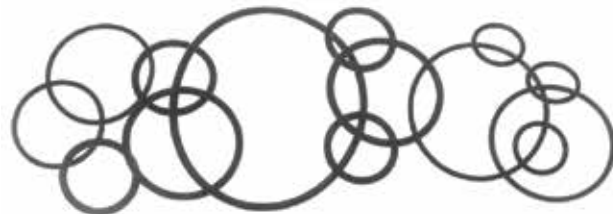

O-RINGS

Part #	O.E. #	I.D.	Dimensions O.D. (mm)	Width
18-0544	09282-24004	23.2	40.3	7
18-0545	09289-10002	9	22.2	8
18-0546	09282-30007	29.5	50.25	6
18-0551	09283-10011	9	22.2	8
18-0569	09284-08003			
18-8345	09289-22007	22.2	35	5
18-8375		29	45	6
18-8377		7	22	7
18-8378		8	22	7

Part No.	O.E. No.	I. D.	Dimensions Width (mm)
18-7118 ①	09280-08008	69.40	3.10
18-7140 ①	09280-75002	69.00	3.50

① This product is priced per piece. To order priced per package, please add -9 to the part number

Model Description	Horsepower	Trim & Tilt/Starting Method	Shaft Length	Control Method	Model Year	Special Model Variation Code (Used on 25HP engines)
B = Inshore series C = C series model CV = C series D = Twin rotating propellers DX = Twin rotating propellers OX66 EFI E = Enduro series model F = Four stroke engine model LF = Left hand four stroke L = Left hand engine model LX = Left hand OX66 EFI LZ = Left hand HPDI P = Pro series model PX = Pro series OX66 EFI S = Saltwater series model SX = Saltwater series OX66 EFI T = Four stroke engine with high thrust V = V max series model VX = V max OX66 EFI VZ = V max HPDI Z = HPDI series	Example: 6 9.9 200 250	T = Power tilt or trim/tilt (1984-1990) P = Power tilt with electric start E = Electric start (1984-1990) M = Manual tilt with manual start	S = 15" L = 20" X = 25" U = 30"	R = Remote control H = Tiller handle J = Jet drive unit	N = 1984 K = 1985 J = 1986 H = 1987 G = 1988 F = 1989 D = 1990 P = 1991 Q = 1992 R = 1993 S = 1994 T = 1995 U = 1996 V = 1997 W = 1998 X = 1999 Y = 2000 Z = 2001 A = 2002 B = 2003 C = 2004 D = 2005	2 = 3 Cyl. 1997 3 = 3 Cyl.

Starting in April 2005 (2006 Model Year and newer) Yamaha no longer designated model years at the end of the model number identification. Beginning at this time any subsequent "new model" will have a letter designation between the Horsepower and the Control / Tilt Method.









Example:

VZ300TLRD = 2005

VZ300TLR = New model after April 2005.

VZ300BTLR = Newest Model and direct replacement for previous models.

EXAMPLE: SX150TLRY - Saltwater EFI, 150 HP, Trim & Tilt w/electric start, 20", Remote control, 2000 model

 <p>18-5130 CDI Replaces: 688-85540-16-00 Fits: 90(1988-91), C75(1994-96), C85(1991-96), CV85(1989-90), E75(1995-96)</p>	 <p>18-5131 CDI Replaces: 695-85540-11, 695-85540-12-00 Fits: 9.9(1984-95), 15(1984-95), C25(1992-97), CV25(1990)</p>	 <p>18-5132 CDI Replaces: 63V-85540-00-00, 63V-85540-01-00, 63V-85540-02-00 Fits: 9.9(1999-09), 15(1999-09)</p>	 <p>18-23205 IGNITION COIL Replaces: 65W-85570-01-00 Fits: Yamaha F25(2005)</p>
 <p>18-23601 IGNITION COIL Replaces: 66M-85570-00-00 Fits: F9.9(2005-06), F15(1998-05), T9.9(2005-06)</p>	 <p>18-23602 IGNITION COIL Replaces: 63V-85570-00-00 Fits: 9.9(1996-09), 15(1996-09)</p>	 <p>18-5110 IGNITION COIL Replaces: 6E5-85570-11-00 For: 115 (4 cyl.) 1985-91</p>	 <p>18-5111 IGNITION COIL Replaces: 697-85570-11-00 For: 55 (2 cyl.) 1989-94 and 90 1984-88</p>
 <p>18-5112 IGNITION OIL Replaces: 6E7-85570-19-00, 680-85570-09-00, 6E7-85570-10-00, 695-85570-10-00 For: 9.9/15 (1988-93)</p>	 <p>18-5128 IGNITION COIL Replaces: 6R3-85570-01-00 For: 115/130/150HP (1994-04) 175HP (1994-95, 1997-98, 2000) 200HP (1994-98) 225HP (1997) B115HP 1998-99) C115HP (1997-98) for late model V4 & V6</p>	 <p>18-5183 COIL, CHARGE Replaces: 63V-85520-00, 63V-85520-01 Fits: 9.9(1996-09), 15(1996-09)</p>	 <p>18-5195 COIL, IGNITION Replaces: 689-81311-40-00 Fits: 25(1984-87), 30(1984-86), C30(1991-92), C40(1994-97), CV30(1989-90), CV40(1990)</p>



18-5138
COIL, IGNITION
 Replaces: 680-85570-00-00;
 680-85570-02-00
 Fits: T6 (02-05); F6, F8 (01-05); C25
 (96-97)



18-5119
COIL, IGNITION
 Replaces: 65E-85570-00-00



18-5113
COIL, IGNITION
 Replaces: 61N-85570-00-00,
 61N-85570-10-00
 Fits: 25(1994-95, 2001-09)



18-25650
COIL, PULSER
 Replaces: 66M-85580-00-00
 Fits: F9.9(2005-06), T9.9(2005-06),
 F15(1998-06)



18-25652
COIL, PULSER
 Replaces: 63V-85580-01-00
 Fits: 9.9(2003-09), 15(2003-09)



18-25604
LIGHTING COIL
 Replaces: 63V-85533-00-00
 Fits: 9.9(1996-09), 15(1996-09)



18-25600
COIL, CHARGE
 Replaces: 66M-85520-00-00
 Fits: F9.9(2005-06), T9.9(2005-06),
 F15(1998-06)



18-5135
CDI
 Replaces: 6E5-85540-10-00,
 6E5-85540-11-00, 6E5-85540-12-00
 Fits: 115 ET 1984-1989; 130 ET 1988-1989; C115TLR
 1991-1996; C115TXR 1992-1996; L130ETX 1989; 1989
 2-225HP



18-5136
CDI
 Replaces: 6F5-85540-21-00,
 6F5-85540-22-00
 Fits: 40HP 2 Cylinder (Int'l)



18-25300
CDI UNIT ASSEMBLY
 Replaces: 66M-85540-01-00
 Fits: F9.9(2005-06), F15(2000-06)

PREMIUM MARINE SPARK PLUG WIRE LEADS

Sierra's **MAGFORCE** Ignition Wires are "Electronics Friendly" protecting all of your electronic devices and electronic engine controls from RFI and EMI while delivering the maximum amount of voltage. Exact fit design ensures easy installation and years of trouble - free service.

Part #	OEM #	Application
18-5217-1	67F-82341-00-00	F75 (2003-2017), F80 (1999-2003), F90 (2003-2017), F100 (1999-2003)
18-5218-1	67F-82342-00-00	F75 (2003-2017), F80 (1999-2003), F90 (2003-2017), F100 (1999-2003)
18-5219-1	67F-82343-00-00	F75 (2003-2017), F80 (1999-2003), F90 (2003-2017), F100 (1999-2003)
18-5220-1	67F-82344-00-00	F75 (2003-2017), F80 (1999-2003), F90 (2003-2017), F100 (1999-2003)
18-8847-1 (Set)	67F-82341-00-00 + 67F-82342-00-00 + 67F-82343-00-00 + 67F-82344-00-00	F75 (2003-2017), F80 (1999-2003), F90 (2003-2017), F100 (1999-2003)





MP39160
MOMENTARY PUSH SWITCH
For outboard installations.



MP51020 (CLAMSHELL)
MP51022 (BULK 100 PCS/CTN)
IGNITION SWITCH
Replaces: 703-82510-12-00
Yamaha Control Box 2 & 4 stroke
Colors on wires match factory color codes



MP51030 (CLAMSHELL)
MP51032 (BULK 100 PCS/CTN)
IGNITION SWITCH
Replaces: 61B-82510-01-00,
61B-82510-00-00
Yamaha Dash Mount 2 Stroke
Dual Engine Application Colors on wires
match factory color codes



MP51040 (CLAMSHELL)
MP51042 (BULK 100 PCS/CTN)
IGNITION SWITCH
Replaces: 703-82510-43-00
Yamaha Control Box 2 & 4 stroke
Push to Choke
Colors on wires match factory color codes



MP51050 (CLAMSHELL)
MP51052 (BULK 100 PCS/CTN)
IGNITION SWITCH
Replaces: 6K1-82510-06-00
Yamaha Dash Mount 2 & 4 Stroke
Dual Engine Application, Push to Choke
Colors on wires match factory color codes



MP28860
IGNITION LANAYARD
Replaces: 682-82556-00-00



18-65450
ENGINE STOP SWITCH
Replaces: 6E9-82575-02-00
Fits: Yamaha 6(1995-00), 8(1995-09),
9.9(1994-95), C30(1994-96), C40(1994-97)



18-5225
SPARK PLUG WIRE KIT
Kit includes 25 ft. Roll of 7 MM Hypalon Ignition Wire With
a Metallic Core and a Large Assortment of Three Different
End Fittings to Fit Outboard Motors.



18-5226
IGNITION WIRE
Metallic Core
100' Spool
7mm Hypalon

PKG. OF 10



18-5750
18-5750-9①
UNIVERSAL SPARK PLUG BOOTS
Replaces: OMC 581027, 580339
Supplied complete w/Terminal Connector



18-5752
UNIVERSAL SPARK PLUG BOOTS
8mm

PKG. OF 10



18-5224
18-5224-9①
SPARK PLUG WIRE TERMINAL
Replaces: Mercury 20121
OMC 510364

① Priced per Package

YAMAHA OUTBOARD IGNITION CHART APPLICATION

HP	Year Start	Year Stop	CDI	Ignition Coil	Charge Coil (Stator)	Pulser Coil	Lighting Coil
9.9	1984	1995	18-5131	18-5111	-	-	-
9.9	1996	1998	-	18-23602	18-5183	18-25652	18-25604
9.9	1999	2009	18-5132	18-23602	18-5183	18-25652	18-25604
15	1984	1995	18-5131	18-5112	-	-	-
15	1996	1998	-	18-23602	18-5183	18-25652	18-25604
15	1999	2009	18-5132	-	18-5183	18-25652	18-25604
20	1996	1997	-	18-5113	-	-	-
25	1984	1987	-	-	18-5195	-	-

APPLICATION CONTINUED ON NEXT PAGE

YAMAHA OUTBOARD IGNITION CHART APPLICATION (Cont.)

HP	Year Start	Year Stop	CDI	Ignition Coil	Charge Coil (Stator)	Pulser Coil	Lighting Coil
25	1994	2009	-	18-5113	-	-	-
30	1984	1986	-	-	18-5195	-	-
90	1984	1988	-	18-5111	-	-	-
90	1988	1991	18-5130	-	-	-	-
115	1984	1989	18-5135	18-5110	-	-	-
115	1994	2009	-	18-5128	-	-	-
130	1988	1989	18-5135	18-5110	-	-	-
130	1994	2004	-	18-5112	-	-	-
150	1984	1989	-	18-5110	-	-	-
150	1994	2009	-	18-5112	-	-	-
175	1984	1989	-	18-5110	-	-	-
175	1994	1995	-	18-5112	-	-	-
175	2000	2000	-	18-5112	-	-	-
200	1984	1989	-	18-5110	-	-	-
200	1994	1998	-	18-5112	-	-	-
225	1994	1997	-	18-5112	-	-	-
B115	1998	1999	-	18-5112	-	-	-
C25	1992	1995	18-5131	18-5112	-	-	-
C25	1996	1997	18-5131	18-5138	-	-	-
C30	1991	1992	-	-	18-5195	-	-
C30	1993	1997	-	18-5113	-	-	-
C40	1991	1997	-	-	18-5195	-	-
C55	1991	1994	-	18-5111	-	-	-
C75	1994	1996	18-5130	-	-	-	-
C85	1991	1996	18-5130	-	-	-	-
C115	1991	1996	18-5135	18-5110	-	-	-
C115	1997	2000	-	18-5112	-	-	-
C150	1996	1999	-	18-5112	-	-	-
CV25	1990	1990	18-5131	18-5112	-	-	-
CV30	1989	1990	-	-	18-5195	-	-
CV40	1990	1990	-	-	18-5195	-	-
CV55	1989	1990	-	18-5111	-	-	-
CV85	1989	1990	18-5130	-	-	-	-
D150	1997	1999	-	18-5112	-	-	-
E48	1995	1996	-	18-5112	-	-	-
E75	1995	1996	18-5130	-	-	-	-
F6	2001	2008	-	18-5138	-	-	-
F8	2001	2015	-	18-5138	-	-	-
F9.9	2005	2006	18-25300	18-23601	18-25600	18-25650	-
F9.9	2007	2014	-	18-5138	-	-	-
F15	1998	1999	-	18-23601	18-25600	18-25650	-
F15	2000	2005	18-25300	18-23601	18-25600	18-25650	-
F25	1998	2004	-	18-23205	-	-	-
F25	2005	2005	-	18-23205	-	-	-
F30	2001	2005	-	-	-	-	-
F40	2000	2008	-	-	-	-	-
L130	1989	1989	18-5135	18-5110	-	-	-
L130	1994	2001	-	18-5112	-	-	-
L150	1986	1989	-	18-5110	-	-	-
L150	1994	1999	-	18-5112	-	-	-
L200	1986	1989	-	18-5110	-	-	-
L200	1994	1999	-	18-5112	-	-	-
P115	1994	1996	-	18-5112	-	-	-
P150	1994	1999	-	18-5112	-	-	-

APPLICATION CONTINUED ON NEXT PAGE

YAMAHA OUTBOARD IGNITION CHART APPLICATION (Cont.)

HP	Year Start	Year Stop	CDI	Ignition Coil	Charge Coil (Stator)	Pulser Coil	Lighting Coil
P175	1994	1999	-	18-5112	-	-	-
P200	1994	1999	-	18-5112	-	-	-
PROV150	1986	1989	-	18-5110	-	-	-
S115	1996	1999	-	18-5112	-	-	-
S130	1996	1999	-	18-5112	-	-	-
S150	1996	1999	-	18-5112	-	-	-
S175	1996	1999	-	18-5112	-	-	-
S200	1996	1999	-	18-5112	-	-	-
T8	2001	2010	-	18-5138	-	-	-
T9.9	2005	2006	18-25300	18-23601	18-25600	18-25650	-
T9.9	2007	2014	-	18-5138	-	-	-
T25	2001	2004	-	-	-	-	-
T25	2005	2005	-	18-23205	-	-	-
T25	2006	2006	-	-	-	-	-
V150	2000	2008	-	18-5112	-	-	-
V175	2000	2000	-	18-5112	-	-	-
V6EXCEL	1987	1989	-	18-5110	-	-	-
V6SPECIAL	1984	1986	-	18-5110	-	-	-



18-5819
SOLENOID
Replaces: 65W-81941-00-00
For: F25 (1998-04), F30 (2001-04), F40 (2000-04)



18-5853
SOLENOID
Replaces: 61A-81941-00-00, 6E5-81941-11-00, 6E5-81941-10-00, 6E5-81941-00-00
For: 2-Stroke: 115hp - 150hp. (1994-Current); 175hp (1994-2000); 200hp (1994-2005); 225hp. (1995-2004); 250hp (1990-2004)



18-5821
STARTER SOLENOID
Replaces: 6G1-81941-10-00
Fits: 9.9/15(1988-97), 20(1996-97), 25(1985, 1988-99), 30(1985-87, 1989-93, 1996-99, 2001), 40(1989-90, 1992-01), 50(1989-97, 1999-02), 1990(1992-02), F15(1998-03), F40(1999), F50(1996-02), F60(2002-03), F75(2003-04), F80(1999-03), F90(2003-04), F100(1999-02)



18-5879
SOLENOID
Replaces: 688-81950-10-00, 688-81941-00-00
For: 2-Stroke: 40hp (1984-88); 50hp (1984-88); 60hp. (2001-06); 70hp. (1991-Current); 90hp. (1984-91)



18-5746
STATOR ASSEMBLY
Replaces: 6H3-85510-A0, 6H3-85510-A1
Fits: E60(1995-99), P60(1991), 70(1984-91)



18-17301
RECTIFIER REGULATOR ASSEMBLY
Replaces: 6J8-81960-00-00
Fits: 25(1997-02), 30(1997-02)



18-6410
OUTBOARD STARTER
Replaces: Yamaha 689-81800-13-00, 689-81800-11, 689-81800-12
Fits: 25-40HP (11 tooth)



18-6411
OUTBOARD STARTER
Replaces: 6H3-81800-11-00, 6H3-81800-10
Fits: 60HP



18-6412
OUTBOARD STARTER
Replaces: 697-81800-12, 99999-03249-00
Fits: 55-60HP 2 cylinder (9 tooth)



18-6413
OUTBOARD STARTER
 Replaces: 6E5-81800-11-00,
 6E5-81800-12-00
 Fits: 55-60HP 2 cylinder (9 tooth)



18-6415
OUTBOARD STARTER
 Replaces: 6N7-81800-10-00
 Fits: 115-250HP (9 tooth)



18-6961
STARTER
 Replaces: 6CB-81800-00-00
 Fits: 200, 225, 250 4 Cycle (2006 & Up)



18-6420
OUTBOARD STARTER
 Replaces: 6L2-81800-20-00
 Fits: 20HP MLHU & MSHU (1996),
 20HP MLHV & MSHV 1997 25 (1988-98)



18-6421
OUTBOARD STARTER
 Replaces: 6F5-81800-11, 6J4-81800-01-00
 Fits: 25HP (1998&2001), 30HP (1996-99 & 2001),
 40HP (1992-03) C40 1997-02, P40 (1998)
 50 (1992-97 & 2000 & 2002-03) C50 (1998-01), P50 (1993-96)



18-6422
OUTBOARD STARTER
 Replaces: 6H4-81800-12-00
 Fits: 40HP (1984-86), 50HP (1986-88), Pro 50
 (1987-88)



18-6423
OUTBOARD STARTER
 Replaces: 688-81800-12-00
 Fits: C75 (1994-96), (1998-99), P75 (1996-99),
 C80 TLRV (1997), C85 (1991-96)
 CV85 (1990), 90 (1984-03), B90 (1998-99) C90 (1997-01)



18-6425
OUTBOARD STARTER
 Replaces: 67F-81800-02-00
 Fits: F75 (2003), F80 (2001-02), F90 (2003), F100
 (2001-02)



18-6426
OUTBOARD STARTER
 Replaces: 68F-81800-01-00
 Fits: LZ150(00-05), LZ200(00-11), VZ150(00-11),
 VZ175(01-11), VZ200(01-04), Z150(00-05), Z175(01-
 05), Z200(00-11)



18-6427
OUTBOARD STARTER
 Replaces: 68V-81800-01-00
 Fits: F115 2001-03



18-6832
STARTER
 Replaces: 60V-81800-00-00,
 60X-81800-00-00
 Fits: 250HP engines 2003-04



18-6833
STARTER
 Replaces: 69J-81800-00-00
 Fits: 2002-2004 200-225HP



18-6861
STARTER
 Replaces: Yamaha 61A-81800-01-00,
 69L-81800-00-00, 69W-81800-00
 Hitachi S114-559B
 Fits: Yamaha 200-250HP Engines



18-6942
STARTER
 Replaces: Yamaha 69W-81800-00-00
 Hitachi S114-682
 Fits: 2002-04 60HP, 2003-04 50HP



18-6943
STARTER
 Replaces: 66M-81800-01-00, 02-00
 Fits: 9.9-15HP Engines

HP	Stroke	Model	Year	Starter	HP	Stroke	Model	Year	Starter
9.9		9.9	1984-1997	18-6420	40		40TLRA - 40TLRZ	1994-2005	18-6421
9.9	4	F9.9ELR2	2006 & UP	18-6943	40		C40	1991-1997	18-6410
9.9		F9.9ELR2D	2005	18-6943	40		C40ELRP	1991	18-6410
9.9	4	F9.9MLH2	2006 & UP	18-6943	40		C40ELRQ - C40TLRZ	1992-2001	18-6410
9.9		F9.9MLH2D	2005	18-6943	40		CV40ELD	1990	18-6410
9.9	4	F9.9MSH2D	2006 & UP	18-6943	40		F40TLRX	1999	18-6413
9.9		F9.9MSH2D	2005	18-6943	40		P40	1998	18-6421
9.9	4	T9.9ELH2	2006 & UP	18-6943	40		P40TLHW - P40TLRW	1998	18-6421
9.9		T9.9ELH2D	2005	18-6943	50		50	1984-1988	18-6422
9.9	4	T9.9ELR2 - T9.9EXH2	2006 & UP	18-6943	50		50	1989-2009	18-6421
9.9		T9.9EXH2D	2005	18-6943	50		50EJRQ - 50TLHV	1992-2001	18-6421
15		15	1984-1997	18-6420	50	2	50TLR	2006 & UP	18-6421
15	4	F15ELH	2006 & UP	18-6943	50		50TLRA - 50TLRZ	1996-2005	18-6421
15		F15ELHA - F15ELHD	2002-2005	18-6943	50		C50	1998-2001	18-6421
15	4	F15ELHK	2006 & UP	18-6943	50		C50TLRW - C50TLRZ	1998-2001	18-6421
15		F15ELHY - F15ELHZ	2000-2001	18-6943	50		F50	1995-2002	18-6413
15	4	F15ESH	2006 & UP	18-6943	50		F50TJRA - F50TLRZ	1995-2002	18-6413
15		F15ESHA - F15ESHD	2002-2005	18-6943	50		P50	1991-1996	18-6421
15	4	F15ESHK	2006 & UP	18-6943	50		P50TLRR - P50TLRU	1993-1996	18-6413
15		F15ESHY - F15ESHZ	2000-2001	18-6943	50		T50	1996-2002	18-6413
15	4	F15MLH	2006 & UP	18-6943	50		T50TLRA - T50TLRY	1996-2002	18-6413
15		F15MLHA - F15MLHD	2002-2005	18-6943	55		C55	1991-1995	18-6412
15	4	F15MLHK	2006 & UP	18-6943	55		CV55	1989-1990	18-6412
15		F15MLHY - F15MLHZ	2000-2001	18-6943	60		60	2001-2005	18-6411
15	4	F15MSH	2006 & UP	18-6943	60	2	60TLR	2006 & UP	18-6411
15		F15MSHA - F15MSHD	2002-2005	18-6943	60		60TLRA - 60TLRZ	2001-2005	18-6411
15	4	F15MSHK	2006 & UP	18-6943	60		C60	1996-2001	18-6411
15		F15MSHY - F15MSHZ	2000-2001	18-6943	60		C60ELRU - C60TLRZ	1996-2001	18-6411
15	4	F15PLH	2006 & UP	18-6943	60		P60	1991-1999	18-6411
15		F15PLHA - F15PLHD	2002-2005	18-6943	60		P60TLHP - P60TLHX	1991-1999	18-6411
15	4	F15PLHK	2006 & UP	18-6943	70		70	1984-2009	18-6411
15		F15PLHZ	2001	18-6943	70		70ETLD - 70ETLN	1984-1990	18-6411
15	4	F15PLR	2006 & UP	18-6943	70	2	70TLR	2006 & UP	18-6411
15		F15PLRA - F15PLRD	2002-2005	18-6943	70		70ETLN - 70TRP	1984-2005	18-6411
15	4	F15PLRK	2006 & UP	18-6943	70		C70	2000-2001	18-6411
15		F15PLRZ	2001	18-6943	70		C70TLRY - C70TLRZ	2000-2001	18-6411
25		25 (2 CYL)	1984-1987	18-6410	75		C75	1994-1999	18-6423
25		25 (2 CYL)	1988-2009	18-6420	75		C75TLRS - C75TLRX	1994-1999	18-6423
25		C25	1991-1997	18-6410	75		F75	2003-2004	18-6425
25		CV25	1990	18-6410	75		F75	2005-2011	18-6427
25	2	25ELH	2006 & UP	18-6420	75		F75TLRB - F75TLRD	2003-2005	18-6425
25		25ELH - 25ELN	1984-1987	18-6410	75		F75TLRD	2005	18-6427
25	2	25ELR	2006 & UP	18-6420	75		P75	1996-1999	18-6423
25	2	25ESH	2006 & UP	18-6420	75		P75TLHU - P75TLHX	1996-1999	18-6423
25		25ESH - 25ESN	1984-1987	18-6410	80		C80	1997	18-6423
25	2	25ESR	2006 & UP	18-6420	80		C80TLRV	1997	18-6423
25		25LH - 25LN	1984-1987	18-6410	80		F80	1999-2003	18-6425
25	2	25MLH	2006 & UP	18-6420	80		F80TJRA - F80TLRZ	2001-2003	18-6425
25		25MLHX3	1999	18-6421	85		C85	1991-1996	18-6423
25	2	25MSH	2006 & UP	18-6420	85		C85ELD - C85TLRU	1990-1996	18-6410
25		25MSHX3 - 25MSHZ3	1999-2001	18-6421	85		CV85	1989-1990	18-6423
25		25SH - 25SN	1984-1987	18-6410	85		CV85ELF	1989	18-6410
25		C25ELD - C25SHV	1990-1997	18-6410	90		90	1984-2009	18-6423
30		30	1984-1986	18-6410	90		90ETLD - 90TJRZ	1984-2001	18-6410
30		30	1987-2001	18-6421	90	2	90TLR	2006 & UP	18-6410
30		30ELHT - 30ELHY	1995-2001	18-6421	90		90TLRA - 90TLRZ	1991-2005	18-6410
30		30ELJ - 30ELN	1984-1986	18-6410	90		B90	1997-1999	18-6423
30		30ELRT - 30ELRZ	1995-2001	18-6421	90		B90TLRV - B90TLRX	1997-1999	18-6410
30		30ESJ - 30ESN	1984-1986	18-6410	90		C90	1997-2001	18-6423
30		30ESRT - 30MSHZ	1995-2001	18-6421	90		C90TLRV - C90TLRZ	1997-2001	18-6410
30		C30	1991-1997	18-6410	90		F90	2003-2004	18-6425
30		C30ELD - C30MLHS	1990-1997	18-6410	90		F90	2006-2011	18-6427
30		CV30	1989-1990	18-6410	90	4	F90TJR	2006 & UP	18-6427
30		CV30ELF	1989	18-6410	90		F90TJRB - F90TJRC	2003-2004	18-6425
40		40	1984-1988	18-6422	90	4	F90TLR	2006 & UP	18-6427
40		40	1989-2005	18-6421	90		F90TLRB - F90TLRC	2003-2004	18-6425
40		40EJRQ	1992	18-6421	90	4	F90TXR	2006 & UP	18-6427
40		40EJRR - 40TLHV	1993-2001	18-6421	100		F100	1999-2003	18-6425
40	2	40TLR	2006 & UP	18-6421	100		F100TLRA - F100TXRZ	2001-2003	18-6425

APPLICATION CONTINUED ON NEXT PAGE

HP	Stroke	Model	Year	Starter	HP	Stroke	Model	Year	Starter
115		115	1984-1996	18-6413	175		VZ175TLRA - VZ175TLRZ	2001-2005	18-6426
115		115	2000-2009	18-6415	175		Z175	2001-2005	18-6426
115		115ETLD	1990	18-6413	175	2	Z175TXR	2006 & UP	18-6426
115		115ETLD-JD	1990	18-6413	175		Z175TXRA - Z175TXRZ	2001-2005	18-6426
115		115ETLF	1989	18-6413	200		200	1984-1996	18-6413
115		115ETLF-JD	1989	18-6413	200		200ETLD - 200TXRT	1984-1996	18-6413
115		115ETLG	1988	18-6413	200	4	F200TXR	2006 & UP	18-6833
115		115ETLG-JD	1988	18-6413	200		F200TXRA - F200TXRD	2002-2005	18-6833
115		115ETLH	1987	18-6413	200	4	F200XTR	2006 & UP	18-6833
115		115ETLH-JD	1987	18-6413	200		L200	1986-1996	18-6413
115		115ETLJ - 115TXRT	1984-1996	18-6413	200		L200ETF - L200TXRU	1986-1996	18-6413
115		C115	1991-1996	18-6413	200	4	LF200TXR	2006 & UP	18-6833
115		C115	2000	18-6415	200		LF200TXRA - LF200TXRD	2002-2005	18-6833
115		C115LXRQ - C115TXRU	1991-1996	18-6413	200		LX200	1999-2001	18-6415
115		F115	2000-2011	18-6427	200		LZ200	2002-2011	18-6426
115	4	F115TJR	2006 & UP	18-6427	200	2	LZ200TXR	2006 & UP	18-6426
115		F115TJRA - F115TJRD	2002-2005	18-6427	200		LZ200TXRA - LZ200TXRZ	2000-2005	18-6426
115	4	F115TLR	2006 & UP	18-6427	200		P200TLRS - P200TLRU	1994-1996	18-6413
115		F115TLRA - F115TLRZ	2001-2005	18-6427	200		S200	1996	18-6413
115	4	F115TXR	2006 & UP	18-6427	200		S200TXRU	1996	18-6413
115		F115TXRA - F115TXRZ	2001-2005	18-6427	200		SX200	1999-2005	18-6415
115		LF115	2000-2011	18-6427	200		V-200	1998-1999	18-6424
115	4	LF115TXR	2006 & UP	18-6427	200		V200TLRW - V200TLRX	1998-1999	18-6861
115		LF115TXRA - LF115TXRD	2002-2005	18-6427	200		VX200	2000-2003	18-6424
115		P115	1993-1996	18-6413	200		VX200TLRA - VX200TLRZ	2001-2003	18-6861
115		P115TLRR - S115TLRU	1993-1996	18-6413	200		VZ200	2001-2004	18-6426
130		130	1988-1996	18-6413	200		VZ200TLRA - VZ200TLRZ	2001-2004	18-6426
130		130	2000-2004	18-6415	200		Z200	2000-2011	18-6426
130		130ETLD - 130TXRT	1988-1995	18-6413	200	2	Z200TLR	2006 & UP	18-6426
130		L130	1989-1996	18-6413	200		Z200TLRD	2005	18-6426
130		L130	2000-2001	18-6415	200		Z200TLRY - Z200TLRZ	2000-2001	18-6426
130		L130ETXD - S130TXRU	1990-1996	18-6413	200	2	Z200TXR	2006 & UP	18-6426
150		150	1984-1996	18-6413	200		Z200TXRA - Z200TXRZ	2000-2005	18-6426
150		150	2000-2009	18-6415	225		Z25TUR	1995	18-6861
150		150ETLD - 150TXRT	1990-1997	18-6413	225		Z25TXRS	1994	18-6861
150		C150	1996	18-6413	225		Z25TXRT	1995	18-6861
150		C150TLRU	1996	18-6413	225	4	F225TUR	2006 & UP	18-6833
150		C150TXRU	1996	18-6413	225		F225TURA - F225TURD	2002-2005	18-6833
150		DX150	1999-2005	18-6415	225	4	F225TXR	2006 & UP	18-6833
150		L150	1986-1996	18-6413	225		F225TXRA - F225TXRD	2002-2005	18-6833
150		L150ETXD - L150TXRU	1986-1996	18-6413	225		L225	1994-1999	18-6424
150	4	LF150TXR	2006 & UP	18-6413	225		L225TUR - L225TXRX	1994-1999	18-6861
150		LX150	1999-2001	18-6415	225	4	LF225TUR	2006 & UP	18-6833
150		LZ150	2000-2005	18-6426	225		LF225TURA - LF225TURD	2002-2005	18-6833
150	2	LZ150TXR	2006 & UP	18-6426	225	4	LF225TXR	2006 & UP	18-6833
150		LZ150TXRA - LZ150TXRZ	2000-2005	18-6426	225		LF225TXRA - LF225TXRD	2002-2005	18-6833
150		Z150	2000-2005	18-6415	225		LX225	2000-2003	18-6424
150		P150	1991-1996	18-6413	225		LX225TXRA - LX225TXRZ	2000-2003	18-6861
150		P150TLRQ - P150TLRU	1986-1996	18-6413	225		S225	1996-1999	18-6424
150		PRO V-150	1986-1990	18-6413	225		S225TURU - S225TXRX	1996-1999	18-6861
150		S150	1996	18-6413	225		SX225	2000-2003	18-6424
150		S150TLRU / S150TXRU	1996	18-6413	225		SX225TURA - SX225TXRZ	2000-2003	18-6861
150		SX150	2000-2001	18-6415	225		V225	1998-1999	18-6424
150		V-150	2000-2008	18-6415	225		V225TLRW - V225TLRX	1998-1999	18-6861
150		VX150	2000-2004	18-6415	225		VX225	2000-2003	18-6424
150		VZ150	2000-2011	18-6426	225		VX225TLRA - VX225TLRZ	2000-2003	18-6861
150	2	VZ150TLR	2006 & UP	18-6426	250		250	1990-1995	18-6424
150		VZ150TLRA - Z150TLRZ	2000-2004	18-6426	250		250ETXD - 250TXRT	1990-1995	18-6861
150	2	Z150TXR	2006 & UP	18-6426	250		L250	1990-1999	18-6424
150		Z150TXRA - Z150TXRZ	2000-2004	18-6426	250		L250ETXD - L250TXRX	1990-1999	18-6861
175		175	1984-1995	18-6413	250		LX250	2000-2003	18-6424
175		175	2000	18-6415	250		LX250TURA - LX250TXRZ	2000-2003	18-6861
175		175ETLD - 175TXRT	1984-1995	18-6413	250		S250	1996-1999	18-6424
175		P175	1994-1996	18-6413	250		S250TURU - S250TXRX	1996-1999	18-6861
175		P175TLRS - P175TLRU	1994-1996	18-6413	250		SX250	2000-2003	18-6424
175		S175 / S175TXRU	1996	18-6413	250		SX250TURA - SX250TXRZ	2000-2003	18-6861
175		V-175	2000	18-6415			V-6 SPECIAL	1984-1986	18-6413
175		VZ175	2001-2011	18-6426			V-6 SPECIAL L	1984	18-6413
175	2	VZ175TLR	2006 & UP	18-6426			V-6SPECIAL X	1984	18-6413



18-50000
STARTER HANDLE
 Replaces: 689-15755-01-00 + 6G1-15779-00-00
 Fits: Yamaha 15 hp & Up (1988 & Up)



18-50001
STARTER HANDLE
 Replaces: 6G1-15755-00-00, 6G1-15779-00-00
 Fits: 2.5-9.9 hp(1988 & Up)



18-56002
BRUSH HOLDER ASSEMBLY
 Replaces: 689-81840-11-00
 Fits: F6/F8/T8 (2001-05), F9.9 (1985-90,1999-05), T9.9 (1991-97,1999,2001-05), 25 (1984-87)(1999-00), C25 (1991,1993-97), CV25 (1990), 30 (1984-01), C30 (1991-97), CV30 (1990), 40 (1984-05), P40 (1998), C40 (1991-01), CV40 (1990), 50 (1986-05), C50 (1998-01), P50 (1991-96), PRO50 (1987-90), 60 (2001-05), C60 (1996-01), P60 (1991-99), 70 (1984-05), C70 (2000-01)
 Use with **18-6410** Starter



18-56004
BRUSH HOLDER ASSEMBLY
 Replaces: 663-81840-11-00
 Fits starters: 689-81800-13-00(18-6410), 6H3-81800-11-00 (18-6410), 6F5-81800-11-00,6J4-81800-01-00 (18-6421) 6H4-81800-12-00 (18-6422), 697-81800-12, 99999-03249-00-00 (18-6412)



18-56005
BRUSH HOLDER ASSEMBLY
 Replaces: 6E5-81840-10-00
 Fits starters: 689-81800-13-00(18-6410), 6H3-81800-11-00 (**18-6410**), 6F5-81800-11-00, 6J481800-01-00(**18-6421**), 6H4-81800-12-00 (**18-6422**), 6E5-81800-11-00, 6E5-81800-12-00 (**18-6413**)



18-56006
BRUSH HOLDER ASSEMBLY
 Replaces: 6N7-81840-00-00
 Fits: 115,130,150 HP (1997-04), 175,200 HP (1997-98), 225 HP (1997)
 Use with **18-6415** Starter



18-56007
BRUSH HOLDER ASSEMBLY
 Replaces: 61A-81840-00-00
 Fits starters: 61A-81800-00-00, 61A-81800-01-00, 69L-81800-00-00 Fits:225 (1991-96), 250 (1990-95), L225 (1994-99), L250 (1990-99), LX225,LX250(2000-03), P150,P175 (1994-96, P200 1991-96, S225/S250 1996-99), SX225,SX250 (2000-03), V200/V225 (1998-99), VX200 (2000-05), VX225 (2000-04), VX250 (2002-04)



18-6798
TRIM MOTOR
 Replaces: 69J-43880-00-00, 60V-43880-00-00
(O-Ring included)
 Fits: F200, F225 (2004-06), F250 (2005-06), LF200, LF225, LF250, LZ200, LZ225, LZ250 (2004-06)



18-6748
TRIM MOTOR
 Replaces: 67C-43880-00-00, 67C-43880-01-00
 Fits: F30, F40 (2001 & Up)



18-6259
TILT/TRIM MOTOR
 Replaces: 6H1-43880-00-00
(O-Ring Included)
 Fits: 70/90HP (1987-91), C85/P60HP (1991)



18-6787
TILT/TRIM MOTOR
 Replaces: 67F-43880-00-00
(O-Ring Included)
 Fits: Yamaha 4-Stroke F75 (2003-04), F80 (1999-03), F90 (2003-04), F100 (1999-02)



18-6788
TILT/TRIM MOTOR
 Replaces: 6H5-43880-02-00
(O-Ring Included)
 Fits: Yamaha 40-50hp (1985-92)



18-6789
TILT/TRIM MOTOR
 Replaces: 62X-43880-09-00
(O-Ring Included)
 Fits: Yamaha 40-100hp (1995-03)



18-6760
TRIM MOTOR
 Replaces: 6G5-43880-02-00
(O-Ring Included)
 For: 115-200HP (1987-96)



18-6781
TILT/TRIM MOTOR
 Replaces: 6H1-43880-02-00
2-wire connection, 3 bolt mount
 For: 40HP (1994) 50HP (1992-95) 60HP (1997-up) 70HP (1996-up) 90HP (1992-up)



18-6782
TILT/TRIM MOTOR
 Replaces: 61A-43880-01-00,
 61A-43880-02-00
3-bolt mount, 4 wire connection
(O-Ring Included)
 For: 225-250HP



18-6783
TILT/TRIM MOTOR
 Replaces: 64E-43880-00-00, 64E-43880-01-00
2-wire ring terminal connection 4-bolt mount
(O-Ring Included)
 For: 115-225HP (1997-2002)



18-6811
POWER TRIM MOTOR
 Replaces: 62Y-43800-11-00, 62Y-43880-00-00,
 69W-43880-00-00
(O-Ring included)
 Fits: 40(2003 & Up), 50(2003 & Up), C40(2003),
 F50(2003-04), T50(2003-04), 2002-04 60hp 4-stroke



18-6812
TRIM MOTOR
 Replaces: 62X-43880-00-00,
 62X-43880-01-00, 62X-43880-09-00
 Fits: 1995-03 Yamaha 40-100HP



18-6821
TRIM MOTOR
 Replaces: 688-43880-11-00,
 6E5-43880-01-00, -02-00
 Fits: Yamaha 50-200HP 1985-86



18-6836
TRIM MOTOR
 Replaces: 6C5-43880-00-00,
 6C5-43880-01-00
 Fits: 2005-06 F50 and F60



new

18-1522
RELAY, TRIM ASSEMBLY
 Replaces: 63P-81950-00
 Fits: 25-150, 200-225 HP (06-Up), 50-90, 250 HP (05-Up),
 150 HP (04-Up)



new

18-1523
RELAY, TRIM ASSEMBLY
 Replaces: 61A-81950-01
 Fits: F25 HP (98-Up), T25 HP (01-Up), 60 HP (93-Up), 70
 HP (93-Up), 75 HP (94-99), 80 HP (97), 85 HP (93-96), 90
 HP (93-09), 150 HP (99-05), 200 HP (98-05), 225 HP
 (90-04), 250 HP (90-04)



18-6823
WIRING HARNESS
 Converts 3-wire Tilt and Trim motors to
 2-Wire design

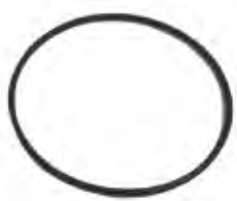

18-7484
BACK-UP RING
 Replaces: 65W-43871-00-00
 For: F25-F40 1999-2008 w/Power Trim



18-2083
FUEL INJECTOR SEAL
 Replaces: 68V-13766-00-00



TRIM SEALS
18-2081
 Replaces: 64E-43822-00-00
18-2082
 Replaces: 64E-4384J-00-00



18-9802
TIMING LIGHT
 Self-powered accurate up to 10,000 RPM's



18-7058
CARBURETOR KIT
 Replaces: 63V-W0093-00-00
 Fits: 9.9(1996-09), 15(1996-09)



18-7059
CARBURETOR KIT
 Replaces: 677-W0093-00-00,
 677-W0093-04-00
 Fits: 9.9(1984-85), 15(1984-85)



18-7002
CARBURETOR KIT
Replaces: 6E5-W0093-06-00
Fits: 115 (1986-88, 1992-93, 1995), 130 (1988, 1992-93, 1995), 150, 175 (1986-87, 1992-95), 200 (1986-87, 1992-95), 225 (1992-93)



18-7290*
CARB KIT
Replaces: 696-W0093-02-00
 *Kit contains enough components to rebuild 2 carburetors



18-7291
CARB KIT
Replaces: 6H1-W0093-01-00
 (3) of 18-7291 = (1) of 6H1-W0093-01-00



18-7293
CARB KIT
Replaces: 6A1-W0093-01-00



18-7736
CARB KIT
Replaces: 67D-W0093-00-00
For: (1999-02) F4



18-7737
CARB KIT
Replaces: 61N-W0093-00-00
For: (1993-97) C30



18-7738
CARB KIT
Replaces: 66M-W0093-01-00, 66M-W0093-00-00
For: (1998-02) F15



18-7739
CARB KIT
Replaces: 6L2-W0093-00-00
For: (1996-97) 20 (1988-02) 25 3 cyl



18-7740
CARB KIT
Replaces: 6E9-W0093-02-00
For: (1990-94) C40 2 cyl



18-7741
CARB KIT
Replaces: 6E9-W0093-03-00
For: (1995-98) C40 2 cyl



18-7742
CARB KIT
Replaces: 6H0-W0093-00-00
For: (1997) C80



18-7743
CARB KIT
Replaces: 67F-W0093-00-00
For: (1999-02) F80/F100



18-7744
CARB KIT
Replaces: 6N6-W0093-02-00
For: (1990-91) 115, 130, L130



18-7747
CARB KIT
Replaces: 6G5-W0093-08-00
For: (1985-86) 150/175/200, V6 Special



18-7756
CARB KIT
Replaces: 64D-W0093-00-00
For: (1996-01) 150/150L/175 (1996-99) 200/L200 (2000-01) 150/175 (1997-98) D150



18-7759
CARB KIT
Replaces: 6K7-W0093-09-00
For: (1990-91) 150/175/200 (1991-92) P200



18-7765
CARB KIT
Replaces: 6G1-W0093-00-00



18-7766
CARB KIT
 Replaces: 6H3-W0093-02-00
 (3) of 18-7766 = (1) of 6H3-W0093-02-00



18-7767
CARB KIT
 Replaces: 6H4-W0093-01-00
 (3) of 18-7767 = (1) of 6H4-W0093-01-00



18-7768
CARB KIT
 Replaces: 6H4-W0093-03-00
 (3) 18-7768 = (1) 6H4-W0093-03-00



18-7769
CARB KIT
 Replaces: 6E7-W0093-04-00



18-7770
CARB KIT
 Replaces: 689-W0093-02-00



18-7772
CARB KIT
 Replaces: 61A-W0093-01-00, 61A-W0093-00-00
 For: (1991-96) 225/250 3.1 liter, L225, L250



18-34600
CARBURETOR
 Replaces: 66M-14301-00-00,
 66M-14301-12-00
 Fits: F15(2006 & Up)



18-34601
CARBURETOR
 Replaces: 67D-14301-13-00
 Fits: F4(2005 & Up)



18-34603
CARBURETOR
 Replaces: 63V-14301-00-00
 Fits: 9.9(1996-03), 15(1996-03)



18-34604
CARBURETOR
 Replaces: 69M-14301-11-00
 Fits: F2.5MSH(2006 & Up)



18-34605
CARBURETOR
 Replaces: 66T-14301-00-00
 Fits: T40/T30 Enduro Series



18-7049
NEEDLE VALVE
 Replaces: 62Y-14392-00-00, 61N-14392-00-00,
 6L2-14392-00-00
 Fits: C30(1993-97)



18-7054
NEEDLE VALVE
 Replaces: 6G1-14546-00-00, 6G1-14546-01-00
 Fits: 3(1988-02), 6(1986-00), 8(1984-03), 9.9(1996-03),
 15(1996-03), F25(1998-03), F30(2000-02), F40(2000-02),
 T25(2001-03)



18-7055
NEEDLE VALVE
 Replaces: 6E5-14546-00-00,
 6J8-14546-00-00
 Fits: 25 MLHV3(1997), 25MLHW3(1998),
 25 MSHV3(1997), 25 MSHW3(1998),
 30(1987-98), 115(1986-09), 130(1988-04),
 150(1986-09), 175(1986-95, 2000), 200(1986-98),
 225(1990-97), B115(1998-99), 250(1991-95),
 C115(1991-00), C150(1996-99), D150(1997-99),
 L130(1989-01), L150(1986-99), L200(1986-99),
 L225(1994-96), L250(1990-96), P115(1993-96),
 P150(1991-99), P175(1994-99), P200(1991-99),
 S115(1996-99), S130(1996-99), S150(1996-99),
 S175(1996-99), S200(1996-99), S225(1996),
 S250(1996), V150(2000-08), V175(2000)



18-7056
NEEDLE VALVE
 Replaces: 6H3-14590-00-00,
 6H3-14590-01-00, 67F1439A-00-00,
 6H2-14591-00-00
 Fits: 40(1984-92), 50(1984-92), 70(1984-01),
 C40(1991-94), C60(1996-01), C70(2000-01),
 CV40(1990), E60(1995-00), F80(2000-02),
 F100(2000-02), P50(1991-92), P60(1991-99)

 <p>18-7060 NEEDLE VALVE Replaces: 692-14590-00-00, 692-14590-01-00 Fits: 90(1984-02), B90(1997-99), C75(1994-99), C80(1997), C85(1991-96), C90(1997-01), CV85(1989-90), E75(1995-00), P75(1996-99)</p>	 <p>18-7073 NEEDLE VALVE Replaces: 6E8-14380-12-00, 6E7-14390-12-00 Fits: 9.9(1986-95), 15(1986-95)</p>	 <p>18-7079 NEEDLE VALVE Replaces: 626-14390-90 Fits: 9.9(1984-85), 15(1984-85)</p>	 <p>18-7063 FLOAT Replaces: 6L2-14385-00-00 Fits: 20(1996-97), 25(1988-09), C30(1993-97), F15(1989-06), F40(1999), F50(1995-03), F60(2002-04), F9.9(2005-06), T50(1996-04), T60(2003-04), T9.9(2005-06)</p>
 <p>18-7064 FLOAT Replaces: 63V-14985-00 Fits: 9.9(1996-09), 15(1996-09), F25(1998-13), F30(2001-05), F40(2000-08), T25(2001-13)</p>	 <p>18-7065 FLOAT Replaces: 647-14385-00-00 Fits: 4(1984-85), 5(1984-85), 9.9(1984-85), 15(1984-85)</p>	 <p>18-7066 FLOAT Replaces: 648-14385-00-00 Fits: 25(1984-87), 30(1984-86), C25(1991-97), C30(1991-92), Cv25(1990), CV30(1989-90)</p>	 <p>18-7067 FLOAT Replaces: 6G1-14985-00-00 Fits: 3(1988-02), 6(1986-00), 8(1984-00), 40(1984-88), 50(1984-88), 70(1984-91), C60(1996-01), E60(1995-00), PRO 50(1987-88), P60(1991)</p>
 <p>18-7068 FLOAT Replaces: 6E5-14385-01-00, 6E5-14385-00-00 Fits: 115(1984), 150(1984), 175(1984), 200(1984)</p>	 <p>18-7069 FLOAT Replaces: 6E5-14385-02-00 Fits: 115(1986-09), 130(1988-04), 150(1986-09), 175(1986-00), 200(1986-98), 200(1990-97), B115(1998-99), C115(1991-00), C150(1996-99), D150(1997-99), L130(1989-01), L150(1986-99), L200(1986-99), P115(1993-96), P150(1991-99), P175(1994-99), P200(1991-99), PRO150(1986-90), S115(1996-99), S130(1996-99), S150(1996-99), S175(1996-99), S200(1996-99), V150(2000-08), V6 Excel(1987-89), V6 Special(1986)</p>	 <p>18-7392 FLOAT Replaces: 676-14985-01-00 Fits: 90(1984-90), C40(1991-97), C75(1994-99), C80(1997), C85(1991-96), CV40(1990), CV85(1989-90), E75(1995-00)</p>	
 <p>18-7393 FLOAT Replaces: 6E7-14385-00-00 Fits: 4(1986-94), 5(1994), 9.9(1986-95), 15(1986-95)</p>	 <p>18-0710 FLOAT CHAMBER GASKET Replaces: 68V-14984-00 Fits: F115 (2000-10), LF115 (2000-10), F200 (2002-10), LF200 (2002-10), F225(2002-05), LF225(2002-05), F225TXR models(2007-10), LF225TXR models(2007-10)</p>	 <p>18-0711 FLOAT CHAMBER GASKET Replaces: 66K-14984-00 Fits: DX 150(1999-05), LX 150(1999-01), LZ 150(2000-05), PX 150(1999), VX 150(2000-04), VZ 150(2000-10), Z 150(2000-05), VZ 175(2001-10), Z175(2001-05), LX200(1999-01), LZ200(2000-10), SX200(1999-05), V200(1999), VX200(2000-05), VZ200(2001-09), Z200 (2000-10), L225(1999), LX225(2000-03), S225(1999), SX225(2000-03), V225(1999), VX225(2000-04), VZ225(2003-09), L250(1999), LX250(2000-03), LZ250(2003-05), S250(1999), SX250(2000-03), VX250(2002-04), VZ250(2003-09), Z250(2003-05), LZ300(2004-06), VZ300(2004-09), Z300(2004-06)</p>	
 <p>18-0712 FLOAT CHAMBER GASKET Replaces: 63P-14984-00 Fits: F150 TLR (2004-10), F150 TXR (2004-10), LF150 TXR (2004-10)</p>	 <p>18-0713 FLOAT CHAMBER GASKET Replaces: 6P2-14984-00 Fits: F225TLR(2007-09), F250(2005-10), LF250(2005-10)</p>	 <p>18-0714 FLOAT CHAMBER GASKET Replaces: 6AW-14984-00 Fits: F300(2007-09), LF300(2007-09), F350(2007-10), LF350(2007-10)</p>	



18-0715
FLOAT CHAMBER GASKET

Replaces: 65L-14984-00
Fits: V200(1998), L225(1997-98), S225(1997-98), V225(1998), L250(1997-98), S250(1997-98)



18-0716
FLOAT CHAMBER GASKET, VITON

Replaces: 6CB-14984-00
Fits: F115(2001-14), F200(2011-14), F225(2010-14), F250(2010-14), F300(2010-14), F350(2011-14), FL250(2010), FL300(2010), LF115(2011-14), LF200(2011-14), LF225(2010-14), LF250(2010-14), LF300(2010-14), LF350(2011-14), VF150(2013-14), VF200(2010-14), VF225(2010-14), VF250(2009-14)



18-0717
FLOAT CHAMBER GASKET, VITON

Replaces: 6C5-14984-00
Fits: F50(2005-14), F60(2005-14), F70(2010-14), F75(2005-14), F90(2005-14), T50(2005-14), T60(2005-14)



18-99146
FLOAT CHAMBER GASKET

Replaces: 677-14384-01
Fits: 9.9(1984-95), 15(1984-95)



18-0707
SEAL, VITON

Replaces: 6CB-13016-00
Fits: F115(2011-14), F175(2014), F200(2011-14), F225(2010-14), F250(2010-14), F300(2010-14), F350(2012-14), FL250(2010), FL300(2010), LF115(2011-14), LF200(2011-14), LF225(2010-14), LF250(2010-14), LF300(2010-14), LF350(2012-14), VF150(2013-14), VF200(2010-14), VF225(2009-14), VF250(2009-14)

H.P.	Year	Carb Kit	Per Engine	Needle Valve Assy	Per Engine	H.P.	Year	Carb Kit	Per Engine	Needle Valve Assy	Per Engine
2	1984-88	18-7293	1			60	2001-02			18-7056	3
3	1988-02	18-7765	1	18-7054	1	C60	1996-01	18-7766	3	18-7056	3
F4	1989-02	18-7736	1			E60	1995-00	18-7766	3	18-7056	3
6	1986-96	18-7765	1	18-7054	1	P60	1991	18-7766	3	18-7056	3
6	1997-00		1	18-7054	1	P60	1992-99			18-7056	3
8	1984-96	18-7765	1	18-7054	1	70	1984-91	18-7766	3	18-7056	3
8	1997-00		1	18-7054	1	70	1992-01			18-7056	3
9.9	1984-85	18-7059	1	18-7079	1	C70	2000-01			18-7056	3
9.9	1986-95	18-7769	1	18-7073	1	C75	1994-97	18-7291	3	18-7060	3
9.9	1996-03	18-7058	1	18-7054	1	C75	1998-99	18-7742	3	18-7060	3
9.9	2004-09	18-7058	1			E75	1995-00	18-7291	3	18-7060	3
F9.9	2006	18-7738	1			P75	1996-99			18-7060	3
T9.9	2005-06	18-7738	1			C80	1997	18-7742	3	18-7060	3
15	1984-85	18-7059	1	18-7079	1	F80	1999-02	18-7743	3	18-7056	3
15	1986-92	18-7769	1	18-7073	1	C85	1991-96	18-7291	3	18-7060	3
15	1993-95		1	18-7073	1	CV85	1989-90	18-7291	3	18-7060	3
15	1996-03	18-7058	1	18-7054	1	90	1984-91	18-7291	3	18-7060	3
15	2004-09	18-7058	1			90	1992-02			18-7060	3
F15	1998-05	18-7738	1			B90	1997-99			18-7060	3
20	1996-97	18-7739	1			C90	1997-01			18-7060	3
25 (2 cyl)	1984-87	18-7770	1			F100	1999-02	18-7743	3	18-7056	3
25 (2 cyl)	1988-09	18-7739	1			115	1986-88, 1992-95	18-7002	2	18-7055	4
F25	1998-03		1	18-7054	1	115	1990-91	18-7744	2	18-7055	4
C25	1991-1997	18-7770	1			115	1992-09		2	18-7055	4
CV25	1990	18-7770	1			B115	1998-99			18-7055	4
T25	2001-03		1	18-7054	1	C115	1991			18-7055	4
30	1984-86	18-7770	1			C115	1992-95	18-7002	2	18-7055	4
30	1987-98		1	18-7055	1	C115	1996-00			18-7055	4
F30	2000-02		1	18-7054	1	P115	1993-96	18-7002	2	18-7055	4
C30	1991-92	18-7770	1			S115	1996-99			18-7055	4
C30	1993-97	18-7737	1	18-7049	1	130	1988, 1992-95	18-7002	2	18-7055	4
CV30	1989-90	18-7770	1			130	1990-91	18-7744	1	18-7055	4
40	1984-88	18-7767	3	18-7056	3	130	1992-04			18-7055	4
40	1989-92	18-7768	3	18-7056	3	L130	1989			18-7055	4
40	1993-05	18-7768	3			L130	1990-91	18-7744	1	18-7055	4
F40	2000-02			18-7054	3	L130	1992-95	18-7002	2	18-7055	4
C40	1991-93	18-7740	1	18-7056	2	L130	1996-01			18-7055	4
C40	1994-97	18-7741	1			S130	1996-99			18-7055	4
C40	2002-03	18-7768	3			150	1985-86	18-7747	1	18-7055	6
P40	1998	18-7768	1			150	1987, 1992-95	18-7002	3	18-7055	6
E48	1995-00	18-7290	2		*	150	1990-91	18-7759	1	18-7055	6
50	1984-88	18-7767	3	18-7056	3	150	1996-01	18-7756	3	18-7055	6
50	1989-92	18-7768	3	18-7056	3	150	2002-09			18-7055	6
50	1993 & Up	18-7768	3			C150	1996-99	18-7756	3	18-7055	6
C50	1998-01	18-7768	3			D150	1997-99	18-7756	3	18-7055	6
PRO 50	1987-88	18-7767	3			L150	1988, 1992-95	18-7002	3	18-7055	6
PRO 50	1989-90	18-7768	3			L150	1990-91	18-7759	1	18-7055	6
P50	1991-92	18-7768	3	18-7056	3	L150	1996-99	18-7756	3	18-7055	6
P50	1993-96	18-7768	3			Z150					
C55	1991-95	18-7290	2		*	P150	1991	18-7759	1	18-7055	6
CV55	1989-90	18-7290	2		*	P150	1992-95	18-7002	3	18-7055	6

① Kit contains enough components to rebuild 2 carburetors

H.P.	Year	Carb Kit	Per Engine	Needle Valve Assy	Per Engine	H.P.	Year	Carb Kit	Per Engine	Needle Valve Assy	Per Engine
P150	1996-99	18-7756	3	18-7055	6	200	1996-98	18-7756	3	18-7055	6
PRO V150	1987	18-7002	3			L200	1988, 1992-95	18-7002	3	18-7055	6
PRO V150	1990	18-7759	1			L200	1990-91	18-7759	1	18-7055	6
S150	1996-99	18-7756	3	18-7055	6	L200	1996-99	18-7756	3	18-7055	6
V150	2000-01	18-7756	3			P200	1991	18-7759	1	18-7055	6
V150	2002-08			18-7055	6	P200	1993-95	18-7002	3	18-7055	6
175	1985-86	18-7747	2			P200	1996-99	18-7756	3	18-7055	6
175	1987, 1992-95	18-7002	3	18-7055	6	S200	1996-99	18-7756	3	18-7055	6
175	1990-91	18-7759	1	18-7055	6	V6 Special	1984-86	18-7747	2		
175	1992-95			18-7055	6	V6 Excel	1987-89	18-7759	1		
175	2000	18-7756	3	18-7055	6	225	1990-91	18-7759	1	18-7055	6
P175	1994-95	18-7002	3	18-7055	6	225	1992-95	18-7002	3	18-7055	6
P175	1996-99	18-7756	3	18-7055	6	225	1996-97	18-7756	3	18-7055	6
S175	1996-99	18-7756	3	18-7055	6	L225	1994-96	18-7772	6	18-7055	6
V175	2000	18-7756	3			S225	1996	18-7772	6	18-7055	6
200	1985	18-7747	2			250	1990-95	18-7772	6	18-7055	6
200	1986-87, 1992-95	18-7002	3	18-7055	6	L250	1991-96	18-7772	6	18-7055	6
200	1990-91	18-7759	1	18-7055	6	S250	1996	18-7772	6	18-7055	6

* Carb Kit contains enough componenets to rebuild 2 carburetors

 <p>18-35302 FUEL PUMP ASSEMBLY Replaces: 66M-24410-10-00 Fits: F9.9(2005-06), T9.9(2005-06), F15(1998-06)</p>	 <p>18-35304 FUEL PUMP ASSEMBLY Replaces: 67D-24410-03-00 Fits: F4(2006-08)</p>		
 <p>18-7334 FUEL PUMP Replaces: 692-24410-00-00, 663-24410-00-00, 6A0-24410-00-00, 6A0-24410-05-00, 6A0-24410-04-00, 6A0-24410-03-00, 6A0-24410-02-00, 6A0-24410-01-00 For: 2-Stroke 40 HP - 90 HP (1984-2009) Uses Kit 18-7797</p>	 <p>18-7340 FUEL PUMP Replaces: 68V-13907-03-00, 68V-13907-02-00, 68V-13907-01-00, 68V-13907-00-00 Fits: F115(2000-04, 2006-11), LF115(2000-11)</p>	 <p>18-7341 FUEL PUMP Replaces: 66K-13907-00-00 Fits: DX150(1999-01), LX150(1999-01), LX200(1999-01), LX225(2000-01), LX250(2000-01), PX150(1999), SX150(1999-01), SX200(1999-01), SX225(2000-01), SX250(2000-01), VZ200(1999), VZ225(1999), VX150(2000-01), VX200(2000-01), VX225(2000-01)</p>	 <p>18-7342 FUEL PUMP Replaces: 68F-13907-00, 68F-13907-01-00, 68F-13907-00-00 Fits: LZ150(2000-05), LZ200(2000-12), VZ150(2000-12), VZ175(2001-12), VZ200(2001-04), Z150(2000-05), Z175(2001-05), Z200(2000-12)</p>
 <p>18-7343 FUEL PUMP Replaces: 60V-13907-00-00 Fits: LZ250(2003-05), LZ300(2004-06), VZ200(2005-09), VZ225(2003-09), VZ250(2003-09), VZ300(2004-09), Z250(2003-05), Z300(2004-06)</p>	 <p>18-7349 FUEL PUMP Replaces: 6E5-24410-03-00, 6E5-24410-10-00, 6E5-24410-04-00, 6E5-24410-02-00, 6E5-24410-01-00, 6E5-24410-00-00 For: 2-Stroke 115 HP - 300 HP (1984-2004) Uses Kit 18-7788</p>	 <p>18-7388 DIAPHRAGM Replaces: 6G1-24411-00-00 Fits: 3(1988-02), 6(1986-00), 8(1984-09), 9.9(1996-09), 15(1996-09)</p>	 <p>18-7389 DIAPHRAGM Replaces: 6E0-24411-00-00 Fits: 4(1984-99), 5(1984-85, 1994-02)</p>
 <p>18-7390 DIAPHRAGM Replaces: 63V-24411-00-00 Fits: 9.9(1996-09), 15(1996-09)</p>	 <p>18-7391 DIAPHRAGM Replaces: 692-24411-00-00 Fits: 40(1995-05), 50(1995-09), 60(2001-05), 70(1995-09), 90(1995-09), B90(1997-99), C25(1996-97), C30(1996-97), C40(1995-03), C50(1998-01), C55(1995), C60(1996-01), C70(2000-01), C75(1995-99), C80(1997), C85(1995-96), C90(1997-01), E48(1995-00), E60(1995-00), E75(1995-00), P40(1998), P50(1995-96), P60(1995-99), P75(1996-99)</p>	 <p>18-7787 FUEL PUMP KIT For: 40-90 HP — CONTAINS — Part # Description O.E. # 18-7840 Diaphragm (Front) 663-24411-00-00 18-7839 Diaphragm 648-24411-00-00</p>	 <p>18-7788 FUEL PUMP KIT Replaces: 6E5-24411-00-00 (V-4, V-6) — CONTAINS — Part # Description O.E. # 18-7843 Gasket (Rear) 6E5-24411-00-00 18-7842 Diaphragm (Top) 6E5-24471-00-00</p>



18-7367
FUEL PUMP KIT
Contains: 18-7833 & 18-7388



18-7368
FUEL PUMP KIT
Contains: 18-7834 & 18-7389



18-7369
FUEL PUMP KIT
Contains: 18-7388 & 18-7390



18-7797
FUEL PUMP KIT
Contains: 18-7839 & 18-7840



18-7798
FUEL PUMP KIT
Contains: 18-7838 & 18-7837



18-7799
FUEL PUMP DIAPHRAGM
Replaces: 6G1-24471-00-00



18-7833
FUEL PUMP DIAPHRAGM
Replaces: 6E0-24471-00-00



18-7834
FUEL PUMP DIAPHRAGM
Replaces: 6E0-24471-00-00



18-7837
FUEL PUMP DIAPHRAGM
Replaces: 677-24411-02-00



18-7838
FUEL PUMP DIAPHRAGM
Replaces: 677-24471-01-00



18-7839
FUEL PUMP DIAPHRAGM
Replaces: 648-24411-00-00



18-7840
FUEL PUMP DIAPHRAGM
Replaces: 663-24411-00-00



18-7841
FUEL PUMP DIAPHRAGM
Replaces: 6J8-24471-00-00



18-7842
FUEL PUMP DIAPHRAGM
Replaces: 6E5-24471-00-00



18-7843
FUEL PUMP DIAPHRAGM
Replaces: 6E5-24411-00-00

Model	Year	Diaphragms	Kits	Model	Year	Diaphragms	Kits	Model	Year	Diaphragms	Kits
3	1988-02	18-7833 / 18-7388	18-7367	E75	1995-00	18-7840		Z175	2001-01	18-7842	
4	1984-99	18-7834 / 18-7389	18-7368	P75	1996-99	18-7840		Z175	2002-04	18-7842 / 18-7843	18-7799
5	1984-85	18-7834 / 18-7389	18-7368	C80	1997	18-7840		200	1984-98	18-7842 / 18-7843	18-7799
5	1986-91	18-7834		85	1990	18-7798		L200	1986-99	18-7842 / 18-7843	18-7799
5	1994-02	18-7834 / 18-7389	18-7368	C85	1991-94	18-7839 / 18-7840	18-7797	LX200	1999-01	18-7842	
6	1986-00	18-7833 / 18-7388	18-7367	C85	1995-96	18-7840		LZ200	2000-01	18-7842	
8	1984-09	18-7833 / 18-7388	18-7367	CV85	1989-90	18-7839 / 18-7840	18-7797	LZ200	2002-04	18-7842 / 18-7843	18-7799
9.9	1984-95	18-7837 / 18-7838	18-7798	90	1984-94	18-7839 / 18-7840	18-7797	P200	1991-99	18-7842 / 18-7843	18-7799
9.9	1996-09	18-7388 / 18-7390	18-7369	90	1995-09	18-7840		S200	1996-99	18-7842 / 18-7843	18-7799
15	1984-95	18-7837 / 18-7838	18-7798	B90	1997-99	18-7840		SX200	1999-01	18-7842	
15	1996-09	18-7388 / 18-7390	18-7369	C90	1997-01	18-7840		SX200	2002-04	18-7842 / 18-7843	18-7799
20	1996-97	18-7837		I15	1984-04	18-7842 / 18-7843	18-7799	V200	1999	18-7842	
25	1984-87	18-7840		B115	1998-99	18-7842 / 18-7843	18-7799	V200	1998	18-7842 / 18-7843	18-7799
25	1984-87			C115	1991-00	18-7842 / 18-7843	18-7799	VX200	2000-01	18-7842	
25	1988-09	18-7837		P115	1993-96	18-7842 / 18-7843	18-7799	VX200	2002-04	18-7842 / 18-7843	18-7799
C25	1991-95	18-7840	18-7797	S115	1996-99	18-7842 / 18-7843	18-7799	VZ200	2001	18-7842	
C25	1996-97	18-7840		I30	1988-04	18-7842 / 18-7843	18-7799	VZ200	2002-04	18-7842 / 18-7843	18-7799
CV25	1990	18-7839 / 18-7840	18-7797	C150	1996-99	18-7842 / 18-7843	18-7799	Z200	2000-01	18-7842	
25	1990	18-7837		L130	1989-99	18-7842 / 18-7843	18-7799	Z200	2002-04	18-7842 / 18-7843	18-7799
30	1984-86	18-7839 / 18-7840	18-7797	L130	2000-01	18-7842		225	1990-97	18-7842 / 18-7843	18-7799
30	1987-90	18-7841		S130	1996-99	18-7842 / 18-7843	18-7799	L225	1994-99	18-7842 / 18-7843	18-7799
30	1991-02	18-7841		I50	1984-04	18-7842 / 18-7843	18-7799	LX225	2000-01	18-7842	
C30	1991-95	18-7839 / 18-7840	18-7797	D150	1997-99	18-7842 / 18-7843	18-7799	LX225	2002-03	18-7842 / 18-7843	18-7799
C30	1996-97	18-7840		L150	1986-99	18-7842 / 18-7843	18-7799	S225	1996-99	18-7842 / 18-7843	18-7799
CV30	1989-90	18-7839 / 18-7840	18-7797	LX150	1999-01	18-7842		SX225	2000-01	18-7842	
40	1984-94	18-7839 / 18-7840	18-7797	LZ150	2000-01	18-7842		SX225	2002-03	18-7842 / 18-7843	18-7799
40	1995-01	18-7840		LZ150	2002-04	18-7842 / 18-7843	18-7799	V225	1999	18-7842	
C40	1991-94	18-7839 / 18-7840	18-7797	DX150	1999-01	18-7842		V225	1998	18-7842 / 18-7843	18-7799
C40	1995-02	18-7840		DX150	2002-04	18-7842 / 18-7843	18-7799	VX225	2000-01	18-7842	
CV40	1990	18-7839 / 18-7840	18-7797	P150	1991-99	18-7842 / 18-7843	18-7799	VX225	2002-04	18-7842 / 18-7843	18-7799
P40	1998	18-7840		S150	1996-99	18-7842 / 18-7843	18-7799	VZ225	2003-04	18-7842 / 18-7843	18-7799
E48	1995-00	18-7840		SX150	1999-01	18-7842		250	1990-95	18-7842 / 18-7843	18-7799
50	1986-94	18-7839 / 18-7840	18-7797	SX150	2002-04	18-7842 / 18-7843	18-7799	L250	1990-99	18-7843	
50	1995-09	18-7840		V150	2000-01	18-7842		LX250	2000-01	18-7842	
C50	1998-01	18-7840		V150	2002-04	18-7842 / 18-7843	18-7799	LX250	2002-03	18-7842 / 18-7843	18-7799
P50	1991-94	18-7839 / 18-7840	18-7797	VX150	2000-01	18-7842		LZ250	2003-04	18-7842 / 18-7843	18-7799
P50	18-1995-96	18-7840		VX150	2002-01	18-7842 / 18-7843	18-7799	S250	1996-99	18-7842 / 18-7843	18-7799
55	1990	18-7798		VZ150	2000-04	18-7842		SX250	2000-01	18-7842	
C55	1991-94	18-7839 / 18-7840	18-7797	VZ150	2002-04	18-7842 / 18-7843	18-7799	SX250	2002-03	18-7842 / 18-7843	18-7799
CV55	1989-90	18-7839 / 18-7840	18-7797	Z150	2000-01	18-7842		VX250	2002-04	18-7842 / 18-7843	18-7799
60	2001-05	18-7840		Z150	2002-04	18-7842 / 18-7843	18-7799	VZ250	2003-04	18-7842 / 18-7843	18-7799
C60	1996-01	18-7840		PRO 150H	1987	18-7798		Z250	2003-04	18-7842 / 18-7843	18-7799
E60	1995-00	18-7840		175	1984-95	18-7842 / 18-7843	18-7799	LZ300	2004	18-7842 / 18-7843	18-7799
P60	1991-94	18-7839		175	1996-00	18-7842		VZ300	2004	18-7842 / 18-7843	18-7799
70	1984-94	18-7839 / 18-7840	18-7797	P175	1994-99	18-7842 / 18-7843	18-7799	Z300	2004	18-7842 / 18-7843	18-7799
70	1995-09	18-7840		S175	1996-99	18-7842 / 18-7843	18-7799	V6			
C70	2000-01	18-7840		V175	2000	18-7842		Special	1984-86	18-7842 / 18-7843	18-7799
C75	1994	18-7839 / 18-7840	18-7797	VZ175	2001	18-7842		V6 Excel	1987-89	18-7842 / 18-7843	18-7799
C75	1995-99	18-7840		VZ175	2002-04	18-7842 / 18-7843	18-7799				

**- UNIVERSAL DESIGN -
FUEL WATER SEPARATOR BRACKETS**



Bracket Type	Part #	Replaces	Bracket Type	Part #	Replaces
1/4" Stainless Steel	18-7777	MAR-FLTHD-SS-12	1/4" Aluminum	18-7853-1	MAR-FLTHD-AL-12
3/8" Stainless Steel	18-7776		3/8" Aluminum	18-7775	

FUEL WATER SEPARATOR KITS



**21 MICRON FILTER KITS
FOR CARBURETED ENGINES**

Kit Type	Part #	Micron Rating	Contents	Replaces
1/4" Aluminum (Short Filter)	18-7848-1 •	21	1 - 18-7844 filter & 1 18-7853-1 bracket 2 - 18-4256 1/4" pipe plugs	
1/4" Aluminum Bonus Pack Contains spare filter	18-7848-2	21	2 - 18-7844 filter & 1 18-7853-1 bracket 2 - 18-4256 1/4" pipe plugs	
1/4" Aluminum (Tall Filter)	18-7852-1	21	1 - 18-7845 filter & 1 18-7853-1 bracket 2 - 18-4256 1/4" pipe plugs	MAR-SEPAR-AT-OR
1/4" Aluminum Bonus Pack Contains spare filter	18-7852-2 •	21	2 - 18-7845 filter & 1 18-7853-1 bracket 2 - 18-4256 1/4" pipe plugs	
3/8" Aluminum (Tall Filter)	18-7775-1	21	1 - 18-7845 filter & 1 18-7775 bracket 2 - 18-4264 3/8" pipe plugs	
1/4" Stainless Steel (Tall Filter)	18-7777-1	21	1 - 18-7845 filter & 1 18-7777 bracket 2 - 18-4256 1/4" pipe plugs	ABB-SPRTR-HD-SS
3/8" Stainless Steel (Tall Filter)	18-7776-1	21	1 - 18-7845 filter & 1 18-7776 bracket 2 - 18-4264 3/8" pipe plugs	



**10 MICRON FILTER KITS
FOR FUEL INJECTED ENGINES**

Kit Type	Part #	Micron Rating	Contents	Replaces
1/4" Aluminum (Short Filter)	18-7983-1 •	10	1 - 18-7944 filter & 1 18-7853-1 bracket 2 - 18-4256 1/4" pipe plugs	
1/4" Aluminum Bonus Pack Contains spare filter	18-7983-2 •	10	2 - 18-7944 filter & 1 18-7853-1 bracket 2 - 18-4256 1/4" pipe plugs	
1/4" Aluminum (Tall Filter)	18-7982-1 •	10	1 - 18-7945 filter & 1 18-7853-1 bracket 2 - 18-4256 1/4" pipe plugs	
1/4" Aluminum Bonus Pack Contains spare filter	18-7982-2 •	10	2 - 18-7945 filter & 1 18-7853-1 bracket 2 - 18-4256 1/4" pipe plugs	
1/4" Aluminum (High Capacity Filter)	18-7966-1 •	10	1 - 18-7866 filter & 1 18-7853-1 bracket 2 - 18-4256 1/4" pipe plugs	MAR-SEPAR-AT-OR
3/8" Aluminum (Tall Filter)	18-7986-1	10	1 - 18-7945 filter & 1 18-7775 bracket 2 - 18-4264 3/8" pipe plugs	
1/4" Stainless Steel (Tall Filter)	18-7984-1 •	10	1 - 18-7945 filter & 1 18-7777 bracket 2 - 18-4256 1/4" pipe plugs	MAR-SPRTR-HD-SS
3/8" Stainless Steel (Tall Filter)	18-7985-1 •	10	1 - 18-7945 filter & 1 18-7776 bracket 2 - 18-4264 3/8" pipe plugs	

• Display Packaged



10 MICRON FILTER KITS WITH DRAIN BOWLS

Sierra AquaVue™ and metal bowl separator filters allow water to be drained from the filter to extend service life. Use the AquaVue™ bowl for outboard, above deck installations. USCG regulations require the use of the flame resistant metal bowl below deck.

- Display Packaged

Kit Type	Part #	Micron Rating	Contents
1/4" Aluminum w/ AquaVue™ bowl	18-7932-1 •	10	1 - 18-7919 filter & 1 18-7853-1 bracket 1 - 18-7922-1 AquaVue™ bowl 2 - 18-4256 1/4" pipe plugs
1/4" Aluminum w/ metal drain bowl	18-7951 •	10	1 - 18-7919 filter & 1 18-7853-1 bracket 1 - 18-7924 metal bowl 2 - 18-4256 1/4" pipe plugs
1/4" Stainless Steel w/ AquaVue™ bowl	18-7937-1 •	10	1 - 18-7919 filter & 1 18-7777 bracket 1 - 18-7922-1 AquaVue™ bowl 2 - 18-4256 1/4" pipe plugs
1/4" Stainless Steel w/ metal drain bowl	18-7938 •	10	1 - 18-7919 filter & 1 18-7777 bracket 1 - 18-7924 metal bowl 2 - 18-4256 1/4" pipe plugs

COMPACT BRACKET AND SEPARATOR KIT - FOR SMALL OUTBOARDS AND FRESH WATER APPLICATIONS

18-7774
COMPACT ALUMINUM BRACKET



18-7965-1
10 MICRON COMPACT SEPARATOR KIT
Replaces: MAR-MINIF-LT-AS
Contains:
1 - 18-7774 bracket
1 - 18-7865 filter



REPLACEMENT FILTERS



UNIVERSAL DESIGN - DIRECT REPLACEMENT FOR MERCURY AND YAMAHA

10 MICRON REPLACEMENT FILTERS

Part #	Description	Replaces
18-7944	Short - 3.875"	
18-7945	Long - 4.35"	ABB-FUELF-IL-TR
18-7866	High Capacity - 6"	MAR-FUELF-IL-TR
18-7865	Compact 10 Micron	MAR-MINIF-IL-TR

21 MICRON REPLACEMENT FILTERS

Part #	Description	Replaces
18-7844	Short - 3.875"	
18-7845	Long - 4.35"	ABB-FUELF-IL-TR



10 MICRON REPLACEMENT FILTERS AND KITS WITH DRAIN BOWLS

- Display Packaged

REPLACEMENT FILTERS

Part #	Description	Replaces
18-7919	Spin on replacement	MAR-24563-00-00 Racor S3213
18-7920	Spin on replacement	Racor S3214
18-7947	Spin on replacement • Fits - 120RRAC01	Racor S3240
18-7948	Spin on replacement • Fits - 320RRAC01	Racor S3227
18-7949	Spin on replacement • Fits - 660RRAC02	Racor S3232

REPLACEMENT FILTERS

Part #	Description	Replaces
18-7922-1	AquaVue™ Collection Bowl	
18-7924	Metal Collection Bowl	MAR-10171-00-10

FILTER & BOWL KITS

Part #	Description
18-7928-1 •	Filter & AquaVue™ Bowl • Mercury/Yamaha Style Contains: 18-7919 filter, 18-7922-1 bowl
18-7929 •	Filter & Metal Bowl • Mercury/Yamaha Style Contains: 18-7919 filter, 18-7924 bowl



18-8953
FUEL WATER SEPARATOR COVER
Fits: Yamaha mini-10 size filter



18-8954
FUEL WATER SEPARATOR COVER
Fits: Yamaha 18-7866 sized filter

 <p>18-7486 O-RING, FUEL FILTER BOWL Replaces: 61A-24564-00-00 Fits: V6</p>	 <p>18-7487 O-RING, FUEL FILTER ELEMENT Replaces: 65L-24564-00-00 Fits: V6</p>	 <p>18-7488 GASKET, FUEL FILTER BOWL Replaces: 6P3-24564-00-00 Fits: F/LF 150 - F300 (2006 - Current), VZ150 - VZ300 (2006 - Current), Z200 - Z300 (2006 - Current)</p>	 <p>18-7710-1 FUEL FILTER Replaces: 68T-24251-00-00 Fits: F6, F8 (2001 & Up)</p>
---	--	--	---

 <p>18-7713 FUEL FILTER (INLINE) Replaces: 646-24251-02-00 Fits: 6 (1989, 1992-99), 8 (1989-99, 2001-02), F4 (1999-02), F9.9 (1989-95, 1997-99, 2001-02), FT 9.9 (1988-90)</p>	 <p>18-7780 FUEL FILTER Replaces: 6F5-24563-00-00 For: 9.9 - 225NR</p>	 <p>18-7781 FUEL FILTER Replaces: 61N-24563-00-00 For: 9.9/90° SX</p>	 <p>18-7782 FUEL FILTER Replaces: 61A-24563-00-00 For: V6, 3.1L, D-T</p>
---	---	---	---

 <p>FUEL FILTERS</p> <table border="1"> <tr> <th>Part #</th> <th>Application:</th> </tr> <tr> <td>18-7828-1</td> <td>1/4" Small Capacity (For 1/4" Fuel Line)</td> </tr> <tr> <td>18-7829</td> <td>1/4" Large Capacity (For 1/4" Fuel Line)</td> </tr> <tr> <td>18-7830</td> <td>5/16" Replaces: 65W-24251-10-00</td> </tr> <tr> <td>18-7831</td> <td>3/8"</td> </tr> </table>	Part #	Application:	18-7828-1	1/4" Small Capacity (For 1/4" Fuel Line)	18-7829	1/4" Large Capacity (For 1/4" Fuel Line)	18-7830	5/16" Replaces: 65W-24251-10-00	18-7831	3/8"	 <p>18-7955 10 MICRON FUEL FILTER ELEMENT Replaces: 68F-24563-10-00 Fits: 150hp -300hp. (2004-2006) Models Z, VZ, LZ</p>	 <p>18-7979 FUEL FILTER Replaces: 68V-24563-00-00</p>
Part #	Application:											
18-7828-1	1/4" Small Capacity (For 1/4" Fuel Line)											
18-7829	1/4" Large Capacity (For 1/4" Fuel Line)											
18-7830	5/16" Replaces: 65W-24251-10-00											
18-7831	3/8"											

 <p>18-79799 FUEL FILTER Replaces: 6D8-WS24A-00-00 F50-F115 after April 2006 For filter housing marked "6D8" ONLY!</p>	 <p>18-79809 FUEL FILTER Replaces: 6P3-24563-01-00, 6P3-WS24A-00-00, 6P3-WS24A-01-00 F150, F200, F225, F250, Z-VZ 150 to 300 hp. after April 2006 For filter housing marked "6P3" ONLY!</p>	 <p>18-79905 10 MICRON FUEL FILTER Replaces: 69J-24501-10-00 Fits: F150 - F225 (2006 - Current), F250 - (2005 - Current)</p>
---	---	---

 <p>18-79970 FUEL FILTER Replaces: 6BG-13915-00 Fits: F30(2013), F40(2008-13), F50(2005-13), F60(2005-13), F70(2010-13), F75(2005-13), F90(2005-13), T50(2005-13), T60(2005-13)</p>	 <p>18-79972 ELEMENT, FILTER (CARB INLET) Replaces: 67F-14371-01 Fits: F75(2003-04), F80(2002-03), F90(2003-04), F100(2002-03)</p>	 <p>18-79973 FUEL FILTER Replaces: 6C5-13915-00 Fits: F50(2005-13), F60(2005-13), F70(2010-13), F75(2005-13), F90(2005-13), T50(2005-13), T60(2005-13)</p>
--	--	---



18-79977
FUEL FILTER

Replaces: 6L5-24251-00
Fits: 3(1992-02), F2.5(2003-12), F4(1999-08)



18-79979
FUEL FILTER

Replaces: 6CB-24501-00
Fits: F225 4.2L (2010), F250 4.2L (2010), F300 4.2L (2010), LF225 4.2L (2010), LF250 4.2L (2010), LF300 4.2L (2010), VF200 4.2L (2009-10), VF225 4.2L (2009-10), VF250 4.2L (2009-10)



18-79980
FUEL FILTER

REPLACES: 68F-24563-00
Fits: LZ150(2000-04), LZ200(2000-04), LZ250(2003-04), VZ150(2000-04), VZ175(2001-04), VZ200(2001-04), VZ225(2003-04), VZ250(2003-04), Z150(2000-04), Z175(2001-04), Z200(2000-04), Z250(2003-04)



18-79981
FUEL FILTER

Replaces: 69J-24501-00
Fits: F150(2004-05), F200(2002-05), F225(2002-05), LF150(2004-05), LF200(2002-05), F225(2002-05)



18-79982
FUEL FILTER

Replaces: 69J-24502-00
Fits: F150(2005-14), F200(2005-10), F225(2005-10), F75(2005-14), F90(2005-14), FL150(2010), LF150(2005-14), LF200(2005-10), LF225(2005-10)



18-79983
FUEL FILTER

Replaces: 6C5-24251-00
Fits: F115(2014-15), F30(2013-15), F40(2008-15), F50(2005-15), F60(2005-15), F70(2010-15), F75(2005-15), F90(2005-15), LF115(2014-15), T50(2005-15), T60(2005-11), VF115(2015)



18-79984
FUEL FILTER

Replaces: 6AW-24502-10, 6AW-24502-00-00
Fits: 2007-09, F350(2007-11), FL350(2010), LF300(2007-09), LF350(2007-11)



18-79985
FUEL FILTER

Replaces: 68V-24502-30, 68V-24502-20-00
Fits: F115(2010-11), LF115(2010-11)



18-79986
FUEL FILTER

Replaces: 68V-24502-02, 68V-24502-01-00, 68V-24502-00-00
Fits: F115(2005-09), LF115(2005-09)



18-79907
VST FILTER

Replaces: 60V-24251-01-00
Fits: LZ150(2005), VZ150(2005-10), Z150(2005), VZ175(2005-10), Z175(2005), LZ200(2005-10), VZ200(2005-09), Z200(2005-10), VZ225(2005-09), LZ250(2005), VZ250(2005-09), Z250(2005), LZ300(2005-06), VZ300(2005-09), Z300(2005-06)



18-79900
VST FILTER (TAN)

Replaces: 66K-13915-00-00
Fits: DX150 (1999-05), LX150 1999-01, PX150 (1999), SX150 (1999-04), VX150 (2000-04), LX200 (1999-01), SX200 (1999-05), V200 (1999), VX200 (2000-05), L225 (1999), LX225 (2000-03), S225 (1999), SX225 (2000-03), V225 (1999), VX225 (2000-04), L250 (1999), LX250 (2000-03), SX250 (2000-03), VX250 (2002-04)



18-79901
VST FILTER (BLUE)

Replaces: 65L-13915-00-00
Fits: L225 (1997-98), S225 (1997-98), L250 (1997 - 98), V200 (1998), V225 (1998)

18-79902
VST FILTER

Replaces:

63P-13915-00-00
Fits: F150 TXR(2004-09), F150 TLR(2004-09), F150 TJR(2009), LF150 TXR(2004-09), F250 TXR(2005-09), F250 TUR(2005-09), F300 TXR(2007-09), F300 TUR(2007-09), F350 TXR(2007-09), F350 TUR(2007-09), F225TLR (2007-09)



18-79903
VST FILTER

Replaces:

68V-13915-00-00
Fits: F115 (2000-09), F200 TXR(2002-09), LF200 TXR(2002-09), F225 TXR(2002-09), F225 TUR(2002-09)



18-79904
VST FILTER (YELLOW)

Replaces:

68F-13915-00-00
Fits: HPDI 150(2000-05), V-Max HPDI 150(2000-09), V-Max HPDI 175(2001-09), HPDI 200(2000-09), HPDI 225(2003-09), HPDI 250 (2003-09), HPDI 300(2004-09)



18-79978
VST FILTER

Replaces: 6CB-13915-00

Fits: F225 4.2L (2010), F250 4.2L (2010), F300 4.2L (2010), LF225 4.2L (2010), LF250 4.2L (2010), LF300 4.2L (2010), VF200 4.2L (2009-10), VF225 4.2L (2009-10), VF250 4.2L (2009-10)



18-79910
FUEL FILTER ASSEMBLY

Replaces: 61N-24560-00, 61N-24560-10

Fits: 15(1994-09), 20(1996-97), 25(1994-09), 30(1995-01), 40(1994-05), 50(1994-09), 60(2001-05), 70(1994-09), 9.9(1994-09), 90(1994-09), B90(1997-99), C25(1994-97), C30(1994-97), C40(1994-03), C50(1998-01), C55(1994-95), C60(1996-01), C75(1994-99), C80(1997), C85(1994-96), C90(1997-01), E48(1995-00), E60(1995-00), E75(1995-00), F15(2005-10), F20(2006-10), F25(2005, 2009-10), F40(1999), F50(1995-04), F9.9(2005-06)



18-79950
VST KITS

Replaces: Kit 1
Fits: F150(04-12), LF150(04-12)

— CONTAINS —

Part #	Description	O.E. #
18-79902	VST Filter	63P-13915-00-00
18-79905	Fuel Filter, 10 Micron	68J-24501-10-00
18-0712	Float Chamber Gasket	63P-14984-00-00

18-79951
VST KITS

Replaces: Kit 2
Fits: F115(00-11), F200(02-10), F225(02-06), F225TXR(07-10), LF115(00-11), LF200(02-10), LF225(02-06), LF225 TXR(07-10)

— CONTAINS —

Part #	Description	O.E. #
18-79903	VST Filter	68V-13915-00-00
18-0710	Float Chamber Gasket	68V-14984-00-00

18-79952
VST KITS

Replaces: Kit 3
Fits: DX150(99-05), L225(99), L250(99), LX150(99-01), LX200(99-01), LX225(00-03), LX250(00-03), PX150(99), S225(99), S250(99), SX150(99-04), SX200(00-05), SX225(00-03), SX250(00-03), V200(99), V225(99), VX150(00-04), VX200(00-05), VX225(00-04), VX250(02-04)

— CONTAINS —

Part #	Description	O.E. #
18-79900	VST Filter	66K-13915-00-00
18-0711	Float Chamber Gasket	66K-14984-00-00

18-79953
VST KITS

Replaces: Kit 4
 LZ150(00-05), LZ200(00-11), LZ250(03-05), LZ300(04-06), VZ150(00-11), VZ175(01-11), VZ200(01-09), VZ225(03-09), VZ250(03-09), VZ300(04-09), Z150(00-05), Z175(01-05), Z200(00-11), Z250(03-05), Z300(04-06)

— CONTAINS —

Part #	Description	O.E. #
18-79904	VST Filter	68F-13915-00-00
18-0711	Float Chamber Gasket	66K-14984-00-00

18-79954
VST FILTER & GASKET KIT

Fits: F225TLR (2007-2009), F250 (2005-2010), LF250 (2005-2010)

— CONTAINS —

Part #	Description	O.E. #
18-79902	VST Filter	63P-13915-00-00
18-0713	Float Chamber Gasket	6P2-14984-00-00

18-79955
VST FILTER & GASKET KIT

Fits: F300 (2007-2009), LF300 (2007-2009), F350 (2007-2010), LF350 (2007-2010)

— CONTAINS —

Part #	Description	O.E. #
18-79902	VST Filter	63P-13915-00-00
18-0714	Float Chamber Gasket	6AW-14984-00-00

18-79956
VST FILTER & GASKET KIT

Fits: F115 (2001-2014), F200 (2011-2014), F250 (2010-2014), F300 (2010-2014), F350 (2011-2014), FL250 (2010), FL300 (2010), LF115 (2011-2014), LF200 (2011-2014), LF225 (2010-2014), LF250 (2010-2014), LF300 (2010-2014), LF350 (2011-2014), VF150 (2013-2014), VF200 (2010-2014), VF225 (2010-2014), VF250 (2009-2014)

— CONTAINS —

Part #	Description	O.E. #
18-79902	VST Filter	63P-13915-00-00
18-0716	Float Chamber Gasket, Viton	6CB-14984-00-00

18-79957
VST FILTER & GASKET KIT

Fits: F50 (2005-2014), F60 (2005-2014), F70 (2010-2014), F75 (2005-2014), F90 (2005-2014), T50 (2005-2014), T60 (2005-2014)

— CONTAINS —

Part #	Description	O.E. #
18-79973	Fuel Filter	6C5-13915-00-00
18-0717	Float Chamber Gasket, Viton	6C5-14984-00-00

18-2083
FUEL INJECTOR SEAL

Replaces: 68V-13766-00-00

Part #	Description	O.E. #
18-2083	Fuel Injector Seal	68V-13766-00-00



18-7655
OXYGEN SENSOR
 Replaces: 67H-8592A-01-00,
 67H-8592A-00-00
 Fits: PX150 (1999), DX150 (99-05),
 LX150, LX200 (99-01), VX150 (00-04)



18-7656
OXYGEN SENSOR
 Replaces: 68F-8592A-00-00
 Fits: L225, L250 (98-99), LX225, LX250 (00-03), LZ150
 (00-05), LZ200 (00-12), S225, S250 (97-99), SX150 (99-
 04), SX200 (99-05), SX225, SX250 (00-03), V200, V225
 (98-99), VX200 (00-05), VX225 (98-05), VX250 (02-04),
 VZ150 (00-14), VZ175 (01-12), VZ200 (01-04), Z150
 (00-05), Z175 (01-05), Z200 (00-12)



18-7606
WATER SENSOR PROBE
 Replaces: MAR-10171-30-00

8' LENGTH COMPLETE FUEL LINE ASSEMBLIES

3/8"
FUEL LINE ASSEMBLY

18-8017EP-2 SILVERADO 4000 Premium

OE# 6YL-24306-60-00



18-8077-1
TANK CONNECTOR
 (SOLD SEPARATELY)



18-8076
FUEL CONNECTOR

18-8005EP-1
PRIMER BULB

18-8076
FUEL CONNECTOR



*

FUEL LINE ASSEMBLY COMPONENTS
 Fits: F75-F250 and 115-300 HP



3/8"
FUEL LINE ASSEMBLY

18-8017S-1 SILVERADO 4000 Premium

OE# 6YL-24306-60-00



18-8077-1
TANK CONNECTOR
 (SOLD SEPARATELY)



18-80415
FUEL CONNECTOR

18-8005S
PRIMER BULB

18-80415
FUEL CONNECTOR



*

FUEL LINE ASSEMBLY COMPONENTS
 Fits: F75-F250 and 115-300 HP



PRIMER BULBS



18-8002EP-1
18-8002EP-1-10^①
PRIMER BULB
 1/4"

18-8005EP-1
18-8005EP-1-10^①
PRIMER BULB
 3/8"
 Replaces: 174512
 Large capacity bulb

18-8004EP-1
18-8004EP-1-10^①
PRIMER BULB
 5/16"
 Large capacity bulb



18-8040
FUEL TANK ELBOW
 Universal Fitting with
 1/4" NPT Threads
 Replaces: ABA-FBARB-90-DG
 (Brass)



18-8055
HOSE BARB
 1/4" NPT threads for connection of 5/16" I.D.
 hose
 Replaces: ABA-FLINE-BA-RB
 (Brass)



18-8077-1
18-8077-1-10^①
TANK CONNECTOR
 (1/4" NPT)
 Fits: F75-F250 and 115-300HP
 Mates with 18-80413, 18-80414, 18-80415





18-80413
FUEL CONNECTOR
1/4"
Replaces: 6Y1-24305-06-00, 6Y1-24305-04
Mates with 18-8077-1



18-80414
FUEL CONNECTOR
Replaces: 6G1-24305-05-00, 6G1-24305-04
Fits: 6(1989, 1992-93), 8(1984-85, 1989-93, 2001-02), 9.9(1984-93, 2000-03), 15(1984-93, 2000-03), 25(1984-85, 1988-93, 2000-03), 30(1984-87, 1989-93, 1999, 2001-02), 40(1984-86, 1988-90, 1992-93, 2000-03), 50(1986-93, 2000-03), 60(2001-03), 70(1984-93, 2000-03), 90(1984-93, 2000-03), C25(1991, 1993), C30(1991-93), C40(1991-93, 2000-02), C50(2000-01), C55(1991-93), C60(2000-01), C70(2000-01), C85(1991-93), C90(2000-01), E48(2000), F6(2001-03), F8(2001-03), F9.9(1985-93, 2001-03), F15(1998-99, 2000-01), F25(1998-99, 2000-03), F30(2001-03), F40(1999, 2000-03), F50(1999, 2000-03), F60(2002-03), T8(2001-03), T9.9(1991-93, 1999, 2001-03), T25(2001-03), T50(1999, 2000-03), T60(2003)
Use with Yamaha 6mm fuel line
Mates with 18-8077-1



18-80415
FUEL CONNECTOR
Replaces: 6E5-24305-05, 6Y2-24305-05
Use with Yamaha 8mm fuel line
Mates with 18-8077-1

18-9145
OETIKER CLAMP KIT
Replaces: YB-6AW04-A

Part #	Qty.	Yamaha #	Oetiker #	Description	
18-9141	1	YB-6AW04-4	14100082	Oetiker Jaw Pincers	
Part #	Qty.	Yamaha #	Oetiker #	Nominal ID	
				Inches	mm
18-9133-9	50	YB-6AW04-1	16700016	5/8"	15.7
18-9146-9	50	YB-6AW04-3	16702498	25/32"	19.8

All clamps are standard package of 10. Each Package of 10 is available individually.

* Tanks and Engines for picture purpose only.

① Discount shop pack of 10 - Priced per package



18-3040
IMPELLER
Replaces: 63V-44352-01-00



18-3042
IMPELLER
Replaces: 67F-44352-00-00



18-3063
IMPELLER
Replaces: 662-44352-01-00



18-3065
IMPELLER
Replaces: 6L2-44352-00-00



18-3066
IMPELLER
Replaces: 6G1-44352-00-00



18-3067
IMPELLER
Replaces: 689-44352-02-00



18-3068
IMPELLER
Replaces: 6H4-44352-02-00



18-3069
IMPELLER
Replaces: 6H3-44352-00-00



18-3070
IMPELLER
Replaces: 688-44352-03-00



18-3071
IMPELLER
Replaces: 6E5-44352-01-00



18-3072
IMPELLER
Replaces: 646-44352-01-00



18-3073
IMPELLER
Replaces: 6E0-44352-00-00



18-3074
IMPELLER
Replaces: 682-44352-01-00



18-3088
IMPELLER
Replaces: 6F5-44352-00-00



18-45617-1
IMPELLER
 Replaces: 6CE-44352-00-00
 Fits: F225-F350, FL250-FL350 & VF250 Engines



18-8910
IMPELLER
 Replaces: 68T-44352-00-00



18-8911
IMPELLER
 Replaces: 6L5-44352-00-00



18-8925
IMPELLER
 Replaces: 6AW-44352-00-00



18-3185
WATER PUMP HOUSING
 Replaces: 61N-44311-01-00,
 61N-44311-00-00



18-43263
WATER PUMP HOUSING
 Replaces: 68D-G4311-01-00



18-3170
WATER PUMP HOUSING
 Replaces: 6E5-44311-00-00



18-3173-1
WATER PUMP HOUSING
 Replaces: 61A-44311-00-00,
 61A-44311-01-00



18-3171
WATER PUMP HOUSING
 Replaces: 688-44311-01-00



18-3356
WATER PUMP HOUSING
 Includes Impeller Cup
 Replaces: 63V-44301-00-00
 Fits: Two-Stroke: 9.9hp-15hp (1996-Current), Four-Stroke:
 6hp-8hp (2001-Current); 9.9hp. (2006-Current); 15hp
 (1998-Current)



18-3482
WATER PUMP HOUSING
 Replaces: 6CE-44311-01-00



18-3486
WATER PUMP HOUSING
 Replaces: 6L2-44311-01-00
 Fits: F25C (2016-17)

new



new

18-3483
WATER PUMP HOUSING
 Replaces: 6AW-44311-01-00
 Fits: F300, LF300 (2007-09), F350A, LF350A (2010-11),
 F350B, LF350B (2012-15), F350C, LF350C (2016-18), FL350
 (2010)



new

18-3484
WATER PUMP HOUSING
 Replaces: 6AW-44311-01-00
 Fits: F15C, F20 (2006-17)



new

18-3485
WATER PUMP HOUSING
 Replaces: 6CJ-44311-00-00
 Fits: F70A (2010-17)



18-4567
WATER PUMP HOUSING
Replaces: 6AH-44311-00
Fits: F4 (2009-17), F6 (2009-17)



18-9081
WATER PUMP HOUSING COVER
Replaces: 6E5-44312-00-00
Fits: 75 (2017), 90 (2016-2017), 115 (1984-2017), 130 (1988-2004), 150-250 (1984-2017), 250 (1990-2017), 300 (2004-2009)



18-9082
WATER PUMP HOUSING COVER
Replaces: 6AW-44312-00-00
Fits: F225 (2010-15), F250 (2010), F250 (2010-15), F300 (2007-15), F350 (2007-15), FL250 (2010), FL300 (2010), FL350 (2010), LF225 (2010-15), LF250 (2010-15), LF300 (2007-15), LF350 (2007-15), VF250 (2015)

PKG. OF 2



18-43716
IMPELLER PIN
Replaces: 93604-18080-00
Fits: 3(1988-02), 4(1984-99), 5(1984-01), F2.5(2003-14), F4(1999-14), F6(2009-14)

IMPELLER KEYS

Part No.	OE No.
18-3297	90280-03M03-00
18-3305	90280-03024-00, 90280-03003-00
18-3300	90280-04M00-00
18-3301	90280-04M04-00
18-3302	90280-04M05-00





BOLTS

Part No.	OE No.	Application
18-0256	97095-08045-00 97080-08045-00	8-1.25 x 45mm F6 (2001-05), F8 (2001-05) M8-1.25x45mm 18-8S/S
18-2605	90119-08M87-00	F80 (1999-03), F90 (2003-04), F100 (1999-02) M8-1.25x75mm 18-8 S/S
18-2606	90119-08M13-00	F80 (1999-03), F90 (2003-04), F100 (1999-02) M8-1.25x50mm 18-8 S/S
18-2607	97095-06040-00	For: 3HP (1988-99, 2002) M8-1.0x40mm 18-8 S/S
18-8400-9 ^{①②}	90119-08M15-00	8-1.25 x 29mm



18-9079
WAVE WASHER KIT
Replaces: 61A-45538-00-00 + 61A-45527-00-00 + 90206-22M19 + 90201-22M01
Fits: Yamaha 2-stroke 115-300hp (1993 & Up); Yamaha 4-stroke 115-225hp (2002 & Up); Mercury 4-stroke 225 EFI S/N 0T653945 & Up

— CONTAINS —

Part #	Desc.	O.E.#	Qty.
18-9075	Spacer	61A-45538-00-00	1
18-9076	Collar	61A-45527-00-00	1
18-9077	Wave Washer	90206-22M19-00	1
18-9078	Stainless Steel Washer	90201-22M01-00	2



18-1828
WATER DAMPER SEAL
Replaces: 663-44366-00
Fits: F30 (2013-17), F40A (2008-17)



18-1836
WATER DAMPER SEAL
Replaces: 6L2-44367-00
Fits: F15C, F20 (2006-17)



18-1837
WATER DAMPER SEAL
Replaces: 6L2-44367-10
Fits: F25C (2016-17)



18-1840
WATER DAMPER SEAL
Replaces: 6EE-G4366-00
Fits: F2.5 (2015-17)



18-1829
WATER SEAL DAMPER
Replaces: 6AW-44365-00-00
Fits: F225 (2010-15), F250 (2010), F250 (2010-15), F300 (2007-15), F350 (2007-15), FL250 (2010), FL300 (2010), FL350 (2010), LF225 (2010-15), LF250 (2010-15), LF300 (2007-15), LF350 (2007-15), VF250 (2015)

18-1830
WATER SEAL DAMPER

Replaces: 663-44366-00
Fits: 25 ML, MS(1997-02), 30(1987-01), 40(1984-05), 50(1986-09), 60(2001-05), 70(1984-09), 90(1984-09), B90(1997-99), C30(1995), C40(1991-01), C50(1998-01), C55(1991-95), C60(1996-01), C70(2000-01), C75(1994-99), C80(1997), C85(1991-96), C90(1997-01), E48(1995-00), E60(1995-00), E75(1995-00), F30(2001-05, 2013), F40(1999-13), F50(1995-13), F60(2002-13), F70(2010-13), F75(2003-11), F80(1999-03), F90(2003-13), F100(1999-03), F200(2002-12), F225(2002-12), F250(2005-12), L225(1994-99), L250(1990-99), LF200(2002-12), LF225(2002-10), LF250(2005-12), LX225(2000-03), LX250(2000-03), LZ250(2003-05), LZ300(2004-06), P40(1998), P50(1991-96), P60(1991-99), P75(1996-99), S225(1996-99), S250(1996-99), SX225(2000-03), SX250(2000-03), T25(2001-13), T50(1996-13), T60(2003-13), V200(1998-99), V225(1998-99), VX200(2000-05), VX225(2000-04), VX250(2002-04), VZ200(2005-09), VZ225(2005-09), VZ250(2003-09), VZ300(2004-09), Z250(2003-05), Z300(2004-06)



18-1831
WATER SEAL DAMPER
Replaces: 682-44366-00
Fits: 9.9(1984-95), 15(1984-95)



18-1832
WATER SEAL DAMPER
Replaces: 682-44367-00
Fits: 9.9(1984-95), 15(1984-95)



18-1833
WATER SEAL DAMPER
Replaces: 647-44366-00
Fits: 6(1986-00), 8(1984-00), 9.9(1996-09), 15(1996-09), F9.9(2005-06), F15(1998-06), T9.9(2005-06)



18-1834
WATER SEAL DAMPER
Replaces: 682-44365-00
Fits: 6(1986-00), 8(1984-00), 9.9(1996-09), 15(1996-09), F9.9(2005-06), F15(1998-06), T9.9(2005-06)



18-1835
WATER SEAL DAMPER
Replaces: 6E5-44365-00-00
Fits: 75 (2017), 90 (2016-2017), 115 (1984-2017), 130 (1988-2004), 150-250 (1984-2017), 250 (1990-2017), 300 (2004-2009)



18-3505
WATER SEAL DAMPER
Replaces: 63V-44365-10-00
Fits: 2-Stroke: 9.9hp & 15hp 1997-Current
 4-Stroke: F6 & F/T8 2001-Current; F/T 9.9 2005-Current; F15 1998-Current



18-3166
WATER SEAL DAMPER
Replaces: 6E0-44366-00-00
For: 2 (1984-85, 88-99, 2002), 3 (1988-99, 02), 4 (1984-85, 88-99), 5 (1984-85, 95-02), F2.5 (2003-05)



18-3176
WATER SEAL DAMPER
Replaces: 68T-44366-00-00
For: F6, F8 (2001-05), C30 (1993-97)



18-3148
WATER PUMP KIT
Without Housing
Replaces: 682-W0078-A1-00

— CONTAINS —

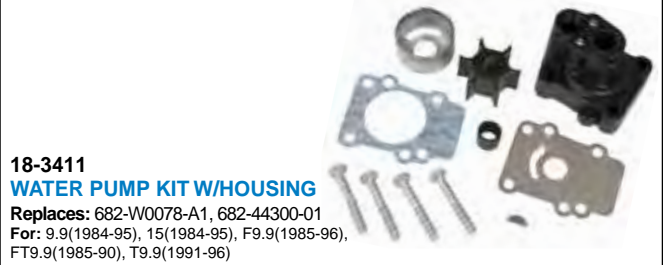

18-3411
WATER PUMP KIT W/HOUSING
Replaces: 682-W0078-A1, 682-44300-01
For: 9.9(1984-95), 15(1984-95), F9.9(1985-96), FT9.9(1985-90), T9.9(1991-96)

— CONTAINS —

Part #	Desc.	O.E.#	Qty.
18-0768	Gasket, Water Pump	682-44315-A0-00	2
18-2607	Bolt	97095-06045-00	4
18-3074	Impeller	682-44352-01-00	1
18-3297	Key, Impeller	90280-03024-00	1
NSS	Grommet	682-44365-00-00	1
NSS	Cup, Insert	682-44322-00-00	1
NSS	Plate, Wear	682-44323-00-00	1

Part #	Desc.	O.E.#	Qty.
18-0768	Gasket, Water Pump	682-44315-A0-00	2
18-2607	Bolt	97095-06040-00	4
18-3074	Impeller	682-44352-01-00	1
18-3297	Key, Impeller	90280-03M03-00	1
NSS	Seal, Water	682-44365-00-00	1
NSS	Cup, Insert	682-44322-00-00	1
NSS	Plate, Wear	682-44323-00-00	1
NSS	Housing, Water Pump	682-44300-01-00	1



18-3310
WATER PUMP KIT
Without Housing
Replaces: 6G5-W0078-01-00

— CONTAINS —



18-3311
WATER PUMP KIT
With Housing
Replaces: 6G5-W0078-A1-00

— CONTAINS —

Part #	Description	O.E. #	Qty.
18-0244	Gasket, Water Pump	6E5-44315-00-00	1
18-0256	Bolt	97395-08045-00-00	4
18-3071	Impeller	6E5-44352-00-00	1
18-3302	Key, Impeller	90280-04M05-00	1
18-3345	Plate, Wear	6G5-44323-00-00	1
18-7483	O-Ring, Water Pump	93210-37M67-00	1
18-7485	O-Ring, Water Pump	93210-86M38-00	1
NSS	Cup, Insert	6E5-44322-00-00	1
NSS	Washers, Bolt	90209-08M02-00	4

Part #	Description	O.E. #	Qty.
18-0244	Gasket, Water Pump	6E5-44315-A0-00	1
18-0256	Bolt	97095-08045-00	4
18-3071	Impeller	6E5-44352-01-00	1
18-3170	Housing, Water Pump	6E5-44311-00-00	1
18-3302	Key, Impeller	90280-04M05-00	1
18-3333	Cup, Insert	61A-44322-00-00	1
18-3345	Plate, Wear	6G5-44323-01-00	1
18-7483	O-Ring (6G8)	93210-37M67-00	1
18-7485	O-Ring	93210-86M38-00	1
NSS	Pin, Dowel	93606-12019-00	2
NSS	Washer, Bolt	90209-08M02-00	4

18-3312
WATER PUMP KIT
Without Housing
Replaces: 6N6-W0078-00-00



— CONTAINS —

Part #	Description	O.E. #	Qty.
18-0244	Gasket, Water Pump	6E5-44315-A0-00	1
18-0256	Bolt	97095-08045-00	4
18-3071	Impeller	6E5-44352-01-00	1
18-3302	Key, Impeller	90280-04M05-00	1
18-3333	Cup, Insert	61A-44322-00-00	1
18-3344	Plate, Wear	6E5-44323-00-00	1
18-7483	O-Ring (6G8)	93210-37M67-00	1
18-7485	O-Ring	93210-86M38-00	1
NSS	Pin, Dowell	93606-12019-00	2
NSS	Washer, Bolt	90209-08M02-00	4

18-3313-1
WATER PUMP KIT
(with Housing)
Replaces: 6N6-W0078-01-00



— CONTAINS —

Part #	Description	O.E. #	Qty.
18-0244	Gasket, Water Pump	6E5-44315-A0-00	1
18-0256	Bolt	97095-08045-00	4
18-3071	Impeller	6E5-44352-01-00	1
18-3173-1	Housing, Water Pump	6E5-44311-00-00	1
18-3302	Key, Impeller	90280-04M05-00	1
18-3333	Cup, Insert	61A-44322-00-00	1
18-3344	Plate, Wear	6E5-44323-00-00	1
18-7483	O-Ring (6G8)	93210-37M67-00	1
18-7485	O-Ring	93210-86M38-00	1
NSS	Pin, Dowell	93606-12019-00	2
NSS	Washer, Bolt	90209-08M02-00	4

18-3370
WATER PUMP KIT
Without Housing
Replaces: 692-W0078-00-00,
692-W0078-01-00, 692-W0078-A0-00



— CONTAINS —

Part #	Description	O.E. #	Qty.
18-0239	Gasket, Water Pump	688-44315-A0-00	1
18-0240	Gasket, Water Pump	688-44316-A0-00	1
18-3070	Impeller	688-44352-03-00	1
18-3301	Key, Impeller	90280-04M04-00	1
18-7436	O-Ring	93210-46044-00	1
NSS	Bolt	97395-08050-00	4
NSS	Cup, Insert	688-44322-00-00	1
NSS	Plate, Wear	688-44323-00-00	1
NSS	Gasket, Water Pump	688-44324-A0-00	1

18-3371
WATER PUMP KIT (with Housing)
Replaces: 692-W0078-A0-00



— CONTAINS —

Part #	Description	O.E. #	Qty.
18-3070	Impeller	688-44352-03-00	1
18-3171	Housing, Water Pump	688-44311-01-00	1
18-3301	Key, Impeller	90280-04M04-00	1
18-7436	O-Ring	93210-46044-00	1
NSS	Bolt	97395-08070-00	2
NSS	Bolt	97395-08050-00	2
NSS	Cup, Insert	688-44322-00-00	1
NSS	Plate, Wear	688-44323-00-00	1
NSS	Gasket, Water Pump	688-44315-A0-00	1
NSS	Gasket, Water Pump	688-44324-A0-00	1
NSS	Gasket, Water Pump	688-44316-A0-00	1

18-3372
WATER PUMP KIT
Without Housing
Replaces: 6E5-W0078-01-00



— CONTAINS —

Part #	Description	O.E. #	Qty.
18-0244	Gasket, Water Pump	6E5-44315-A0-00	1
18-0256	Bolt	97095-08045-00	4
18-3071	Impeller	6E5-44352-01-00	1
18-3302	Key, Impeller	90280-04M05-00	1
18-3344	Plate, Wear	6E5-44323-00-00	1
18-7483	O-Ring	93210-37M67-00	1
18-7485	O-Ring	93210-86M38-00	1
NSS	Pin, Dowell	93606-12019-00	2
NSS	Washer, Bolt	90209-08M02-00	4
NSS	Cup, Insert	6E5-44322-00-00	1

18-3373
WATER PUMP KIT
(with Housing)
Replaces: 6E5-W0078-A1-00



— CONTAINS —

Part #	Description	O.E. #	Qty.
18-0244	Gasket, Water Pump	6E5-44315-A0-00	1
18-0256	Bolt	97095-08045-00	4
18-3071	Impeller	6E5-44352-01-00	1
18-3170	Housing, Water Pump	6E5-44311-00-00	1
18-3302	Key, Impeller	90280-04M05-00	1
18-3344	Plate, Wear	6E5-44323-00-00	1
18-7483	O-Ring (6G8)	93210-37M67-00	1
18-7485	O-Ring	93210-86M38-00	1
NSS	Pin, Dowell	93606-12019-00	2
NSS	Washer, Bolt	90209-08M02-00	4
NSS	Cup, Insert	6E5-44322-00-00	1

18-3395
WATER PUMP KIT
Without Housing
Replaces: 61A-W0078-01-00



— CONTAINS —

Part #	Description	O.E. #	Qty.
18-0244	Gasket, Water Pump	6E5-44315-A0-00	1
18-0256	Bolt	97095-08045-00	4
18-3071	Impeller	6E5-44352-01-00	1
18-3302	Key, Impeller	90280-04M05-00	1
18-3333	Cup, Insert	61A-44322-00-00	1
18-3345	Plate, Wear	6G5-44323-01-00	1
18-7483	O-Ring (6G8)	93210-37M67-00	1
18-7485	O-Ring	93210-86M38-00	1
NSS	Pin, Dowell	93606-12019-00	2
NSS	Washer, Bolt	90209-08M02-00	4

18-3396-1
WATER PUMP KIT
(with Housing)
Replaces: 61A-W0078-A2-00, 61A-W0078-A3-00



— CONTAINS —

Part #	Description	O.E. #	Qty.
18-0244	Gasket, Water Pump	6E5-44315-A0-00	1
18-0256	Bolt	97095-08045-00	4
18-3071	Impeller	6E5-44352-01-00	1
18-3173-1	Housing, Water Pump	6E5-44311-00-00	1
18-3302	Key, Impeller	90280-04M05-00	1
18-3333	Cup, Insert	61A-44322-00-00	1
18-3345	Plate, Wear	6G5-44323-01-00	1
18-7483	O-Ring (6G8)	93210-37M67-00	1
18-7485	O-Ring	93210-86M38-00	1
NSS	Pin, Dowell	93606-12019-00	2
NSS	Washer, Bolt	90209-08M02-00	4

18-3397
WATER PUMP KIT

Without Housing

Replaces: 679-W0078-00-00, 679-W0078-A0-00

— CONTAINS —



Part #	Description	O.E. #	Qty.
18-3088	Impeller	6F5-44352-00-00	1
18-0256	Bolt	97095-08045-00	2
18-3300	Key, Impeller	90280-04M00-00	1
18-3334	Cup, Insert	676-44322-00-00	1
NSS	Gasket, Water Pump	676-44315-A0-00	1
NSS	Gasket, Water Pump	676-44324-A0-00	1
NSS	Gasket, Water Pump	679-44316-A0-00	1
NSS	Plate, Wear	676-44323-00-00	1
NSS	Bolt	97095-08055-00	2
NSS	Seal, Water	663-44366-00-00	1
NSS	Washer, Bolt	92990-08600-00	4

18-3398
WATER PUMP KIT
(with Housing)

Replaces: 6F5-W0078-A0-00, 6F5-W0078-00-00

— CONTAINS —



Part #	Description	O.E. #	Qty.
18-3088	Impeller	6F5-44352-00-00	1
18-0237	Gasket, Water Pump Outer	676-44315-A0-00	1
18-0256	Bolt	97095-08045-00	2
18-3300	Key, Impeller	90280-04M00-00	1
18-3334	Cup, Insert	676-44322-00-00	1
NSS	Gasket, Water Pump	676-44324-A0-00	1
NSS	Gasket, Water Pump	679-44316-A0-00	1
NSS	Plate, Wear	676-44323-00-00	1
NSS	Housing, Water Pump	676-44311-00-00	1
NSS	Bolt	97095-08055-00	2
NSS	Seal, Water	663-44366-00-00	1
NSS	Washer, Bolt	92990-08600-00	4

18-3428-1
WATER PUMP KIT

Without Housing

Replaces: 6H3-W0078-00-00, 6H3-W0078-A0-00

— CONTAINS —



Part #	Description	O.E. #	Qty.
18-0240	Gasket, Water Pump	688-44316-A0-00	1
18-0256	Bolt	97095-08045-00	2
18-0756-1	Gasket, Water Pump	6H3-44315-A0-00	1
18-0757	Gasket, Outer Plate	6H3-44324-A0-00	1
18-3069	Impeller	697-44352-00-00	1
18-3297	Key, Impeller	90280-03M03-00	1
18-3435	Cup, Impeller	663-44322-00-00	1
18-7436	O-Ring	93210-46044-00	1
NSS	Bolt	97095-08055-00	2
NSS	Plate, Wear	63D-44323-00-00	1

18-3461
WATER PUMP KIT
(with Housing)

Replaces: 6H3-W0078-00-00, A0-00, 6H3-44311-00-00

For: 70(1984-91), P60(1991), T50(1996)

— CONTAINS —



Part #	Description	O.E. #	Qty.
NSS	Housing, Water Pump	6H3-44311-00-00	1
18-0240	Gasket, Water Pump	688-44316-A0-00	1
18-0256	Bolt	97095-08045-00	2
18-0756-1	Gasket, Water Pump	6H3-44315-A0-00	1
18-0757	Gasket, Outer Plate	6H3-44324-A0-00	1
18-3069	Impeller	697-44352-00-00	1
18-3297	Key, Impeller	90280-03M03-00	1
18-3435	Cup, Impeller	663-44322-00-00	1
18-7436	O-Ring	93210-46044-00	1
NSS	Bolt	97395-08055-00	2
NSS	Plate, Wear	6H3-44323-00-00	1

18-3429
WATER PUMP KIT

Without Housing

Replaces: 6H4-W0078-00-00, 6H4-W0078-A0-00

— CONTAINS —



Part #	Description	O.E. #	Qty.
18-0256	Bolt	97095-08045-00	2
18-0258	Bolt	97095-08055-00	2
18-0292	Gasket, Wear Plate to Housing	663-44315-A0-00	1
18-0294	Gasket, Wear Plate to Base	663-44324-A0-00	1
18-3068	Impeller	6H4-44352-00-00	1
18-3297	Key, Impeller	90280-03M03-00	1
18-3435	Cup, Insert	663-44322-00-00	1
18-3436	Plate, Wear	663-44323-00-00	1
NSS	Gasket, Water Pump	663-44316-A0-00	1
NSS	Seal	93101-23070-00	1

18-3408
WATER PUMP KIT With Housing

Replaces: 6H4-W0078-00, A0, 663-44311-02

For: 40(1984-87), 50(1984-87), Pro50(1987)

— CONTAINS —



Part #	Description	O.E. #	Qty.
NSS	Housing, Water Pump	6J8-44311-00-00	1
18-0256	Bolt	97095-08045-00	2
18-0258	Bolt	97395-08055-00	2
18-0292	Gasket, Wear Plate to Housing	663-44315-A0-00	1
18-0294	Gasket, Wear Plate to Base	663-44324-A0-00	1
18-3068	Impeller	6H4-44352-00-00	1
18-3297	Key, Impeller	90280-03M03-00	1
18-3435	Cup, Insert	663-44322-00-00	1
18-3436	Plate, Wear	663-44323-00-00	1
NSS	Gasket, Water Pump	663-44316-00-00	1
NSS	Seal	93101-23070-00	1

18-3433
WATER PUMP KIT

Without Housing

Replaces: 63V-W0078-01-00

Fits: 9.9/15(1996-04), F15 (1998-04)

— CONTAINS —



Part #	Description	O.E. #	Qty.
18-0256	Bolt	97095-08045-00	4
18-3040	Impeller	63V-44352-01-00	1
18-3195	Plate, Wear	63V-44323-00-00	1
18-3294	Key, Impeller	63V-44338-00-00	1
18-3444	Cup, Insert	63V-44322-00-00	1
NSS	Seal, Water	647-44366-00-00	1

18-3412
WATER PUMP KIT
(with Housing)

Replaces: 63V-W0078-01, 63V-44301-00

For: 9.9(1996-09), 15(1996-09), F9.9(2005-06), F15(1998-05), T9.9(2005-06)

— CONTAINS —



Part #	Description	O.E. #	Qty.
18-0256	Bolt	97095-08045-00	4
18-3040	Impeller	63V-44352-01-00	1
18-3195	Plate, Wear	63V-44323-00-00	1
18-3294	Key, Impeller	63V-44338-00-00	1
18-3356	Housing, Water Pump	63V-44301-00-00	1
18-3444	Cup, Insert	63V-44322-00-00	1
NSS	Seal, Water	647-44366-00-00	1

18-3434
WATER PUMP KIT

Without Housing

Replaces: 63D-W0078-01-00, 63D-44311-00-00

Fits: 40/50(1995-03),P40(1998), C40 3 cyl(1997-02), C50(1999-01),F40 2.6L(1999), F50(1995-03), P50 (1995-96), F60(2002-03)

For kit with housing, order **18-3415**

— CONTAINS —

Part #	Desc.	O.E.#	Qty.
18-0483	Gasket, Pump Case	63D-44316-00-00	1
18-3069	Impeller	697-44352-00-00	1
18-3186	Plate, Wear	63D-44323-00-00	1
18-3297	Key, Impeller	90280-03M03-00	1
18-3449	Cup, Insert	63D-44322-00-00	1
18-8400-9	Bolt (Set of 4)	90119-08M15-00	1
NSS	Cover, Pump Housing	63D-44312-00-00	1
NSS	Washer, Bolt	90209-08M02-00	4
NSS	O-Ring	93210-59MG7-00	1
NSS	Seal, Water	663-44366-00-00	1

18-3415
WATER PUMP KIT
(with Housing)

Replaces: 63D-W0078-01-00, 63D-44311-00-00

Fits: 40/50(1995-03),P40(1998), C40 3 cyl(1997-02), C50(1999-01),F40 2.6L(1999), F50(1995-03), P50 (1995-96), F60(2002-03)

For kit w/o housing, order **18-3434**



Part #	Desc.	O.E.#	Qty.
18-0483	Gasket, Water Pump Case	63D-44316-00-00	1
18-3069	Impeller	697-44352-00-00	1
18-3186	Plate, Wear	63D-44323-00-00	1
18-3297	Key, Impeller	90280-03M03-00	1
18-3449	Cup, Insert	63D-44322-00-00	1
18-8400-9	Bolt (Set of 4)	90119-08M15-00	1
NSS	Cover, Water Pump Housing	63D-44312-00-00	1
NSS	Washer, Bolt	90209-08M02-00	4
NSS	O-Ring	93210-59MG7-00	1
NSS	Seal, Water	663-44366-00-00	1
NSS	Housing, Water Pump	63D-44311-00-00	1

18-3440
WATER PUMP KIT

Without Housing

Replaces: 66T-W0078-00-00

Fits: T25 (2001-04), F30 (2001-04), F40 (2000-04)

— CONTAINS —

Part #	Desc.	O.E.#	Qty.
18-0483	Gasket, Pump Case	63D-44316-00-00	1
18-3068	Impeller	6H4-44352-00-00	1
18-3196	Plate, Impeller	66T-44323-00-00	1
18-3297	Key, Impeller	90280-03M03-00	1
18-3449	Cup, Insert	63D-44322-00-00	1
18-8400-9	Bolt (Set of 4)	90119-08M15-00	1
NSS	Cover, Pump Housing	63D-44312-00-00	1
NSS	O-Ring	93210-59MG7-00	1
NSS	Seal, Water	663-44366-00-00	1
NSS	Washer	90209-08M02-00	4

18-3413
WATER PUMP KIT
(with Housing)

Replaces: 66T-W0078-00, 66T-44311-00

For: F30(2001-05), F40(2000-08), T25 (2001-06)

For kit w/o housing, order **18-3440**



Part #	Desc.	O.E.#	Qty.
18-0483	Gasket, Water Pump Case	63D-44316-00-00	1
18-3068	Impeller	6H4-44352-00-00	1
18-3196	Plate, Wear	66T-44323-00-00	1
18-3297	Key, Impeller	90280-03M03-00	1
18-3449	Cup, Insert	63D-44322-00-00	1
18-8400-9	Bolt (Set of 4)	90119-08M15-00	1
NSS	Cover, Water Pump Housing	63D-44312-00-00	1
NSS	O-Ring	93210-59MG7-00	1
NSS	Seal, Water	663-44366-00-00	1
NSS	Washer, Bolt	90209-08M02-00	4
NSS	Housing, Water Pump	66T-44311-00-00	1

18-3442
WATER PUMP REPAIR KIT

Without Housing

Replaces: 68V-W0078-00-00

For: F115 2002-2010 / LF115 2002-2010

— CONTAINS —

Part #	Desc.	O.E.#	Qty.
18-0244	Gasket, Water Pump	6E5-44315-A0-00	2
18-0256	Bolt	97095-08045-00	4
18-3071	Impeller	6E5-44352-01-00	1
18-3302	Key, Impeller	90280-04M05-00	1
18-3519	Cup, Insert	61A-44322-02-00	1
18-3521	Plate, Wear	68V-44323-00-00	1
18-7483	O-Ring (6G8)	93210-37M67-00	1
18-7485	O-Ring	93210-86M38-00	1
NSS	Pin, Dowel	93606-12019-00	2
NSS	Washer	90209-08M02-00	4

18-3523-1
WATER PUMP KIT
(with Housing)

Replaces: 68V-W0078-00, 61A-44311-01

Fits: F115 & LF115 (2002 & Up)



Part #	Desc.	O.E.#	Qty.
18-0244	Gasket, Water Pump	6E5-44315-A0-00	2
18-0256	Bolt	97095-08045-00	4
18-3071	Impeller	6E5-44352-01-00	1
18-3173-1	Housing, Water Pump	61A-44311-01-00	1
18-3302	Key, Impeller	90280-04M05-00	1
18-3519	Cup, Insert	61A-44322-02-00	1
18-3521	Plate, Wear	68V-44323-00-00	1
18-7483	O-Ring (6G8)	93210-37M67-00	1
18-7485	O-Ring	93210-86M38-00	1
NSS	Pin, Dowel	93606-12019-00	2
NSS	Washer, Bolt	90209-08M02-00	4

18-3450
WATER PUMP KIT

Without Housing

Replaces: 68T-W0078-00-00

For: F6, F8 (2001-05)

— CONTAINS —

Part #	Desc.	O.E.#	Qty.
18-0256	Bolt	97095-08045-00	4
18-3142	Plate, Wear	68T-44323-00-00	1
18-3176	Seal, Water Damper	68T-44366-00-00	1
18-3294	Key, Impeller	63V-44338-00-00	1
18-3444	Cup, Insert	63V-44322-00-00	1
18-8910	Impeller	68T-44352-00-00	1
NSS	O-Ring	93210-44398-00	1

18-3410
WATER PUMP KIT (with Housing)

Replaces: 68T-W0078-00, 63V-44301-00

For: F6(01-08), F8(01-09), F9.9(07-09)



Part #	Desc.	O.E.#	Qty.
18-0256	Bolt	97095-08045-00	4
18-3142	Plate, Wear	68T-44323-00-00	1
18-3176	Seal, Water Damper	68T-44366-00-00	1
18-3294	Key, Impeller	63V-44338-00-00	1
18-3356	Housing, Water Pump	63V-44301-00-00	1
18-3444	Cup, Insert	63V-44322-00-00	1
18-8910	Impeller	68T-44352-00-00	1
NSS	O-Ring	93210-44398-00	1

18-3451
WATER PUMP KIT

Replaces: 67F-W0078-00-00
Fits: F75 (2003-06), F80(1999-03), F90(2003-04), F100(1999-02)



— CONTAINS —

Part #	Desc.	O.E.#	Qty.
18-2605	Bolt	90119-08M87-00	2
18-2606	Bolt	90119-08M13-00	2
18-3042	Impeller	67F-44352-00-00	1
18-3143	Plate, Wear	67F-44323-00-00	1
18-3162	Cup, Insert	67F-44322-00-00	1
18-3301	Key, Impeller	90280-04M04-00	1
18-7436	O-Ring	93210-46044-00	1
NSS	Gasket, Water Pump	688-44315-A0-00	1
NSS	Gasket, Water Pump	688-44324-A0-00	1
NSS	Gasket, Water Pump	688-44316-A0-00	1
NSS	Washer, Bolt	90209-08M02-00	4

18-3409
WATER PUMP KIT (with Housing)

Replaces: 67F-W0078-00, 67F-44311-01
For: F75(2006-10), F80(1999-03), F90(2006-10), F100(1999-03)



— CONTAINS —

Part #	Desc.	O.E.#	Qty.
18-2605	Bolt	90119-08M87-00	2
18-2606	Bolt	90119-08M13-00	2
18-3042	Impeller	67F-44352-00-00	1
18-3143	Plate, Wear	67F-44323-00-00	1
18-3162	Cup, Insert	67F-44322-00-00	1
18-3301	Key, Impeller	90280-04M04-00	1
18-7436	O-Ring	93210-46044-00	1
NSS	Gasket, Water Pump	688-44315-A0-00	1
NSS	Gasket, Water Pump	688-44324-A0-00	1
NSS	Gasket, Water Pump	688-44316-A0-00	1
NSS	Housing, Water Pump	67F-44311-01-00	1
NSS	Washer, Bolt	90209-08M02-00	4

18-3465
WATER PUMP KIT

Without Housing
Replaces: 6H3-W0078-02-00
Fits: T50(1997-05), 60(2001-03), C60(1997-01), C70(2000-01), P60(1997-99), T60(2003-05), 70(1997-03)

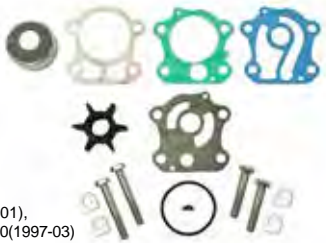

— CONTAINS —

Part #	Desc.	O.E.#	Qty.
18-3069	Impeller	697-44352-00-00	1
18-0256	Bolt	97095-08045-00	2
18-0757	Gasket, Water Pump	6H3-44324-A0-00	1
18-3297	Key, Impeller	90280-03M03-00	1
18-3435	Cup, Insert	663-44322-00-00	1
18-7436	O-Ring	93210-46044-00	1
NSS	Plate, Wear	6H3-44323-00-00	1
NSS	Gasket, Water Pump	6H3-44315-A0-00	1
NSS	Gasket, Water Pump	6H3-44324-A0-00	1
NSS	Bolt	97095-08055-00	2
NSS	Washer, Bolt	90209-08M02-00	4

18-3466
WATER PUMP KIT (with Housing)

Replaces: 6H3-W0078-01, 6H3-44311-00
For: 70(1992-03), C60(1996-01), E60(1995-96), P60(1992-99), C70(2000-01), T50(1997-10), T60(2003-10)



— CONTAINS —

Part #	Desc.	O.E.#	Qty.
NSS	Housing, Water Pump	6H3-44311-00-00	1
18-0256	Bolt	97095-08045-00	2
18-0757	Gasket, Water Pump	6H3-44324-A0-00	1
18-3069	Impeller	697-44352-00-00	1
18-3297	Key, Impeller	90280-03M03-00	1
18-3435	Cup, Insert	663-44322-00-00	1
18-7436	O-Ring	93210-46044-00	1
NSS	Plate, Wear	6H3-44323-00-00	1
NSS	Gasket, Water Pump	6H3-44315-A0-00	1
NSS	Gasket, Water Pump	688-44316-A0-00	1
NSS	Bolt	97095-08055-00	2
NSS	Washer, Bolt	90209-08M02-00	4

18-3470
WATER PUMP REPAIR KIT

Without Housing
Replaces: 6CE-W0078-01
Fits: F225 (2010-15), F250 (2010), F250 (2010-15), F300 (2007-15), F350 (2007-15), FL250 (2010), FL300 (2010), FL350 (2010), LF225 (2010-15), LF250 (2010-15), LF300 (2007-15), LF350 (2007-15), VF250 (2015)



— CONTAINS —

Part #	Desc.	O.E.#	Qty.
18-7471	O-Ring, Outer	93210-94003-00	1
18-0256	Bolt	97095-08045-00	4
18-2091	Seal, Oil	93104-22M07-00	2
18-3302	Key, Impeller	90280-04M05-00	1
18-3457	Cup, Insert	6AW-44322-00-00	1
18-3458	Gasket, Water Pump	6CE-44315-00-00	1
18-3459	Plate, Wear	6CE-44323-01-00	1
18-45617-1	Impeller	6CE-44352-00-00	1
18-7483	O-Ring (6G8)	93210-37M67-00	1
NSS	Washer, Bolt	90209-08M02-00	4
NSS	Pin, Dowell	93606-12019-00	2

18-3471
WATER PUMP REPAIR KIT (with Housing)

Replaces: 6CE-W0078-01 + 6CE-44311-01
Fits: F225 (2010-15), F250 (2010), F250 (2010-15), F300 (2007-15), F350 (2007-15), FL250 (2010), FL300 (2010), FL350 (2010), LF225 (2010-15), LF250 (2010-15), LF300 (2007-15), LF350 (2007-15), VF250 (2015)



— CONTAINS —

Part #	Desc.	O.E.#	Qty.
18-7471	O-Ring, Outer	93210-94003-00	1
18-0256	Bolt	97095-08045-00	4
18-2091	Seal, Oil	93104-22M07-00	2
18-3302	Key, Impeller	90280-04M05-00	1
18-3457	Cup, Insert	6AW-44322-00-00	1
18-3458	Gasket, Water Pump	6CE-44315-00-00	1
18-3459	Plate, Wear	6CE-44323-01-00	1
18-3482	Housing, Water Pump	6CE-44311-01-00	1
18-45617-1	Impeller	6CE-44352-00-00	1
18-7483	O-Ring (6G8)	93210-37M67-00	1
NSS	Washer, Bolt	90209-08M02-00	4
NSS	Pin, Dowel	93606-12019-00	2

18-3516
WATER PUMP REPAIR KIT

Without Housing
Replaces: 60X-W0078-00-00
For: VZ200 (3.3L) 2005-2010, VZ225 (3.3L) 2003-2010, VZ250 (3.3L) 2003-2010, VZ300 (3.3L) 2005-2010

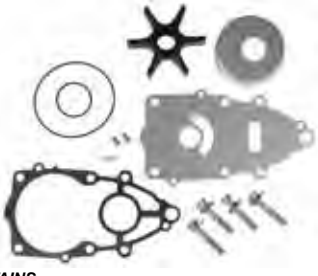

— CONTAINS —

Part #	Desc.	O.E.#	Qty.
18-0256	Bolt	97095-08045-00	4
18-3071	Impeller	6E5-44352-01-00	1
18-3302	Key, Impeller	90280-04M05-00	1
18-3519	Cup, Insert	61A-44322-02-00	1
18-3520	Plate, Wear	60X-44323-00-00	1
18-7483	O-Ring (6G8)	93210-37M67-00	1
18-7485	O-Ring	93210-86M38-00	1
18-0406	Gasket, Water Pump	60X-44315-A0-00	1
NSS	Pin, Dowel	93606-12019-00	2
NSS	Washer, Bolt	90209-08M02-00	4

18-3522-1
WATER PUMP KIT (with Housing)

Replaces: 60X-W0078-00, 61A-44311-01
For: VZ200(2005-09), VZ225(2003-09), VZ250(2003-09), VZ300(2004-09)



— CONTAINS —

Part #	Desc.	O.E.#	Qty.
18-0256	Bolt	97095-08045-00	4
18-3071	Impeller	6E5-44352-01-00	1
18-3173-1	Housing, Water Pump	6E5-44311-00-00	1
18-3302	Key, Impeller	90280-04M05-00	1
18-3519	Cup, Insert	61A-44322-02-00	1
18-3520	Plate, Wear	60X-44323-00-00	1
18-7483	O-Ring (6G8)	93210-37M67-00	1
18-7485	O-Ring, Outer	93210-86M38-00	1
NSS	Gasket, Water Pump	60X-44315-A0-00	1
NSS	Pin, Dowel	93606-12019-00	2
NSS	Washer, Bolt	90209-08M02-00	4

**18-3425
WATER PUMP KIT**

Without Housing

Replaces: 663-W0078-00-00, 663-W0078-A0-00



— CONTAINS —

Part #	Description	O.E. #	Qty.
18-0256	Bolt	97095-08045-00	2
18-0292	Gasket, Water Pump	663-44315-00-00	1
18-0294	Gasket, Water Pump	663-44324-A0-00	1
18-3069	Impeller	697-44352-00-00	1
18-3297	Key, Impeller	90280-03M03-00	1
18-3435	Cup, Insert	663-44322-00-00	1
18-3436	Plate, Wear	663-44323-00-00	1
NSS	Bolt	97095-08055-00	2
NSS	Seal, Water	663-44366-00-00	1

**18-3430
WATER PUMP REPAIR KIT**

Without Housing

Replaces: 6J8-W0078-A1-00



— CONTAINS —

Part #	Description	O.E. #	Qty.
18-0294	Gasket, Water Pump	663-44324-A0-00	1
18-3068	Impeller	6H4-44352-00-00	1
18-3435	Cup, Insert	663-44322-00-00	1
18-3436	Plate, Wear	663-44323-00-00	1
NSS	Gasket, Water Pump	663-44315-A0-00	1
NSS	Gasket, Water Pump	663-44324-A0-00	1
NSS	Bolt	97395-08050-00	2
NSS	Bolt	97395-08040-00	2
NSS	Washer, Bolt	90209-08M02-00	4

**18-3431
WATER PUMP KIT**

Without Housing

Replaces: 6L2-W0078-00-00



— CONTAINS —

Part #	Description	O.E. #	Qty.
NSS	Cup, Insert	6L2-44322-00-00	1
18-2607	Bolt	97095-06040-00	4
18-3065	Impeller	6L2-44352-00-00	1
18-7483	O-Ring (6G8)	93210-37M67-00	1
NSS	Plate, Wear	6L2-44323-00-00	1

**18-3460
WATER PUMP KIT**

Replaces: 6N0-W0078-A0-00, 6G1-W0078-A1-00, 6G1-W0078-01-00
Fits: 6(1986-00), 8(1984-05)



— CONTAINS —

Part #	Desc.	O.E.#	Qty.
18-0753	Gasket, Water Pump	6G1-44315-A0-00	1
18-3066	Impeller	6G1-44352-00-00	1
18-3456	Cup, Insert	6G1-44322-00-00	1
NSS	Plate, Wear	6G1-44323-00-00	1
NSS	Plate, Bolt	6G1-44328-00-00	2
NSS	Bolt	97095-06045-00	4
NSS	Seal, Water	647-44366-00-00	1

**18-3462
WATER PUMP KIT**

Replaces: 6A1-W0078-02-00
Fits: 2(1988-02)



— CONTAINS —

Part #	Desc.	O.E.#	Qty.
18-1079	Protector, Oil Seal	6A1-44325-00-00	1
18-3072	Impeller	646-44352-01-00	1
18-3328	Cup, Insert	646-44322-00-00	1
18-3357	Plate, Wear	646-44323-00-00	1
18-7463	O-Ring	93210-19123-00	1
NSS	Seal, Water	646-44366-01-00	1
NSS	Seal, Oil	93101-11M44-00	2
NSS	Pin, Dowel	93604-09068-00	2
NSS	Bolt	97095-05016-00	2

**18-3463
WATER PUMP KIT**

Replaces: 6A1-W0078-01-00
Fits: 2(1984-87)



— CONTAINS —

Part #	Desc.	O.E.#	Qty.
18-1079	Protector, Oil Seal	6A1-44325-00-00	1
18-3328	Impeller	646-44322-00-00	1
18-3328	Cup, Insert	646-44322-00-00	1
18-3357	Plate, Wear	646-44323-00-00	1
18-7463	O-Ring	93210-19123-00	1
NSS	Seal, Water	646-44366-01-00	1
NSS	Seal, Oil	93103-11051-00	1
NSS	Pin, Dowel	93604-09068-00	2
NSS	Bolt	97095-05016-00	2

**18-3515
WATER PUMP REPAIR KIT**

Replaces: 6P2-W0078-00-00
For: F225 Produced after 04/2007 /
F250 Produced after 4/2006

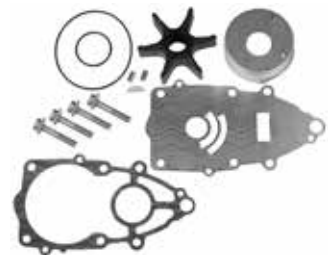

— CONTAINS —

Part #	Desc.	O.E.#	Qty.
18-0256	Bolt	97095-08045-00	4
18-0406	Gasket, Water Pump	60X-44315-A0-00	1
18-3071	Impeller	6E5-44352-01-00	1
18-3302	Key, Impeller	90280-04M05-00	1
18-3518	Plate, Wear	6P2-44323-00-00	1
18-3519	Cup, Insert	61A-44322-02-00	1
18-7483	O-Ring (6G8)	93210-37M67-00	1
18-7485	O-Ring	93210-86M38-00	1
NSS	Pin, Dowel	93606-12019-00	2
NSS	Washer, Bolt	90209-08M02-00	4

**18-3426
WATER PUMP KIT**

With Housing

Replaces: 689-W0078-04-00, 689-W0078-A4-00



— CONTAINS —

Part #	Description	O.E. #	Qty.
18-3067	Impeller	689-44352-02-00	1
18-3294	Key, Impeller	63V-44338-00-00	1
NSS	Housing, Water Pump	689-44311-03-00	1
NSS	Gasket, Water Pump	689-44324-A0-00	1
NSS	Cup, Insert	689-W4432-02-00	1
NSS	Plate, Wear	689-44323-03-00	1
NSS	Washer, Bolt	90209-06M04-00	3
NSS	Bolt	90101-06M56-00	3
NSS	Grommet	689-44366-00-00	1
NSS	Gasket, Seal Cover	689-44315-01-00	1

18-3432
WATER PUMP KIT

Replaces: 61N-W0078-11-00
Fits: F25(1998-05)



— CONTAINS —

Part #	Desc.	O.E.#	Qty.
18-0191	Plate, Washer	92990-06600-00	4
18-2607	Bolt	97095-06040-00	4
18-3068	Impeller	6H4-44352-00-00	1
18-3185	Housing, Water Pump	61N-44311-01-00	1
18-3194	Plate, Wear	61N-44323-00-00	1
18-3297	Key, Impeller	90280-03M03-00	1
18-3443	Cup, Insert	61N-44322-01-00	1
18-7115	O-Ring	93210-45161-00	1
NSS	Seal, Water	6L2-44367-00-00	1

18-3427
WATER PUMP KIT
With Housing

Replaces: 689-W0078-A6-00



— CONTAINS —

Part #	Description	O.E. #	Qty.
18-3067	Impeller	689-44352-02-00	1
18-3294	Key, Impeller	63V-44338-00-00	1
NSS	Gasket, Water Pump	689-44316-A0-00	1
NSS	Plate, Wear	689-44323-03-00	1
NSS	Gasket, Water Pump	689-44324-A0-00	1
NSS	Cup, Insert	689-44352-02-00	1
NSS	Housing, Water Pump	689-44311-03-00	1
NSS	Washer, Bolt	90209-06M04-00	3
NSS	Bolt	90101-06M56-00	3
NSS	Grommet	689-44366-00-00	1

18-48619
COMPLETE
WATER PUMP KIT

Replaces: 68D-WG078-00-00
Fits: Yamaha F4(2002-08)



— CONTAINS —

Part #	Desc.	O.E.#	Qty.
18-43263	Housing, Water Pump	68D-G4311-01-00	1
18-3073	Impeller	6E0-44352-00-00	1
18-43531	Cup, Insert	6E0-44322-02-00	1
18-43716	Pin, Impeller	93604-18080-00	1
18-43818	Bolt	97095-06045-00	4
18-60541	Gasket, Water Pump	6BX-G4315-01-00	1
NSS	Plate, Wear	6E0-44323-00-00	1
NSS	Tube, Rubber	67D-44366-00-00	1
NSS	Washer, Bolt	N/A	4
NSS	Plate, Bolt	68D-G4328-00-00	2

new

18-3473
WATER PUMP KIT
With Housing

Replaces: 6EE-W0078-00-00
Fits: F4 (2009-17), F6 (2009-17)



— CONTAINS —

Part #	Description	O.E. #	Qty.
18-3073	Impeller	6E0-44352-00	1
18-4567	Housing, Water Pump	6EE-G4311-00	1
18-60541	Gasket, Water Pump	6EE-G4315-00	1
18-4546	Cup, Insert	6EE-G4322-00	1
18-4573	Plate, Wear	6EE-G4323-00	1
18-1840	Damper, Water Seal 2	6EE-G4366-00	1
18-43716	Pin, Dowel (647)	93604-18080	2
18-0261	Bolt	97080-06045	4

new

18-3474
WATER PUMP KIT
Without Housing

Replaces: 6CB-W0078-00-00
Fits: VF225, VF250 (2009-18)



— CONTAINS —

Part #	Description	O.E. #	Qty.
18-3519	Cup, Insert	61A-44322-02	1
18-0451	Gasket, Water Pump	6CV-44315-00	1
18-4572	Plate, Wear	6CV-44323-00	1
18-3071	Impeller	6E5-44352-01	1
NSS	Bolt, With Washer	90119-08M14	4
18-3302	Key, Woodruff	90280-04002	1
18-7483	O-Ring (6G8)	93210-37M67	1
18-7485	O-Ring (6E5)	93210-86M38	1
NSS	Pin, Dowel (614)	93606-12019	2

new

18-3475
WATER PUMP KIT
Without Housing

Replaces: 69G-W0078-00
Fits: T9.9 (2007-17)



— CONTAINS —

Part #	Description	O.E. #	Qty.
18-3444	Cup, Insert	63V-44322-00	1
18-3040	Impeller	63V-44352-01	1
18-3294	Key, Woodruff	664-44338-00	1
18-3142	Plate, Wear	68T-44323-00	1
18-3176	Damper, Water Seal 2	68T-44366-00	1
18-71331	O-Ring (55X)	93210-44704	1
18-0256	Bolt	97095-08045	4

new

18-3477
WATER PUMP KIT
Without Housing

Replaces: 6AW-W0078-00-00
Fits: F300, LF300 (2007-09)



— CONTAINS —

Part #	Description	O.E. #	Qty.
18-0452	Gasket, Water Pump	6AW-44315-00	1
18-3457	Cup, Insert	6AW-44322-00	1
18-0421	Plate, Wear	6AW-44323-00	1
18-3028	Key, Impeller	6AW-44336-00	1
18-8925	Impeller	6AW-44352-00	1
NSS	Bolt, With Washer	90119-08M14	4
18-7483	O-Ring (6G8)	93210-37M67	1
18-7471	O-Ring (6G8)	93210-94003	1
NSS	Pin, Dowel (614)	93606-12019	2

new

18-3479
WATER PUMP KIT
With Housing

Replaces: 6AH-W0078-00
Fits: F15C, F20 (2006-17)



— CONTAINS —

Part #	Description	O.E. #	Qty.
18-3444	Cup, Insert	63V-44322-00	1
18-9090	Plate	63V-44328-01	2
18-3040	Impeller	63V-44352-01	1
18-3294	Key, Woodruff	664-44338-00	1
18-3142	Plate, Wear	68T-44323-00	1
NSS	Housing, Water Pump	6AH-44311-00	1
18-1836	Damper, Water Seal	6L2-44367-00	1
18-71333	O-Ring (620)	93210-49046	1
18-43717	Pin, Dowel (688)	93604-10M03	2
18-0256	Bolt, Hexagon	97095-08045	4

New



**18-3490
WATER PUMP KIT
Without Housing**
Replaces: 6BG-W0078-00-00
Fits: F30 (2013-17), F40A (2008-17)

— CONTAINS —

Part #	Description	O.E. #	Qty.
18-9083	Cover, Water Pump Housing	63D-44312-00	1
18-0483	Gasket, Water Pump	63D-44316-00	1
18-3449	Cup, Insert	63D-44322-00	1
18-3186	Plate, Wear	63D-44323-00	1
18-1828	Seal, Water Damper 2	663-44366-00	1
18-3068	Impeller	6H4-44352-02	1
18-8400-9	Bolt, With Washer	90119-08M15	4
18-3297	Key, Woodruff	90280-03M03	1
18-71334	O-Ring	93210-59MG7	1

New



**18-3494
WATER PUMP KIT
Without Housing**
Replaces: 6CJ-W0078-00-00
Fits: F70A (2010-17)

— CONTAINS —

Part #	Description	O.E. #	Qty.
18-9083	Cover, Water pump Housing	63D-44312-00	1
18-3449	Cup, Insert	63D-44322-00	1
18-1830	Seal, Water Damper 2	663-44366-00	1
18-0448	Gasket, Water Pump	6CJ-44315-00	1
18-0449	Gasket, Water Pump	6CJ-44316-00	1
18-3186	Plate, Wear	6CJ-44323-00	1
18-0450	Gasket, Water Pump	6CJ-44324-00	1
18-3069	Impeller	6H3-44352-00	1
NSS	Bolt, With Washer	90119-08M14	2
18-0260	Bolt, With Washer	90119-08M33	2
18-3297	Key, Woodruff (697)	90280-03M03	1
18-0297	Oil Seal (663)	93101-23070	2
18-7436	O-Ring	93210-46044	1
18-43717	Pin, Dowel (688)	93604-10M03	2

New



**18-4527
WATER PUMP KIT
With Housing**
Replaces: 6FM-W0078-00-00
Fits: F25C (2016-17)

— CONTAINS —

Part #	Description	O.E. #	Qty.
18-4576	Plate, Wear	6FM-44323-01	1
18-3486	Housing, Water Pump	6L2-44311-01	1
18-4548	Cup, Insert	6L2-44322-00	1
18-9092	Plate	6L2-44328-00	2
18-3065	Impeller	6L2-44352-00	1
18-1837	Seal, Water Damper 3	6L2-44367-10	1
18-3305	Key, Woodruff (662)	90280-03024	1
18-71332	O-Ring	93210-45161	1
18-43717	Pin, Dowel (688)	93604-10M03	2
18-8407	Bolt, With Washer	97595-06540	4

New



**18-4532
WATER PUMP KIT
Without Housing**
Replaces: 6EG-W0078-00-00
Fits: F2.5 (2015-17)

— CONTAINS —

Part #	Description	O.E. #	Qty.
18-1840	Seal, Water Damper 2	6EE-G4366-00	1
18-99157	Gasket, Water Pump	6EG-G4315-00	1
18-4547	Cup, Insert	6EG-G4322-00	1
18-4574	Plate, Wear	6EG-G4323-00	1
18-9089	Plate	6EG-G4328-00	2
18-8911	Impeller	6L5-44352-00	1
18-43717	Pin, Dowel (688)	93604-10M03	2
18-8406	Bolt W/ Washer	97595-06535	4

New



**18-4533
WATER PUMP KIT
Without Housing**
Replaces: 65N-W0078-A0-00
Fits: B115 (1998-99), D150 (1997-98), DX150 (1999-05)

— CONTAINS —

Part #	Description	O.E. #	Qty.
18-3519	Cup, Insert	61A-44322-02	1
18-0453	Gasket, Water Pump	65N-44315-A0	1
18-0408	Plate, Wear	65N-44323-00	1
18-3071	Impeller	6E5-44352-01	1
NSS	Bolt, With Washer	90119-08M14	4
18-3302	Key, Woodruff (6E5)	90280-04M05	1
18-7483	O-Ring (6G8)	93210-37M67	1
18-7485	O-Ring (6E5)	93210-86M38	1
NSS	Pin, Dowel (614)	93606-12019	2

New



**18-4534
WATER PUMP KIT
Without Housing**
Replaces: 69M-WG078-00-00
Fits: F2.5 (2003-15)

— CONTAINS —

Part #	Description	O.E. #	Qty.
18-3166	Seal, Water Damper 2	6E0-44366-00	1
18-7119	O-Ring	93210-33M85	1
18-3164	Cup, Insert	6L5-44322-00	1
18-8911	Impeller	6L5-44352-00	1
18-0409	Plate, Wear	69M-G4323-00	1
18-43716	Pin, Dowel	93604-18080	2
18-71330	O-Ring	93210-05001	1
18-2607	Bolt	97095-06040	4
18-9091	Plate	69M-G4328-00	1

YAMAHA 4-STROKE WATER PUMP APPLICATION CHART

HP Model	Year	Impeller	Cup	Plate	Housing	Damper Seal	Water Pump Cover	Kit without Housing	Kit with Housing
F2.5	2003-15	18-8911	-	18-0409	-	18-3166	-	18-4534	-
F2.5	2016-18	18-8911	18-4547	18-4574	-	18-1840	-	18-4532	-
4	1984-99	18-3073	-	-	-	-	-	-	-
F4	1999-13	18-3073	-	-	-	-	-	-	-
F4	2014-18	18-3073	18-4546	18-4573	18-4567	18-1840	-	18-3473	-
F6	2001-08	18-8910	18-3444	18-3142	18-3356	18-3176	-	18-3450	18-3410
F6	2009-17	18-3073	18-4546	18-4573	18-4567	-	-	18-3473	-
F8	2001-17	18-8910	18-3444	18-3142	18-3356	18-3176	-	18-3450	18-3410
T8	2001-10	18-3040	18-3444	18-3142	18-3356	18-3176	-	18-3450	18-3410
F9.9	1985-05	18-3074	-	-	-	18-1834	-	18-3148	18-3411
F9.9	2005-06	18-3040	18-3444	18-3195	18-3356	18-1833	-	18-3433	18-3412
F9.9	2007-17	18-8910	18-3444	18-3142	18-3356	18-3176	-	18-3450	18-3410

YAMAHA 4-STROKE WATER PUMP APPLICATION CHART

HP Model	Year	Impeller	Cup	Plate	Housing	Damper Seal	Water Pump Cover	Kit without Housing	Kit with Housing
FT9.9	1985-90	18-3074	-	-	-	18-1834	-	18-3148	18-3411
T9.9	1985-05	18-3074	-	-	-	18-1834	-	18-3148	18-3411
T9.9	2005-06	18-3040	18-3444	18-3195	18-3356	18-1833	-	18-3433	18-3412
T9.9	2007-17	18-3040	18-3444	18-3142	18-3356	18-3176	-	18-3475	-
F15	1998-06	18-3040	18-3444	18-3195	18-3356	18-1833	-	18-3433	18-3412
F15C	2006-18	18-3040	18-3444	18-3142	18-3484	18-1836	-	18-3479	-
F20	2006-18	18-3040	18-3444	18-3142	18-3484	18-1836	-	18-3479	-
F25	1998-05	18-3068	18-3443	18-3194	18-3185	-	-	-	18-3432
F25A	2009-17	18-3068	18-3443	18-3194	18-3185	-	-	-	18-3432
F25B	2012-17	18-3068	18-3443	18-3194	18-3185	-	-	-	18-3432
F25C	2016-17	18-3065	18-4548	18-4576	18-3486	18-1837	-	18-4527	-
T25	2001-06, 2009-17	18-3068	18-3449	18-3196	-	-	-	18-3440	18-3413
F30	2001-05	18-3068	18-3449	18-3196	-	-	-	18-3440	18-3413
F30	2013-17	18-3068	18-3449	18-3186	18-3413	18-1828	18-9083	18-3490	-
F40	1999	18-3069	18-3449	18-3186	-	-	-	18-3434	18-3415
F40	2000-06	18-3068	18-3449	18-3196	-	-	-	18-3440	18-3413
F40A	2008-17	18-3068	18-3449	18-3186	18-3413	18-1828	18-9083	18-3490	-
F40B	2007-08	18-3068	18-3449	18-3196	-	-	-	18-3440	18-3413
F50	1995-17	18-3069	18-3449	18-3186	-	-	-	18-3434	18-3415
F50	1996	18-3069	18-3435	-	-	-	-	18-3428-1	18-3461
F50	1997	18-3069	18-3435	-	-	-	-	18-3465	18-3466
T50	1996	18-3069	18-3435	-	-	-	-	18-3428-1	18-3461
T50	1997-17	18-3069	18-3435	-	-	-	-	18-3465	18-3466
F60	2002-17	18-3069	18-3449	18-3186	-	-	-	18-3434	18-3415
T60	2003-17	18-3069	18-3435	-	-	-	-	18-3465	18-3466
F70A	2010-17	18-3069	18-3449	-	18-3485	-	-	18-3494	-
F75A	2003-17	18-3042	18-3162	18-3143	-	18-1830	-	18-3451	18-3409
F75B	2017	18-3071	18-3519	18-3521	18-3173-1	18-1835	18-9081	18-3442	18-3523-1
F80	1999-03	18-3042	18-3162	18-3143	-	18-1830	-	18-3451	18-3409
F90	2003-11	18-3042	18-3162	18-3143	-	18-1830	-	18-3451	18-3409
F90A	2012-17	18-3042	18-3162	18-3143	-	18-1830	-	18-3451	18-3409
F90B	2016-17	18-3071	18-3519	18-3521	18-3173-1	18-1835	18-9081	18-3442	18-3523-1
VF90A	2018	18-3071	18-3519	18-3521	18-3173-1	18-1835	18-9081	18-3442	18-3523-1
F100	1999-03	18-3042	18-3162	18-3143	-	18-1830	-	18-3451	18-3409
F115/LF115	2000-01	18-3071	18-3333	18-3344	18-3173-1	18-1835	18-9081	-	18-3313-1
F115/LF115	2002-17	18-3071	18-3519	18-3521	18-3173-1	18-1835	18-9081	18-3442	18-3523-1
VF115	2015-17	18-3071	18-3519	18-3521	18-3173-1	18-1835	18-9081	18-3442	18-3523-1
F150 / LF150	2004-11	18-3071	18-3519	18-3345	18-3173-1	18-1835	18-9081	18-3395	18-3396-1
F150A / LF150A	2012-14	18-3071	18-3519	18-3345	18-3173-1	18-1835	18-9081	18-3395	18-3396-1
F150B / LF150B	2015-18	18-3071	18-3519	18-3345	18-3173-1	18-1835	18-9081	18-3395	18-3396-1
F150C / LF150C	2017	18-3071	18-3519	18-3345	18-3173-1	18-1835	18-9081	18-3395	18-3396-1
VF150	2013-17	18-3071	18-3519	18-3345	18-3173-1	18-1835	18-9081	18-3395	18-3396-1
VF150A	2018	18-3071	18-3519	18-3345	18-3173-1	18-1835	18-9081	18-3395	18-3396-1
F175A	2014-18	18-3071	18-3519	18-3345	18-3173-1	18-1835	18-9081	18-3395	18-3396-1
F175 / LF175C	2017	18-3071	18-3519	18-3345	18-3173-1	18-1835	18-9081	18-3395	18-3396-1
VF175	2015-18	18-3071	18-3519	18-3345	18-3173-1	18-1835	18-9081	18-3395	18-3396-1
F200/LF200	2002-10	18-3071	18-3519	18-3345	18-3173-1	18-1835	18-9081	18-3395	18-3396-1
F200A/LF200A	2010-17	18-3071	18-3519	18-3345	18-3173-1	18-1835	18-9081	18-3395	18-3396-1
F200B/LF200B	2012-18	18-3071	18-3519	18-3345	18-3173-1	18-1835	18-9081	18-3395	18-3396-1
F200C/LF200C	2013-18	18-3071	18-3519	18-3345	18-3173-1	18-1835	18-9081	18-3395	18-3396-1
VF200	2009-18	18-3071	18-3519	-	18-3173-1	18-1835	18-9081	-	-
F225 / LF225	2002-10	18-3071	18-3519	18-3345	18-3173-1	18-1835	18-9081	18-3395	18-3396-1
F225 / LF225	2007-09	18-3071	18-3519	18-3518	18-3173-1	18-1835	18-9081	18-3515	-
F225A/LF225A (3.3L)	2011-17	18-3071	18-3519	18-3345	18-3173-1	18-1835	18-9081	18-3395	18-3396-1
F225A/LF225A (4.2L)	2010-17	18-45617-1	18-3457	18-3459	18-3482	18-1829	18-9082	18-3470	18-3471
F225B/LF225B (4.2L)	2016-17	18-45617-1	18-3457	18-3459	18-3482	18-1829	18-9082	18-3470	18-3471
F225B/LF225B (3.3L)	2016-17	18-3071	18-3519	18-3345	18-3173-1	18-1835	18-9081	18-3395	18-3396-1

CHART CONTINUED ON NEXT PAGE

YAMAHA 4-STROKE WATER PUMP APPLICATION CHART

HP Model	Year	Impeller	Cup	Plate	Housing	Damper Seal	Water Pump Cover	Kit without Housing	Kit with Housing
VF225 (4.2L)	2009-18	18-3071	18-3519	-	18-3173-1	18-1835	18-9081	18-3474	-
F250 / LF250 (3.3L)	2005	18-3071	18-3519	18-3345	18-3173-1	18-1835	18-9081	18-3395	18-3396-1
F250 / LF250 (3.3L)	2006-11	18-3071	18-3519	18-3518	18-3173-1	18-1835	18-9081	18-3515	-
F250A / LF250A (3.3L)	2010-17	18-3071	18-3519	18-3518	18-3173-1	18-1835	18-9081	18-3515	-
F250A / LF250A (4.2L)	2014-17	18-45617-1	18-3457	18-3459	18-3482	18-1829	18-9082	18-3470	18-3471
F250B / LF250B (3.3L)	2008-09	18-3071	18-3519	18-3518	18-3173-1	18-1835	18-9081	18-3515	-
F250B / LF250B (4.2L)	2016-17	18-45617-1	18-3457	18-3459	18-3482	18-1829	18-9082	18-3470	18-3471
FL250	2010	18-45617-1	18-3457	18-3459	18-3482	18-1829	18-9082	18-3470	18-3471
VF250	2009-18	18-3071	18-3519	-	18-3173-1	18-1835	18-9081	18-3474	-
VF250 (XA Models)	2015-18	18-45617-1	18-3457	18-3459	18-3482	18-1829	18-9082	18-3470	18-3471
F300 / LF300 (5.3L)	2007-09	18-8925	18-3457	18-0421	18-3483	18-1835	18-9081	18-3477	-
F300 / LF300 (4.2L)	2010-18	18-45617-1	18-3457	18-3459	18-3482	18-1829	18-9082	18-3470	18-3471
FL300	2010, 2016	18-45617-1	18-3457	18-3459	18-3482	18-1829	18-9082	18-3470	18-3471
F350 / LF350 (5.3L)	2007-09	18-8925	18-3457	18-0421	18-3483	18-1835	18-9081	18-3477	-
F350A / LF350A (5.3L)	2010-11	18-8925	18-3457	18-0421	18-3483	18-1835	18-9081	18-3477	-
F350B / LF350B (5.3L)	2012-15	18-8925	18-3457	18-0421	18-3483	18-1835	18-9081	18-3477	-
F350C / LF350C (5.3L)	2016-18	18-8925	18-3457	18-0421	18-3483	18-1835	18-9081	18-3477	-
FL350 (5.3L)	2010	18-8925	18-3457	18-0421	18-3483	18-1835	18-9081	18-3477	-

YAMAHA 2-STROKE WATER PUMP APPLICATION CHART

HP Model	Year	Impeller	Cup	Plate	Housing	Damper Seal	Water Pump Cover	Kit without Housing	Kit with Housing
2	1984-87	18-3072	18-3328	18-3357	-	18-3166	-	18-3463	-
2	1988-02	18-3072	18-3328	18-3357	-	18-3166	-	18-3462	-
3	1988-02	18-8911	18-3164	18-3163	-	18-3166	-	-	-
4	1984-99	18-3073	-	-	-	18-3166	-	-	-
5	1984-02	18-3073	-	-	-	18-3166	-	-	-
6	1986-00	18-3066	18-3456	-	-	18-1833	-	18-3460	-
8	1984-09	18-3066	18-3456	-	-	18-1833	-	18-3460	-
9.9	1984-95	18-3074	-	-	-	18-1834	-	18-3148	18-3411
9.9	1996-09	18-3040	18-3444	18-3195	-	18-1833	-	18-3433	18-3412
15	1984-95	18-3074	-	-	-	18-1834	-	18-3148	18-3411
15	1996-09	18-3040	18-3444	18-3195	-	18-1833	-	18-3433	18-3412
20	1996-97	18-3065	-	-	-	-	-	18-3431	-
25	1984-85	18-3067	-	-	-	-	-	-	18-3426
25	1986-87	18-3067	-	-	-	-	-	-	18-3427
25 (2 cyl)	1988-09	18-3065	-	-	-	-	-	18-3431	-
25 (3 cyl)	1997-02	18-3068	-	-	-	-	-	-	-
C25	1991-97	18-3067	-	-	-	-	-	-	18-3427
CV25	1990	18-3067	-	-	-	-	-	-	18-3427
30	1984-85	18-3067	-	-	-	-	-	-	18-3426
30	1986	18-3067	-	-	-	-	-	-	18-3427
30	1987-02	18-3068	18-3435	18-3436	-	-	-	18-3430	-
C30	1991-92	18-3067	-	-	-	-	-	-	18-3427
C30	1993-97	18-3068	18-3443	18-3194	18-3185	6L2-44367-00-00	-	-	18-3432
CV30	1989-90	18-3067	-	-	-	-	-	-	-
40	1984-87	18-3068	18-3435	18-3436	-	-	-	18-3429	18-3408
40	1988-94	18-3068	18-3435	18-3436	-	-	-	18-3429	-
40	1995-05	18-3069	18-3449	18-3186	-	-	-	18-3434	18-3415
C40	1990-91	18-3088	-	-	-	-	-	18-3397	-
C40	1992-97	18-3088	-	-	-	-	-	18-3397	18-3398
C40	1997-03	18-3069	18-3449	18-3186	-	-	-	18-3434	18-3415
P40	1998	18-3069	18-3449	18-3186	-	-	-	18-3434	18-3415
E48	1995-2000	18-3069	-	-	-	-	-	-	-
50	1984-87	18-3068	18-3435	18-3436	-	-	-	18-3429	18-3408
50	1988-94	18-3068	18-3435	18-3436	-	-	-	18-3429	-
50	1995-09	18-3069	18-3449	18-3186	-	-	-	18-3434	18-3415

CHART CONTINUED ON NEXT PAGE



YAMAHA 2-STROKE WATER PUMP APPLICATION CHART

HP Model	Year	Impeller	Cup	Plate	Housing	Damper Seal	Water Pump Cover	Kit without Housing	Kit with Housing
C50	1998-01	18-3069	18-3449	18-3186	-	-	-	18-3434	18-3415
PRO 50	1987	18-3068	18-3435	18-3436	-	-	-	18-3429	18-3408
PRO 50	1988-90	18-3068	18-3435	18-3436	-	-	-	18-3429	-
P50	1991-94	18-3068	18-3435	18-3436	-	-	-	18-3429	-
P50	1995-96	18-3069	18-3449	18-3186	-	-	-	18-3434	-
50 Jet	1986-95	18-3068	-	-	-	-	-	-	-
C55	1991-95	18-3069	18-3435	18-3436	-	-	-	18-3425	-
CV55	1989-90	18-3069	18-3435	18-3436	-	-	-	18-3425	-
60	2001-03	18-3069	18-3435	-	-	-	-	18-3465	-
60	2004-05	18-3070	-	-	18-3171	18-1830	-	18-3370	18-3371
C60	1996-01	18-3069	18-3435	-	-	-	-	18-3465	18-3466
E60	1995-96	18-3069	18-3435	-	-	-	-	18-3465	18-3466
E60	1997-00	18-3069	-	-	-	-	-	-	-
P60	1991	18-3069	18-3435	-	-	-	-	18-3428-1	18-3461
P60	1992-99	18-3069	18-3435	-	-	-	-	18-3465	18-3466
70	1984-91	18-3069	18-3435	-	-	-	-	18-3428-1	18-3461
70	1992-03	18-3069	18-3435	-	-	-	-	18-3465	18-3466
70	2004-09	18-3070	-	-	18-3171	18-1830	-	18-3370	18-3371
C70	2000-01	18-3069	18-3435	-	-	-	-	18-3465	18-3466
C75	1994-99	18-3070	-	-	18-3171	18-1830	-	18-3370	18-3371
E75	1995-00	18-3070	-	-	-	-	-	-	-
P75	1996-99	18-3070	-	-	-	-	-	-	-
C80	1997	18-3070	-	-	-	-	-	-	-
C85	1991-96	18-3070	-	-	18-3171	18-1830	-	18-3370	18-3371
CV85	1989-90	18-3070	-	-	18-3171	18-1830	-	18-3370	18-3371
90	1984-09	18-3070	-	-	18-3171	18-1830	-	18-3370	18-3371
90 Jet	1986-89	18-3070	-	-	-	-	-	-	-
90 Jet	1992-94	18-3071	-	-	-	-	-	-	-
B90	1997-99	18-3070	-	-	-	18-1830	-	-	-
C90	1997-01	18-3070	-	-	18-3171	18-1830	-	18-3370	18-3371
115	2002-09	18-3071	18-3333	18-3344	18-3173-1	18-1835	18-9081	18-3312	18-3313-1
115	1995-01	18-3071	18-3333	18-3344	18-3173-1	18-1835	18-9081	18-3312	18-3313-1
115 (6N6), (6E5)	1984-94	18-3071	-	18-3344	18-3170	18-1835	-	18-3372	18-3373
115 (6N6)	1994	18-3071	18-3333	18-3344	18-3173-1	18-1835	18-9081	18-3312	18-3313-1
B115	1998-99	18-3071	18-3519	18-0408	18-3173-1	18-1835	18-9081	18-4533	-
C115	1991-92	18-3071	-	18-3344	18-3170	18-1835	-	18-3372	18-3373
C115	1993-00	18-3071	18-3333	18-3344	18-3173-1	18-1835	18-9081	18-3312	18-3313-1
P115 (62A)	1993-96	18-3071	18-3333	18-3344	18-3173-1	18-1835	18-9081	18-3312	18-3313-1
S115	1996-99	18-3071	18-3519	18-3344	18-3173-1	18-1835	18-9081	18-3312	18-3313-1
130 (6L1), (6N7)	1988-92	18-3071	-	18-3344	18-3170	18-1835	-	18-3372	18-3373
130 (6N7)	1993-96	18-3071	18-3333	18-3344	18-3173-1	18-1835	18-9081	18-3312	18-3313-1
130	1997-04	18-3071	18-3519	18-3344	18-3173-1	18-1835	18-9081	18-3312	18-3313-1
L130 (6L6), (6N4)	1989-92	18-3071	-	18-3344	18-3170	18-1835	-	18-3372	18-3373
L130 (6N4)	1993-96	18-3071	18-3333	18-3344	18-3173-1	18-1835	18-9081	18-3312	18-3313-1
L130	1997-01	18-3071	18-3519	18-3344	18-3173-1	18-1835	18-9081	18-3312	18-3313-1
S130	1996-99	18-3071	18-3519	18-3344	18-3173-1	18-1835	18-9081	18-3312	18-3313-1
150 (6R2), (6G4)	1984-91	18-3071	-	18-3344	18-3170	18-1835	-	18-3310	18-3311
150 (6R2)	1992-09	18-3071	18-3333	18-3345	18-3173-1	18-1835	18-9081	18-3395	18-3396-1
C150 (6E5)	1996-99	18-3071	18-3333	18-3345	18-3173-1	18-1835	18-9081	18-3395	18-3396-1
D150	1997-98	18-3071	18-3519	18-0408	18-3173-1	18-1835	18-9081	18-4533	-
DX150	1999-05	18-3071	18-3519	18-0408	18-3173-1	18-1835	18-9081	18-4533	-
L150 (6R0), (6K0)	1986-91	18-3071	-	18-3344	18-3170	18-1835	-	18-3310	18-3311
L150 (6R0)	1992-99	18-3071	18-3333	18-3345	18-3173-1	18-1835	18-9081	18-3395	18-3396-1
LX150	1999-01	18-3071	18-3333	18-3345	18-3173-1	18-1835	18-9081	18-3395	18-3396-1
P150	1986-91	18-3071	-	18-3344	18-3170	18-1835	-	18-3310	18-3311
P150	1992-99	18-3071	18-3333	18-3345	18-3173-1	18-1835	18-9081	18-3395	18-3396-1

CHART CONTINUED ON NEXT PAGE

YAMAHA 2-STROKE WATER PUMP APPLICATION CHART

HP Model	Year	Impeller	Cup	Plate	Housing	Damper Seal	Water Pump Cover	Kit without Housing	Kit with Housing
PRO V150 (6J9)	1986-89	18-3071	-	18-3344	18-3170	18-1835	-	18-3310	18-3311
PRO V150D (6N9)	1990	18-3071	-	18-3344	18-3170	18-1835	-	18-3310	18-3311
PX150	1999	18-3071	18-3333	18-3345	18-3173-1	18-1835	18-9081	18-3395	18-3396-1
S150	1996-99	18-3071	18-3333	18-3345	18-3173-1	18-1835	18-9081	18-3395	18-3396-1
SX150	1999-04	18-3071	18-3333	18-3345	18-3173-1	18-1835	18-9081	18-3395	18-3396-1
V150	2000-08	18-3071	18-3333	18-3345	18-3173-1	18-1835	18-9081	18-3395	18-3396-1
VX150	2000-04	18-3071	18-3333	18-3345	18-3173-1	18-1835	18-9081	18-3395	18-3396-1
VZ150	2000-14	18-3071	18-3333	18-3345	18-3173-1	18-1835	18-9081	18-3395	18-3396-1
Z150/LZ150	2000-05	18-3071	18-3333	18-3345	18-3173-1	18-1835	18-9081	18-3395	18-3396-1
175 (6G5)	1984-91	18-3071	-	18-3344	18-3170	18-1835	-	18-3310	18-3311
175 (6R3)	1992-00	18-3071	18-3333	18-3345	18-3173-1	18-1835	18-9081	18-3395	18-3396-1
P175 (62H)	1994-99	18-3071	18-3333	18-3345	18-3173-1	18-1835	18-9081	18-3395	18-3396-1
S175	1996-99	18-3071	18-3333	18-3345	18-3173-1	18-1835	18-9081	18-3395	18-3396-1
V175	2000	18-3071	18-3333	18-3345	18-3173-1	18-1835	18-9081	18-3395	18-3396-1
VZ175	2001-12	18-3071	18-3333	18-3345	18-3173-1	18-1835	18-9081	18-3395	18-3396-1
Z175	2001-05	18-3071	18-3333	18-3345	18-3173-1	18-1835	18-9081	18-3395	18-3396-1
200 (6G6), (6R4)	1984-91	18-3071	-	18-3344	18-3170	18-1835	-	18-3310	18-3311
200 (6R4)	1992-99	18-3071	18-3333	18-3345	18-3173-1	18-1835	18-9081	18-3395	18-3396-1
L200 (6K1), (6R1)	1986-91	18-3071	-	18-3344	18-3170	18-1835	-	18-3310	18-3311
L200	1992-99	18-3071	18-3333	18-3345	18-3173-1	18-1835	18-9081	18-3395	18-3396-1
LX200	1999-01	18-3071	18-3333	18-3345	18-3173-1	18-1835	18-9081	18-3395	18-3396-1
LZ200	2000-12	18-3071	18-3333	18-3345	18-3173-1	18-1835	18-9081	18-3395	18-3396-1
P200	1991-99	18-3071	18-3333	18-3345	18-3173-1	18-1835	18-9081	18-3395	18-3396-1
S200	1996-99	18-3071	18-3333	18-3345	18-3173-1	18-1835	18-9081	18-3395	18-3396-1
SX200	1999-05	18-3071	18-3333	18-3345	18-3173-1	18-1835	18-9081	18-3395	18-3396-1
V200	1998-99	18-3071	18-3333	18-3345	18-3173-1	18-1835	18-9081	18-3395	18-3396-1
VX200	2000-05	18-3071	18-3333	18-3345	18-3173-1	18-1835	18-9081	18-3395	18-3396-1
VZ200	2001-04	18-3071	18-3333	18-3345	18-3173-1	18-1835	18-9081	18-3395	18-3396-1
VZ200	2005-09	18-3071	18-3519	18-3520	18-3173-1	18-1835	18-9081	18-3516	-
Z200	2000-12	18-3071	18-3333	18-3345	18-3173-1	18-1835	18-9081	18-3395	18-3396-1
V6 Special (6G7)	1984-86	18-3071	-	18-3344	18-3170	18-1835	-	18-3310	18-3311
V6 Excel (6K7)	1987-89	18-3071	-	18-3344	18-3170	18-1835	-	18-3310	18-3311
225 (6R5)	1990-91	18-3071	-	18-3344	18-3170	18-1835	-	18-3310	18-3311
225	1992-97	18-3071	18-3333	18-3345	18-3173-1	18-1835	18-9081	18-3395	18-3396-1
L225	1994-99	18-3071	18-3333	18-3345	18-3173-1	18-1835	18-9081	18-3395	18-3396-1
LX225	2000-03	18-3071	18-3333	18-3345	18-3173-1	18-1835	18-9081	18-3395	18-3396-1
S225	1996-99	18-3071	18-3333	18-3345	18-3173-1	18-1835	18-9081	18-3395	18-3396-1
SX225	2000-03	18-3071	18-3333	18-3345	18-3173-1	18-1835	18-9081	18-3395	18-3396-1
V225	1998-99	18-3071	18-3333	18-3345	18-3173-1	18-1835	18-9081	18-3395	18-3396-1
VX225	2000-04	18-3071	18-3333	18-3345	18-3173-1	18-1835	18-9081	18-3395	18-3396-1
VZ225	2003-09	18-3071	18-3519	18-3520	18-3173-1	18-1835	18-9081	18-3516	-
250	1990-95	18-3071	18-3333	18-3345	18-3173-1	18-1835	18-9081	18-3395	18-3396-1
L250	1990-99	18-3071	18-3333	18-3345	18-3173-1	18-1835	18-9081	18-3395	18-3396-1
LX250	2000-03	18-3071	18-3333	18-3345	18-3173-1	18-1835	18-9081	18-3395	18-3396-1
LZ250	2003-05	18-3071	18-3333	18-3345	18-3173-1	18-1835	18-9081	18-3395	18-3396-1
S250	1996-99	18-3071	18-3333	18-3345	18-3173-1	18-1835	18-9081	18-3395	18-3396-1
SX250	2000-03	18-3071	18-3333	18-3345	18-3173-1	18-1835	18-9081	18-3395	18-3396-1
VX250	2002-04	18-3071	18-3333	18-3345	18-3173-1	18-1835	18-9081	18-3395	18-3396-1
VZ250	2003-09	18-3071	18-3519	18-3520	18-3173-1	18-1835	18-9081	18-3516	-
LZ300	2004-06	18-3071	18-3519	-	18-3173-1	18-1835	18-9081	18-3515	-
VZ300	2004-09	18-3071	18-3519	18-3520	18-3173-1	18-1835	18-9081	18-3516	-
Z250	2003-05	18-3071	18-3333	18-3345	18-3173-1	18-1835	18-9081	18-3395	18-3396-1
Z300	2004-06	18-3071	18-3519	-	18-3173-1	18-1835	18-9081	18-3515	-

 <p>18-3524 THERMOSTAT Replaces: 6CE-12411-00-00 Fits: F225/LF225 (2010-2016), F250/LF250 (2010-2016), VF250 (2015), F300/LF300 (2010-2016), FL250/FL300 (2010)</p>	<p>50°C</p>  <p>18-3525 THERMOSTAT Replaces: 60V-12411-00 Fits: F115(2005-14), LF115(2005-14), LZ250(2003-05), LZ300(2004-06), VZ200(2005-09), VZ225(2005-09), VZ250(2005-09), VZ300(2005-09), Z250(2003-05), Z300(2004-06)</p>	<p>60°C</p>  <p>18-3625 THERMOSTAT (Seal Included) Replaces: 6F5-12411-03-00 9.9EL, 9.9ES, 15EL, 15ES (1986-1995), 9.9L, 9.9S, 15L, 15S (1986-1990), 9.9M, 15ML, 15MS, C55EL (1991-1995), C25EL, C40EL (1991-1997), C25ML (1993-1997), C25MS, C40MS, C40PL (1992-1997), C30EL (1991-1992), CV30EL (1989-1990), C40ML (1994-1995), C55TL (1993-1995), CV25EL, CV25EM, CV40EL (1990), CV55EL (1989)</p>
<p>50°C</p>  <p>18-3623 THERMOSTAT (Seal Included) Replaces: 6E5-12411-02-00 8MSH-0405, 8MSH-0406, 8MSH-0407, 8MSH-0608, 8MSHD-2005</p>	<p>60°C</p>  <p>18-3632 THERMOSTAT Replaces: 67F-12411-01-00 Fits: F75-F250 (2005 & Up)</p>	<p>New</p>  <p>18-3634 THERMOSTAT Replaces: 6AW-12411-00-00 Fits: F300/LF300 (2007-09), F350/LF350 (2007-09), F350A/LF350A (2010-11), F350B/LF350B (2012-15), F350C/LF350C (2016-18)</p>
<p>New</p>  <p>18-3636 THERMOSTAT Replaces: 6DA-12411-01-00 Fits: F150C/LF150C (2017), VF150 (2013-17), VF150A (2018), F175A (2014-18), F175C/LF175C (2017), VF175 (2015-18), F200B/LF200B (2012-18), F200C/LF200C (2013-18)</p>	<p>New</p>  <p>18-3637 THERMOSTAT Replaces: 6CB-12411-10-00 Fits: VF200LA/VF225LA/VF250LA (2011-18)</p>	<p>New</p>  <p>18-3639 THERMOSTAT Replaces: 6EK-12411-00-00 Fits: F115/LF115/VF115 (2014-18)</p>
<p>New</p>  <p>18-3641 THERMOSTAT Replaces: 6FP-12411-00-00 Fits: F75B (2017-18), F90B (2016-18), VF90A (2018)</p>	<p>50°C</p>  <p>18-3540 THERMOSTAT Replaces: 6E5-12411-30-00 Fits: 9.9-15 (1996-06), 20 (1996-97), 25 (1988-95), 30 3-cyl (1987-91), 40 (1986-05), C40 3-cyl (1998-02), 50 (1986-05), C50 (1998-01), P50 (1987-96), 115 (1984-05), B115 (1998-99), C115 (1991-00), P115 (1993-96), S115/S130 (1996-98), 130L130 (1988-05), 150/175/200 (1986-05), C150 (1996-99), D150/DX150 (1997-05), L150/L200 (1986-99), LX150/LX200 (1999-01), P150 (1986-99), PX150 (1999), SX150/SX200 (1999-04), V150 (2000-05), VX150 (2000-05), VZ150/VZ175/VZ200 (2001-05), Z150/Z175/Z200 (2000-05), P200 (1991-93), V200/V225 (1998-99), VX200/VX225 (2000-05), V6 Special (1984-86), V6 Excel (1987-89), 225 2.6L (1990-97), 250/L250 2.6L (1990-95) Note: Will not fit 3.1 L</p>	
<p>60°C</p>  <p>18-3541 THERMOSTAT Replaces: 66M-12411-01-00 Fits: F6 (2001-05), F8 (2001-05), T8 (2001-05), F9.9 (1985-05), T9.9 (1985-05), T9.9 (1991-05), F15 (1998-05), F25 (1998-05), T25 (2001-05), F30 (2001-05), F40 4cyl (1999), F40 3cyl (2000-05), F50 (1995-05), T50 (1996-05), F60 (2002-05), T60 (2003-05), F80 (1999-00), F100 (1999-00)</p>	<p>50°C</p>  <p>18-3622 THERMOSTAT KIT Replaces: 6H3-12411-11-00 60TLR-0405, 70TLR-0405, 70TLR-0406, 70TLR-0407, 70TLR-0408</p>	<p>50°C</p>  <p>18-3624 THERMOSTAT KIT Replaces: 69M-12411-01-00 F2.5MSH-0405, F2.5MSH-0406, F2.5MSH-0407, F2.5MSH0608, F2.5MSHD-2005</p>

APPLICATION STARTS ON NEXT PAGE

①18-3608D Display Package



18-3608
THERMOSTAT KIT
Fits: 115 (1991-02), C115 (1991-99), P115 (1993-96), S115 (1996-99), 130 (1991-02), L130 (1991-00), S130 (1996-99), 150 (1991-02), C150 (1996-99), L150 (1991-99), P150 (1991-99), S150 (1996-99), V150 (2000-02), Z150 (2001-02), 175 (1991-95, 97), P175 (1994-99), V175 (2000), Z175 (2001-02), 200 (1991-98), L200 (1991-99), P200 (1991-99), S200 (1996-99), V200 (1998-99), Z200 (2001-02), 225 (1991-97), V225 (1998-99)

— CONTAINS—

Part #	Desc.	O.E. #	Qty.
18-3540	Thermostat	6E5-12411-30-00	1
18-0844	Gasket	688-12414-A1-00	1

①18-3609D Display Package



18-3609
THERMOSTAT KIT
Fits: 25 (1996-98,2001-02), 40 (1991-99, 01), C40 (1997-02), P40 (1998), 50 (1991-97, 1999-02), C50 (1998-01), P50 (1991-96), L225 (1994-99), S225 (1996-99), 250 (1991-95), L250 (1991-99), S250 (1996-99)

— CONTAINS—

Part #	Desc.	O.E. #	Qty.
18-3540	Thermostat	6E5-12411-30-00	1
18-0829	Gasket	61A-12414-A0-00, 6J8-12414-A0-00	1

60°C



18-3611
THERMOSTAT KIT
Fits: 15 (2006), F15 (1998-06), F25 (1999-06), F30 (2001-06), F40 (1999-06), F50 (1996-06), F60 (2002-06), F9.9 (2005-06), T25 (2001-06), T50 (1996-06), T60 (2003-06), T9.9 (2005-06)

— CONTAINS—

Part #	Desc.	O.E. #	Qty.
18-3541	Thermostat	66M-12411-01-00	1
18-0835	Gasket	62Y-12414-00-00	1

YAMAHA 2-STROKE THERMOSTAT APPLICATION

HP/Model	Year	Thermostat	Gasket	Thermostat Kit	Qty. Per Engine
4	1986-88	18-3540	—	—	1
4	1989-99	18-3623	—	—	1
5	1995-02	18-3623	—	—	1
6	1986-88	18-3540	—	—	1
6	1989-00	18-3623	—	—	1
8	1986-88	18-3540	—	—	1
8	1989-09	18-3623	—	—	1
9.9	1986-95	18-3625	18-0836	—	1
9.9	1996-09	18-3540	18-0836	—	1
15	1984-85	—	18-0836	—	1
15	1986-95	18-3625	18-0836	—	1
15	1996-09	18-3540	18-0836	—	1
20	1996-97	18-3540	18-0829	18-3609	1
25 (2 cyl)	1984-87	—	18-0232	—	1
25 (2 cyl)	1988-09	18-3540	18-0829	18-3609	1
C25	1991-97	18-3625	18-0232	—	1
CV25	1990	18-3625	18-0232	—	1
30	1984-85	—	18-0232	—	1
30	1986	18-3625	18-0835	—	1
30	1987-88	18-3540	18-0829	18-3609	1
30	1989-91	18-3623	18-0829	—	1
30	1992-02	—	18-0829	—	1
C30	1991-92	18-3625	18-0232	—	1
C30	1993-94, 1996-97	18-3623	18-0232	—	1
40	1984-85	—	18-0829	—	1
40	1986-05	18-3540	18-0829	18-3609	1
C40	1991-97	18-3625	—	—	1
C40	1998-03	18-3540	18-0829	18-3609	1
P40	1998	18-3540	18-0829	18-3609	1
50	1984-85	—	18-0829	—	1
50	1986-09	18-3540	18-0829	18-3609	1
C50	1998-01	18-3540	18-0829	18-3609	1
PRO 50	1987-90	18-3540	18-0829	18-3609	1
P50	1991-96	18-3540	18-0829	18-3609	1
50 Jet	1986-00	18-3540	18-0829	18-3609	1
C55	1991-95	18-3625	—	—	1
CV55	1989-90	18-3625	—	—	1
60	2001-05	Kit Only	18-0835	18-3622	1
C60	1996-01	Kit Only	18-0835	18-3622	1
E60	1995-00	Kit Only	18-0835	18-3622	1
P60	1991-99	Kit Only	18-0835	18-3622	1

APPLICATION CONTINUED ON NEXT PAGE

YAMAHA 2-STROKE THERMOSTAT APPLICATION

HP/Model	Year	Thermostat	Gasket	Thermostat Kit	Qty. Per Engine
70	1984-09	Kit Only	18-0835	18-3622	1
C70	2000-01	Kit Only	18-0835	18-3622	1
C75	1994-99	—	18-0844	—	1
E75	1995-00	—	18-0844	—	1
P75	1996-99	—	18-0844	—	1
C80	1997	—	18-0844	—	1
90	1984-09	—	18-0844	—	1
90 Jet	1986-00	—	18-0844	—	1
B90	1997-99	—	18-0844	—	1
C90	1997-01	—	18-0844	—	1
115	1984-09	18-3540	18-0844	18-3608	2
B115	1998-99	18-3540	18-0844	18-3608	2
C115	1991-00	18-3540	18-0844	18-3608	2
P115	1993-96	18-3540	18-0844	18-3608	2
S115	1996-99	18-3540	18-0844	18-3608	2
130	1988-04	18-3540	18-0844	18-3608	2
L130	1989-01	18-3540	18-0844	18-3608	2
S130	1996-99	18-3540	18-0844	18-3608	2
C150	1996-99	18-3540	18-0844	18-3608	2
150	1984	—	18-0844	—	2
150	1985	18-3623	18-0844	—	2
150	1986-09	18-3540	18-0844	18-3608	2
D150	1997-99	18-3540	18-0844	18-3608	2
DX150	1999-05	18-3540	18-0844	18-3608	2
L150	1986-99	18-3540	18-0844	18-3608	2
LX150	1999-01	18-3540	18-0844	18-3608	2
LZ150	2000-05	18-3540	18-0844	18-3608	2
Z150	2000-05	18-3540	18-0844	18-3608	2
P150	1991-99	18-3540	18-0844	18-3608	2
PX150	1999	18-3540	18-0844	18-3608	2
PRO V150	1986-90	18-3540	18-0844	18-3608	2
S150	1996-99	18-3540	18-0844	18-3608	2
SX150	1999-04	18-3540	18-0844	18-3608	2
V150	2000-08	18-3540	18-0844	18-3608	2
VX150	2000-04	18-3540	18-0844	18-3608	2
VZ150	2000-11	18-3540	18-0844	18-3608	2
175	1984	—	18-0844	—	2
175	1985	18-3623	18-0844	—	2
175	1986-00	18-3540	18-0844	18-3608	2
P175	1994-99	18-3540	18-0844	18-3608	2
S175	1996-99	18-3540	18-0844	18-3608	2
V175	2000	18-3540	18-0844	18-3608	2
VZ175	2001-10	18-3540	18-0844	18-3608	2
Z175	2001-05	18-3540	18-0844	18-3608	2
200	1984	—	18-0844	—	2
200	1985	18-3623	18-0844	—	2
200	1986-98	18-3540	18-0844	18-3608	2
L200	1986-99	18-3540	18-0844	18-3608	2
LX200	1999-01	18-3540	18-0844	18-3608	2
LZ200	2000-11	18-3540	18-0844	18-3608	2
P200	1991-99	18-3540	18-0844	18-3608	2
SX200	1999-05	18-3540	18-0844	18-3608	2
V200	1998-99	18-3540	18-0829	18-3609	2
VX200	2000-05	18-3540	18-0829	18-3609	2
VZ200	2001-04	18-3540	18-0844	18-3608	2

APPLICATION CONTINUED ON NEXT PAGE

YAMAHA 2-STROKE THERMOSTAT APPLICATION

HP/Model	Year	Thermostat	Gasket	Thermostat Kit	Qty. Per Engine
VZ200	2005-09	18-3525	-	-	2
Z200	2000-11	18-3540	18-0844	18-3608	2
V6 Special	1985-86	18-3540	18-0844	18-3608	2
V6 Excel	1987-89	18-3540	18-0844	18-3608	2
225	1990-97	18-3540	18-0844	18-3608	2
L225	1994-99	18-3540	18-0829	18-3609	2
S225	1996-99	18-3540	18-0829	18-3609	2
LX225	2000-03	18-3540	18-0829	18-3609	2
SX225	2000-03	18-3540	18-0829	18-3609	2
V225	1998-99	18-3540	18-0829	18-3609	2
V225	2003-09	18-3525	-	-	2
VX225	2000-04	18-3540	18-0829	18-3609	2
VZ250	2003-09	18-3525	-	-	2
250	1990-95	18-3540	18-0829	18-3609	2
L250	1990-99	18-3540	18-0829	18-3609	2
LX250	2000-03	18-3540	18-0829	18-3609	2
S250	1996-99	18-3540	18-0829	18-3609	2
SX250	2000-03	18-3540	18-0829	18-3609	2
VX250	2002-04	18-3540	18-0829	18-3609	2
Z250 / LZ250	2003-05	18-3525	-	-	2
VZ300	2004-09	18-3525	-	-	2
Z300 / LZ300	2004-06	18-3525	-	-	2

YAMAHA 4-STROKE THERMOSTAT APPLICATION

HP/Model	Year	Thermostat	Gasket	Thermostat Kit	Qty. Per Engine
F2.5	2003-17	Kit Only	18-0754	18-3624	1
F4	1999-17	18-3541	18-0754	—	1
F6	2001-08	18-3541	18-99120	—	1
F6	2009-17	18-3541	18-0754	—	1
F8	2001-10	18-3541	18-99120	—	1
F8A	2011-14	18-3541	18-99120	—	1
F8B	2015-18	18-3541	18-99120	—	1
T8	2001-10	18-3541	18-99120	—	1
F9.9	1985-05	18-3541	18-99120	—	1
F9.9 (66N)	2005-06	18-3541	18-0835	18-3611	1
F9.9A	2011-12	18-3541	18-99120	—	1
F9.9B	2013-18	18-3541	18-99120	—	1
F9.9F	2007-10	18-3541	18-99120	—	1
FT9.9	1985-90	18-3541	18-99120	—	1
T9.9	1991-05	18-3541	18-99120	—	1
T9.9 (66R)	2005-06	18-3541	18-0835	18-3611	1
T9.9A	2011-12	18-3541	18-99120	—	1
T9.9B	2013-18	18-3541	18-99120	—	1
T9.9G	2007-10	18-3541	18-99120	—	1
F15	1998-06	18-3541	18-0835	18-3611	1
F25	1998-05	18-3541	18-0835	18-3611	1
F25A	2009-18	18-3541	18-0835	18-3611	1
F25B	2012-18	18-3541	18-0835	18-3611	1
F25	1998-08	18-3541	18-0835	18-3611	1
T25	2001-04	18-3541	18-0835	18-3611	1
T25	2001-08	18-3541	18-0835	18-3611	1
T25	2009-18	18-3541	18-0835	18-3611	1
F30	2001-05	18-3541	18-0835	18-3611	1
F30	2013-18	18-3541	18-0835	18-3611	1
F40	1999-06	18-3541	18-0835	18-3611	1

APPLICATION CONTINUED ON NEXT PAGE

YAMAHA 4-STROKE THERMOSTAT APPLICATION

HP/Model	Year	Thermostat	Gasket	Thermostat Kit	Qty. Per Engine
F40A	2008-18	18-3541	18-0835	18-3611	1
F40B	2007-08	18-3541	18-0835	18-3611	1
F50	1995-18	18-3541	18-0835	18-3611	1
T50	1996-18	18-3541	18-0835	18-3611	1
F60	2002-18	18-3541	18-0835	18-3611	1
T60	2003-18	18-3541	18-0835	18-3611	1
F70A	2010-18	18-3541	18-0835	18-3611	1
F75A	2003-17	18-3632	—	—	1
F75B	2017-18	18-3641	—	—	1
F80	1999-00	18-3541	—	—	1
F80	2001-03	18-3632	—	—	1
F90	2003-11	18-3632	—	—	1
F90A	2012-17	18-3632	—	—	1
F90B	2016-18	18-3641	—	—	1
VF90A	2018	18-3641	—	—	1
F100	1999-00	18-3541	—	—	1
F100	2001-03	18-3632	—	—	1
F115 / LF115	2000-14	18-3525	—	—	1
F115 / LF115	2014-18	18-3639	—	—	1
VF115	2015-18	18-3639	—	—	1
F150 / LF150	2004-11	18-3632	18-99127	—	1
F150A / LF150A	2012-14	18-3632	18-99127	—	1
F150B / LF150B	2015-18	18-3632	18-99127	—	1
F150C / LF150C	2017	18-3636	—	—	1
VF150	2013-17	18-3636	—	—	1
VF150A	2018	18-3636	—	—	1
F175A	2014-18	18-3636	—	—	1
F175C / LF175C	2017	18-3636	—	—	1
VF175	2015-18	18-3636	—	—	1
F200 / LF200	2005-10	18-3632	—	—	2
F200A / LF200A	2011-17	18-3632	—	—	2
F200B / LF200B	2012-18	18-3636	—	—	1
F200C / LF200C	2013-18	18-3636	—	—	1
VF200	2009-10	18-3632	—	—	2
VF200LA	2011-18	18-3637	—	—	2
F225 / LF225	2005-10	18-3632	—	—	2
F225A / LF225A	2011-17	18-3632	—	—	2
F225A / LF225A	2010-17	18-3524	—	—	2
F225B / LF225B	2016-17	18-3524	—	—	2
F225B / LF225B	2008-09	18-3632	—	—	2
VF225	2009-10	18-3632	—	—	2
VF225LA	2011-18	18-3637	—	—	2
F250 / LF250	2005-11	18-3632	—	—	2
F250A / LF250A	2010-17	18-3524	—	—	2
F250B / LF250B	2016-17	18-3524	—	—	2
VF250	2010	18-3632	—	—	2
VF250LA	2011-18	18-3637	—	—	2
VF250XA	2015-17	18-3524	—	—	2
F300 / LF300	2007-09	18-3634	—	—	2
F300A / LF300A	2010-18	18-3524	—	—	2
F350 / LF350	2007-09	18-3634	—	—	2
F350A / LF350A	2010-11	18-3634	—	—	2
F350B / LF350B	2012-15	18-3634	—	—	2
F350C / LF350C	2016-18	18-3634	—	—	2

**ALL PISTONS
ARE SUPPLIED WITH PISTON RINGS, WRIST PIN AND CIRCLIPS**



Piston Rings are available individually.

V-4 & V-6 Pistons and Rings

STANDARD			.25mm O.S.	.50mm O.S.		
18-4128 (Port) Replaces: 6G5-11642-00-93	18-4129 (Stbd.) Replaces: 6G5-11631-00-93		18-4130 (Port)	18-4132 (Port) Replaces: 6G5-11646-01-00	18-4133 (Stbd.) Replaces: 6G5-11636-01-00	
— CONTAINS —						
Part #	Rings	O.E. #				
18-3934	Standard	6E5-11610-03-00				

V-6 Loop Charged Engines (1992-2001)

18-4080 (Port) Replaces: 6R5-11642-11-93	18-4081 (Stbd.) Replaces: 6R5-11631-11-93	18-4082 (Port) Replaces: 6R5-11645-11-00	18-4083 (Stbd.) Replaces: 6R5-11635-11-00	18-4084 (Port) Replaces: 6R5-11646-11-00	18-4085 (Stbd.) Replaces: 6R5-11636-11-00
— CONTAINS —					
Part #	Rings	O.E. #			
18-39320	Standard	6R5-11603-00			

★ ★ ★ Inline Pistons and Rings ★ ★ ★

STANDARD			.25mm O.S.	.50mm O.S.		
18-4091 Replaces: 6H3-11631-01-96 — CONTAINS —			Part # 18-3977	Rings 25mm O.S.	O.E. # 682-11610-11-00	18-4093 Replaces: 6H3-11636-01-00
Part #	Rings	O.E. #				18-4096 Replaces: 6K5-11636-03-00
18-3963	Standard	6K5-11601-02-00				18-4146 Replaces: 61N-11636-00-00
18-4135 Replaces: 6E7-11631-00-97 — CONTAINS —			18-4142 Replaces: 6H4-11635-01-00			18-4143 Replaces: 6H4-11636-00-00 — CONTAINS —
Part #	Rings	O.E. #	Part #	Rings	O.E. #	Part #
18-3976	Standard	682-11610-01-00	18-3958	25mm O.S.	61N-11604-00-00	18-3962
18-4138 Replaces: 689-11631-00-95 — CONTAINS —						18-4099 Replaces: 6H1-11636-03-00
Part #	Rings	O.E. #				
18-3954	Standard	689-11610-01-00				
18-4141 Replaces: 6H4-11631-00-96 — CONTAINS —						
Part #	Rings	O.E. #				
18-3960	Standard	6H4-11610-00-00				
18-4097 Replaces: 6H1-11631-03-95 — CONTAINS —						
Part #	Rings	O.E. #				
18-3969	Standard	688-11603-A0-00				

PISTON APPLICATION

HP/Model	Years	PISTON			RINGS		
		Std.	.25mm	.50mm	Std.	.25mm	.50mm
9.9/15	1984-96	18-4135	—	18-4137	18-3976	18-3977	—
9.9/15	1997-2009	18-4135	—	18-4137	18-3976	18-3977	—
25	1985	18-4138	—	—	18-3954	—	—
30	1984-86	18-4138	—	—	18-3954	—	—
C30	1991-92	18-4138	—	—	18-3954	—	—
C30	1993-97	—	18-4145	18-4146	18-3957	—	—
40	1984-88	18-4141	—	18-4143	18-3960	18-3961	18-3962
C40	1997-99,2001-02	—	18-4142	18-4143	18-3960	18-3961	18-3962
P40	1998	—	—	18-4143	18-3960	18-3961	18-3962
E48	1997	18-4097	—	18-4099	18-3969	—	—
50	1984-88	18-4141	—	18-4143	18-3960	18-3961	18-3962
50	1996-97, 1999, 2000,2002-03	18-4141	18-4142	18-4143	18-3960	18-3961	18-3962
C50	1998-99, 2001	—	18-4142	18-4143	18-3960	18-3961	18-3962
P50	1996	—	18-4142	18-4143	18-3960	18-3961	18-3962
Pro50	1987-88	18-4141	—	18-4143	18-3960	—	—
60	2001-05	18-4091	—	18-4093	18-3963	—	—
C60	1996-01	18-4091	—	18-4093	18-3963	—	—
E60 MLH,T,U,V	1995-00	—	—	18-4096	18-3963	—	—
P60	1991-99	18-4091	—	18-4093	18-3963	—	—
70	1984-09	18-4091	—	18-4093	18-3963	—	—
C70	2000-01	18-4091	—	18-4093	18-3963	—	—
75	1994-98	18-4097	—	18-4099	18-3969	—	—
C75	1996	18-4097	—	18-4099	18-3969	—	—

APPLICATION CONTINUED ON NEXT PAGE



PISTON APPLICATION (Cont.)

HP/Model	Years	PISTON			RINGS		
		Std.	.25mm	.50mm	Std.	.25mm	.50mm
C75	1998-99	18-4097	—	18-4099	18-3969	—	—
E75	1996-97	18-4097	—	18-4099	18-3969	—	—
P75	1996-99	18-4097	—	18-4099	18-3969	—	—
C80	1997	18-4097	—	18-4099	18-3969	—	—
C85	1996	18-4097	—	18-4099	18-3969	—	—
90	1994-09	18-4097	—	18-4099	18-3969	—	—
C90	1997-01	18-4097	—	18-4099	18-3969	—	—

V4 & V-6 Engines	Years	PISTON						RINGS		
		Port Std.	Stbd. Std.	Port .25mm	Stbd. .25mm	Port .50mm	Stbd. .50mm	Std.	Std.	
115 w/22mm wrist pin	V-4	1984-86	18-4128	18-4129	18-4130	—	18-4132	18-4133	18-3934	18-3936
115 w/22mm wrist pin	V-4	1987-92	18-4128	18-4129	18-4130	—	18-4132	18-4133	18-3934	18-3936
115 w/23mm wrist pin	V-4	1993-03	18-4080	18-4081	18-4082	18-4083	18-4084	18-4085	18-39320	18-3936
130 w/22mm wrist pin	V-4	1984-92	18-4128	18-4129	18-4130	—	18-4132	18-4133	18-3934	18-3936
130 w/23mm wrist pin	V-4	1993-03	18-4080	18-4081	18-4082	18-4083	18-4084	18-4085	18-39320	18-3936
150, 175 w/22mm wrist pin	V-6	1984-92	18-4128	18-4129	18-4130	—	18-4132	18-4133	18-3934	18-3936
150, 175 w/23mm wrist pin	V-6	1993-99	18-4080	18-4081	18-4082	18-4083	18-4084	18-4085	18-39320	18-3936
200, 225 w/22mm wrist pin	V-6	1984-92	18-4128	18-4129	18-4130	—	18-4132	18-4133	18-3934	18-3936
200, 225 w/22mm wrist pin	V-6	1993-99	18-4080	18-4081	18-4082	18-4083	18-4084	18-4085	18-39320	18-3936
SPECIAL J,K,LN,XN (6G7)	V-6	1984-86	18-4128	18-4129	18-4130	—	18-4132	18-4133	18-3934	18-3936

 <p>18-1755 CONNECTING ROD Replaces: 650-11651-04-00 Fits: 9.9, 15 (1996-97)</p>	 <p>18-1756 CONNECTING ROD Replaces: 688-11650-03-00 Fits: 55 (1991-95), 75 (1994-99), 80 (1997), 85 (1991-96), 90 (1997, 2000-01)</p>	 <p>18-1755K CONNECTING ROD KIT Replaces: 650-11651-04-00 Fits: E336 9.9 (1996-97), 15 (1996-97)</p>	 <p>18-4157 CONNECTING ROD Replaces: 6R5-11650-10-00 For: V6 150/175/200 (1992-03)</p>	 <p>18-1410 ROD BEARING Replaces: 93310-32337-00 Fits: 115 (1993-03), 130 (1993-00, 2002-03), 150 (1992-00, 2002-03), 175 (1992-98, 2000), 200 (1992-98), 225 (1992-93, 1997)</p>
--	---	---	--	--

 <p>18-1411 ROD BEARING Replaces: 93310-620V5-00 Fits: 9.9 (1996-97), 15 (1996-97)</p>	 <p>18-4077 ROD BEARING Replaces: 93310-730V8-00 For: 45, 55, 90 HP -3 Cyl.</p>	 <p>18-4078 ROD BEARING Replaces: 93310-836V2-00 For: V4 & V6 (1990 motors)</p>	 <p>WASHERS 18-0191 Replaces: 92990-06600-00</p>	 <p>18-79974 OIL STRAINER Replaces: 6J8-13411-00 Fits: 20(1996-97), 25(1988-01), 30(1987-02), 40(1989-05), 50(1989-09), 60(2001-05), 70(1989-09), C30(1995), P40(1998), P50(1991-96), P60(1991-99), PRO50(1989-90)</p>
---	--	--	--	---

 <p>18-79975 OIL STRAINER Replaces: 6E5-13411-00 Fits: 115(1988-09), 130(1988-05), 150(1989-09), 175(1989-00), 200(1989-98), 225(1990-97), B115(1998-99), D150(1997-99), DX150(1999-05), L130(1989-01), L150(1988-99), L200(1988-99), LX150(1999-01), LX200(1999-01), LZ150(2000-05), LZ200(1999-12), P115(1993-96), P150(1991-99), P175(1994-99), P200(1991-99), PRO V150(1988-90), PX150(1999), S115-(1996-99), S130(1996-99), S150(1996-99), S200(1996-99)SX150(1999-04), SX200(1999-05), V150(2000-08), V175(2000), V6 Excel(1988-89), VX150(2000-04), VZ150(2000-12), VZ175(2001-12), VZ200(2001-04), Z150(2000-05), Z175(2001-05), Z200(2000-12)</p>	 <p>18-79976 OIL STRAINER Replaces: 61A-13411-00 Fits: 225(1994-95), 250(1990-95), L225(1994-99), L250(1990-99), LX225(2000-03), LX250(2000-03), LZ250(2003-05), LZ300(2004-06), S225(1996-99), S250(1996-99), SX225(2000-03), SX250(2000-03), V200(1998-99), VZ25(1998-99), VX200(2000-05), VX225(2000-04), VX250(2002-04), VZ200(2005-09), VZ225(2003-09), VZ250(2003-09), VZ300(2004-09), Z250(2003-05), Z300(2004-06)</p>
---	---

 <p>18-79971 OIL STRAINER, ELECTRIC Replaces: 68F-13440-00 Fits: LZ150(2000-05), LZ200(2000-12), LZ250(2003-05), LZ300(2004-06), VZ150(2000-12), VZ175(2001-12), VZ175(2001-12), VZ200(2001-09), VZ225(2003-09), VZ250(2003-09), VZ300(2004-09), Z150(2000-05), Z175(2001-05), Z200(2000-12), Z250(2003-05), Z300(2004-06)</p>	 <p>18-79961 OIL STRAINER Replaces: 6H1-13411-00 Fits: 90(1990-01), B90(1997-99), C90(2000-01), P75(1996-99)</p>	 <p>18-7911-1 OIL FILTER Replaces: 5GH-13440-00, 5GH-13440-10, 5GH-13440-30</p>	 <p>18-7954 OIL FILTER Replaces: N26-13440-02-00, N26-13440-00-00 Fits: F350</p>
---	---	---	---

4-CYCLE OUTBOARD OIL FILTERS



18-8700

OIL FILTER

Replaces: 5GH-13440-50-00, 5GH-13440-20, 5JW-13400-00-00, 2MB-E3440-00-00, 1WD-E3440-00-00

Fits: F15(2006-12), F20(2006-12), F25(2009-12), F40(2008-12), F50(2005-12), F60(2005*-12), F70(2010-12), T25(2009-12), T50(2005-12), T60(2005-12)



Make-Model	Years	Replaces	Part No.
F/T9.9	1990-03	6G8-13440-00-00	18-7901
F/T50	1995-99	3FV-13440-20-00, 3FV-13440-00-00	18-7902
F15,F25	1998-99	3FV-13440-20-00, 3FV-13440-00-00	18-7902
F80/F100	1999	3FV-13440-20-00, 3FV-13440-00-00	18-7902
F40	1999-00	3FV-13440-20-00, 3FV-13440-00-00	18-7902
F200/F225	2002-06	69J-13440-00-00, -01-00, -03-00	18-7906-1
F150	2004-06	69J-13440-00-00, -01-00, -03-00	18-7906-1
F250	2005-06	69J-13440-00-00, -01-00, -03-00	18-7906-1
F350	2008-up	N26-13440-02-00, N26-13440-00-00	18-7954



18-9390

OIL CHANGE KIT

Replaces: LUB-MRNSM-KT-10

Fits: F30(2001-06), F40(1999-08), F40A(2009 & Up), F50(1995 & Up), T50(1996 & Up), F60(2002 & Up), T60(2003 & Up), F70(2010 & Up)



18-9391

OIL CHANGE KIT

Replaces: LUB-MRNMD-KT-10

Fits: F75(2003 & Up), F80(1999-02), F90(2003 & Up), F100(1999-02), F115(2000 & Up)



18-9392

OIL CHANGE KIT

Replaces: LUB-MRNMD-KT-10

Fits: F150(2004 & Up)



18-9393

OIL CHANGE KIT

Replaces: LUB-MRNLG-KT-10

Fits: F200 3.3L(2002 & Up), F225 3.3L(2002 & Up), F225 Sport(2008), F250A 3.3L(2005 & Up), F250B 3.3L(2005 & Up)

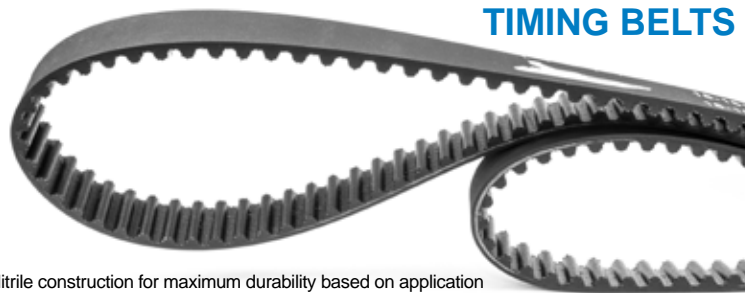

TIMING BELTS

FEATURES:

- Neoprene or Nitrile construction for maximum durability based on application
- Positive Slip Proof engagement
- Fiberglass tension member for excellent flex and elongation behavior
- Chemical and Contaminant Resistance for Long Life
- Meets or Exceeds OEM belt specifications
- Modified Curvilinear or Trapezoidal tooth profile for direct OE fitment/replacement
- Recommended periodic maintenance interval of 5 years or 1000 hours of use (Note: Timing belt should be inspected every 100 hours and replaced as necessary.)
- Inexpensive insurance to prevent catastrophic engine failure

Sierra Timing Belts provide extended durability and smoother performance characteristics required by today's marine engines.

Part No.	Replaces	Fits
18-15130	6C5-46241-00-00	Fits: F25 (2009-2017), T25 2009-2017), F30 (2013-2017), F40 (2008-2017), F50 (2005-2017), T50 (2005-2010), F60 (2005-2017), T60 (2005-2017), F70 (2010-2017)
18-15131	67F-46241-00-00	Fits: F75 (2003-2011), F80 (1999-2003), F90 (2005-2015), F100 (1999-2003), F115 (2000-2014), LF115 (2000-2014)
18-15132	6P2-46241-02-00	Fits: F200 (2011-2017), LF200 (2011-2017), F225 (2007-2017), F250 (2005-2017), LF250 (2005-2017)
18-15133	6G8-46241-00-00	Fits: F9.9 (1985-2005), FT9.9 (1985-1990), T9.9 (1991-2005)
18-15134	6CB-W4624-00-00	Fits: F225 (2010-2017), LF225 (2010-2017), F250 (2010-2017), FL250 (2010), LF250 (2010-2017), F300 (2010-2017), FL300 (2010), LF300 (2010-2017), VF200 (2009-2017), VF225 (2009-2017), VF250 (2009-2017)
18-15135	65W-46241-00-00	Fits: F25 (1998-2005), T25 (2001-2005), F30 (2001-2005), F40 (2000-2008)
18-15136	6AH-46241-00-00	Fits: F15 (2006-2017), F20 (2006-2017)
18-15137	66M-46241-00-00	Fits: F9.9 (2005-2006), F15 (1998-2005)
18-15138	68T-46241-00-00	Fits: F6 (2001-2008), T8 (2001-2010), F8 (2001-2017), F9.9 (2007-2017), T9.9 (2007-2017)
18-15139 <small>NEW</small>	6AW-W4624-00-00	F300/LF300 (5.3L) (2007-09), F350/LF350 (5.3L) (2007-09), F350A/LF350A (5.3L) (2010-11), F350/LF350 (5.3L) (2012-15), F350C/LF350C (2016-18)
18-15140 <small>NEW</small>	63P-46241-00-00	F150/LF150 (2004-11), F150/LF150 (2012-14), F150B/LF150B (2015-18)
18-15141 <small>NEW</small>	69J-46241-00-00	F200/LF200 (2002-10), F225/LF225 (2002-10)
18-15142 <small>NEW</small>	6DA-W4624-00-00	F150C/LF150C (2017-18), VF150 (2013-17), VF150A (2018)
18-15143 <small>NEW</small>	60V-46241-00-00	VZ200 (2005-09), VZ225 (2005-09), VZ250 (2005-09), Z250/LZ250 (2003-05), VZ300 (2005-09), Z300/LZ300 (2004-06)
18-15144 <small>NEW</small>	62Y-46241-00-00	F40 (1999), F50 (1995-03), T50 (1996-04), F60 (2002-04), T60 (2003-04)
18-15145 <small>NEW</small>	68F-46241-10-00	VZ150 (2004-14), Z150/LZ150 (2004-05)

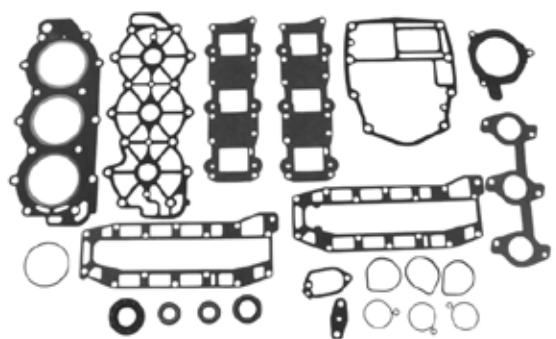

18-99061
GASKET SET
 Replaces: 63D-W0001-00
 Fits: 40(1995-05), 50(1995-069), C40(1997-02),
 C50(1998-01), P40(1998), P50(1995-96)



18-99073
GASKET SET
 Replaces: 65W-W0001-20
 Fits: F25(1998-00)

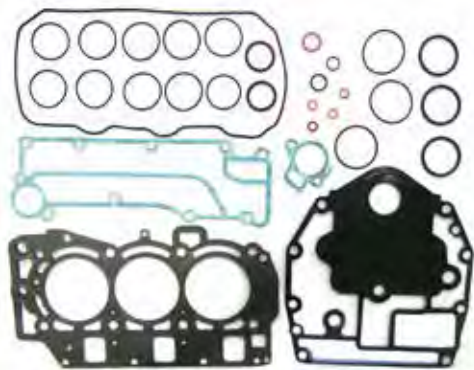

18-99092
GASKET SET
 Replaces: 67C-W0001-00
 Fits: F30(2001), F40(2000-01)



18-99093
GASKET SET
 Replaces: 67C-W0001-20
 Fits: F30(2001), F40(2000-01), T25(2001)



18-99097
GASKET SET
 Replaces: 682-W0001-06
 Fits: 9.9(1994-95), 15(1994-95)



18-99103
GASKET SET
 Replaces: 68F-W0001-01
 Fits: LZ150(2004-05), LZ200(2004-10), VZ150(2004-10),
 VZ175(2004-10), VZ200(2004), Z150(2004-05), Z175(2004-05),
 Z200(2004-10)



18-99104
GASKET SET
 Replaces: 6A0-W0001-21
 Fits: C40(1992-94)

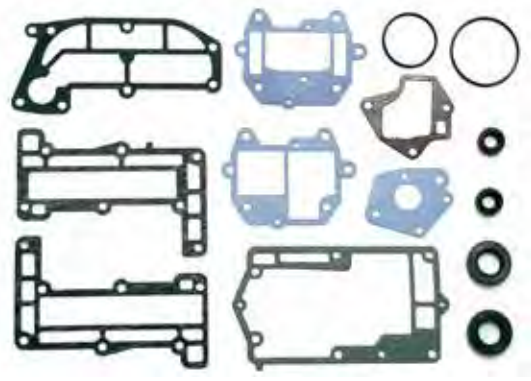

18-99117
GASKET SET
 Replaces: 6G1-W0001-A2
 Fits: 6(1996), 8(1996)

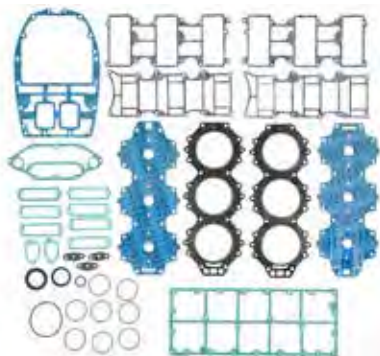

18-4400
POWERHEAD GASKET SET

Replaces: 61A-W0001-01-00, 61A-W0001-A1-00
— CONTAINS—

Part #	Desc.	O.E. #	Qty.
18-3891	Head Gasket	61A-11181-00-A0	2
18-0829	O-Ring	61A-12414-A0-00, 6J8-12414-A0-00	2
18-0808	Pressure Control Valve Gasket	6G5-11382-A1-00	1

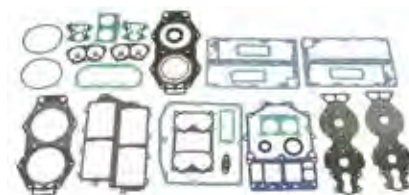

18-4403
POWERHEAD GASKET SET

Replaces: 6F3-W0001-04-00, 6F3-W0001-A4-00
— CONTAINS—

Part #	Desc.	O.E. #	Qty.
18-3832	Head Gasket	6E5-11181-02-00	2
18-0844	Thermostat Cover Gasket	688-12414-A1-00	2
18-2079	Oil Seal	93101-22M15-00	1
18-2085	Oil Seal	93102-35M13-00	1
18-7442	O-Ring	93210-74M35-00	1
18-7444	O-Ring	93211-04384-00	2
18-0782	Cover Gasket	6E5-11381-A1-00	1
18-0799	Exhaust Cover Gasket	6E5-41112-A1-00	2
18-0823	Exhaust Manifold Gasket	6E5-13645-A1-00	1
18-0785	Carb Mounting Gasket	6E5-14198-A1-00	2
18-0813	Powerhead Base Gasket	6G5-45113-A0-00	1
18-2592	Float Bowl Gasket	6E5-14384-03-00	2
18-0781	Water Jacket Gasket	6E5-11193-A0-00	2

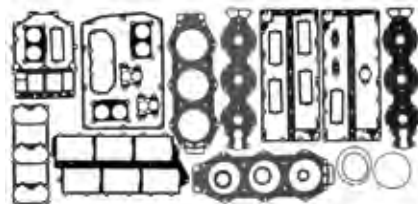

18-4404
POWERHEAD GASKET SET

Replaces: 6G5-W0001-03-00, 6G5-W0001-A3-00
— CONTAINS—

Part #	Desc.	O.E. #	Qty.
18-3894	Head Gasket	6G5-11181-A0-00	2
18-0844	Thermostat Cover Gasket	688-12414-A1-00	2
18-2079	Oil Seal	93101-22M15-00	1
18-2085	Oil Seal	93102-35M13-00	1
18-7442	O-Ring	93210-74M35-00	1
18-7444	O-Ring	93211-04384-00	2
18-0785	Carb Mounting Gasket	6E5-14198-A1-00	3
18-0808	Pressure Control Valve Gasket	6G5-11382-A1-00	1
18-0813	Powerhead Base Gasket	6G5-45113-A0-00	1
18-0782	Cover Gasket	6E5-11381-A1-00	1
18-0809	Reed Block Gasket	6G5-13645-A1-00	1
18-0812	Exhaust Cover Gasket	6G5-41112-A1-00	2
18-0779	Water Jacket Gasket	6G5-11193-A0-00	2

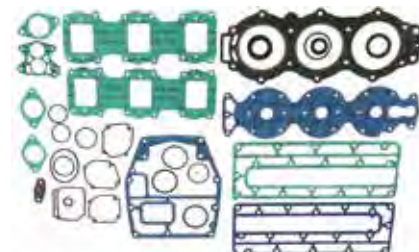

18-4405
POWERHEAD GASKET SET

Replaces: 6H1-W0001-00-00, 6H1-W0001-01-00, 6H1-W0001-A0-00
— CONTAINS—

Part #	Desc.	O.E. #	Qty.
18-3805	Head Gasket	688-11181-02-00	1
18-0840-1	O-Ring	676-14984-00-00	3
18-0844	Thermostat Cover Gasket	688-12414-A1-00	1
18-0847	Exhaust Cover Gasket	688-41112-A0-00	1
18-0826	Drain Screw Gasket	90430-14115-00	1
18-7436	O-Ring	93210-48044-00	3
18-0767	Water Jacket Cover Gasket	688-11193-01-00	1

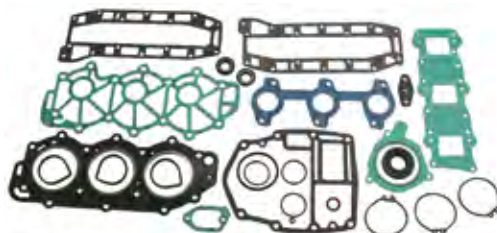

18-4407
POWERHEAD GASKET SET

Replaces: 6H4-W0001-01-00, 6H4-W0001-A1-00
— CONTAINS—

Part #	Desc.	O.E. #	Qty.
18-3830	Head Gasket	6H4-11181-00-00	1
18-0826	Drain Screw Gasket	90430-14115-00	1
18-0815	Water Jacket Gasket	6H4-11193-A1-00	1
18-0798	Exhaust Cover Gasket	6H4-41114-A0-00	1
18-0829	Cover Gasket	61A-12414-A0-00, 6J8-12414-A0-00	1



18-4409
POWERHEAD GASKET SET

Replaces: 6H4-W0001-03-00, 6H4-W0001-04-00
— CONTAINS—

Part #	Desc.	O.E.#	Qty.
18-3830	Head Gasket	6H4-11181-00-00	1
18-0826	Drain Screw Gasket	90430-14115-00	1
18-7432	O-Ring	93210-32768-00	1
18-0815	Water Jacket Gasket	6H4-11193-A1-00	1
18-0798	Exhaust Cover Gasket	6H4-41114-A0-00	1
18-0829	Cover Gasket	61A-12414-A0-00, 6J8-12414-A0-00	1

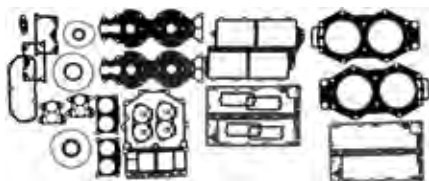

18-4411
POWERHEAD GASKET SET

Replaces: 6N6-W0001-03-00, 6N6-W0001-A3-00
— CONTAINS—

Part #	Desc.	O.E. #	Qty.
18-3832	Head Gasket	6E5-11181-02-00	2
18-0844	Thermostat Cover Gasket	688-12414-A1-00	2
18-2079	Oil Seal	93101-22M18-00	1
18-2085	Oil Seal	93102-35M13-00	1
18-7442	O-Ring	93210-74M35-00	1
18-7444	O-Ring	93211-04384-00	2
18-0782	Cover Gasket	6E5-11381-A1-00	1
18-0799	Exhaust Cover Gasket	6E5-41112-A1-00	2
18-0823	Exhaust Manifold Gasket	6E5-13645-A1-00	1
18-0785	Carb Mounting Gasket	6E5-14198-A1-00	2
18-0813	Powerhead Base Gasket	6G5-45113-A0-00	1
18-2592	Float Bowl Gasket	6E5-14384-03-00	2
18-0781	Water Jacket Gasket	6E5-11193-A0-00	2

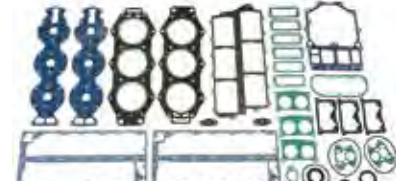

18-4412
POWERHEAD GASKET SET

Replaces: 6R3-W0001-03-00, 6R3-W0001-A3-00
— CONTAINS—

Part #	Desc.	O.E. #	Qty.
18-3894	Head Gasket	6G5-11181-A0-00	2
18-0844	Thermostat Cover Gasket	688-12414-A1-00	2
18-2079	Oil Seal	93101-22M18-00	1
18-2085	Oil Seal	93102-35M13-00	1
18-7442	O-Ring	93210-74M35-00	1
18-7444	O-Ring	93211-04384-00	2
18-0782	Cover Gasket	6E5-11381-A1-00	1
18-0809	Reed Block Gasket	6G5-13645-A1-00	1
18-0812	Exhaust Cover Gasket	6G5-41112-A1-00	2
18-0779	Water Jacket Gasket	6G5-11193-A0-00	2
18-0785	Carb Mounting Gasket	6E5-14198-A1-00	3
18-0808	Pressure Control Valve Gasket	6G5-11382-A1-00	1
18-0816	Powerhead Base Gasket	6G5-45113-A0-00	1

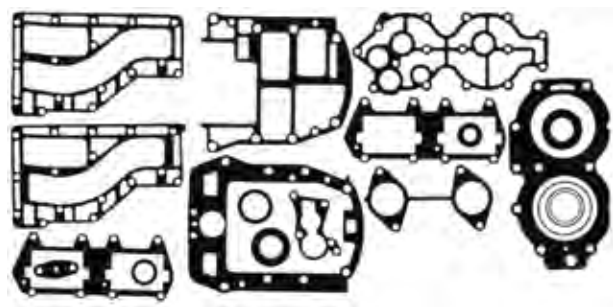

18-4413
POWERHEAD GASKET SET
Replaces: 6R6-W0001-01-00

— CONTAINS —

Part #	Desc.	O.E. #	Qty.
18-3892	Head Gasket	676-11181-00-A0	1
18-7126	O-Ring	—	1

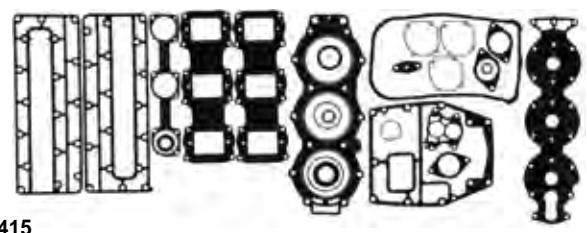

18-4415
POWERHEAD GASKET SET

Replaces: 688-W0001-00-00, 688-W0001-A0-00
— CONTAINS —

18-0840	Fuel Bowl Seal	676-14984-00-00	3
18-3805	Head Gasket	688-11181-02-00	1
18-0844	Thermostat Cover Gasket	688-12414-A1-00	1
18-0846	Carburetor Mounting Gasket	688-14198-A1-00	3
18-0847	Exhaust Cover Gasket	688-41112-A0-00	2
18-0826	Drain Screw Gasket	90430-14115-00-00	1
18-0767	Water Jacket Cover Gasket	688-11193-01-00	1
18-0845	Intake Manifold Reed Plate Gasket	688-13621-A1-00	2
18-7441	O-Ring	93210-62269-00	1

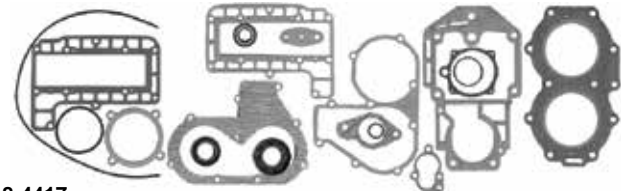

18-4417
POWERHEAD GASKET SET

Replaces: 695-W0001-01-00, 695-W0001-02-00, 695-W0001-A2-00
— CONTAINS —

Part #	Desc.	O.E. #	Qty.
18-0231	Packing Gasket	648-13621-A1-00	1
18-0771	Intake Manifold Gasket	648-13645-A0-00	1
18-0775	Carburetor Mounting Gasket	648-14198-A0-00	1
NSS	Bowl Gasket	648-14384-01-00	1
18-0232	Cover Gasket	655-12414-A1-00	1
18-0250	Exhaust Cover Gasket	664-41114-A0-00	2
18-2078	Oil Seal	93101-16M36-00	1
18-0570	Oil Seal	93102-23096-00	1
18-3849	Head Gasket	695-11181-A0-00	1
18-0739	Upper Casing Gasket	689-45113-A1-00	1

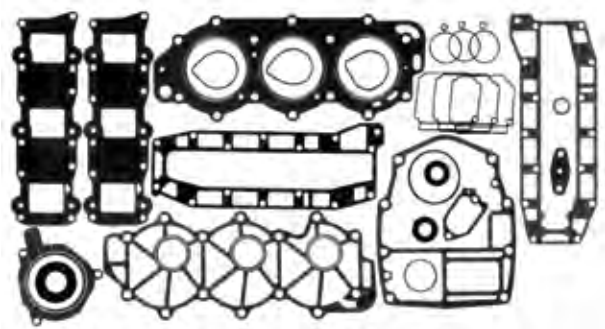

18-4419
POWERHEAD GASKET SET

Replaces: 6H4-W0001-02-00, 6H4-W0001-A2-00
— CONTAINS —

Part #	Desc.	O.E. #	Qty.
18-3830	Head Gasket	6H4-11181-00-00	1
18-0826	Drain Screw Gasket	90430-14115-00-00	1

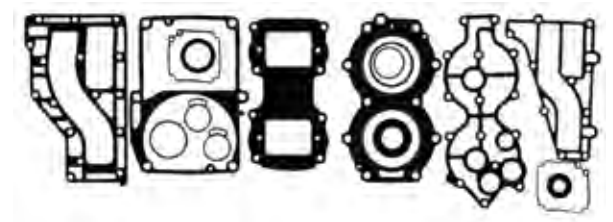

18-4422
POWERHEAD GASKET SET

Replaces: 6L2-W0001-01-00, 6L2-W0001-02-00, 6L2-W0001-A2-00
— CONTAINS —

Part #	Desc.	O.E. #	Qty.
18-3847	Head Gasket	6L2-11181-A1-00	1
18-0765	Flat Chamber Gasket	6L2-14384-00-00	1
18-0743	Exhaust Inner Cover Gasket	6L2-41112-A1-00	1
18-0744	Exhaust Outer Cover Gasket	6L2-41114-A1-00	1
18-0748	Upper Casing Gasket	6L2-45113-A1-00	1



18-99175
POWERHEAD GASKET SET

Replaces: 63V-W0001-00, 63V-W0001-01
Fits: 9.9(1996-00), 15(1996-00)

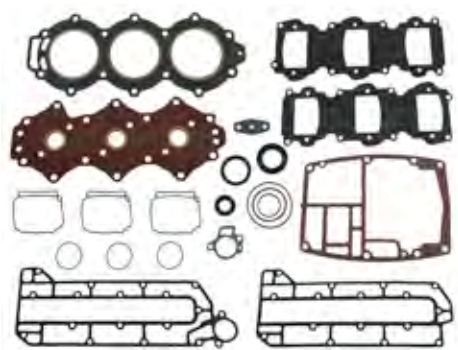

18-99176
POWERHEAD GASKET SET

Replaces: 6H3-W0001-02
Fits: 60(2001-05), 70(1994-09), C70(2000-01), P60(1994-99)





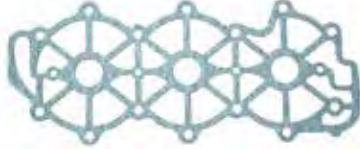

18-4427
POWERHEAD GASKET SET

Replaces: 6H3-W0001-A0-00

 <p>18-0663 PLENUM GASKET KIT Fits: Yamaha F75 (2003-04), F80 (1999-03), F90 (2003-04), F100 (1999-02)</p>	 <p>18-99048 HEAD GASKET Replaces: 60V-11181-00 Fits: LZ250(2003-05), VZ200(2005-09), VZ225(2003-09), VZ250(2003-09), Z250(2003-05)</p>	 <p>18-99059 HEAD GASKET Replaces: 63D-11193-A0 Fits: 40(1995-05), 50(1995-09), C40(1997-03), C50(1998-01), P40(1998), P50(1995-96)</p>
---	---	--

 <p>18-99060 HEAD GASKET Replaces: 63D-11181-A1 Fits: 40(1997-05), 50(1997-08), C40(1997-03), C50(1998-01), P40(1998)</p>	 <p>18-99062 HEAD GASKET Replaces: 68F-11181-00 Fits: LZ150(2000-05), LZ200(2000-10), VZ150(2000-10), VZ175(2001-10), VZ200(2001-04), Z150(2000-05), Z175(2001-05), Z200(2000-10)</p>	 <p>18-99094 HEAD GASKET Replaces: 67F-11181-02 Fits: F75(2004-05), F90(2004-05), F115(2004-05), LF115(2004-05)</p>	 <p>18-3804 HEAD GASKET Replaces: 689-11181-02-00, 689-W0001-A1-00</p>
--	--	---	---

 <p>18-3805 HEAD GASKET Replaces: 688-11181-02-00, 688-11181-A1-00</p>	 <p>18-3827 HEAD GASKET Replaces: 6G8-11181-00-00, 6G8-11181-A1-00</p>	 <p>18-3828 HEAD GASKET Replaces: 6E7-11181-00-00, 6E7-11181-A1-00</p>	 <p>18-3829 HEAD GASKET Replaces: 6J8-11181-00-00, 6J8-11181-A1-001</p>
---	---	--	--

 <p>18-3830 HEAD GASKET Replaces: 6H4-11181-00-00, 6H4-11181-A1-00</p>	 <p>18-3831 HEAD GASKET Replaces: 6H3-11181-01-00, 6H3-11181-A1-00</p>	 <p>18-3832 HEAD GASKET Replaces: 6E5-11181-02-00, 6E5-11181-A1-00</p>
---	--	---

 <p>18-3847 HEAD GASKET Replaces: 6L2-11181-A1-00, 6L2-11181-A2-00</p>	 <p>18-3848 HEAD GASKET Replaces: 697-11181-A0-00, 697-11181-A1-00</p>	 <p>18-3849 HEAD GASKET Replaces: 695-11181-A0-00, 695-11181-A1-00</p>
---	--	---

 <p>18-3891 HEAD GASKET Replaces: 61A-11181-A0-00, 61A-11181-A1-00</p>	 <p>18-3892 HEAD GASKET Replaces: 676-11181-A0-00, 676-11181-A1-00</p>	 <p>18-3894 HEAD GASKET Replaces: 6G5-11181-00-00, 6G5-11181-A0-00</p>
---	--	---

SEE PAGES 201-202 FOR OUR COMPLETE LINE OF GASKET SEALANTS
APPLICATION BEGINS ON NEXT PAGE

POWERHEAD GASKET SETS / HEAD GASKETS APPLICATION

HP	Year	Powerhead Gasket Set	Head Gasket	HP	Year	Powerhead Gasket Set	Head Gasket
6	1988-96	18-99117		F80	1999-01		18-99094
8	1984-96	18-99117		F80	2002-03		18-99094
9.9	1984-87		18-3828	C85	1991	18-4415	18-3805
9.9	1988-91		18-3828	C85	1992-93		18-3805
9.9	1992-93		18-3828	C85	1994-96		18-3805
9.9	1994-95		18-3828	CV85	1989-90	18-4415	18-3805
9.9	1996	18-99175		90	1984-93	18-4405	18-3805
9.9	1997-00	18-99175	18-99140	90	1994-09		18-3805
9.9	2001-08		18-99140	B90	1997-99		18-3805
F9.9	1986-89		18-3827	C90	1997-01		18-3805
F9.9	1990-05		18-3827	F90	2003-04		18-99094
FT9.9	1985-87		18-3827	F90	2005-11		18-99094
FT9.9	1988-89		18-3827	F100	1999-01		18-99094
FT9.9	1990		18-3827	F100	2002-03		18-99094
T9.9	1991-05		18-3827	115	1984		18-3832
15	1984-87		18-3828	115	1985		18-3832
15	1988-91		18-3828	115	1986 ¹		18-3832
15	1992-93		18-3828	115	1986-89 ²	18-4403	18-3832
15	1994-95	18-99097		115	1990-99	18-4411	18-3832
15	1996	18-99175		115	2000-01		18-3832
15	1997-00	18-99175	18-99140	115	2002-09		18-3832
15	2001-08		18-99140	B115	1998-99		18-3832
20	1996-97		18-3847	C115	1991-95	18-4403	18-3832
25 (2 cyl)	1984-87		18-3804	C115	1996-99		18-3832
25 (2 cyl)	1988-93	18-4422	18-3847	C115	2000		18-3832
25 (2 cyl)	1994-09		18-3847	F115	2000-01		18-99094
25 (3 cyl)	1997-02		18-3829	F115	2002-05		18-99094
C25	1991-93	18-4417	18-3849	F115	2006-11		18-99094
C25	1994-97		18-3849	LF115	2000-01		18-99094
CV25	1990	18-4417	18-3849	LF115	2002-05		18-99094
F25	1998-01	18-99073		LF115	2006-11		18-99094
30	1984-86		18-3804	P115	1993-96	18-4411	18-3832
30	1987-94		18-3829	S115	1996-99	18-4411	18-3832
30	1993-02		18-3829	130	1988-99	18-4403	18-3832
C30	1991-92		18-3804	130	2000-01		18-3832
C30	1995-97		18-3829	130	2002-04		18-3832
CV30	1989-90		18-3804	L130	1989	18-4403	18-3832
F30	2000	18-99093		L130	1990-99	18-4411	18-3832
F30	2001-05	18-99092		L130	2000-01		18-3832
40	1984-88	18-4407	18-3830	S130	1996-99	18-4411	18-3832
40	1989-91	18-4419	18-3830	150	1984-89	18-4404	18-3894
40	1992-94	18-4409	18-3830	150	1990-95	18-4412	18-3894
40	1995-05	18-99061	18-99060	150	1996-03		18-3894
C40 2 Cyl	1991		18-3892	150	2004-09		18-3894
C40 2 Cyl	1992-93	18-4413	18-3892	C150	1996-99	18-4404	18-3894
C40 2 Cyl	1994-97	18-4414	18-3892	D150	1997-99		18-3894
C40 3 Cyl	1998-03	18-99061	18-99060	DX150	1999-03		18-3894
CV40	1990		18-3892	DX150	2004-05		18-3894
F40	2000-08	18-99092		L150	1986-89	18-4404	18-3894
P40	1998	18-99061	18-99060	L150	1990-95	18-4412	18-3894
50	1984-88	18-4407	18-3830	L150	1996-99		18-3894
50	1989-91	18-4419	18-3830	LX150	1999-01		18-3894
50	1992-94	18-4419	18-3830	LZ150	2000-03		18-99062
50	1995-09	18-99061	18-99060	LZ150	2004-05	18-99103	18-99062
C50	1998-01	18-99061	18-99060	Z150	2000-03		18-99062
PRO 50	1987-88	18-4407	18-3830	Z150	2004-05	18-99103	18-99062
PRO 50	1989-90	18-4419	18-3830	P150	1991-93	18-4412	18-3894
P50	1991	18-4419	18-3830	P150	1994-95		18-3894
P50	1992-94	18-4409	18-3830	P150	1996-99		18-3894
P50	1995-96	18-99061	18-99060	PX150	1999		18-3894
C55	1991		18-3848	PRO V150	1987-89	18-4404	18-3894
C55	1992-93		18-3848	PRO V150	1990	18-4412	18-3894
C55	1994-95		18-3848	S150	1996-99		18-3894
CV55	1989-90		18-3848	SX150	1999-03		18-3894
60	2001-05	18-99176	18-3831	SX150	2004		18-3894
C60	1996-01		18-3831	V150	2000-03		18-3894
E60	1995-00		18-3831	V150	2004-08		18-3894
P60	1991	18-4427	18-3831	VX150	2000-03		18-3894
P60	1992-93		18-3831	VX150	2004		18-3894
P60	1994-99	18-99176	18-3831	VZ150	2000-03		18-99062
70	1984-91	18-4427	18-3831	VZ150	2004-11	18-99103	18-99062
70	1992-93		18-3831	175	1984-89	18-4404	18-3894
70	1994-09	18-99176	18-3831	175	1990-95	18-4412	18-3894
C70	2000-01	18-99176	18-3831	175	2000		18-3894
C75	1994-96		18-3805	P175	1996-99		18-3894
C75	1998-99		18-3805	S175	1996-99		18-3894
E75	1995-00		18-3805	V175	2000		18-3894
F75	2003-04		18-99094	VZ175	2001-02		18-99062
F75	2005, 2007-11		18-99094	VZ175	2003-11	18-99103	18-99062
F75	2006		18-99094	Z175	2001-03		18-99062
P75	1996-99		18-3805	Z175	2004-05	18-99103	18-99062
C80	1997		18-3805	200	1984-89	18-4404	18-3894

① LJ:-357803/XJ:-700843
 ② LJ: 357804/XJ: 700844

③ 2.6 litre engine
 ④ 3.1 litre engine

HP	Year	Powerhead Gasket Set	Head Gasket	HP	Year	Powerhead Gasket Set	Head Gasket
200	1990-95	18-4412	18-3894	L225 ④	1994-96	18-4400	18-3891
200	1996-98		18-3894	L225	1997-99		18-3891
L200	1986-89	18-4404	18-3894	S225	1996	18-4400	18-3891
L200	1990-95	18-4412	18-3894	S225	1997-99		18-3891
L200	1996-99		18-3894	LX225	2000-03		18-3891
LX200	1999-01		18-3894	SX225	2000-03		18-3891
LZ200	2000-03		18-99062	V225	1998-99		18-3891
LZ200	2004-11	18-99103	18-99062	VX225	2000-04		18-3891
P200	1991-95		18-3894	VZ225	2003-04		18-99048
P200	1996-99		18-3894	VZ225	2005-09		18-99048
S200	1996-99		18-3894	250	1990-95	18-4400	18-3891
SX200	1999-03		18-3894	L250	1990-96	18-4400	18-3891
SX200	2004-05		18-3894	L250	1997-99		18-3891
V200	1998-99		18-3891	LX250	2000-03		18-3891
VX200	2000-05		18-3891	LZ250	2003-04		18-99048
VZ200	2000-03		18-99062	LZ250	2005		18-99048
VZ200	2004-09	18-99103	18-99062	S250	1996	18-4400	18-3891
Z200	2000-03		18-99062	S250	1997-99		18-3891
Z200	2004-11	18-99103	18-99062	SX250	2000-03		18-3891
V6 Special	1984-86	18-4404	18-3894	VZ250	2003-04		18-99048
V6 Excel	1987-89		18-3894	VZ250	2005-09		18-99048
225 ③	1990-95		18-3894	Z250	2003-04		18-99048
225	1996-97		18-3894	Z250	2005		18-99048
225 ④	1994-95	18-4400	18-3891				

- ① LJ:-357803/XJ:-700843
- ② LJ: 357804/XJ: 700844
- ③ 2.6 litre engine
- ④ 3.1 litre engine

 <p>18-0406 WATER PUMP GASKET Replaces: 60X-43315-A0-00 Fits: VZ200 (3.3L) 2005-10, VZ225 (3.3L) 2003-10, VZ250 (3.3L) 2003-10, VZ300 (3.3L) 2005-10</p>	 <p>18-0605 EXHAUST MANIFOLD SEAL Replaces: 67F-41138-00-00 Fits: F75 2003-Current; F80 1999-2003; F90 2003-Current; F100 1999-2003; F115 2000-Current.</p>	 <p>18-0617 EXHAUST SEAL Replaces: 67F-45127-00-00 Fits: F75 2003-Current; F80 1999-2003; F90 2003-Current; F100 1999-2003; F115 2000-Current.</p>	 <p>18-0618 EXHAUST MANIFOLD GASKET Replaces: 68V-45123-00-00</p>
 <p>18-0619 EXHAUST TUBE SEAL Replaces: 69J-41138-00-00</p>	 <p>18-0656 EXHAUST TUBE SEAL Replaces: 69J-45123-00-00</p>	 <p>18-0755 CRANKCASE DRAIN GASKET Replaces: 90430-14M09-00, 90430-14228-00, 90430-14228-00 Fits: Four-Stroke 9.9hp.- 300hp. / 1999 - Current</p>	 <p>18-0849 FUEL PUMP MOUNTING GASKET Replaces: 650-24431-A0-00</p>
 <p>18-0856-1 GASKET Replaces: 64D-14384-01-00</p>	 <p>18-99000 EXHAUST MANIFOLD GASKET Replaces: 61A-41134-A0 Fits: 225(1994-95), 250(1992-95), L225 (1994-99), L250(1992-99), LX225(2000-03), LX250(2000-03), LZ250(2003-05), LZ300 (2004-05), S225(1996-99), S250(1996-99), SX225(2000-03), SX250(2000-03), V200(1998-99), V225(1998-99), VX200(2000-05), VX250 (2000-04), VZ200(2005), VZ225(2003-05), VZ250(2003-05), VZ300(2004-05), Z250(2003-05), Z300(2004-05)</p>	 <p>18-99001 UPPER CASING GASKET Replaces: 61A-45114-A0 Fits: 225(1994-95), 250(1992-95), L225 (1994-99), L250(1992-99), LX225(2000-03), LX250(2000-03), S225(1996-99), S250 (1996-99), SX225(2000-03), SX250 (2000-03), V200(1998-99), V225(1998-99), VX200(2000-05), VX225(2000-04), VX250(2002-04)</p>	 <p>18-99002 EXHAUST MANIFOLD GASKET Replaces: 62Y-41133-00 Fits: F25(1998-00), F40(1999), F50(1995-00), T50(1996-00)</p>
 <p>18-99003 EXHAUST GASKET Replaces: 62Y-41134-01 Fits: F30(2002-05), F40(2002-08), F50(2002-04), F60(2002-04), T25(2002-05), T50(2002-04)</p>	 <p>18-99004 UPPER CASING GASKET Replaces: 63D-45114-A0 Fits: 40(1995-05), 50(1995-09), C40(1997-03), C50(1998-01), P40(1998), P50(1995-96)</p>	 <p>18-99005 MUFFLER GASKET Replaces: 63D-45123-00 Fits: 40(1995-05), 50(1995-09), C40(1997-03), C50(1998-01), P40(1998), P50(1995-96)</p>	 <p>18-99006 EXHAUST MANIFOLD GASKET Replaces: 63V-41133-A1 Fits: 9.9(1997-09), 15(1997-09)</p>



18-99008
EXHAUST
MANIFOLD GASKET

Replaces: 64J-41133-10
Fits: F40(2008-10), F60(2002-04), T25(2009-10), T60(2003-04)



18-99009
MUFFLER GASKET

Replaces: 663-45123-00
Fits: (1985-94), (1984-94), C55(1991-95), CV55(1989-90), E48(1995-00), F40(1999), F50(1995-04), P50(1991-94), PR50(1989), PRO 50(1987-90), T50(1996-04)

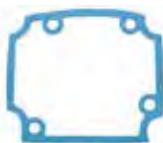

18-99010
EXHAUST
MANIFOLD GASKET

Replaces: 664-41134-A0
Fits: C25(1992-97), C30(1992-97)



18-99012
EXHAUST
MANIFOLD GASKET

Replaces: 66M-41133-00
Fits: F15(1998-04)

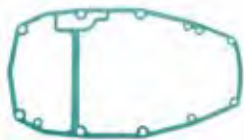

18-99013
UPPER
CASING GASKET

Replaces: 66M-45113-00
Fits: F9.9(2005-06), F15(1998-05), T9.9(2005-06)



18-99014
EXHAUST
MANIFOLD GASKET

Replaces: 676-41133-A0
Fits: C40(1992-97)



18-99015
UPPER
CASING GASKET

Replaces: 676-45114-A0
Fits: C40(1991-97), CV40(1990)



18-99016
EXHAUST
MANIFOLD GASKET

Replaces: 67C-41133-00
Fits: F25(2001-05, 2009-10), F30(2001-05), F40(2000-08), F50(2001-04), T25(2005-06)



18-99017
MUFFLER GASKET

Replaces: 67C-45123-00
Fits: F30(2001-05), F40(2000-10), F60(2002-04), T25(2001-06, 2009-10), T60(2003-04)



18-99018
EXHAUST
MANIFOLD GASKET

Replaces: 67F-41133-A1
Fits: F75(2003-10), F90(2004-10), F115(2004-10), LF115(2004-10)

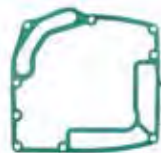

18-99019
EXHAUST
MANIFOLD GASKET

Replaces: 67F-41134-A0
Fits: F75(2003-10), F80(1999-03), F90(2003-10), F100(1999-03), F115(2000-10), LF115(2000-10)



18-99020
MUFFLER GASKET

Replaces: 67F-45123-00
Fits: F75(2003-10), F80(1999-03), F90(2003-10), F100(1999-03)



18-99021
EXHAUST
MANIFOLD GASKET

Replaces: 682-41133-A0
Fits: 9.9(1992-95), 15(1992-95)



18-99022
UPPER
CASING GASKET

Replaces: 682-45113-A1
Fits: 9.9(1984-95), 15(1984-95)



18-99023
EXHAUST
MANIFOLD GASKET

Replaces: 688-41133-00
Fits: 90(1984-09), B90(1997-99), C75(1994-96, 98-99), C80(1997), C85(1991-96), C90(1997-01), CV85(1989-90), E75(1995-00), P75(1996-99)

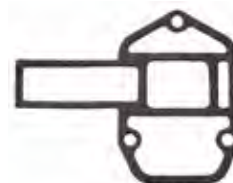

18-99024
EXHAUST
MANIFOLD GASKET

Replaces: 688-41134-A0
Fits: 90(1984-09), B90(1997-99), C75(1994-99), C80(1997), C85(1991-96), C90(1997-01), CV85(1989-90), E75(1995-00), P75(1996-99)

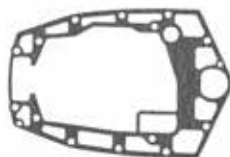

18-99025
UPPER
CASING GASKET

Replaces: 688-45114-A1
Fits: 90(1984-09), B90(1997-99), C75(1994-99), C80(1997), C85(1991-96), C90(1997-01), CV85(1989-90), E75(1995-00), P75(1996-99)



18-99026
MUFFLER GASKET

Replaces: 688-45123-00
Fits: 90(1984-09), B90(1997-99), C75(1994-99), C80(1997), C85(1991-96), C90(1997-01), CV85(1989-90), E75(1995-00), P75(1996-99)

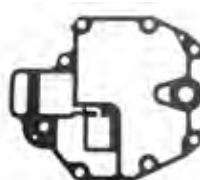

18-99027
OIL PAN GASKET

Replaces: 68T-13475-00
Fits: F6(2001-08), F8(2001-10), F9.9(2007, 2010), T8(2001-10), T9.9(2007-10)

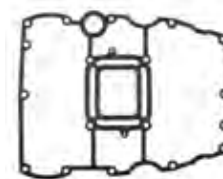

18-99028
OIL PAN GASKET

Replaces: 68V-15312-00
Fits: F75(2003-10), F90(2004-10), F115(2004-10), LF115(2004-10)



**18-99030
UPPER
CASING GASKET**
Replaces: 697-45114-A0
Fits: E48(1995-00), C55(1992-95)



**18-99032
EXHAUST
MANIFOLD GASKET**
Replaces: 69J-41134-A0
Fits: F200(2002-05), F225(2002-05), LF200(2002-05), LF225(2002-05)

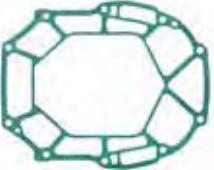

**18-99033
EXHAUST
MANIFOLD GASKET**
Replaces: 69J-41135-A0
Fits: F200(2002-10), F225(2002-10), F250(2005-10), LF200(2002-10), LF225(2002-10), LF250(2005-10)



**18-99034
EXHAUST
MANIFOLD GASKET**
Replaces: 69J-41136-A0
Fits: F200(2002-05), F225(2002-05), F250(2005), LF200(2002-05), LF225(2002-05), LF250(2005)



**18-99037
EXHAUST
MANIFOLD GASKET**
Replaces: 6E5-41134-A0
Fits: 115(1992-09), 130(1992-04), B115(1998-99), C115(1992-00), L130(1994-01), P115(1993-96), S115(1996-99), S130(1996-99)



**18-99038
EXHAUST
MANIFOLD GASKET**
Replaces: 6E5-41135-A0
Fits: 115(1992-09), 130(1992-04), 150(1992-09), 175(1992-95, 2000), 200(1992-98), 225(1992-97), B115(1998-99), C115(1992-00), C150(1996-99), D150(1997-99), DX150(1999-05), L150(1992-01), L200(1992-99), LX150(1999-01), LX200(1999-01), LZ150(2000-05), LZ200(2000-10), P115(1993-96), P150(1992-99), P175(1994-99), P200(1992-99), PX150(1999), S115(1996-99), S130(1996-99), S150(1996-99), S175(1996-99), S200(1996-99), SX150(1999-04), SX200(1999-05), V150(2000-08), V175(2000), VX150(2000-04), VZ150(2000-10), VZ175(2001-10), VZ200(2001-04), Z150(2000-05), Z175(2001-05), Z200(2000-10)



**18-99039
EXHAUST
MANIFOLD GASKET**
Replaces: 6G5-41134-A1
Fits: 115(2003-04), 130(2003-04), 150(2003-09), DX150(2003-05), LZ150(2003-05), LZ200(2003-10), SX150(2003-04), SX200(2003-05), V150(2003-08), V150(2003-05), V150(2003-08), VX150(2003-04), VZ150(2003-10), VZ175(2003-10), VZ200(2003-04), Z150(2003-05), Z175(2003-05), Z200(2003-10)



**18-99040
UPPER CASING
GASKET**
Replaces: 6G5-45114-A1
Fits: 115(2003-09), 130(2003-04), 150(2003-09), DX150(2003-05), LZ150(2003-05), LZ200(2003-10), SX150(2003-04), SX200(2003-05), V150(2003-08), VX150(2003-04), VZ150(2003-10), VZ175(2003-10), VZ200(2003-04), Z150(2003-05), Z175(2003-05), Z200(2003-10)



**18-99045
UPPER CASING GASKET**
Replaces: 6G8-45113-A1
Fits: F9.9(1997-05), T9.9(1995-05)

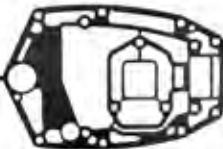

**18-99046
UPPER CASING GASKET**
Replaces: 6H3-45114-A1
Fits: 60(2002-05), 70(1984-069), C60(1996-01), C70(2001-02), E60(1995-00), P60(1991-99)



**18-99047
MUFFLER GASKET**
Replaces: 6H3-45123-00
Fits: 60(2001-05), 70(1984-09), C60(1996-01), C70(2000-01), E60(1995-00), P60(1991-99)



**18-99049
REED GASKET**
Replaces: 60V-13621-A0
Fits: LZ250(2003-05), LZ300(2004-06), VZ200(2005-09), VZ225(2003-09), VZ250(2003-09), VZ300(2004-09), Z250(2003-05), Z300(2004-06)



**18-99050
INTAKE GASKET**
Replaces: 60V-13645-00
Fits: LZ250(2003-05), LZ300(2004-06), VZ200(2005-09), VZ225(2003-09), VZ300(2004-09), Z250(2003-05), Z300(2004-06)



**18-99051
VALVE COVER GASKET**
Replaces: 61A-11193-A1
Fits: L225(1996-99), L250(1996-99), LX225(2000-03), LX250(2000-03), S225(1996-99), S250(1996-99), SX225(2000-03), SX250(2000-03), V200(1998-99), V225(1998-99), VX200(2000-05), VX225(2000-04), VX250(2000-04)



**18-99052
SIDE COVER GASKET**
Replaces: 61A-11381-A0
Fits: 225(1994-95), 250(1992-95), L225(1994-99), L250(1992-99), LX225(2000-03), LX250(2000-03), S225(1996-99), S250(1996-99), SX225(2000-03), SX250(2000-03), V200(1998-99), V225(1998-99), VX200(2000-05), VX225(2000-04), VX250(2002-04)



**18-99053
INTAKE GASKET**
Replaces: 61A-13621-A0
Fits: 225(1994-95), 250(1992-95), DX150(1999-05), L225(1994-99), L250(1992-99), LX150(1999-01), LX200(1999-01), LX225(2000-03), LX250(2000-03), LZ150(2000-05), LZ200(2000-10), PX150(1999), S225(1996-99), S250(1996-99), SX150(1999-04), SX200(1999-05), SX225(2000-03), SX250(2000-03), V200(1998-99), V225(1998-99), VX150(2000-04), VX200(2000-05), VX225(2000-04), VX250(2002-04), VZ150(2000-10), VZ175(2001-10), VZ200(2001-04), Z150(2000-05), Z175(2001-05), Z200(2000-10)



**18-99054
INTAKE GASKET**
Replaces: 61A-13645-00
Fits: 225(1994-95), 250(1990-95), L225(1994-96), L250(1990-96), S225(1996), S250(1996)



**18-99055
MANIFOLD GASKET**
Replaces: 61A-13646-00
Fits: 225(1994-95), 250(1990-95), L225(1994-96), L250(1990-96), S225(1996), S250(1996)



**18-99056
BASE GASKET**
Replaces: 61A-45113-A0
Fits: 225(1994-95), 250(1990-95), L225(1994-99), L250(1990-99), LX225(2000-03), LX250(2000-03), S225(1996-99), S250(1996-99), SX225(2000-03), SX250(2000-03), V200(1998-99), V225(1998-99), VX200(2000-05), VX225(2000-04), VX250(2002-04)



**18-99057
VALVE COVER GASKET**
Replaces: 61T-11193-A1
Fits: C30(1993-97)



**18-0242
VALVE SEAT GASKET**
Replaces: 663-13622-00-00, 663-13622-A0-00



18-99064
INTAKE GASKET

Replaces: 64E-13645-A0
Fits: 150(1996-99), 200(1996-98), 225(1996-97), D150(1997-99), L150(1996-99), L200(1996-99), P150(1996-99), P175(1996-99), P200(1996-99), S150(1996-99), S175(1996-99), V150(2000-08), V175(2000)



18-99066
INTAKE GASKET

Replaces: 65L-13645-00
Fits: DX150(1999-05), L225(1997-99), L250(1997-99), LX150(1999-01), LX200(1999-01), LX225(2000-03), LX250(2000-03), LZ150(2000-05), LZ200(2000-10), PX150(1999), S225(1997-99), S250(1997-99), SX150(1999-04), SX200(1999-05), SX200(2000-03), SX225(2000-03), SX250(2000-03), V200(1998-99), V225(1998-99), VX150(2000-04), VX200(2000-05), VX225(2000-04), VX250(2002-04), VZ150(2000-10), VZ175(2001-10), VZ200(2001-04), Z150(2000-05), Z175(2001-05), Z200(2000-10)



18-99067
INTAKE GASKET

Replaces: 65L-13646-00
Fits: DX150(1999-05), L225(1997-99), L250(1997-99), LX150(1999-01), LX200(1999-01), LX225(2000-03), LX250(2000-03), LZ150(2000-05), LZ200(2000-10), PX150(1999), S225(1997-99), S250(1997-99), SX150(1999-04), SX200(1999-05), SX200(2000-03), SX225(2000-03), SX250(2000-03), V200(1998-99), V225(1998-99), VX150(2000-04), VX200(2000-05), VX225(2000-04), VX250(2002-04), VZ150(2000-10), VZ175(2001-10), VZ200(2001-04), Z150(2000-05), Z175(2001-05), Z200(2000-10)



18-99063
LOWER CASING GASKET

Replaces: 63V-45315-A0
Fits: 9.9(1996-09), 15(1996-09), F9.9(2005-06), F15(1998-05), T9.9(2005-06)



18-99068
BREATHER COVER GASKET

Replaces: 65W-11169-00
Fits: F25(1998-01), T25(2001)



18-99069
BASE GASKET

Replaces: 65W-11351-00
Fits: F25(1998-02), T25(2001-02)

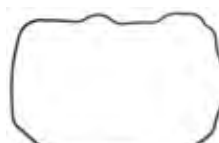

18-99070
CRANKCASE GASKET

Replaces: 65W-11356-00
Fits: F25(1998-05), T25(2001-06)



18-99071
GASKET

Replaces: 65W-14457-10
Fits: F25(1999-05), T25(2001-06)

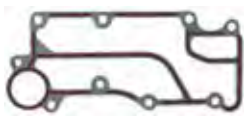

18-99072
EXHAUST GASKET

Replaces: 65W-41114-00
Fits: F25(1998-05), T25(2001-06)



18-99074
BASE GASKET

Replaces: 66M-11351-10
Fits: F9.9(2005-06), F15(2005), T9.9(2005-06)



18-99075
CYLINDER COVER GASKET

Replaces: 66M-11356-00
Fits: F9.9(2005-06), F15(1998-05), T9.9(2005-06)



18-99076
WATER PUMP GASKET

Replaces: 66M-13329-10
Fits: F9.9(2005-06), F15(2001-05), T9.9(2005-06)



18-99078
GASKET

Replaces: 66M-41138-00
Fits: F15(1998-04)



18-99079
UPPER CASING GASKET

Replaces: 66M-45115-00
Fits: F9.9(2005-06), F15(1998-05), T9.9(2005-06)



18-99080
INTAKE GASKET

Replaces: 676-13646-A0
Fits: C40(1991-97), CV40(1990)



18-99081
EXHAUST GASKET

Replaces: 676-41112-A0
Fits: C40(1991-97), CV40(1990)



18-99082
WATER PUMP GASKET

Replaces: 676-44315-A1
Fits: C40(1991-97), CV40(1990)



18-99083
WATER PUMP GASKET

Replaces: 676-44324-A0
Fits: C40(1991-97), CV40(1990)



18-99084
EXHAUST GASKET

Replaces: 676-45127-00
Fits: C40(1991-97), CV40(1990)



18-99085
EXHAUST GASKET

Replaces: 676-45128-00
Fits: C40(1991-97), CV40(1990)



18-99086
WATER PUMP GASKET

Replaces: 679-44316-A0
Fits: C40(1991-97), CV40(1990)







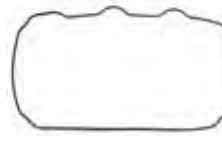







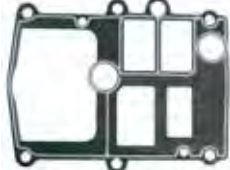





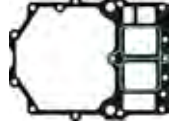

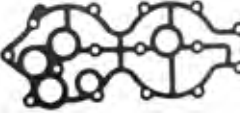



18-99087
LOWER CASING GASKET

















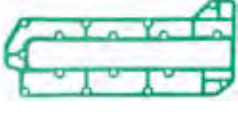
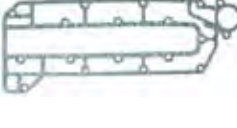





Replaces: 679-45315-A0
Fits: C40(1991-94), CV40(1990)



18-99088
CYLINDER COVER GASKET

Replaces: 67C-11356-00
Fits: F30(2001-05), F40(2000-08)

 <p>18-99089 EXHAUST GASKET Replaces: 67C-41114-00 Fits: F30(2001), F40(2000-01)</p>	 <p>18-99091 GASKET Replaces: 67C-45113-00 Fits: F25(2001), F30(2001), F40(2000-01), t25(2001)</p>	 <p>18-99095 BASE GASKET Replaces: 682-11351-A0 Fits: 9.9(1984-95), 15(1984-95)</p>	 <p>18-99096 GASKET Replaces: 682-41112-A1 Fits: 9.9(1984-95), 15(1984-95)</p>	 <p>18-60508 THERMOSTAT GASKET Replaces: 60V-12414-A0-00 Fits: Yamaha LZ250(2003-05), LZ300(2004-06), VZ200(2005-09), VZ225(2003-09), VZ250(2003-09), VZ300(2004-09), Z250(2003-05), Z300(2004-06)</p>
 <p>18-99098 INTAKE GASKET Replaces: 688-13621-A1 Fits: 90(1992-09), B90(1997-99), C75(1994-99), C80(1997), C85(1992-96), C90(1997-01), E75(1995-00), P75(1996-99)</p>	 <p>18-99099 VALVE COVER GASKET Replaces: 68F-11193-01 Fits: LZ150(2000-05), LZ200(2000-08), VZ150(2000-08), VZ175(2001-08), VZ200(2001-04), Z150(2000-05), Z175(2001-05), Z200(2000-08)</p>	 <p>18-99100 GASKET Replaces: 68F-11381-00 Fits: LZ150(2000-05), LZ200(2000-10), VZ150(2000-10), VZ175(2001-10), VZ200(2001-04), Z150(2000-05), Z175(2001-05), Z200(2000-10)</p>	 <p>18-99101 EXHAUST GASKET Replaces: 68F-41114-00 Fits: LZ150(2000-05), LZ200(2000-10), VZ150(2000-10), VZ175(2001-10), VZ200(2001-04), Z150(2000-05), Z175(2001-05), Z200(2000-10)</p>	 <p>18-99102 BASE GASKET Replaces: 68F-45113-00 Fits: 150(2004-08), DX150(2004-05), LZ150(2000-05), LZ200(2000-08), SX150(2004), SX200(2004-05), V150(2004-08), VX150(2004), VZ150(2000-08), VZ175(2001-08), VZ200(2001-04), Z150(2000-05), Z175(2001-05), Z200(2000-08)</p>
 <p>18-99105 INTAKE GASKET Replaces: 6E5-13621-A1 Fits: 115(1992-09), 130(1992-04), 150(1992-09), 175(1992-95, 2000), 200(1992-98), B115(1998-969), C115(1992-00), C150(1996-99), L130(1992-01), L150(1992-99), L200(1992-98), P115(1993-96), P150(1993), S115(1996-99), S130(1996-99), S150(1996-99), S175(1996-99), S200(1996-99)</p>	 <p>18-99106 VALVE COVER GASKET Replaces: 6E9-11193-A0 Fits: C40(1991-97), CV40(1990)</p>	 <p>18-99107 EXHAUST GASKET Replaces: 6E9-41114-A0 Fits: C40(1992-97)</p>	 <p>18-99108 VALVE COVER GASKET Replaces: 6G1-11193-A1 Fits: 6(1986-00), 8(1984-09)</p>	 <p>18-99109 REED GASKET Replaces: 6G1-13621-A1 Fits: 6(1991-00), 8(1991-09)</p>
 <p>18-99110 INTAKE GASKET Replaces: 6G1-13645-A1 Fits: 6(1991-00), 8(1991-09)</p>	 <p>18-99111 INTAKE GASKET Replaces: 6G1-14198-A1 Fits: 6(1986-00), 8(1984-09)</p>	 <p>18-99112 EXHAUST GASKET Replaces: 6G1-41112-A1 Fits: 6(1986-00), 8(1984-09)</p>	 <p>18-99113 EXHAUST GASKET Replaces: 6G1-41114-A0 Fits: 6(1991-00), 8(1991-09)</p>	 <p>18-99114 EXHAUST GASKET Replaces: 6G1-41133-A0 Fits: 6(1992-00), 8(1992-09)</p>
 <p>18-99115 BASE GASKET Replaces: 6G1-45113-A1 Fits: 6(1986-00), 8(1984-09)</p>	 <p>18-99116 WATER PUMP GASKET Replaces: 6G1-45315-A0 Fits: 6(1986-00), 8(1984-09)</p>	 <p>18-99118 CARBURETOR GASKET Replaces: 6G5-14483-A1 Fits: C150(1996-99)</p>	 <p>18-99119 BASE GASKET Replaces: 6G8-11351-A0 Fits: F9.9(1985-05), FT9.9(1985-90), T9.9(1991-05)</p>	 <p>18-99120 THERMOSTAT GASKET Replaces: 6G8-12414-A0 Fits: F6(2001-04), F8(2001-04), F9.9(1985-05, 2007, 2010), FT9.9(1985-90), T8(2001-04), T9.9(1991-05, 2007-10)</p>

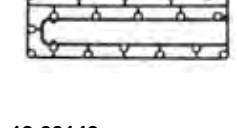
 <p>18-99121 INTAKE GASKET Replaces: 6G8-13646-A0 Fits: F9.9(1985-05), FT9.9(1985-90), T9.9(1991-05)</p>	 <p>18-99122 INTAKE GASKET Replaces: 6G8-14198-A0 Fits: F9.9(1992-05), T9.9(1992-05)</p>	 <p>18-99123 GASKET Replaces: 6G8-15374-00 Fits: F9.9(1985-05), FT9.9(1985-90), T9.9(1991-05)</p>	 <p>18-99124 THERMOSTAT GASKET Replaces: 6H3-12414-A1 Fits: 60(2001-05), 70(1984-09), C60(1996-01), C70(2000-01), E60(1995-00), P60(1991-99)</p>	 <p>18-99125 INTAKE GASKET Replaces: 6H3-13622-00 Fits: 70(1985-91), P60(1991)</p>
 <p>18-99126 INTAKE GASKET Replaces: 6H3-14198-01 Fits: 70(1984-91), P60(1991)</p>	 <p>18-99128 EXHAUST GASKET Replaces: 6H3-41114-A0 Fits: 60(2001-05), 70(1992-09), C60(1996-01), C70(2000-01), E60(1995-00), P60(1992-99)</p>	 <p>18-99129 EXHAUST GASKET Replaces: 6H3-41112-A0 Fits: 60(2001-05), 70(1986-09), C60(1996-01), C70(2000-01), E60(1995-00), P60(1991-99)</p>	 <p>18-99130 EXHAUST GASKET Replaces: 6H3-45113-A0 Fits: 60(2001-025), 70(1984-09), C60(1996-01), C70(2000-01), E60(1995-00), P60(1991-99)</p>	 <p>18-99132 REED GASKET Replaces: 6H4-13621-A1 Fits: 40(1984-05), 50(1984-09), C40(1997-03), C50(1998-01), P40(1998), P50(1991-96), PR50(1989), Pro 50(1987-90)</p>
 <p>18-99133 GASKET Replaces: 6H4-14198-01 Fits: 40(1989-05), 50(1989-09), C40(1997-03), C50(1998-01), P40(1998), P50(1991-96), PR50(1989), Pro 50(1989-90)</p>	 <p>18-99134 END CAP GASKET Replaces: 6H4-15369-A1 Fits: 40(1984-01), 50(1984-09), C40(1997-03), C50(1998-01), P40(1998), P50(1991-96), PR50(1989), Pro 50(1987-90)</p>	 <p>18-99135 EXHAUST GASKET Replaces: 6H4-41112-A0 Fits: 40(1992-05), 50(1992-09), C40(1997-03), C50(1998-01), P40(1998), P50(1992-96)</p>	 <p>18-99136 INTAKE GASKET Replaces: 6K7-13646-A1 Fits: 225(1990-95), P150(1994-95), P175(1994-95), P200(1992-95), V6 Excel(1987-89)</p>	 <p>18-99137 EXHAUST GASKET Replaces: 6L2-41133-A2 Fits: 25(2004-08)</p>
 <p>18-99138 WATER PUMP GASKET Replaces: 6L2-45315-A0 Fits: 20(1996-97), 25(1992-09)</p>	 <p>18-99139 INTAKE GASKET Replaces: 6OV-13646-00 Fits: LZ250(2003-05), LZ300(2004-06), VZ200(2005-09), VZ225(2003-09), VZ250(2003-09), VZ300(2004-09), Z250(2003-05), Z300(2004-06)</p>	 <p>18-99140 HEAD GASKET Replaces: 63V-11181-A1, 63V-11181-A2 Fits: 9.9(1997-08), 15(1997-08)</p>	 <p>18-99141 COVER GASKET Replaces: 6H3-11193-A1 Fits: 60(2001-05), 70(1984-09), C60(1996-01), C70(2000-01), E60(1995-00), P60(1991-99)</p>	 <p>18-99142 THERMOSTAT GASKET Replaces: 6E9-12414-A0, 6E9-12414-A1 Fits: C40(1992-97)</p>
 <p>18-99143 VALVE SEAL GASKET Replaces: 6H3-13621-A1 Fits: 60(2001-05), 70(1992-09), C60(1996-01), C70(2000-01), E60(1995-00), P60(1992-99)</p>	 <p>18-99144 MIXING COVER GASKET Replaces: 6E7-14227-00 Fits: 9.9(1984-95), 15(1984-95)</p>	 <p>18-99145 CARBURETOR GASKET Replaces: 677-14198-00, 677-14198-A1 Fits: 9.9(1984-91), 15(1984-91)</p>	 <p>18-99147 FUEL PUMP GASKET Replaces: 6G1-24431-01 Fits: 3(1990-02), 6(1990-00), 8(1990-09), 9.9(1996-09), 15(1996-09)</p>	 <p>18-99148 OUTER EXHAUST COVER GASKET Replaces: 688-41114-A0 Fits: 90(1992-09), B90(1998-99), C75(1994-99), C80(1997), C85(1992-96), C90(1997-01), E75(1995-00), P75(1996-99)</p>

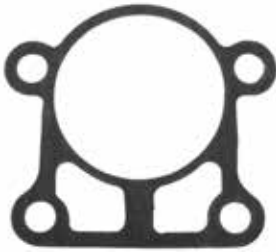

18-99149
WATER PUMP GASKET

Replaces: 663-44316-A0
Fits: 25(1997-02), 30(1992-01), 40(1992-94), 50(1992-94), C30(1995), C55(1992-95), E48(1995-00), P50(1992-94)

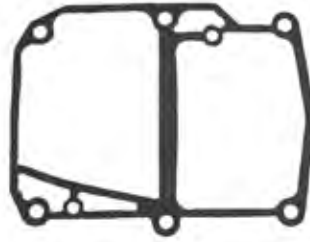

18-99150
UPPER CASING GASKET

Replaces: 63V-45113-A1
Fits: 9.9(1997-09), 15(1997-09)

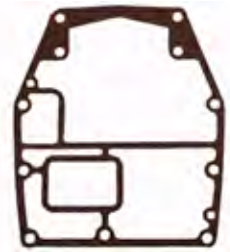

18-99151
UPPER CASING GASKET

Replaces: 688-45113-A0
Fits: 90(1984-09), B90(1997-99), C75(1994-99), C80(1997), C85(1991-96), C90(1997-01), C85(1989-90), E75(1995-00), P75(1996-99)



18-99152
LOWER CASING GASKET

Replaces: 683-45315-A0
Fits: 9.9(1984-95), 15(1984-95), F9.9(1986-05)

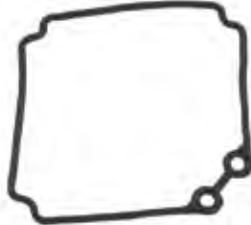

18-0765
FLOAT CHAMBER GASKET

Replaces: 6L2-14384-00-00

PKG. OF 2



18-0775
18-0775-9^①
CARB MOUNTING GASKET

Replaces: 648-14198-A0-00



18-0785
CARB MOUNTING GASKET

Replaces: 6E5-14198-A1-00



18-0786
FLOAT CHAMBER GASKET

Replaces: 6E5-14384-02-00



18-2592
FLOAT BOWL GASKET

Replaces: 6E5-14384-03-00
For: V-4 Outboards: 115, 130, 150, 175, 200, 225 (1986-96) V-6 Special & Excel (1986-89)



18-0840-1
FLOAT CHAMBER GASKET

Replaces: 676-14984-00-00

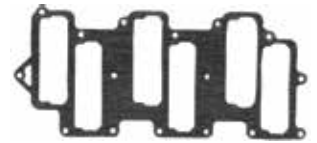

18-0807-1
REED PLATE GASKET

Replaces: 6K7-13645-A1-00

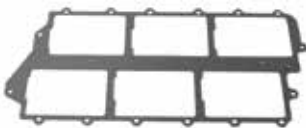

18-0809
REED BLOCK GASKET

Replaces: 6G5-13645-A1-00



18-64415
O₂ SENSOR KIT

Replaces: 68F-W1135-00-00
Fits: Yamaha DX150(2001-05), LX150(2001), LX200(2001), LX225(2001-02), LX250(2001-02), LZ150(2000-05), LZ200(2000-12), SX150(2001-04), SX200(2001-05), SX225(2001-02), SX250(2001-02), VX150(2001-04), VX200(2001-02), VX225(2001-02), VZ150(2000-14), VZ175(2001-12), VZ200(2001-04), Z150(2000-05), Z175(2001-05), Z200(2000-12)



18-0808
PRESSURE CONTROL VALVE GASKET

Replaces: 6G5-11382-A1-00

SEE PAGES 201-202 FOR OUR COMPLETE LINE OF GASKET SEALANTS

^① Priced per Package

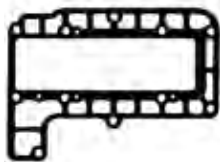

18-0250
EXHAUST COVER
GASKET
 Replaces: 664-41114-A0-00

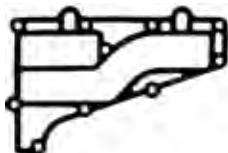

18-0743
INNER EXHAUST
COVER GASKET
 Replaces: 6L2-41112-A1-00

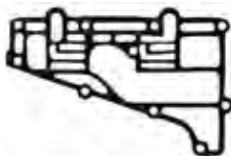

18-0744
OUTER EXHAUST
COVER GASKET
 Replaces: 6L2-41114-A1-00

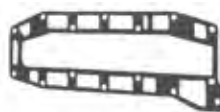

18-0798
EXHAUST COVER
GASKET
 Replaces: 6H4-41114-A0-00



18-0799
EXHAUST COVER
GASKET
 Replaces: 6E5-41112-A1-00



18-0812
EXHAUST COVER
GASKET
 Replaces: 6G5-41112-A1-00

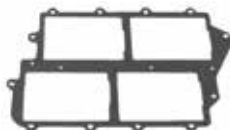

18-0823
EXHAUST MANIFOLD
GASKET
 Replaces: 6E5-13645-A1-00

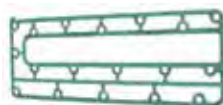

18-0847
EXHAUST COVER
GASKET
 Replaces: 688-41112-A0-00
 Fits: 90 HP



18-0739
UPPER CASING
GASKET
 Replaces: 689-45113-A1-00



18-0813
POWERHEAD
BASE GASKET
 Replaces: 6G5-45113-A0-00



18-0232
COVER GASKET
 Replaces: 655-12414-A1-00



18-0782
COVER GASKET
 Replaces: 6E5-11381-A1-00



18-0829
COVER GASKET
 Replaces: 61A-12414-A0-00
 6J8-12414-A0-00



18-99127
THERMOSTAT GASKET
 Replaces: 63P-12414-00-00
 Fits: F150/LF150 (2004-11), F150A/
 LF150A (2012-14), F150B/LF150B
 (2015-18)



18-0754
THERMOSTAT GASKET
 Replaces: 68D-E2414-A0-00
 Fits: F2.5MSH-0405,
 F2.5MSH-0406, F2.5MSH-0407,
 F2.5MSH0608, F2.5MSHD-2007



18-0835
THERMOSTAT GASKET
 Replaces: 62Y-12414-00-00
 Fits: F 9.9, T9.9 (2005-06), 15 (2006),
 F15, F25 (1998-06), T25, F30 (2001-
 06), F40 4cyl (1999), F40 3cyl (2000-
 06), F50 (1996-06), T50 (1996-06),
 F60 (2002-06), T60 (2003-06)



18-0836
THERMOSTAT GASKET
 Replaces: 682-12414-A1-00
 Fits: 9.9, 15 (1984-06)



18-0844
THERMOSTAT GASKET
 Replaces: 688-12414-A1-00
 Fits: 90 HP V-4, V-6



18-0767
WATER JACKET
GASKET
 Replaces: 688-11193-01-00
 Fits: 90 HP



18-0779
WATER JACKET
GASKET
 Replaces: 6G5-11193-A0-00



18-0781
WATER JACKET
GASKET
 Replaces: 6E5-11193-A0-00



18-0815
WATER JACKET
GASKET
 Replaces: 6H4-11193-A1-00













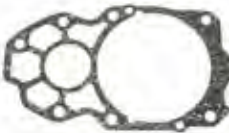









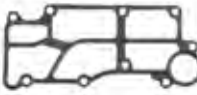

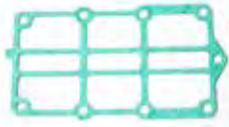

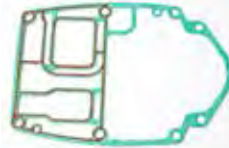
18-0483
PUMP CASE GASKET
 Replaces: 63D-44316-00-00
 Fits: 40 (1995-04),
 50 (1995-97, 1999-04)







18-0753
WATER PUMP GASKET
 Replaces: 6G1-44315-A0-00
 Fits: 6 (1986-00), 8 (1984-05)







18-0239
WATER PUMP GASKET
 Replaces: 688-44315-A0-00

 <p>18-3458 WATER PUMP GASKET Replaces: 6CE-44315-00-00 Fits: F225 (2010-15), F250 (2010), F250 (2010-15), F300 (2007-15), F350 (2007-15), FL250 (2010), FL300 (2010), FL350 (2010), LF225 (2010-15), LF250 (2010-15), LF300 (2007-15), LF350 (2007-15), VF250 (2015)</p>	 <p>18-60512 BREATHER GASKET Replaces: 68D-E1169-A0-00 Fits: Yamaha F4(2002-08)</p>	 <p>18-60521 CYLINDER COVER GASKET Replaces: 69M-11196-A0-00 Fits: Yamaha F2.5(2003-14), F4(1999-14), F6(2009-14)</p>	 <p>18-60529 EXHAUST MANIFOLD GASKET Replaces: 66T-41133-A0-00 Fits: Yamaha T40/T30 Enduro Series</p>	 <p>18-63966 CYLINDER HEAD GASKET Replaces: 66M-11181-10-00 Fits: Yamaha F9.9(2005-06), F15(2005-06), T9.9(2005-06)</p>
 <p>18-63968 CYLINDER HEAD GASKET Replaces: 65W-11181-30-00 Fits: F25(2005), T25(2005-06)</p>	 <p>18-60522 CYLINDER COVER GASKET Replaces: 66T-11181-A0-00 Fits: Yamaha F2.5(2003-14), F4(1999-14), F6(2009-14)</p>	 <p>18-60518 CRANKCASE GASKET Replaces: 68D-11351-A0-00 Fits: Yamaha F4(2002-08)</p>	 <p>18-60519 CRANKCASE GASKET Replaces: 68D-E1193-A0-00 Fits: Yamaha F4(2002-08)</p>	 <p>18-60530 EXHAUST OUTER COVER GASKET Replaces: 66M-41114-01-00 Fits: Yamaha F9.9(2005-06), F15(2005-06), T9.9(2005-06)</p>
 <p>18-60531 EXHAUST OUTER COVER GASKET Replaces: 65W-41114-01-00 Fits: Yamaha F25</p>	 <p>18-60523 CYLINDER COVER GASKET Replaces: 69M-11181-00-00 Fits: Yamaha F2.5(2003 & Up)</p>	 <p>18-60527 ENGINE GASKET Replaces: 67D-45113-A0-00 Fits: Yamaha F4(1999-08)</p>	 <p>18-60532 EXHAUST OUTER COVER GASKET Replaces: 66T-41114-A0-00 Fits: Yamaha T40/T30 Enduro Series</p>	 <p>18-60520 CYLINDER COVER GASKET Replaces: 66T-11193-A0-00 Fits: Yamaha T40/T30 Enduro Series</p>
 <p>18-60528 ENGINE GASKET Replaces: 66T-45113-A0-00 Fits: Yamaha T40/T30 Enduro Series</p>	 <p>18-60534 MANIFOLD GASKET Replaces: 66M-13645-00-00 Fits: Yamaha F9.9(2005-06), F15(1998-06), T9.9(2005-06)</p>	 <p>18-60535 MANIFOLD GASKET Replaces: 65W-13645-00-00 Fits: F25(1998-05), T25(2001-06)</p>	 <p>18-60540 THERMOSTAT GASKET Replaces: 676-12414-A0-00 For: Yamaha T40/T30 Enduro Series</p>	 <p>18-60541 WATER PUMP COVER GASKET Replaces: 6BX-G4315-01-00 Fits: F4(2009-14), F6(2009-14)</p>
 <p>18-0240 WATER PUMP GASKET Replaces: 688-44316-A0-00</p>	 <p>18-0244 WATER PUMP GASKET Replaces: 6E5-44315-A0-00</p>	 <p>18-0292 WEAR PLATE TO PUMP HOUSING GASKET Replaces: 663-44315-A0-00</p>	<p>PKG. OF 2</p>  <p>18-0294 18-0294-9 WEAR PLATE TO PUMP BASE GASKET Replaces: 663-44324-A0-00</p>	 <p>18-0756-1 WATER PUMP GASKET Replaces: 6H3-44315-A0-00</p>

 <p>18-60513 BREATHER GASKET Replaces: 66M-11357-00-00 Fits: Yamaha F9.9(2005-06), F15(1998-06), T9.9(2005-06)</p>	 <p>18-0757 OUTER PLATE GASKET Replaces: 6H3-44324-A0-00</p>	<p>PKG. OF 2</p>  <p>18-0768 18-0768-9① WEAR PLATE GASKET Replaces: 682-44315-A0-00</p>	 <p>18-0826 DRAIN SCREW GASKET Replaces: 90430-14115-00 Fits: 40-90 HP</p>	 <p>18-1079 OIL SEAL PROTECTOR Replaces: 6GD-G4325-00-00 Fits: 2(1984-85, 1988-89)</p>
--	---	---	--	---

SEE PAGES 201-202 FOR OUR COMPLETE LINE OF GASKET SEALANTS

 <p>18-4274 PROP SPACER Replaces: 688-45997-01-00</p>	 <p>18-2448 LOWER UNIT FILL/ DRAIN KIT M8 - 1.25 thread Fits: Yamaha, Nissan/Tohatsu, & Honda Lower Units</p>	 <p>18-4698 18-46981-9① (PKG. OF 50) DRAIN FILL WASHER Replaces: 90430-08020-00</p>	 <p>18-2371 18-23711-9① (PKG. OF 50) DRAIN SCREW M8 - 1.25 thread Replaces: 90340-08002-00, 90340-08M04-00 Uses Gasket 18-4698</p>	 <p>18-2374 18-23741-9① (PKG. OF 50) MAGNETIC DRAIN SCREW M8 - 1.25 thread Replaces: 688-45341-00-00, 688-45341-10-00 Uses Gasket 18-4698</p>
--	--	--	---	---

 <p>18-2388 PROP SHAFT Replaces: 688-45611-00-00 For: F40 (1999) F50(1999-00) C60/C70/C90 (2000-01) C75 (1994) C85 (1991-94)</p>	 <p>18-2385 PROP SHAFT Replaces: 6E5-45611-01-00 For: 115/130HP</p>	<p>RECOIL STARTER SPRINGS</p>  <p>18-51001 Replaces: 63V-15713-00-00 Fits: 9.9(1996-09), 15(1996-09), F6(2001-08), F8(2001-14), F9.9(2005-14), F15(1998-14), F20(2006-14), T8(2002-10), T9.9(2007-14)</p> <p>18-51002 Replaces: 67D-15713-00-00 Fits: F2.5(2003-14), F4(1999-14), F6(2009-14)</p> <p>18-51003 Replaces: 66T-15713-00-00 Fits: F25(2009-14), F30(2001-05), F40(2001-08)</p>
--	---	--

Model	Year	Part #	Model	Year	Part #
40EJRP - 50TLHS	1984-1997	N/A	F115TLR	2006 & UP	18-2385
50ETSN - 50TLHS	1984-1994	N/A	F115TLRA - F115TLRZ	2001-2005	18-2385
T50TLRY - C90TLRZ	1989-2001	18-2388	F115TXR	2006 & UP	18-2385
50ETSK	1984-2001	18-2385	F115TXRA -200ETXN	1984-2004	18-2385
115TLR	2006 & UP	18-2385	V-6 SPECIAL	1985-1986	18-2385
115TLRA - 115TRR	1991-2005	18-2385	V-6 SPECIAL L	1984-1986	18-2385
115TXR	2006 & UP	18-2385	V-6 SPECIAL LK	1985	18-2385
115TXRA - 115TXRA	1991-2005	18-2385	V-6 SPECIAL X	1984-1986	18-2385
F115TJR	2006 & UP	18-2385	V-6 SPECIAL XK	1985	18-2385
F115TJRA - F115TJRD	2002-2005	18-2385			

 <p>18-2773 CARRIER BEARING Replaces: 663-45331-00-94 For: E48 (1995, 1997-00) / C55 (1991-95)</p>	 <p>18-2782 CARRIER BEARING Replaces: 688-45331-00-94 For: F40 (1999) F50/T50 (1996-00) 60 (2002-03) C60 (1996-01) E60 (1995-99) P60 (1991-99) 70 (1984-03) C70 (2000-01) C75 (1994-96 / 1998-99) E75 (1995-00) P75 (1996-99) C80 (1997) C85 (1991-96)</p>
---	---

① Priced per Package

Zinc is for saltwater only applications.
Magnesium is for fresh water only applications.
Aluminum is for brackish water, or if boat is used in both fresh and salt environments.

 <p>18-6118A^① CYLINDER BLOCK ANODE Replaces: 68V-11325-01-00 Fits: F75-F250 / 2004 through April 2006 Production</p>	 <p>18-6119A^① 18-6119Z^③ TRIM TAB ANODE Replaces: 61A-45371-00-00</p>	 <p>18-6120A^① 18-6120Z^③ GEARCASE ANODE Replaces: 61N-45251-01-00</p>	 <p>18-6121A^① 18-6121Z^③ TRIM TAB ANODE Replaces: 6K1-45371-02-00 Fits: FL150 (2004-2005); L150 - L200 (1987-2002)</p>	 <p>18-6122A^① 18-6122Z^③ TRIM TAB ANODE Replaces: 69L-45371-00-00 Fits: VZ200 - VZ300 / 3.3L (2005-Current), VX225 - VX250 / 2.6L (2002-2005), Z250 - Z300 / 3.3L (2004-Current)</p>															
 <p>18-6246 TRIM TAB BOLT Replaces: 90105-10M00-00 M10 - 1.25 x 45mm thread</p>	 <p>③ 18-6034 ANODE Replaces: 6K1-45371-00-00 For use on lower drive 150,200 HP (1986)</p>	 <p>② 18-6112 ③ 18-6035 ANODE Replaces: 6J9-45371-01-00 For: 150-200 HP</p>	 <p>② 18-6111 ③ 18-6070 ANODE Replaces: 688-45371-02-00 For use on lower casing drive For: 60, 70, 90HP (1984-04) C60, C75, C85, C90 (1994-01), E60, E75 (1995-00), F50 (1996-00), P60, P75 (1991-99), T50 (1996-00)</p>	 <p>③ 18-6090 ANODE Replaces: 6G5-45251-01-00 For use on transom bracket For: 115-225HP (1988-02)</p>															
 <p>③ 18-6091 ANODE Replaces: 6H1-45251-02-00 For: 40-90 HP</p>	 <p>③ 18-6096 ANODE Replaces: 664-45371-01-00 For: 20-50 HP</p>	 <p>③ 18-6097 ANODE Replaces: 6E5-45371-01-00 For use on lower casing drive For: 115, 130 HP(1984-04), V6 Special (1985-86)</p>	 <p>① 18-6132A ② 18-6132M ANODE For: Yamaha 200-250 Outboards</p>	 <p>① 18-6133A ② 18-6133M ANODE Fits: Yamaha 150-200 Outboards</p>															
 <p>18-6162A^① 18-6162M^② ANODE KIT Fits: Yamaha 60-90HP Engines</p>	 <p>COTTER PINS</p> <table border="1"> <thead> <tr> <th>Part #</th> <th>O.E. #</th> <th>Pkg of</th> </tr> </thead> <tbody> <tr> <td>18-2380</td> <td>91490-30030-00, 91401-30030-00, 91401-30028-00, 91402-30028-09, 91402-30028-00, 91402-30022-09, 91402-30022-00</td> <td>10</td> </tr> <tr> <td>18-3735</td> <td>91490-40030-00</td> <td>10</td> </tr> <tr> <td>18-3748</td> <td>91490-30045-00</td> <td>5</td> </tr> <tr> <td>18-73893</td> <td>91490-25030-00</td> <td>1</td> </tr> </tbody> </table>		Part #	O.E. #	Pkg of	18-2380	91490-30030-00, 91401-30030-00, 91401-30028-00, 91402-30028-09, 91402-30028-00, 91402-30022-09, 91402-30022-00	10	18-3735	91490-40030-00	10	18-3748	91490-30045-00	5	18-73893	91490-25030-00	1	 <p>18-73891 PROP SPACER Replaces: 68D-G5987-00-00 Fits: Yamaha F2.5(2001 & Up), F4(2001 & Up), F6(2006 & Up)</p>	 <p>18-73914 PROP SPACER Replaces: 670-45997-02-00 Fits: Yamaha 40-50(1984-05)</p>
Part #	O.E. #	Pkg of																	
18-2380	91490-30030-00, 91401-30030-00, 91401-30028-00, 91402-30028-09, 91402-30028-00, 91402-30022-09, 91402-30022-00	10																	
18-3735	91490-40030-00	10																	
18-3748	91490-30045-00	5																	
18-73893	91490-25030-00	1																	
 <p>18-73918 PROP THRUST WASHER Replaces: 63P-45987-00-00, 6E5-45987-01-00 Fits: Yamaha F115-F200(2004-14)</p>	 <p>18-73979 PROP THRUST WASHER Replaces: 6L2-45987-01-00 Fits: Yamaha 25(1988-09), 30(1990-02), C30(1994-97), F25(1998-14)</p>	 <p>18-73978 PROP NUT WASHER Replaces: 90201-08M54-00 Fits: Yamaha Multiple Applications</p>	 <p>18-73990 PROP NUT KIT Fits: Yamaha 40(1984-01), 50(1984-95), C55, F40-F50(1995-00)</p>	 <p>18-73993 PROP NUT KIT Fits: Yamaha F9.9/15</p>															

① Aluminum ② Magnesium ③ Zinc



**18-73994
PROP NUT KIT**
Fits: Yamaha F2.5/F4(2001 & Up), F6(2006 & Up)



**18-73892
PROP NUT**
Replaces: 6L5-45616-00-00
Fits: Yamaha 2.5-6(1988 & Up)



**18-3781
PROP NUT KIT**
Replaces: 6H1-W4599-00-00
For: T50, C60, E60, P60, 70, C75, C80, C85, 90
— CONTAINS —

Part #	O.E. #	Desc.
18-3732	90171-16011-00	Prop Nut
18-4274	688-45997-01	Spacer
18-2380	91490-30030	Cotter Pin



**18-3782
PROP NUT KIT**
Replaces: 6G5-W4599-00-00
— CONTAINS —

Part #	O.E. #	Desc.
18-3726	90171-18M04	Prop Nut
18-4274	688-45997-01	Spacer
18-3735	91490-40030	Cotter Pin

ALL V-4 & V-6 (Except D150)



**18-3771
PROP NUT KIT**
Replaces: 689-W4599-00
— CONTAINS —

Part #	O.E. #	Desc.
18-3791	689-45997-00	Spacer
18-3792	90171-14013-00	Prop Nut
18-2380	91490-30030-00	Cotter Pin



**18-3709
PROP NUT**
Replaces: 647-45616-02
Fits: 4(1984-91), 5(1984-85)



**18-3726
PROP NUT**
Replaces: 90171-18M04
Fits: All V-4 & V-6 (Except D150)



**18-3732
PROP NUT**
Replaces: 90171-16011-00
95307-16900-00
Fits: Yamaha 20-30 hp(1980 & Up)



**18-73907
PROP NUT**
Replaces: 90171-14056-00
Fits: Yamaha 20-30 HP (1980 & up)



**18-3773
PROP NUT**
Replaces: 90171-10M01
Fits: 6(1986-00), 8(1986-09), 9.9(1984-09), 15(1984-09), F6(2001-08), F8(2001-12), F9.9(1985-12), F15(1998-13), F20(2006-13)



**18-3791
SPACER**
Replaces: 689-45997-00



**18-3792
PROP NUT**
Replaces: 90171-14013-00, 90171-14056-00



**18-79989
TRAILERING STICKS**
Fits: Most outboards over 150hp with three ram intrigril tilt/trim.

HP/Model	Years	Nut #	Spacer #	Cotter Pin #	Kit #
2(6A1)	1984-95	—	—	18-3748	—
4(6E0)	1984-90	—	—	18-3748	—
4(6E0)	1991	—	—	18-2380	—
5	1984-85	—	—	18-3748	—
9.9(6GB)	1984-85	—	—	18-3748	—
20	1996-97	18-3792	18-3791	18-2380	18-3771
25(6H7)(6L2)	1984-09	18-3792	18-3791	18-2380	18-3771
C25(695)	1991-97	18-3792	18-3791	18-2380	18-3771
CV25	1990	18-3792	18-3791	18-2380	18-3771
F25	1998-05, 2009-10	18-3792	18-3791	18-2380	18-3771
30(689)(6J8)	1984-02	18-3792	18-3791	18-2380	18-3771
C30(689)(61T)	1991-97	18-3792	18-3791	18-2380	18-3771
CV30	1990	18-3792	18-3791	18-2380	18-3771
40(6H4)(63B,C,D)	1984-05	18-3732	—	18-2380	—
C40(6R6)	1990-03	18-3732	—	18-2380/18-3748	—
50(6H5)(62X)	1984-09	18-3732	—	18-2380/18-3748	—
PRO50(6H5)(62X)	1987-90	18-3732	—	18-2380	—
T50	2001-10	18-3732	18-3789	18-3735	18-3772
C55(697)	1991-95	18-3732	—	18-3735	—
60	2004-05	18-3732	18-3789	18-3735	18-3772
P60(6H2)	1991-99	18-3732	18-4274	18-3735	18-3781
T60	2003-10	18-3732	18-3789	18-3735	18-3772
70(6H3)	1984-03	18-3732	18-4274	18-3735	18-3781
70	2004-09	18-3732	18-3789	18-3735	18-3772
F70	2010	18-3732	18-3789	18-3735	18-3772
C75(692)	1994-99	18-3732	18-4274	18-3735	18-3781
F75	2003-10	18-3732	18-3789	18-3735	18-3772
F80	1999-03	18-3732	18-3789	18-3735	18-3772
C85(688)	1991-96	18-3732	18-4274	18-3735	18-3781
90(6H1)	1984-03	18-3732	18-4274	18-3735	18-3781
90	2004-09	18-3732	18-3789	18-3735	18-3772
F90	2003-10	18-3732	18-3789	18-3735	18-3772
F100	1999-03	18-3732	18-3789	18-3735	18-3772
115(6E5)(6N6)	1984-09	18-3726	18-4274	18-3735	18-3782
C115(6E5)	1991-00	18-3726	18-4274	18-3735	18-3782
P115(62A)	1993-96	18-3726	18-4274	18-3735	18-3782
130(6L1)(6N7)	1988-04	18-3726	18-4274	18-3735	18-3782
L130(6L6)(6N4)	1989-01	18-3726	18-4274	18-3735	18-3782
150(6G4)(6R2)	1984-09	18-3726	18-4274	18-3735	18-3782
PRO V 150. (6J9)(6N9)	1986-90	18-3726	18-4274	18-3735	18-3782
P150(6N9)	1991-99	18-3726	18-4274	18-3735	18-3782
L150(6RO)	1986-99	18-3726	18-4274	18-3735	18-3782
175(6G5)(6R3)	1984-00	18-3726	18-4274	18-3735	18-3782
P175(62H)	1994-99	18-3726	18-4274	18-3735	18-3782
200(6G6)(6R4)	1984-95	18-3726	18-4274	18-3735	18-3782
L200(6K1)(6R1)	1987-99	18-3726	18-4274	18-3735	18-3782
P200(61H)	1991-99	18-3726	18-4274	18-3735	18-3782
225(6R5)(62J)	1990-97	18-3726	18-4274	18-3735	18-3782
L225(62K)	1994-99	18-3726	18-4274	18-3735	18-3782
250(61A)	1990-95	18-3726	18-4274	18-3735	18-3782
L250(61B)	1990-99	18-3726	18-4274	18-3735	18-3782
V6 SPECIAL(6G7)	1984-86	18-3726	18-4274	18-3735	18-3782
V6 EXCEL(6K7)	1987-89	18-3726	18-4274	18-3735	18-3782

① Items ending in "D" are Display Packaged - Regular number is Non-Display
 ② This product is priced per piece. To order price per package, please add -9 to the part number.



QUALITY is ASSURED

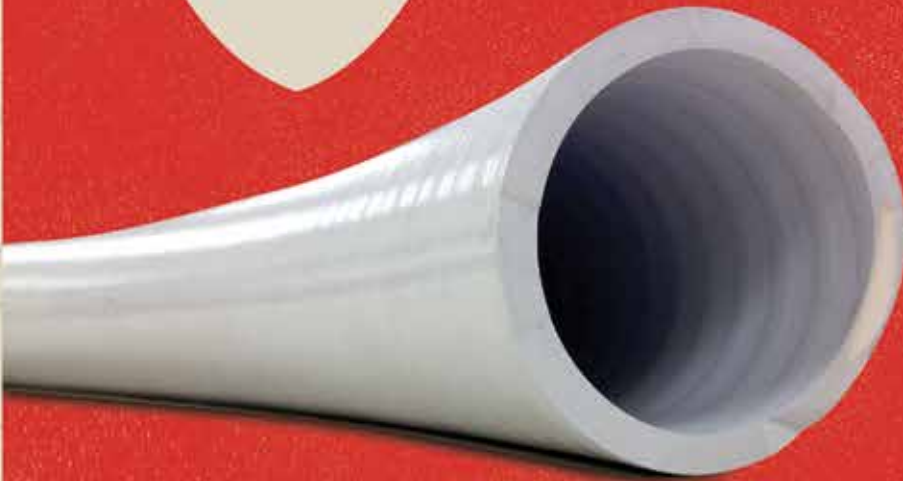

Shields Marine manufactures a wide variety of hoses for applications onboard pleasure craft. **Serving as conduits for fluids, air or exhaust, each Shields hose is designed for a specific application and meets strict standards set by the USCG, ABYC and other regulatory agencies.**

Three of our marine exhaust hoses have qualified for Lloyd's Register Type Approval, meeting the highest standards of production quality.

See pages 63-109 for product offering.



The Very Best Parts of Boating
www.sierramarine.com

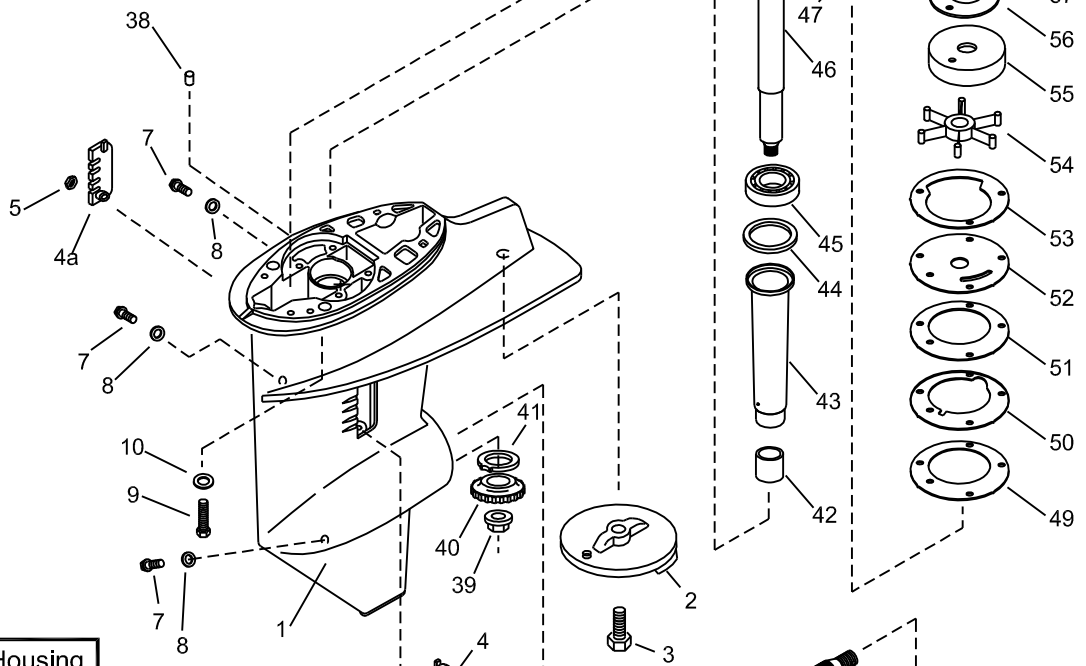
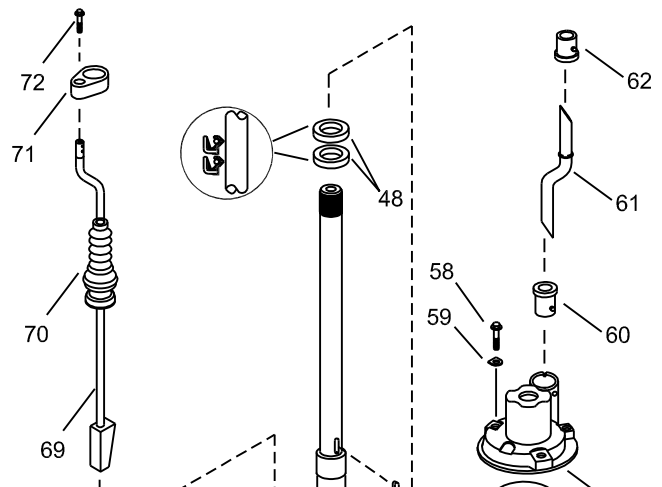
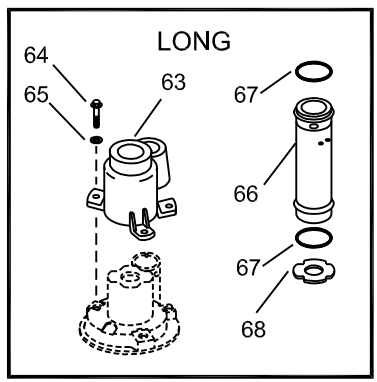

73 — Gear Housing Seal Kit 18-2785

74 — Water Pump Repair Kit 18-3427

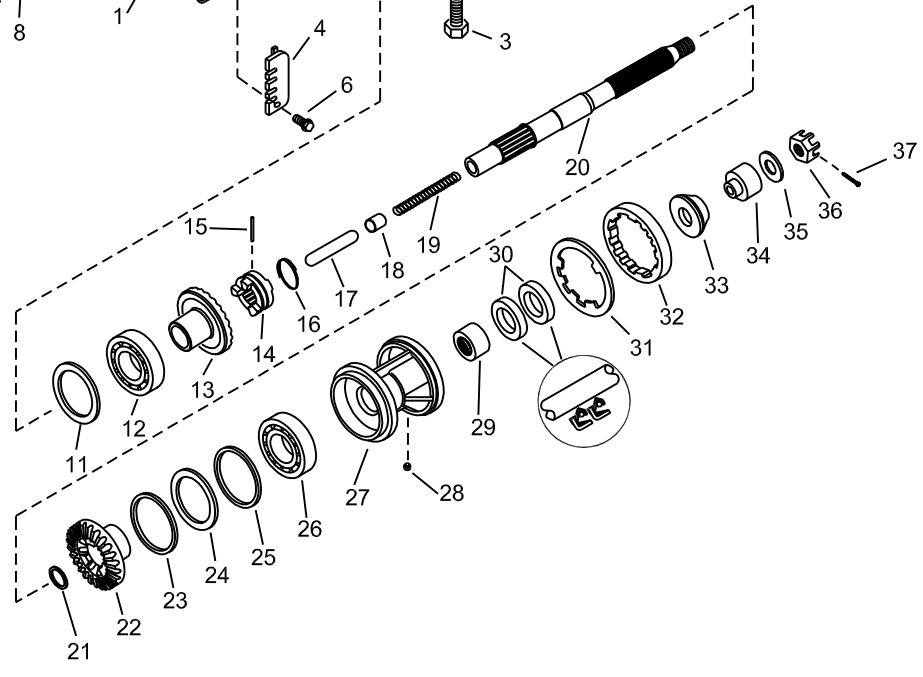
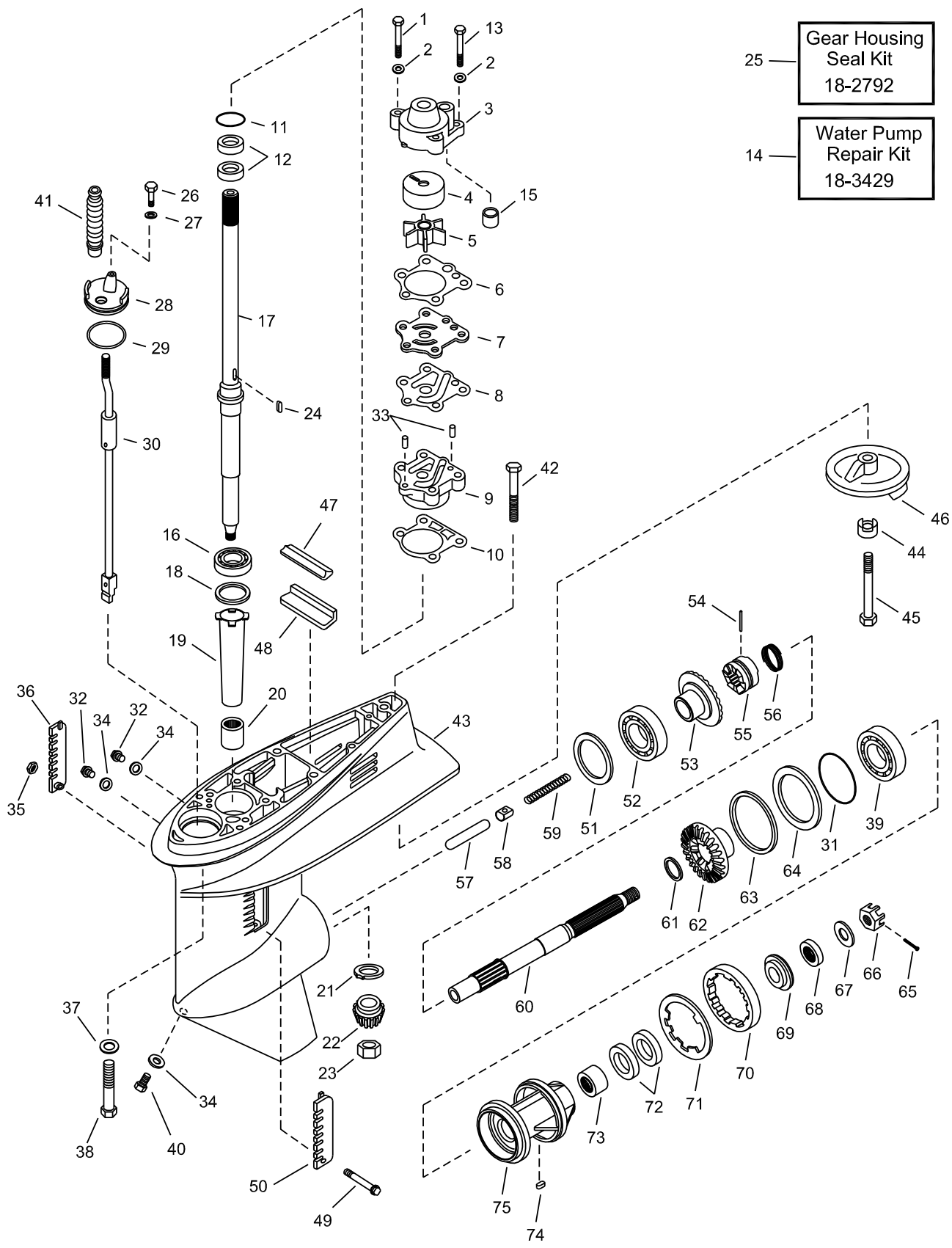

Figure #	Description	Part #	O.E.M. #	Qty.	Figure #	Description	Part #	O.E.M. #	Qty.
1	Housing, Gearcase	—	689-45311-04-EK3	1	37	Cotter Pin	18-2380	91490-30030-00	
2	Trim Tab	18-6096A, 18-6113	664-45371-01-00	1	38	Pin, Dowel	—	93606-12019-00	2
					39	Nut, Pinion	—	90179-09M02-00	2
3	Bolt, Trim Tab	—	90105-08M02-00	1	40	Gear, Pinion	—	689-45551-00-00	1
4	Cover, Water Inlet (port)	—	689-45214-01-01	1	41	Bearing, Thrust	—	664-45552-09-00	1
4a	Cover, Water Inlet (stbd)	—	689-45215-01-00	1	42	Bearing, Pinion	—	93315-017U4-00	1
5	Nut, Nylock	—	90185-05904-00	1	43	Sleeve, Drive Shaft	—	689-45536-00-00	1
6	Bolt, Water Inlet	—	98680-05525-00	1	44	Shim Pinion Gear (0.5mm)	—	664-45587-00-05	AR
7	Plug, Drain & Vent	—	90340-08M04-00	3		Shim Pinion Gear (0.8mm)	—	664-45587-00-08	AR
8	Gasket, Plug	—	90430-08020-00	3		Shim Pinion Gear (0.12mm)	—	664-45587-01-12	AR
9	Bolt, Gearcase Mounting	—	90105-10059-00	2		Shim Pinion Gear (0.30mm)	—	664-45587-01-30	AR
10	Washer, Gearcase Mounting	—	92990-10600-00	4		Shim Pinion Gear (0.50mm)	—	664-45587-01-50	AR
11	Shim Forward Gear (0.5mm)	—	664-45567-00-05	AR	45	Bearing, Drive Shaft	—	93332-000U4-00	1
	Shim Forward Gear (0.8mm)	—	664-45567-00-08	AR	46	Drive Shaft (long)	—	689-45501-10-00	1
	Shim Forward Gear (0.12mm)	—	664-45567-01-12	AR	47	Key, Impeller	—	664-44338-00-00	1
	Shim Forward Gear (0.30mm)	—	664-45567-01-30	AR	48	Oil Seal, Pump Base	18-0296	93101-22067-00	2
	Shim Forward Gear (0.50mm)	—	664-45567-01-50	AR	49	Gasket, Base	18-0773	689-44316-A0-00	1
12	Bearing, Forward Gear	—	93332-00005-00	1	50	Base, Water Pump	—	689-44325-02-5B	1
13	Gear, Forward	—	689-45560-00-00	1	51	Gasket, Base	18-0773	689-44316-A0-00	1
14	Clutch, Dog	—	664-45631-01-00	1	52	Impeller Plate	—	689-44323-03-00	1
15	Pin, Clutch Dog	—	90250-05010-00	1	53	Gasket, Impeller Plate	—	689-44324-A0-00	1
16	Ring, Cross Pin	—	648-45633-00-00	1	54	Impeller	18-3067	689-44352-02-00	1
17	Plunger, Shift	—	648-45635-00-00	1	55	Insert Cup	18-3439	689-W4432-02-00	1
18	Slide, Shift	—	648-45634-00-00	1	56	Damper, Water Seal	—	689-44367-01-00	1
19	Spring, Compression	—	90501-10065-00	1	57	Housing, Water Pump	—	689-44311-03-00	1
20	Shaft, Propeller	—	689-45611-00-00	1	58	Bolt, Pump Housing	—	90101-06M56-00	3
21	Thrust, Washer, Prop Shaft	—	90201-20417-00	1	59	Washer, Housing (short shaft)	—	90209-06M04-00	3
22	Gear, Reverse	—	689-45571-00-00	1	60	Seal, Lower Water Tube	—	626-44365-01-00	1
23	Shim Reverse Gear (0.5mm)	—	664-45577-00-05	AR	61	Water Tube (long shaft)	—	689-44361-10-00	1
	Shim Reverse Gear (0.8mm)	—	664-45577-00-08	AR	62	Seal, Upper Water Tube	18-0552	689-44366-00-00	1
	Shim Reverse Gear (0.12mm)	—	664-45577-01-12	AR	63	Extension, Housing (long shaft)	—	689-44312-00-5B	1
	Shim Reverse Gear (0.30mm)	—	664-45577-01-30	AR	64	Bolt, Extension (long shaft)	—	97080-06035-00	3
	Shim Reverse Gear (0.50mm)	—	664-45577-01-50	AR	65	Washer, Bolt (long shaft)	—	92990-06600-00	3
24	Washer Thrust	—	664-45576-00-00	1	66	Extension Tube (long shaft)	—	689-44362-00-94	1
25	O-Ring, Bearing Carrier	—	93210-30MA3-00	1	67	O-Ring, Extension Tube	—	93210-26240-00	2
26	Bearing, Reverse Gear	—	93306-00612-00	1	68	Plate (long shaft)	—	689-44328-03-00	1
27	Bearing, Carrier	—	689-45331-01-94	1	69	Shift Cam Assembly (short shaft)	—	664-44150-01-00	1
28	Key, Bearing Carrier	—	90282-04010-00	1	69	Shift Cam Assembly (long shaft)	—	664-44150-11-00	1
29	Bearing, Prop Shaft	—	93315-22004-00	1	70	Boot, Shift Rod	—	664-44147-00-00	1
30	Seal, Prop Shaft	18-0554	93101-20M07-00	2	71	Bracket, Shift Shaft	—	689-44176-01-00	1
31	Tab Washer	—	90214-45M02-00	1	72	Screw, Bracket	—	97780-50610-00	1
32	Nut, Cover	—	664-45384-00-00	1	73	Gear Housing Seal Kit	18-2785	689-W0001-22-00	1
33	Prop Spacer (fore)	—	664-45987-01-00	1	74	Water Pump Repair Kit	18-3427	689-W0078-A6-00	1
34	Prop Spacer (aft)	—	689-45997-00-00	1					
35	Washer, Prop Mounting	—	92990-14200-00	1					
36	Nut, Propeller	—	90171-14013-00	1					

AR As required



25 — Gear Housing Seal Kit 18-2792

14 — Water Pump Repair Kit 18-3429

Figure #	Description	Part #	O.E.M. #	Qty.	Figure #	Description	Part #	O.E.M. #	Qty.
1	Bolt, Water Pump Housing	—	97395-08055-00	2	39	Bearing, Ball	—	93306-00702-00	1
2	Washer, Water Pump Housing	—	92990-08600-00	4	40	Plug, Drain	18-2374	688-45341-00-00	1
3	Housing, Water Pump	—	663-44311-02-00	1	41	Propeller	—	various	1
4	Insert, Water Pump	18-3435	663-44322-00-00	1	42	Bolt, Trim Tab	—	97575-08675-00	1
5	Impeller	18-3068	6H4-44352-02-00	1	43	Casing, Lower	—	6H4-45301-01-EK	1
6	Gasket, Wear Plate to Water Pump	18-0292	663-44315-A0-00	1	44	Washer, Locking	—	92990-08100-00	1
					45	Bolt, Lower Casing	—	97095-08085-00	1
7	Wear Plate, Water Pump	18-3436	663-44323-00-00	1	46	Tab, Trim	18-6096A	664-45371-01-00	1
8	Gasket, Wear Plate to Water Pump	18-0294	663-44324-A0-00	1	47	Seal Rubber	—	688-45375-00-00	1
					48	Guide, Seal Rubber	—	663-45376-00-94	1
9	Base, Water Pump	—	663-44341-00-94	1	49	Screw Ovalhead	—	98780-05535-00	1
10	Gasket, Pump Base	—	663-44316-A0-00	1	50	Cover, Water Inlet (port)	—	668-45214,02-00	1
11	O-Ring, Pump Base	18-0298	93210-41042-00	1	51	Shim Forward Gear (0.5mm)	—	6H4-45567-00-05	1
12	Oil Seal, Pump Base	18-0297	93101-23070-00	2		Shim Forward Gear (0.8mm)	—	6H4-45567-00-08	AR
13	Bolt, Water Pump Housing	18-0256	97095-08045-00	2		Shim Forward Gear (0.12mm)	—	6H4-45567-01-12	AR
14	Water Pump Repair Kit	18-3429	6H4-W0078-00-00	1		Shim Forward Gear (0.30mm)	—	6H4-45567-01-30	AR
15	Water Seal	—	663-44366-00-00	1		Shim Forward Gear (0.50mm)	—	6H4-45567-01-50	AR
16	Bearing, Tapered Roller	—	93332-00079-00	1	52	Bearing, Tapered Roller	—	93332-000V4-00	1
17	Drive Shaft (Short)	—	6H4-45501-00-00	1	53	Gear, Forward	—	6H4-45560-00-00	1
17	Drive Shaft (Long)	—	6H4-45501-10-01	1	54	Pin, Cross (clutch dog)	—	90250-06023-00	1
18	Shim (0.5mm)	—	663-45587-00-05	AR	55	Clutch, Sliding	—	663-45631-01-00	1
	Shim (0.8mm)	—	663-45587-00-08	AR	56	Retainer Ring, Cross Pin	—	663-45633-00-00	1
	Shim (0.12mm)	—	663-45587-01-12	AR	57	Plunger, Shift	—	676-45635-00-00	1
	Shim (0.30mm)	—	663-45587-01-30	AR	58	Slide, Shift	—	663-45634-00-00	1
	Shim (0.50mm)	—	663-45587-01-50	AR	59	Spring, Compression	—	60501-16M01-00	1
19	Sleeve, Drive Shaft	—	6H4-45536-00-0	1	60	Shaft, Propeller	—	679-45611-01-00	1
20	Bearing, Needle	—	93315-32224-00	1	61	Washer, Plate	—	90201-22429-00	1
21	Bearing (not used 1988 & later)	—	663-45552-00-00	1	62	Gear, Reverse	—	6H4-45571-00-00	1
22	Gear, Pinion	—	6H4-45551-00-00	1	63	Shim Reverse Gear (0.5mm)	—	663-45577-00-05	AR
23	Nut, Pinion Gear	—	90170-12138-00	1		Shim Reverse Gear (0.8mm)	—	663-45577-00-08	AR
24	Key, Woodruff	18-3305	90280-03024-00	1		Shim Reverse Gear (0.12mm)	—	663-45577-01-12	AR
25	Gearcase Seal Kit	18-2792	6H4-W0001-20-00	1		Shim Reverse Gear (0.30mm)	—	663-45577-01-30	AR
26	Bolt, Plate	—	97095-06016-00	1		Shim Reverse Gear (0.50mm)	—	663-45577-01-50	AR
27	Washer, Plate	—	92990-06600-00	1	64	Washer, Thrust	—	663-45576-00-00	1
28	Plate	—	6H4-45321-01-00	1	65	Pin, Cotter	18-2380	91490-30030-00	1
29	O-Ring, Plate	—	93210-49046-00	1	66	Nut, Castle	18-3732	90171-16011-11	1
30	Shift Cam Assembly (short shaft)	—	6H4-44150-01-00	1	67	Washer	—	92990-16200-00	1
	Shift Cam Assembly (long shaft)	—	6H4-44150-12-01	1	68	Spacer, Prop Mounting (aft)	—	670-45997-02-00	1
31	O-Ring, Bearing Housing	18-0299	93210-66M98-00	1	69	Spacer, Prop Mounting (fore)	—	663-45987-02-00	1
32	Plug, Vent	—	90340-08M04-00	2	70	Nut, Cover	—	697-45385-00-00	1
33	Pin, Dowel	—	93604-08062-00	2	71	Washer, Tab	—	90214-48M03-00	1
34	Gasket, Drain Plug	—	90430-08020-00	3	72	Oil Seal, Bearing Housing	18-0296	93101-22067-00	2
35	Nut, Nylock	—	90185-05904-00	1	73	Bearing, Needle	—	93317-22204-00	1
36	Cover, Water Inlet (stbd)	—	688-45215-02-00	1	74	Key, Bearing Housing	—	90282-04010-00	1
37	Washer, Locking	—	92990-10100-00	4	75	Housing, Bearing	—	679-45331-00-94	1
38	Bolt	—	97078-10040-00	4					

AR As required

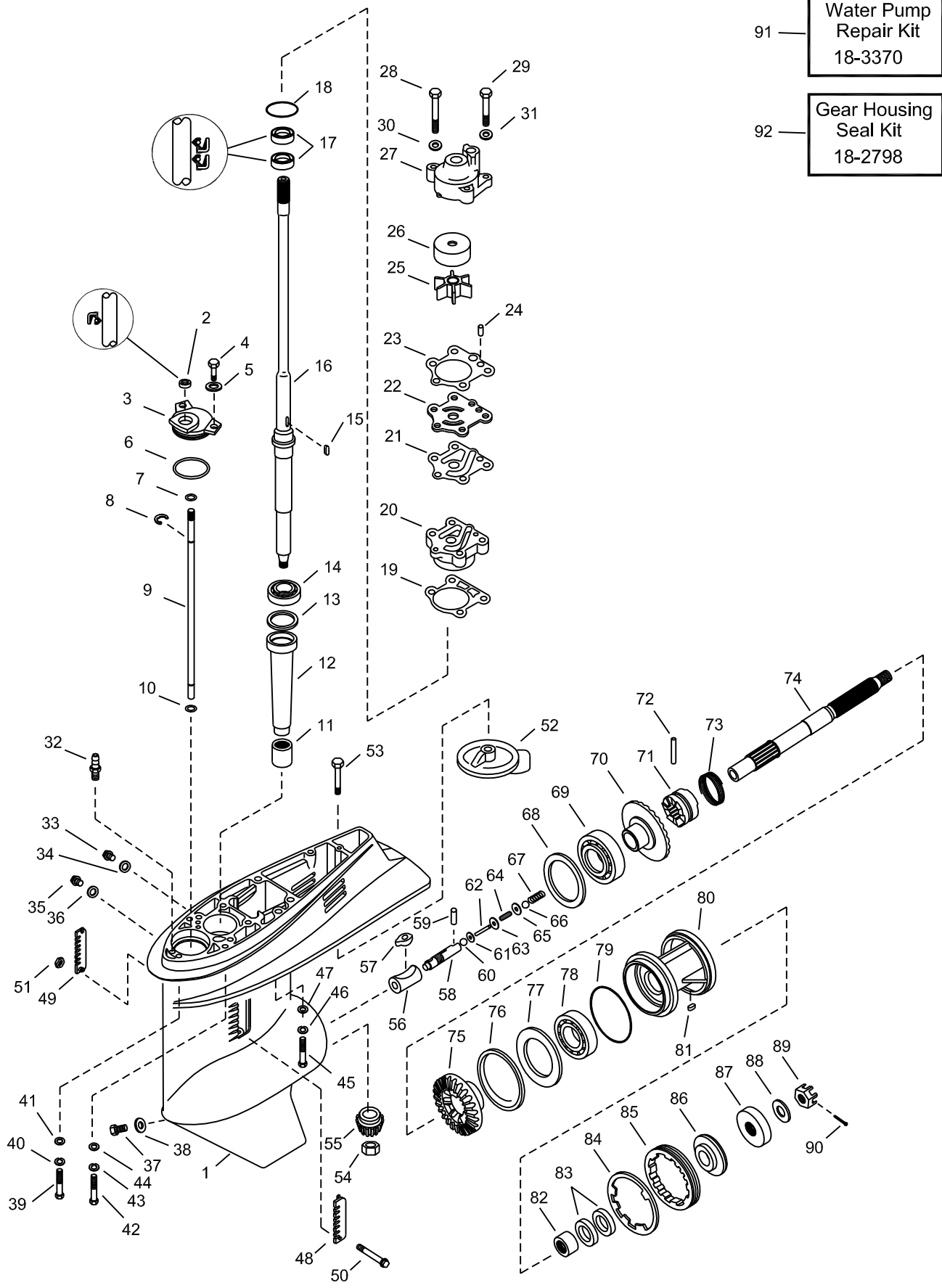

91 — Water Pump
Repair Kit
18-3370

92 — Gear Housing
Seal Kit
18-2798

Figure #	Description	Part #	O.E.M. #	Qty.	Figure #	Description	Part #	O.E.M. #	Qty.
1	Gearcase	—	6H1-45301-04-EK	1	50	Screw, Water Inlet	—	98680-05545-00	1
2	Oil Seal, Shift Shaft	18-0267	93106-09014-00	1	51	Nut, Water Inlet	—	90185-05002-00	1
3	Plate, Shift Rod	—	688-45321-00-00	1	52	Trim Tab	18-6070	988-45371-02-00	1
4	Bolt, Shift Rod Retainer	—	97395-06016-00	2	53	Bolt, Anode Mounting	—	90105-10M00-00	1
5	Washer	—	92990-06600-00	2	54	Nut, Pinion	—	90170-16M01-00	1
6	O-Ring	—	93210-49046-00	1	55	Gear, Pinion	—	688-45551-01-00	1
7	O-Ring	—	93210-07540-01	1	56	Shifter	—	6H1-45641-01-00	1
8	Circlip	—	99001-08600-00	1	57	Shift Cam	—	6H1-44151-00-00	1
9	Rod, Shift	—	6H1-44144-00-00	1	58	Shift Slide	—	6H1-45634-02-00	1
10	Circlip	—	93450-07M00-00	1	59	Pin	—	93603-12M11-00	1
11	Bearing, Pinion	—	93315-325V1-00	1	60	Nut, Spring	—	90183-02M03-00	1
12	Sleeve, Drive shaft	—	688-45536-01-00	1	61	Shift Plunger	—	6H1-45635-00-00	1
13	Shim Drive Shaft (0.10mm)	—	688-45587-01-10	AR	62	Shaft	—	6H1-45668-00-00	1
	Shim Drive Shaft (0.12mm)	—	688-45587-01-12	AR	63	Shift Plunger	—	6H1-45635-00-00	1
	Shim Drive Shaft (0.15mm)	—	688-45587-01-15	AR	64	Spring, Compression	—	90501-12M48-00	1
	Shim Drive Shaft (0.18mm)	—	688-45587-01-30	AR	65	Washer, Plate	—	90201-03313-00	1
	Shim Drive Shaft (0.30mm)	—	688-45587-01-40	AR	66	Nut, Spring	—	90183-02M03-00	1
	Shim Drive Shaft (0.40mm)	—	688-45587-01-50	AR	67	Spring, Compression	—	90501-16M65-00	1
	Shim Drive Shaft (0.50mm)	—	688-45587-01-16	AR	68	Shim Forward Gear (0.10mm)	—	688-45567-01-10	AR
14	Bearing, Upper Drive Shaft	—	93332-000U3-00	1		Shim Forward Gear (0.12mm)	—	688-45567-01-12	AR
15	Key, Impeller	18-3301	90280-04M04-00	1		Shim Forward Gear (0.15mm)	—	688-45567-01-15	AR
16	Drive Shaft	—	6H1-45501-11-00	1		Shim Forward Gear (0.18mm)	—	688-45567-01-18	AR
17	Oil Seal, Pump Base	18-0587	93101-25M03-00	2		Shim Forward Gear (0.30mm)	—	688-45567-01-30	AR
18	O-Ring, Base	18-7436	9321-46044-00	1		Shim Forward Gear (0.40mm)	—	688-45567-01-40	AR
19	Gasket, Base	18-0240	688-44316-A0-00	1		Shim Forward Gear (0.50mm)	—	688-45567-01-50	AR
20	Base, Water Pump	—	688-44341-01-94	1	69	Bearing, Forward Gear	—	93332-000W7-00	1
21	Gasket, Wear Plate to Base	—	688-44324-A0-00	1	70	Gear, Forward	—	688-45560-00-00	1
22	Wear Plate	18-3341	688-44323-00-00	1	71	Clutch, Dog	—	6H1-45631-01-00	1
23	Gasket, Wear Plate to Housing	18-0239	688-44315-A0-00	1	72	Pin, Cross	—	90250-07M02-00	1
24	Pin	—	93604-10M03-00	1	73	Spring, Cross Pin	—	688-45633-00-00	1
25	Impeller	18-3070	688-44352-03-00	1	74	Shaft, Propeller	—	6H1-45611-01-00	1
26	Insert, Water Pump	—	688-44322-00-00	1	75	Gear, Reverse	—	6H1-45571-00-00	1
27	Housing, Water Pump	18-3171	688-44311-01-00	1	76	Shim Reverse Gear (0.10mm)	—	688-45577-01-10	AR
28	Bolt, Water Pump	—	97395-08070-00	2		Shim Reverse Gear (0.12mm)	—	688-45577-01-12	AR
29	Bolt, Water Pump	—	97395-08050-00	2		Shim Reverse Gear (0.15mm)	—	688-45577-01-15	AR
30 &						Shim Reverse Gear (0.18mm)	—	688-45577-01-18	AR
31	Washer, Water Pump	—	90209-08M02-00	4		Shim Reverse Gear (0.30mm)	—	688-45577-01-30	AR
32	Nipple, Hose	—	6E5-45378-00-00	1		Shim Reverse Gear (0.40mm)	—	688-45577-01-40	AR
33	Plug, Drain	18-2371	90340-08M04-00	1		Shim Reverse Gear (0.50mm)	—	688-45577-01-50	AR
34	Gasket, Vent & Drain Plugs	18-46981-9	90430-08020-00	1	77	Washer, Thrust	—	688-45576-00-00	1
35	Plug, Drain	18-2371	90340-08M04-00	1	78	Bearing, Reverse Gear	—	93306-207U0-00	1
36	Gasket, Vent & Drain Plugs	18-46981-9	90430-08020-00	1	79	O-Ring, Bearing Housing	—	93210-85M97-00	1
37	Plug, Drain	18-2374	688-45341-00-00	1	80	Housing, Bearing	18-2782	688-45331-00-94	1
38	Gasket, Vent & Drain Plugs	18-46981-9	90430-08020-00	1	81	Key	—	90282-04010-00	1
39	Bolt	—	97395-10040-00	2	82	Bearing, Needle	—	93317-325U0-00	1
40	Washer, Lock	—	92990-10100-00	2	83	Oil Seal	18-0587	93101-25M03-00	2
41	Washer, Flat	—	92990-10600-00	2	84	Washer, Tab	—	688-45383-02-00	1
42	Bolt	—	97395-10040-00	2	85	Nut, Cover	—	688-45384-00-00	1
43	Washer, Lock	—	92990-10100-00	2	86	Spacer, Forward	—	688-45987-01-00	1
44	Washer, Flat	—	92990-10600-00	2	87	Spacer	18-4274	688-45997-01-00	1
45	Bolt	—	97395-08060-00	1	88	Washer, Propeller	—	90201-17M00-00	1
46	Washer, Lock	—	92990-08100-00	1	89	Nut, Castle	18-3732	90171-16011-00	1
47	Washer, Lock	—	92990-08100-00	1	90	Pin, Cotter	18-3735	91490-40030-00	1
48	Cover, Water Inlet (Port)	—	688-45214-02-00		91	Water Pump Repair Kit	18-3370	692-W0078-00-00	1
49	Cover, Water Inlet (Stbd)	—	688-45215-02-00	1	92	Gear Housing Seal Kit	18-2798	688-W0001-20-00	1

AR As required

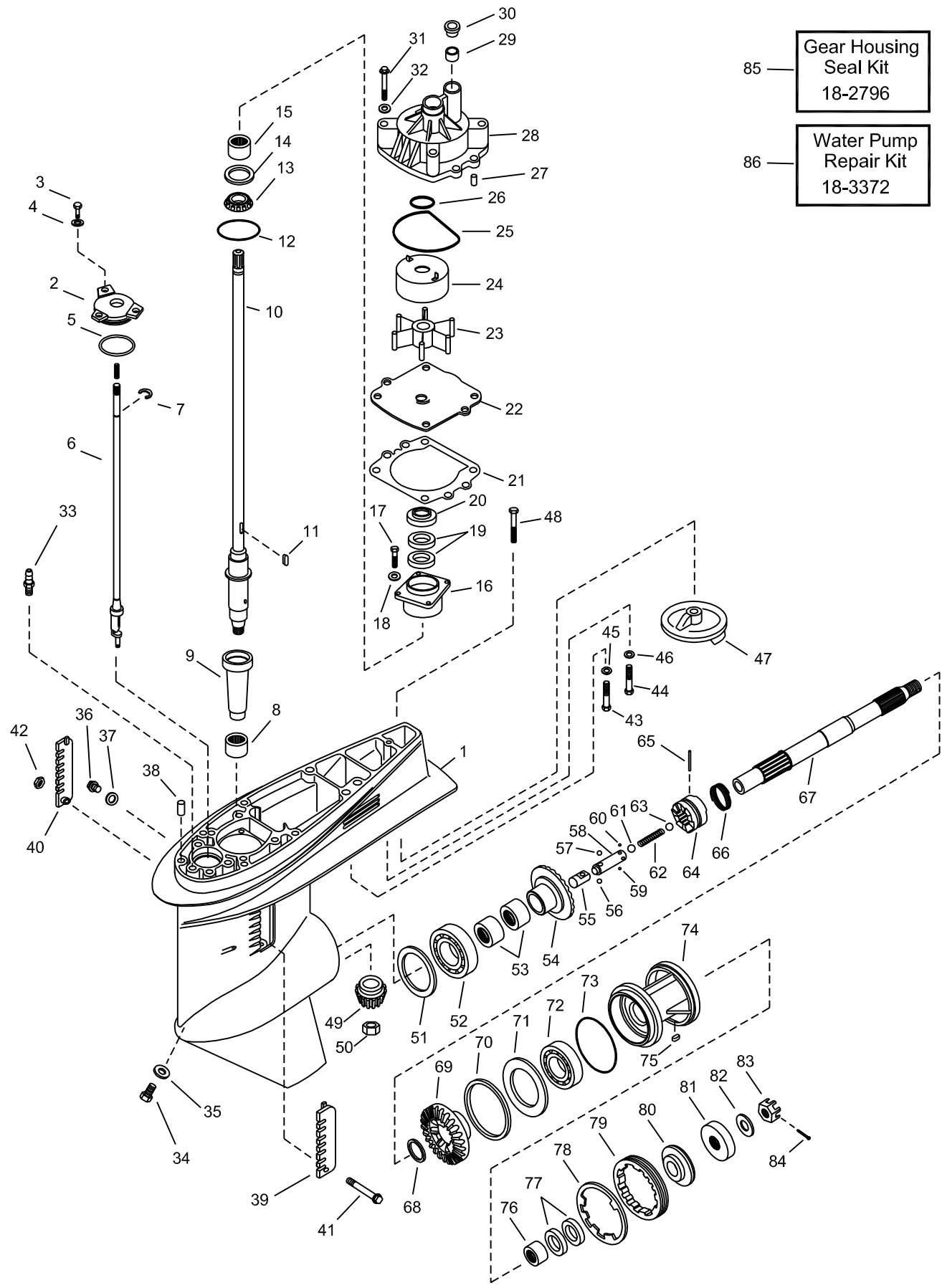

Figure #	Description	Part #	O.E.M. #	Qty.	Figure #	Description	Part #	O.E.M. #	Qty.
1	Housing, Gearcase	—	6E5-45301-03EK	1	47	Trim Tab	18-6097A	6E5-45371-01-00	1
2	Plate, Shift Rod Cover	—	6E5-45321-00-00	1	48	Bolt, Trim Tab	—	90105-10M00-00	1
3	Bolt, Shift Rod Cover	—	97395-06020-00	3	49	Gear Pinion	—	6E5-45551-02-00	1
4	Washer	—	90209-06M04-00	3	50	Nut, Pinion	—	90170-16M01-00	1
5	O-Ring, Plate	—	93210-5867-00	1	51	Shim (0.10mm)	—	6E5-45567-01-10	AR
6	Shift Rod Assembly	—	6E5-44150-01-00	1		Shim (0.12mm)	—	6E5-45567-01-12	AR
7	Circlip	—	99001-08600-00	1		Shim (0.15mm)	—	6E5-45567-01-15	AR
8	Bearing, Needle	—	93315-628U9-00	1		Shim (0.18mm)	—	6E5-45567-01-18	AR
9	Sleeve, Drive Shaft	—	6E5-45536-00-00	1		Shim (0.30mm)	—	6E5-45567-01-30	AR
10	Drive Shaft (long)	—	6E5-45501-01-00	1		Shim (0.40mm)	—	6E5-45567-01-40	AR
	Drive Shaft (x-long)	—	6E5-45501-21-00	1		Shim (0.50mm)	—	6E5-45567-01-50	AR
11	Key, Impeller	—	90280-04M05-00	1	52	Bearing, Forward Gear	—	93332-000U7-00	1
12	O-Ring, Housing	—	93210-54534-00	1	53	Bearing, Needle	—	93315-425U7-00	2
13	Bearing, Tapered	—	93341-930U0-00	1	54	Gear, Forward	—	6E5-45560-01-00	1
14	Shim (0.10mm)	—	6E5-45587-01-10	AR	55	Shifter	—	6E5-45641-01-00	1
	Shim (0.12mm)	—	6E5-45587-01-12	AR	56	Ball, Detent	—	93507-32031-00	1
	Shim (0.15mm)	—	6E5-45587-01-15	AR	57	Ball, Detent	—	93507-32031-00	1
	Shim (0.18mm)	—	6E5-45587-01-18	AR	58	Slide, Shift	—	6E5-45634-01-00	1
	Shim (0.30mm)	—	6E5-45587-01-30	AR	59	Ball, Detent	—	93503-16010-00	1
	Shim (0.40mm)	—	6E5-45587-01-40	AR	60	Ball, Detent	—	93503-16010-00	1
	Shim (0.50mm)	—	6E5-45587-01-50	AR	61	Ball, Detent	—	93511-32027-00	1
15	Bearing, Needle	—	93315-430V5-00	1	62	Spring, Compression	—	90501-16M37-00	1
16	Housing, Bearing	—	6E5-45331-0094	1	63	Ball, Detent	—	93511-32027-00	1
17	Bolt, Bearing Housing	—	97395-08025-00	4	64	Clutch, Dog	—	6R5-45631-01-00	1
18	Washer	—	92990-08600-00	4	65	Cross Pin, Clutch	—	90250-08M07-00	1
19	Seal, Drive Shaft	18-0265	93101-28M16-00	2	66	Retainer, Cross Pin	—	6E5-45631-01-00	1
20	Cover, Oil Seal	—	6E5-45344-00-00	1	67	Shaft, Propeller	18-2385	6E5-45611-01-00	1
21	Gasket, Wear Plate	18-0244	6E5-44315-A0-00	1	68	Washer, Thrust	—	90201-30M92-00	1
22	Wear Plate	18-3344	6G5-44323-00-00	1	69	Gear, Reverse	—	6E5-45571-04-00	1
23	Impeller	18-3071	6E5-44352-00-00	1	70	Shim (0.10mm)	—	6L6-45577-00-10	AR
24	Insert, Water Pump	—	6E5-44322-00-00	1		Shim (0.12mm)	—	6L6-45577-00-12	AR
25	O-Ring, Water Pump	18-7485	93210-86M38-00	1		Shim (0.15mm)	—	6L6-45577-00-15	AR
26	O-Ring, Water Pump	18-7483	93210-37M67-00	1		Shim (0.18mm)	—	6L6-45577-00-18	AR
27	Pin, Water Pump Housing	—	93606-12019-00	2		Shim (0.30mm)	—	6L6-45577-00-30	AR
28	Housing, Water Pump	18-3170	6E5-44311-00-00	1		Shim (0.40mm)	—	6L6-45577-00-40	AR
29	Damper, Water Seal	—	6E5-44365-00-00	1		Shim (0.50mm)	—	6L6-45577-00-50	AR
30	Cover, Pump Housing	—	6E5-44312-00-0	1	71	Washer, Thrust	—	6E5-45576-00-00	1
31	Bolt, Water Pump	—	97080-08045-00	4	72	Bearing, Reverse Gear	—	93306-208U0-00	1
32	Washer	—	90209-08M02-00	4	73	O-Ring, Bearing Housing	—	93210-86M39-00	1
33	Nipple, Hose	—	6E5-45378-00-00	1	74	Housing, Bearing	—	6E5-45332-00-94	1
34	Drain, Plug Lower	18-2374	688-45341-00-00	1	75	Key, Bearing Housing	—	90282-04010-00	1
35	Gasket, Drain Plug	18-4698	90430-08020-00	1	76	Bearing, Needle	—	93315-430U8-00	1
36	Drain Plug Upper	—	90340-08M04-00	1	77	Seal, Prop Shaft	18-0266	93101-30M17-00	2
37	Gasket, Drain Plug	18-4698	90430-08020-00	1	78	Washer, Tab	—	688-45383-02-00	1
38	Pin, Locating	—	93608-12M05-00	2	79	Nut, Cover	—	688-45384-00-00	1
39	Cover, Water Inlet (Port)	—	688-45214-02-00	1	80	Washer, Thrust	—	6E5-45987-01-00	1
40	Cover, Water Inlet (Stbd)	—	688-45215-02-00	1	81	Spacer, Prop	18-4274	688-45997-01-00	1
41	Screw, Water Inlet	—	90142-05M03-00	1	82	Washer, Prop	—	92990-18200-00	1
42	Nut, Water Inlet	—	90185-05002-00	1	83	Nut, Prop	18-3726	90171-18M04-00	1
43	Bolt	—	97395-10070-00	1	84	Pin, Cotter	18-3735	91490-40030-00	1
44	Bolt	—	97395-10070-00	1	85	Gear Housing Seal Kit	18-2796	6E5-W0001-51-00	1
45	Washer	—	92990-10100-00	1	86	Water Pump Repair Kit	18-3372	6E5-W0078-00-00	1
46	Washer	—	92990-10100-00	1					

AR As required

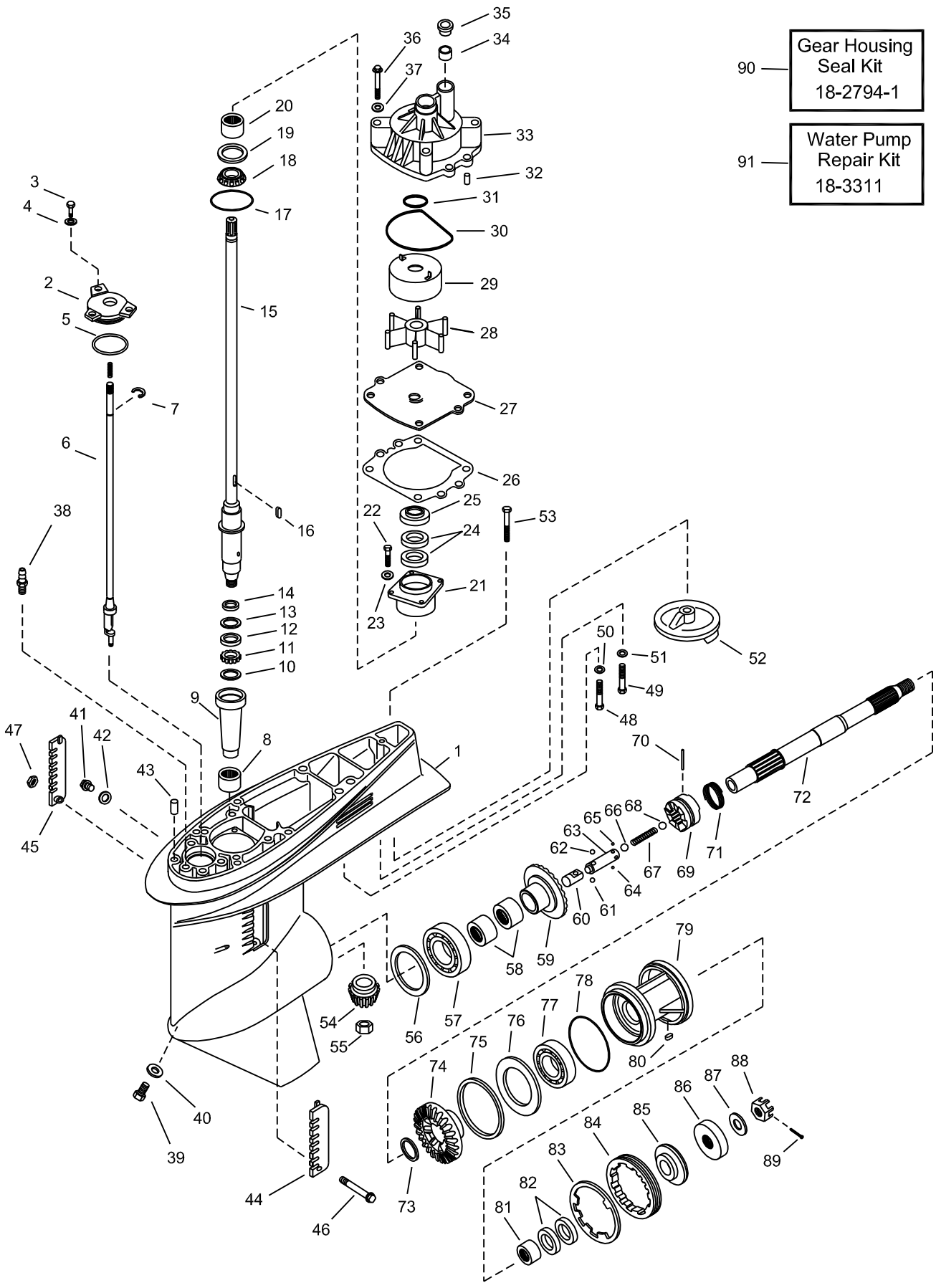
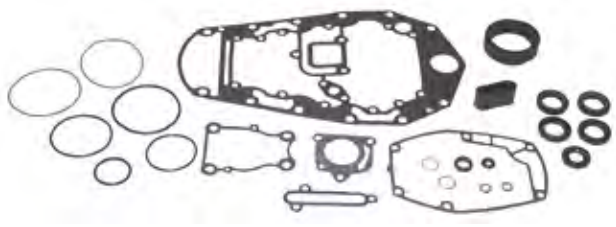

Figure #	Description	Part #	O.E.M. #	Qty.	Figure #	Description	Part #	O.E.M. #	Qty.
1	Housing, Gearcase	—	6J9-45301-02-Ek	1	49	Bolt	—	97395-10070-00	1
2	Plate, Shift Rod Cover	—	6E5-45321-00-00	1	50	Washer	—	92990-10100-00	1
3	Bolt, Shift Rod Cover	—	97395-06020-00	3	51	Washer	—	92990-10100-00	1
4	Washer	—	90209-06M04-00	3	52	Trim Tab	18-6035	6J9-45371-01-00	1
5	O-Ring, Plate	—	93210-58677-00	1	53	Bolt, Trim Tab	—	90105-10M00-00	1
6	Shift Rod Assembly	—	6G5-44150-01-00	1	54	Gear Pinion	—	6G5-45551-01-00	1
7	Circlip	—	99001-08600-00	1	55	Nut, Pinion	—	90170-16M01-00	1
8	Bearing, Needle	—	90250-08M07-00	1	56	Shim (0.10mm)	—	6G5-45567-01-10	AR
9	Sleeve, Drive Shaft	—	6G5-45536-01-00	1		Shim (0.12mm)	—	6G5-45567-01-12	AR
10	Washer	—	90209-33M13-00	1		Shim (0.15mm)	—	6G5-45567-01-15	AR
11	Spring, Compression	—	90501-05M64-00	AR		Shim (0.18mm)	—	6G5-45567-01-30	AR
12	Collar	—	90387-33M00-00	1		Shim (0.30mm)	—	6G5-45567-01-40	AR
13	Washer	—	90209-33M13-00	1		Shim (0.40mm)	—	6G5-45567-01-50	AR
14	Washer	—	90209-33M12-00	1		Shim (0.50mm)	—	6G5-45567-01-10	AR
15	Drive Shaft (long)	—	6G5-45501-01-00	1	57	Bearing, Forward Gear	—	93332-00V3-00	1
	Drive Shaft (x-long)	—	6G5-45501-21-00	1	58	Bearing, Needle	—	93315-425V3-00	2
16	Key, Impeller	—	90280-04M05-00	1	59	Gear, Forward	—	6G5-45631-00-00	1
17	O-Ring, Housing	—	93210-54534-00	1	60	Shifter	—	6E5-45641-01-00	1
18	Bearing, Tapered	—	93341-930U0-00	1	61	Ball, Detent	—	93507-32031-00	1
19	Shim (0.10mm)	—	6E5-45587-01-10	AR	62	Ball, Detent	—	93507-32031-00	1
	Shim (0.12mm)	—	6E5-45587-01-12	AR	63	Slide, Shift	—	6E5-45634-01-00	1
	Shim (0.15mm)	—	6E5-45587-01-15	AR	64	Ball, Detent	—	93503-16010-00	1
	Shim (0.18mm)	—	6E5-45587- 01-18	AR	65	Ball, Detent	—	93503-16010-00	1
	Shim (0.30mm)	—	6E5-45587-01-30	AR	66	Ball, Detent	—	93511-32027-00	1
	Shim (0.40mm)	—	6E5-45587-01-40	AR	67	Spring, Compression	—	90501-16M37-00	1
	Shim (0.50mm)	—	6E5-45587-01-50	AR	68	Ball, Detent	—	93511-32027-00	1
20	Bearing, Needle	—	93315-430V5-00	1	69	Clutch, Dog	—	6E5-45633-01-00	1
21	Housing, Bearing	—	6E5-45331-00-94	1	70	Cross Pin, Clutch	—	90250-08M07-00	1
22	Bolt, Bearing Housing	—	97395-08025-00	4	71	Retainer, Cross Pin	—	6E5-45633-01-00	1
23	Washer	—	92990-08600-00	4	72	Shaft, Propeller	—	6J9-45611-01-00	1
24	Seal, Drive Shaft	18-0265	93101-28M16-00	2	73	Washer, Thrust	—	90201-30M92-00	1
25	Cover, Oil Seal	—	6E5-45344-00-00	1	74	Gear, Reverse	—	6G5-45571-02-00	1
26	Gasket, Wear Plate	18-0244	6E5-44315-A0-00	1	75	Shim (0.10mm)	—	6G5-45577-02-10	AR
27	Wear Plate	18-3345	6G5-44323-00-00	1		Shim (0.12mm)	—	6G5-45577-02-12	AR
28	Impeller	18-3071	6E5-44352-00-00	1		Shim (0.15mm)	—	6G5-45577-02-15	AR
29	Insert, Water Pump	—	6E5-44322-00-00	1		Shim (0.18mm)	—	6G5-45577-02-18	AR
30	O-Ring, Water Pump	18-7485	93210-86M38-00	1		Shim (0.30mm)	—	6G5-45577-02-30	AR
31	O-Ring, Water Pump	18-7483	93210-37M67-00	1		Shim (0.40mm)	—	6G5-45577-02-40	AR
32	Pin, Water Pump Housing	—	93606-12019-00	2		Shim (0.50mm)	—	6G5-45577-02-50	AR
33	Housing, Water Pump	18-3170	6E5-44311-00-00	1	76	Washer, Thrust	—	6G5-45576-00-00	1
34	Damper, Water Seal	—	6E5-44365-00-00	1	77	Bearing, Reverse Gear	—	93306-209U0-00	1
35	Cover, Pump Housing	—	6E5-44312-00-00	1	78	O-Ring, Bearing Housing	18-0275	93210-97M55-00	1
36	Bolt, Water Pump	—	97080-08045-00	4	79	Bearing Housing Assembly	—	6J9-45332-00-94	1
37	Washer	—	90209-08M02-00	4	80	Key, Bearing Housing	—	90282-04010-00	1
38	Nipple, Hose	—	6E5-45378-00-00	1	81	Bearing, Needle	—	93315-430U8-00	1
39	Drain, Plug Lower	18-2374	688-45341-00-00	1	82	Seal, Prop Shaft	18-0266	93101-30M17-00	2
40	Gasket, Drain Plugs	—	90430-08020-00	2	83	Washer, Tab	—	9G5-45383-01-00	1
41	Drain Plug Upper	—	90340-08M04-00	1	84	Nut, Cover	—	6G5-45384-00-00	1
42	Gasket, Drain Plugs	—	90430-08020-00	2	85	Washer, Thrust	—	6E5-45987-00-00	1
43	Pin, Locating	—	93608-12M05-00	2	86	Spacer, Prop	18-4274	688-45997-01-00	1
44	Cover, Water Inlet (Port)	—	6J9-45214-00-00	1	87	Washer, Prop	—	92990-18200-00	1
45	Cover, Water Inlet (Stbd)	—	6J9-45215-00-00	1	88	Nut, Prop	18-3726	90171-18M04-00	1
46	Screw, Water Inlet	—	90142-05M04-00	1	89	Pin, Cotter	18-3735	91490-40030-00	1
47	Nut, Water Inlet	—	90185-05002-00	1	90	Gear Housing Seal Kit	18-2794-1	6G5-W0001-21-00	1
48	Bolt	—	97395-10070-00	1	91	Water Pump Repair Kit	18-3311	6G5-W0078-00-00	1

AR As required



18-0020
GEAR HOUSING SEAL KIT

Replaces: 67C-W0001-21-00
For: T25 (2001-02) / F30 (2002) F40 (2002) 3 cyl model

— CONTAINS —

Part #	Desc.	O.E.#	Qty.
18-0296	Seal, Propshaft	93101-22067	2
18-4698	Drain Fill Washer	90430-08020-00	2
18-4698	Drain Fill Washer	604-45342-00-00	2
18-4698	Drain Fill Washer	90430-08020-00	2



18-0021
GEAR HOUSING SEAL KIT

Replaces: 688-W0001-22-00
For: C75 (1994-99) / E75 (1995-00) / P75 (1996-99)
C80 (1997) / C85 (1992-96) / 90 (1992-02) B90(1998-99) / C90 (1997-01)

— CONTAINS —

Part #	Desc.	O.E.#	Qty.
18-0239	Gasket	688-44315-A0	1
18-0240	Gasket	688-44316-A0	1
18-7436	O-Ring	93210-46044-00-00	2
18-0267	Oil Seal	93106-09014	1
18-0587	Oil Seal	93101-25M03	4
18-4698	Plug, Drain	90430-08020	2



18-0022
GEAR HOUSING SEAL KIT

Replaces: 689-W0001-23-00
For: C25 (1992-97) / C30 (1992)

— CONTAINS —

Part #	Desc.	O.E.#	Qty.
18-99010	Exhaust Manifold Gasket	664-41134-A0-00	1
18-0296	Seal, Propshaft	93101-22067	2
18-0554	Seal	93101-20M07	2
18-0773	Gasket	689-44316-A0	1
18-4698	Plug, Drain	90430-08020	3



18-0023
GEAR HOUSING SEAL KIT

Replaces: 689-W0001-C2-00
For: C25 (1986-87) C25 (1990-91) 30 (1986) C30 (1990-91)

— CONTAINS —

Part #	Desc.	O.E.#	Qty.
18-99010	Exhaust Manifold Gasket	664-41134-A0-00	1
18-0554	Seal	93101-20M07	2
18-4698	Plug, Drain	90430-08020	3



18-0024
GEAR HOUSING SEAL KIT

Replaces: 698-W0001-21-00
For: E48 (1995-00) / C55 (1989-94)

— CONTAINS —

Part #	Desc.	O.E.#	Qty.
18-0292	Gasket	663-44315-A0	1
18-0294	Gasket	663-44324-A0	1
18-0297	Seal, Drive Shaft	93101-23070	2
18-0296	Seal, Propshaft	93101-22067	2
18-0298	O-Ring	93210-41042	1
18-7160	O-Ring	93210-66M98	1
18-4698	Plug, Drain	90430-08020	3



18-0025
GEAR HOUSING SEAL KIT

Replaces: 69G-W0001-20-00
For: T8 (2001-04)

— CONTAINS —

Part #	Desc.	O.E.#	Qty.
18-7442	O-Ring	93210-74M68	1
18-4698	Plug, Drain	90430-08020	2



18-0026
GEAR HOUSING SEAL KIT
 Replaces: 6A1-W0001-C2-00
 For: 2HP (1986-88)

— CONTAINS —

Part #	Desc.	O.E.#	Qty.
18-4698	Plug, Drain	90430-08020	2



18-0027
GEAR HOUSING SEAL KIT
 Replaces: 6A1-W0001-C3-00
 For: 2HP (1989-02)

— CONTAINS —

Part #	Desc.	O.E.#	Qty.
18-4698	Plug, Drain	90430-08020	2



18-0028
GEAR HOUSING SEAL KIT
 Replaces: 6E0-W0001-C1-00
 For: 4HP (1984-99) / F4 (1999-02) / 5HP (1984-02)

— CONTAINS —

Part #	Desc.	O.E.#	Qty.
18-4698	Plug, Drain	90430-08020	3



18-0029
GEAR HOUSING SEAL KIT
 Replaces: 6G1-W0001-C1-00
 For: 6HP (1986-96) 8HP (1984-96)

— CONTAINS —

Part #	Desc.	O.E.#	Qty.
18-4698	Plug, Drain	90430-08020	3



18-0030
GEAR HOUSING SEAL KIT
 Replaces: 6L2-W0001-C3-00
 For: 20HP (1996-97) 25HP (1988-02) 2 cyl model

— CONTAINS —

Part #	Desc.	O.E.#	Qty.
18-0554	Seal	93101-20M07	2
18-4698	Plug, Drain	90430-08020	2



18-0031
GEAR HOUSING SEAL KIT
 Replaces: 6N0-W0001-C0-00
 For: 6HP (1997-00), 8HP (1997-04)

— CONTAINS —

Part #	Desc.	O.E.#	Qty.
18-4698	Plug, Drain	90430-08020	3



18-2785
GEAR HOUSING SEAL KIT
 Replaces: 689-W0001-21-00, 689-W0001-C1-00

— CONTAINS —

Part #	Desc.	O.E.#	Qty.
18-0776	Grommet	682-44365-00-00	1
18-0552	Grommet	689-44366-00-00	1
18-4698	Drain or Fill Washer Gasket	YSG-14090-90-8G	3
18-0554	Oil Seal	93101-20M07-00	1
18-0296	Oil Seal	93101-22067-00	2
18-7405	O-Ring	93210-40M10-00	1
18-0766	Exhaust Tube Gasket	664-41134-A0-00	1
18-0773	Wear Plate Gasket	689-44316-A0-00	1



18-2787
GEAR HOUSING SEAL KIT
 Replaces: 698-W0001-20-00, 698-W0001-C0-00

— CONTAINS —

Part #	Desc.	O.E.#	Qty.
18-4698	Drain or Fill Washer Gasket	YSG-14090-90-8G	3
18-0296	Oil Seal	93101-22067-00	2
18-0297	Oil Seal	93101-23070-00	2
18-0298	O-Ring	93210-41042-00	1
18-0299	O-Ring	93210-66M98-00	1
18-0292	Wear Plate to Pump Housing Gasket	663-44315-A0-00	1
18-0267	Oil Seal	93106-09014-00	1
18-0294	Wear Plate to Pump Base Gasket	663-44324-A0-00	1

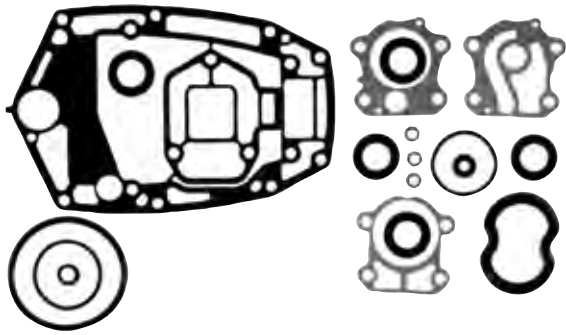

18-2788
LOWER UNIT SEAL KIT
 Replaces: 6H3-W0001-21-00, 6H3-W0001-C1-00
 — CONTAINS —

Part #	Desc.	O.E. #	Qty.
18-0240	Wear Plate to Gear Case Mounting Gasket	688-44316-A0-00	1
18-0756-1	Water Pump Gasket	6H3-44315-A0-00	1
18-0757	Outer Plate Gasket	6H3-44324-A0-00	1
18-4698	Drain or Fill Washer	YSG-14090-90-8G	3
18-0297	Oil Seal	93101-23070-00	2
18-0267	Oil Seal	93106-09014-00	1
18-7436	O-Ring	93210-46044-00	1

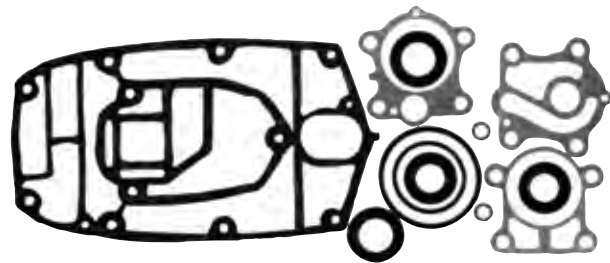

18-2789
LOWER UNIT SEAL KIT
 Replaces: 6J8-W0001-21-00, 6J8-W0001-C2-00
 — CONTAINS —

Part #	Desc.	O.E. #	Qty.
18-0292	Wear Plate to Pump Housing Gasket	663-44315-A0-00	1
18-0294	Wear Plate to Pump Base Gasket	663-44324-A0-00	1
18-4698	Drain or Fill Washer	YSG-14090-90-8G	2
18-0554	Oil Seal	93101-20M07-00	2
18-0297	Oil Seal	93101-23070-00	2
18-0298	O-Ring	93210-41042-00	1



18-2792
LOWER UNIT SEAL KIT
 Replaces: 6H4-W0001-21-00, 6H4-W0001-20-00
 — CONTAINS —

Part #	Desc.	O.E. #	Qty.
18-0292	Wear Plate to Pump Housing Gasket	663-44315-A0-00	1
18-0294	Wear Plate to Pump Base Gasket	663-44324-A0-00	1
18-4698	Drain or Fill Washer Gasket	YSG-14090-90-8G	2
18-0296	Oil Seal	93101-22067-00	2
18-0297	Oil Seal	93101-23070-00	2
18-0298	O-Ring	93210-41042-00	1
18-0299	O-Ring	93210-66M98-00	1
18-0293	Pump Base to Gearcase Gasket	663-44316-A0-00	1

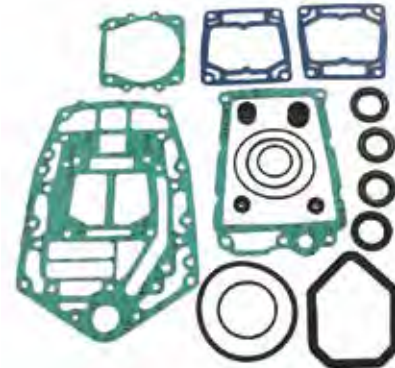

18-2794-1
LOWER UNIT SEAL KIT
 Replaces: 6F3-W0001-21-00, 6F3-W0001-C1-00
 6E5-W0001-51-00, 6E5-W0001-F1-00
 6G5-W0001-21-00, 6G5-W0001-C1-00
 — CONTAINS —

Part #	Desc.	O.E. #	Qty.
18-0244	Water Pump Gasket	6E5-44315-A0-00	1
18-4698	Drain or Fill Washer Gasket	YSG-14090-90-8G	2
18-0265	Oil Seal	93101-28M16-00	2
18-0266	Oil Seal	93101-30M17-00	2
18-0267	Oil Seal	93106-09014-00	1
18-7483	O-Ring	93210-37M67-00	1
18-7485	O-Ring	93210-86M38-00	1
18-0275	O-Ring	93210-97M55-00	1

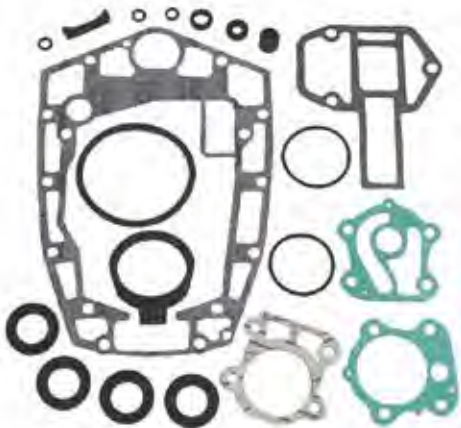

18-2798
LOWER UNIT SEAL KIT
 Replaces: 688-W0001-20-00, 688-W0001-C0-00
 — CONTAINS —

Part #	Desc.	O.E. #	Qty.
18-0240	Wear Plate to Gear Case Mounting Gasket	688-44316-A0-00	1
18-4698	Drain or Fill Washer Gasket	YSG-14040-90-8G	3
18-7436	O-Ring	93210-46044-00	1
18-0239	Wear Plate to Pump Housing Gasket	688-44315-A0-00	1
18-0267	Oil Seal	93106-09014-00	1

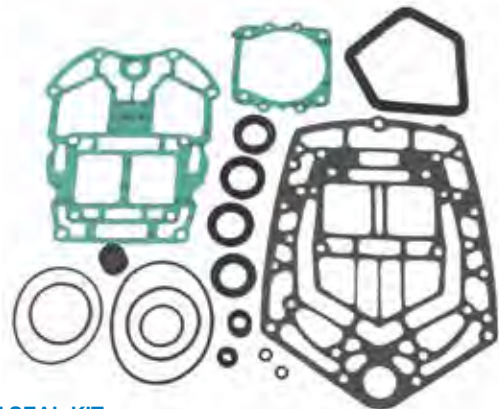

18-2799
LOWER UNIT SEAL KIT
 Replaces: 61A-W0001-21-00, 61A-W0001-C1-00
 — CONTAINS —

Part #	Desc.	O.E. #	Qty.
18-0244	Water Pump Gasket	6E5-44315-A0-00	1
18-4698	Drain or Fill Washer Gasket	YSG-14040-90-8G	2
18-0265	Oil Seal	93101-28M16-00	2
18-0266	Oil Seal	93101-30M17-00	1
18-0267	Oil Seal	93106-09014-00	1
18-7483	O-Ring	93210-37M67-00	1
18-7485	O-Ring	93210-86M38-00	1
18-7444	O-Ring	93210-04384-00	1



18-74501
GEAR HOUSING SEAL KIT
 Replaces: 683-W0001-C1-00
 Fits: Yamaha 9.9/15(1984-91)



18-74504
GEAR HOUSING SEAL KIT
 Replaces: 6H3-W0001-22-00
 Fits: Yamaha 60(2002), C60(1996-01), E60(1995-00), P60(1992-99), 70(1992-02)



18-74507
GEAR HOUSING SEAL KIT
 Replaces: 63V-W0001-21-00
 Fits: Yamaha 9.9(1997-00), 15(1997-00)



18-74510
GEAR HOUSING SEAL KIT
 Replaces: 65L-W0001-C0-00
 Fits: Yamaha 225/L225(1997-99), 3.1L, 250/L250(1997-99), SX225/SX250(2000-02), LX225/LX250(2000-02)



18-74512
GEAR HOUSING SEAL KIT
 Replaces: 66K-W0001-20-00
 Fits: Yamaha V200/V225(1998-99), VX200/VX225(2000-02), VX250(2002)



18-74515
GEAR HOUSING SEAL KIT
 Replaces: 68V-W0001-20-00
 Fits: Yamaha F115/LF115(2000-05)



18-74527
GEAR HOUSING SEAL KIT
 Replaces: 6G9-W0001-C6-00
 Fits: Yamaha F9.9(1997-05)



18-74535
GEAR HOUSING SEAL KIT
 Replaces: 67F-W0001-20-00
 Fits: Yamaha F75/F90(2003-05), F80/F100(1999-02)



18-74540
SEAL KIT
 Replaces: 62Y-W0001-20-00
 Fits: Yamaha F40 4cyl(1999), F50(1995-00)



18-74544
GEAR HOUSING SEAL KIT
 Replaces: 68T-W0001-20-00
 Fits: Yamaha F6/F8(2001-03)



18-74546
GEAR HOUSING SEAL KIT
 Fits: Yamaha T40/T30 Enduro International Series

GEAR HOUSING SEAL KIT APPLICATION

Model #	Year	Lower Unit Gasket Kit	Model #	Year	Lower Unit Gasket Kit	Model #	Year	Lower Unit Gasket Kit
2	1986-88	18-0026	C55	1992-95	18-0024	SX150	1999-04	18-2794-1
2	1989-02	18-0027	CV55	1989-90	18-2787	V150	2000-08	18-2794-1
4	1984-99	18-0028	P60	1991	18-2788	VX150	2000-04	18-2794-1
F4	1999-08	18-0028	70	1984-85, 1988-91	18-2788	VZ150	2000-11	18-2794-1
5	1984-02	18-0028	C75	1994-99	18-0021	175	1984-00	18-2794-1
6	1988-96	18-0029	E75	1995-00	18-0021	P175	1994-99	18-2794-1
6	1997-00	18-0031	P75	1996-99	18-0021	S175	1996-99	18-2794-1
8	1984-96	18-0029	C80	1997	18-0021	V175	2000	18-2794-1
8	1997-09	18-0031	C85	1991	18-2798	VZ175	2001-11	18-2794-1
T8	2001-10	18-0025	C85	1992-96	18-0021	Z175	2001-05	18-2794-1
20	1996-97	18-0030	CV85	1989-90	18-2798	200	1984-98	18-2794-1
25 ①	1984-85	18-2785	90	1984-91	18-2798	L200	1986-99	18-2794-1
25 ①	1986-87	18-0023	90	1992-09	18-0021	LX200	1999-01	18-2794-1
25 ①	1988-09	18-0030	B90	1997-99	18-0021	LZ200	2000-11	18-2794-1
25 ②	1997-02	18-2789	C90	1997-	18-0021	P200	1991-99	18-2794-1
C25	1991	18-0023	115	1986-09	18-2794-1	S200	1996-99	18-2794-1
C25 ①	1992-97	18-0022	C115	1992-00	18-2794-1	SX200	1999-05	18-2794-1
CV25	1990	18-0023	P115	1993-96	18-2794-1	VZ200	2001-04	18-2794-1
T25 ①	2002	18-0020	S115	1996-99	18-2794-1	Z200	2000-11	18-2794-1
30	1984-85	18-2785	130	1988-04	18-2794-1	V6 Special	1984-86	18-2794-1
30	1986	18-0023	L130	1989-01	18-2794-1	V6 Excel	1987-89	18-2794-1
30	1987-02	18-2789	S130	1996-99	18-2794-1	225 ③	1990-97	18-2794-1
C30	1991	18-0023	150	1984-09	18-2794-1	225 ④	1994-96	18-2799
C30	1992	18-0022	C150	1996-99	18-2794-1	L225 ④	1994-96	18-2799
F30 ②	2002	18-0020	L150	1986-99	18-2794-1	S225	1996	18-2799
40	1984-94	18-2792	LX150	1999-01	18-2794-1	250	1990-95	18-2799
C40	1992-94	18-99104	LZ150	2000-05	18-2794-1	L250	1990-96	18-2799
F40 ②	2002	18-0020	Z150	2000-05	18-2794-1	S250	1996	18-2799
50	1986-94	18-2792	P150	1991-99	18-2794-1			
PRO 50	1987-90	18-2792	PX150	1999	18-2794-1			
P50	1992-94	18-2792	PRO V150	1987-90	18-2794-1			
C55	1991	18-2787	S150	1996-99	18-2794-1			

① 2 cylinder model ② 3 cylinder model ③ 2.6 liter engine ④ 3.1 liter engine

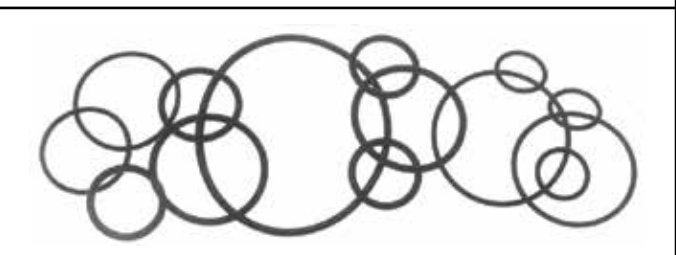

OIL SEALS

Part #	OE#	Dimensions		
		I.D.	O.D.	Width
18-0265	93101-28M16-00	27	43.25	7
18-0266	93101-30M17-00	28.5	45.25	7
18-0267	93106-09014-00	8.75	19.2	5.25
18-0296	93101-22067-00	23	36.25	6
18-0297	93101-23070-00	22.75	37.25	6
18-0554	93101-20M07-00	21.5	34	6.25
18-0570	93102-23096-00	22.75	38.25	7
18-0587	93101-25M03-00	24	40.25	6
18-0588	93102-25M28-00	24.5	48.4	8
18-2079	93101-22M15-00	21.75	35.2	6
18-2085	93102-35M13-00	34	52.25	8
18-2087	93102-40M36-00	39.5	58.25	8.5
18-2091	93104-22M07-00	22	29.25	5

O-RINGS

Part #	Std. Pkg.	O.E.#	Part #	Std. Pkg.	O.E.#
18-0275	1	93210-97M55-00	18-7470	1	65W-43865-00-00
18-0298	1	93210-41042-00	18-7471	1	93210-94003-00
18-0299	1	93210-66M98-00	18-7483	1	93210-37M67-00
18-7119	1	93210-33M85-00	18-7485	1	93210-86M38-00
18-7432 ⑤	2	93210-32738-00	18-7511-9	5	93210-16716-00
18-7436	1	93210-46044-00	18-76689	1	65W-14198-00-00
18-7439-9	5	93210-54M54-00	18-76690	1	93210-46M16-00
18-7442	1	93210-74M35-00	18-76691	1	93210-27ME3-00
18-7444	1	93211-04384-00	18-76692	1	93210-75M51-00
18-7463	1	93210-19123-00	18-76693	1	93210-31MJ5-00
18-7468	1	6G5-43864-00-00	18-76694	1	93210-24M79
18-7469	1	64E-43869-00-00			

⑤ This product is priced per piece. To order priced per package, please add -9 to the part number.



18-6859
SOLENOID

Replaces: Sea-Doo 278-001-376, 278-001-802
Sea-Doo PWC



18-6860
SOLENOID PLUG

Replaces: Sea-Doo
Used on Sea-Doo 1995 and UP



18-6862
STARTER

Replaces: Yamaha 6M6-81800-10-00, 64X-81800-00-00



18-6866
STARTER

Replaces: Sea-Doo 278-000-576, 278-000-577, 278-001-038, 278-001-301



18-6867
STARTER

Replaces: Sea-Doo 278-000-484, 278-000-485, 278-001-300, 278-001-935
Denso 228000-4550



18-6868
STARTER

Replaces: Sea-Doo 278-000-186, 311, 316
Denso 995435, 128000-4860, 61, 62, 63, 64



18-6869
STARTER

Replaces: Sea-Doo 278-001-497, 278-001-936



18-6873
STARTER

Replaces: Kawasaki 21163-3715, 21163-3719 Denso 428000-0081
99-2005 JH1200 Ultra 150 w/1176cc, 2002-05 JT1200 STX-R w/1176cc



18-6877
STARTER

Replaces: Honda PWC 31200-HW1-671



18-6904
STARTER

Replaces: Kawasaki 21163-3720, 21163-3721



18-6905
STARTER

Replaces: Sea-Doo 290-888-993, 999, 420-888-9933, -994, -996



18-6906
STARTER

Replaces: Yamaha PWC 64X-81800-00-00



18-6907
STARTER

Replaces: Yamaha PWC 6D3-81800-00-00
2005-08 VX1100 Wave Runner w/1100cc



18-6908
STARTER
 Replaces: Yamaha PWC 63M-81800-00-00



18-6909
STARTER
 Replaces: Yamaha PWC 6S5-81800-00-00



18-6919
STARTER
 Replaces: Arctic Cat PWC 3008-093, 3008-327, 3008-462, 3008-536



18-6921
STARTER
 Replaces: Yamaha PWC 60E-81800-00-00



18-6871
TRIM MOTOR
 Replaces: Sea-Doo 278-001-292



18-6875
TRIM MOTOR
 Replaces: Kawasaki PWC 21174-3703 Super Sport 750,900,110 ZXI, STX, XI



18-6650
VOLTAGE REGULATOR
 Replaces: 6M6-81960-A0-00
 Fits: Most models 1990-2014



18-6651
VOLTAGE REGULATOR
 Replaces: 66V-81960-00-00
 Fits: GP1200 (2000-02); XL, XLT1200 (1999-05)



18-6652
VOLTAGE REGULATOR
 Replaces: 6K8-81960-A0-00
 Fits: Waverunner 500 (1987-93)



18-6857
VOLTAGE REGULATOR
 Replaces: Yamaha PWC 63M-81960-00-00 800 1998-05; 1100 WR 1995-96; 1100 WV 1997



18-6858
VOLTAGE REGULATOR
 Replaces: Yamaha PWC 6H2-81960-00-00 GP1200 1997-99



18-6874
VOLTAGE REGULATOR
 Replaces: Sea-Doo 278-001-581 GTX 4-Tec 2003-04



18-6876
VOLTAGE REGULATOR
 Replaces: Sea-Doo 278-001-554



18-6878
VOLTAGE REGULATOR
 Replaces: Sea-Doo 278-000-123



18-6879
VOLTAGE REGULATOR
 Replaces: Sea-Doo 278-001-239



18-5129
COIL, IGNITION
 Replaces: 62L-85570-00-00
 Fits: 1994-1995 FX-1 FX700S, T



18-5146
COIL, LIGHTING
 Replaces: 62T-85533-00-00
 Fits: Wave Venture WVT700 (95-98); Wave Raider RA700 (94-97); Wave Raider Deluxe RA700 (1995); Wave Blaster WB700, WB760 (96-97); Wave Runner III WRA650 (1996); Wave Runner III WRA700 (1997); Waverunner GP760 97-00; Wave Runner XP760 (98-99); Wave Runner XL700 (99-04); Super Jet SJ700 (96-11)



18-5147
CHARGE COIL
 Replaces: Yamaha 62T-85520-00-00; 62T-85520-01-00
 Fits: Wave Raider RA700 (94-97); Wave Raider Deluxe (1995); Wave Venture WVT700 (95-98); Wave Runner III WRA650 (1996); Wave Runner III WRA700 (1997); Super Jet SJ700 (96-06); Wave Runner XL700 (99-04)



18-15080
IDLER GEAR ASSEMBLY
 Replaces: Polaris 3240120 Yamaha 6M6-8183E00-00
 Use with 18-6908, 18-6862 Yamaha Starters, fits some Kawasaki, Polaris, Sea-Doo and Tiger Shark PWC's.



18-8880
OIL FILTER
 Replaces: BRP 420956741 Yamaha 6M6-8183E00-00
 For: SeaDoo & 4 Stroke

Model	Year	Starter	Trim Motor	Voltage Regulator	Model	Year	Starter	Trim Motor	Voltage Regulator
YAMAHA					SEA-DOO (CONT.)				
EXS1200 Exciter	98-99	18-6908			GTI w/ 718cc	1996-97	18-6867		18-6878
EXT1100 Exciter	96-98	18-6908			GTI w/ 718cc	98-04	18-6867		18-6879
EXT1200 Exciter	98-99	18-6908			GTI w/ 718cc	2005	18-6867		
FX700 FX1 w/ 701cc	94-95	18-6862			GTI LE w/ 718cc	2002	18-6867		18-6879
FX1000 Wave Runner w/ 998cc	2002-05	18-6921			GTI LE w/ 718cc	2003	18-6867		
FX1100 Wave Runner w/ 1100cc	2004-05	18-6921			GTI LE w/ 718cc	2004	18-6867		
FX1800 FX Waverunner w/ 1812cc	2008	18-6909			GTI LE w/ 782cc	2005	18-6869		
GP760 Wave Runner w/ 760cc	97-00	18-6906			GTI LE RFI	2004			18-6876
GP800 Wave Runner w/ 784cc	98-05	18-6908		18-6857	GTI w/ 1494cc	2006-08	18-6905		
GP1200 Wave Runner w/ 1176cc	97-99	18-6908		18-6858	GTI RFI	2004			18-6876
GP1200 Wave Runner w/ 1176cc	2000-02	18-6908			GTI SE w/ 1494cc	2006-07	18-6905		
GP1300 Wave Runner w/ 1300cc	2003-08	18-6908			GTS w/ 581cc	92-94	18-6868		
LST1200	99-05	18-6908			GTS w/ 718cc	97-00	18-6867		18-6878
RA700 Wave Raider w/701cc	94-97	18-6862			GTS w/ 718cc	2001	18-6867		18-6879
RA760 Wave Raider w/ 760cc	1996	18-6906			GTS - 2 passenger w/ 581cc	1995	18-6867		
RA1100 Wave Raider w/ 1100cc	95-96	18-6908			GTS - 3 passenger w/ 581cc	95-96	18-6867		
SJ650 Super Jet w/ 650cc	90-93	18-6862			GTX w/ 581cc	1992	18-6868		
SJ700 Super Jet w/ 701cc	94-11	18-6862			GTX w/ 650cc	93-94	18-6868		
SRT1000	2003-05	18-6921			GTX - 2 passenger w/ 650cc	1995	18-6867		
SRT1100	2005	18-6921			GTX - 3 passenger w/ 650cc	1995	18-6867		
SUV 1200 w/1176cc	99-04	18-6908			GTX w/ 782cc	96-97	18-6866		
Wave Runner 1100cc	1995-96			18-6857	GTX DI	2000-03			18-6876
WB700 Wave Blaster w/ 701cc	93-96	18-6862			GTX RFI w/ 782cc	1998	18-6866		
WR650 Wave Runner LX w/ 650cc	90-94	18-6862			GTX RFI	2000-02			18-6876
WB760 Wave Blaster w/ 760cc	96-97	18-6906			GTX 155 w/ 1494cc	2008	18-6905		
WRA650 Wave Runner III w/650cc	90-96	18-6862			GTX 215 w/ 1494cc	2008	18-6905		
WRA700 Wave Runner III w/ 701cc	94-97	18-6862			GTX 4-Tec w/ 1494cc	2002	18-6905		
WRB650 Wave Runner w/ 650cc	91-95	18-6862			GTX 4-Tec w/ 1494cc	2003-04	18-6905		18-6874
WRB700 Wave Runner w/ 700cc	93-94	18-6862			GTX 4-Tec w/ 1494cc	2005-08	18-6905		
WVT700 Wave Vent w/ 701cc	95-98	18-6862			GTX Wake w/ 1494cc	2005-07	18-6905		
WVT760 Wave Venture w/ 760cc	1997	18-6906			GTX Wake 155 w/ 1494cc	2005-08	18-6905		
WVT1100 Wave Vent w/ 1100cc	1996	18-6908			GTX Wake 215 w/ 1494cc	2008	18-6905		
WVT1100 Wave Vent w/ 1100cc	1997	18-6908		18-6857	HX w/ 718cc	1995	18-6867		
VX1100 Wave Runner w/ 1100cc	2005-08	18-6907			HX w/ 718cc	96-97	18-6867		18-6878
XL700 Wave Runner w/ 701cc	99-04	18-6862			LRV DI	2002			18-6876
XL760 Wave Runner w/ 760cc	1997	18-6906			RX	2001-02		18-6871	
XL800 Wave Runner w/ 784cc	00-01	18-6908			RX DI	00-03		18-6871	18-6876
XL1200 Wave Runner w/ 1176cc	98-00	18-6908			RX limited	2000		18-6871	
XLT800 Wave Runner w/ 784cc	2002-04	18-6908			RXP w/ 1494cc	2004-05	18-6905	18-6871	
XLT1200 Wave Runner w/ 1176cc	2001-05	18-6908			RXP w/ 1494cc	2006-07	18-6905		
XRT1200	00-01	18-6908			RXP 155 w/ 1494cc	2008	18-6905		
SEA-DOO					RXP 215 w/ 1494cc	2008	18-6905		
3D DI w/ 782cc	2004-05	18-6869			RXP X 255 w/ 1494cc	2008	18-6905		
3D DI w/ 1494cc	2007	18-6905			RXT w/ 1494cc	2005-07	18-6905		
Explorer	93-94	18-6868			RXT 215 w/ 1494cc	2008	18-6905		
Explorer	95-97	18-6867			RXT 255 w/ 1494cc	2008	18-6905		
GS w/ 718cc	97-01	18-6867		18-6879	SP w/ 581cc	92-94	18-6868		
GSI w/ 718cc	1997	18-6867	18-6871	18-6879	SP w/ 581cc	1995	18-6867		
GSX RFI w/ 782cc	1999	18-6869			SP w/ 581cc	1996	18-6867		18-6878
GSX RFI w/ 782cc	2000	18-6869		18-6876	SP w/ 718cc	1997	18-6867		
GSX RFI w/ 782cc	2001	18-6869			SPI w/ 581cc	93-94	18-6868		
GSX w/ 782cc	1996	18-6866	18-6871	18-6879	SPI w/ 581cc	1995	18-6867		
GSX w/ 782cc	1997	18-6866	18-6871	18-6879	SPI w/ 581cc	1996	18-6867		18-6878
GSX limited	1998		18-6871		SPX w/ 581cc	1993	18-6868		

















APPLICATION CONTINUED ON NEXT PAGE

Model	Year	Starter	Trim Motor	Voltage Regulator	Model	Year	Starter	Trim Motor	Voltage Regulator
SEA-DOO (CONT.)					ARCTIC CAT (Cont.)				
SPX w/ 650cc	1994	18-6868			Monte Carlo 640 w/ 639cc	94-97	18-6919		
SPX w/ 650cc	1995	18-6867			Monte Carlo 770 w/ 768cc	96-97	18-6919		
SPX w/ 718cc	1996	18-6867	18-6871	18-6878	Monte Carlo 900 w/ 900cc	1996	18-6919		
SPX w/ 782cc	1997	18-6867	18-6871		Monte Carlo 1000 w/ 999cc	1997	18-6919		
SPX w/ 782cc	98-99	18-6866	18-6871		Montego 640 w/ 639cc	94-97	18-6919		
XP w/ 581cc	1992	18-6868			Montego Dlx 640 w/639cc	94-97	18-6919		
XP w/ 650cc	93-94	18-6868			Tigershark 640 w/639cc	1993	18-6919		
XP w/ 718cc	1995	18-6867	18-6871		Tigershark 900 w/900cc	1995	18-6919		
XP w/ 782cc	96-97	18-6866	18-6871		TS640 w/639cc	1993	18-6919		
XP	2002		18-6871		TS770, 770L, 770R w/ 768cc	98-99	18-6919		
XP800	ALL but '95			18-6878	TS900L w/ 900cc	1999	18-6919		
XP800	1995		18-6871		TS1000L, R w/ 999cc	1998	18-6919		
XP DI	2003-04			18-6876	TS1100Li, R w/ 1100cc	1999	18-6919		
XP Limited VTS motor	98-05		18-6871		KAWASAKI				
Challenger	1998	18-6867			JH1200 Ultra 150 w/ 1176cc	99-05	18-6873		
Challenger	96-99	18-6866			JT1200 STX-R w/ 1176cc	2002-05	18-6873		
Challenger	2004-07	18-6905			JT1200 STX-12F w/1199cc	2003-07		18-6904	
Challenger 180, 230	2008	18-6905			JT1500 STX-15F w/1498cc	2004-09		18-6904	
Islandia	2004-08	18-6905			JT1500 Ultra 250X w/ 1498cc	2007-09		18-6904	
Speedster	98-99	18-6866			JT1500 Ultra LX w/ 1498cc	2007-09		18-6904	
Speedster	95-99	18-6867			Super Sport 750	ALL		18-6875	
Speedster	2004-07	18-6905			Super Sport 900	ALL		18-6875	
Speedster 150, 200	2008	18-6905			Super Sport 110	ALL		18-6875	
Speedster Wake	2008	18-6905			Super Sport ZXI	ALL		18-6875	
Sportster	95-99	18-6867			Super Sport STX	ALL		18-6875	
Sportster	2003-06	18-6905			Super Sport XI	ALL		18-6875	
Utopia	2004-08	18-6905			HONDA				
ARCTIC CAT					Aquatrax F-12 w/ 1235cc	2002-07	18-6877		
Barracuda 639cc	94-95	18-6919			Aquatrax F-12X w/ 1235cc	2002-07	18-6877		
Daytona w/ 639cc	93-95	18-6919			Aquatrax F-12X GPSC w/ 1235cc	2005-07	18-6877		
Daytona 770 w/ 768cc	96-97	18-6919			Aquatrax R-12 w/ 1235cc	2004-06	18-6877		
Daytona 1000 w/ 999cc	1997	18-6919			Aquatrax R-12X w/ 1235cc	2003-07	18-6877		







Sierra
Marine Engine and Drive Parts

IMPELLERS/IMPELLER KITS FOR JABSCO

 <p>18-3275 IMPELLER KIT Replaces: Jabsco 17935-0001 For: TAMD74A, A-A, A-B (2000-05); TAMD74C-A, C-B (2000-05); TAMD74L-A, B (1999-2005); TAM-D74P-A, P-B (1998-2005); TAMD75P-A (1998-2005); TAMD71B (1989-2000); TAMD73P-A (1997-98); TAMD73WJ-A (1997-99)</p>	 <p>18-3304 IMPELLER KIT Replaces: Jabsco 6760-0001 For: F9B Pumps DIA. 3 3/4" SIDE WIDTH 3 1/2" (Neoprene)</p>	 <p>18-3076 IMPELLER KIT Includes: Impeller & Gaskets Replaces: Jabsco 22405-0001</p>	
 <p>18-3306 IMPELLER KIT Replaces: Jabsco 13554-0001 Yanmar 119773-42600-00 DIA 2 1/4" SIDE WIDTH 1 15/16" (Neoprene)</p>	 <p>18-3036 IMPELLER KIT Replaces: Jabsco 673-0003 (Nitrile)</p>	 <p>18-3038 IMPELLER KIT Replaces: Jabsco 920-0003, 17937-0003 (Nitrile)</p>	
 <p>18-3077 IMPELLER KIT Replaces: Jabsco 920-0001 12 SPLINES 8 FINS (Neoprene)</p>	 <p>①18-3046D Display Package 18-3046 IMPELLER KIT Replaces: Jabsco 18838-0001</p>	 <p>18-3047 IMPELLER KIT Replaces: Jabsco 18948-0001</p>	
 <p>①18-3081D Display Package 18-3081 IMPELLER KIT Replaces: Jabsco 1210-0001 12 SPLINES 12 FINS</p>	 <p>18-3080 IMPELLER KIT Replaces: Jabsco 673-0001 Diameter 2" • Side Width 7/8" (Neoprene)</p>	 <p>18-3078 IMPELLER KIT Replaces: Jabsco 836-0001 Cummins 160596, 166758, 556540, 556850, 21601R Diameter 3 3/4" • Side Width 2 1/2" (Neoprene)</p>	
 <p>18-3079 IMPELLER KIT Replaces: Jabsco 4528-0001 Diameter 1 9/16" • Side Width 3/4" (Neoprene)</p>	 <p>①18-3075D Display Package 18-3075 IMPELLER KIT Replaces: Jabsco 4568-0001, 2877-0001, 14510-46090, 124310-46090 Diameter 2 1/4" • Side Width 1 1/4" (Neoprene)</p>	 <p>18-3037 IMPELLER KIT Replaces: Jabsco 836-0003 Diameter 3 3/4" • Side Width 2 1/2" (Nitrile)</p>	 <p>18-45713 IMPELLER KIT Replaces: Jabsco 18653-0001 Fits: F4B Pump</p>

① Items ending in "D" are Display Packaged - Regular number is Non-Display

 18-3020 IMPELLER Replaces: Jabsco 1210-0003 (Nitrile)	 18-3021 IMPELLER Replaces: Jabsco 4598-0001 Diameter 2 9/16" • Side Width 2" (Neoprene)	 18-45712 IMPELLER Replaces: Jabsco 17636-0001, 21676-0001 Fits: F9B-9 Pump	PKG. OF 2  18-3125 18-3125-9① WATER PUMP GASKET Replaces: Jabsco 3101-0000	 18-2005 SEAL Replaces: Jabsco 92700-0060
--	---	--	---	--

JABSCO COMPONENT APPLICATIONS

Pump Model	Impeller Kit	Oil Seal	Pump Model	Impeller Kit	Oil Seal	Pump Model	Impeller Kit	Oil Seal
777-0001	18-3077	18-2005	1673-9051	18-3081	—	3890-9011	18-3077	—
777-0003	18-3077	—	2300-9001	18-3077	—	5330-9001	18-3077	—
777-9003	18-3077	—	2300-9003	18-3077	—	5330-9101	18-3077	—
777-9004	18-3077	—	2300-9004	18-3077	—	5560-0001	18-3077	18-2005
777-9005	18-3077	—	2300-9005	18-3077	—	5660-0001	18-3077	18-2005
777-9051	18-3077	—	3270-0001	18-3081	18-2005	5850-0001	18-3081	18-2005
1673-0001	18-3081	18-2005	3270-0003	18-3081	18-2005	7120-9001	18-3077	—
1673-0003	18-3081	18-2005	3290-9001	18-3081	—	7320-9001	18-3077	—
1673-1001	18-3081	18-2005	3380-0001	18-3081	18-2005	8170-9001	18-3077	—
1637-1003	18-3081	18-2005	3480-9002	18-3081	—	17120-0001	18-3079	18-2005
1673-9001	18-3081	—	3480-9011	18-3081	—	22740-0301	—	18-2005
1673-9003	18-3081	—	3590-9001	18-3079	—	22740-0351	—	18-2005

IMPELLERS/IMPELLER KITS FOR JOHNSON PUMP

 18-3275 IMPELLER KIT Replaces: Johnson Pump 09-819B For: TAMD74A, A-A, A-B (2000-05); TAMD74C-A, C-B (2000-05); TAMD74L-A, B (1999-2005); TAM-D74P-A, P-B (1998-2005); TAMD75P-A (1998-2005); TAMD71B (1989-2000); TAMD73P-A (1997-98); TAMD73WJ-A (1997-99)	 18-3080 IMPELLER KIT Replaces: Johnson Pump 09-1026B Diameter 2" • Side Width 7/8" (Neoprene)	 18-3077 IMPELLER KIT Replaces: Johnson Pump 09-1028B Yanmar 127610-42200 Cummins 650607 12 SPLINES 8 FINS
② 18-3081D   18-3081 IMPELLER KIT Replaces: Johnson Pump 09-1027B 12 SPLINES 12 FINS	② 18-3075D   18-3075 IMPELLER KIT Replaces: Johnson Pump 09-801B Diameter 2 1/4" • Side Width 1 1/4" For: Johnson Pump # F4B-8007 (Neoprene)	 18-3079 IMPELLER KIT Replaces: Johnson Pump 09-806B, Yanmar 104211-42070 Diameter 1 9/16" • Side Width 3/4" (Neoprene)
 18-3037 IMPELLER KIT Replaces: Johnson Pump 09-1029B-9 (Nitrile)	 18-3078 IMPELLER KIT Replaces: Johnson Pump 09-1029B Diameter 3 3/4" • Side Width 2 1/2" For: Johnson Pump #'s F8B-3000, F8B500, F8B-8007, F8B-50017 (Neoprene)	 18-3306 IMPELLER KIT Replaces: Johnson Pump 09-812B
 18-3037 IMPELLER KIT Replaces: Johnson Pump 09-1029B-9 (Nitrile)	 18-3078 IMPELLER KIT Replaces: Johnson Pump 09-1029B Diameter 3 3/4" • Side Width 2 1/2" For: Johnson Pump #'s F8B-3000, F8B500, F8B-8007, F8B-50017 (Neoprene)	 18-3036 IMPELLER KIT Replaces: Johnson Pump 09-1026B-9 (Nitrile)

① Priced per Package

② Items ending in "D" are Display Packaged - Regular number is Non-Display



**18-3038
IMPELLER KIT**
Replaces: Johnson Pump 09-1028B-9 (Nitrile)



**18-3076
IMPELLER KIT**
Includes: Impeller & Gaskets
Replaces: Johnson Pump 09-808B, 09-45589



**18-3089
WATER PUMP KIT**
Includes: Impeller, Seal, Gasket, End & Cover Screws
Replaces: Johnson Pump 09-45825
Use with 18-3587-1 Pump



**18-3510
WATER PUMP KIT**
Includes: Neoprene Impeller, Seal, Gasket, End & Cover Screws
Replaces: Johnson Pump 09-45589
For: F35B-8 Pumps



**18-3020
IMPELLER**
Replaces: Johnson Pump 09-1027B-9 (Nitrile)



**18-45712
IMPELLER**
Replaces: Johnson Pump 09814B
Fits: F9B-9 Pump



**18-45713
IMPELLER**
Replaces: Johnson Pump 09-810B
Fits: F4B Pump



**18-45714
IMPELLER**
Replaces: Johnson Pump 09-821B
Fits: F75B Pump



PKG. OF 2
**18-3125
18-3125-9①
WATER PUMP GASKET**
Replaces: 3298-0000



**18-3303
COVER PLATE GASKET**
Replaces: Johnson Pump 01-42401
For: Johnson Pump JN-F6



**18-3586-1
WATER PUMP**
Replaces: Johnson Pump 10-24228-1
For Impeller Repair Kit use 18-3081
Use replacement Impeller 18-3020





**18-3587-1
WATER PUMP**
Replaces: Johnson Pump 10-24232-1
For Impeller Repair Kit use 18-3089

IMPELLERS FOR OBERDORFER PUMPS



**18-3061
IMPELLER**
Replaces: Oberdorfer 8922
Sherwood 10615
12 FINS
For: GM engines with V-Belt



②18-3075D 
**18-3075
IMPELLER KIT**
Replaces: Oberdorfer B6620
12 FINS



**18-3077
IMPELLER KIT**
Replaces: Oberdorfer C7441 Sherwood 18200
12 SPLINES 8 FINS



**18-3078
IMPELLER KIT**
Replaces: Oberdorfer 7054
12 SPLINES 9 FINS



①18-3046D 
**18-3046
IMPELLER KIT**
Replaces: Sherwood 9959K
with 18-3060 Impeller
Replaces: Sherwood 9959



**18-3047
IMPELLER KIT**
Replaces: Sherwood 10615K with
18-3061 Impeller
Replaces: Sherwood 10615

① Priced per Package
② Items ending in "D" are Display Packaged - Regular number is Non-Display



**18-3060
IMPELLER**
Replaces: Sherwood 9959
Onan 132-0317
12 FINS



**18-3021
IMPELLER**
Replaces:
Oberdorfer 6603
Diameter 2 9/16" • Side width 2"
(Neoprene)

PKG. OF 2



**18-3140
18-3140-9[Ⓢ]
WATER PUMP GASKET**
Replaces: Sherwood 10931



**18-3168
SEAL & SEAT**
Replaces: Sherwood 10927



**18-3169
SEAL & SEAT**
Replaces:
Sherwood 12859, 12322

SHERWOOD COMPONENT APPLICATIONS

Pump #	Impeller Kit	Impeller	Seal & Seat Assembly	Pump #	Impeller Kit	Impeller	Seal & Seat Assembly	Pump #	Impeller Kit	Impeller	Seal & Seat Assembly
A-03	—	18-3060	—	G-50	18-3047	18-3061	18-3169	N-10410G	18-3046	18-3060	—
B-04	18-3047	18-3061	18-3168	G-55-2	—	18-3061	18-3169	N-10460	—	18-3060	—
C-03	18-3047	18-3061	18-3168	G-56	—	18-3061	18-3169	N-10470	—	18-3060	—
D-05	—	18-3061	18-3168	G-85	18-3047	18-3061	18-3169	N-10510G	18-3046	18-3060	—
D-55	18-3046/18-3047	18-3060/18-3061	18-3168	G-1004	—	18-3061	—	P-101	—	18-3061	18-3169
D-60	18-3046	18-3060	18-3168	G-1005	—	18-3061	—	P-102	—	18-3061	—
D-65	18-3046	18-3060	18-3168	G-1006	—	18-3061	—	P-105	18-3047	18-3061	—
D-75	18-3046	18-3060	18-3168	G-85106	—	18-3061	18-3168	P-10550G	18-3046/18-3047	18-3060/18-3061	—
E-35	—	18-3061	18-3168	H-85	—	18-3061	18-3169	P-10560G	18-3046	18-3060	—
F-10	18-3047	18-3061	18-3168	J-70	—	18-3060	18-3169	P-10610G	18-3046	18-3060	—
F-75	18-3047	18-3061	18-3168	K-90	—	18-3061	18-3169	P-10650G	18-3046	18-3060	—
F-95	—	18-3061	18-3168	L-10	—	18-3061	18-3069	P-10710G	18-3046	18-3060	—
G-3	—	18-3061	—	L-10B	—	18-3061	18-3169	Q-10770G	18-3046	18-3060	—
G-4	—	18-3061	—	L-80	—	18-3061	18-3169	Q-10755G	—	18-3060	—
G-5	18-3047	18-3061	18-3169	L-90	—	18-3061	18-3169	Q-10855G	18-3046	18-3060	—
G-5-1	—	18-3061	18-3169	L-9930G	18-3046	18-3060	—	R-40G	18-3046	18-3060	18-3168
G-7	—	18-3061	18-3169	M-70	—	18-3061	18-3169	R-101	—	18-3061	18-3168
G-8	—	18-3061	—	M-71	—	18-3061	18-3169	R-102	—	18-3060	—
G-7B	—	18-3061	18-3169	M-10065G	—	18-3060	—	R-10870G	18-3046	18-3060	18-3168
G-15	—	18-3060	18-3169	M-10180G	18-3046	18-3060	—	R-10920G	18-3046	18-3060	—
G-26	—	18-3061	18-3169	M-10210G	18-3046	18-3060	—	R-10930G	18-3046	18-3060	—
G-30-2	—	18-3060	18-3169	M-10263G	18-3046	18-3060	—	R-10935G	18-3046	18-3060	—
G-30-2B	—	18-3060	18-3169	M-10264G	18-3046	18-3060	—	R-10970G	18-3046	18-3060	18-3168
G-45-1	—	18-3061	—	M-10270G	18-3046	18-3060	—	RP-B-C	—	18-3061	18-3168
G-45-2	—	18-3061	18-3169	M-10280G	18-3046	18-3060	—	S-11040G	18-3046	18-3061	18-3168
G-46	—	18-3061	18-3169	N-10390G	18-3046	18-3060	—	S-11095G	—	18-3061	—



**18-2434
FLYWHEEL BELL HOUSING**
Replaces:
Crusader 96938
Marine Power 0100-000
Mercruiser 814309A1
Pleasurecraft R142006
Volvo Penta 3857846-4
GM V-8's Big & Small Block inboard/Ski models.



**18-2589
TRANSMISSION OIL COOLER**

- 1" Water Hose Connection
- 9" Tube Bundle Overall Length
- Approximately 12"
- Oil-6 GPM MAX Water 25 GPM MAX
- Shipped bare metal, ready for primer and factory paint finish.



**18-2587
TRANSMISSION OIL COOLER**
Replaces: Mercruiser 99356A2

- Replacement Power Steering Cooler for Mercruiser
- Power Steering Fluid-4 GPM MAX Water 25 GPM MAX
- 6" tube bundle, overall length 8", 1 1/4" water inlet and outlet
- Shipped bare metal, ready for primer and factory paint finish.



**18-2588
TRANSMISSION OIL COOLER**

- 1 1/4" Water Hose Connection
- 9" x 2" and 3/8" NPT Inlet/Outlet Oil Fitting
- Oil-6 GPM MAX Water 25 GPM MAX
- 10" tube bundle, overall length 12", 1 1/4" water inlet and outlet
- Shipped bare metal, ready for primer and factory paint finish.

Ⓢ Priced per Package

TRANSMISSION REPAIR KITS

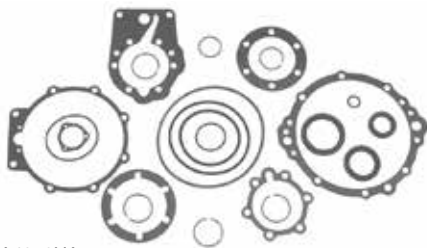

18-2590 SEAL KIT

Replaces: Borg Warner A4876HA
 • Service kit for Borg-Warner Velvet Drive 71 and 72 series transmission



18-2591 OVERHAUL KIT

Includes: Gaskets, Seals, Sealing Rings, Bronze and Steel Plates
 • Service kit for Borg-Warner Velvet Drive 71 and 72 series transmission

ANODES

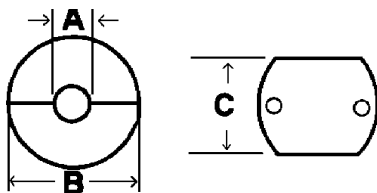

SHAFT ANODES

ZINC ANODES			NOMINAL DIMENSIONS		
Part #	Nom. Weight		A-Diameter	Dimension B	Dimension C
	LBS.	(KG)	IN. (MM)	IN. (MM)	IN. (MM)
18-6040	.90	(.40)	1 1/8 (29)	2 1/8 (54)	2 1/8 (54)
18-6041-1	1.65	(.75)	1 1/4 (33)	2 5/8 (67)	2 1/2 (64)
18-6043-1	1.45	(.65)	1 1/2 (38)	2 1/2 (64)	2 1/2 (64)

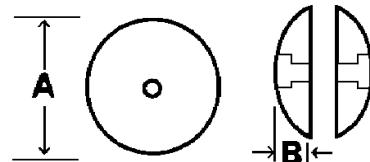

RUDDER ANODES

ZINC ANODES			NOMINAL DIMENSIONS		
Part #	Nom. Weight		A-Diameter	Dimension B	
	LBS.	(KG)	IN. (MM)	IN.	(MM)
18-6045	.20	(.09)	1 7/8 (47)	1/4	(6)
18-6046	.90	(.40)	2 13/16 (71)	1/2	(13)
18-6047	1.40	(.64)	3 3/4 (95)	1/2	(13)
18-6107	-	-	5 (127)	5/8	(16)
18-6108	4.63	(2.10)	5 1/8 (130)	7/8	(22)
18-6109	9.32	(4.22)	6 1/2 (165)	7/8	(22)

COMPLETE ENGINE ANODES (with Brass Plug)

ZINC ANODES			NOMINAL DIMENSIONS			Replacement Anode Only
Part #	Nom. Weight		A-Length	B-Diameter	Plugs (pis)	
	LBS.	(KG)	IN. (MM)	IN. (MM)	IN. (MM)	
18-6134	.12	(.05)	2-0 (50)	1/4 (6)	1/8 (3)	18-6050
18-6059	.10	(.05)	1 3/4 (44)	3/8 (10)	1/4 (6)	18-6135
18-6060	.20	(.09)	2-0 (50)	1/2 (13)	3/8 (10)	18-6052
18-6136	.20	(.09)	2-0 (50)	3/8 (10)	3/8 (10)	18-6053
18-6062	.30	(.14)	2-0 (50)	5/8 (16)	1/2 (13)	18-6137
18-6063	.45	(.20)	2-0 (50)	3/4 (19)	3/4 (19)	-

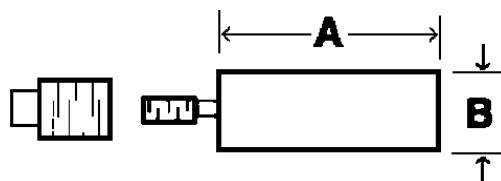

PACKING (* All 3 foot packing comes in display packaging)

PREMIUM SQUARE MARINE TEFLON PACKAGING					PREMIUM SQUARE MARINE LUBRICATED FLAX PACKAGING				
AP#	Diameter	Length*	Wt. (lbs.)	Pkg.	AP#	Diameter	Length*	Wt. (lbs.)	Pkg.
4720	1/8"	3 ft.	—	1	4701	3/16"	3 ft.	—	1
4730	1/8"	—	1	1	4711	3/16"	—	1	1
4721	3/16"	3 ft.	—	1	4702	1/4"	3 ft.	—	1
4731	3/16"	—	1	1	4712	1/4"	—	1	1
4722	1/4"	3 ft.	—	1	4703	5/16"	3 ft.	—	1
4732	1/4"	—	1	1	4713	5/16"	—	1	1
4723	5/16"	3 ft.	—	1	4704	3/8"	3 ft.	—	1
4733	5/16"	—	1	1	4714	3/8"	—	1	1
4724	3/8"	3 ft.	—	1	4705	1/2"	3 ft.	—	1
4734	3/8"	—	1	1	4715	1/2"	—	1	1
4725	1/2"	3 ft.	—	1					
4735	1/2"	—	1	1					



18-6140 ZINC ANODE

Replaces: 301068
 For: 5424, M-30, M-35, M3-20, M3-20A, M4-30, M4-30A, M-35A



18-6141 ZINC ANODE

Replaces: 301069
 For: 5416, M-12, M-18, M-20, M-25, M-25XP, M-25XPA, M-30, M2-12



SHAFT KEY

Part #	Shaft Dimensions
18-2334	2 1/8" x 1/4"

①18-5250D 



**18-5250
TUNE-UP KIT**

—CONTAINS—

Part #	O.E. #	Description
18-5311	16.69-00049	Contact Set
18-5345	16.69-00050	Condenser
18-5418	16.69-00051	Rotor

Delco 4 & 6 cyl.

①18-5251D 

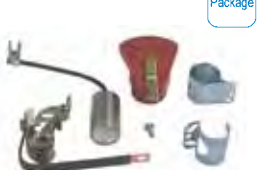

**18-5251
TUNE-UP KIT**

—CONTAINS—

Part #	O.E. #	Description
18-5314	16.69-00039	Contact Set
18-5338	16.69-00040	Condenser
18-5404-1	16.69-00149	Rotor

Mallory 8 cyl. Tall Cap

**18-5252
TUNE-UP KIT**

—CONTAINS—

Part #	Description
18-5310	Contact Set
18-5344	Condenser
-	Rotor

Delco 8 cyl.

**18-5255
TUNE-UP KIT** 

—CONTAINS—

Part #	Description
18-5303	Contact Set
18-5345	Condenser
18-5407	Rotor

Prestolite 8 cyl.

**18-5256
TUNE-UP KIT**

—CONTAINS—

Part #	O.E. #	Description
18-5314	16.69-00039	Contact Set
18-5338	16.69-00040	Condenser
18-5411	16.69-00042	Rotor

Mallory 8 cyl. Flat Cap

①18-5258D 



**18-5258
TUNE-UP KIT**

—CONTAINS—

Part #	Description
18-5303	Contact Set
18-5347	Condenser
18-5407	Rotor

Prestolite 8 cyl.

**18-5259
TUNE-UP KIT**

—CONTAINS—

Part #	Description
18-5303	Contact Set
18-5347	Condenser
18-5429	Rotor

Prestolite 6 & 8 cyl.

①18-5260D 



**18-5260
TUNE-UP KIT**

—CONTAINS—

Part #	Description
18-5303	Contact Set
18-5345	Condenser
18-5403	Rotor





**18-5266
TUNE-UP KIT**

Fits: Flame Thrower Distributors 18-5481, 18-5482, 18-5483, 18-5477, 18-5478 and 18-5479

**18-5268
TUNE-UP KIT** 

—CONTAINS—

Part #	O.E. #	Description
18-5311	16.69-00049	Contact Set
18-5345	16.69-00050	Condenser
18-5418	16.69-00051	Rotor
18-5385	16.69-00052	Distributor Cap

GM 4 Cyl. • Single Point

**18-5269
TUNE-UP KIT** 



—CONTAINS—

Part #	O.E. #	Description
18-5311	16.69-00049	Contact Set
18-5345	16.69-00050	Condenser
18-5418	16.69-00051	Rotor
18-5386	-	Distributor Cap

GM V-6 • Single Point

**18-5271
TUNE-UP KIT** 



—CONTAINS—

Part #	O.E. #	Description
18-5314	16.69-00039	Contact Set
18-5338	16.69-00040	Condenser
18-5376	16.69-00148	Distributor Cap
18-5404-1	16.69-00149	Rotor

Mallory Tall • V-8 • Single Point

**18-5272
TUNE-UP KIT** 

—CONTAINS—

Part #	O.E. #	Description
18-5314	16.69-00039	Contact Set
18-5338	16.69-00040	Condenser
18-5375	16.69-00100, F6900165	Distributor Cap
18-5411	16.69-00042	Rotor

Mallory Flat • V-8 • Single Point

**18-5275
TUNE-UP KIT** 



—CONTAINS—

Part #	Description
18-5303	Contact Set
18-5347	Condenser
18-5352	Distributor Cap
18-5403	Rotor

Single Point • Screw Cap • V-8

**18-5277
TUNE-UP KIT** 



—CONTAINS—

Part #	Description
18-5303	Contact Set
18-5347	Condenser
18-5369	Distributor Cap
18-5407	Rotor

Single Point • Clip Cap • V-8

**18-5303
CONTACT SET**



**18-5307
CONTACT SET**



APPLICATION BEGINS ON PAGE 565

① Items ending in "D" are Display Packaged - Regular number is Non-Display

 <p>18-5310 CONTACT SET</p>	 <p>18-5311 CONTACT SET Replaces: 16.69-00049</p>	 <p>18-5314 CONTACT SET Replaces: 16.69-00039</p>	 <p>18-5338 CONDENSER Replaces: 16.69-00040</p>	 <p>18-5344 CONDENSER</p>
 <p>18-5345 CONDENSER Replaces: 16.69-00050</p>	 <p>18-5346 CONDENSER Replaces: 1869704</p>	 <p>18-5347 CONDENSER</p>	 <p>18-5300 ROTOR Fits: Flamethrower Distributors</p>	
 <p>18-5403 ROTOR</p>	 <p>18-5404-1 ROTOR Replaces: 16.69-00149</p>	 <p>18-5407 ROTOR</p>	 <p>18-5411 ROTOR Replaces: 16.69-00042</p>	
 <p>18-5418 ROTOR Replaces: 16.69-00051</p>	 <p>18-5419 ROTOR</p>	 <p>18-5427 ROTOR Replaces: 16.69-0022</p>	 <p>18-5429 ROTOR</p>	
 <p>18-5352 DISTRIBUTOR CAP Prestolite</p>	 <p>18-5359 DISTRIBUTOR CAP</p>	 <p>18-5369 DISTRIBUTOR CAP Prestolite W/Gasket 18-5399</p>	 <p>18-5375 DISTRIBUTOR CAP Replaces: 16.69-00100, FI 6900165 Mallory</p>	
 <p>18-5376 DISTRIBUTOR CAP Replaces: 16.69-00148 Mallory</p>	 <p>18-5385 DISTRIBUTOR CAP Replaces: 16.69-00052 Delco</p>	 <p>18-5386 DISTRIBUTOR CAP Delco</p>	 <p>18-5301 TUNE-UP KIT Fits: male cap v-8 flamethrower distributors</p>	



**18-5302
TUNE-UP KIT**
Fits: male cap v-8 flamethrower distributors



**18-5226
IGNITION WIRE**
Metallic Core
100' Spool • 7mm Hypalon



**18-5224
18-5224-9^①
SPARK PLUG WIRE TERMINAL**
Replaces: Mercury 20121
OMC 510364



**18-5225
SPARK PLUG WIRE KIT**
Replaces: Mercury 84-99215A26, 84-813706A26
Kit includes 25 ft. Roll of 7 MM Hypalon Ignition Wire With a Metallic Core and a Large Assortment of Three Different End Fittings.



**18-5750
18-5750-9^①
UNIVERSAL SPARK PLUG BOOTS**
Supplied complete w/Terminal Connector
Replaces: OMC 581027, 580339



**18-5752
UNIVERSAL
SPARK PLUG BOOTS**
8mm

PREMIUM MARINE SPARK PLUG WIRE LEADS

Sierra's MAGFORCE Ignition Wires are "Electronics Friendly" protecting all of your electronic devices and electronic engine controls from RFI and EMI while delivering the maximum amount of voltage. Exact fit design ensures easy installation and years of trouble - free service.

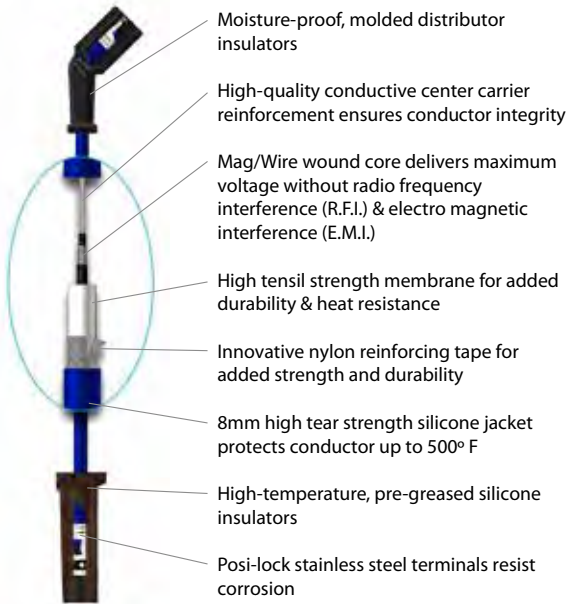

CHRIS-CRAFT					
Engine	Cyl.	Distributor	Year Start	Year Stop	Plug Wire Set
181 CID (3.0L)	4	Conventional	ALL	ALL	18-8800-1
302	8	Conventional	ALL	ALL	18-28044
351	8	Conventional	ALL	ALL	18-28044
460	8	Conventional	ALL	ALL	18-28044
350	8	Conventional	1970	1990	18-8803-2
350	8	Conventional ①	1970	1990	18-8823-1
454	8	Conventional	ALL	ALL	18-8817-1
502	8	Conventional	ALL	ALL	18-8817-1

① Models designed with Mallory side terminals



FEATURES

- Senses current levels in the coil and adjusts the dwell to maintain peak energy throughout the entire RPM range.
- Develops, on average, 4 times more available energy between 3000 and 5000 RPM's and twice as much plug voltage as point-type systems.
- Ignition energy is sustained and coil life is increased when peak current level is reached just prior to spark.
- More stable timing.
- Use with 18-5472 "Flame Thrower II" Coil for optimum performance



**18-5286
HI-PERFORMANCE ELECTRONIC
CONVERSION KIT**
Fits: 6 Cylinder Delco Distributors



18-5288
HI-PERFORMANCE ELECTRONIC CONVERSION KIT
 Fits: Most Prestolite V-8 with snap down cap



18-5289
HI-PERFORMANCE ELECTRONIC CONVERSION KIT
 Fits: Most Prestolite V-8 Distributors with screw down cap



18-5290
HI-PERFORMANCE ELECTRONIC CONVERSION KIT
 Fits: Most Mallory YL or YD 8 cylinder Distributors with clockwise and counter clockwise rotation



FEATURES

- Replaces points & condensers for true solid state ignition.
- Uses standard coil, cap and rotor.
- Easy to install, one-piece, 2-wire hook-up.
- Accurate to within 1/4° timing accuracy 0 to 6000 RPM range.
- Can be used with Flame Thrower coils 18-5466 & 18-5469.



Conventional wiring system



Ignitor wiring system



18-5294
ELECTRONIC CONVERSION KIT
 Fits: 6 cyl. Delco distributors



18-5295
ELECTRONIC CONVERSION KIT
 Fits most 4 cyl. Prestolite distributors. (Except IBM 7026)
 For: Onan, Universal, Waukesha, Wisconsin



18-5298
ELECTRONIC CONVERSION KIT
 (with snap down cap)
 For: Most Prestolite V-8 Distributors



18-5296-2D Display Package
18-5296-2
ELECTRONIC CONVERSION KIT
 Fits: Most Mallory V-8 YL & YD 8 cyl. Distributors with clockwise or counter-clockwise rotation



18-5299
ELECTRONIC CONVERSION KIT
 (with screw down cap)
 For: Most Prestolite V-8 Distributors
 Use with 18-5403 style rotor



18-9801
MULTI METER/DVA TESTER
 Tests electrical and ignition systems. Consists of a VOA meter with built-in direct voltage adapter.



18-9802
TIMING LIGHT
 Self-powered accurate up to 10,000 RPM's

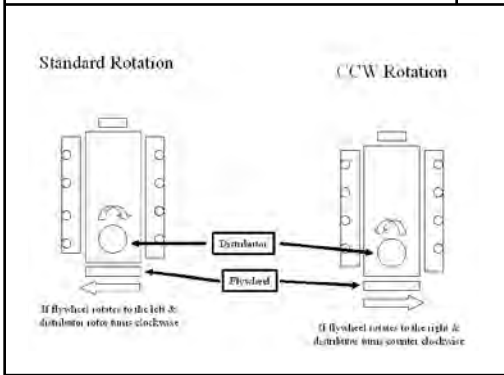



18-5483
HI-PERFORMANCE ELECTRONIC DISTRIBUTOR
 Fits: Chevrolet Marine Small and Big Block engines (Standard Deck Height)

- Distributors feature the Ignitor II ignition module with adaptive dwell control adjusts the spark timing over the entire RPM range to maximize performance
- Upper roller bearing and oil impregnated bronze sintered bottom bushing are installed and aligned bored for accuracy for maximum durability
- Machined heat treated gear with tight tolerances insures durability and consistent timing to maximize and performance. Complete with high dielectric strength cap and rotor for years of performance
- Replacement cap/rotor kit: 18-5266

**18-5313-1
DISTRIBUTOR**

Replaces: Mallory YL624MW
For most GM V-8 Eng. (small & large blocks)
Uses: 18-5251 TUNE-UP KIT

— CONTAINS —

Part #	Desc.
18-5314	Contact Set
18-5338	Condenser
18-5404-1	Rotor
And 18-5376 CAP	



**18-5494-2
ELECTRONIC DISTRIBUTOR**

U.L. Approved Conventional Rotation
For: Chevrolet All V8 (exc. 348, 409 & Tall Deck Big Block) includes 482, 502, 540 CID
USES:

Part #	Description
18-5376	Distributor Cap
18-5404-1	Rotor
18-5488	Module



**18-5480
COMPLETE IGNITION
CONVERSION KIT**

Fits: GM SB & BB with Standard Deck Height

—CONTAINS—

Part #	Description
18-5472	Coil
18-8803-2	Wire Set
18-5483	Distributor



**18-5433
IGNITION COIL
(Uses External Resistor)**



**18-5435
IGNITION COIL
(Has Internal Resistor)**



FEATURES

- Oil filled for better cooling and long life
- Low resistance and improved turn ratios produces the higher voltage needed to run larger spark plug gaps for added power and better fuel economy
- More windings maximize energy and reliability over the full RPM range
- Fits existing brackets for easy installation

**18-5466
HI-PERFORMANCE
IGNITION COIL**

1.5 ohm (oil filled), black - 8 cylinder: Flame-Thrower 40,000 volt coil.

- Designed for use with the original Ignitor Electronic Conversion Kits
- Can be used with other inductive ignition systems



**18-5469
HI-PERFORMANCE
IGNITION COIL**

3.0 ohm (oil filled), black - 4 & 6 cylinder: Flame-Thrower 40,000 volt coil.

- Designed for use with the original Ignitor Electronic Conversion Kits
- Can be used with other inductive ignition systems



**18-5472
HI-PERFORMANCE
IGNITION COIL**

0.6 ohm (oil filled), black - 4, 6, & 8 cylinder: Flame-Thrower 45,000 volt coil.

- Super low 0.6 ohm resistance coil designed for use with the Ignitor II Hi Performance Electronic Conversion Kits
- Compatible with capacitive discharge systems



Part No.	Description	Recommended Coil	Resistance Ohms	Part No.	Description	Recommended Coil	Resistance Ohms
18-5294	Electronic Conversion Kit	18-5469	3	18-5286	Hi Performance Electronic Conversion Kit	18-5472	0.6
18-5295	Electronic Conversion Kit	18-5469	3	18-5288	Hi Performance Electronic Conversion Kit	18-5472	0.6
18-5296-2	Electronic Conversion Kit	18-5466	1.5	18-5289	Hi Performance Electronic Conversion Kit	18-5472	0.6
18-5298	Electronic Conversion Kit	18-5466	1.5	18-5290	Hi Performance Electronic Conversion Kit	18-5472	0.6
18-5299	Electronic Conversion Kit	18-5466	1.5	18-5483	Flame-Thrower Distributor	18-5472	0.6

**18-5450
COIL RESISTOR
1.5 OHM**



**18-5464
IGNITION MODULE**
Fits: Sierra 18-5483 Billet HI-PERFORMANCE ELECTRONIC DISTRIBUTOR (except HEI/EST)



**18-5493
IGNITION PICKUP
COIL ASSEMBLY**
Replacement pick-up coil for Accel Electronic Distributors



IGNITION/ELECTRICAL SYSTEMS APPLICATION

Year	Cyl.	Model	Distributor No.	Contact Set	Condenser	Rotor	Dist. Cap	Tune-Up Kit	Distributor	Elect. Conv. Kit
1946-62	4	B,BR,BR3	IGW-4152, C	—	—	—	18-5359	—	—	—
1946-68	4	A,B,BR,BR3	IAY-4010	18-5307	18-5345 ①	18-5427	—	—	—	—
1975-80	4	FL153,181	—	18-5311	18-5338	18-5418	18-5385	—	—	—
1947-60	6	M,ML,MLO,MO, K,KL,KLO,KO	IAY-4009	18-5307	—	18-5427	—	—	—	—
1947-63	6	KS,KSO,KR, W,WO	IAY-4009	18-5307	—	18-5427	—	—	—	—
1947-63	6	W,WO	IGC-4279B	—	18-5345 ①	—	—	—	—	—
1967-71	6	225B, BVC	1110342	18-5310	18-5346	18-5419	—	—	—	—
1958-67	8	283, 283-0 Corvette Eng.	IBB-4109A	18-5303	18-5345 ①	18-5404-1	—	—	18-5313-1 ③ 18-5494-2 ④	18-5296-1
1963-71	8	283F, 327F Corvette Eng.	IBM-4115, 4116	18-5303	18-5345 ①	18-5429	—	18-5259	18-5494-2 ④	—
1958-67	8	Dual Contact	IBB-4201A, B	18-5303 ②	18-5345 ①	18-5404-1	—	—	—	18-5296-1
1958-68	8	Dual Contact	IBB-4301A, B	18-5303 ②	18-5345 ①	18-5407	18-5369	18-5255 ⑤	—	18-5298
1958-67	8	Dual Contact	1110630	—	18-5346	—	—	—	—	—
1979-80	8	ALL	IBM-7011	18-5303	18-5345 ①	18-5407	18-5369	18-5255 ⑤	—	18-5298
1981-85	8	ALL	IBM-7013	18-5303	18-5345 ①	18-5403	18-5352	18-5260 ⑥	—	18-5299

- ① For Strap Type Condenser, Use 18-5347
② Two Required

- ③ Contact Controlled Distributor
④ Electronic Ignition Distributor



- ⑤ 18-5277 Kit with distributor cap
⑥ 18-5275 Kit with distributor cap



**18-6835
STARTER**
Replaces: GM Engines Universal
Used on all GM Engines with either 14 1/4" or 12 3/4" flywheels.

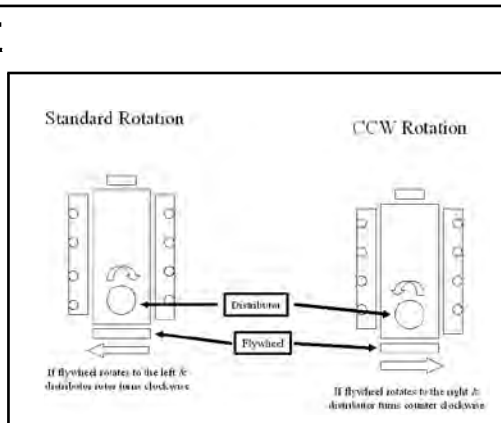

**18-5911
STARTER**
Replacement Solenoid: 18-5837
(Heavy-Duty) (No Core)
For: GM Engines, Bottom Mount Straight Across Bolt Pattern, Standard Rotation, Clockwise
Replaces: 16.61-00042
SAEJ1171

BATTERY CABLES
Gauge cable with soldered lug terminals on each end to accept a 3/8" stud.

Part #	Size	Color	Gauge	Part #	Size	Color	Gauge
BC88523	2'	red	4	BC88563	6'	red	2
BC88533	2'	black	4	BC88573	6'	black	2
BC88543	4'	red	2	BC88583	8'	red	1
BC88553	4'	black	2	BC88593	8'	black	1



**18-5838
SOLENOID**
Delco



**18-5717
STARTER BRUSH SET**
Delco



**18-5840
SOLENOID**
Prestolite 15-79, SAW4201, SAW4207, SAW4210



**18-5710
VOLTAGE REGULATOR**
Prestolite VSH-6201JY

APPLICATION ON NEXT PAGE

VOLTAGE REGULATOR, BRUSH SET, STARTER SWITCH APPLICATION

Year	Model	Volt	Original Alt. or Gen.	Volt Reg.	Original Starter No.	Brush Set	Starter Switch
1979-85	ALL	12	—	—	—	—	18-5840
1967-78	283,F,305,307,327,F,350,454	12	ALE,6207AY,Y,YS & ALE-6221AY,Y	—	MHA,MDY,MDU 1108366,417	— 18-5717	18-5840 18-5838
1961-78	283,O,F,307,327,F,Q,427,F 430,H,430-0,430-HO	12	ALD-5006	—	MDY-6007,8	—	18-5840
		12	ALE-5202,B,Y	—	MDU-7032,3,4,5	—	18-5840
		12	ALE-5203	—	MHA-7005,6,9 10,12,13	—	18-5840
1947-66	K,KR,KRO,KS,KSO,KO,M,ML MLO,MO,W,WO Series	12	—	—	MAS-4011, 2	—	18-5840
		12	GFW	—	MAU	—	18-5840
		12	—	—	MBG	—	18-5840
		12	—	—	MDL	—	—
1961-65	430H,430,HO	12	GHW-4807, 8	—	MDL-6007	—	18-5840



18-7019
CARB KIT



18-7022
CARB KIT



18-7023
CARB KIT



18-7025
CARB KIT



18-7070
CARB KIT



18-7072
CARB KIT

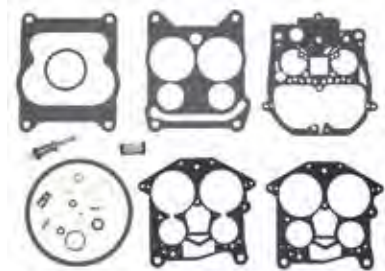

18-7095
CARB KIT



18-7732
CARB KIT



18-7200
FLOAT
(ALCOHOL RESISTANT)
Plastic



18-7201
FLOAT
(ALCOHOL RESISTANT)
Brass

APPLICATION ON NEXT PAGE

CARBURETOR KIT/FLOAT APPLICATION

Cyl.	Eng./Model	Mfg. Code	Carb. Model	Carburetor	Float Number	Car Kit. ①
4	A & B (1942-55)	Z-1	63M2E10	8963, A-J	—	18-7732
4	K (1939-55)	Z-1	63M2AWE11	8983, A-H	—	18-7732
4	B (1947-Up)	Z-1	63M2E10	12206	—	18-7732
4	K (1956-62)	Z-1	63M2E11	12091, A	—	18-7732
4	153" (2.5L), 181" (3.0L)	R-2	2GC	7041187, 7042181, 17059055	18-7200	18-7070
6	225" (3.7L)	R-2	2GC	7025181, 189	—	18-7070
8	283" (4.6L)	R-2	2GC	7019082	18-7200	18-7070
8	283" (4.6L)	R-4	4GC	7013071, 7015090	—	18-7019
8	283" (4.6L)	C-4	WCFB	2669, 3205	—	18-7025
8	283" (4.6L), 307"(5.0L), 327" (5.3L)	C-4	AFB	3660, 6310	—	18-7022
8	305"(5.0L), 350" (5.7L)	R-4	4MC	17056287, 17058280	18-7201	18-7072
8	305" (5.0L), 350" (5.7L), 454" (7.4L)	R-4	4MV	17059294, 17059295, 17059296	18-7201	18-7095
8	307" (5.0L), 327" (5.3L), 350" (5.7L)	C-4	AVS	4695, 6117	—	18-7023
8	307" (5.0L), 454" (7.4L)	R-4	4MV	7044283, 7044288, 7044289	18-7201	18-7072

① Does not include metering rods

**18-8114
FUEL LINE HOSE
UNIVERSAL**
For fuel pump to carburetor connection. Replaces copper or steel tubing 3/8" X 31" PTFE composite hose with 5/8"-18 male inverted flare straight one end, 5/8"-18 90° one end. SAE J1527 type A1

**18-8115
FUEL LINE HOSE
UNIVERSAL**
For fuel pump to carburetor connection. Replaces copper or steel tubing 3/8" X 25" PTFE composite hose with 5/8"-18 male inverted flare straight one end, 5/8"-18 90° one end. SAE J1527 type A1

**18-7260
FUEL PUMP**
(Flange I.D. #40155, M3120)
For: GM (V-8) 283, 307, 327, 350, 409

**18-7265
FUEL PUMP**
Replaces: 16.83-08758, F18308762
(Flange I.D. #41412)
For: GM (V-8) 305, 350, 400

**18-7272
FUEL PUMP**
(Flange I.D. #41419, M73020)
For: GM (V-8) 283, 305, 350, 400

**18-7278
FUEL PUMP**
(Flange I.D. #60032)
For: GM (4 & 6 Cyl.) 153, 181, 250, 224, 225
Uses replacement filter **18-7860** & **18-0889** gasket

ALL SIERRA FUEL PUMPS INCLUDE MOUNTING GASKET

FUEL WATER SEPARATORS



Sierra offers a complete line of 10 and 21 micron fuel water separating filters including drainable bowl filters to protect your carbureted and fuel injected engine.

Refer to pages 136-140 for a complete listing of OEM and universal applications.

Sierra fuel water separators remove over 99.8% of emulsified water from your gasoline. Sierra's 10 micron filters are over 90% efficient at removing particles as small as 10 micron. All filters flow @ 90 GPH to feed even the hungriest motor. Sierra 10 micron filters are recommended to prevent damage to sensitive inboard and outboard fuel injection systems.

• Display Packaged

Sierra #	Chris-Craft #	Description
18-7860 •	16.83-90006	Fuel Filter
18-7964-1	—	Transmission Filter
②18-4456D 	②18-4457D 	②18-4458D
18-4456 EXHAUST PROTECTOR VALVE Includes Stainless Steel Clamp 3"	18-4457 EXHAUST PROTECTOR VALVE Includes Stainless Steel Clamp 4"	18-4458 EXHAUST PROTECTOR VALVE Includes Stainless Steel Clamp 5" & 6" (5" requires two 45° cuts)
PKG. OF 8 		
FREEZE PLUGS 18-5961 18-5962 18-5961-9① 18-5962-9① 1 5/8" 1 3/4"		

① Priced per Package

② Items ending in "D" are Display Packaged - Regular number is Non-Display



SIERRA MANIFOLDS ARE PAINTED, PACKAGED AND LEAK TESTED



**18-1997-1
MANIFOLD**
Port & Starboard
Replaces: Barr CHV-1-83
Universal Center Riser Manifold
FITS:
Chriscraft 283, 302, 307 and 350 CID engines
Crusader 283 and 327 CID engines thru 1964; 305, 307 and 350 CID engines 1965 and later
Daytona 200-283 and 300-327
Flagship 283, 327 and 350 CID engines
Pacer 305, 307 and 350 CID engines 1965 and later
Mercury 190, 198, 225, 250, 270, 228, 898, 260, 255 and 280 models
OMC 283, 305, 307 and 350 CID engines 1968-1980
Volvo 307 and 350 CID engines
Use 18-0604 Exhaust Manifold Gasket Set
***For Exploded View - See Pages 638-639**



**18-1998-1
MANIFOLD**
Port & Starboard
Replaces: Barr FM-1-83
Universal Center Riser Manifold
FITS:
Crusader 302 and 351 CID engines
Interceptor 221, 260 and 289 CID engines
Commander, Mercury, OMC, Palmer, Pleasurecraft & Waukesha
Comes with 18-4363 Mounting Package
Use 18-0603 Exhaust Manifold Gasket Set
***For Exploded View - See Pages 640-641**



**18-1898
MANIFOLD**
Port & Starboard
Replaces: Barr CHVA-1-84
Marine Power 0991-110
Fits: 454 cu.in. GM big block V8 engines
Use with:
Exhaust Gasket: 18-0418
Riser Gasket: 18-2854-1 open or 18-0476-1 blocked
***For Exploded View - See Pages 636-637**



**18-1999
ELBOW
(3" exhaust)**
Replaces: Barr 20-0082
Comes with 18-4364 open Mounting Package
If blocked mounting kit is required use 18-8535
Use with:
Manifold: 18-1997-1 or 18-1998-1
Riser Gasket 18-2854-1 open or 18-0476-1 blocked



**18-1907
RISER**
Replaces: Barr 20-0102
Indmar 53-2009, 53-2018
Barr and Indmar Ford Small Block V8 302-351cu.in.
Use with:
Manifolds: 18-1997-1 or 18-1998-1
Riser Gasket: 18-2854-1 open or 18-0476-1 blocked
Mounting Kit: 18-4364 open or 18-8535 blocked



**18-1939
RISER
(3 1/2" exhaust)**
Replaces: Barr 20-0100,
Marine Power 0992-593
Barr, Indmar and Marine Power Ford Small Block V8 302-351cu.in., GM Small Block V8 305-350cu.in., GM Big Block V8 454cu.in.
Used with:
Manifolds: 18-1898 or 18-1997-1 or 18-1998-1
Riser Gasket: 18-2854-1 open or 18-0476-1 blocked
Mounting Kit: 18-4364 open or 18-8535 blocked



**18-1991
ELBOW ADAPTER**
Barr 200089P
For: 3" I.D. Exhaust Hose
Use with:
Manifold Riser: 18-1999
30°



**18-1992-1
EXHAUST ELBOW**
Barr 200087P
For: 3" I.D. Exhaust Hose
(As used in 18-1987 Exhaust Manifold Conversion Kit)
80°



**18-1949
MANIFOLD SPACER (3")**
Barr CM 20-0097
Barr, Indmar and Marine Power Ford Small Block V8 302-351cu.in., GM Small Block V8 305-350cu.in., GM Big Block V8 454cu.in.
Used with:
Manifolds: 18-1998-1, 18-1997-1 and 18-1898



PIPE PLUGS

PART NO.	Thread Size	PART NO.	Thread Size
18-4256	1/4"	18-4263	1/8" - 27 NPT
18-4257	1/4"	18-4264	3/8" - 18 NPT
18-4258	3/4"		

56507 Pipe Sealant with Teflon® is recommended for use on plug threads.



18-4461
HOSE BARB
3/4" - 14 NPT x 1" Hose
Corrosion Resistant Brass Fitting

①18-4218D



18-4218
DRAIN TAP
Used with:
Most O.E.M. Manifolds
18-3223-9 Bulk Pack of 12
1/4"



18-4363
EXHAUST ELBOW KIT
Replaces: Barr FM-1-83-P
Use with:
Manifold: 18-1998-1



18-4364 (Open)
EXHAUST ELBOW KIT
Replaces: Barr 20-0082-P
Use with:
Riser: 18-1999, 18-1907, 18-1939



18-8516
EXHAUST MANIFOLD MOUNTING KIT
Chris Craft GM Small Block V8 283-350cu.in.
Use with Chris Craft 7056, 7686



18-8535
EXHAUST MANIFOLD MOUNTING KIT
Barr, Indmar and Marine Power Ford Small Block V8 302-351 cu.in., GM Small Block V8 305-350 cu.in., GM Big Block V8 454cu.in.
Used with:
Risers: 18-1939, 18-1999, and 18-1907 (Blocked)



18-8536
EXHAUST ELBOW MOUNTING KIT
Barr, Indmar and Marine Power GM Small Block V8 305-350cu.in.
Used with:
Manifold: 18-1997-1



18-8538
EXHAUST MOUNTING KIT
Barr and Indmar Ford Small Block V8 302-351cu.in.
Used with:
Manifold: 18-1998-1



18-0603
EXHAUST MANIFOLD GASKET SET
Use with:
Manifold: 18-1998-1
For: FORD 302/351 CID Engines

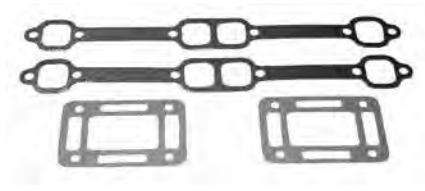

18-0604
EXHAUST MANIFOLD GASKET SET
Use with:
Manifold: 18-1997-1
For: GM 305/350 CID Engines

① Items ending in "D" are Display Packaged - Regular number is Non-Display



18-0868
INTAKE MANIFOLD
GASKET SET
 Replaces: 16.50-00232



18-0476-1
RISER BLOCKOFF GASKET
 Barr, Indmar & Marine Power
 Ford Small Block V8
 302-351cu.in.
 Used with:
 Risers: 18-1939, 18-1999
 and 18-1907
 Blocked

PKG. OF 2



18-2854-1 (Open)
18-2854-9^①
EXHAUST ELBOW GASKET
 Replaces: Barr 01-0107
 Use with:
 Riser: 18-1999, 18-1939, 18-1907

PKG. OF 2



18-2949
18-2949-9^①
EXHAUST MANIFOLD
GASKET
 Replaces:
 Barr CHV-47-000
 Use with:
 Manifold: 18-1997-1

MARINE OIL FILTERS



18-7824-2
 (Short)
 GM 153, 181, 250
 Replaces: 16.81-08746
 For models 307G, 305K, 307K

18-7875
 FORD 302, 351
 (Long)
 Replaces:
 16.81-06536

18-7876-1
 (Long)
 GM 283, 305, 307,
 350, 454

SEE PAGES 182-184 & 1147-1170 FOR ADDITIONAL INFORMATION



18-2946
HEAD GASKET
 Replaces: 16.50-00204
 For: GM 181 CID Eng. (3.0L)



18-3876
HEAD GASKET
 Replaces: 16.50-00250
 For: GM 305/350 CID Eng.
 (5.0L and 5.7L)



18-3877
HEAD GASKET
 Replaces: 16.50-00259
 For: GM 454 CID Eng. (7.4L)

PKG. OF 2



18-0874
18-0874-9^①
DISTRIBUTOR
GASKET
 Replaces: 16.50-00162
 GM V-6 7 V-8

PKG. OF 2



18-0876
18-0876-9^①
FUEL PUMP
GASKET
 Replaces: 16.50-05756

PKG. OF 2



18-0889
18-0889-9^①
FUEL PUMP GASKET
 Replaces: 16.50-00074

PKG. OF 2

























18-0891
18-0891-9^①
WATER PUMP GASKET
 Replaces: 16.50-00078



18-2845
VALVE COVER GASKET
 Replaces: 16.11-01236
 V-8

SEE PAGES 201-202 FOR OUR COMPLETE LINE OF GASKET SEALANTS

① Priced per Package

<p>①18-5251D Display Package</p>  <p>18-5251 TUNE-UP KIT —CONTAINS—</p> <table border="0"> <tr> <th>Part #</th> <th>Description</th> </tr> <tr> <td>18-5314</td> <td>Contact Set</td> </tr> <tr> <td>18-5338</td> <td>Condenser</td> </tr> <tr> <td>18-5404</td> <td>Rotor</td> </tr> <tr> <td>Mallory 8 cyl. Tall Cap</td> <td></td> </tr> </table>	Part #	Description	18-5314	Contact Set	18-5338	Condenser	18-5404	Rotor	Mallory 8 cyl. Tall Cap		<p>Display Package</p>  <p>18-5255 TUNE-UP KIT —CONTAINS—</p> <table border="0"> <tr> <th>Part #</th> <th>Description</th> </tr> <tr> <td>18-5303</td> <td>Contact Set</td> </tr> <tr> <td>18-5345</td> <td>Condenser</td> </tr> <tr> <td>18-5407</td> <td>Rotor</td> </tr> <tr> <td>Prestolite 8 cyl.</td> <td></td> </tr> </table>	Part #	Description	18-5303	Contact Set	18-5345	Condenser	18-5407	Rotor	Prestolite 8 cyl.		<p>①18-5258D Display Package</p>  <p>18-5258 TUNE-UP KIT —CONTAINS—</p> <table border="0"> <tr> <th>Part #</th> <th>Description</th> </tr> <tr> <td>18-5303</td> <td>Contact Set</td> </tr> <tr> <td>18-5347</td> <td>Condenser</td> </tr> <tr> <td>18-5407</td> <td>Rotor</td> </tr> <tr> <td>Prestolite 8 cyl.</td> <td></td> </tr> </table>	Part #	Description	18-5303	Contact Set	18-5347	Condenser	18-5407	Rotor	Prestolite 8 cyl.		 <p>18-5259 TUNE-UP KIT —CONTAINS—</p> <table border="0"> <tr> <th>Part #</th> <th>Description</th> </tr> <tr> <td>18-5303</td> <td>Contact Set</td> </tr> <tr> <td>18-5347</td> <td>Condenser</td> </tr> <tr> <td>18-5429</td> <td>Rotor</td> </tr> <tr> <td>Prestolite 6 & 8 cyl.</td> <td></td> </tr> </table>	Part #	Description	18-5303	Contact Set	18-5347	Condenser	18-5429	Rotor	Prestolite 6 & 8 cyl.	
Part #	Description																																										
18-5314	Contact Set																																										
18-5338	Condenser																																										
18-5404	Rotor																																										
Mallory 8 cyl. Tall Cap																																											
Part #	Description																																										
18-5303	Contact Set																																										
18-5345	Condenser																																										
18-5407	Rotor																																										
Prestolite 8 cyl.																																											
Part #	Description																																										
18-5303	Contact Set																																										
18-5347	Condenser																																										
18-5407	Rotor																																										
Prestolite 8 cyl.																																											
Part #	Description																																										
18-5303	Contact Set																																										
18-5347	Condenser																																										
18-5429	Rotor																																										
Prestolite 6 & 8 cyl.																																											
<p>①18-5260D Display Package</p>  <p>18-5260 TUNE-UP KIT —CONTAINS—</p> <table border="0"> <tr> <th>Part #</th> <th>Description</th> </tr> <tr> <td>18-5303</td> <td>Contact Set</td> </tr> <tr> <td>18-5345</td> <td>Condenser</td> </tr> <tr> <td>18-5403</td> <td>Rotor</td> </tr> <tr> <td>Prestolite 8 cyl.</td> <td></td> </tr> </table>	Part #	Description	18-5303	Contact Set	18-5345	Condenser	18-5403	Rotor	Prestolite 8 cyl.		 <p>18-5303 CONTACT SET Replaces: 2421173, 2808870</p>	 <p>18-5307 CONTACT SET Replaces: 2084074, 1274092, 2421178</p>	 <p>18-5314 CONTACT SET Replaces: 2421820</p>																														
Part #	Description																																										
18-5303	Contact Set																																										
18-5345	Condenser																																										
18-5403	Rotor																																										
Prestolite 8 cyl.																																											
 <p>18-5338 CONDENSER</p>	 <p>18-5345 CONDENSER Replaces: 2098058, 2279949</p>	 <p>18-5347 CONDENSER Replaces: 1818757, 3420600</p>	 <p>18-5403 ROTOR</p>																																								
 <p>18-5404-1 ROTOR Replaces: 868096</p>	 <p>18-5407 ROTOR Replaces: 1658535</p>	 <p>18-5429 ROTOR Replaces: 2098611</p>	 <p>18-5430 ROTOR Replaces: 868095</p>	 <p>18-5300 ROTOR Fits: Flamethrower Distributors</p>																																							
 <p>18-5352 DISTRIBUTOR CAP Replaces: 4142817 Prestolite</p>	 <p>18-5369 DISTRIBUTOR CAP (With Gasket 18-5399) Replaces: 4142408 Prestolite</p>	 <p>18-5376 DISTRIBUTOR CAP Mallory</p>	 <p>18-5473 DISTRIBUTOR CAP Black Distributor Cap with Male Terminals for Flamethrower Distributors</p>	 <p>18-5474 DISTRIBUTOR CAP Red Distributor Cap with Male Terminals for Flamethrower Distributors</p>																																							



① Items ending in "D" are Display Packaged - Regular number is Non-Display



**18-5301
TUNE-UP KIT**
Replaces:
Fits: male cap v-8 flamethrower distributors

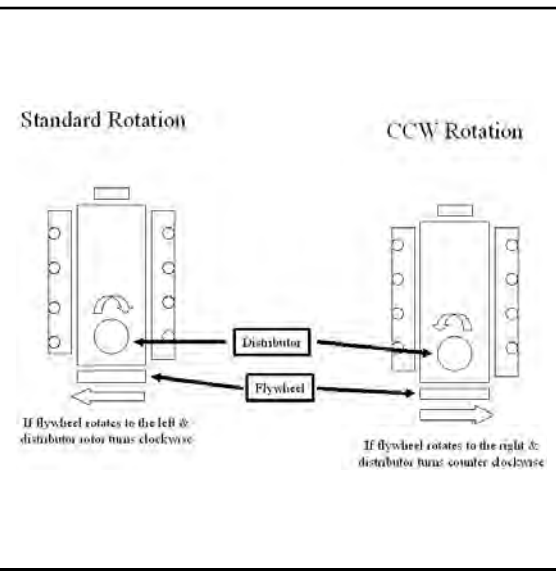

**18-5302
TUNE-UP KIT**
Replaces:
Fits: male cap v-8 flamethrower distributors

**18-5497-2
ELECTRONIC DISTRIBUTOR**
U.L. Approved • Conventional Rotation
For: Chrysler V-8 273, 318 (1967-Up), 340, 360 CID "LA" Engines

USES:

Part #	Description
18-5376	Distributor Cap
18-5404-1	Rotor
18-5491	Reluctor
18-5488	Module

PREMIUM MARINE SPARK PLUG WIRE LEADS

Sierra's MAGFORCE Ignition Wires are "Electronics Friendly" protecting all of your electronic devices and electronic engine controls from RFI and EMI while delivering the maximum amount of voltage. Exact fit design ensures easy installation and years of trouble - free service.

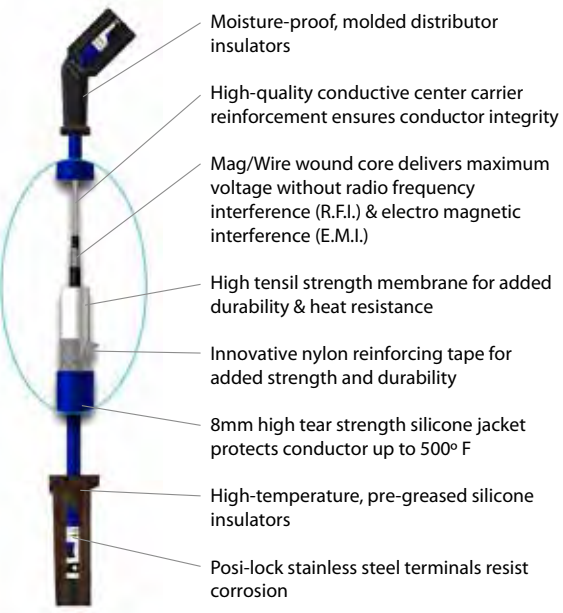

CHRYSLER MARINE IGNITION WIRES APPLICATION

Engine	Cyl.	Distributor	Years	Year Stop	Plug Wire Set
M273	8	Conventional & Electronic	1968-1974	1974	18-8826-1
LM318	8	Conventional & Electronic	1968-1985	1985	18-8826-1
M340	8	Conventional & Electronic	1968-1985	1985	18-8826-1
M360	8	Conventional & Electronic	1975-1985	1985	18-8826-1
361	8	Conventional & Electronic	1968-1985	1985	18-8827-1
383	8	Conventional & Electronic	1960-1988	1988	18-8827-1
400	8	Conventional & Electronic	1968-1985	1985	18-8827-1
440	8	Conventional & Electronic	1968-1985	1985	18-8827-1

Ignitor II FEATURES
ELECTRONIC IGNITION

- Senses current levels in the coil and adjusts the dwell to maintain peak energy throughout the entire RPM range.
- Develops, on average, 4 times more available energy between 3000 and 5000 RPM's and twice as much plug voltage as point-type systems.
- Ignition energy is sustained and coil life is increased when peak current level is reached just prior to spark.
- More stable timing.
- Use with 18-5472 "Flame Thrower II" Coil for optimum performance



**18-5286
HI-PERFORMANCE
ELECTRONIC
CONVERSION KIT**
Fits: 6 Cylinder Delco Distributors



FEATURES

- ★ Replaces points & condensers for true solid state ignition.
- ★ Uses standard coil, cap and rotor.
- ★ Easy to install, one-piece, 2-wire hook-up.
- ★ Accurate to within 1/4° timing accuracy 0 to 6000 RPM range.
- ★ Can be used with Flame Thrower Coil 18-5469

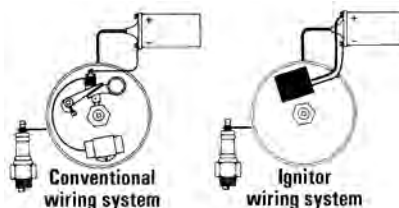

18-5294
ELECTRONIC CONVERSION KIT
 Fits: 6 cyl. Delco distributors



18-5295
ELECTRONIC CONVERSION KIT
 Fits: most 4 cyl. Prestolite distributors. (Except IBM 7026)
 For: Onan, Universal, Waukesha, Wisconsin



18-5433
IGNITION COIL
 Replaces: 201522, 2495531
 Uses External Resistor



18-5435
IGNITION COIL
 4.0 OHM
 Replaces: 200691
 Has Internal Resistor



FEATURES

- Oil filled for better cooling and long life
- Low resistance and improved turn ratios produces the higher voltage needed to run larger spark plug gaps for added power and better fuel economy
- More windings maximize energy and reliability over the full RPM range
- Fits existing brackets for easy installation

18-5469
HI-PERFORMANCE IGNITION COIL
 3.0 ohm (oil filled), black - 4 & 6 cylinder:
 Flame-Thrower 40,000 volt coil.

- Designed for use with the original Ignitor Electronic Conversion Kits
- Can be used with other inductive ignition systems



18-5472
HI-PERFORMANCE IGNITION COIL
 0.6 ohm (oil filled), black - 4, 6, & 8 cylinder:
 Flame-Thrower 45,000 volt coil.

- Super low 0.6 ohm resistance coil designed for use with the Ignitor II Hi Performance Electronic Conversion Kits
- Compatible with capacitive discharge systems



Sierra Part #	Description	Recommended Coil	Resistance Ohms
18-5294	Electronic Conversion Kit	18-5469	3.0
18-5295	Electronic Conversion Kit	18-5469	3.0
18-5286	Hi Performance Electronic Conversion Kit	18-5472	0.6

18-5450
COIL RESISTOR
 15. OHM
 Replaces: 4106140



18-5451
COIL RESISTOR
 1.5 OHM & 3.0 OHM
 Replaces: 3874767



18-5102
RELUCTOR
 Replaces: 3656017





18-5493
IGNITION PICKUP COIL ASSEMBLY
Replacement pick-up coil for Accel Electronic Distributors



18-5103
IGNITION PICKUP
Replaces: 3780600



18-5105
IGNITION MODULE
Replaces: 3874020

STANDARD IGNITION

Year	Cyl.	Model	Distributor No.	Contact Set	Condenser	Rotor	Dist. Cap	Tune-Up Kit	Electronic Dist.
1949-60	6	M37, M47 (CROWN), M36	IAL-4004-1M, IGC-4510-1M	18-5307	18-5345 ③	18-5430	—	—	—
1955-60	8	M44 (IMPERIAL), M45 (ROYAL)	IBB-4102A	18-5303 ①	18-5347 ②	18-5404-1	—	—	—
1955-61	6	M49	IAO	18-5307	—	18-5430	—	—	—
1959-62	8	M80,81,M273X,M318,A,B,M413	IBM	18-5303	18-5347 ②	18-5407	18-5369	18-5258	18-5497-2 ④
1955-62	6	M36, M46, (ACE), M47 (CROWN), M46-3, 4, M49,TACK DRIVE	IAO-4109-1M, IAO-4113-1M	18-5307	18-5345 ③	18-5430	—	—	—
1961-65	6	M170,,225,MH225	2098748, 2444430	—	18-5347 ②	18-5430	—	—	—
1960-72	8	M80, 81, M273, A, B, X, M318A, B, C, X, M383, B, X, M413, B, D, E, M426, B, D, X, M426 HEMI	IBM-4106,08, A,B,C,09,A	18-5303	18-5347 ②	18-5407	18-5369	18-5258	—
1965-66	8	M318X	IBM-4120,5	18-5303	18-5347 ②	18-5429	—	18-5259	18-5497-2
1969-72	6	M225X	IBR-4205,A,AS	—	18-5347 ②	—	—	—	—
1970	8	M440X	IBB-4205	18-5303 ①	18-5347 ②	18-5407	18-5369	18-5258	—
1970	6	M265X	IAO-4114-1M	18-5307	18-5347 ②	18-5430	—	—	—
1960-72	8	M80, 80A, 81, 273X, 318A, B, C, X, M383, B, X, M413, B, D, E, M426B, D, X, M200, 225, 250, 260,300,335,440X	IBM-4108B, C,9A	18-5303	18-5347 ②	18-5407	18-5369	18-5258	18-5497-2 ④
1972-77	6	M225X	IBR-7002,A,AS,S	18-5307	18-5345 ③	18-5430	—	—	—
1973	8	ALL	IBB-7003,S	18-5303 ①	18-5345 ③	18-5407	18-5369	—	18-5497-2 ④
1976	8	M318	3675979	18-5303	18-5347 ②	18-5407	—	18-5258	18-5497-2
1971-82	8	M273, ML318, ML340, ML440	IBM-7001,2, 3,IBM-7003B,BS, 7004A,B,AS, BS	18-5303	18-5345 ③	18-5407	18-5369	—	18-5497-2 ④
1983-88	8	273, 318, 340, 440	IBM-7016,7017	18-5303	18-5347 ②	18-5403	18-5352	18-5260	18-5497-2 ④
1971	8	M273, M318	IBM-4122	18-5303	18-5347 ②	18-5407	18-5369	18-5258	18-5497-2

- ① Two (2) used
- ② For lead wire type use 18-5345
- ③ For strap type use 18-5347
- ④ Does not include Models 413, 426, 440 CID

B.I.D. ELECTRONIC IGNITION

Year	Model/Engine	Distributor	Reluctor	Pickup	Elect. Control Unit	Rotor	Distributor Cap
1972-82	M318,M340, 360, 440	IDH-7001, 2S	18-5102	18-5103	18-5105	18-5407	18-5369
1979-82	318,340, 360, 440	IDH-7002,S, 3,3A,3AS,3S	18-5102	18-5103	18-5105	18-5407	18-5369
1983-88	318,340, 360, 440	IDH-7004, 7005	18-5102	18-5103	18-5105	18-5403	18-5352
1983-88	318,340, 360, 440	IDH-7006,A	18-5102	18-5103	18-5105	18-5403	18-5352



18-5225
SPARK PLUG WIRE KIT
Replaces:
Mercury 84-99215A26,
84-813706A26
Kit includes 25 ft. Roll of 7 MM Hypalon Ignition Wire With a Metallic Core and a Large Assortment of Three Different End Fittings to Fit Outboard Motors.



18-5226
IGNITION WIRE
Metallic Core
100' Spool • 7mm Hypalon

PKG. OF 10



18-5224
18-5224-9^①
SPARK PLUG WIRE TERMINAL
 Replaces: Mercury 20121
 OMC 510364

PKG. OF 10



18-5750
18-5750-9^①
UNIVERSAL SPARK PLUG BOOTS
 Supplied complete w/Terminal Connector
 Replaces: OMC 581027, 580339



18-5752
UNIVERSAL SPARK PLUG BOOT
 8mm



18-5840
SOLENOID
 Replaces: Prestolite 15-79,
 SAW4201, SAW4207, SAW4210



18-5841
SOLENOID
 Replaces: 1692658
 Prestolite



BATTERY CABLES
 Gauge cable with soldered lug terminals
 on each end to accept a 3/8" stud.

Part #	Size	Color	Gauge	Part #	Size	Color	Gauge
BC88523	2'	red	4	BC88563	6'	red	2
BC88533	2'	black	4	BC88573	6'	black	2
BC88543	4'	red	2	BC88583	8'	red	1
BC88553	4'	black	2	BC88593	8'	black	1

① Priced per Package

BRUSH SET/STARTER SWITCH APPLICATION

Year/Model	Volt	Original Starter No.	Starter Switch
1960-88 LM318X,340X,M80A, 81,170A,M225A, X,M251X, 265X,273X,M318,A,B,C, X,M383BX,M413,B,D,E, X,M426B,D,E,X,M440, X,M155,200,225,250,260,300,335,375	12 12 12 12 12 12 12	MCL-6115 MDT-6010,11 MDT-7001,10 MDT-7002,14 MDT-7021,22 MDU-6003,10 MDU-7001	— 18-5840 18-5841 18-5840 — 18-5841 18-5841
1961-69 M225,MH225,M273,A,B, LM318,B,M318A,B,C, M383,B,X,M413,E,M426 B,D,X,M426 Hemi	12 12 12 12 12 12 12 12 12 6 & 12	MDT-6010,11 MDT-7002,14 2095150 1779955 2,095,393,509 2095509 MDT-7002,14 MDT-7001,10 MDT-7001,10	18-5841 18-5841 18-5841 18-5841 18-5841 18-5841 18-5841 18-5841 18-5841
1959-69	12 12 12	MDU-6003,10 MDT-7001,10 MDT-7002	18-5841 18-5841 18-5841
1961-68	12	MDT-6010,11	18-5840
1961-65	12	MDU-7001	18-5841
1955-71 M26,46,46-4 (Ace),M27, 47,47-4, (Crown),M28, 36,37,38,44,44-3,48 (Royal)M45(Imperial), M45-3,46-3,47-3,M49	6 6 12 12 12 12	MCL-6102,M,07 MCL-6127,28,M MCL-6020M MCL-6115 MDT-6010,11M MDU-7013	— — — — 18-5840 —



18-9802
TIMING LIGHT
 Self-powered accurate up to 10,000 RPM's



18-5710
VOLTAGE REGULATOR
 Replaces: 2847527, 2098300 Prestolite
 VSH-6201JY

Year/Model	Volt	Original	Alt/Gen. No.
1970-88 M273X,LM318X	12	ANE-5201S,2S,2YS	
1972-77 225,318X,340,X,400,440	12	3527502	

18-5723
VOLTAGE
REGULATOR
(Field Relay)
 Replaces: 2095946
 (Use with 18-5710)



Year/Model	Volt	Original Alt/Gen. No.
1961-70		
B,D,X, M426 Hemi	12	2095860

Standard Rotation

CCW Rotation

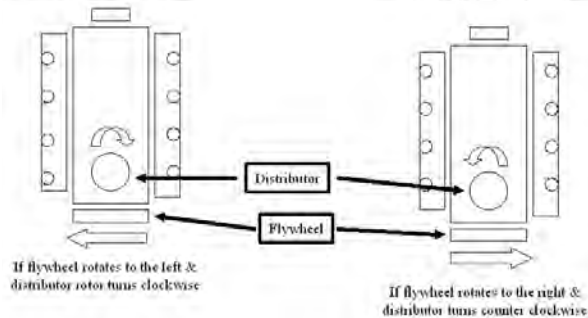

18-6270
PERMANENT MAGNET
I/O STARTER
 Heavy Duty - 12 Volt
 2 Bolt Mount - 1 Threaded Hole - CW Rotation
 Fits: Ford 460
 Permanent Magnet I/O



18-6835
STARTER
 Replaces: GM Engines Universal
 Used on all GM Engines with either 14 1/4" or 12 3/4" flywheels



18-5954
ALTERNATOR
 Replaces: 3527501, 3527502, 3744870
 61 Amps



18-7089
CARB KIT



18-7091
CARB KIT

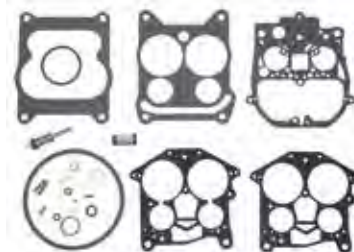

18-7095
CARB KIT



18-7725
CARB KIT



18-7726
CARB KIT



18-7201
FLOAT
 (Alcohol Resistant)
 Brass

CARBURETOR KIT / FLOAT APPLICATION

Years	Cyl.	Model or Engine Displacement	Mfg. Code	Carb. Model	Carburetor Number	Float	Carb. Kit ①
1965 -Up	8	M-273-B,LM-318-B, M-340-B, M-360-B,M383-B,M-440-B	C-4	AFB	3980, 6130, 6212	—	18-7089
1965-69	8	M-318-B,M-383, M-413,M-426, M-440	C-4	AFB	3213, 3214, 3392, 3543, 4476, 4699, 9263, 9264	—	18-7091
—	8	318" (5.2L), 360" (5.9L)	R-4	4MV	17084001, 17086115, 17086116	18-7201	18-7095
—	8	M-80, M-81 318" (5.2L), 361" (5.9L) (2 Carb. Installation)	C-1	YH	2911, 3035, 3195	—	18-7725
—	6	M-225, M-225D, MH-225	C-2	BBD	3389, 3390, 4268	—	18-7726
—	8	M273A, M318A, M318G	C-2	BBD	3212, 3979, 3981	—	18-7726

① Does not include Metering Rods.

ALL SIERRA FUEL PUMPS INCLUDE MOUNTING GASKET

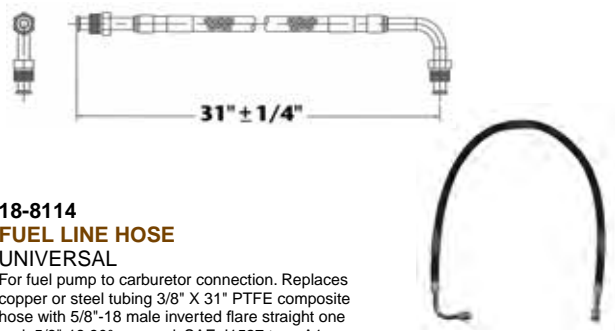

18-8114
FUEL LINE HOSE
UNIVERSAL

For fuel pump to carburetor connection. Replaces copper or steel tubing 3/8" X 31" PTFE composite hose with 5/8"-18 male inverted flare straight one end, 5/8"-18 90° one end. SAE J1527 type A1

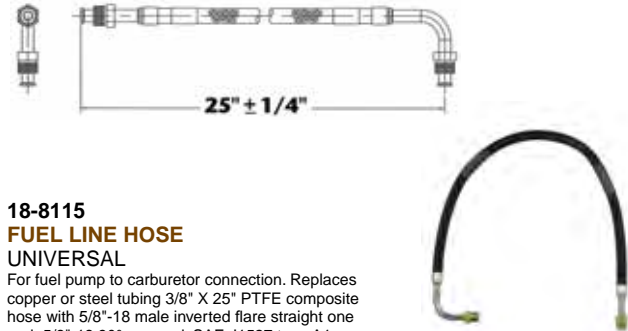

18-8115
FUEL LINE HOSE
UNIVERSAL

For fuel pump to carburetor connection. Replaces copper or steel tubing 3/8" X 25" PTFE composite hose with 5/8"-18 male inverted flare straight one end, 5/8"-18 90° one end. SAE J1527 type A1







FUEL WATER SEPARATORS



Sierra offers a complete line of 10 and 21 micron fuel water separating filters including drainable bowl filters to protect your carbureted and fuel injected engine.

Refer to pages 136-140 for a complete listing of OEM and universal applications.

Sierra fuel water separators remove over 99.8% of emulsified water from your gasoline. Sierra's 10 micron filters are over 90% efficient at removing particles as small as 10 micron. All filters flow @ 90 GPH to feed even the hungriest motor. Sierra 10 micron filters are recommended to prevent damage to sensitive inboard and outboard fuel injection systems.

Sierra #	Chrysler #	Description
18-7964-1	—	Transmission Filter
 18-7230 FLAME ARRESTOR Replaces: 4142886 Ht. 2.250 Element 1.470 Throat 5.050 1 Vent Tube	 18-7254 FUEL PUMP Replaces: 3745414 (Flange I.D. #6766, M6766) For: (V-8) 318,360	 18-7255 FUEL PUMP Replaces: 3745415 (Flange I.D. #6767, M6767) For: (V-8) 361, 400, 413, 440
 18-7264 FUEL PUMP Replaces: 2279913, 1736073 (Flange I.D. #40781, M6866) For: (V-8) 273, 318, 340, 360	 18-3551 THERMOSTAT Replaces: 4142885 142° 2.125 O.D. x 1.500 H	 18-3645 THERMOSTAT Replaces: 2463441 For: 318 & 360 CID Engines 160°



18-3047
IMPELLER KIT
Contains: 18-3061 Impeller



18-3060
IMPELLER
Replaces: Sherwood 9959



①**18-3046D** Display Package

18-3046
IMPELLER KIT
Replaces: Sherwood 9959K
Contains: 18-3060 Impeller



18-3061
IMPELLER
Replaces: Sherwood 10615
For: GM engines with V-Belt



18-3168
SEAL & SEAT
Replaces: Sherwood 10927
For: 318 CID Engines (1975-77) & 360 CID Engines (1975)



18-3581
CIRCULATING WATER PUMP
(Bi-Directional)
Replaces: 3004886, 3745985, 3619542, 4417905
For: Engine Models 318, 340 & 360



18-3582
CIRCULATING WATER PUMP
Replaces: 3619859
For: 383,400,440

②**18-4456D** Display Package



18-4456
EXHAUST PROTECTOR VALVE
Includes Stainless Steel Clamp
3"

②**18-4457D** Display Package



18-4457
EXHAUST PROTECTOR VALVE
Includes Stainless Steel Clamp
4"

②**18-4458D** Display Package



18-4458
EXHAUST PROTECTOR VALVE
Includes Stainless Steel Clamp
5" & 6" (5" requires two 45° cuts)

OIL FILTERS

Part #	Replaces:
18-7875	1851658, 56874, F724002 (Long)
18-7878-1	L-19, L-1008, 3549957 (Short)
18-7879-1	L-319

SEE PAGES 182-184 & 1147-1170 FOR ADDITIONAL INFORMATION



① Display Package



18-3878
HEAD GASKET
Replaces: 4417375



18-3860
HEAD GASKET
Replaces: 4142880
For: 318 CID Engines



18-0609
VALVE COVER GASKET
Replaces: 4273129
For: 318/340/360 CID

PKG. OF 2



18-0499
18-0499-9
WATER PUMP PLATE GASKET
Replaces: 10612

Fits Chrysler Small Block V8 318-360 cu. in. All Models 1966 & up with Fixed Exhaust

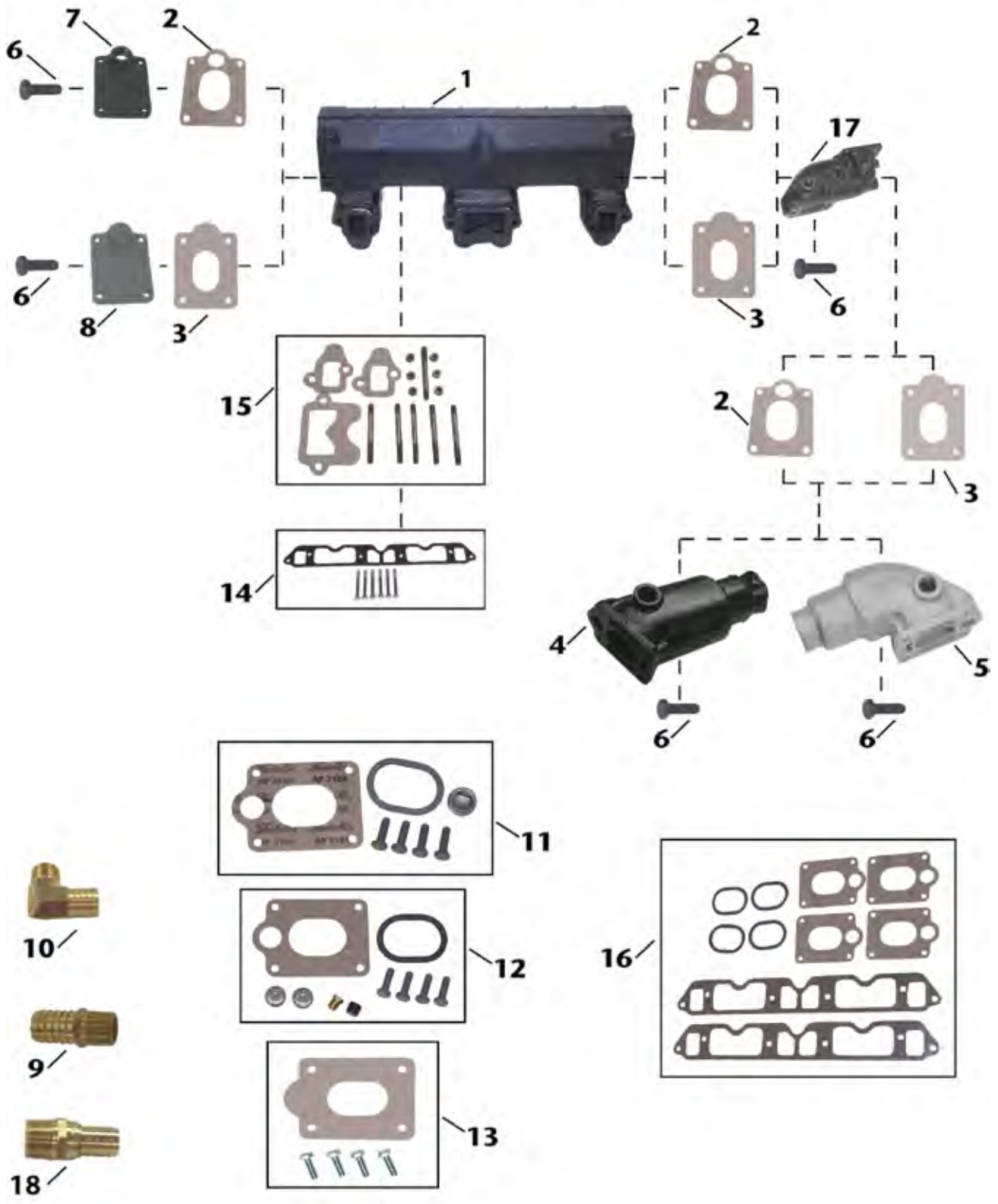

Item No.	Description	OE No.	Application
1	18-1940 MANIFOLD	4142322, 3675826	Chrysler Models 318-360CID Engines (1966 & Up); Use manifold mounting kit 18-8526 or 18-8527 (stainless).
2	18-2941 END CAP GASKET (OPEN)	2847480, 2469559	Fits: End Caps of Manifold (Starboard & Port) 18-1940; Risers: 18-1945; Elbows: 18-1946 & 18-1913
3	18-0472-1 END CAP GASKET (BLOCKED)	N/A	Fits: End Caps of Manifold (Starboard & Port) 18-1940; Risers: 18-1945; Elbows: 18-1946 & 18-1913
4	18-1946 MANIFOLD ELBOW	3527794	Use in conjunction with 18-1945. 3" exhaust outlet & a 20° down angle.
5	18-1913 MANIFOLD ELBOW	2469639, 2847405	Use in conjunction with 18-1945. 3" exhaust outlet & a 90° down angle.
6	NSS MOUNTING BOLT	N/A	Included in 18-4360, 18-4361, & 18-8506 mounting kits.
7	18-1942 MANIFOLD END PLATE (OPEN)	2846106	Use with End Plate Gasket: 18-2941 (Open); Mounting Kit: 18-4360 (Open) or 18-4361 (Open); (Port & Starboard) Manifold: 18-1940
8	18-1941 MANIFOLD END PLATE (BLOCKED)	2469556, 3675826	Use with End Plate Gasket: 18-2941; Mounting Kit: 18-4360 or 18-4361; (Port & Starboard) Manifold: 18-1940
9	18-4461 HOSE FITTING	N/A	3/4" - 14NPT X 1" Hose (Corrosion Resistant Brass Fitting)
10	18-8216 HOSE FITTING	N/A	3/4" - 14 NPT x 1" Hose (Corrosion Resistant Brass Fitting)
11	18-4360 MOUNTING PACKAGE (OPEN GASKET)	N/A	Use with End Plates: 18-1942 (open) or 18-1941 (Blocked); Riser/Elbow: 18-1945, 18-1946, 18-1913
12	18-4361 MOUNTING PACKAGE (OPEN GASKET)	N/A	Use with End Plates: 18-1942 (open) or 18-1941 (Blocked); Riser/Elbow: 18-1945, 18-1946, 18-1913
13	18-8506 MOUNTING KIT (BLOCKED GASKET)	N/A	Use with Riser/Elbow: 18-1945, 18-1946, 18-1913; End Plate: 18-1941 (Blocked)
14	18-8526 MOUNTING KIT	N/A	Use with Manifold: 18-1940
15	18-8527 MOUNTING KIT (STAINLESS STEEL)	N/A	Use with Manifold: 18-1940 (Kit has stainless steel studs and nuts)
16	18-4346 EXHAUST MANIFOLD GASKET SET	3745220	318 CID Engines (1969-85)
17	18-1945 MANIFOLD RISER	2846689	Use with Manifold: 18-1940; Riser Gasket: 18-2941 (Open) or 18-0472-1 (Closed); Mounting Kit: 18-4361 (Open) or 18-4360 (Open) or 18-8506 (Blocked)
18	18-8215 HOSE FITTING	N/A	3/4" - 14NPT X 3/4" Hose (Corrosion Resistant Brass Fitting)



Fits Chrysler Big Block V8 383-440 cu. in. All Models Except 413 "E" with Staggered Bolt Pattern

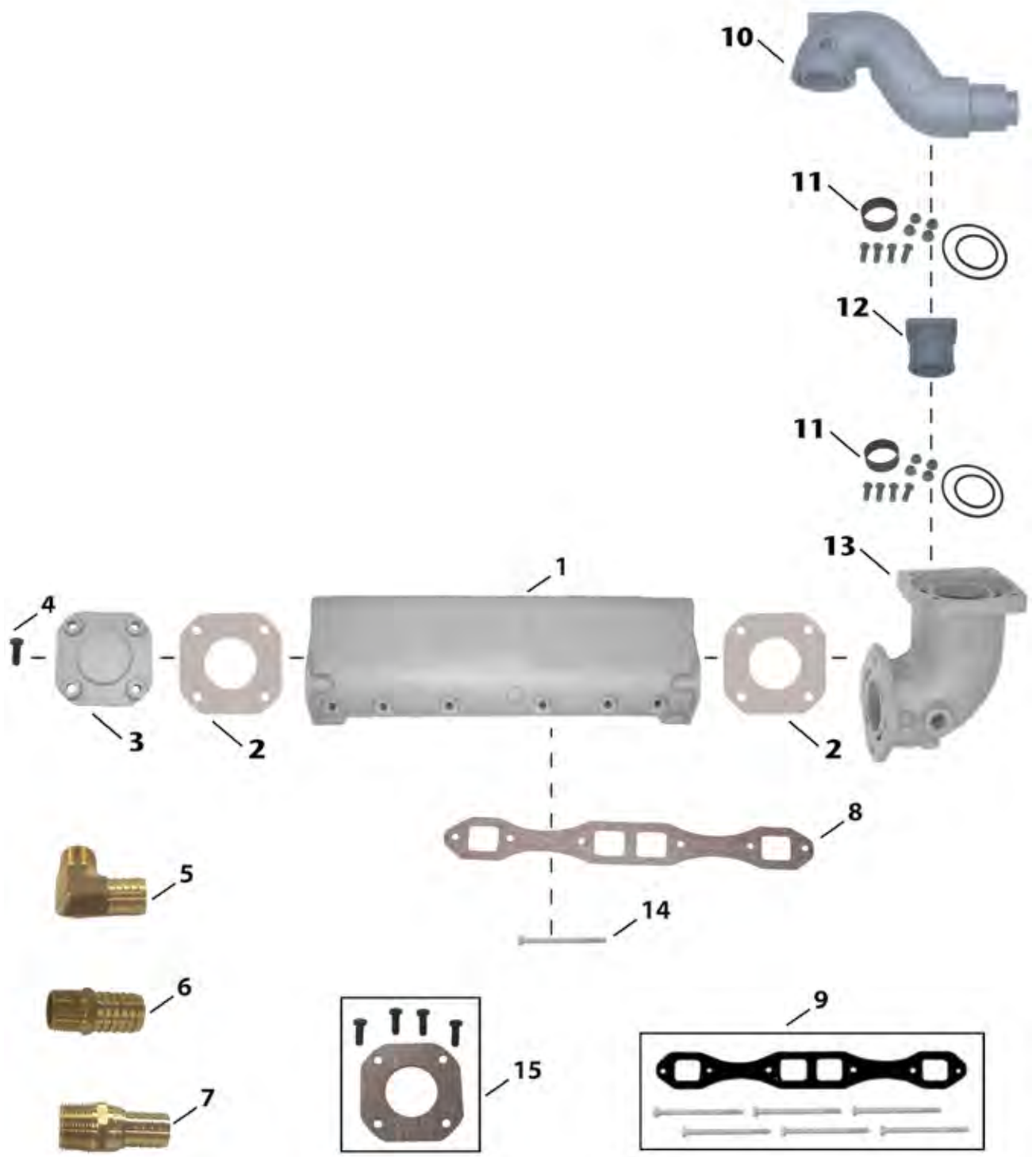

Item No.	Description	OE No.	Application
1	NSS MANIFOLD	E7081M, 3619659	Chrysler Models 383-440 cu.in. (V8 Big Block). Use with Manifold Gasket: 18-0474-1; Front Plate: 18-1911
2	18-0471 ELBOW GASKET	N/A	Gasket for Elbow:18-1948 ; End Plate: 18-1911
3	18-1911 END/FRONT PLATE	N/A	Use with Elbow Gasket: 18-0471, &/or Mounting Kit: 18-8501
4	NSS MOUNTING BOLT	N/A	Included in 18-8501 mounting kit.
5	18-8216 HOSE FITTING	N/A	3/4" - 14 NPT x 1" Hose (Corrosion Resistant Brass Fitting)
6	18-4461 HOSE FITTING	N/A	3/4" - 14NPT X 1" Hose (Corrosion Resistant Brass Fitting)
7	18-8215 HOSE FITTING	N/A	3/4" - 14NPT X 3/4" Hose (Corrosion Resistant Brass Fitting)
8	18-0474-1 MANIFOLD GASKET	N/A	
9	NSS MOUNTING KIT	N/A	Big Block (V8) 383-440 cu.in. (All models except 413"E" with offset bolt pattern) Includes 18-0474-1 Manifold Gasket
10	18-1944 RISER	2847404, 2847623, 3745639, E9923M	Use with Manifold: 18-1940; Mounting Kit: 18-8518
11	18-8518 MOUNTING KIT	N/A	Use with Riser: 18-1944.
12	N/A EXTENSION	N/A	Use in conjunction with 18-1948. Use mounting kit: 18-8518.
13	18-1948 RISER	E9234M	Use with 18-8501 mounting kit.
14	NSS MOUNTING BOLT	N/A	
15	18-8501 MOUNTING KIT	N/A	Used with Front Plate: 18-1911; Elbow:18-1948



Fits Chrysler Small Block V8 318-360 cu. in. All Models 1966 & up with Swivel Exhaust

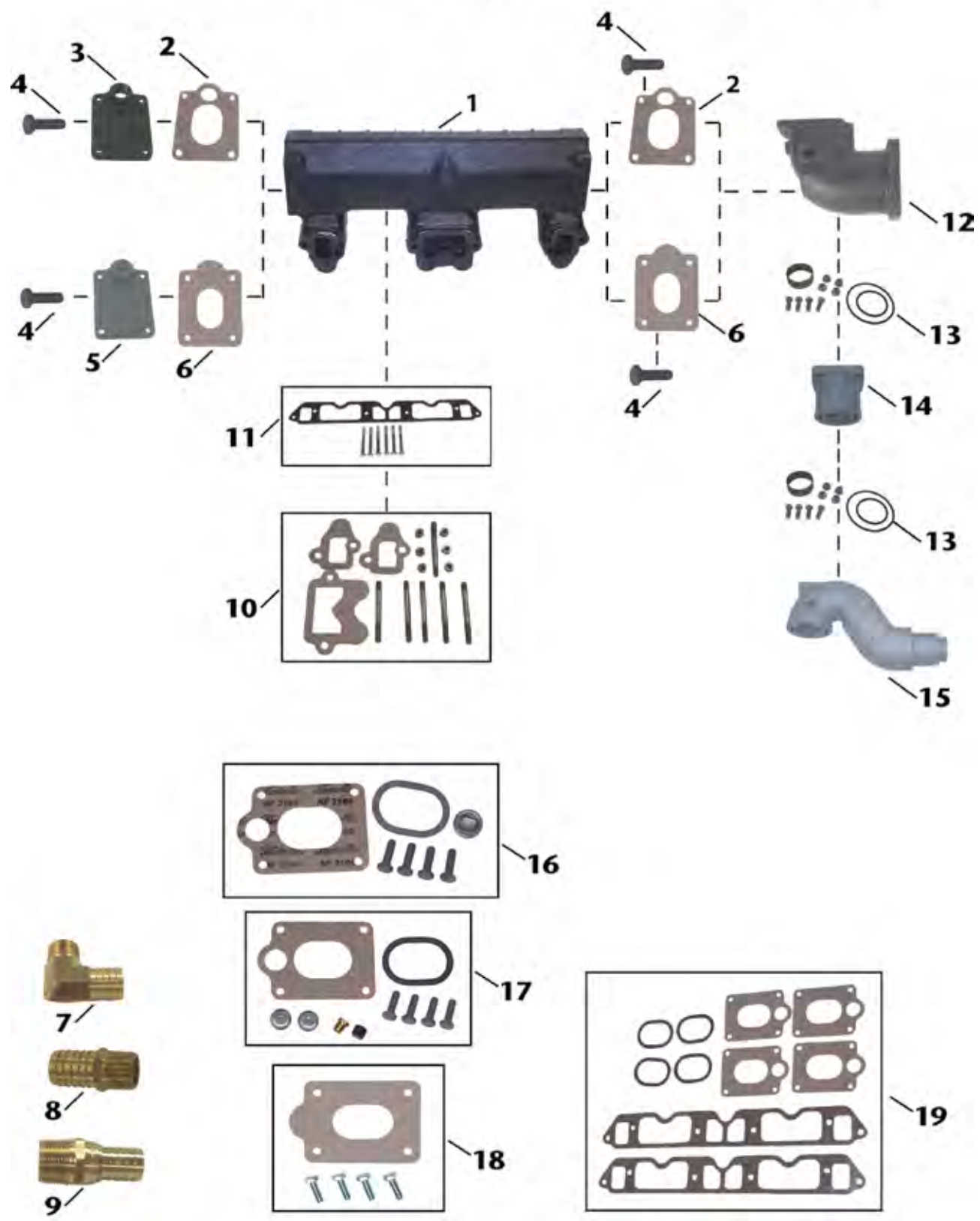

Item No.	Description	OE No.	Application
1	18-1940 MANIFOLD	4142322, 3675826	Chrysler Models 318-360CID Engines (1966 & Up); Use manifold mounting kit 18-8526 or 18-8527
2	18-2941 END CAP GASKET (OPEN)	2847480, 2469559	Fits: End Caps of Manifold (Starboard & Port) 18-1940. Included in 18-4360, & 18-4361 mounting kits.
3	18-1942 MANIFOLD END PLATE	2469556, 3675826	Use with End Plate Gasket: 18-2941; Mounting Kit: 18-4360 or 18-4361
4	NSS MOUNTING BOLT	N/A	Included in 18-4360, 18-4361, & 18-8506 mounting kits.
5	18-1941 MANIFOLD END PLATE	2846106	Use with End Plate Gasket: 18-0472-1 ; Mounting Kit: 18-8506
6	18-0472-1 END CAP GASKET (BLOCKED)	N/A	Fits: End Caps of Manifold (Starboard & Port) 18-1940. Included in 18-8506 mounting kit.
7	18-8216 HOSE FITTING	N/A	3/4" - 14 NPT x 1" Hose (Corrosion Resistant Brass Fitting)
8	18-4461 HOSE FITTING	N/A	3/4" - 14NPT X 1" Hose (Corrosion Resistant Brass Fitting)
9	18-8215 HOSE FITTING	N/A	3/4" - 14NPT X 3/4" Hose (Corrosion Resistant Brass Fitting)
10	18-8527 MOUNTING KIT (STAINLESS STEEL)	N/A	Use with Manifold: 18-1940 (Kit has stainless steel studs and nuts)
11	18-8526 MOUNTING KIT	N/A	Use with Manifold: 18-1940
12	N/A ELBOW	2600402	Use with Manifold: 18-1940. Use mounting kit 18-4360, 18-4361, or 18-8506.
13	18-8518 MOUNTING KIT	N/A	Use with Riser: 18-1944
14	N/A EXTENSION	N/A	Use mounting kit: 18-8518.
15	18-1944 RISER	N/A	Use with Manifold: 18-1940. Use with mounting kit: 18-8518
16	18-4360 MOUNTING PACKAGE (OPEN GASKET)	N/A	Use with End Plates: 18-1942 (open) or 18-1941 (Blocked).
17	18-4361 MOUNTING PACKAGE (OPEN GASKET)	N/A	Use with End Plates: 18-1942 (open) or 18-1941 (Blocked).
18	18-8506 MOUNTING KIT (BLOCKED GASKET)	N/A	Use with End Plate: 18-1941 (Blocked).
19	18-4346 EXHAUST MANIFOLD GASKET SET	3745220	318 CID Engines (1969-85)



ALL SIERRA MANIFOLDS ARE PAINTED, PACKAGED AND LEAK TESTED

18-1940

MANIFOLD

Port & Starboard

Replaces: 4142322, 3675826

Barr CM-1-6677A

Fits: Chrysler Model 273, 318, 340 & 360

CID engines (1973-1986)

Use with:

End Cap Gasket: 18-2941 Open or 18-0472-1 Blocked

Mounting Kit: 18-4360 Open or 18-4361 Open or 18-8506 Blocked

End Plate: 18-1941 Blocked or 18-1942 Open

Note: If using a blocked end plate either gasket will work. If using an open end plate use only an open gasket.



18-1997-1

MANIFOLD

Port & Starboard

Replaces: Barr CHV-1-83

Universal Center Riser Manifold

FITS:

Chrysler 283, 302, 307 and 350 CID engines

Crusader 283 and 327 CID engines thru 1964; 305, 307 and 350 CID engines 1965 and later

Daytona 200-283 and 300-327

Flagship 283, 327 and 350 CID engines

Pacer 305, 307 and 350 CID engines 1965 and later

Mercury 190, 198, 225, 250, 270, 228, 898, 260, 255 and 280 models

OMC 283, 305, 307 and 350 CID engines 1968-1980

Volvo 307 and 350 CID engines

Use 18-0604 Exhaust Manifold Gasket Set

***For Exploded View - See Pages 638-639**



18-1898

MANIFOLD

Port & Starboard

Replaces: Barr CHVA-1-84, Marine Power 0991-110

Fits: 454 cu.in. GM big block V8 engines

Use with:

Exhaust Manifold Gasket: 18-0418

***For Exploded View - See Pages 636-637**



18-1945

RISER

Replaces: 2846689, Barr CM-20-6674

Fits: Chrysler Model 273, 318, 340 & 360 CID engines (1966-1986)

Use with:

Manifold: 18-1940

Riser Gasket: 18-2941 open or 18-0472-1 blocked

Mounting Kit: 18-4361 open or 18-4360 open or 18-8506 blocked



18-1939

RISER

Replaces: Barr 20-0100, Marine Power 0992-593

Barr, Indmar and Marine Power Ford Small Block V8 302-351 cu.in., GM Small Block V8 305-350cu.in., GM Big Block V8 454cu.in.

Use with:

Manifold: 18-1997-1 or 18-1998-1 or 18-1898

Riser Gasket: 18-2854-1 open or 18-0476-1 blocked

Mounting Kit: 18-4364 open or 18-8535 blocked



18-1944

RISER

Replaces: 2847404, 2847623,

3745639, E9923M

Barr CM-20-414211

Chrysler Small Block V8 318-360cu.in.

(All models 1966 and up with swivel exhaust),

Big Block V8 383-440cu.in. (All models except

413"E" with offset bolt pattern)

Use with:

Manifold: 18-1940

Mounting Kit: 18-8518



18-1907

RISER

Replaces: Barr 20-0102, Indmar 53-2009, 53-2018

Barr and Indmar Ford Small Block V8 302-351cu.in.

Use with:

Manifold: 18-1997-1 or 18-1998-1

Riser Gasket: 18-2854-1 open or 18-0476-1 blocked

Mounting Kit: 18-4364 open or 18-8535 blocked



18-1946

ELBOW

Replaces: 3527794

Barr CM-20-6672

Fits Chrysler Model 273, 318,

340 & 360 CID engines (1966-1986)

will work in conjunction with 18-1945

Use with:

Manifold: 18-1940

Elbow Gasket: 18-2941 open or 18-0472-1 blocked

Mounting Kit: 18-4360 open or 18-4361 open or 18-8506 blocked

20°

18-1913
ELBOW
Replaces: Chrysler 2469556, 2469639, 2847405
 Chrysler Small Block V8 318-360 cu.in.
 (All Models 1966 and up with fixed exhaust)
 For: 18-1940 Manifold will work in conjunction with **18-1945**
Use with:
 Elbow Gasket: 18-2941 open or 18-0472-1 blocked
 Mounting Kit: 18-4360 open or 18-4361 open or 18-8506 blocked



18-1948
ELBOW
Replaces: Chrysler E9234M
 Barr CM-20-9234
 Chrysler Big Block V8 383-440cu.in.
 (All Models except 413"E" with offset bolt pattern)
Use with:
 Elbow Gasket: 18-0471
 Mounting Kit: 18-8501



18-1911
MANIFOLD END PLATE
 Chrysler Big Block V8 383-440cu.in.
 (All Models except 413"E" w/offset bolt pattern)
Used with:
 Front/End Plate Gasket: 18-0471
 Mounting Kit: 18-8501



18-1941
MANIFOLD END PLATE
Replaces: 2846106
 Barr CM-1-6672-B
Use with:
 End Plate Gasket: 18-2941 open or 18-0472-1 blocked
 Mounting Kit: 18-4360 open or 18-4361 open or 18-8506 blocked



18-1942
MANIFOLD END PLATE
 with hole
Replaces: 24695566, 3675826
 Barr CM-1-6672-H
Use with:
 End Plate Gasket: 18-2941
 Mounting Kit: 18-4360 or 18-4361
Fits: 18-1940 Manifold



18-0607
INTAKE MANIFOLD GASKET SET
Replaces: 3745217
For: 318 CID Engines (1969-82)



18-4346
EXHAUST MANIFOLD GASKET SET
Replaces: 3745220
For: 318 CID Engines (1969-85)

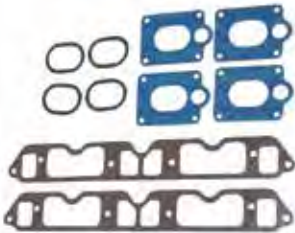

18-0474-1
MANIFOLD GASKET



18-0471
ELBOW GASKET
Used with:
 Elbow: 18-1948
 End Plate: 18-1911



18-0472-1 (Blocked)
ELBOW GASKET
Used with:
 Riser/Elbow: 18-1945, 18-1946, 18-1913
 End Plate: 18-1941



18-0956-1
EXHAUST MANIFOLD GASKET
Replaces: 118-614
For: 460 CID



18-4360 (Open)
EXHAUST ELBOW MOUNTING KIT
 Barr CM206672JP
Use with:
 Exhaust Elbow: 18-1946, 18-1913, 18-1945
 End Plate: 18-1942 open or 18-1941 blocked



18-4361 (Open)
EXHAUST ELBOW MOUNTING KIT
 Barr CM-20-6674P
Use with:
 End Plate: 18-1942 open or 18-1941 blocked
 Riser: 18-1945
 Elbow: 18-1946, 18-1913





18-4364 (Open)
EXHAUST ELBOW KIT
 Replaces: Barr 20-0082-P
 Use with:
 Riser: 18-1999, 18-1907, 18-1939

PKG. OF 2



18-2941 (Open)
18-2941-9^①
END CAP GASKET
 Replaces:
 2847480, 2469559
 Use with:
 End Plate: 18-1941, 18-1942
 Riser/Elbow: 18-1945, 18-1946, 18-1913
 For: 318CID Engines



18-8501
EXHAUST ELBOW MOUNTING KIT
 Barr CM-20-9234 P
 Chrysler Big Block V8 383-440 cu.in.
 (Models: All except 413 "E" with offset bolt pattern)
 Used with:
 Front Plate: 18-1911
 Elbow: 18-1948

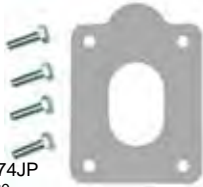

18-8506
EXHAUST ELBOW MOUNTING KIT
 Replaces: Barr CM-20-6674JP
 Chrysler Small Block V8 318-360 cu.in. (All models 1966 and up with swivel and fixed exhaust)
 Used with:
 Riser: 18-1945
 Elbow: 18-1946, 18-1913
 End Plate: 18-1941 blocked



18-8518
EXHAUST ELBOW MOUNTING KIT
 Replaces: Barr CM-20-9232P
 Chrysler Small Block V8 318-360cu.in. (All models 1966 and up with swivel exhaust), Big Block V8 383-440cu.in. (All models except 413 "E" with offset bolt pattern)
 Used with:
 Riser: 18-1944



18-8526
EXHAUST MANIFOLD MOUNTING KIT
 Chrysler Small Block V8 318-360cu.in.
 (All models 1966 and up with swivel and fixed exhaust)
 Used with:
 Manifold: 18-1940



18-8527
EXHAUST MANIFOLD MOUNTING KIT
 Replaces: Barr CM-1-6677SS P
 Chrysler Small Block V8 318-360cu.in.
 (All models 1966 and up with swivel and fixed exhaust)
 Used with:
 Manifold: 18-1940
 (Kit has stainless steel studs and nuts)



18-8535
EXHAUST ELBOW MOUNTING KIT
 Barr, Indmar and Marine Power
 Ford Small Block V8 302-351cu.in.,
 GM Small Block V8 305-350cu.in.,
 GM Big Block V8 454cu.in.
 Used with:
 Risers: 18-1939, 18-1999, and 18-1907



18-8536
EXHAUST ELBOW MOUNTING KIT
 Barr, Indmar and Marine Power GM Small Block V8 305-350cu.in.
 Used with:
 Manifold: 18-1997-1



PIPE PLUGS

Part #	Thread Size	Part #	Thread Size
18-4256	1/4"	18-4263	1/8" - 27 NPT
18-4257	1/4"	18-4264	3/8" - 18 NPT
18-4258	3/4"		

56507 Pipe Sealant with Teflon® is recommended for use on plug threads.



18-4218D



18-4218
BRASS DRAIN COCK (1/4")
 Used with:
 Most O.E.M. Manifolds
18-3223-9 (Bulk Pack of 12)



18-8538
EXHAUST MANIFOLD MOUNTING KIT
 Barr and Indmar Ford Small Block V8 302-351cu.in.
 Used with:
 Manifold: 18-1998-1



18-7512
EXHAUST ELBOW SEAL KIT
 Replaces: 7087-OR
 For use with 18-1944 Exhaust Riser

PKG. OF 8



FREEZE PLUGS
18-5961 **18-5962**
18-5961-9 **18-5962-9**
 1 5/8" 1 3/4"
 BRONZE



18-4461
HOSE BARB
 3/4" - 14 NPT x 1" Hose
 Corrosion Resistant Brass Fitting



18-8215
HOSE BARB
 Fits: Chrysler V8



18-8216
HOSE BARB
 Fits: Chrysler-Small Block V8 (318-360ci), Big Block V8(383-440)

① Priced per Package ② Items ending in "D" are Display Packaged - Regular number is Non-Display

CRUSADER MODEL IDENTIFICATION

MODEL C X L X H F L 245 M SERIAL 631254

- 1st Space: **MANUFACTURER**
C - Crusader
- 2nd Space: **FACTORY FRESHWATER / CLOSED COOLING**
X-Freshwater Cooled
(Space Omitted If Raw Water Cooled)
- 3rd Space: **ENGINE ROTATION**
L - Rotation, Left-Hand from Rear
R - Rotation, Right-Hand from Rear
- 4th Space: **ENGINE TYPE**
A = 5.7L (350 CID HO) (GM)
G = 5.0L (305 CID) (GM)
Q = 6.0L (364 CID) (GM)
X = 8.1L (496 CID STD) (GM)
Z = 8.1L (496 CID HO) (GM)
- 5th Space: **DRIVE MANUFACTURER**
W - Borg-Warner
H - Hurth
T - Walters
V - Velvet Drive (cast iron units specify 71c or 72c)
- 6th Space: **DRIVE FUNCTION / APPLICATION**
R - Reverse / Reduction
V - Vee Drive / Reversed Risers
F - Full Reversing
- 7th Space: **PROPELLER SHAFT ROTATION**
L - Left-Hand Rotation
R - Right-Hand Rotation

8th 9th 10th Spaces: **DRIVE GEAR RATIO OR REDUCTION**
The drive gear ratio will appear in these spaces which identifies the production gear specs. The example gear number shown is a (2.45:1). If the gear being identified does not have 3 digits, a "0" will appear in 10th space.
Example: (2.0:1) will appear as 200
(1.5:1) will appear as 150

***MODELS ENDING WITH "000000" IN PLACE OF DRIVE I.D. ARE BOBTAIL ENGINES.**

11th Space: **IGNITION / FUEL TYPE USED**
D - DISTRIBUTOR (Carb)
E - THROTTLE BODY INJECTION
M - MULTI-PORT FUEL INJECTION

SERIAL NUMBER I.D.
1st DIGIT INDICATES DECADE ENGINE WAS MANUFACTURED (5 = 1990, 6 = 2000, 7 = 2010)
2nd DIGIT INDICATES YEAR ENGINE WAS MANUFACTURED.

①18-5250D Display Package



18-5250 TUNE-UP KIT

<p>Part # 18-5311 18-5345 18-5418</p>	—CONTAINS—	<p>Description Contact Set Condenser Rotor</p>
---	------------	--

Delco 4 & 6 cyl.

Display Package



18-5251 TUNE-UP KIT

<p>Part # 18-5314 18-5338 18-5404-1</p>	—CONTAINS—	<p>O.E. # 20117 12530 20223</p>	<p>Description Contact Set Condenser Rotor</p>
---	------------	---	--

Mallory 8 cyl. Tall Cap



18-5252 TUNE-UP KIT

<p>Part # 18-5310 18-5344 -</p>	—CONTAINS—	<p>Description Contact Set Condenser Rotor</p>
---	------------	--

Delco 8 cyl.

Display Package



18-5255 TUNE-UP KIT

<p>Part # 18-5303 18-5345 18-5407</p>	—CONTAINS—	<p>O.E. # 41058 41057, 705787 41059</p>	<p>Description Contact Set Condenser Rotor</p>
---	------------	---	--

Prestolite 8 cyl.



18-5256 TUNE-UP KIT

<p>Part # 18-5314 18-5338 18-5411</p>	—CONTAINS—	<p>O.E. # 20117 12530 12531</p>	<p>Description Contact Set Condenser Rotor</p>
---	------------	---	--

Mallory 8 cyl. Flat Cap

① Items ending in "D" are Display Packaged - Regular number is Non-Display

①18-5258D Display Package



**18-5258
TUNE-UP KIT**

Part #	O.E. #	Description
18-5303	41058	Contact Set
18-5347	—	Condenser
18-5407	41059	Rotor



**18-5259
TUNE-UP KIT**

Part #	O.E. #	Description
18-5303	41058	Contact Set
18-5347	—	Condenser
18-5429	—	Rotor

①18-5260D Display Package



**18-5260
TUNE-UP KIT**

Part #	O.E. #	Description
18-5303	41058	Contact Set
18-5345	41057, 705787	Condenser
18-5403	—	Rotor



**18-5266
TUNE-UP KIT**

Fits: Flame Thrower Distributors 18-5481, 18-5482, 18-5483, 18-5477, 18-5478, 18-5479



**18-5269
TUNE-UP KIT**

Part #	O.E. #	Description
18-5311	41058	Contact Set
18-5345	41057, 705787	Condenser
18-5418	—	Rotor
18-5386	—	Distributor Cap

GM V-6 — Single Point



**18-5270
TUNE-UP KIT**

Part #	O.E. #	Description
18-5310	380543	Contact Set
18-5344	382125	Condenser
—	381711	Rotor
18-5384	383587	Distributor Cap

Delco V-8 - Single Point



**18-5271
TUNE-UP KIT**

Part #	O.E. #	Description
18-5314	20117	Contact Set
18-5338	12530	Condenser
18-5404-1	20223	Rotor
18-5376	20222	Distributor Cap

Mallory V-8 Tall Cap — Single Point



**18-5272
TUNE-UP KIT**

Part #	O.E. #	Description
18-5314	20117	Contact Set
18-5338	12530	Condenser
18-5411	12531	Rotor
18-5375	1003317, 12532	Distributor Cap

Mallory V-8 Flat Cap — Single Point - Side



**18-5275
TUNE-UP KIT**

Part #	O.E. #	Description
18-5303	41058	Contact Set
18-5347	—	Condenser
18-5403	41089, 41074	Rotor
18-5352	41076	Distributor Cap

Prestolite V-8 - Single Point - Screw Down Cap



**18-5276
TUNE-UP KIT**

Part #	O.E. #	Description
18-5303	41058	Contact Set
18-5347	—	Condenser
18-5403	41089, 41074	Rotor
18-5353	41069	Distributor Cap

Prestolite V-6 - Single Point - Screw Down Cap

APPLICATION BEGINS ON PAGE 597

Items ending in "D" are Display Packaged - Regular number is Non-Display



18-5277
TUNE-UP KIT
—CONTAINS—
Part # O.E. # Description
18-5303 41058 Contact Set
18-5347 — Condenser
18-5407 41059 Rotor
18-5369 41052 Distributor Cap
Prestolite V-8 - Single Point - Clip Down Cap

Display Package



18-5278
TUNE-UP KIT
Delco EST - V-6



18-5279
TUNE-UP KIT
Prestolite Electronic - V-8
—CONTAINS—
Part # Description O.E. # Qty.
18-5352 Distributor Cap 392-9766 1
18-5403 Rotor 392-9089 1



18-5280
TUNE-UP KIT
Delco EST - In-Line 4
—CONTAINS—
Part # Description O.E. # Qty.
18-5361 Distributor Cap 986643 1
18-5406 Rotor, Delco 986651 1



18-5281
TUNE-UP KIT
Delco EST - V-8
—CONTAINS—
Part # Description O.E. # Qty.
18-5354 Distributor Cap 808483 1



18-5301
TUNE-UP KIT
Replaces:
Fits: male cap v-8 flamethrower distributors



18-5302
TUNE-UP KIT
Replaces:
Fits: male cap v-8 flamethrower distributors



18-5303
CONTACT SET
Replaces: 41058



18-5307
CONTACT SET
Replaces: 705788



18-5310
CONTACT SET
Replaces: 12525



18-5311
CONTACT SET



18-5314
CONTACT SET
Replaces: 20117



18-5318
CONTACT SET
Replaces: 3000124



18-5338
CONDENSER
Replaces: 12530



18-5344
CONDENSER
Replaces: 12526













18-5345
CONDENSER
Replaces: 41057, 705787



18-5347
CONDENSER



18-5403
ROTOR
Replaces: 41089, 41074

 <p>18-5404-1 ROTOR Replaces: 20223</p>	 <p>18-5405 ROTOR Replaces: 38071 Use with 18-5354 Distributor Cap Fits: New GM style "Module in Cap" distributors - V-8 application</p>	 <p>18-5406 ROTOR Use with 18-5361 Distributor Cap</p>	 <p>18-5407 ROTOR Replaces: 41059</p>
 <p>18-5408 ROTOR Use with 18-5362 Distributor Cap Fits: New GM Style "Module in Cap" Distributors V6 Applications</p>	 <p>18-5411 ROTOR Replaces: 12531,1003318</p>	 <p>18-5418 ROTOR</p>	 <p>18-5300 ROTOR Fits: Flamethrower Distributors</p>
 <p>18-5420 ROTOR Replaces: 3000122</p>	 <p>18-5427 ROTOR Replaces: 705786</p>	 <p>18-5429 ROTOR</p>	 <p>18-5301 TUNE-UP KIT Replaces: Fits: Male cap v-8 flamethrower distributors</p>
 <p>18-5302 TUNE-UP KIT Replaces: Fits: Male cap v-8 flamethrower distributors</p>	 <p>18-5352 DISTRIBUTOR CAP Replaces: 41076 Prestolite</p>	 <p>18-5353 DISTRIBUTOR CAP Replaces: 41069 Prestolite</p>	 <p>18-5354 DISTRIBUTOR CAP Replaces: 38070 Fits: New GM style "Module in Cap" Distributors—V-8 applications Use 18-5405 Rotor</p>
 <p>18-5361 DISTRIBUTOR CAP Fits: New GM style "Module in Cap" Distributors – 4 cyl. applications Use 18-5406 Rotor</p>	 <p>18-5362 DISTRIBUTOR CAP Fits: New GM Style "Module in Cap" Distributors – V6 Applications Use 18-5408 Rotor</p>	 <p>18-5369 DISTRIBUTOR CAP Includes Gasket: 18-5399 Replaces: 41052 Prestolite</p>	 <p>18-5473 DISTRIBUTOR CAP Black Distributor Cap with Male Terminals for Flamethrower Distributors</p>



18-5474
DISTRIBUTOR CAP
 Red Distributor Cap with Male Terminals for Flamethrower Distributors



18-5375
DISTRIBUTOR CAP
 Replaces: 12532, 1003317



18-5376
DISTRIBUTOR CAP
 Replaces: 20222



18-5384
DISTRIBUTOR CAP
 Replaces: 12528



18-5386
DISTRIBUTOR CAP



18-5389
DISTRIBUTOR CAP
 Replaces: 3000121

PKG. OF 2



18-5399
18-5399-9
DISTRIBUTOR CAP GASKET
 Replaces: 41061



FEATURES

- Senses current levels in the coil and adjusts the dwell to maintain peak energy throughout the entire RPM range.
- Develops, on average, 4 times more available energy between 3000 and 5000 RPM's and twice as much plug voltage as point-type systems.
- Ignition energy is sustained and coil life is increased when peak current level is reached just prior to spark.
- More stable timing.
- Use with 18-5472 "Flame Thrower II" Coil for optimum performance



18-5286
HI-PERFORMANCE ELECTRONIC CONVERSION KIT
 Fits: 6 Cylinder Delco Distributors



18-5288
HI-PERFORMANCE ELECTRONIC CONVERSION KIT
 Fits: Most Prestolite V-8 Distributors with snap down cap



18-5289
HI-PERFORMANCE ELECTRONIC CONVERSION KIT
 Fits: Most Prestolite V-8 Distributors with screw down cap



18-5290
HI-PERFORMANCE ELECTRONIC CONVERSION KIT
 Fits: Most Mallory YL or YD 8 cylinder Distributors with clockwise and counter clockwise rotation



FEATURES

- Replaces points & condensers for true solid state ignition.
- Uses standard coil, cap and rotor.
- Easy to install, one-piece, 2-wire hook-up.
- Accurate to within 1/4° timing accuracy 0 to 6000 RPM range.
- Can be used with Flame Thrower Coils 18-5466 & 18-5469.

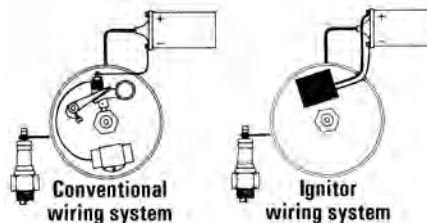

18-5294
ELECTRONIC CONVERSION KIT
Fits: 6 Cyl. Delco distributors



18-5295
ELECTRONIC CONVERSION KIT
Fits: Most 4 Cyl. Prestolite distributors (except IBM 7026)
For: Onan, Universal, Waukesha, Wisconsin



18-5296-2D
ELECTRONIC CONVERSION KIT
Fits: Most Mallory YL & YD 8 cyl. Distributors with clockwise and counter clockwise rotation



18-5298
ELECTRONIC CONVERSION KIT
With snap down cap
For: Most Prestolite V-8 Distributors



18-5299
ELECTRONIC CONVERSION KIT
With screw down cap
For: Most Prestolite V-8 Distributors
Use with 18-5403 style rotor



PREMIUM MARINE SPARK PLUG WIRE LEADS

Sierra's MAGFORCE Ignition Wires are "Electronics Friendly" protecting all of your electronic devices and electronic engine controls from RFI and EMI while delivering the maximum amount of voltage. Exact fit design ensures easy installation and years of trouble - free service.

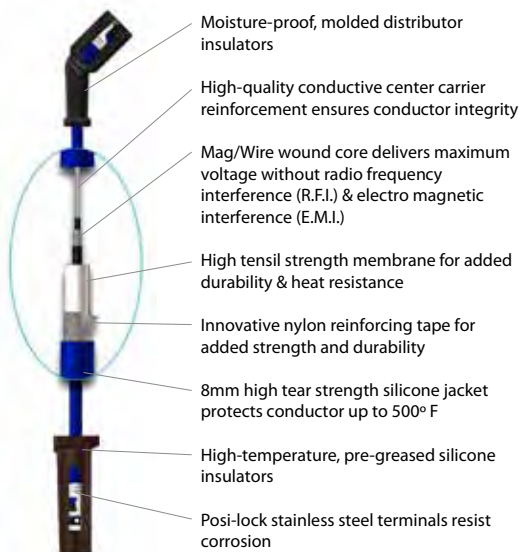

CRUSADER MARINE IGNITION WIRES APPLICATION				
Engine	Cyl.	Distributor	Years	Plug Wire Set
262 CID 4.3L	6	Prestolite	ALL	18-8801-1
262 CID 4.3L	6	Delco EST	ALL	18-8810-1
262 CID 4.3L	6	Delco HVS	ALL	18-8829-1
220 (305 CID 5.0L)	8	Mallory/Prestolite ①	Up to 1987	18-8803-2

CRUSADER MARINE IGNITION WIRES APPLICATION				
Engine	Cyl.	Distributor	Years	Plug Wire Set
220 (305 CID 5.0L)	8	Mallory/Prestolite ②	1987-1992	18-8803-2
270 (350 CID 5.7L)	8	Mallory/Prestolite ①	Up to 1987	18-8803-2
270 (350 CID 5.7L)	8	Mallory/Prestolite ②	1987-1992	18-8803-2
TB350	8	Delco EST ③	1992 & Up	18-8824-1
5.7L Classic	8	Mallory	1999 & Up	18-8803-2
5.7L MPI Classic	8	Delco HVS	2007 & Up	18-8828-1
MP5.0L Captain's Choice	8	Delco HVS	2002-2005	18-8828-1
MP5.7L Captain's Choice	8	Delco HVS	2002-2005	18-8828-1
MP6.0L	8	Distributorless	2002 & Up	18-8838-1
350 (454 CID 7.4L)	8	Mallory ④	Up to 1991	18-8803-2
454XL (454 CID 7.4L)	8	Delco EST ⑤	1991 & Up	18-8824-1
CM454HO (454 CID 7.4L)	8	Delco EST ⑥	1991 & Up	18-8824-1
454XL (454 CID 7.4L)	8	Delco EST ⑥	1993 & Up	18-8824-1
MP8.1L	8	Distributorless	ALL	18-8838-1
502 (502 CID 8.2L)	8	Prestolite ①	Up to 1991	18-8803-2
502 (502 CID 8.2L)	8	Delco EST ④	Up to 1991	18-8824-1
502XL (502 CID 8.2L)	8	Delco EST ⑤	1991 & Up	18-8824-1
TB502XL (502 CID 8.2L)	8	Delco EST ⑦	1994 & Up	18-8824-1

① Serial Number up to 68702 ② Serial Number 68703-90232 ③ Serial Number 90232 & UP
④ Serial Number up to 88710 ⑤ Serial Number 88710 & Up ⑥ Serial Number 92882 & Up
⑦ Serial Number 94268 & Up

APPLICATION BEGINS ON PAGE 597

Items ending in "D" are Display Packaged - Regular number is Non-Display



BATTERY CABLES

Gauge cable with soldered lug terminals on each end to accept 3/8" stud.

PART NO.	SIZE	COLOR	GAUGE	PART NO.	SIZE	COLOR	GAUGE
BC88523	2'	red	4	BC88563	6'	red	2
BC88533	2'	black	4	BC88573	6'	black	2
BC88543	4'	red	2	BC88583	8'	red	1
BC88553	4'	black	2	BC88593	8'	black	1



**18-5225
SPARK PLUG WIRE KIT**

Replaces: Mercury 84-99215A26, 84-813706A26
Kit includes 25 ft. Roll of 7 MM Hypalon Ignition Wire With a Metallic Core and a Large Assortment of Three Different End Fittings.



**18-5226
IGNITION WIRE**
Metallic Core
100' Spool • 7mm Hypalon

PKG. OF 10



**18-5224
18-5224-9①
SPARK PLUG WIRE
TERMINAL**
Replaces: Mercury 20121
OMC 510364

PKG. OF 10



**18-5750
18-5750-9①
UNIVERSAL SPARK
PLUG BOOTS**
Supplied complete w/Terminal Connector
Replaces:
OMC 581027, 580339



**18-5752
UNIVERSAL SPARK PLUG
BOOTS**
8mm

FEATURES

- Distributors feature the Ignitor II ignition module with adaptive dwell control adjusts the spark timing over the entire RPM range to maximize performance
- Upper roller bearing and oil impregnated bronze sintered bottom bushing are installed and aligned bored for accuracy for maximum durability
- Machined heat treated gear with tight tolerances insures durability and consistent timing to maximize horsepower and performance. Complete with high dielectric strength cap and rotor for years of performance

Standard Rotation

CCW Rotation

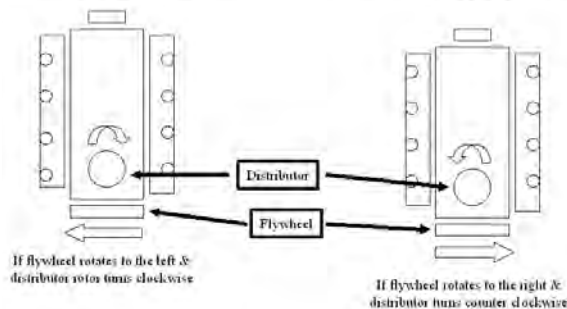

**18-5483
HI-PERFORMANCE
ELECTRONIC DISTRIBUTOR**
Fits: Chevrolet Marine Small and Big Block engines (Standard Deck Height)
Replacement cap/rotor kit **18-5266**

**18-5309-1
DISTRIBUTOR**

Replaces: Mallory YL512CV
For most Ford 302 CID V-8 Eng.
Tune-Up Kit **18-5251**

— CONTAINS —

Part #	Desc.
18-5314	Contact Set
18-5338	Condenser
18-5404-1	Rotor



**18-5313-1
DISTRIBUTOR**

Replaces:
Crusader 37061
Mallory YL624MW
For most GM V-8 Eng. small & large block Mallory Tall Cap
Tune-Up Kit **18-5251**

— CONTAINS —

Part #	Desc.
18-5314	Contact Set
18-5338	Condenser
18-5404-1	Rotor



**ELECTRONIC DISTRIBUTORS
U.L. Approved**

Part No.	Rotation	Application
18-5494-2	Conventional	Chevrolet All V8 (exc. 348,409 & Tall Deck Big Block) Includes 482, 502, 540 CID
18-5495-2	Conventional	Ford V-8, 302 CID

*Older reverse rotation engines with reverse cut camshaft gear

USES:			
Part #	Description	Part #	Description
18-5376	Distributor Cap	18-5488	Module
18-5404-1	Rotor		

① Priced per Package

**18-5484-1
ELECTRONIC
DISTRIBUTOR**

Conventional Rotation

Replaces: RA107039E

Late Model HEI

For V8 — 262-454 & 502 except 384/409 and tall block engines

- Designed as a plug-in replacement for GM-style fuel injection system distributors



—CONTAINS—

Description	Part #
Distributor Cap	18-5354
Rotor	18-5405

**18-5480
COMPLETE IGNITION
CONVERSION KIT**

Fits: GM SB & BB with Standard Deck Height

—CONTAINS—	
Part #	Description
18-5472	Coil
18-8803-2	Wire Set
18-5483	Distributor



**18-26812
HEI COIL GRAY CONNECTOR**



**18-26813
HEI COIL BLACK CONNECTOR**



**18-5108
PICKUP COIL
SENSOR**



**18-5464
IGNITION MODULE**
Fits: Sierra 18-5481, 18-5482 and 18-5483 Billet HI-PERFORMANCE ELECTRONIC DISTRIBUTORS (except HEI/EST)



**18-5107-1
IGNITION MODULE**
4/6/8 cyl.
Replaces: 7243110



**18-26810
GM HEI 4 TERMINAL
PIGTAIL**
Fits: GM HEI Distributors w/4 terminals



**18-26811
GM HEI 2 TERMINAL
PIGTAIL**
Fits: GM HEI Distributors w/2 terminals

FEATURES

- Oil filled for better cooling and long life
- Low resistance and improved turn ratios produces the higher voltage needed to run larger spark plug gaps for added power and better fuel economy
- More windings maximize energy and reliability over the full RPM range
- Fits existing brackets for easy installation

**18-5466
HI-PERFORMANCE
IGNITION COIL**

1.5 ohm (oil filled), black - 8 cylinder: Flame-Thrower 40,000 volt coil.
★ Designed for use with the original Ignitor Electronic Conversion Kits
★ Can be used with other inductive ignition systems



**18-5469
HI-PERFORMANCE
IGNITION COIL**

3.0 ohm (oil filled), black - 4 & 6 cylinder: Flame-Thrower 40,000 volt coil.
★ Designed for use with the original Ignitor Electronic Conversion Kits
★ Can be used with other inductive ignition systems



**18-5472
HI-PERFORMANCE
IGNITION COIL**

0.6 ohm (oil filled), black - 4, 6, & 8 cylinder: Flame-Thrower 45,000 volt coil.
★ Super low 0.6 ohm resistance coil designed for use with the Ignitor II Hi Performance Electronic Conversion Kits
★ Compatible with capacitive discharge systems



Part #	Description	Recommended Coil	Resistance Ohms	Part #	Description	Recommended Coil	Resistance Ohms
18-5294	Electronic Conversion Kit	18-5469	3.0	18-5286	Hi Performance Electronic Conversion Kit	18-5472	0.6
18-5295	Electronic Conversion Kit	18-5469	3.0	18-5288	Hi Performance Electronic Conversion Kit	18-5472	0.6
18-5296-2	Electronic Conversion Kit	18-5466	1.5	18-5289	Hi Performance Electronic Conversion Kit	18-5472	0.6
18-5298	Electronic Conversion Kit	18-5466	1.5	18-5290	Hi Performance Electronic Conversion Kit	18-5472	0.6
18-5299	Electronic Conversion Kit	18-5466	1.5	18-5483	Flame-Thrower Distributor	18-5472	0.6

**18-5433
IGNITION COIL**
Replaces: 37068, 51080
Uses External Resistor



**18-5435
IGNITION COIL
4.0 OHM**
Replaces: 41080
Has Internal Resistor



**18-5436
IGNITION COIL
3.0 OHM**
**Has Internal Resistor
(For Mallory Applications)**



**18-5438
IGNITION COIL**
Replaces: 37068
HEI



**18-5443
IGNITION COIL**
Replaces: 7243200
4cyl./V-8
For: 3.0L (1991 & up) 5.7 & 7.4 EFI (1995 & up)



**18-5450
COIL RESISTOR
1.5 OHM**



**18-5493
IGNITION PICKUP
COIL ASSEMBLY**
Replacement pick-up coil for Accel Electronic Distributors



IGNITION / ELECTRICAL SYSTEMS APPLICATION

Cyl.	Model Engine	Year	Distributor No.	Contact Set	Condenser	Rotor	Dist. Cap	Tune-Up Kit	Distributor	Elect. Con. Kit
4	153	1961-69	YL486C,D ④	18-5314	18-5338	18-5427	—	—	—	—
4	IH60,M60, PH45,134	1971-75	IAY4010A	18-5307	18-5345 ⑤	18-5427	—	—	—	—
6	230,292 Chevy	1961-69	YL486A,B ④	18-5314	18-5338	18-5427	—	—	—	—
6	229,3.8L	1980-82	IBM7014,A	18-5303	18-5345 ⑤	18-5403	18-5353	18-5260, 18-5276 ⑥	—	—
6	229,262	1983-88	IBM7018	18-5303	18-5345 ⑤	18-5403	18-5353	18-5260	—	—
6	229,262	1983-88	IBM7021	18-5303	18-5345 ⑤	18-5403	18-5353	18-5260, 18-5276 ⑥	—	—
8	185,230, 250, 280	1962	IBM4110	18-5303	18-5345 ⑤	18-5429	—	18-5259	—	—
8	283,327,348	1961-69	YL487A	18-5314	18-5338	18-5404-1	18-5376	18-5251, 18-5271 ⑥	18-5494-2 ① 18-5498-1 ② 18-5313-1 ③	18-5296
8	185,220,230	1961-69	ZD431A, YL431A ④	18-5314	18-5338	18-5411	18-5375	18-5256	—	—
8	170,220,225HP, 275CAD	1961-69	ZD345A,B, ZD345A,B	18-5314	18-5338	18-5404-1	18-5376	18-5251, 18-5271 ⑥	18-5494-2 ① 18-5498-1 ② 18-5313-1 ③	18-5296
8	283,327,409,427	1965-71	1111161	18-5310	18-5344	—	18-5384	18-5252, 18-5270 ⑥	18-5494-2 ① 18-5498-1 ② 18-5313-1 ③	18-5296
8	302,351	1971-75	—	18-5318	—	18-5420	18-5389	—	18-5495-2 ① 18-5309-1 ③	—
8	302	1975-78	IBM7007,A	18-5303	18-5345 ⑤	18-5407	18-5369	18-5258, 18-5277 ⑥	18-5495-2 ① 18-5309-1 ③	18-5298
8	305,350,454	1977-82	IBM7011,D	18-5303	18-5345 ⑤	18-5407	18-5369	18-5258, 18-5277 ⑥	18-5495-2 ① 18-5309-1 ③	18-5298
8	305,350,454	1977-82	IBM7013	18-5303	18-5345 ⑤	18-5403	18-5352	18-5260, 18-5275 ⑥	18-5494-2 ① 18-5498-1 ② 18-5313-1 ③	18-5299
8	305,350,454	1983-87	Mallory	18-5314	18-5338	18-5404-1	18-5376	18-5251, 18-5271 ⑥	18-5494-2 ① 18-5498-1 ② 18-5313-1 ③	18-5296
8	ALL	1987-88	IDU7801B,C B.I.D.Elec. Ign.	N/A	N/A	18-5403	18-5352	N/A	—	—

- ① Electronic Distributor (Standard Rotation)
- ② Electronic Distributor (Counter Rotation)

- ③ Contact Controlled Distributor (Standard Rotation)
- ④ Mallory Ignition Only

- ⑤ For Strap Type Condenser, use 18-5347
- ⑥ Tune-Up Kit with Distributor Cap



**18-5907
STARTER**
**(Heavy Duty) (No Core) Clockwise
Top Mount Rear Entry Starter**
Will not replace non-starter mounted solenoids.
For: Opposite Rotation GM & Ford Engines.
Replaces: 42090
Replacement Solenoid: **18-5837**
SAEJ1171

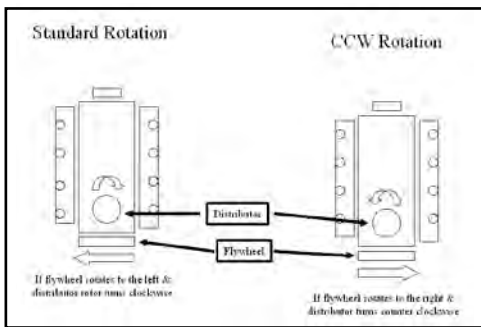

**18-5908
STARTER**
**(Heavy Duty) (No Core)
Counter-Clockwise
Top Mount Rear Entry Starter**
For: Standard Rotation GM & Ford Engines.
Replaces: 42091
Replacement Solenoid: **18-5837**
SAEJ1171



**18-6835
STARTER**
Replaces: GM Engines Universal
Used on all GM Engines with either 14 1/4" or
12 3/4" flywheels



**18-6834
STARTER**
Replaces: GM Engines Universal
Used on all GM Engines with either 14 1/4" or
12 3/4" flywheels



**18-9802
TIMING LIGHT**
Self-powered accurate
up to 10,000 RPM's



**18-15214
RELAY, SHROUDED**
Replaces: R130012
For: Fuel Pump on Crusader MEFI
systems



**18-5717
STARTER BRUSH SET**
Replaces: 42001, 707125
Delco



**18-5838
SOLENOID**
Delco







**18-5840
SOLENOID**
Prestolite 15-79,
SAW4201, SAW4207,
SAW4210









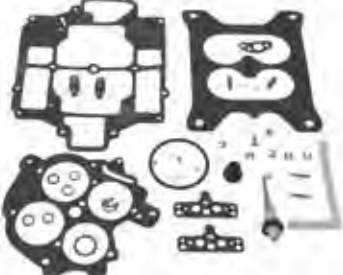

**18-2434
FLYWHEEL
BELL HOUSING**
Replaces: 96938

BRUSH SET / STARTER SWITCH APPLICATION

Year	Voltage	Original Starter No.	Brush Set	Starter Switch
1960-75	12	MDU-7015, 16	—	18-5840
1975-81	12	MEO-7044, 05	—	18-5840
1972-UP	12	96077, 96078 42031, 420036 1107710, 54, 63, 889	18-5717	18-5838
	<p>PKG. OF 8</p>  <p>FREEZE PLUGS</p> <p>18-5961 18-5961-9① 1 5/8"</p> <p>18-5962 18-5962-9① 1 3/4"</p>			
18-5710 VOLTAGE REGULATOR Prestolite VSH-6201JY		18-7600 TEMPERATURE SENSOR Replaces: 47002	18-7630 THROTTLE POSITION SENSOR Replaces: 47032	18-7632-1 IDLE AIR CONTROL MOTOR Replaces: 47033

VOLTAGE REGULATOR APPLICATION

Year	Model	Voltage	Original Alt./Gen. No.	Voltage Regulator
1966-75	Conqueror 190, 220, 250, 320	12	ALE-5204,S	18-5710
1966-75	150, 165, 185, 190, 230, 250, 280, 320	12	ALF-5201-1, A-1,S	—
		12	ALE-5202,S	—
		12	ALK-6204A	
		12	ALE-5204,S	18-5710

		
18-7607-1 CARBURETOR (REMANUFACTURED) Replaces: Rochester 17082403 For: Rochester Carb: Crusader 454	18-7019 CARB KIT	18-7022 CARB KIT
		
18-7070 CARB KIT	18-7072 CARB KIT	18-7078 CARB KIT
		
18-7086 CARB KIT	18-7095 CARB KIT Replaces: 45334	18-7725 CARB KIT

① Priced per Package

CARBURETOR KIT APPLICATION ON NEXT PAGE



18-7200
FLOAT
Replaces: 45303
(Alcohol Resistant)
Plastic



18-7201
FLOAT
(Alcohol Resistant)
Brass



18-7202
FLOAT
(Alcohol Resistant)
Brass

CARBURETOR KIT AND FLOAT APPLICATION

Cyl.	Model or Eng. Displacement	Mfg. Code	Carb. Model	Carburetor Number	Carb. Kit ①	Float
4	153" (2.5L)	R-2	2GC	7025082, 7028086	18-7070	18-7200
6	225" (3.7L)	R-2	2GC	7025181	18-7070	—
8	283" (4.6L), 327 (5.3L)	R-2	2GC	7024185	18-7070	—
8	283" (4.6L)	C-1	YH	2618, 2912	18-7725	—
8	305" (5.0L)	R-2	2GV	17057134	18-7086	18-7202
8	327" (5.3L), 409 (6.6L)	R-4	4GC	7020084, 085	18-7019	—
8	327" (5.3L), 409 (6.6L)	R-4	4GC	7023084, 085, 089	18-7078	—
8	348" (5.7L)	C-4	AFB	2955	18-7022	—
8	350" (5.7L), 454 (7.4L)	R-4	4MV	17059293, 17082403	18-7095	18-7201
8	427" (7.0L)	R-4	4MV	7027081, 7028282	18-7072	18-7201

① Does Not Include Metering Rods



18-8114
FUEL LINE HOSE
UNIVERSAL
For fuel pump to carburetor connection. Replaces copper or steel tubing 3/8" X 31" PTFE composite hose with 5/8"-18 male inverted flare straight one end, 5/8"-18 90° one end. SAE J1527 type A1



18-8115
FUEL LINE HOSE
UNIVERSAL
For fuel pump to carburetor connection. Replaces copper or steel tubing 3/8" X 25" PTFE composite hose with 5/8"-18 male inverted flare straight one end, 5/8"-18 90° one end. SAE J1527 type A1



18-7231
FLAME ARRESTOR
Replaces: 97595, 97214
V-8



18-7232
FLAME ARRESTOR
Replaces: 33628
Hi-Performance



18-7256
FUEL PUMP
Replaces: 32722
(Flange I.D. #6790, M3530)
For: GM (4 & 6 Cyl.) 153, 230, 250, 292



18-7260
FUEL PUMP
(Flange I.D. #40155)
For: GM (V-8) 283, 307, 327, 350, 409



18-7267
FUEL PUMP
(Flange I.D. #41414)
For: Ford (V-8) 302



18-7268
FUEL PUMP
(Flange I.D. #41415, M6948)
For: GM (V-8) 305, 307, 350, 400
(5.25 - 6.5 PSI)
Dual Diaphragm - Requires Sight Glass

18-7270
FUEL PUMP
 (Flange I.D. #41417, M73019)
 For: GM (V-8) 305, 350, 400
 (5.75 - 7 PSI)
Replaces: 21140
 (Gasket included)



18-7272
FUEL PUMP
 (Flange I.D. #41419, M73020)
 For: GM (V-8) 283, 305, 350, 400
 (5.75 - 6.5 PSI)
Replaces: 97039



FUEL WATER SEPARATORS



Sierra offers a complete line of 10 and 21 micron fuel water separating filters including drainable bowl filters to protect your carbureted and fuel injected engine.

Refer to pages 136-140 for a complete listing of OEM and universal applications.

Sierra fuel water separators remove over 99.8% of emulsified water from your gasoline. Sierra's 10 micron filters are over 90% efficient at removing particles as small as 10 micron. All filters flow @ 90 GPH to feed even the hungriest motor. Sierra 10 micron filters are recommended to prevent damage to sensitive inboard and outboard fuel injection systems.

Sierra #	Crusader #	Description
18-7976	23250	Fuel Filter with O-Rings
18-7852-1	22687	Fuel Water Separator Kit
18-7846	98041	Fuel Filter
18-7862	91606	Fuel Filter
18-7964-1		Fuel Filter
18-7717		Fuel Element (For: Rochester 2bbl & 4bbl Carburetors)
18-7958	47047	Fuel Element (110 Series Filter, 10 Micron)



18-3060
IMPELLER
Replaces: 1003026, 22212
 For: Ford



18-3061
IMPELLER
Replaces: 20300
 For: GM engines with V-Belt



18-8926
IMPELLER
Replaces: RP061022
Fits: Crusader 5.7 & 6.0L w/ Serpentine Belt

PKG. OF 2



18-3140
18-3140-9
WATER PUMP GASKET
Replaces: 20502
 For: Early 262, 305, 350
 (ID) 454, 502



18-3046
IMPELLER KIT
Replaces: 1003062
Contains: 18-3060 Impeller
Diameter 2 7/16" • **Side Width** 1 1/4"
 Use with Sherwood Pumps

① 18-3046D

① Priced per Package



18-3047
IMPELLER KIT
 Includes 18-3061 impeller



18-3577-2
CIRCULATING WATER PUMP
 (Bi-Directional)
Replaces: 67859, 17670, 811573, 30103
For: Big block GM engines with stamped steel timing covers



18-3599-2
CIRCULATING WATER PUMP
Replaces: 20318, 7142520
For: GM V-6 & small block V-8 engines
 Uses gasket **18-0981** (included)



18-3584
CIRCULATING WATER PUMP
 (Bi-Directional)



18-3168
SEAL & SEAT ASSEMBLY
Replaces: 20309



18-3169
SEAL & SEAT ASSEMBLY
Replaces: 40057



18-3551
THERMOSTAT
Replaces: 96319
 142°
For:

Model No.	Cubic Inch
CH190	305
CH220	305
CH270	350
CH350	454



18-3552
THERMOSTAT
Replaces: 96358
 Fresh Water Cooling Only
 160°
For:

Model No.	Cubic Inch
165	229
CH190/CH220	305
CH270	350
CH350	454



18-3671D 
THERMOSTAT KIT
Replaces: 97361
 Includes Thermostat 18-3551 and 18-0875 Gasket
 142°
FOR:

Model No.	Cubic Inch
CH190	305
CH220	305
CH270	350
CH350	454



18-3649
THERMOSTAT
Replaces: 97895
 16°
 Fresh Water Cooling
 Use with 18-2917 Gasket



18-5898
SENDER
Replaces: 700427
 1/2" — 14 NPT



18-5899
OIL PRESSURE SENDER
Replaces: 700425



18-4456D 
EXHAUST PROTECTOR VALVE
 Includes Stainless Steel Clamp
 3"



18-4457D 
EXHAUST PROTECTOR VALVE
 Includes Stainless Steel Clamp
 4"



18-4458D 
EXHAUST PROTECTOR VALVE
 Includes Stainless Steel Clamp
 5" & 6" (5" requires two 45° cuts)

① Items ending in "D" are Display Packaged - Regular number is Non-Display

Fits GM Big Block V8 454 cu. in. Models CH350 & 454XL

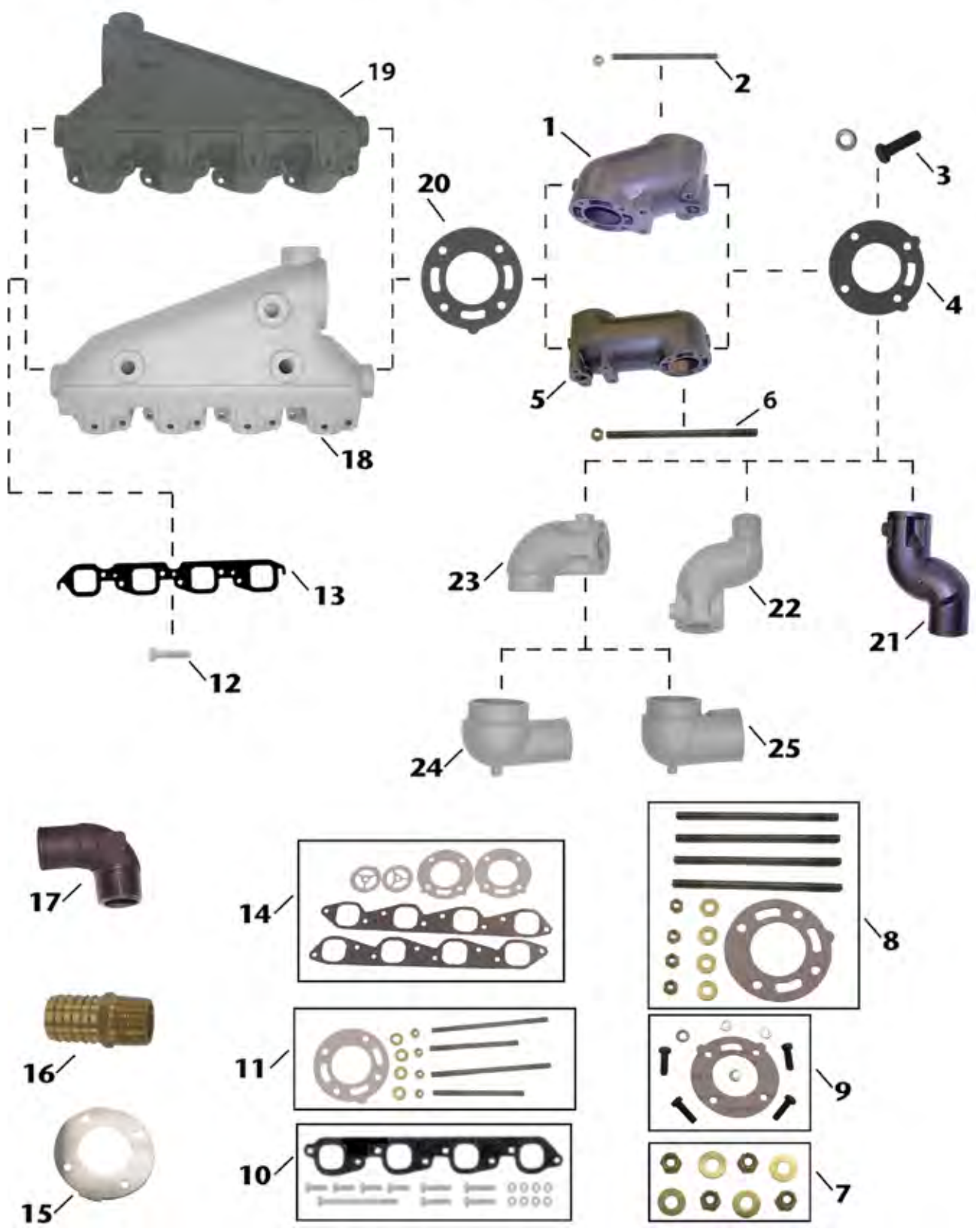

Item No.	Description	OE No.	Application
1	18-1927 4" RISER	97772	Use with Manifolds: 18-1933, & 18-1929; Elbow Gasket: 18-0309-1; Mounting Kit: 18-8523
2	NSS MOUNTING HARDWARE	N/A	Included in 18-8523 mounting kit.
3	NSS MOUNTING HARDWARE	N/A	Included in 18-8515 mounting kit.
4	18-0309-1 ELBOW GASKET	96562	Use with Exhaust Elbow: 18-1928, 18-1934, & 18-1918
5	18-1916 8" RISER	97169	Use with Manifolds: 18-1933, & 18-1929; Elbow Gasket: 18-0309-1; Mounting Kit: 18-8519
6	NSS MOUNTING HARDWARE	N/A	Included in 18-8519 mounting kit.
7	NSS WASHER & NUT KIT	N/A	Used in mounting kits: 18-8515, 18-8523, & 18-8519
8	18-8519 MOUNTING KIT	N/A	Use with Riser: 18-1916
9	18-8515 MOUNTING KIT	N/A	Use with Elbows: 18-1934, 18-1928, 18-1918
10	18-8524 MOUNTING KIT	N/A	Use with Manifolds: 18-1929 & 18-1933
11	18-8523 MOUNTING KIT	N/A	Use with Riser: 18-1927
12	NSS MOUNTING BOLT	N/A	Included in 18-8524 mounting kit.
13	18-0418 MANIFOLD GASKET	96653	Use with Manifold: 18-1929, 18-1933
14	18-0601 EXHAUST MANIFOLD GASKET SET	N/A	For: "CH" Model Big Block (V8) Chevy 454 CID (7.4L); Use with Manifolds: 18-1929, & 18-1933
15	18-1917 BLOCK OFF PLATE (STAIN-LESS)	97296	Use with Elbow/Riser Gasket: 18-0309-1, 18-0305-1
16	18-4461 HOSE FITTING	N/A	3/4" - 14NPT X 1" Hose (Corrosion Resistant Brass Fitting)
17	18-8112 HOSE FITTING	97296; 97854	90 degree fitting. Thread Size: 1" NPT X 1 1/4" Hose Barb
18	18-1929 MANIFOLD (STARBOARD)	97992, 97114	GM Big Block (V8) 454 cu.in. (Models CH350 & 454XL)(Starboard); Use with Manifold Gasket: 18-0418; Mounting Kit: 18-8524
19	18-1933 MANIFOLD (PORT)	97993, 97115	GM Big Block (V8) 454 cu.in. (Models CH350 & 454XL)(Port); Use with Manifold Gasket: 18-0418; Mounting Kit: 18-8524
20	18-0305-1 ELBOW GASKET	96108	Use with Exhaust Manifold: 18-1929, & 18-1933. Included in 18-8515 mounting kit.
21	18-1928 ELBOW W/ 4" OUTLET	97924	Use with Riser: 18-1927 or 18-1916; Elbow Gasket: 18-0309-1; Mounting Kit: 18-8515
22	18-1934 ELBOW W/ 3" OUTLET	98068	Use with Riser: 18-1927 or 18-1916; Elbow Gasket: 18-0309-1; Mounting Kit: 18-8515
23	18-1918 ELBOW W/ 2 1/2" INLET	97386	Use with Riser: 18-1927 or 18-1916; Elbow Gasket: 18-0309-1; Mounting Kit: 18-8515
24	18-1919 RE-DIRECTION ELBOW W/ 3" OUTLET	97387	Use with Elbow: 18-1918
25	18-1924 RE-DIRECTION ELBOW W/ 4" OUTLET	97624	Use with Elbow: 18-1918



**Fits GM Big Block V8 454 cu. in.
Models 454XL & 502XL**

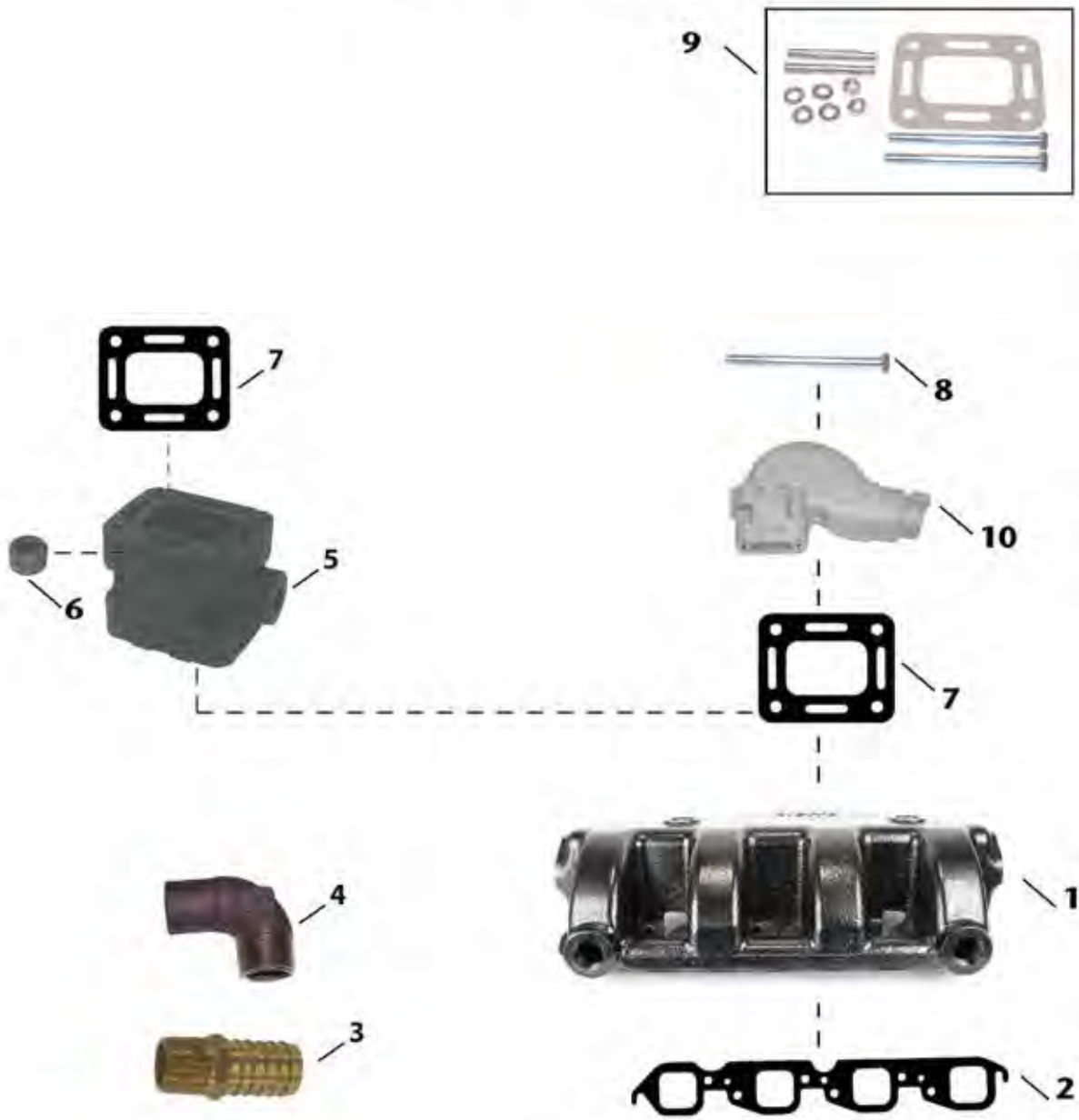

Item No.	Description	OE No.	Application	
1	18-1982	MANIFOLD	98125	GM Big Block (V8) 454-502 cu.in. (Port & Starboard); Use with Manifold Gasket: 18-0418
2	18-0418	MANIFOLD GASKET	96653	Use with Manifold: 18-1982.
3	18-4461	HOSE FITTING	N/A	3/4" - 14NPT X 1" Hose (Corrosion Resistant Brass Fitting)
4	18-8112	HOSE FITTING	97296; 97854	90 degree fitting. Thread Size: 1" NPT X 1 1/4"
5	18-1984	MANIFOLD SPACER	98128	Use with Elbow Gasket: 18-0475-1
6	18-4258	BLACKSTEEL PLUG	113186	Thread Size: 3/4" NPT X 1". Use with Spacer: 18-1984
7	18-0475-1	ELBOW GASKET (OPEN)	98127	Open gasket for universal elbow; Use with Riser: 18-1938
8	NSS	MOUNTING BOLT	N/A	Included in 18-8547 mounting kit.
9	18-8547	MOUNTING KIT	N/A	Use with Riser: 18-1938. Includes 18-0475-1 gasket.
10	18-1938	RISER	98126	Use with Manifold: 18-1982; Riser Gasket: 18-0475-1; Mounting Kit 18-8547

Fits GM Small Block V8 305-350 cu. in. Models 220 & 270

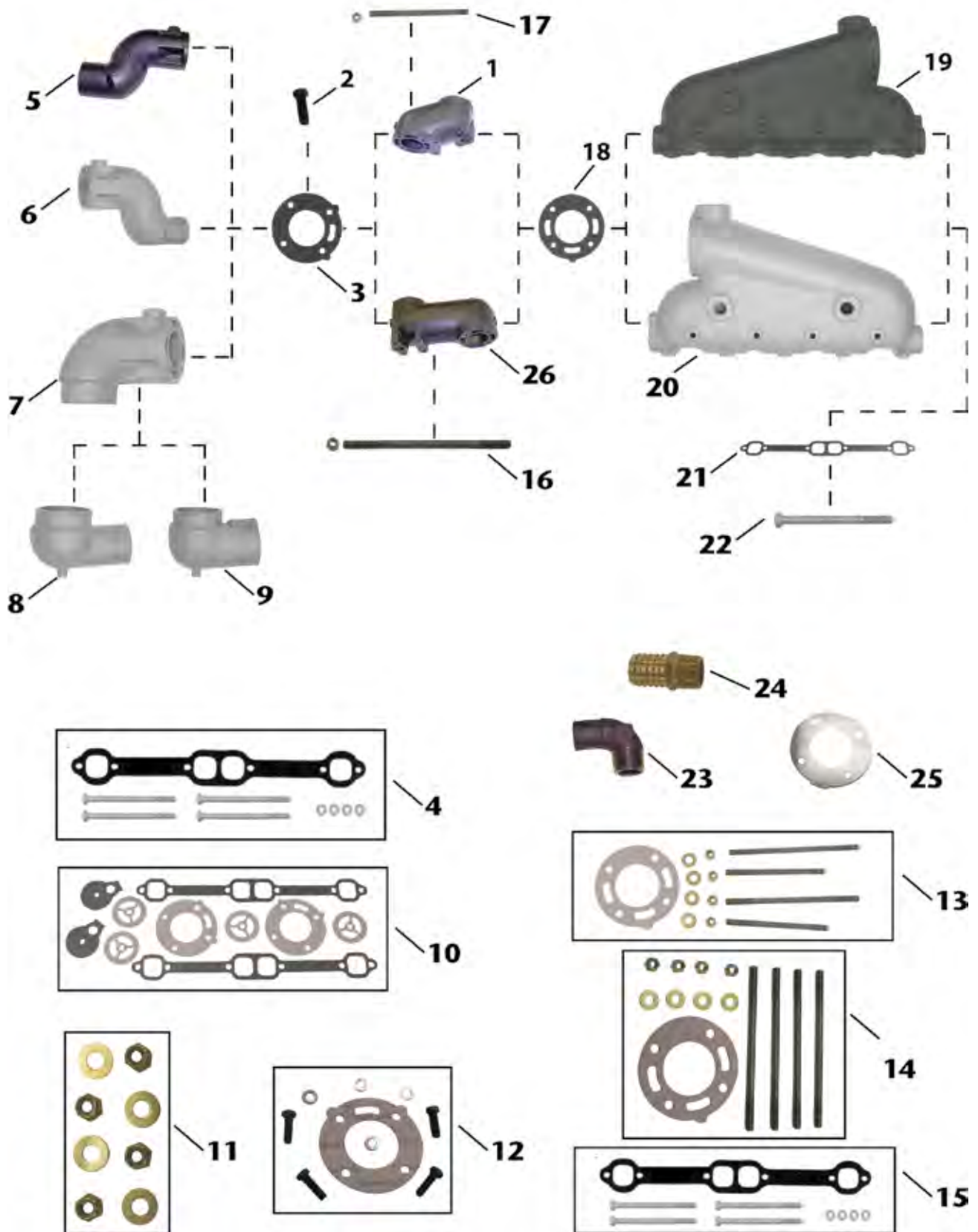

SEE NEXT PAGE FOR APPLICATION CHART

Item No.	Description	OE No.	Application	
1	18-1927	4" RISER	97772	Use with Manifold: 18-1925, 18-1926, 18-1933, & 18-1929; Elbow Gasket: 18-0309-1; Mounting Kit: 18-8523
2	NSS	MOUNTING BOLT	N/A	Included in 18-8515 mounting kit.
3	18-0309-1	ELBOW GASKET	96562	Use with Exhaust Elbow: 18-1927, or 18-1916. Included in 18-8515 mounting kit.
4	—	MOUNTING KIT	N/A	Use with Manifold: 18-1926 w/ alternator bracket
5	18-1928	ELBOW W/ 4" OUTLET	97924	Use with Manifold: 18-1925, 18-1926; Elbow Gasket: 18-0309-1; Mounting Kit: 18-8515
6	18-1934	ELBOW W/ 3" OUTLET	98068	Use with Manifold: 18-1925, 18-1926; Elbow Gasket: 18-0309-1; Mounting Kit: 18-8515
7	18-1918	ELBOW W/ 2 1/2" INLET	97386	Use with Manifold: 18-1925, 18-1926; Elbow Gasket: 18-0309-1; Mounting Kit: 18-8515
8	18-1919	RE-DIRECTION ELBOW W/ 3" OUTLET	97387	Use with Elbow: 18-1918
9	18-1924	RE-DIRECTION ELBOW W/ 4" OUTLET	97624	Use with Elbow: 18-1918
10	18-0602	EXHAUST MANIFOLD GASKET SET	N/A	For: "CH" Model Small Block (V8) Chevy 305 CID (5.0L) & 350 CID (5.7L)
11	NSS	WASHER & NUT KIT	N/A	Used in mounting kits: 18-8515, 18-8523, & 18-8519
12	18-8515	MOUNTING KIT	N/A	Use with Elbows: 18-1934, 18-1928, 18-1918
13	18-8523	MOUNTING KIT	N/A	Use with Riser: 18-1927
14	18-8519	MOUNTING KIT	N/A	Use with Riser: 18-1916
15	18-8521	MOUNTING KIT	N/A	Use with Manifold: 18-1925 & 18-1926
16	NSS	MOUNTING STUD	N/A	Included in 18-8519 mounting kit
17	NSS	MOUNTING STUD	N/A	Included in 18-8523 mounting kit
18	18-0305-1	ELBOW GASKET	96108	Use with Exhaust Manifolds: 18-1925 & 18-1926
19	18-1926	MANIFOLD (PORT)	97753, 96121	GM Small Block (V8) 305-351 cu.in. (Models: 220 & 270) (Port); Use with Manifold Gasket: 18-2949; Mounting Kit: 18-8521 (if manifold has alternator bracket)
20	18-1925	MANIFOLD (STARBOARD)	97752, 96120	GM Small Block (V8) 305-351 cu.in. (Models: 220 & 270) (Starboard); Use with Manifold Gasket: 18-2949; Mounting Kit: 18-8521
21	18-2949	MANIFOLD GASKET	96306	Use with Manifolds: 18-1925 & 18-1926
22	NSS	MOUNTING BOLT	N/A	Included in 18-8521 mounting kits
23	18-8112	HOSE FITTING	97296; 97854	90 degree fitting. Thread Size: 1" NPT X 1 1/4"
24	18-4461	HOSE FITTING	N/A	3/4" - 14NPT X 1" Hose (Corrosion Resistant Brass Fitting)
25	18-1917	BLOCK OFF PLATE (STAINLESS)	97296	Use with Elbow/Riser Gaskets: 18-0309-1, 18-0305-1
26	18-1916	8" RISER	97169	Use with Manifolds: 18-1925, 18-1926; Elbow Gasket: 18-0309-1;



SIERRA MANIFOLDS ARE PAINTED, PACKAGED & LEAK TESTED

18-1997-1
MANIFOLD
Port & Starboard
Replaces: Barr CHV-1-83
Universal Center Riser Manifold



FITS:
283 and 327 CID engines thru 1964; 305, 307
and 350 CID engines 1965 and later
Use with:
Exhaust Manifold Gasket Set: 18-0604
***For Exploded View - See Pages 638-639**

18-1998-1
MANIFOLD
Port & Starboard
Replaces: Barr FM-1-83
Universal Center Riser Manifold



FITS:
302 and 351 CID engines
Comes with 18-4363 Mounting Package
Use with:
Exhaust Manifold Gasket Set: 18-0603
***For Exploded View - See Pages 640-641**

18-1999
ELBOW
Replaces: Barr 20-0082



Comes with 18-4364 open
If blocked mounting kit is required use 18-8535
Use with:
Manifold: 18-1997-1 or 18-1998-1 or 18-1898
Riser Gasket: 18-2854-1 open

18-1982
MANIFOLD
Port & Starboard
Replaces: Crusader 98125



Use:
Exhaust Manifold Gasket: 18-0418
For: GM Big Block V-8 454-502 ci

18-1929
MANIFOLD
Starboard
Replaces: Crusader 97992, 97114
Crusader GM Big Block V8 454cu.in.
(Models: CH350 and 454XL)



Use with:
Exhaust Manifold Gasket: 18-0418
Mounting Kit: 18-8524

18-1933
MANIFOLD
Port
Replaces: Crusader 97993, 97115
Crusader GM Big Block V8 454cu.in.
(Models: CH350 and 454XL)



Use with:
Exhaust Manifold Gasket: 18-0418
Mounting Kit: 18-8524

18-1925
MANIFOLD
Starboard
Replaces: Crusader 97752, 96120
Crusader GM Small Block V8 305-350cu.in.
(Models: 220 and 270)



Use with:
Exhaust Manifold Gasket: 18-2949
Mounting Kit: 18-8521

18-1926
MANIFOLD
Port
Replaces: Crusader 97753, 96121
Crusader GM Small Block V8 305-350-cu.in.
(Models: 220 and 270)



Use with:
Exhaust Manifold Gasket: 18-2949
Mounting Kit: 18-8521 (if manifold has alternator bracket)

18-1898
MANIFOLD
Port & Starboard
Replaces: Barr CHVA-1-84
Marine Power 0991-110
Fits: 454 cu.in. GM big block V8 engines



Use with:
Exhaust Manifold Gasket: 18-0418
Riser Gasket: 18-2854-1 open or 18-0476-1 blocked

***For Exploded View - See Pages 636-637**



18-1991
ELBOW ADAPTER
 Replaces: Barr 200089P
 For: 3" I.D. Exhaust Hose
 Use with:
 Manifold Riser: 18-1999
 30°



18-1992-1
ELBOW ADAPTER
 Replaces: Barr 200087P
 For: 3" I.D. Exhaust Hose
 (As used in 18-1987 Exhaust Manifold Conversion Kit)
 80°



18-1919
RE-DIRECTION ELBOW W/ 3" OUTLET
 Replaces: Crusader 97387
 Crusader GM Small Block V8 305-350-cu.in.
 (Models: 220 and 270), GM Big Block V8 454cu.in.
 (Models: CH350 and 454XL)
 Use with:
 Elbow: 18-1918



18-1924
RE-DIRECTION ELBOW W/ 4" OUTLET
 Replaces: Crusader 97624
 Crusader GM Small Block V8 305-350-cu.in.
 (Models: 220 and 270), GM Big Block V8 454cu.in.
 (Models: CH350 and 454XL)
 Use with:
 Elbow: 18-1918



18-1928
ELBOW W/ 4" OUTLET
 Replaces: Crusader 97924
 Crusader GM Small Block V8 305-350cu.in. (Models: 220 and 270), GM Big Block V8 454cu.in.(Models: CH350 and 454XL)
 4" Hose
 Use with:
 Manifold: 18-1925, 18-1926, 18-1933, 18-1929
 Elbow Gasket: 18-0309-1
 Mounting Kit: 18-8515



18-1934
ELBOW W/ 3" OUTLET
 Replaces: Crusader 98068
 Crusader GM Small Block V8 305-350cu.in.(Models 220 and 270), GM Big Block V8 454cu.in.(Models: CH350 and 454XL)
 3" Hose
 Use with:
 Manifold: 18-1925, 18-1926, 18-1933, 18-1929
 Elbow Gasket: 18-0309-1
 Mounting Kit: 18-8515



18-1918
ELBOW
 Replaces: Crusader 97386
 Crusader GM Small Block V8 305-350-cu.in.
 (Models: 220 and 270), GM Big Block V8 454cu.in.
 (Models: CH350 and 454XL)
 2 1/2" Inlet
 Use with:
 Manifold: 18-1925, 18-1926, 18-1933, 18-1929
 Elbow Gasket: 18-0309-1
 Mounting Kit: 18-8515
 Re-direction Elbow: 18-1919, 18-1924



18-1916
8" RISER
 Replaces: Crusader 97169
 Crusader Small Block V8 305-350-cu.in.
 (Models: 220 and 270), GM Big Block V8 454cu.in.
 (Models: CH350 and 454XL).
 Use with:
 Manifold: 18-1925, 18-1926, 18-1933, 18-1929
 Riser Gasket: 18-0305-1
 Mounting Kit: 18-8519



18-1927
4" RISER
 Replaces: Crusader 97772
 Crusader Small Block V8 305-350-cu.in.
 (Models: 220 and 270), GM Big Block V8 454cu.in.
 (Models: CH350 and 454XL).
 Use with:
 Manifold: 18-1925, 18-1926, 18-1933, 18-1929
 Riser Gasket: 18-0305-1
 Mounting Kit: 18-8523



18-1938
RISER
 Replaces: Crusader 98126, RO29015
 Crusader GM Small Block V8 305-350cu.in.(Models: CM305, CM350XL and CM350HT), GM Big Block V8 454cu.in.(Models: 454XL and 502XL)
 Use with:
 Manifold: 18-1982, Crusader 98243
 Riser Gasket: 18-0475-1
 Mounting Kit: 18-8547



18-1907
RISER (3")

Replaces: Barr 20-0102
Barr and Indmar Ford Small Block V8 302-351cu.in.
Indmar 53-2009 and 53-2018

Use with:
Manifold: 18-1997-1, 18-1998-1
Riser Gasket: 18-2854-1 open or 18-0476-1 blocked
Mounting Kit: 18-4364 open or 18-8535 blocked



18-1939
RISER (3 1/2")

Replaces: Barr 20-0100, Marine Power 0992-593
Barr, Indmar and Marine Power Ford Small Block
V8 302-351cu.in., GM Small Block V8 305-350cu.in.,
GM Big Block V8 454cu.in.

Use with:
Manifold: 18-1997-1, 18-1998-1, 18-1898
Riser Gasket: 18-2854-1 open or 18-0476-1 blocked
Mounting Kit: 18-4364 open or 18-8535 blocked



18-8112
HOSE FITTING (90°)

Replaces: Crusader 97854
GM Small Block V8 305-350cu.in. (Models: 220,
270, CM305, CM350XL, CM350HT), GM Big Block
V8 454 cu.in. (Models: 454XL, 502XL, CH350, 454XL)
Thread size: 1" NPT x 1 1/4" hose barb

Use with:
Manifold: 18-1997-1, 18-1998-1, 18-1982, Crusader 98243,
18-1929, 18-1933, 18-1925, 18-1926, 18-1898



18-1949
MANIFOLD SPACER (3")

Barr CM 20-0097
Barr, Indmar and Marine Power Ford Small Block
V8 302-351cu.in., GM Small Block V8 305-350cu.in.,
GM Big Block V8 454cu.in.

Used with:
Manifolds: 18-1998-1, 18-1997-1 and 18-1898



18-1984
MANIFOLD SPACER

Replaces: 98128
For: GM Small Block V8 305-350 cu.in., GM Big Block V8



18-4363
EXHAUST ELBOW MOUNTING KIT

Replaces: Barr FM-1-83-P
Use with:
Manifold: 18-1998-1



18-4364 (Open)
EXHAUST ELBOW MOUNTING KIT

Replaces: Barr 20-0082-P
Use with:
Risers: 18-1999, 18-1907, 18-1939



18-8515
EXHAUST MANIFOLD MOUNTING KIT

Crusader GM Small Block V8 305-350cu.in. (Models: 220, 270), GM Big Block
V8 454cu.in. (Models: CH350, 454XL)
Used with:
Elbows: 18-1934, 18-1928, 18-1918



18-8519
EXHAUST MOUNTING KIT

Crusader GM Small Block V8 305 350cu.
in. (Models: 220, 270), GM Big Block V8
454cu.in.
(Models: CH350, 454XL)
Used with:
Riser: 18-1916



18-8521
EXHAUST MANIFOLD MOUNTING KIT

Crusader GM Small Block V8 305-350cu.in. (Models: 220, 270)
Used with:
Manifold: 18-1925 & 18-1926



18-8523
EXHAUST ELBOW MOUNTING KIT
 Crusader GM Small Block V8 305-350cu.in. (Models: 220, 270), GM Big Block V8 454cu.in. (Models: CH350, 454XL)
 Used with:
 Riser: 18-1927



18-8524
EXHAUST MANIFOLD MOUNTING KIT
 Crusader GM Big Block V8 454cu.in. (Models: CH350 and 454XL)
 Used with:
 Manifolds: 18-1929 and 18-1933



18-8535
(CLOSED)
EXHAUST ELBOW MOUNTING KIT
 Barr, Indmar and Marine Power Ford Small Block V8 302-351cu.in., GM Small Block V8 305-350cu.in., GM Big Block V8 454cu.in.
 Used with:
 Risers: 18-1939, 18-1999, and 18-1907 Blocked



18-8536
EXHAUST ELBOW MOUNTING KIT
 Barr, Indmar and Marine Power GM Small Block V8 305-350cu.in.
 Used with:
 Manifold: 18-1997-1



18-8538
EXHAUST MANIFOLD MOUNTING KIT
 Barr and Indmar Ford Small Block V8 302-351cu.in.
 Used with:
 Manifold: 18-1998-1



18-8547
EXHAUST ELBOW MOUNTING KIT
 For: GM SB V8 305-350cu.in. GM BB V8 454 cu. in.
 Used with:
 Riser: 18-1938



PIPE PLUGS

Part #	Thread Size	Part #	Thread Size
18-4256	1/4"	18-4263	1/8" - 27 NPT
18-4257	1/4"	18-4264	3/8" - 18 NPT
18-4258	3/4"		

56507 Pipe Sealant with Teflon® is recommended for use on plug threads.



18-4461
HOSE BARB
 3/4" - 14 NPT x 1" Hose
 Corrosion Resistant Brass Fitting

① **18-4218D**



18-4218
DRAIN TAP
 Used with:
 Most O.E.M. Manifolds
18-3223-9 Bulk Pack of 12
 1/4" Brass

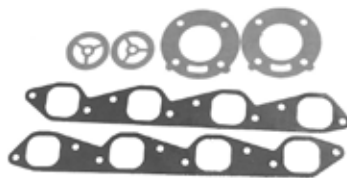

18-0601
EXHAUST MANIFOLD GASKET SET
 For: "CH" Model Big Block V-8 Chevy 454 CID (7.4L)
 Use with:
 Manifolds: 18-1929, 18-1933

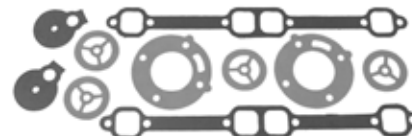

18-0602
EXHAUST MANIFOLD GASKET SET
 For: "CH" Model Small Block V-8 Chevy 305 CID (5.0L) & 350 CID (5.7L)

① Items ending in "D" are Display Packaged - Regular number is Non-Display



18-0603
EXHAUST MANIFOLD GASKET SET
 For: Ford 302/351 CID Engines
 Use with:
 Manifold: 18-1998-1



18-0604
EXHAUST MANIFOLD GASKET SET
 For: GM 305/350 CID Engines
 Use with:
 Manifold: 18-1997-1



18-0183-1
EXHAUST MANIFOLD GASKET
 Used with:
 Manifold: 18-1998-1



18-0305-1
EXHAUST ELBOW GASKET
 Replaces: 96108
 Use with:
 Exhaust Manifold: 18-1929



18-0309-1
EXHAUST ELBOW GASKET
 Replaces: 96562
 Use with:
 Exhaust Elbow: 18-1928
 V-6/V-8



18-0418
EXHAUST MANIFOLD GASKET
 Replaces: 96653
 Used with:
 Manifold: 18-1957-2, 18-1982,
 18-1929, 18-1933, 18-1898



18-0475-1
EXHAUST ELBOW GASKET
 Used with:
 Riser: 18-1938
 Manifold: Crusader 98243



18-0476-1
BLOCK OFF GASKET
 Barr, Indmar & MarinePower
 Ford Small Block V8 302-351cu.in.
 Used with:
 Risers: 18-1939, 18-1999 and 18-1907
 Blocked



18-1917
MANIFOLD BLOCK OFF PLATE (STAINLESS)
 Replaces: 97296
 Crusader Small Block V8 305-350 cu.in. (Models: 220 and 270), GM Big Block V8 454cu.in. (Models: CH350 and 454XL)
 Used with:
 Elbow/Riser Gasket: 18-0309-1, 18-0305-1

PKG. OF 2



18-2854-1 (Open)
18-2854-9①
EXHAUST RISER GASKET
 Replaces: Barr 01-0107
 Used with:
 Riser: 18-1999, 18-1907, 18-1939

PKG. OF 2



18-2909
18-2909-9①
EXHAUST MANIFOLD GASKET
 Replaces: 97498
 For: GM V-6
 Used with:
 Manifold: 18-1952-1, 18-1932

PKG. OF 2



18-2949
18-2949-9①
EXHAUST MANIFOLD GASKET
 Replaces: 96306
 Barr CHV-47-000
 Use with:
 18-1997-1

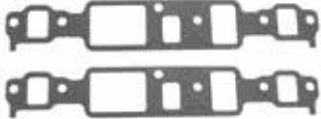

18-4408
INTAKE MANIFOLD GASKET SET
 Replaces: 33393
 For: 222 CID



18-0306-1
ELBOW AND CUP GASKET
 Replaces: 96216
 V-6/V-8



OIL FILTERS

Part #	Replaces:	
18-7824-2 (Short)	201104	GM Engines + SS330 Remote Mount
18-7875 (Long)	9002514	Ford Engines
18-7876-1 (Long)	201104	GM Engines + SS330 Remote Mount
18-7878-1 (Short)	—	220, 300, 320, 325 Remote Mount

SEE PAGES 182-184 & 1147-1170 FOR ADDITIONAL INFORMATION



18-0311
262 CID
VALVE COVER GASKET
Replaces: 97686



PKG. OF 2
18-0875
18-0875-9①
THERMOSTAT GASKET



PKG. OF 2
18-0976
18-0976-9①
TIMING CHAIN COVER GASKET
Replaces: 20129



18-2845
VALVE COVER GASKET
Replaces: 91351
V-8



18-3874
HEAD GASKET
Replaces: 31137
For: (8.2L) 502 CID/7.4L



18-3876
HEAD GASKET
Replaces: 7057500
For: GM 305 (5.0L)/350 (5.7L) CID Eng.



18-3877
HEAD GASKET
Replaces: 30266
For: GM 454 (7.4L) CID Eng.

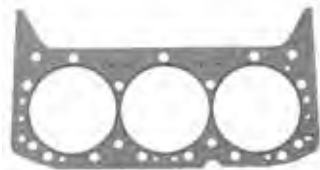

18-3879
HEAD GASKET
Replaces: 33408



18-3887
HEAD GASKET
Replaces: 31136
For: (7.4L) 454 CID GEN V



18-5303
CONTACT SET
Replaces: 751007



18-5345
CONDENSER
Replaces: 755017



18-5407
ROTOR

PARTS FOR CONTACT CONTROLLED DISTRIBUTORS

Year	Cyl.	Model / Engine	Distributor	Contact Set	Condenser	Rotor
1979	8	All	IBM-7010	—	18-5345	18-5407
			IBM-7011	18-5303	18-5345	18-5407



18-5268
TUNE-UP KIT



18-5271
TUNE-UP KIT



18-5275
TUNE-UP KIT



18-5276
TUNE-UP KIT



18-5277
TUNE-UP KIT
Replaces: 755021



18-5278
TUNE-UP KIT



18-5279
TUNE-UP KIT



18-5280
TUNE-UP KIT



18-5281
TUNE-UP KIT



18-5283
TUNE-UP KIT

PARTS FOR IGNITION - TUNE-UP KITS

Cyl.	Ignition System	Tune-Up Kit	Cyl.	Ignition System	Tune-Up Kit
In-Line 4	Delco Single Point	18-5268	In-Line 4	Delco EST	18-5280
V-8	Mallory Single Point	18-5271	V-6	Delco EST	18-5278
V-8	Prestolite Single Point - Screw Down Cap	18-5275	V-8	Delco EST	18-5281
V-6	Prestolite Single Point - Screw Down Cap	18-5276	In-Line 4	Mallory Single Point	18-5283
V-8	Prestolite Single Point - Clip Down Cap	18-5277	V-8	Prestolite Electronic	18-5279

PREMIUM MARINE IGNITION WIRES

Sierra's MAGFORCE Ignition Wires are "Electronics Friendly" protecting all of your electronic devices and electronic engine controls from RFI and EMI while delivering the maximum amount of voltage. Exact fit design ensures easy installation and years of trouble - free service.

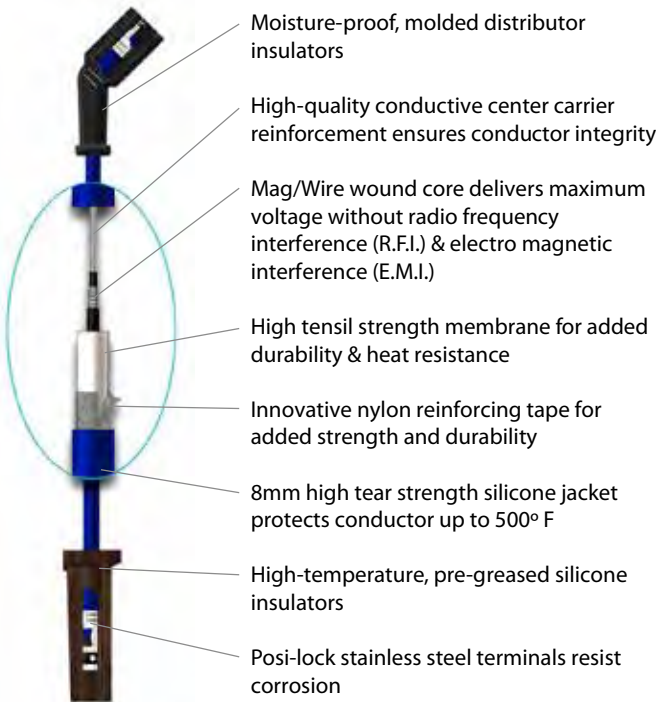

INDMAR MARINE IGNITION WIRES APPLICATION

Engine	Cyl.	Distributor	Year Start	Year Stop	Plug Wire Set
140	8	Prestolite	Up to	1993	18-8803-2
200	8	Prestolite	Up to	1993	18-8803-2
225	8	Prestolite	Up to	1993	18-8803-2
250	8	Prestolite	Up to	1993	18-8803-2
275	8	Prestolite/Mallory	Up to	1993	18-8803-2
300	8	Prestolite/Mallory	Up to	1993	18-8803-2
350	8	Prestolite/Mallory	Up to	1993	18-8803-2
400	8	Prestolite/Mallory	Up to	1993	18-8803-2
5.7L EFI	8	Delco EST	1994	2009	18-8836-1
5.7L EFI	8	Delco HVS	2007	& Up	18-8828-1
6.0L EFI	8	Distributorless	2003	& Up	18-8838-1
6.2L EFI	8	Distributorless	2010	& Up	18-8838-1
454 Carbureted (7.4L)	8	Delco EST	1994	2011	18-8824-1
8.1L Vortec	8	Distributorless	2003	2011	18-8838-1
502 Carbureted (8.2L)	8	Delco EST	1994	2011	18-8824-1





18-5493
IGNITION PICKUP
COIL ASSEMBLY
 Replacement pick-up coil for Accel Electronic Distributors



18-5433
IGNITION COIL
 Has external resistor



18-5450
COIL RESISTOR
 1.5 OHM

COIL AND RESISTOR

Year	Model or Engine	Service Coil	Resistor
1979	12 Volt w/ 2-Prong Resistor	18-5433	18-5450

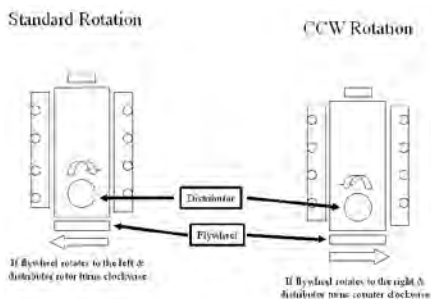

18-5603
STARTER
 Replaces: 573001
 Noseless: CCW Top mount rear entry starter for standard rotation GM & Ford engines. Can be used in place of 18-5908



18-6835
STARTER
 Replaces: GM Engines Universal
 Used on all GM Engines with either 14 1/4" or 12 3/4" flywheels



18-5984
ALTERNATOR
 Replaces: 575011
 7SI/70 amp, Spool Mount, Serpentine Pulley



18-6288
ALTERNATOR
 Replaces: 575010
 7SI/70 amp, Spool Mount, Single Groove V-Belt Pulley



18-6451
ALTERNATOR
 Replaces: 575014
 11SI/95 amp Spool Mount, serpentine pulley
 Fits: GM LS Engines



18-32150
OXYGEN SENSOR
 Replaces:
 Indmar / Pleasurecraft / Mastercraft
 Fits: GM New Generation Ls Series Small Block



18-32151
OXYGEN SENSOR
 Replaces:
 Indmar / Malibu / Ilmor
 Fits: GM New Generation Ls Series Small Block



18-32152
OXYGEN SENSOR
 Replaces:
 Indmar / Malibu / Ilmor S556162
 4-Wire; Used on ETXCAT Exhaust Manifolds for both pre and post catalyst locations (Except Ford 6.2L engines, sensor is used post catalyst only)

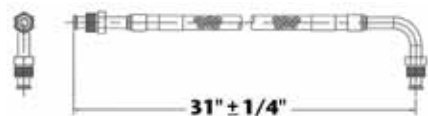

18-8114
FUEL LINE HOSE
UNIVERSAL
 For fuel pump to carburetor connection. Replaces copper or steel tubing 3/8" X 31" PTFE composite hose with 5/8"-18 male inverted flare straight one end, 5/8"-18 90° one end. SAE J1527 type A1



18-8115
FUEL LINE HOSE
UNIVERSAL
 For fuel pump to carburetor connection. Replaces copper or steel tubing 3/8" X 25" PTFE composite hose with 5/8"-18 male inverted flare straight one end, 5/8"-18 90° one end. SAE J1527 type A1













FUEL WATER SEPARATORS

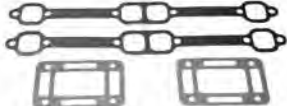

Sierra offers a complete line of 10 and 21 micron fuel water separating filters including drainable bowl filters to protect your carbureted and fuel injected engine.

Refer to pages 136-140 for a complete listing of OEM and universal applications.

Sierra fuel water separators remove over 99.8% of emulsified water from your gasoline. Sierra's 10 micron filters are over 90% efficient at removing particles as small as 10 micron. All filters flow @ 90 GPH to feed even the hungriest motor. Sierra 10 micron filters are recommended to prevent damage to sensitive inboard and outboard fuel injection systems.

 <p>18-8215 HOSE BARB Fits: Chrysler V8</p>	 <p>18-3304 IMPELLER Replaces: Johnson Pump 09-802-B Dia: 3 3/4" Side Width 3 1/2" Neoprene</p>	 <p>18-3586-1 WATER PUMP Replaces: Indmar 685011 Use Impeller Repair Kit: 18-3081</p>	 <p>18-3587-1 WATER PUMP Replaces: Indmar 685001 Use Impeller Repair Kit: 18-3089</p>
 <p>18-42608 WATER CIRCULATING PUMP Replaces: Indmar S556050 Fits: Indmar/PCM 6.0L</p>	 <p>18-43017 THERMOSTAT Replaces: Indmar S985009 Fits: Mercruiser 496 Mag & HO, 8.1L MIE & HO</p>	 <p>18-0603 EXHAUST MANIFOLD GASKET SET</p>	 <p>18-0604 EXHAUST MANIFOLD GASKET SET</p>
<p>PKG. OF 2</p>  <p>18-0665 18-0665-9^① THERMOSTAT GASKET Replaces: 98-5006</p>	 <p>18-0476-1 RISER BLOCKOFF GASKET Replaces: Barr 1-0105</p>	<p>new</p>  <p>18-8623 OIL FILTER Replaces: Indmar 501022S Fits: 6.2L Ford Engines 2016 and Newer</p>	<p>new</p>  <p>18-8779 OIL FILTER Replaces: Indmar 872025 Fits: 6.2L Ford Engines 2015-2016</p>

MISCELLANEOUS GASKETS

Model or Engine	Gasket Set	Type	O.E. #	Gasket
Ford 302/350 CID Engines	18-0603	Thermostat	98-5006	18-0665
GM 305/350 CID Engines	18-0604	Block Off (For: Small block GM & Ford V-8 (Use with 18-1999 Manifold)	Barr 1-0105	18-0476-1

① Priced per Package

PREMIUM MARINE IGNITION WIRES

Sierra's MAGFORCE Ignition Wires are "Electronics Friendly" protecting all of your electronic devices and electronic engine controls from RFI and EMI while delivering the maximum amount of voltage. Exact fit design ensures easy installation and years of trouble - free service.

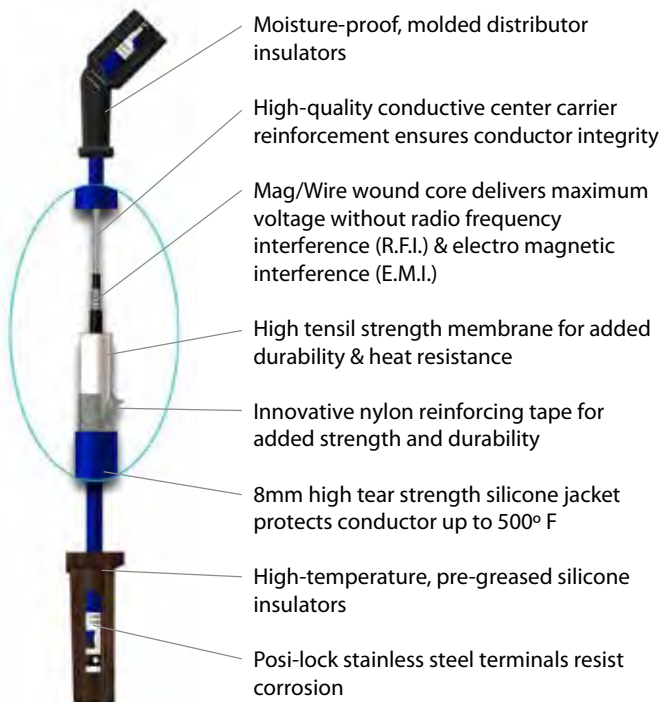

MARINE POWER IGNITION WIRES APPLICATION

Engine	Cyl.	Distributor	Year Start	Year Stop	Plug Wire Set
181	4	Delco	1986	1992	18-8800-1
262	6	Prestolite ②	1986	1992	18-8801-1
350	8	Prestolite ②	1986	1992	18-8802-1
350	8	Mallory	1986	1992	18-8802-1
3.0L	4	Delco EST	1993	& Up	18-8833-1
4.3L	6	Delco EST	1993	& Up	18-8835-1
5.0L	8	Delco EST	1993	2005	18-8822-1
5.0L	8	Delco HVS	2005	& Up	18-8828-1
5.7L	8	Delco EST	1993	2005	18-8822-1
5.7L	8	Delco HVS	2005	& Up	18-8829-1
7.4L	8	Delco EST	1993	2000	18-8832-1
8.2L	8	Delco EST	1993	2000	18-8832-1

② Screw down cap



Standard Rotation

CCW Rotation

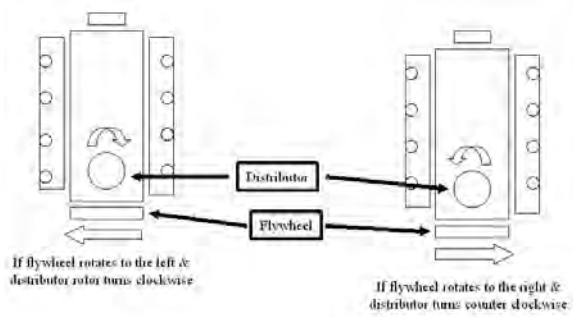

**18-5603
STARTER**

Replaces: 0170-000
Noseless:CCW Top mount rear entry starter for standard rotation GM & Ford engines. Can be used in place of 18-5908



**18-6299
ALTERNATOR**

Replaces: 402001
75I/70 amp, Spool Mount, Larger 2 Groove Pulley



**18-37824
INLINE FUEL FILTER**

Replaces: Indmar S556003
Fits: Gasoline Engines with pump boost, In-line filter



**18-31104
FLAME ARRESTOR**

Replaces: Indmar S525009
Fits: 262 Mag EFI, 4.3L EFI, 5.0L EFI, 5.7L LX EFI, 350 Mag Alpha EFI & Ski Rochester Throttle Body Injection



**18-0476-1
RISER BLOCK-OFF
GASKET**

Replaces: Barr 1-0105

PKG. OF 2



**18-2909
18-2909-9^①
EXHAUST MANIFOLD
GASKET**

For: GM V-6



**18-8535
EXHAUST ELBOW MOUNTING KIT**



**18-8536
EXHAUST ELBOW MOUNTING KIT**



**18-4364 (Open)
EXHAUST ELBOW MOUNTING KIT**

Replaces: Barr 20-0082-P
Use with:
Risers: 18-1999, 18-1907, 18-1939

EXHAUST MANIFOLD HARDWARE MOUNTING KITS

EXHAUST ELBOW HARDWARE MOUNTING KITS

Exhaust Manifold	Elbow O.E. No.	Gasket Set	Exhaust Elbow	Elbow O.E. No.	Closed Cooling Kit	Raw Water Cooling Kit
18-1997-1	Barr CHV-1-83 Indmar 53-1027 Marine Power 0994-000	18-8536	18-1999	Barr 20-0082	18-8535	18-4364
			18-1939	Barr 20-0100	18-8535	18-4364

① Priced per Package

PLEASURECRAFT MODEL IDENTIFICATION

MODEL 0 2 - 6 0 0 V - 0 1 SERIAL 460000

1st - 2nd Space: **MANUFACTURING CODE**

3rd - 5th Space: **ENGINE CODE**

810 = 8.1L	(496 CID MPI)	(GM)
811 = 8.1L	(496 CID H.O. MPI)	(GM)
600 = 6.0L	(364 CID MPI)	(GM)
570 = 5.7L	(350 CID LH MPI)	(GM)
571 = 5.7L	(350 CID RH MPI)	(GM)
572 = 5.7L	(350 CID LH Carburetor)	(GM)
573 = 5.7L	(350 CID RH Carburetor)	(GM)
500 = 5.0L	(305 CID LH MPI)	(GM)
501 = 5.0L	(305 CID RH MPI)	(GM)
502 = 5.0L	(305 CID LH Carburetor)	(GM)
503 = 5.0L	(305 CID RH Carburetor)	(GM)

SERIAL NUMBER I.D.

1st DIGIT INDICATES DECADE ENGINE WAS MANUFACTURED (3 = 1990, 4 = 2000, 5 = 2010)
2nd DIGIT INDICATES YEAR ENGINE WAS MANUFACTURED.

6th Space: **DRIVE CONFIGURATION**

blank - Direct Drive
V - V-Drive

7th - 8th Space: **SPECIFICATION CODE**



①18-5251D Display Package

18-5251 TUNE-UP KIT

Part #	-CONTAINS- O.E. #	Description
18-5314	R114001, R114004	Contact Set
18-5338	R115001	Condenser
18-5404	R103001	Rotor
	Mallory 8 cyl. Tall Cap	



Display Package

18-5255 TUNE-UP KIT

Part #	-CONTAINS- O.E. #	Description
18-5303	R114002	Contact Set
18-5345	R115002	Condenser
18-5407	R103003	Rotor



①18-5260D Display Package

18-5260 TUNE-UP KIT

Part #	-CONTAINS- O.E. #	Description
18-5303	R114002	Contact Set
18-5345	R115002	Condenser
18-5403	R103004	Rotor



18-5266 TUNE-UP KIT

Fits: Flame Thrower Distributors 18-5481, 18-5482, 18-5483, 18-5477, 18-5478, 18-5479



Display Package

18-5271 TUNE-UP KIT

Part #	-CONTAINS- O.E. #	Description
18-5314	R114001, R114004	Contact Set
18-5338	R115001	Condenser
18-5404-1	R103001	Rotor
18-5376	R108001	Distributor Cap
	Mallory V-8 Tall Cap	



Display Package

18-5275 TUNE-UP KIT

Part #	-CONTAINS- O.E. #	Description
18-5303	R114002	Contact Set
18-5347	—	Condenser
18-5403	R103004	Rotor
18-5352	RA108003	Distributor Cap
	Prestolite V-8 Screw Down Cap	

APPLICATION ON PAGE 624

① Items ending in "D" are Display Packaged - Regular number is Non-Display



**18-5276
TUNE-UP KIT**

-CONTAINS-

Part #	O.E. #	Description
18-5303	R114002	Contact Set
18-5347	—	Condenser
18-5403	R103004	Rotor
18-5353	—	Distributor Cap

Prestolite V-6 Screw Down Cap

Display Package



**18-5277
TUNE-UP KIT**

-CONTAINS-

Part #	O.E. #	Description
18-5303	R114002	Contact Set
18-5347	—	Condenser
18-5407	R103003	Rotor
18-5369	RA108002	Distributor Cap

Prestolite V-8 Clip Down Cap

Display Package



**18-5301
TUNE-UP KIT**

Fits: Male cap v-8 flamethrower distributors



**18-5302
TUNE-UP KIT**

Fits: Male cap v-8 flamethrower distributors



**18-5278
TUNE-UP KIT**

Delco EST • V-6



**18-5281
TUNE-UP KIT**

Delco EST • V-8



**18-5303
CONTACT SET**

Replaces: R114002



**18-5314
CONTACT SET**

Replaces: R114001, R114004



**18-5317
CONTACT SET**



**18-5338
CONDENSER**

Replaces: R115001



**18-5345
CONDENSER**

Replaces: R115002



**18-5346
CONDENSER**



**18-5347
CONDENSER**



**18-29322
CAP & ROTOR KIT**

Fits: Ford HEI Distributors



**18-5245
ROTOR**

Replaces: R103011

For: Models MP 5.0L and 5.7L (2002-05)



**18-5403
ROTOR**

Replaces: R103004



**18-5404-1
ROTOR**

Replaces: R103001



**18-5407
ROTOR**

Replaces: R103003



**18-5300
ROTOR**

Fits: Flamethrower Distributors



**18-5474
DISTRIBUTOR CAP**

Red Distributor Cap with Male Terminals for Flamethrower Distributors

 <p>18-5473 DISTRIBUTOR CAP Black Distributor Cap with Male Terminals for Flamethrower Distributors</p>	 <p>18-5244 DISTRIBUTOR CAP Replaces: RA108009 For: Models MP 5.0L and 5.7L (2002-05)</p>	 <p>18-5352 DISTRIBUTOR CAP Replaces: RA108003</p>	 <p>18-5353 DISTRIBUTOR CAP</p>
 <p>18-5359 DISTRIBUTOR CAP</p>	 <p>18-5369 DISTRIBUTOR CAP Replaces: RA108002 Includes: 18-5399 Gasket</p>	 <p>18-5376 DISTRIBUTOR CAP Replaces: R108001</p>	 <p>18-5389 DISTRIBUTOR CAP</p>



FEATURES

- Senses current levels in the coil and adjusts the dwell to maintain peak energy throughout the entire RPM range.
- Develops, on average, 4 times more available energy between 3000 and 5000 RPM's and twice as much plug voltage as point-type systems.
- Ignition energy is sustained and coil life is increased when peak current level is reached just prior to spark.
- More stable timing.
- Use with 18-5472 "Flame Thrower II" Coil for optimum performance

 <p>18-5286 HI-PERFORMANCE ELECTRONIC CONVERSION KIT Fits: 6 Cylinder Delco Distributors</p>	 <p>18-5288 HI-PERFORMANCE ELECTRONIC CONVERSION KIT Fits: Most Prestolite V-8 Distributors with snap down cap</p>	 <p>18-5289 HI-PERFORMANCE ELECTRONIC CONVERSION KIT Fits: Most Prestolite V-8 Distributors with screw down cap</p>	 <p>18-5290 HI-PERFORMANCE ELECTRONIC CONVERSION KIT Fits: Most Mallory YL or YD 8 cylinder Distributors with clockwise and counter clockwise rotation</p>
---	---	---	---



FEATURES

- Replaces points & condensers for true solid state ignition.
- Uses standard coil, cap and rotor.
- Easy to install, one-piece, 2-wire hook-up.
- Accurate to within 1/4° timing accuracy 0 to 6000 RPM range.
- Can be used with Flame Thrower Coils 18-5466 & 18-5469.

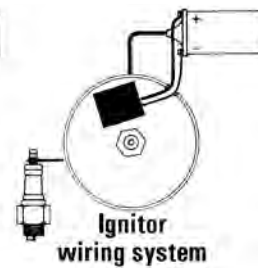

 <p>18-5294 ELECTRONIC CONVERSION KIT Fits: 6 Cyl. Delco distributors</p>	 <p>18-5295 ELECTRONIC CONVERSION KIT Fits: Most 4 Cyl. Prestolite distributors (Except IBM 7026) For: Onan, Universal, Waukesha, Wisconsin</p>	 <p>18-5296-2 ELECTRONIC CONVERSION KIT Fits: Most Mallory V-8 YL & YD 8 cyl. Distributors with clockwise and counter clockwise rotation</p> <p style="text-align: right;">① 18-5296-2D Display Package</p>
--	---	---

APPLICATION ON PAGE 624

① Items ending in "D" are Display Packaged - Regular number is Non-Display



18-5298
ELECTRONIC CONVERSION KIT
 (with snap down cap)
 For: Most Prestolite V-8 Distributors



① **18-5299D** Display Package
18-5299
ELECTRONIC CONVERSION KIT
 (with screw down cap)
 For: Most Prestolite V-8 Distributors
 Use with 18-5403 Style Rotor

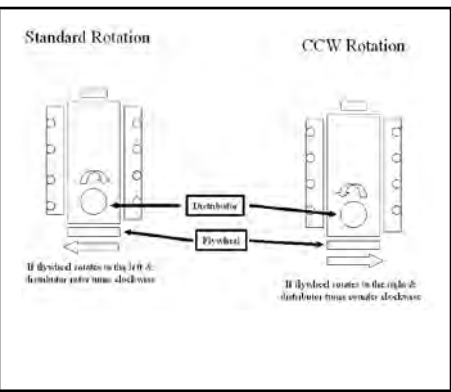

18-5309-1
DISTRIBUTOR
 Replaces: RA107001
 Mallory YL512CV
 For most Ford 302 CID V-8 Eng.
 Uses: 18-5251 TUNE-UP KIT — CONTAINS —
 Part # Desc.
 18-5314 Contact Set
 18-5338 Condenser
 18-5404-1 Rotor
 18-5376 Cap



18-5312-1
DISTRIBUTOR
 Replaces: Mallory YL554CV
 For most Ford 351 CID V-8 Eng.
 Uses: 18-5251 TUNE-UP KIT — CONTAINS —
 Part # Desc.
 18-5314 Contact Set
 18-5338 Condenser
 18-5404-1 Rotor
 18-5376 Cap



18-5313-1
DISTRIBUTOR
 Replaces: Mallory YL624MW
 For most GM V-8 Eng.
 (small & large blocks)
 Uses: 18-5251 TUNE-UP KIT — CONTAINS —
 Part # Desc.
 18-5314 Contact Set
 18-5338 Condenser
 18-5404-1 Rotor
 18-5376 Cap



FEATURES

- Distributors feature the Ignitor II ignition module with adaptive dwell control adjusts the spark timing over the entire RPM range to maximize performance
- Upper roller bearing and oil impregnated bronze sintered bottom bushing are installed and aligned bored for accuracy for maximum durability
- Machined heat treated gear with tight tolerances insures durability and consistent timing to maximize horsepower and performance. Complete with high dielectric strength cap and rotor for years of performance



18-5481
HI-PERFORMANCE ELECTRONIC DISTRIBUTOR
 Fits: Ford V-8 351 Windsor
 Replacement cap/rotor kit 18-5266

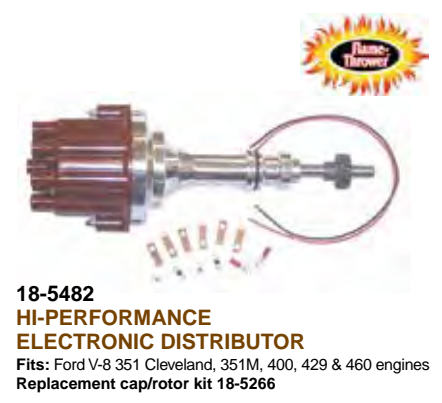

18-5482
HI-PERFORMANCE ELECTRONIC DISTRIBUTOR
 Fits: Ford V-8 351 Cleveland, 351M, 400, 429 & 460 engines
 Replacement cap/rotor kit 18-5266



18-5483
HI-PERFORMANCE ELECTRONIC DISTRIBUTOR
 Fits: Chevrolet Marine Small and Big Block engines (Standard Deck Height)
 Replacement cap/rotor kit 18-5266



18-5477
ELECTRONIC DISTRIBUTOR
 Ford 302 V-8 engines
 Replacement Cap/Rotor Kit 18-5266



18-5478
ELECTRONIC DISTRIBUTOR
 Chrysler LA series V-8 engines
 Replacement Cap/Rotor Kit 18-5266



18-5479
ELECTRONIC DISTRIBUTOR
 GM V-8 engines-reverse rotation
 Replacement Cap/Rotor Kit 18-5266

APPLICATION ON PAGE 624

① Items ending in "D" are Display Packaged - Regular number is Non-Display



18-5480
COMPLETE IGNITION CONVERSION KIT
 Fits: GM SB & BB with Standard Deck Height

—CONTAINS—

Part #	Description
18-5472	Coil
18-8803-2	Wire Set
18-5483	Distributor

18-5484-1
ELECTRONIC DISTRIBUTOR
 Conventional Rotation
 Replaces: RA107039E
 Late Model HEI
 For V8 — 262-454 & 502 except 384/409 and tall block engines
 • Designed as a plug-in replacement for GM-style fuel injection system distributors



—CONTAINS—

Description	Part #
Distributor Cap	18-5354
Rotor	18-5405
Tune-Up Kit	18-5281

18-5489-2
ELECTRONIC DISTRIBUTOR
 Conventional Rotation
 For Ford V-8 351W CID



—CONTAINS—

Part #	Description	Part #	Description
18-5376	Distributor Cap	18-5404-1	Rotor
18-5488	Module		

18-5494-2
ELECTRONIC DISTRIBUTOR
 Conventional Rotation
 For Chevrolet all V8 includes 482, 502, 540 CID (Except 348,409 & Tall Deck Big Block)



—CONTAINS—

Part #	Description	Part #	Description
18-5376	Distributor Cap	18-5404-1	Rotor
18-5488	Module		

18-5495-2
ELECTRONIC DISTRIBUTOR
 Replaces: Mallory YLM512CV
 Conventional Rotation
 For Ford V8 302 CID



—CONTAINS—

Part #	Description	Part #	Description
18-5376	Distributor Cap	18-5404-1	Rotor
18-5488	Module		

18-5496-2
ELECTRONIC DISTRIBUTOR
 Conventional Rotation
 For Ford V-8 351C – 460 CID



—CONTAINS—

Part #	Description	Part #	Description
18-5376	Distributor Cap	18-5404-1	Rotor
18-5488	Module		

PREMIUM MARINE IGNITION WIRES

Sierra's **MAGFORCE** Ignition Wires are "Electronics Friendly" protecting all of your electronic devices and electronic engine controls from RFI and EMI while delivering the maximum amount of voltage. Exact fit design ensures easy installation and years of trouble - free service.

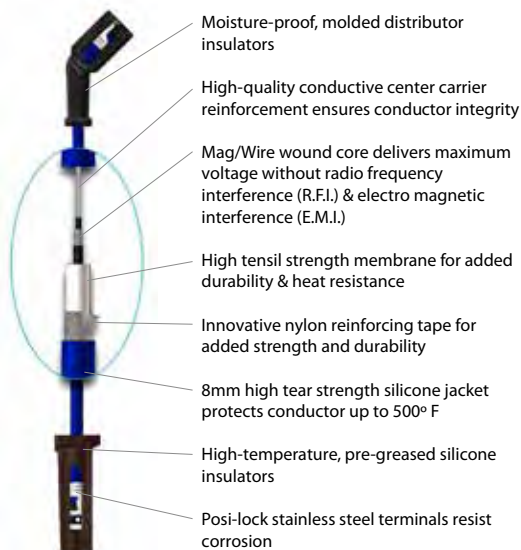

PLEASURECRAFT MARINE IGNITION WIRES APPLICATION

Engine	Cyl.	Distributor	Years	Plug Wire Set
220 (305 CID 5.0L)	8	Mallory/Prestolite ②	1987-1992	18-8803-2
270 (350 CID 5.7L)	8	Mallory/Prestolite ①	Up to 1987	18-8803-2
270 (350 CID 5.7L)	8	Mallory/Prestolite ②	1987-1992	18-8803-2
TB350	8	Delco EST ③	1992 & Up	18-8824-1
5.7L Classic	8	Mallory	1999 & Up	18-8803-2
5.7L MPI Classic	8	Delco HVS	2007 & Up	18-8828-1
MP5.0L Captain's Choice	8	Delco HVS	2002-2005	18-8828-1
MP5.7L Captain's Choice	8	Delco HVS	2002-2005	18-8828-1
MP6.0L	8	Distributorless	2002 & Up	18-8838-1
350 (454 CID 7.4L)	8	Mallory ④	Up to 1991	18-8803-2
454XL (454 CID 7.4L)	8	Delco EST ⑤	1991 & Up	18-8824-1
CM454HO (454 CID 7.4L)	8	Delco EST ⑤	1991 & Up	18-8824-1
454XL (454 CID 7.4L)	8	Delco EST ⑥	1993 & Up	18-8824-1
MP8.1L	8	Distributorless	ALL	18-8838-1
502 (502 CID 8.2L)	8	Prestolite ④	Up to 1991	18-8803-2
502 (502 CID 8.2L)	8	Delco EST ④	Up to 1991	18-8824-1
502XL (502 CID 8.2L)	8	Delco EST ⑤	1991 & Up	18-8824-1
TB502XL (502 CID 8.2L)	8	Delco EST ⑦	1994 & Up	18-8824-1

Engine	Cyl.	Distributor	Years	Plug Wire Set
262 CID 4.3L	6	Prestolite	ALL	18-8801-1
262 CID 4.3L	6	Delco EST	ALL	18-8810-1
262 CID 4.3L	6	Delco HVS	ALL	18-8829-1
220 (305 CID 5.0L)	8	Mallory/Prestolite ①	Up to 1987	18-8803-2

① Serial Number up to 68702 ② Serial Number 68703-90232 ③ Serial Number 90232 & UP
 ④ Serial Number up to 88710 ⑤ Serial Number 88710 & Up ⑥ Serial Number 92882 & Up
 ⑦ Serial Number 94268 & Up



**18-5225
SPARK PLUG WIRE KIT**

Replaces: Mercury 84-99215A26, 84-813706A26
Kit includes 25 ft. Roll of 7 MM Hypalon Ignition Wire With a Metallic Core and a Large Assortment of Three Different End Fittings.



BATTERY CABLES
Gauge cable with soldered lug terminals on each end to accept 3/8" stud.

PART NO.	SIZE	COLOR	GAUGE	PART NO.	SIZE	COLOR	GAUGE
BC88523	2'	red	4	BC88563	6'	red	2
BC88533	2'	black	4	BC88573	6'	black	2
BC88543	4'	red	2	BC88583	8'	red	1
BC88553	4'	black	2	BC88593	8'	black	1



**18-5226
IGNITION WIRE
Metallic Core**
100' Spool • 7mm Hypalon

PKG. OF 10



**18-5224
18-5224-9[®]
SPARK PLUG WIRE
TERMINAL**
Replaces: Mercury 20121
OMC 510364



**18-5750
18-5750-9[®]
UNIVERSAL SPARK
PLUG BOOTS**
Supplied complete w/Terminal Connector
Replaces: OMC 581027, 580339



**18-5752
UNIVERSAL
SPARK PLUG BOOT**
8mm

IGNITION / ELECTRICAL SYSTEMS APPLICATION

Years	Cyl.	Model/Engine	Distributor No.	Contact Set	Condenser	Dist. Cap	Rotor	Tune-Up Kit	Coil	Distributor	Elect. Conv. Kit
1959-72	4	1C	IGW-4118A	—	18-5345	18-5359	—	—	18-5435	—	—
1959-73	4	1C	IGW-4301	—	18-5345	—	—	—	18-5435	—	—
1984-88	6	3.8L Eng.	IBM-7014A	18-5303	18-5345 ④	18-5353	18-5403	18-5260, 18-5276 ⑥	18-5433 ⑥ ⑦	—	—
1973-74	8	Mercury Dist.	B64025A2	18-5317	18-5346 ④	18-5389	—	—	18-5433 ⑤	—	—
1976-82	8	305,350, 454 Eng.	IBM-7011	18-5303	18-5345 ④	18-5352	18-5403	18-5260, 18-5275 ⑥	18-5433 ③ ④	18-5494-2 ① 18-5498-1 ② 18-5313-1 ③	18-5299
1983-88	8	305, 350, 454 Eng.	IBM-7013	18-5303	18-5345 ④	18-5352	18-5403	18-5260, 18-5275 ⑥	18-5433 ⑥ ⑦	18-5494-2 ① 18-5498-1 ② 18-5313-1 ③	18-5299
1975-86	8	Ford 302 Eng.	IBM-7007, A	18-5303	18-5345 ④	18-5369	18-5407	18-5255, 18-5277 ⑥	18-5433 ⑥ ⑦	18-5495-2 ① 18-5309-1 ③	18-5298
1975-86	8	Ford 351, 460 Eng.	IBM-7008, A, B, C	18-5303	18-5345 ④	18-5369	18-5407	18-5255, 18-5277 ⑥	18-5433 ⑥ ⑦	18-5496-2 ① 18-5312-1 ③	18-5298
1986-UP	8	Ford 302 Eng.	Prestolite	N/A	N/A	18-5352	18-5403	N/A	18-5433 ⑥ ⑦	18-5495-2 ① 18-5309-1 ③	18-5299
1987	8	—	Prestolite	18-5303	18-5345 ④	18-5352	18-5403	18-5260, 18-5275 ⑥	18-5433 ⑥ ⑦	—	—
ALL	8	—	Mallory	18-5314	18-5338	18-5376	18-5404-1	18-5251, 18-5271 ⑥	18-5433 ⑥ ⑦	—	18-5296-2

- ① Electronic Distributor (Standard Rotation)
- ② Electronic Distributor (Counter Rotation)
- ③ Contact Controlled Distributor (Standard Rotation)
- ④ For strap type, use 18-5347
- ⑤ For applications requiring internal resistor use 18-5436
- ⑥ For applications requiring internal resistor use 18-5435
- ⑦ Use 18-5450 coil resistor
- ⑧ With distributor cap

FEATURES

- Oil filled for better cooling and long life
- Low resistance and improved turn ratios produces the higher voltage needed to run larger spark plug gaps for added power and better fuel economy
- More windings maximize energy and reliability over the full RPM range
- Fits existing brackets for easy installation



**18-5466
HI-PERFORMANCE
IGNITION COIL**
1.5 ohm (oil filled), black - 8 cylinder:
Flame-Thrower 40,000 volt coil.

- Designed for use with the original Ignitor Electronic Conversion Kits
- Can be used with other inductive ignition systems



**18-5469
HI-PERFORMANCE
IGNITION COIL**
3.0 ohm (oil filled), black - 4 & 6 cylinder:
Flame-Thrower 40,000 volt coil.

- Designed for use with the original Ignitor Electronic Conversion Kits
- Can be used with other inductive ignition systems



**18-5472
HI-PERFORMANCE
IGNITION COIL**
0.6 ohm (oil filled), black - 4, 6, & 8 cylinder:
Flame-Thrower 45,000 volt coil.

- Super low 0.6 ohm resistance coil designed for use with the Ignitor II Hi Performance Electronic Conversion Kits
- Compatible with capacitive discharge systems

Part #	Description	Recommended Coil	Resistance Ohms	Part #	Description	Recommended Coil	Resistance Ohms
18-5294	Electronic Conversion Kit	18-5469	3.0	18-5288	Hi Performance Electronic Conversion Kit	18-5472	0.6
18-5295	Electronic Conversion Kit	18-5469	3.0	18-5289	Hi Performance Electronic Conversion Kit	18-5472	0.6
18-5296-2	Electronic Conversion Kit	18-5466	1.5	18-5290	Hi Performance Electronic Conversion Kit	18-5472	0.6
18-5298	Electronic Conversion Kit	18-5466	1.5	18-5483	Flame-Thrower Distributor	18-5472	0.6
18-5299	Electronic Conversion Kit	18-5466	1.5	18-5483	Flame-Thrower Distributor	18-5472	0.6
18-5286	Hi Performance Electronic Conversion Kit	18-5472	0.6	18-5483	Flame-Thrower Distributor	18-5472	0.6

⑨ Priced per Package



18-7648
IGNITION COIL
Replaces: R117012



18-5433
IGNITION COIL
Replaces: R117001
Uses External Resistor



18-5435
IGNITION COIL
4.0 OHM
Has Internal Resistor



18-5436
IGNITION COIL
3.0 OHM
Has Internal Resistor



18-5450
COIL RESISTOR
1.5 OHM
Replaces: R119001



18-9802
TIMING LIGHT
Self-powered accurate up to 10,000 RPM's



18-5464
IGNITION MODULE
Fits: Sierra 18-5481, 18-5482 and 18-5483 Billet
HI-PERFORMANCE ELECTRONIC DISTRIBUTORS (except HEI/EST)



18-26810
GM HEI 4 TERMINAL PIGTAIL
Fits: GM HEI Distributors w/4 terminals



18-26811
GM HEI 2 TERMINAL PIGTAIL
Fits: GM HEI Distributors w/2 terminals



18-26812
HEI COIL GRAY CONNECTOR



18-26813
HEI COIL BLACK CONNECTOR



18-5493
IGNITION PICKUP COIL ASSEMBLY
Replacement pick-up coil for Accel Electronic Distributors



18-5603
STARTER
Replaces: RA122009
Noseless:CCW Top mount rear entry starter for standard rotation GM & Ford engines. Can be used in place of 18-5908



18-6443
STARTER
Replaces: RA122019
PG260, CW that fits GM 6.0L



18-5907
STARTER
(Heavy-Duty) (No Core) Clockwise
Replaces: RA122008
Replacement Solenoid: 18-5837
Will not replace non-starter mounted solenoids.
Top mount rear entry started for opposite rotation GM & FORD engines.
SAEJ1171

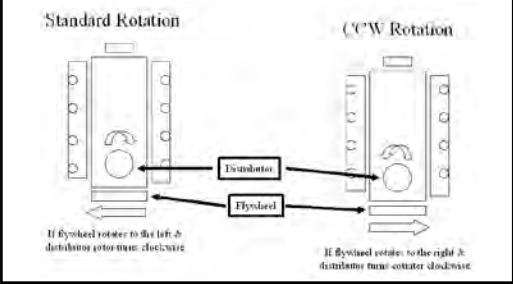

18-5908
STARTER
(Heavy-Duty) (No Core) Counter-Clockwise
Replaces: RA122009
Replacement Solenoid: 18-5837
Top mount rear entry started for standard rotation GM & FORD engines.
SAEJ1171



18-5903
STARTER
(No Core) Clockwise
 Replaces: RA122001
 Replacement Solenoid: 18-5801
 Bottom mount, two bolt pattern for standard rotation FORD engines.



18-5920
STARTER
 Replaces: 987811, RK122014, RA122001
 For: 5.0 & 5.8 litre Ford engines.

①18-5801D



18-5801
SOLENOID
 Replaces: R130001
 For all engines with flat solenoid bracket



18-5957
ALTERNATOR
(3-Wire) (68 amp)
 Replaces: RA097002, RA097003, RA097006
 Replaces Mando, Motorola and original equipment Delco. Uses same electrical connections and mounting method. Equipped with fan and drive pulley. SAEJ1171



18-5984
ALTERNATOR
 Replaces: RA097007B
 7SI/70 amp, spool mount, 2 5/8" OD, 6 groove serpentine pulley Clockwise position, 65mm



18-6451
ALTERNATOR
 Fits: Gm LS Series



18-6288
ALTERNATOR
 Replaces: RA097007B
 7SI/70 amp, spool mount, single groove V-belt pulley



18-6452
ALTERNATOR
 Replaces: RA097009
 11SI/95 amp spool mount, serpentine pulley



18-6453
ALTERNATOR
 Replaces: RA097007C
 7SI/70 amp spool mount, serpentine pulley



18-7227
CHOKE THERMOSTAT
 Replaces: RN0067
 For: Holley Carburetors



18-15214
RELAY, SHROUDED
 Replaces: R130012
 For: Fuel Pump on Crusader MEFI systems



18-7206
FLOAT
 Nitrophenyl

① Items ending in "D" are Display Packaged - Regular number is Non-Display



**18-7017
CARB KIT**
(Contains non-adjustable needles & seats)
Replaces: RN0118-1, RN0120-1



**18-7081
CARB KIT**
Replaces: RN0116, RN0116-2



**18-7096
CARB KIT**
Replaces: RN0118, RN0120

CARBURETOR KIT AND FLOAT APPLICATION

Engine/Model	Cyl.	Mfg. Code	Carb. Model	Carburetor No.	Float	Carb Kit ①
155, 165, 175, 185 w/302" (5.0L)	8	H-2	2300	R-6150A, R-6317A, R-6317-1A, R-7036A (D1JJ-9510-B, D3JL-9510-S)	18-7206	18-7081
215, 255, 215 w/302" (5.0L) 351" (5.8L)	8	H-4	4160	R-4473A, R-4473AAS, R-4608A, R-4608AAS, R-6151A, R6151AAA, R-6152A, R-6152AAA, R-6407A, R-6576A (C9FF-9510-E, D2JL-9510E)	18-7206	18-7096
215, 255 w/302" (5.0L) 351" (5.8L)	8	H-4	4160	R-7159A, R-7163A, D4JL-9510-F, D4JL-9510-G	—	18-7017

① Does not include metering rods.



**18-7646
CAMSHAFT SENSOR**
Replaces: R020035A



**18-7677
KNOCK SENSOR**
Replaces: R020027



**18-7697
IAC MOTOR**
Replaces: R084003



**18-32150
O2 SENSOR**
Replaces: Idmar, Pleasurecraft, Mastercraft
Fits: GM New Generation Ls Series Small Block



**18-32151
O2 SENSOR**
Replaces: Idmar, Pleasurecraft, Mastercraft
Fits: GM New Generation Ls Series Small Block

FUEL WATER SEPARATORS



Sierra offers a complete line of 10 and 21 micron fuel water separating filters including drainable bowl filters to protect your carbureted and fuel injected engine.

Refer to pages 136-140 for a complete listing of OEM and universal applications.

Sierra fuel water separators remove over 99.8% of emulsified water from your gasoline. Sierra's 10 micron filters are over 90% efficient at removing particles as small as 10 micron. All filters flow @ 90 GPH to feed even the hungriest motor. Sierra 10 micron filters are recommended to prevent damage to sensitive inboard and outboard fuel injection systems.

Sierra #	Pleasurecraft #	Description
18-7976		Fuel Filter with O-rings
18-7964-1		Fuel Filter



18-37824
INLINE FUEL FILTER
 Replaces: 9-37824
 Fits: Gasoline Engines with pump boost, In-line filter



New

18-8127
FUEL FILTER
 Replaces: RP080026
 For: 1996 & Up EFI Engines



18-7267
FUEL PUMP
 Flange I.D. #41414
 For: Ford (V-8) 302



18-3577-2
CIRCULATING WATER PUMP (Bi-Directional)
 Replaces: RA057019
 Fits: GM Big Block



18-3584
CIRCULATING WATER PUMP (Bi-Directional)
 Replaces: RA057004
 Includes 18-0147 gasket
 Fits: Ford 302 & 351w



18-42608
CIRCULATING WATER PUMP
 Replaces: RA057036
 Fits: Indmar/PCM 6.0L



18-3599-2
CIRCULATING WATER PUMP
 Replaces: RA057018
 For: GM V-6 & small block V-8 engines
 Uses gasket 18-0981 (included)



18-3586-1
WATER PUMP
 Replaces: RA057023
 Use Impeller Repair Kit: 18-3081



18-3587-1
WATER PUMP
 Replaces: RA057024



18-5899
OIL PRESSURE SENDER
 Replaces: RO20001



18-3551
THERMOSTAT
 Replaces: R026002E
 142°
 For: FORD 302/351 CID Engines
 Raw Water Cooled



② 18-3671D

Display Package

18-3671
THERMOSTAT KIT
 Replaces: RP026002E
 For: Ford 302/351 CID Engines
 Includes:
 18-3551 Thermostat and
 18-0875 Gasket
 Raw Water Cooled

PKG. OF 8



FREEZE PLUGS
18-5961
18-5961-9①
 1 5/8"
18-5962
18-5962-9①
 1 3/4"



18-3060
IMPELLER
 Replaces: RP061015
 Sherwood 9959
 For: Ford Engines



18-3061
IMPELLER
 Replaces: RP061017
 Sherwood 10615
 For: GM Engines
 With V-Belt



② 18-3081D

Display Package

18-3081
IMPELLER REPAIR KIT

PKG. OF 2



18-7480
18-7480-9①
O-RING
 Replaces: R047111
 For use with 18-3060 & 18-3061 Impeller

① Priced per Package

② Items ending in "D" are Display Packaged - Regular number is Non-Display

Fits Ford Small Block V8 302 & 351 cu. in.

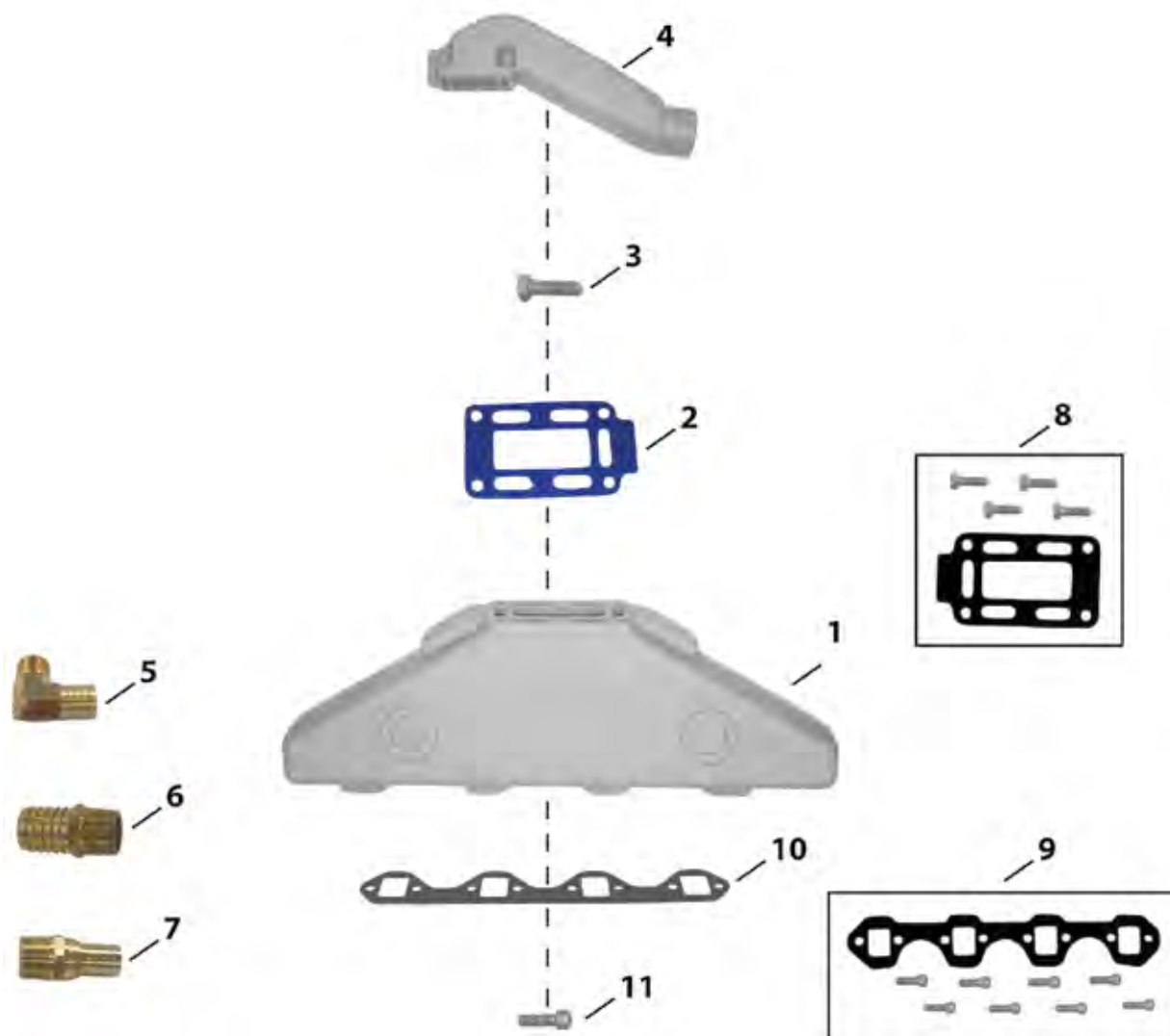

Item No.	Description	OE No.	Application
1	18-1996 MANIFOLD	RO28001	Ford Small Block (V8) 302-351 cu.in.; Use with Manifold Gasket: 18-0183-1; Mounting Kit: 18-8503
2	18-0677-1 GASKET	RM0002	Use with Riser: 18-1899; Included in 18-8504 mounting kit.
3	NSS MOUNTING BOLT	N/A	Included in 18-8504 mounting kit.
4	18-1899 RISER W/ 3" OUTLET	RO29001	Use with Manifold: 18-1996; Riser Gasket: 18-0677-1; Mounting Kit: 18-8504
5	18-8216 HOSE FITTING	N/A	3/4" - 14NPT X 1" Hose (Corrosion Resistant Brass Fitting)
6	18-4461 HOSE FITTING	N/A	3/4" - 14NPT X 1" Hose (Corrosion Resistant Brass Fitting)
7	18-8215 HOSE FITTING	N/A	3/4" - 14NPT X 3/4" Hose (Corrosion Resistant Brass Fitting)
8	18-8504 MOUNTING KIT	N/A	Use with Manifold: 18-1899. Includes 18-0677-1 gasket.
9	18-8503 MOUNTING KIT	N/A	Use with Manifold: 18-1996. Includes 18-0183-1 gasket.
10	18-0183-1 MANIFOLD GASKET	RM0007	Use with Manifold: 18-1996; Included in 18-8503 mounting kit.
11	NSS MOUNTING BOLT	N/A	Included in 18-8503 mounting kit.

**SIERRA MANIFOLDS
ARE PAINTED, PACKAGED AND LEAK TESTED**

18-1997-1

MANIFOLD

Port & Starboard

Replaces: Barr CHV-1-83

Universal Center Riser Manifold

FITS: GM 283, 305, 307 and 350 CID engines

Use 18-0604 Exhaust Manifold Gasket Set

*For Exploded View - See Pages 638-639



18-1996

MANIFOLD

Port & Starboard

Replaces: Pleasurecraft RO28001, Barr FM-1-83

Pleasurecraft Ford Small Block V8 302 and 351 cu. in.

Used with:

Exhaust Manifold Gasket: 18-0183-1 (included)

Mounting Kit: 18-8503



18-1998-1

MANIFOLD

Port & Starboard

Replaces: Barr FM-1-83

Universal Center Riser Manifold

FITS: Ford 302 and 351 CID engines

Use 18-0603 Exhaust Manifold Gasket Set

*For Exploded View - See Pages 640-641



18-1991

ELBOW ADAPTER

Replaces: Barr 200089P

For: 3" I.D. Exhaust Hose

Use 18-1999 Manifold Riser

30°



18-1992-1

ELBOW ADAPTER

Replaces: Barr 200087P

For: 3" I.D. Exhaust Hose

(As used in 18-1987 Exhaust Manifold Conversion Kit)

80°



18-1899

RISER

Replaces: Pleasurecraft RO29001

Fits: Small block 302/351cu.in. Ford with 3" outlet.

Fits: 18-1996 Manifold

Used with:

Manifold: 18-1996

Riser Gasket: 18-0677-1

Mounting Kit: 18-8504



18-1999

ELBOW

Replaces: Barr 20-0082

Comes with 18-4364 open Mounting Package

If blocked mounting kit is required use 18-8535

Use 18-2854-1 open, 18-0476-1 blocked Riser Gasket

Use with:

Manifold: 18-1997 or 18-1998-1



18-4363

EXHAUST ELBOW MOUNTING KIT

Replaces: Barr FM-1-83-P

Use with:

Manifold: 18-1998-1



18-4364

EXHAUST ELBOW MOUNTING KIT

Replaces: Barr 20-0082-P

Use with:

Riser: 18-1999, 18-1907, 18-1939



18-8503

EXHAUST MANIFOLD MOUNTING KIT

Pleasurecraft Ford Small Block

V8 302 and 351cu.in.

Used with:

Manifold: 18-1996



18-8504

EXHAUST ELBOW MOUNTING KIT

Pleasurecraft Ford Small Block

V8 302 and 351cu.in.

Used with:

Riser: 18-1899



18-8535

EXHAUST ELBOW MOUNTING KIT

Barr, Indmar and Marine Power Ford Small Block V8

302-351cu.in., GM Small Block V8 305-350cu.in., GM Big

Block V8 454cu.in.

Used with:

Risers: 18-1939, 18-1999, and 18-1907





18-8536
EXHAUST ELBOW MOUNTING KIT
 Barr, Indmar and Marine Power GM Small Block V8 305-350cu.in.
 Used with:
 Manifold: 18-1997-1



18-8538
EXHAUST MANIFOLD MOUNTING KIT
 Barr and Indmar Ford Small Block V8 302-351cu.in.
 Used with:
 Manifold: 18-1998-1



18-0603
EXHAUST MANIFOLD GASKET SET
 For: Ford 302/351 CID Engines
 Use with:
 Manifold: 18-1998-1



18-0604
EXHAUST MANIFOLD GASKET SET
 For: GM 305/350 CID Engines
 Use with:
 Manifold: 18-1997-1



18-0183-1
EXHAUST MANIFOLD GASKET
 Replaces: RM0007
 Use with:
 Manifold: 18-1998-1



PIPE PLUGS

Part #	Thread Size	Part #	Thread Size
18-4256	1/4"	18-4263	1/8" - 27 NPT
18-4257	1/4"	18-4264	3/8" - 18 NPT
18-4258	3/4"		

56507 Pipe Sealant with Teflon® is recommended for use on plug threads.



18-0676-1
EXHAUST ELBOW GASKET
 Replaces: RM0099



PKG. OF 2
18-0677-1
18-0677-9^①
EXHAUST ELBOW GASKET
 Replaces: RM0002
 Use with:
 Mounting Kit: 18-8504
 Riser: 18-1899



PKG. OF 2
18-2854-1
18-2854-9^①
EXHAUST ELBOW GASKET
 Use with:
 Riser: 18-1999, 18-1907, 18-1939



PKG. OF 2
18-2949
18-2949-9^①
EXHAUST MANIFOLD GASKET
 Replaces: Barr CHV-47-000
 Use with:
 Manifold: 18-1997-1



18-0898
OIL PUMP MOUNTING GASKET
 Replaces: 27-56859
 For: Ford Engines



②18-4218D 
18-4218
DRAIN TAP
 Used with most O.E.M. Manifolds
18-3223-9 Bulk Pack of 12
 1/4" Brass



PKG. OF 2
18-0875
18-0875-9^①
THERMOSTAT GASKET



PKG. OF 2
18-0878
18-0878-9^①
THERMOSTAT GASKET
 Replaces: RM0003



PKG. OF 2
18-0889
18-0889-9^①
FUEL PUMP GASKET
 Replaces: 3705042

① Priced per Package
 ② Items ending in "D" are Display Packaged - Regular number is Non-Display

OIL FILTERS



Display Package

Part #	Replaces:	Application
18-7824-2	R077002	GM Engines (Short)
18-7875	R077001	Ford Engines (Long)
18-7876-1	—	GM Engines (Long)
18-7878-1	—	Ford Engines (Short)

SEE PAGES 182-184 & 1147-1170 FOR ADDITIONAL INFORMATION

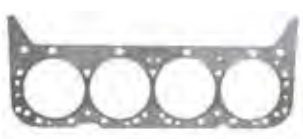

18-3876 HEAD GASKET
 Replaces: GM 6269577
 For: GM 305/350 CID Engines

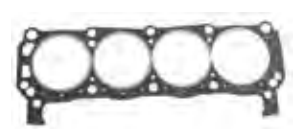

18-3883 HEAD GASKET
 Replaces: RM0032
 For Ford 302 and 351 CID Engines



18-4461 HOSE BARB
 3/4" - 14 NPT x 1" Hose
 Corrosion Resistant Brass Fitting



18-8215 HOSE BARB



18-2434 FLYWHEEL BELL HOUSING
 Replaces: R142006
 For: GM Blocks



18-2103 POWER TRIM HOSE
 Replaces: RO85035



18-2702-1 POWER TRIM BUSHING
 Replaces: R094020A



18-4220 THRUST WASHER
 Replaces: R096116



18-4214 LOCKING WASHER
 Replaces: RO96081



18-3701 PROP NUT KIT
 -CONTAINS-

Part #	O.E. #	Desc.
18-3200	R096117	Tab Washer
18-3700	R017066	Prop Nut



18-3700 PROP NUT
 Replaces: R017066



18-3200 TAB WASHER
 Replaces: R096117



18-4446 PROP WRENCH KIT
 - CONTAINS -

Part #	Desc.	O.E.#	Qty.
18-3200	Tab Washer	R096117	2
18-3700	Prop Nut	R017066	1
18-4444	Prop Wrench	—	1



18-4444 PROP WRENCH



18-4456 EXHAUST PROTECTOR VALVE
 Includes Stainless Steel Clamp
 3"



18-4457 EXHAUST PROTECTOR VALVE
 Includes Stainless Steel Clamp
 4"



18-4458 EXHAUST PROTECTOR VALVE
 Includes Stainless Steel Clamp
 5" & 6" (5" requires two 45° cuts)

① Priced per Package

② Items ending in "D" are Display Packaged - Regular number is Non-Display

UNIVERSAL



18-5307
CONTACT SET



18-5310
CONTACT SET



18-5311
CONTACT SET



18-5345
CONDENSER



18-5347
CONDENSER



18-5268
TUNE-UP KIT



18-5354
DISTRIBUTOR CAP



18-5359
DISTRIBUTOR CAP



18-5385
DISTRIBUTOR CAP



18-5418
ROTOR



18-5427
ROTOR



18-5419
ROTOR



18-5430
ROTOR



Display Package

18-5433
IGNITION COIL
Requires external resistor
For: Atomic Four w/resistor (1969-70),
Super Sabre (1948-70)



18-28100
COIL LEAD
12" long w/90 degree male Dist end
and 90 degree female coil end



18-28101
COIL LEAD
12" long w/90 degree female Dist end
and 90 degree female coil end



18-28102
COIL LEAD
12" long w/90 degree male Dist end
and 180 degree male coil end

PARTS FOR CONTACT CONTROLLED DISTRIBUTORS

Year	Cyl.	Model / Engine	Distributor	Contact Set	Condenser	Cap	Tune-Up Kit	Rotor
1969-70	4	Atomic Four	DELCO	18-5311	18-5345	18-5385	18-5268	18-5418
1961-70	4	Unimate Four, HF (Herc. IXB), LSG Super Four, BFA, BN Utility Four, BR, FA, UJ Atomic Four, UJ64	IGW	—	—	18-5354	—	—
	6	Arrow, Bluefin, Economy, Bullet, Knight, Marlin, Tarpon	IGC-5501A	18-5307	18-5347 ^①	—	—	18-5430
1954-68	6	Explorer Master, OK, OL, Z, Super Six	IAY-4009-1, IA	18-5307	—	—	—	18-5427
1963-65	6	Super Sabre	1110322	18-5310	—	—	—	18-5419
1945-60	4	HF, UJ, Atomic Four, BFA, BFS, BN, BR, EA, LSG, Racing 4, Super 4	IGW	—	—	18-5359	—	—
1955-57	6	HCS, LHS	IGW-6002B	18-5307	—	—	—	18-5430

① For lead type, use 18-5345

Standard Rotation

CCW Rotation

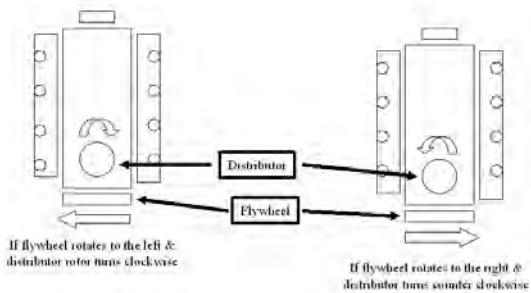

18-6264
RELAY
Arco R036
32-36 Volt, 85 Amp
Used with many winch motors



18-6263
ALTERNATOR
Replaces: 288182, 288759
12 Volt, 51 Amp, Integral Regulator,
Negative Ground, Single Groove Pulley
For: Universal and others
(I/O)



18-6284
ALTERNATOR
Hitachi Marine, Arco 84135
12 Volt, 35 Amp, Integral Regulator,
Single Groove Pulley
Fits: Yanmar Diesel
(Inboard)



18-5804
SOLENOID



18-5840
SOLENOID

PARTS FOR CHARGING SYSTEMS

PARTS FOR STARTING SYSTEMS

Year	Model	Volt	Alt. or Gen. No	Voltage Regulator	Volt	Starter No.	Starter Switch Kit
1961-68	Explorer, Master, Super Six	—	—	—	12	MAU-4046	18-5840
	Unimite Four, Atomic Four, Utility	12	ALE-5202	—	—	—	—
	Four, Blue Jacket Twin	12	ALE-5204S	18-5710	12	MAU-4006, 47	18-5840
		12	ALK-6204	—	12	MBG-4129, 31	18-5840
1955-68	Knight, Tarpon, Marlin, Bullet, Arrow, Bluefin	—	—	—	6	MAU-4046, 47	18-5840
1954-68	OK, OL, Z Superb, Z Series	—	—	—	6	MAU-4046, 47	18-5840
1961-64	11694 Super Sabre V-6	12	1100619, 54	—	12	1107260	18-5804
1955-57	AMS, HCS, LHS	—	—	—	12	MAB-4116	18-5840

**18-7070
CARB KIT**

For: 198(3.3L), 225(3.7L) E, 6Cyl.
Carb Type and Model: R-2, 2GC
Carb No:7023081,7025181



**18-7071
CARB KIT**

For: 225(3.7L) Eng., 6Cyl.
Carb Type and Model: R-1, BC
Carb No:7024083



FUEL WATER SEPARATORS



Sierra offers a complete line of 10 and 21 micron fuel water separating filters including drainable bowl filters to protect your carbureted and fuel injected engine.

Refer to pages 136-140 for a complete listing of OEM and universal applications.

Sierra fuel water separators remove over 99.8% of emulsified water from your gasoline. Sierra's 10 micron filters are over 90% efficient at removing particles as small as 10 micron. All filters flow @ 90 GPH to feed even the hungriest motor. Sierra 10 micron filters are recommended to prevent damage to sensitive inboard and outboard fuel injection systems.

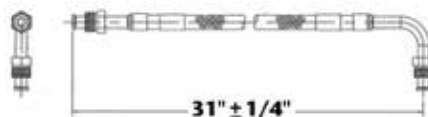

**18-8114
FUEL LINE HOSE**

For fuel pump to carburetor connection. Replaces copper or steel tubing 3/8" X 31" PTFE composite hose with 5/8"-18 male inverted flare straight one end, 5/8"-18 90° one end. SAE J1527 type A1

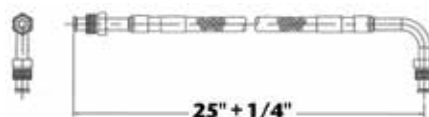

**18-8115
FUEL LINE HOSE**

For fuel pump to carburetor connection. Replaces copper or steel tubing 3/8" X 25" PTFE composite hose with 5/8"-18 male inverted flare straight one end, 5/8"-18 90° one end. SAE J1527 type A1



Fits GM 454/502 CID V8 Big Block

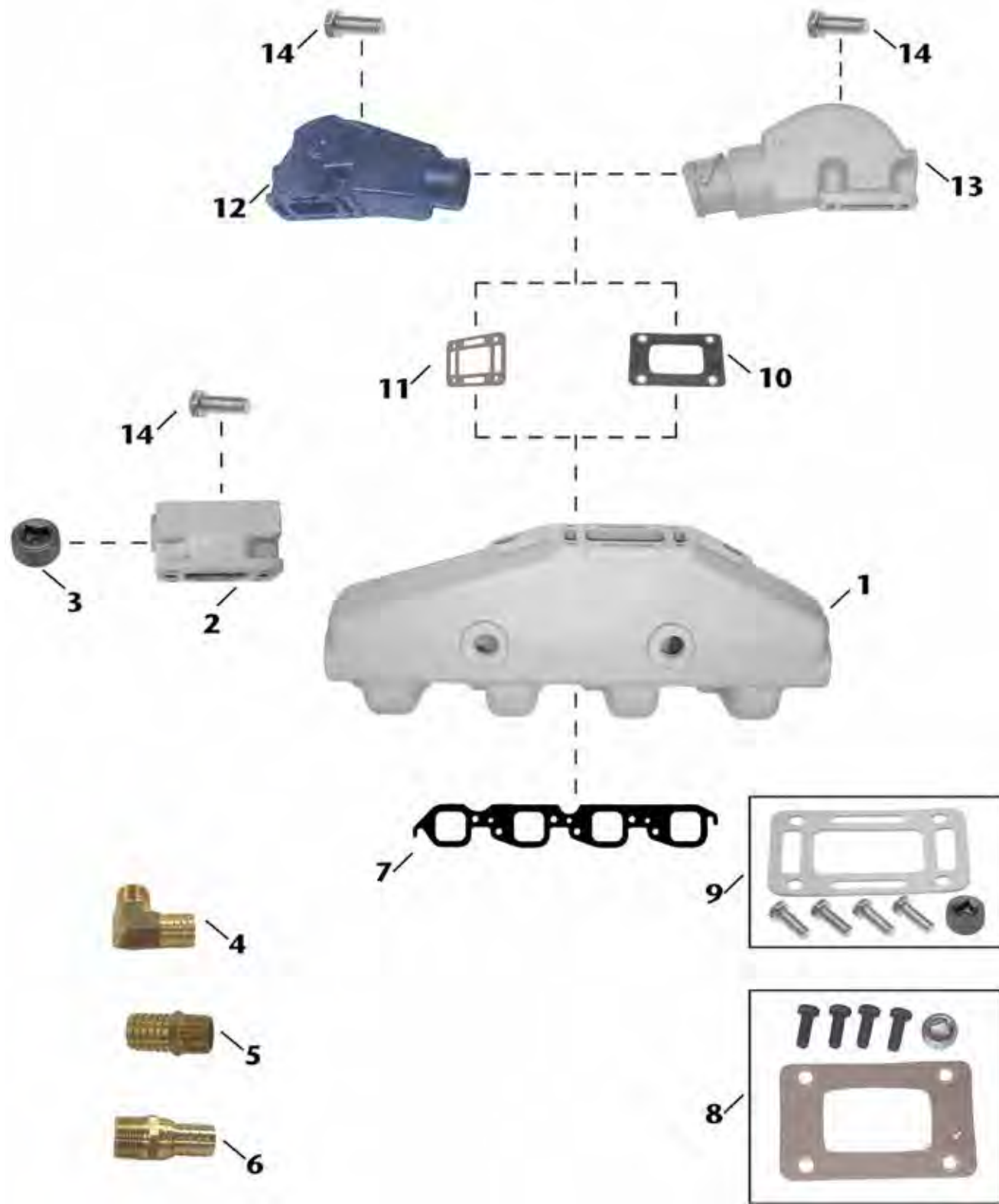

Item No.	Description	OE No.	Application
1	18-1898 MANIFOLD	BARR CHVA-1-84, MARINE POWER 0991-110	Fits 454/502 cu. in. GM Big Block V8 engines. Used with Manifold Gasket: 18-0418.
2	18-1949 MANIFOLD SPACER	N/A	Use with Manifold: 18-1898.
3	18-4258 BLACKSTEEL PLUG	N/A	Thread Size: 3/4". Use with Manifold Spacer: 18-1949.
4	18-8216 HOSE FITTING	N/A	3/4" - 14NPT X 1" Hose (Corrosion Resistant Brass Fitting)
5	18-4461 HOSE FITTING	N/A	3/4" - 14NPT X 1" Hose (Corrosion Resistant Brass Fitting)
6	18-8215 HOSE FITTING	N/A	3/4" - 14NPT X 3/4" Hose (Corrosion Resistant Brass Fitting)
7	18-0418 MANIFOLD GASKET	CRUSADER 96653	Use with Manifold: 18-1898
8	18-8535 MOUNTING KIT (BLOCKED GASKET)	N/A	Use with Risers: 18-1939, 18-1999, 18-1907. Includes 18-0476-1 elbow gasket. (Use with a closed cooling system)
9	18-4364 MOUNTING KIT (OPEN GASKET)	BARR 20-0082-P	Use with Risers: 18-1999, 18-1907, & 18-1939. Includes 18-2854-1 elbow gasket.
10	18-0476-1 ELBOW GASKET (BLOCKED)	BARR 01-0105	Used with Risers: 18-1939, 18-1999. Included in 18-8535 mounting kit.
11	18-2854-1 3" ELBOW GASKET (OPEN)	BARR 01-0107	Used with Risers: 18-1939, 18-1999. Included in 18-4364 mounting kit.
12	18-1999 3 1/2" MANIFOLD ELBOW	BARR 20-0082	Comes with 18-4364 (open) mounting package. If blocked mounting kit is required use 18-8535 mounting kit. Use with Manifold: 18-1898; Riser Gasket: 18-2854-1 (open) or 18-0476-1 (blocked)
13	18-1939 3 1/2" MANIFOLD ELBOW	BARR 20-0100, MARINE POWER 0992-593	Use with Manifold: 18-1898; Riser Gasket: 18-2854-1 (open) or 18-0476-1 (blocked); Mounting Kit: 18-4364 (open) or 18-8535 (blocked)
14	NSS MOUNTING BOLT	N/A	Included in 18-4364 & 18-8535 mounting kits.



Fits GM 305/350 CID V8 Small Block

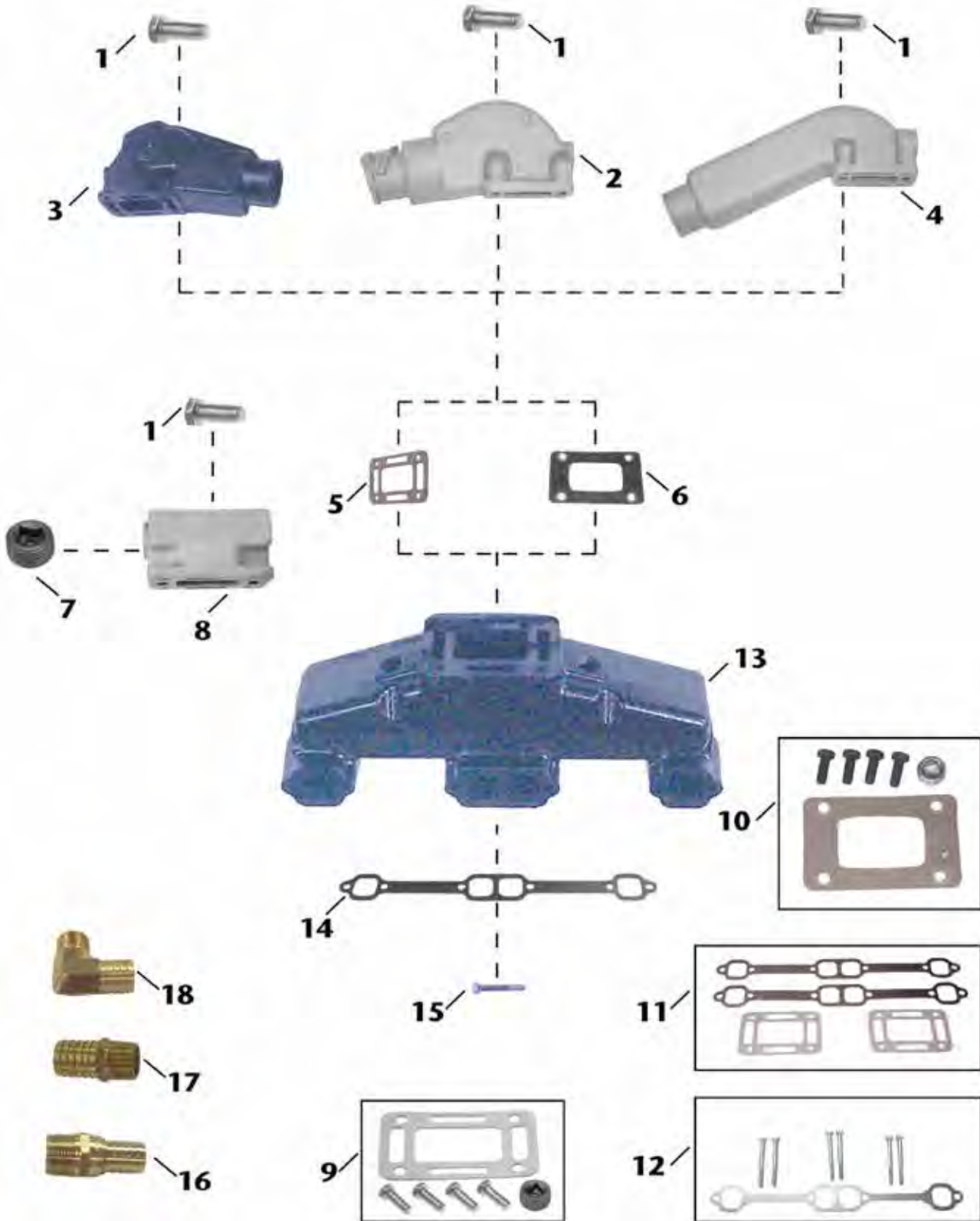

Item No.	Description	OE No.	Application
1	NSS MOUNTING BOLT	N/A	Included in 18-4364 & 18-8535 mounting kits.
2	18-1939 MANIFOLD ELBOW (3 1/2" hose, 7° down angle)	BARR 20-0100, MARINE POWER 0992-593	Use with Manifold: 18-1997-1; Riser Gasket: 18-2854-1 (open) or 18-0476-1 (blocked); Mounting Kit: 18-4364 (open) or 18-8535 (blocked)
3	18-1999 MANIFOLD ELBOW (3" hose, 15° down angle)	BARR 20-0082	Comes with 18-4364 (open) mounting package. If blocked mounting kit is required use 18-8535 mounting kit. Use with Manifolds: 18-1997-1; Riser Gasket: 18-2854-1 (open) or 18-0476-1 (blocked)
4	18-1907 MANIFOLD ELBOW (3" hose)	BARR 20-0100, INDMAR 53-2009, 53-2018	Use with Manifold: 18-1997-1; Riser Gasket: 18-2854-1 (open) or 18-0476-1 (blocked); Mounting Kit: 18-4364 (open) or 18-8535 (blocked)
5	18-2854-1 ELBOW GASKET (OPEN)	BARR 01-0107	Used with Risers: 18-1939, 18-1999, 18-1907. Included in 18-4364 mounting kit.
6	18-0476-1 ELBOW GASKET (BLOCKED)	BARR 01-0105	Used with Risers: 18-1939, 18-1999, 18-1907. Included in 18-8535 mounting kit.
7	18-4258 BLACKSTEEL PLUG	N/A	Thread Size: 3/4". Use with Manifold Spacer: 18-1949.
8	18-1949 MANIFOLD SPACER	N/A	Use with Manifold: 18-1997-1.
9	18-4364 MOUNTING KIT (OPEN GASKET)	BARR 20-0082-P	Use with Risers: 18-1999, 18-1907, & 18-1939. Includes 18-2854-1 elbow gasket.
10	18-8535 MOUNTING KIT (BLOCKED GASKET)	N/A	Use with Risers: 18-1939, 18-1999, 18-1907. Includes 18-0476-1 elbow gasket. (Use with a closed cooling system)
11	18-0604 EXHAUST MANIFOLD GASKET SET	N/A	GM 305-350 CID Engines; Use with Manifold: 18-1997-1
12	18-8536 MOUNTING KIT	N/A	Use with Manifold: 18-1997-1. Includes 18-2949 mounting kit.
13	18-1997-1 or 18-1964 MANIFOLD	BARR CHV-1-83	GM Small Block (V8) 305-350 cu.in. Use with Manifold Gasket 18-2949. Mounting Kit: 18-8536.
14	18-2949 MANIFOLD GASKET	BARR CHV-47-000	Use with Manifold: 18-1997-1. Included in 18-8536 mounting kit.
15	NSS MOUNTING BOLT	N/A	Included in 18-8536 mounting kit.
16	18-8215 HOSE FITTING	N/A	3/4" - 14NPT X 3/4" Hose (Corrosion Resistant Brass Fitting)
17	18-4461 HOSE FITTING	N/A	3/4" - 14NPT X 1" Hose (Corrosion Resistant Brass Fitting)
18	18-8216 HOSE FITTING	N/A	3/4" - 14NPT X 1" Hose (Corrosion Resistant Brass Fitting)



Fits Ford 5.0L/5.8L 302/351 CID V8

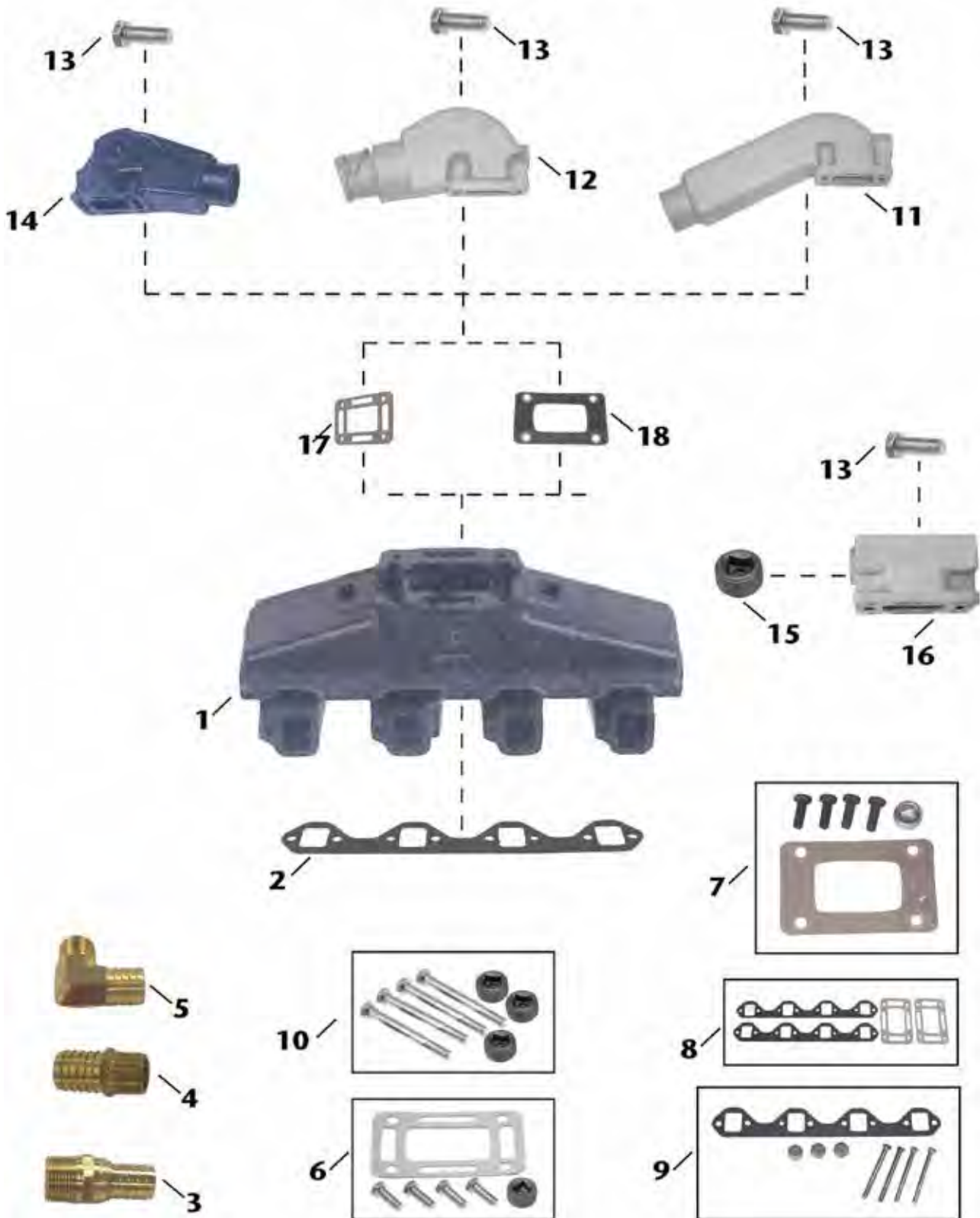

Item No.	Description	OE No.	Application
1	18-1998-1 MANIFOLD	BARR FM-1-83	Ford 302-351 (V8) CID Engines. Use with Manifold Gasket: 18-0183-1; Mounting Kit: 18-8538
2	18-0183-1 MANIFOLD GASKET	PLEASURECRAFT RM0007	Use with Manifold: 18-1998-1. Included in 18-8538 mounting kit.
3	18-8216 HOSE FITTING	N/A	3/4" - 14NPT X 1" Hose (Corrosion Resistant Brass Fitting)
4	18-4461 HOSE FITTING	N/A	3/4" - 14NPT X 1" Hose (Corrosion Resistant Brass Fitting)
5	18-8215 HOSE FITTING	N/A	3/4" - 14NPT X 3/4" Hose (Corrosion Resistant Brass Fitting)
6	18-4364 MOUNTING KIT (OPEN GASKET)	BARR 20-0082-P	Use with Risers: 18-1999, 18-1907, & 18-1939. Includes 18-2854-1 elbow gasket.
7	18-8535 MOUNTING KIT (BLOCKED GASKET)	N/A	Use with Risers: 18-1939, 18-1999, 18-1907. Includes 18-0476-1 elbow gasket. (Use with a closed cooling system)
8	18-0603 EXHAUST MANIFOLD GASKET SET	N/A	Ford 302-351 CID Engines; Use with Manifold: 18-1998-1.
9	18-8538 MOUNTING KIT	N/A	Use with Manifold: 18-1998-1. Includes 18-0183-1 manifold gasket.
10	18-4363 HARDWARE KIT	BARR FM-1-83-P	Hardware Only for Manifold: 18-1998-1
11	18-1907 ELBOW (3" hose)	BARR 20-0100, INDMAR 53-2009, 53-2018	Use with Manifold: 18-1998-1; Riser Gasket: 18-2854-1 (open) or 18-0476-1 (blocked); Mounting Kit: 18-4364 (open) or 18-8535 (blocked)
12	18-1939 ELBOW (7° down angle, 3 1/2" hose)	BARR 20-0100, MARINE POWER 0992-593	Use with Manifold: 18-1998-1; Riser Gasket: 18-2854-1 (open) or 18-0476-1 (blocked); Mounting Kit: 18-4364 (open) or 18-8535 (blocked)
13	NSS MOUNTING BOLT	N/A	Included in 18-4364 & 18-8535 mounting kits.
14	18-1999 MANIFOLD ELBOW (15° down angle, 3" hose)	BARR 20-0082	Comes with 18-4364 (open) mounting package. If blocked mounting kit is required use 18-8535 mounting kit. Use with Manifold: 18-1998-1; Riser Gasket: 18-2854-1 (open) or 18-0476-1 (blocked)
15	18-4258 BLACKSTEEL PLUG	N/A	Thread Size: 3/4". Use with Manifold Spacer: 18-1949
16	18-1949 MANIFOLD SPACER	N/A	Use with Manifold: 18-1998-1
17	18-2854-1 ELBOW GASKET (OPEN)	BARR 01-0107	Used with Risers: 18-1939, 18-1999, 18-1907. Included in 18-4364 mounting kit.
18	18-0476-1 ELBOW GASKET (BLOCKED)	BARR	Used with Risers: 18-1939, 18-1999, 18-1907. Included in 18-8535 mounting kit.



MOST MANIFOLDS ARE PAINTED, PACKAGED & LEAK TESTED



**18-1998-1
MANIFOLD**

Port & Starboard

Replaces: Barr FM-1-83

Universal Center Riser Manifold

FITS: Ford 302 and 351 CID engines

Comes with **18-4363 Mounting Package** - **Replaces:** Barr FM 1-83-P

Use with:

Exhaust Manifold Gasket Set: **18-0603**



**18-1997-1
MANIFOLD**

Port & Starboard

Replaces: Barr CHV-1-83

Universal Center Riser Manifold

FITS: GM 283, 305, 307 and 350 CID engines

Use with:

Exhaust Manifold Gasket Set: **18-0604**



**18-1999
ELBOW (3" HOSE)**

Replaces: Barr 20-0082

Comes with **18-4364 open Mounting Package**

Use with:

Manifold: **18-1997-1** or **18-1998-1** or **18-1898**

Riser Gasket: **18-2854-1 open** or **18-0476-1 blocked**

Mounting Kit: **18-4364 open** or **18-8535 blocked**



**18-1898
MANIFOLD**

Port & Starboard

Replaces: Barr CHVA-1-84, Marine Power 0991-110

Fits: 454 cu.in. GM big block V8 engines

Use with:

Exhaust Gasket: **18-0418**

Riser Gasket: **18-2854-1 open** or **18-0476-1 blocked**



**18-1907
RISER (3" HOSE)**

Replaces: Barr 20-0100, Indmar 53-2009, 53-2018

Barr and Indmar Ford Small Block V8 302-351cu.in.

Use with:

Manifolds: **18-1997-1** or **18-1998-1**

Riser Gasket: **18-2854-1 open** or **18-0476-1 blocked**

Mounting Kit: **18-4364 open** or **18-8535 blocked**



**18-1939
RISER (3 1/2" HOSE)**

Replaces: Barr 20-0100, Marine Power 0992-593

Barr, Indmar and Marine Power Ford Small Block V8 302-351cu. in. GM

Small Block V8 305-350cu. in., GM Big Block V8 454cu in.

Use with:

Manifold: **18-1997-1, 18-1998-1**

Riser Gasket: **18-2854-1 open** or **18-0476-1 blocked**

Mounting Kit: **18-4364 open** or **18-8535 blocked**

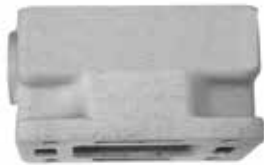

**18-1949
MANIFOLD SPACER (3")**

Barr CM 20-0097

Barr, Indmar and Marine Power Ford Small Block V8

302-351cu.in., GM Small Block V8 305-350cu.in.,

GM Big Block V8 454cu.in.

Used with:

Manifolds: **18-1998-1, 18-1997-1** and

18-1898



**18-4363
EXHAUST ELBOW KIT**

Replaces: Barr FM-1-83-P

Use with:

Manifold: **18-1998-1**



**18-4364 (Open)
EXHAUST ELBOW KIT**

Replaces:

Barr 20-0082-P

Use with:

Riser: **18-1999, 18-1907, 18-1939**



18-8535 (Blocked)
EXHAUST MANIFOLD MOUNTING KIT
 Barr, Indmar and Marine Power
 Ford Small Block V8 302-351cu.in., GM Small Block V8
 305-350cu.in., GM Big Block V8 454cu.in.
 Used with:
 Risers: 18-1939, 18-1999, and 18-1907



18-8536
EXHAUST ELBOW MOUNTING KIT
 Barr, Indmar and Marine Power GM Small Block V8
 305-350cu.in.
 Used with:
 Manifold: 18-1997-1



18-8538
EXHAUST MANIFOLD MOUNTING KIT
 Barr and Indmar Ford Small Block V8
 302-351cu.in.
 Used with:
 Manifold: 18-1998-1



18-0603
EXHAUST MANIFOLD GASKET SET
 For: Ford 302/351 CID Engines
 For use with 18-1998-1



18-0604
EXHAUST MANIFOLD GASKET SET
 For: GM 305/350 CID Engines
 For use with 18-1997-1



18-0183-1
EXHAUST MANIFOLD GASKET
 Replaces: Mercruiser 27-73866, 27-54566
 Volvo 3853742, 3852455
 OMC 908717
 Used with:
 Manifold: 18-1962-1, 18-1938,
 18-1998-1, 18-1996, 18-1979



18-0418
EXHAUST MANIFOLD GASKET
 Replaces: Mercruiser 27-46820
 Use with:
 Manifolds: 18-1957-2, 18-1982,
 18-1929, 18-1933, 18-1898



18-0476-1
RISER BLOCKOFF GASKET
 Replaces: Barr 01-0105
 Indmar & Marine Power
 Ford Small Block V8 302-351cu.in.
 Used with:
 Risers: 18-1939, 18-1999, 18-1907



PKG. OF 2
18-2854-1 (Open)
18-2854-9^①
EXHAUST ELBOW GASKET
 Replaces: Barr 01-0107
 Use with:
 Riser: 18-1999, 18-1939, 18-1907



PKG. OF 2
18-2949
18-2949-9^①
EXHAUST MANIFOLD GASKET
 Replaces: Barr CHV-47-000
 Use with:
 Manifold: 18-1997-1



18-4461
HOSE BARB
 Replaces: Mercruiser 22-807155
 3/4" - 14 NPT x 1" Hose
 Corrosion Resistant Brass Fitting



18-4258
PIPE PLUG
 Replaces: Mercruiser 22-33198, 22-33198A1,
 22-41622, 22-46754
 3/4" Thread size
 Blacksteel

^① Priced per Package

Sierra[®] High Performance

18-5466

**HI-PERFORMANCE
IGNITION COIL**

1.5 ohm (oil filled), black - 8 cylinder:
Flame-Thrower 40,000 volt coil.

- Designed for use with the original Ignitor Electronic Conversion Kits
- Can be used with other inductive ignition systems



18-5469

**HI-PERFORMANCE
IGNITION COIL**

3.0 ohm (oil filled), black - 4 & 6 cylinder:
Flame-Thrower 40,000 volt coil.

- Designed for use with the original Ignitor Electronic Conversion Kits
- Can be used with other inductive ignition systems



18-5472

**HI-PERFORMANCE
IGNITION COIL**

0.6 ohm (oil filled), black - 4, 6, & 8
cylinder: Flame-Thrower 45,000 volt coil.

- Super low 0.6 ohm resistance coil designed for use with the Ignitor II Hi Performance Electronic Conversion Kits
- Compatible with capacitive discharge systems



**18-8898
COIL**

High performance coil HV for Ignitor or points



**18-8899
COIL**

High performance coil HV for Ignitor II or Flamethrower

18-29716

**CHROME HIGH
OUTPUT COIL**

Replaces: Mallory 29716

Fits: Mallory 8 cylinder



18-29717

CHROME COIL

Replaces: Mallory 29217

Fits: Breaker Point ignition systems



18-28150

WIRE SEPARATOR / BLUE



18-28151

WIRE SEPARATOR / BLACK

PROMASTER[®] SERIES IGNITION COILS



18-29720

Replaces: Mallory 29440M

For use with Mallory UNILITE Ignition, Magnetic Breakerless Ignition and/or Electronic Advance Computer. Effective to 8000 RPM's. (External Resistor required)



18-29723

For use with Mallory UNILITE Ignition, Magnetic Breakerless Ignition and/or Electronic Advance Computer. Effective to 8000 RPM's. (Internally Resisted)

Our PROMASTER[®] Coil delivers higher performance through faster rise time and longer spark duration. A rugged, glass-filled polyester case and oil-filled construction ensure long life with no energy loss from arcing. All PROMASTER[®] Coils include threaded brass contact terminals and spark plug type secondary post for better coil wire retention. For use with Mallory UNILITE[®] Ignition, Magnetic Breakerless Ignition, and/or Electronic Advance Computer. Effective to 8000 RPM.

Sierra[®] High Performance



18-28175
WIRE MARKERS



18-5285
HI-PERFORMANCE
ELECTRONIC CONVERSION KIT
Fits: 4 Cylinder Delco Distributors



18-5286
HI-PERFORMANCE
ELECTRONIC CONVERSION KIT
Fits: 6 Cylinder Delco Distributors



18-5288
HI-PERFORMANCE
ELECTRONIC CONVERSION KIT
Fits: Most Prestolite V-8 Distributors with snap down cap



18-5289
HI-PERFORMANCE
ELECTRONIC CONVERSION KIT
Fits: Most Prestolite Distributors with screw down cap



18-5290
HI-PERFORMANCE
ELECTRONIC CONVERSION KIT
Fits: Most Mallory YL or YD 8 cylinder Distributors with clockwise and counter clockwise rotation



18-5477
ELECTRONIC DISTRIBUTOR
Fits: Ford 302 V-8 engines
Replacement Cap/Rotor Kit **18-5266**



18-5478
ELECTRONIC DISTRIBUTOR
Fits: Chrysler LA series V-8 engines



18-5479
ELECTRONIC DISTRIBUTOR
Fits: GM V-8 engines-reverse rotation



18-5480
COMPLETE IGNITION
CONVERSION KIT
Fits: GM SB & BB with Standard Deck Height



18-5481
HI-PERFORMANCE
ELECTRONIC DISTRIBUTOR
Fits: Ford V-8 351 Windsor
Replacement cap/rotor kit: **18-5266**



18-5482
HI-PERFORMANCE
ELECTRONIC DISTRIBUTOR
Fits: Ford V-8 351 Cleveland, 351M, 400, 429 and 460 engines. Replacement cap/rotor kit: **18-5266**

Sierra® High Performance



18-5483
HI-PERFORMANCE
ELECTRONIC DISTRIBUTOR

Fits: Chevrolet marine small and big block engines (standard deck height). Replacement cap/rotor kit: **18-5266**



18-5473
DISTRIBUTOR CAP

Black Distributor Cap with Male Terminals for Flamethrower Distributors



18-5474
DISTRIBUTOR CAP

Red Distributor Cap with Male Terminals for Flamethrower Distributors



18-6842
ALTERNATOR

Replaces: 983424, 836, 247
For: 37-63A Marine Applications

18-6975
ALTERNATOR (Universal)

Fits: High amp 160A alternator, universal mounting pattern based on Delco CS1300 design, v-belt and 6 groove serpentine pulley included



18-6834
STARTER

Replaces: GM Engines Universal
Used on all GM Engines with either 14 1/4" or 12 3/4" flywheels



18-6835
STARTER

Replaces: GM Engines Universal
3 terminal
Used on all GM Engines with either 14 1/4" or 12 3/4" flywheels



18-7751
CARB KIT

Replaces: Mercruiser 13220
Fits: GM 420 V8 454 (1987-89), GM 425 V8 454 (1990-93), GM 425 (Gen V) V8 454 (1992-93), 440 TRS GM 454 (1983-86), GM 450 V8 454 (1995-96), 460 TRS V8 482 (1983-86), GM 465 V8 502 (1990-92), GM 465 (Gen V) V8 502 (1992-94), 500 (Gen+) GM 502 V8 (1999), 500 (Gen V) 502 V8 (1994-98), 500 Bulldog 540 V8 (1990-01)



18-7637
CARBURETOR
(REMANUFACTURED)

(Gasket included)
600 CFM Holley 4V



18-7638
CARBURETOR
(REMANUFACTURED)

600 CFM Holley 4V-side inlet



18-7775
FILTER BRACKET
3/8" Aluminum



18-7776
FILTER BRACKET
3/8" Stainless Steel



18-7232
FLAME ARRESTOR
Replaces: Crusader 33628
Mercruiser 57882, 57882T

Sierra[®] High Performance



**18-7790
FUEL FILTER KIT**
Complete Kit Contains: Housing,
Replaceable Element & Fittings for
1/4", 5/16", & 3/8" Fuel Lines
Uses Filter 18-7791



**18-7945C
FUEL WATER SEPARATOR FILTER
(Chrome)**
Replaces: Mercury 35-802893Q
Yamaha ABB-FUELF-IL-TR



**18-7824C-2
OIL FILTER (Chrome)**
Short GM
Replaces:
Chris-Craft 16.81-08746
Crusader 201104, Indmar: 50-1001
Mercuriser 35-802885Q, 32716, 866340Q02, Q03,
866340K01
Mercuriser Vazer, OMC 173232, 502902
Pleasurecraft R077002
Volvo-Penta 835440
Yamaha YSC-10231-20-0C
Thread Spec: 13/16" x 16NPT



**18-7866
FUEL FILTER**
Replaces: Yamaha MAR-FUELF-IL-TR
High Capacity - 6"
10 Micron



**18-8114
FUEL LINE HOSE**
For fuel pump to carburetor connection. Replaces
copper or steel tubing 3/8" X 31" PTFE composite
hose with 5/8"-18 male inverted flare straight one
end, 5/8"-18 90° one end. SAE J1527 type A1



**18-8115
FUEL LINE HOSE**
For fuel pump to carburetor connection. Replaces
copper or steel tubing 3/8" X 25" PTFE composite
hose with 5/8"-18 male inverted flare straight one
end, 5/8"-18 90° one end. SAE J1527 type A1



**18-34110
ELECTRIC FUEL PUMP**
Replaces: Mallory 4110M
110GPH MARINE



**18-34120
ELECTRIC FUEL PUMP**
Replaces: Mallory 5110MFI
INJ 110GPH



**18-34140
ELECTRIC FUEL PUMP**
Replaces: Mallory 4140M
140GPH MARINE



**18-35101
FUEL PUMP
BLOCK-OFF PLATE SB CHEV**
Replaces: Mallory 5421
For: Chevrolet 265-400



**18-35102
FUEL PUMP
BLOCK-OFF PLATE BB CHEV**
Replaces: Mallory 5422
For: Chevrolet 396-502 & Ford 289-351W



**18-7332
ELECTRIC FUEL PUMP**
Includes bracket and mounting hardware
43 GPH - 7 PSI Max. - 1/4 NPSF for 3/8 hose
- operates with both gasoline and diesel fuel - 24 Volt only



18-35435
ELECTRIC FUEL PUMP
 Universal - 12V 2.5-4.5 psi @ 16.8 gph 1/8"
 Female Pipe Thread



18-35436
ELECTRIC FUEL PUMP
 Universal - 12V 5-9 psi @ 16.8 gph 1/8"
 Female Pipe Thread



18-7628
INTAKE MANIFOLD
 Small-block GM with vortec cylinder heads
 Brass lined water jackets for salt water applications



18-7489
WEBER 750 CARBURETOR

- Universal square flange mounting pattern
- High-luster polished exterior
- Electric choke
- Calibrated and flow-tested for mid to high range performance improvement and throttle response.



18-1989
THERMOSTAT HOUSING
 Replaces: Mercruiser 8M0061381, 861006A1
 Stainless Steel
 Use 18-1989K Thermostat Service Kit for replacement parts



18-1989K
THERMOSTAT SERVICE KIT
 Service Kit for 18-1989 Thermostat Housing



18-4506
GUIDE PLATES
 Big-Block GM with 5/16" pushrods



18-4507
ROCKER ARM KIT (4 VALVES)
 Big-Block GM



18-4508
HEAD BOLT KIT
 High performance head bolt kit-small block GM



18-4492
ROCKER ARM ASSEMBLY
 Replaces: Mercruiser 35329, F3746241, F11100014, F11100495
 Fits: MCM/MIE Gm V6 & V8(283, 305 & 350 cid) engines

CYLINDER HEAD ASSEMBLIES

*All cylinder heads are new castings and complete assemblies with new stainless steel valves, hardened steel exhaust seats, valve springs, valve locks and retainers.
All GM cylinder heads utilize high performance screw-in rocker arm studs in place of factory press in rocker arm studs.*



18-4485

CYLINDER HEAD ASSEMBLY

Replaces: MerCruiser 938-883490R1, 938-883490, 938-883490R50, 938-884741R, 938-884741R50

Fits: 5.7L V-8 GM (1987-95) with press in rocker arm studs with 12 intake manifold mounting bolts- (4 inside intake manifold bolts at 23 degrees), center mount valve covers



18-4485HP

CYLINDER HEAD ASSEMBLY

Fits: Mid GM small block 5.7L high performance.

Completely assembled with revised runner and combustion chambers. Add 30hp to stock motor with no additional modifications.



18-4486

CYLINDER HEAD ASSEMBLY

Replaces: MerCruiser 938-883297 1, 938-803860T, 938-883297R1

Fits: 5.7L V-8 GM Vortec (1996-Up) with press in rocker arm studs with 8 intake manifold mounting bolts, composite valve cover



18-4486HP

CYLINDER HEAD ASSEMBLY

Fits: Vortec GM small block 5.7L high performance

Completely assembled with revised runner and combustion chambers. Add 30hp to stock motor with no additional modifications.



18-4489

CYLINDER HEAD ASSEMBLY

Replaces: MerCruiser 936-810840/986767, 938-884739R01

Fits: 2.5L/3.0L GM (1968-95) (non MerCruiser LX models) (1968-95)



18-4484HP

CYLINDER HEAD ASSEMBLY

Fits: Early GM small block 5.7L high-performance

Completely assembled with revised runner and combustion chambers. Add 30hp to stock motor with no additional modifications.



18-4493HP

CYLINDER HEAD

Fits: Big-block GM cast iron performance



18-4491

CYLINDER HEAD ASSEMBLY

Replaces: MerCruiser 938-827178

Replaces 4.3L Vortec V-6 (1996-Up) with screw in rocker arm studs (non-adjustable valve train), 8 intake manifold mounting bolts, center mount valve cover. NOTE: not for use with engines using factory roller rocker arms.



18-4501
CYLINDER HEAD
Fits: 5.0L Vortec



18-4501HP
CYLINDER HEAD

Fits: Vortec GM small block 5.0L
Completely assembled with revised runner and combustion chambers. Add 30hp to stock motor with no additional modifications.



18-4503
CYLINDER HEAD (HIGH PERFORMANCE)

- Up to 60 HP increase over OE cylinder heads
- 5 angle valve seat cut
- Double drilled intake mounting
- For either standard 12 bolt GM intake or late-model 8 bolt Vortec intake
- Accepts both perimeter or center bolt valve covers
- Fits 5.7 & 6.2L small block GM V-8 applications
- OE look
- Corrosion resistance heavy-duty cast iron castings suitable for saltwater usage
- Intake Runner: 185cc
- Exhaust Runner: 62cc
- Combustion Chambers: 72cc
- Intake Stainless Steel Valves: 2.02
- Exhaust Stainless Steel Valves: 1.60
- Cast Iron Cylinder Heads: Sold in pairs only



18-4497
TIMING COVER
For: Small block GM-(1986-1995)



18-56870
TIMING COVER
Replaces: Mercury 59341A1
Fits: GM 3.0L w/ tin cover



18-4516
RING GEAR-FLYWHEEL
14" GM flywheel w/ 168 teeth



18-4517
RING GEAR-FLYWHEEL
12" GM flywheel w/ 153 teeth



18-4518
FLYWHEEL
14" 4.3L V-6, 1 piece main 1987 and up.
Bottom mount starter (Block mounted)
applications



18-4519
FLYWHEEL
14" 5.0/5.7L, 1 piece main 1987 and UP.
Bottom mount starter (Block mounted)
applications.



18-4521
FLYWHEEL
14" small-block GM, 2 piece main, pre 1987.
Bottom mount starter (Block mounted)
applications.



18-4522
FLYWHEEL
14" 454, Gen IV w/ 2 piece rear main.
Bottom mount starter (Block mounted)
applications.



18-4523
FLYWHEEL
14" 454, Gen V & VI w/ 1 piece rear main.
Bottom mount starter (Block mounted)
applications.



18-4726
VALVE SEAL
Fits: GM V-6 & V-8 engines



18-4727
VALVE SPRING
Fits: GM vortec style valve springs



18-4728
VALVE SPRING
Fits: GM standard style valve springs



18-4729
VALVE RETAINER, VORTEC
Fits: GM V-6 & V-8 engines



18-4730
VALVE RETAINER
Fits: GM V-6 & V-8 engines



18-4731
VALVE LOCK
Fits: GM V-6 & V-8 engines



18-4732
INTAKE VALVE (1.94")
Fits: GM V-6 & V-8 engines



18-4733
EXHAUST VALVE (1.50")
Fits: GM V-6 & V-8 engines



18-4734
INTAKE VALVE (1.84")
Fits: GM V-6 & V-8 engines



18-4735
INTAKE VALVE (2.02")
Fits: GM V-6 & V-8 engines



18-4736
EXHAUST VALVE (1.60")
Fits: GM V-6 & V-8 engines



18-4737
ROCKER ARM STUD
Fits: GM V-6 & V-8 engines



18-8962
VALVE COVER SET
For: 4.3L V-6 (1986 & Up) metal



18-8963
VALVE COVER SET
For: Small block GM (1986 & up)



BRASS FREEZE PLUG KITS
Eliminate any chance of rusted out freeze plugs with our Brass Freeze Plug Kits. Designed for marine applications. Kit includes all plugs needed for a complete engine.

Part No.	Application
18-56481	Chevrolet 265-400

EDELbrock® CARBURETORS



18-34080
600 CFM CARBURETOR
Fits: V-6 and small V-8 engines



18-34081
750 CFM CARBURETOR
Fits: Small and big-block GM engines



EDELbrock® INTAKE MANIFOLDS



18-34082
BRASS WATER INTAKE MANIFOLD
Fits: Small block GM, 1955-1986



18-34083
BRASS WATER INTAKE MANIFOLD
Fits: Small block GM, 1987-1995



18-34084
BRASS WATER INTAKE MANIFOLD
Fits: Big-block GM with oval port cylinder heads



EASY TO USE MODULAR GASKET KITS FOR FORD & CHEVROLET MARINE ENGINES

- For most popular marine versions of: Chevrolet In-line 4 & 6 cylinder V6 & V8 Engines and Ford 5.0 L & 5.8L V8 Engines
- Minimizes inventory investment to cover most major engine applications
- Maximizes inventory utilizations via mix and match system
- Utilizes generic type gasket kits common among all engine brands., (i.e. a 350CID (5.7L) Crusader & Mercruiser would use the same short block & valve grind gasket sets, but would use different exhaust manifold gasket kits)

CHEVY 4 cyl. 153/2.5L 1965-88 ③

CHEVY 4 cyl. 181/3.0L 1973-84 ③

CHEVY 4 cyl. 181/3.0L 1985-89 (4 cyl. 181/3.0L HO 1990-98 ③)

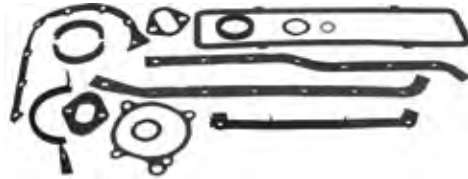

18-1271 ① ③
SHORT BLOCK GASKET SET

— CONTAINS —

Description	Part #
Oil Pan Gasket	18-0466
Forward Crankshaft Seals	18-1213
Rear Crankshaft Seals	18-1211
Push Rod Cover	18-0328
Water Pump Gasket	18-0327
Fuel Pump Mounting Gasket	18-0889
Fuel Pump Mounting Gasket	NSS
Cam Gear Cover Gasket	18-0887
Distributor Mounting Gasket	18-0948
Distributor Mounting Gasket	18-0874

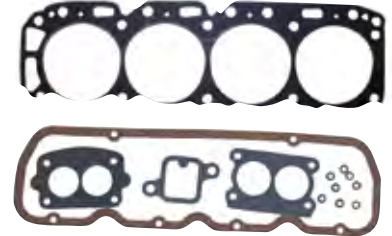

18-1274
HEAD GASKET SET

— CONTAINS —

Description	Part #
Head Gasket	18-2946
Mercarb Mounting Gasket	18-0994
Carb. Mounting Gasket	18-0356
Thermostat Housing Gasket	18-0164
Valve Cover Gasket	18-0347
Valve Stem Seals (8)	18-0518

GM 4 cyl. 3.0L

18-1206
SHORT BLOCK GASKET SET

— CONTAINS —

Description	Part #
Front Crankshaft Seal	18-1213
Rear Crankshaft Seal	18-0519
Fuel Pump Mounting Gasket	18-0889
Fuel Pump Mounting Gasket	NSS
Push Rod Cover Gasket	18-2815
Distributor Mounting Gasket	18-0874
Distributor Mounting Gasket	18-0948
Timing Cover Gasket	18-0887
Water Pump Gasket	18-0327



4 cyl. 3.7L Mercruiser 470

18-1276
SHORT BLOCK GASKET SET

— CONTAINS —

Description	Part #
Oil Seal	18-2014
Mounting Gasket	NSS
Distributor Mounting Gasket	18-0874
Fuel Pump Mounting Gasket	18-0889
O-Ring	NSS
Water Pump Seal	18-0172
O-Ring	18-7145
Oil Pan Gasket	18-4366
Water Pump Timer Cover Gasket	NSS

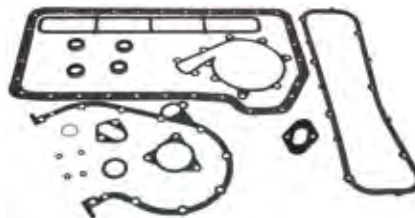

18-1277
HEAD GASKET SET

— CONTAINS —

Description	Part #
Intake Gasket	18-0158
Quadrajel Gasket	18-2848
Valve Grind Cover Gasket	NSS
Head Gasket	18-3878
Exhaust Manifold Mounting Gasket	18-0956-1
Valve Seal	NSS

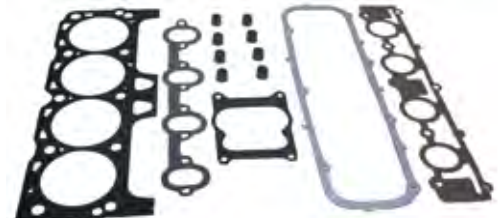

① Except models with cast push rod cover

② Does not include intake and/or exhaust manifold gaskets

③ For models with 1 piece rear main seal use 18-1206

NSS Not Sold Separately

CHEVY 6 Cyl. 250/4.1L



18-1255

SHORT BLOCK GASKET SET

(24 Bolt Pan Only)

— CONTAINS —

Description	Part #
Oil Pan Gasket	18-0340
Forward Crankshaft Seals	18-1213
Rear Crankshaft Seals	18-1211
Push Rod Cover	18-0329
Water Pump Gasket	18-0327
Fuel Pump Mounting Gasket	18-0889
Timing Gear Cover Gasket	18-0887
Distributor Mounting Gasket	18-0874

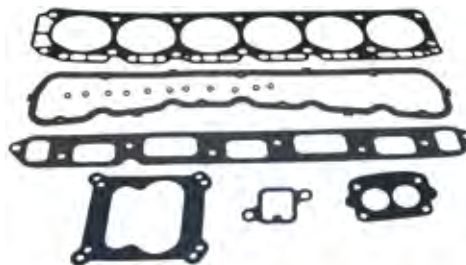

18-1264

HEAD GASKET SET

— CONTAINS —

Description	Part #
Head Gasket	18-3881
4BBL Carb Mounting Gasket	NSS
2BBL Carb Mounting Gasket	18-0356
Exhaust Manifold Gasket	18-2830-1
T-Stat Hsg. Mounting Gasket	18-0164
Valve Cover Gasket	18-0346
Valve Stem Seals (8)	18-0518

CHEVY V-6 229/3.8L AND 4.3L (thru 1985)



18-1270 *

SHORT BLOCK GASKET SET

— CONTAINS —

Description	Part #
Oil Pan Gasket	18-0405
Oil Drain Screw Gasket	18-0905
Forward Crankshaft Seals	18-1213
Rear Crankshaft Seal	18-0519
Crankshaft Seal Retainer	18-0322
Water Pump Mounting Gasket	18-0891
Fuel Pump Plate Gasket	NSS
Fuel Pump Mounting Gasket	18-0889
Timing Chain Cover Gasket	18-0976
Timing Chain Cover Gasket	NSS

* Requires Rear Crankshaft Seal

(Not Included) in addition to short block kit

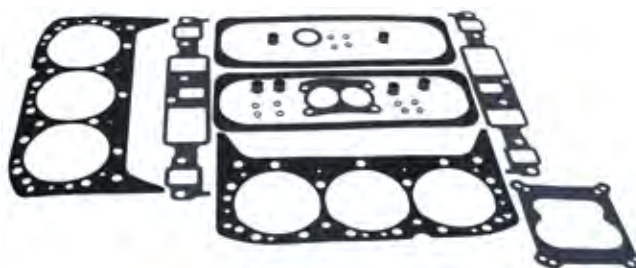

18-1275 ①

HEAD GASKET SET

— CONTAINS —

Description	Part #
Head Gasket	18-3879
2BBL Carb Mounting Gasket	18-0994
4BBL Carb Mounting Gasket	18-0463
Intake Manifold Gasket	18-4408
Valve Cover Gasket	18-0311
Valve Stem Seals (6)	18-4024
Valve Stem Seals (12)	18-0518
Distributor Mounting Gasket	18-0874

CHEVY V-6 262/4.3L - 1 Piece Rear Seal
CHEVY V-6 262/4.3L GEN II - 1 Piece Rear Seal
 1986-1995



18-1270

SHORT BLOCK GASKET SET

— CONTAINS —

Description	Part #
Oil Pan Gasket	18-0405
Oil Drain Screw Gasket	18-0905
Forward Crankshaft Seals	18-1213
Rear Crankshaft Seal	18-0519
Crankshaft Seal Retainer	18-0322
Water Pump Mounting Gasket	18-0891
Fuel Pump Plate Gasket	NSS
Fuel Pump Mounting Gasket	NSSFuel Pump
Timing Chain Cover Gasket	18-0889
Timing Chain Cover Gasket	18-0976
Timing Chain Cover Gasket	NSS

* Requires Rear Crankshaft Seal

(Not Included) in addition to short block kit



18-1278

HEAD GASKET SET

— CONTAINS —

Description	Part #
Head Gasket	18-3879
2BBL Carb Mounting Gasket	18-0994
4BBL Carb Mounting Gasket	18-0463
Valve Stem Seals (6)	18-4024
Valve Stem Seals (12)	18-0518
Distributor Mounting Gasket	18-0874
Intake Gasket Set	18-1238
Valve Cover Gasket (2)	18-0311

① Does not include oil pan gasket

② Does not include intake and/or exhaust manifold gaskets

NSS Not Sold Separately

CHEVY V-8 305/5.0L
2 Piece Rear Seal
thru 1985



18-1265

SHORT BLOCK GASKET SET
Port Dip Stick Models ONLY
Left Hand (Standard Rotation)
— CONTAINS —

Description	Part #
Oil Pan Gasket	18-0153
Oil Drain Screw Gasket	18-0905
Oil Filter Gasket	18-0185
Forward Crankshaft Seal	18-1213
Rear Crankshaft Seal	18-1211
Water Pump Mounting Gasket	18-0891
Water Pump Plate Gasket	NSS
Fuel Pump Plate Gasket	18-0876
Fuel Pump Mounting Gasket	18-0889
Timing Chain Cover Gasket	18-0976
Vent Adapter Gasket	NSS



18-1266 ②

HEAD GASKET SET
— CONTAINS —

Description	Part #
Head Gasket	18-3876
2BBL Carb Mounting Gasket	18-0994
4BBL Carb Mounting Gasket	18-0463
4BBL Carb Mounting Gasket	18-0462
Intake Manifold Gasket	18-0868
Valve Cover Gasket (2)	18-2845
Valve Stem Seals (8)	18-4024
Valve Stem Seals (16)	18-0518
Distributor Mounting Gasket	18-0874

CHEVY V-8 305/5.0L (Right Hand Rotation)
2 Piece Rear Seal
thru 1985

18-1266 ②

HEAD GASKET SET
— CONTAINS —

Description	Part #
Head Gasket	18-3876
2BBL Carb Mounting Gasket	18-0994
4BBL Carb Mounting Gasket	18-0463
4BBL Carb Mounting Gasket	18-0462
Intake Manifold Gasket	18-0868
Valve Cover Gasket (2)	18-2845
Valve Stem Seals (8)	18-4024
Valve Stem Seals (16)	18-0518
Distributor Mounting Gasket	18-0874

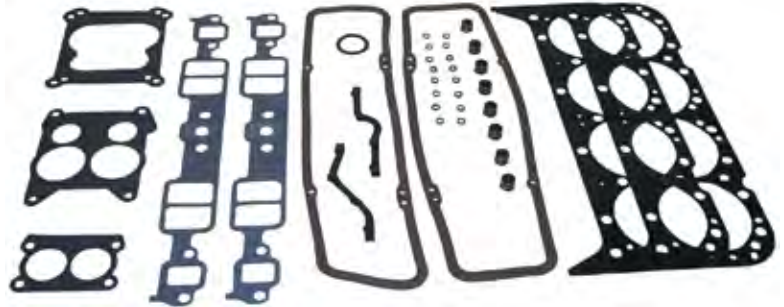

CHEVY V-8 305/5.0L GEN II
1 Piece Rear Seal
1986-1995

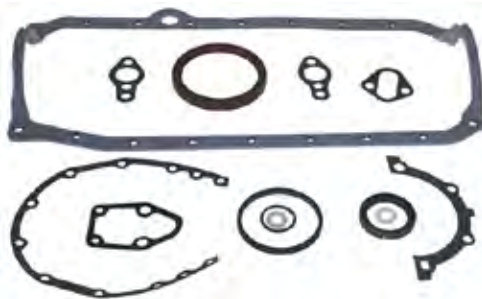

18-1268

SHORT BLOCK GASKET SET
— CONTAINS —

Description	Part #
Oil Pan Gasket	18-1237
Oil Drain Screw Gasket	18-0905
Oil Filter Gasket	18-0185
Forward Crankshaft Seal	18-1213
Rear Crankshaft Seal	18-0519
Rear Main Bearing Gasket	18-0322
Water Pump Mounting Gasket	18-0891
Water Pump Plate Gasket	NSS
Fuel Pump Plate Gasket	18-0976
Fuel Pump Mounting Gasket	18-0889



18-1267 ②

HEAD GASKET SET
— CONTAINS —

Description	Part #
Head Gasket	18-3876
2BBL Carb Mounting Gasket	18-0994
4BBL Carb Mounting Gasket	18-0463
4BBL Carb Mounting Gasket	18-0462
Intake Manifold Gasket Set	18-0868
Valve Cover Gasket (2)	18-0664
Valve Stem Seals (8)	18-4024
Valve Stem Seals (16)	18-0518
Distributor Mounting Gasket	18-0874

① Does not include oil pan gasket

② Does not include intake and/or exhaust manifold gaskets

NSS Not Sold Separately

**CHEVY V-8 305/5.0L GEN II (Right Hand Rotation)
1 Piece Rear Seal
1986-1995**



18-1263 ①
SHORT BLOCK GASKET SET
— CONTAINS —

Description	Part #
Oil Drain Screw Gasket	18-0905
Oil Filter Gasket	18-0185
Forward Crankshaft Seal	18-1213
Rear Main Bearing Gasket	18-0322
Water Pump Mounting Gasket	18-0891
Water Pump Backing Plate Gasket	18-0893
Water Pump Plate Gasket	NSS
Fuel Pump Plate Gasket	18-0876
Fuel Pump Mounting Gasket	18-0889
Timing Chain Cover Gasket	18-0976



18-1267 ②
HEAD GASKET SET
— CONTAINS —

Description	Part #
Head Gasket	18-3876
2BBL Carb Mounting Gasket	18-0994
4BBL Carb Mounting Gasket	18-0463
4BBL Carb Mounting Gasket	18-0462
Intake Manifold Gasket Set	18-0868
Valve Cover Gasket (2)	18-0664
Valve Stem Seals (8)	18-4024
Valve Stem Seals (16)	18-0518
Distributor Mounting Gasket	18-0874

**CHEVY V-8 350/5.7L
2 Piece Rear Seal
thru 1985**



18-1265 *
SHORT BLOCK GASKET SET
Port Dip Stick Models ONLY
Left Hand (Standard Rotation)
— CONTAINS —

Description	Part #
Oil Pan Gasket	18-0153
Oil Drain Screw Gasket	18-0905
Oil Filter Gasket	18-0185
Forward Crankshaft Seal	18-1213
Rear Crankshaft Seal	18-1211
Water Pump Mounting Gasket	18-0891
Water Pump Plate Gasket	NSS
Fuel Pump Plate Gasket	18-0876
Fuel Pump Mounting Gasket	18-0889
Timing Chain Cover Gasket	18-0976
Vent Adapter Gasket	NSS

* Except Stbd Dip Stick models



18-1266 ②
HEAD GASKET SET
— CONTAINS —

Description	Part #
Head Gasket	18-3876
2BBL Carb Mounting Gasket	18-0994
4BBL Carb Mounting Gasket	18-0463
4BBL Carb Mounting Gasket	18-0462
Intake Manifold Gasket	18-0868
Valve Cover Gasket (2)	18-2845
Valve Stem Seals (8)	18-4024
Valve Stem Seals (16)	18-0518
Distributor Mounting Gasket	18-0874

**CHEVY V-8 350/5.7L (Right Hand Rotation)
2 Piece Rear Seal
thru 1985**

18-1266 ②
HEAD GASKET SET
— CONTAINS —

Description	Part #
Head Gasket	18-3876
2BBL Carb Mounting Gasket	18-0994
4BBL Carb Mounting Gasket	18-0463
4BBL Carb Mounting Gasket	18-0462
Intake Manifold Gasket	18-0868
Valve Cover Gasket (2)	18-2845
Valve Stem Seals (8)	18-4024
Valve Stem Seals (16)	18-0518
Distributor Mounting Gasket	18-0874

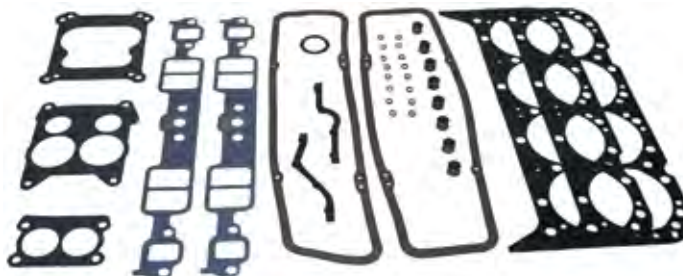

① Does not include oil pan gasket

② Does not include intake and/or exhaust manifold gaskets

NSS Not Sold Separately

CHEVY V-8 350/5.7L GEN II
1 Piece Rear Seal
1986-1995



18-1267^②

HEAD GASKET SET

— CONTAINS —

Description	Part #
Head Gasket	18-3876
2BBL Carb Mounting Gasket	18-0994
4BBL Carb Mounting Gasket	18-0463
4BBL Carb Mounting Gasket	18-0462
Intake Manifold Gasket Set	18-0868
Valve Cover Gasket (2)	18-0664
Valve Stem Seals (8)	18-4024
Valve Stem Seals (16)	18-0518
Distributor Mounting Gasket	18-0874

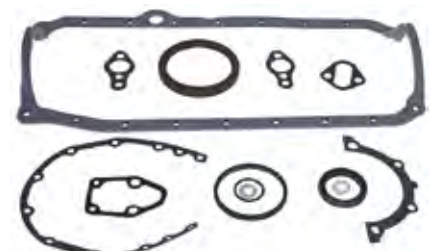

18-1268

SHORT BLOCK GASKET SET

— CONTAINS —

Description	Part #
Oil Pan Gasket	18-1237
Oil Drain Screw Gasket	18-0905
Oil Filter Gasket	18-0185
Forward Crankshaft Seal	18-1213
Rear Crankshaft Seal	18-0519
Rear Main Bearing Gasket	18-0322
Water Pump Mounting Gasket	18-0891
Water Pump Plate Gasket	NSS
Fuel Pump Plate Gasket	18-0976
Fuel Pump Mounting Gasket	18-0889
Timing Chain Cover Gasket	18-0468

CHEVY V-8 350/5.7L GEN II (Right Hand Rotation)
1 Piece Rear Seal
1986-1995



18-1263^①

SHORT BLOCK GASKET SET

— CONTAINS —

Description	Part #
Oil Drain Screw Gasket	18-0905
Oil Filter Gasket	18-0185
Forward Crankshaft Seal	18-1213
Rear Main Bearing Gasket	18-0322
Water Pump Mounting Gasket	18-0891
Water Pump Plate Gasket	NSS
Fuel Pump Plate Gasket	18-0876
Fuel Pump Mounting Gasket	18-0889
Timing Chain Cover Gasket	18-0468



18-1267^②

HEAD GASKET SET

— CONTAINS —

Description	Part #
Head Gasket	18-3876
2BBL Carb Mounting Gasket	18-0994
4BBL Carb Mounting Gasket	18-0463
4BBL Carb Mounting Gasket	18-0462
Intake Manifold Gasket Set	18-0868
Valve Cover Gasket (2)	18-0664
Valve Stem Seals (8)	18-4024
Valve Stem Seals (16)	18-0518
Distributor Mounting Gasket	18-0874

CHEVY V-8 454/7.4L



18-1256 *

SHORT BLOCK GASKET SET

— CONTAINS —

Description	Part #
Oil Pan Gasket	18-0348
Oil Drain Screw Gasket	18-0905
Forward Crankshaft Seal	18-1233
Rear Crankshaft Seal	18-0520
Water Pump Mounting Gasket	18-0903
Fuel Pump Mounting Gasket	18-0889
Timing Cover Gasket	18-0980

* Right Hand Rotation
Engines Require



18-1257^②

VALUE GRIND GASKET SET

— CONTAINS —

Description	Part #
Head Gasket	18-3877
Carb Mounting Gasket	NSS
Carb Mounting Gasket	NSS
Carb Mounting Gasket	NSS
Intake Manifold Gasket Set	NSS
Valve Cover Gasket (2)	NSS
Valve Stem Seals (16)	NSS
Distributor Mounting Gasket	18-0874

① Does not include oil pan gasket

② Does not include intake and/or exhaust manifold gaskets

NSS Not Sold Separately

CHEVY V-8 454/7.4L w/Square Ports



18-1256 *
SHORT BLOCK GASKET SET
 — CONTAINS —

Description	Part #
Oil Pan Gasket	18-0348
Oil Drain Screw Gasket	18-0905
Forward Crankshaft Seal	18-1233
Rear Crankshaft Seal	18-0520
Water Pump Mounting Gasket	18-0903
Fuel Pump Mounting Gasket	18-0889
Timing Cover Gasket	18-0980

* Right Hand Rotation Engines Require

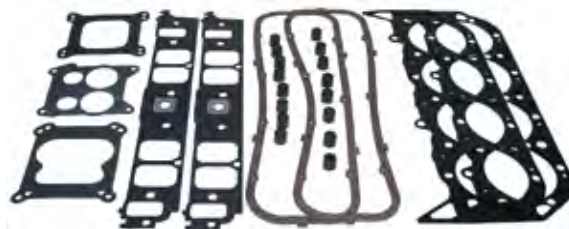

18-1259 ②
HEAD GASKET SET
 — CONTAINS —

Description	Part #
Head Gasket	18-3877
Carb Mounting Gasket	18-0467
Carb Mounting Gasket	18-0463
Carb Mounting Gasket	18-0462
Intake Manifold Gasket Set	18-1231
Valve Cover Gasket (2)	18-0464
Valve Stem Seals (16)	18-4024
Distributor Mounting Gasket	18-0874

CHEVY V-8 454/7.4L GEN V
CHEVY V-8 454/7.4L GEN V (w/square ports)
CHEVY V-8 502/8.2L GEN V

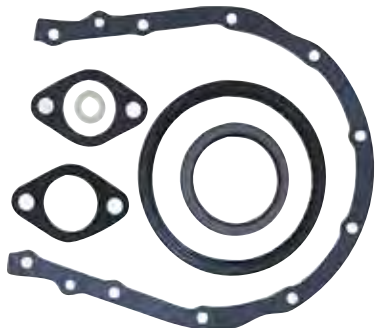

18-1261 ①
TIMING CHAIN GASKET SET
 — CONTAINS —

Description	Part #
Oil Drain Screw Gasket	18-0905
Forward Crankshaft Seals	18-1233
Rear Crankshaft Seals	18-1234
Water Pump Mounting Gasket	18-0903
Timing Cover Gasket	18-0468



18-1258 ②
VALVE GRIND GASKET SET
 — CONTAINS —

Description	Part #
Head Gasket	18-3874
Carb Mounting Gasket	18-0467
Carb Mounting Gasket	18-0463
Carb Mounting Gasket	18-0462
Intake Manifold Gasket Set	NSS
Valve Stem Seals (16)	NSS
Distributor Mounting Gasket	18-0874

CHEVY V-8 502/8.2L

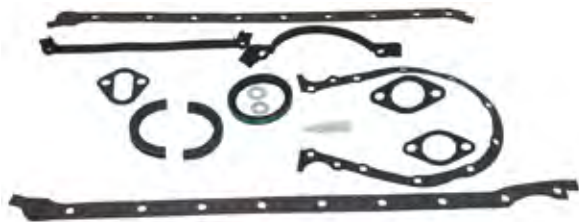

18-1256 *
SHORT BLOCK GASKET SET
 — CONTAINS —

Description	Part #
Oil Pan Gasket	18-0348
Oil Drain Screw Gasket	18-0905
Forward Crankshaft Seal	18-1233
Rear Crankshaft Seal	18-0520
Water Pump Mounting Gasket	18-0903
Fuel Pump Mounting Gasket	18-0889
Timing Cover Gasket	18-0980

* Right Hand Rotation Engines Require



18-1259 ②
HEAD GASKET SET
 — CONTAINS —

Description	Part #
Head Gasket	18-3873
Carb Mounting Gasket	18-0467
Carb Mounting Gasket	18-0463
Carb Mounting Gasket	18-0462
Intake Manifold Gasket Set	18-1231
Valve Cover Gasket (2)	18-0464
Valve Stem Seals (16)	18-4024
Distributor Mounting Gasket	18-0874

① Does not include oil pan gasket

② Does not include intake and/or exhaust manifold gaskets

NSS Not Sold Separately

18-1273 ②

HEAD GASKET SET

— CONTAINS —

Description	Part #
Head Gasket (2)	18-3883
4BBL Carb Mounting Gasket	18-0357
2BBL Carb Mounting Gasket	18-0360
Intake Manifold Gasket Set	18-0410
Valve Cover Gasket (2)	18-0352
Valve Stem Seals (16)	18-4023

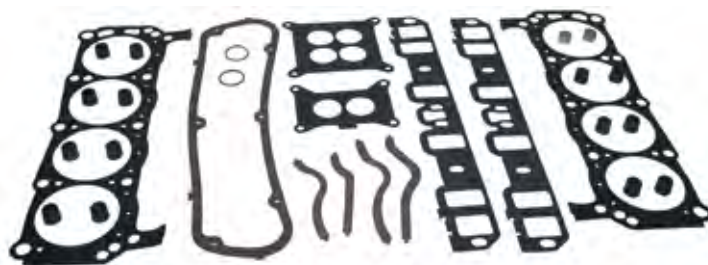

FORD V-8 351/5.8L 1977-93

18-1273 ②

HEAD GASKET SET

— CONTAINS —

Description	Part #
Head Gasket (2)	18-3883
4BBL Carb Mounting Gasket	18-0357
2BBL Carb Mounting Gasket	18-0360
Intake Manifold Gasket Set	18-0410
Valve Cover Gasket (2)	18-0352
Valve Stem Seals (16)	18-4023

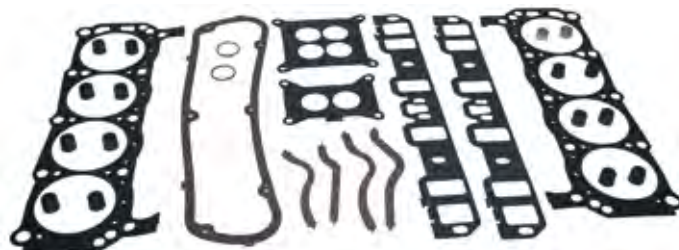

① Does not include oil pan gasket

② Does not include intake and/or exhaust manifold gaskets

NSS Not Sold Separately

MODULAR GASKET APPLICATION

Engine/Model	Years	Serial No.	Short Block	Valve Grind Kit
Chevy 153-2.5L	1965-85	3377341-6229717 ⑤ ②	18-1271	18-1274
Chevy 153/2.5L	1986-88	6229718 & Up ⑤ ②	18-1271	18-1274
Chevy 181/3.0L	1973-84	3332137-6229717 ⑤ ② ⑤	18-1271	18-1274
Chevy 181/3.0L	1985-96	6229718 & Later ⑤ ② ⑤	N/A	18-1274
Chevy 181/3.0LX	1990-97	C856559 & Later ① ⑤ ②	N/A	18-1274
Mercury 165/3.7L (4 Cyl.)	1987-89	6916779 & Later ⑦ ④	18-1276	18-1277
Mercury 170 (4 Cyl.)	1985-86	6916779 & Later ③	18-1276	18-1277
Mercury 180/3.7L-LX (4 Cyl.)	1987-89	6916779 & Later ③	18-1276	18-1277
Mercury 190 (4 Cyl.)	1985-86	6916779 & Later ③	18-1276	18-1277
Mercury 470	1976-82	4208730-6218036 ③	18-1276	18-1277
Mercury 470	1983-84	6218037-6916778 ③	18-1276	18-1277
Mercury 485	1980-82	5685394-6218036 ③	18-1276	18-1277
Mercury 488	1983-84	6170297-6916778 ③	18-1276	18-1277
Chevy 229/3.8L	1983-84	6330183-6919655 ② ⑤	18-1270	18-1275
Chevy L6 250/4.1L	1970-81	2770032-5813433 ⑤	18-1255	18-1264
Chevy 262/4.3L (2Pc. Rm Seal)	1985	6919656-B455459 ⑤	N/A	18-1275
Chevy 262/4.3L (2Pc. Rm Seal)	1986-92	A483581 ① ⑤	18-1270	18-1275

- ① Full circle rear crankshaft seal, one piece oil pan gasket
- ② 3.8L models require 18-1211 rear crank seal and 18-0362 oil pan gasket
- ③ Starboard dip stick models require 18-0411 oil pan gasket set
- ④ Four piece oil pan set
- ⑤ Head & valve cover gaskets included in valve grind kit

- ⑦ Intake/exhaust manifold gasket included in kit
- ⑧ Rear main crankshaft seal also required
- ① Crankshaft seals also required
- ② Models with cast push rod cover require 18-0328
- ④ Crankshaft seals not included in short block kit
- ④ Use 18-4349 for serial no.6218462-B525981
- ⑤ For models with one piece rear main seal use 18-1206 kit

MODULAR GASKET APPLICATION

Engine/Model	Years	Serial No.	Short Block	Valve Grind Kit
Chevy 262/4.3L Gen II	1992	D714370-F802999 ① ⑤	18-1270	18-1278
Chevy 262/4.3L Gen II	1993-96	D714370-F802999 ① ⑤	18-1270	18-1278
Chevy 305/5.0L	1977-85	4762210-B525981 ③ ⑤	18-1265	18-1266
Chevy 305/5.0L (Rev. Rota.)	1977-85	4762210-B525981 ③ ⑤	—	18-1266
Chevy 305/5.0L (1 Pc. Rm Seal)	1986	A482027-B525981 ① ⑤	18-1258	18-1266
Chevy 305/5.0L (Rev. Rota.) (1 Pc. Rm Seal)	1986	A482027-B525981 ① ⑤	18-1263	18-1266
Chevy 305/5.0L	1987-95	B525982 & Later ① ⑤ ⑧	18-1268	18-1267
Chevy 305/5.0L Inboard	1987-95	B522506 & Later ① ⑤ ⑧	18-1268	18-1267
Chevy 305/5.0L (Rev.Rota) Inboard	1987-95	B522506 & Later ① ⑤	18-1263	18-1267
Chevy 350/5.7L	1975-86	4175500-B525982 ③ ⑤ ④	18-1265	18-1266
Chevy 350/5.7 Inboard	1975-86	4498701-B522506 ③ ⑤	18-1265	18-1266
Chevy 350/5.7 (Rev.Rota) Inboard	1975-86	4498701-B522506 ③ ⑤	—	18-1266
Chevy 350/5.7L (1Pc. Rm Seal)	1986	6218462-B522506 ① ⑤	18-1268	18-1266
Chevy 350/5.7L (1Pc. Rm Seal) Inboard	1986	A492879-B522506 ① ⑤	18-1268	18-1266
Chevy 350/5.7L (Rev.Rota)(1 Pc. Rm Seal)	1986	A492879-B522506 ① ⑤	18-1263	18-1266
Chevy 350/5.7L	1987-95	B525982 & Later ① ⑤ ⑧	18-1268	18-1267
Chevy 350/5.7L	1996-97	B525982 & Later ① ⑤ ⑧	18-1268	18-1267
Chevy 350/5.7L Inboard	1987-95	B522506 & Later ① ⑤	18-1263	18-1267
Chevy 350/5.7L Inboard	1996-97	B522506 & Later ① ⑤	18-1263	18-1267
Chevy 350/5.7L (Rev.Rota.) Inboard	1987-95	B522506 & Later ① ⑤	18-1263	18-1267
Chevy 350/5.7L (Rev. Rota.) Inboard	1996-97	B522506 & Later ① ⑤	18-1263	18-1267
Chevy 454/7.4L	1977-92	4623115-D937001 ⑤	18-1256	18-1257
Chevy 454/7.4L Inboard	1977-92	4623110 & Later ⑤	18-1256	18-1257
Chevy 454/7.4L (Rev.Rota.) Inboard	1977-92	4623110 & Later ⑤ ⑧	18-1256	18-1257
Chevy 454/7.4L (Sq. Ports)	1988-91	B721206-D805068 ⑤	18-1256	18-1259
Chevy 454/7.4L Gen V	1992-94	D603118 & Later ⑤	18-1261	18-1258
Chevy 454/7.4L Gen V	1995-97	D603118 & Later ⑤	18-1261	18-1258
Chevy 454/7.4L Gen V Inboard	1992-94	D715494 & Later ⑤	18-1261	18-1258
Chevy 454/7.4L Gen V Inboard	1995-97	D715494 & Later ⑤	18-1261	18-1258
Chevy 454/7.4L Gen V (Sq. Ports)	1992-94	D805069 & Later ⑤	18-1261	—
Chevy 454/7.4L Gen V (Sq. Ports)	1995-97	D805069 & Later ⑤	18-1261	—
Chevy 502/8.2L	1990-92	C84992-F213244 ⑤	18-1256	18-1259
Chevy 502/8.2L Inboard	1990-92	C878221-D857199 ⑤	18-1256	18-1259
Chevy 502/8.2L Gen V	1993-97	D824589 & Later ⑤	18-1261	—
Chevy 502/8.2L Gen V Inboard	1993-97	D857200 & Later ⑤	18-1261	—
Ford 302/5.0L	1971-77	3108723-4887829 ④ ⑤	—	18-1273
Ford 351/5.8L	1975-77	4173000-4902304 ④ ⑤	—	18-1273
Ford 351/5.8L (Rev. Rota.)	1975-77	4173000-4902304 ④ ⑤ ①	—	18-1273

- ① Full circle rear crankshaft seal, one piece oil pan gasket
- ② 3.8L models require 18-1211 rear crank seal and 18-0362 oil pan gasket
- ③ Starboard dip stick models require 18-0411 oil pan gasket set
- ④ Four piece oil pan set
- ⑤ Head & valve cover gaskets included in valve grind kit

- ⑦ Intake/exhaust manifold gasket included in kit
- ⑧ Rear main crankshaft seal also required
- ① Crankshaft seals also required
- ② Models with cast push rod cover require 18-0328
- ③ Crankshaft seals not included in short block kit
- ④ Use 18-4349 for serial no.6218462-B525981
- ⑤ For models with one piece rear main seal use 18-1206 kit



18-5982
ALTERNATOR
 Replaces: Cummins 216040, 3604234RX
 Fits: Cummins Diesel Marine



18-6846
ALTERNATOR
 Replaces: Volvo Penta 1502272, 3803270-2, 5001677, 845940, 72021, 872022, 872757, 873635, 873757, 873757-9, 873771



18-6849
ALTERNATOR
 Replaces: Yanmar 119773-77200
 Denso 101211-9940
 Fits: Yanmar Engines



18-6925
ALTERNATOR
 Replaces: Yanmar 128270-77200
 Hitachi LR135-105
 Fits: Yanmar Marine 3GM Engines



18-6926
ALTERNATOR
 Replaces:
 Yanmar 119836-77200, -2, -3, 129612-77230
 Fits: 3TNE84 3cyl diesel, 3TNE88 3cyl diesel, 4TNE84 4cyl, 1.995L, 4TNE88 4cyl, 2.190L



18-6927
ALTERNATOR
 Replaces: Yanmar 128171-77200
 Fits: Yanmar GM Engines



18-6928
ALTERNATOR
 Replaces: Yanmar 128170-77200, 77201, 77202
 Hitachi LR135-74, 74B
 Fits: 3HM, 3HMF models



18-6929
ALTERNATOR
 Replaces: Yanmar 119573-77200, 77201, 129470-77200
 Hitachi LR180-03A, B, C
 Fits: Yanmar LH Engines



18-6952
ALTERNATOR
 Replaces: Cummins 214169, 3603853RX, 3920618, 10459244
 Delco 1100077, 93, 1100211, 74, 1105474, 75, 76



18-6953
ALTERNATOR
 Replaces: Volvo 3803645, 8602629, 8602710, 14 8676496, 98, 8676499
 Fits: Diesel D3 Models



18-6955
ALTERNATOR
 Replaces: Caterpillar 3001117, 10-258
 Prestolite 110-258, 110-258A
 Volvo 849748-9
 Fits: Volvo Diesel 6 cylinder models



18-6970
ALTERNATOR
 Replaces:
 Yanmar 129470-77200
 Fits: 2GM series, 3HM Series & 4JM engines



18-6971
ALTERNATOR
 High Amp version of 18-6970 (120A)



18-6948
ALTERNATOR
 Replaces: Mercury 882571
 Fits: CMD 1.7 MI 120 I/L4, CMD 1.7 MS 120 I/L4, D1.7L DTI

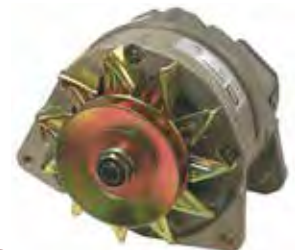

18-5975
ALTERNATOR
 Replaces: Perkins 2871A651
 Valeo 2939590, Motorola 9AR3959G, 3855G, 6000G, 510-845, -860, -864
 28 Volt. 45 AMP
 For: Perkins Marine Engine: 6-354-4, SAEJ1171



**18-6880
STARTER**
3 Bolt Flange
Replaces: Yanmar 123500-77010,
124610-77010, -77019 424610-77010
Hitachi S114-257, 257G, 483, 483A



**18-6930
STARTER**
Replaces: Yanmar 104211-77010, 77011



**18-6931
STARTER**
Replaces: Yanmar 119209-77010, 121120-77010,
77011, 77012, 124520-77010, 77011
Fits: 3 TNV-84-T engines



**18-6932
STARTER**
Replaces: Yanmar 121370-77010,
129242-77010, 129698-77010
Fits: 2QM, 3JH3, 3JH3E, 3JH3E-YEU, 3QM, 3QM30,
3QM30F, 3QM30H, 4JH3E



**18-6934
STARTER**
2 Bolt Flange
Replaces: Yanmar 129573-77010, 171008-77010
Hitachi S13-68, 68A, 68C, 86
Fits: Engine Model 2TR16, 2TR19



**18-6935
STARTER**
Replaces: Yanmar 119225-77010, 77011,
119226-77010
Fits: 3TN63, 3TN66, 3TN68



**18-6936
STARTER**
Replaces: Yanmar 114361-77011,
114362-77010, 77011, 114399-77010
Fits: L40S, L60S



**18-6937
STARTER**
2 Bolt Flange
Replaces: Yanmar 128170-77010,
77010D **Hitachi** S114-303, 303A
Fits: GM, GM2, GM3, GM10, GM20/2-
20F, GM30, GMF, 1GM, 2GM, 3GM



**18-6938
STARTER**
Replaces: Yanmar 119773-77010
Fits: 6LP-DTE, 6LP-STE Diesel models



**18-6872
STARTER**
12 Volt
Replaces: Volvo 233991, 240501,
837924, 842775, 843511, 847306-8,
881681
Fits: TAMD, MD, AQD Models



**18-6939
STARTER**
Replaces:
Yanmar 121254-77010, 77011,
77012, 77019, 129429-77010, 77011



**18-6944
STARTER**
Replaces:
Bosch 0-001-109-035
Caterpillar 163-3361
Perkins 185086600
Volvo 21323043, 3583555
Fits: 2001-07 D2-55A, B, C, 2003-07 D2-
75A, 4 cyl 134.2cu in. 2.2L



**18-6947
STARTER**
Replaces:
Mercuriser 50-805991
Fits: 7.3L (BRAVO & MIE) DIESEL NAV
444 V-8 1994-1996



**18-6870
STARTER**
Replaces: Mercury 50-805833, T
Fits: D7.3L D-tronic 260 LD, 300 1999 year



**18-6949
STARTER**
Replaces:
Mercuriser 50-831001562,
50-831001961
Fits: WO4CTA (150 HP) HINO 234 I/L4,
WO4CTI (210 HP) HINO 234 I/L4



**18-6954
STARTER**
Replaces:
Mercury 50-831001671, 672,
50-831002050, 051, 052
Fits: EH700 (175/220HP) HINO 393 I/L6,
HINO Diesel (See Mercuriser)



**18-6957
STARTER**
Replaces:
Mercuriser 50-801333980,
50-854178, 50-855507



**18-6958
STARTER**
24 Volt
Replaces:
Volvo 847308-4, 870998,
881682
Fits: MD, TMD, TAMD Models

CATERPILLAR ALTERNATOR/STARTER APPLICATION

Model	Year	Starter	Alternator	Amps
D2-55 A, B, C	2001-2007	18-6944	—	—
D2-75 A	2003-2007	18-6944	—	—

CUMMINS ALTERNATOR/STARTER APPLICATION

Model	Year	Starter	Alternator	Amps
6BT 5.9L	1985-UP	18-6947	—	—
6C	ALL	—	18-6952	65
6L8.9	ALL	—	18-6952	65
C8.3	ALL	—	18-6952	65
C8.3G	ALL	—	18-6952	65
CM556	ALL	—	18-6952	65
G8.3	ALL	—	18-6952	65
GTA8.3 CM558	ALL	—	18-6952	65
ISC CM2150	ALL	—	18-6952	65
ISC CM554	ALL	—	18-6952	65
ISC CM850	ALL	—	18-6952	65
ISC8.3 CM2250	ALL	—	18-6952	65
ISL CM2150 SN	ALL	—	18-6952	65
ISL CM554	ALL	—	18-6952	65
ISL CM850	ALL	—	18-6952	65
ISL G CM2250	ALL	—	18-6952	65
ISL9 CM2250	ALL	—	18-6952	65
QSC8.3 CM2250	ALL	—	18-6952	65
QSC8.3 CM554	ALL	—	18-6952	65
QSC8.3 CM850	ALL	—	18-6952	65
QSL9 CM2250	ALL	—	18-6952	65
QSL9 CM554	ALL	—	18-6952	65
QSL9 CM850	ALL	—	18-6952	65
QSL9 G CM558	ALL	—	18-6952	65

MERCURISER ALTERNATOR/STARTER APPLICATION

Model	Year	Starter	Alternator	Amps
530D-TA (Bravo & MIE)	1989-1993	18-6957	—	—
636D-TA (Bravo & MIE)	1989-1993	18-6957	—	—
6BTA5.9-M	1989-UP	18-6947	—	—
7.3L (Bravo & MIE)	1994-1998	18-6947	—	—
D183 Turbo AC (Bravo & MIE)	1990-1993	18-6957	—	—
D2.8L D-Tronic (Bravo & MIE)	1997-1999	18-6957	—	—
D219 Turbo AC (Bravo & MIE)	1990-1993	18-6957	—	—
D254 Turbo AC (Bravo & MIE)	1990-1993	18-6957	—	—
D3.0L Bravo	1994-1997	18-6957	—	—
D3.0L MIE	1994-1995	18-6957	—	—
D3.6L (Bravo & MIE)	1994-1996	18-6957	—	—
D3.6L W Bravo (Export)	1996-UP	18-6957	—	—
D4.2L (Bravo & MIE)	1994-1995	18-6957	—	—
D4.2L/ 250 D-Tronic	1997-1999	18-6957	—	—
EI 165	2004-2005	18-6957	—	—
EI 200	2004-2005	18-6957	—	—
EI 250	2004-2005	18-6957	—	—
EI 300	2004-2005	18-6957	—	—
ES 165	2004-2005	18-6957	—	—
ES 250	2004-2005	18-6957	—	—
ES300	2004-2005	18-6957	—	—
MI 200	2004-2005	18-6957	—	—
MS 200	2004-2005	18-6957	—	—
WO4CTA HINO 234 (150HP)	1990-1997	18-6949	—	—
WO4CTI HINO 234 (210HP)	1990-1997	18-6949	—	—
WO6DTA HINO 351 (310HP)	1990-1997	18-6949	—	—
WO6DTI HINO 351 (250HP)	1990-1997	18-6949	—	—

APPLICATION CONTINUED ON NEXT PAGE

VOLVO ALTERNATOR/STARTER APPLICATION

Model	Year	Starter	Alternator	Amps	Valeo Part No.
2001	1983-1993	—	18-5943	50	—
2002, T	1983-1993	18-6839	18-5943	50	—
2003, T	1983-1993	18-6839	18-5943	50	—
AD290	ALL	—	18-5943	50	—
AD31 A, B, D, L, P, X	1986-2004	—	18-6846	60	—
AD31 A, B, D, L, P, X	1986-2004	—	18-5943	50	—
AD41D	ALL	—	18-5943	50	—
AQAD30A	1983-1986	—	18-5943	50	A13N259
AQAD30A	1983-1986	—	18-59700	50	A13N234
AQAD31A	1986-1989	—	18-5943	50	A13N259
AQAD31A	1986-1989	—	18-59700	50	A13N234
AQAD40A, B	1980-1986	—	18-5943	50	A13N259 OR A13N1M
AQAD40A, B	1980-1986	—	18-59700	50	—
AQAD41	ALL	—	18-5943	50	A13N259
AQAD41	ALL	—	18-59700	50	A13N234
AQAD41A, B, C	1986-1994	—	18-5943	50	A13N259 OR A13N1M
AQAD41A, B, C	1986-1994	—	18-59700	50	A13N234
AQD32A	1969-1977	—	18-5943	50	A13N1M
AQD32A	1969-1977	—	18-59700	50	A13N234
AQD40A, B	1977-1986	—	18-5943	50	A13N259
AQD40A, B	1977-1986	—	18-59700	50	A13N234
AQD41	ALL	—	18-5943	50	A13N259
AQD41	ALL	—	18-59700	50	A13N234
AQD41A	1986-1989	—	18-5943	50	A13N259
AQD41A	1986-1989	—	18-59700	50	A13N234
AQD70B, BL, C, CL, D	1971-1982	18-6872	18-6846	55	—
B21	ALL	—	18-5943	50	A13N2M
B21	ALL	—	18-59700	50	—
B23	ALL	—	18-5943	50	A13N2M
B23	ALL	—	18-59700	50	—
D12-650	2006-2007	—	18-6846	60	—
D12-715	2002-2004	—	18-6846	60	—
D12C	1999-2004	—	18-6846	60	—
D12-MH	2005-2007	—	18-6846	60	—
D2-55A	ALL	—	18-5939	50	—
D25A	ALL	—	18-5959	50	—
D30A	ALL	—	18-5959	50	—
D3-110	2003-2007	—	18-6953	140	—
D3-130	2003-2007	—	18-6953	140	—
D3-160	2003-2007	—	18-6953	140	—
D3-190	2003-2007	—	18-6953	140	—
D41D	ALL	—	18-5943	50	—
D49A	ALL	—	18-5959	50	—
D63	ALL	—	18-5939	50	—
D71, D	ALL	—	18-5939	50	—
D73	ALL	—	18-5939	50	—
KAD32P	1996-2005	—	18-6846	60	—
KAD42A, B, P	1991-2001	—	18-5943	50	A13N259
KAD42A, B, P	1991-2001	—	18-59700	50	A13N234
KAMD42A B, P	1991-1997	—	18-5943	50	A13N259
KAMD42A B, P	1991-1997	—	18-59700	50	A13N234
MD100	ALL	—	18-6846	55	—
MD100A, B	1965-1984	—	18-6846	60	—
MD11	ALL	—	18-59700	50	A13N234

APPLICATION CONTINUED ON NEXT PAGE

VOLVO ALTERNATOR/STARTER APPLICATION

Model	Year	Starter	Alternator	Amps	Valeo Part No.
MD11C	1975-1981	—	18-5943	50	A13N57M OR A13N1M
MD11C	1975-1981	—	18-59700	50	—
MD120	ALL	—	18-6846	55	—
MD120A	1970-1980	—	18-6846	60	—
MD17	1975-1981	—	18-5943	50	A13N2M
MD17	1975-1981	—	18-59700	50	A13N234
MD17C	1975-1984	—	18-5943	50	A13N2M
MD17C	1975-1984	—	18-59700	50	A13N234
MD17D	1975-1984	—	18-5943	50	A13N147M OR A13N1M
MD17D	1975-1984	—	18-59700	50	A13N234
MD18	ALL	—	18-5943	50	A13N147M
MD18	ALL	—	18-59700	50	—
MD21	1968-1979	—	18-5943	50	A13N147M OR A13N1M
MD21	1968-1979	—	18-59700	50	—
MD21A	1968-1979	—	18-5943	50	A13N1M
MD21A	1968-1979	—	18-59700	50	—
MD2B	1964-1975	—	18-5943	50	A13N1M
MD2B	1964-1975	—	18-59700	50	A13N234
MD2BHY	1964-1975	—	18-5943	50	A13N1M
MD2BHY	1964-1975	—	18-59700	50	—
MD30	1983-1986	—	18-5943	50	A13N147M OR A13N1M
MD30	1983-1986	—	18-59700	50	A13N234
MD30A	1983-1986	—	18-5943	50	A13N259
MD30A	1983-1986	—	18-59700	50	A13N234
MD31A	1986-1994	—	18-5943	50	A13N259
MD31A	1986-1994	—	18-59700	50	—
MD32A	1969-1977	—	18-5943	50	A13N1M
MD32A	1969-1977	—	18-59700	50	A13N234
MD3B	1971-1975	—	18-5943	50	A13N1M
MD3B	1971-1975	—	18-59700	50	A13N234
MD40A	1976-1985	—	18-5943	50	A13N259
MD40A	1976-1985	—	18-59700	50	A13N234
MD42A	1970-1979	18-6872	—	—	—
MD5	ALL	—	18-5943	50	A13N2M OR A13N147M
MD5	ALL	—	18-59700	50	—
MD5A, B, C	1975-1982	—	18-5943	50	A13N1M
MD5A, B, C	1975-1982	—	18-59700	50	—
MD6A	1971-1976	—	18-5943	35	A13N57M
MD6A	1971-1976	—	18-59700	35	A13N234
MD7	ALL	—	18-5943	50	A13N147M OR A13N2M
MD7	ALL	—	18-59700	50	A13N234
MD70B, C	1970-1985	18-6872	—	—	—
MD70B, C	1965-1985	18-6958	18-6846	60	—
MD7A, B	1976-1983	—	18-5943	50	A13N1M OR A13N259
MD7A, B	1976-1983	—	18-59700	50	A13N234
MD11	ALL	—	18-5943	50	A13N2M
TAMD 120	ALL	—	18-6955	120	—
TAMD 120 A, B	1973-1982	—	18-6955	175	—
TAMD 162 A, B, C	1988-2001	—	18-6955	175	—
TAMD102 A, D	1991-2000	—	18-6846	60	—
TAMD103A	2000-2004	—	18-6846	60	—
TAMD120	ALL	—	18-6846	55	—
TAMD120A, B	1972-1983	18-6958	18-6846	60	—
TAMD121 C, D	1983-1988	18-6958	18-6846	60	—

APPLICATION CONTINUED ON NEXT PAGE

VOLVO ALTERNATOR/STARTER APPLICATION

Model	Year	Starter	Alternator	Amps	Valeo Part No.
TAMD121 C, D	1983-1988	18-6958	18-6846	55	—
TAMD122 A, C, D, P	1988-2002	18-6958	18-6846	60	—
TAMD162 A, B, C	1988-2001	—	18-6846	60	—
TAMD163 A, P	1994-2001	—	18-6846	60	—
TAMD163 A, P	1994-2001	—	18-6846	55	—
TAMD165A, C, P	2002-2005	—	18-6846	60	—
TAMD30, A, B, C	1983-1986	—	18-5943	50	A13N1M
TAMD30, A, B, C	1983-1986	—	18-59700	50	A13N234
TAMD31A, B, D, L, M, P, S, X	1985-2004	—	18-5943	50	A13N259
TAMD31A, B, D, L, M, P, S, X	1985-2004	—	18-59700	50	A13N234
TAMD31A, B, D, L, M, P, S, X	1985-2004	—	18-6846	60	—
TAMD40A, B, C	1979-1986	—	18-5943	50	A13N259
TAMD40A, B, C	1979-1986	—	18-59700	50	A13C234
TAMD41A	1986-1989	—	18-5943	50	A13N259 OR A13N1M
TAMD41A	1986-1989	—	18-59700	50	A13N234
TAMD60 A, B, C	1976-1987	18-6872	18-6846	60	—
TAMD61A	1986-1995	18-6872	18-6846	60	—
TAMD62A	1992-1994	18-6872	18-6846	60	—
TAMD63L, P	1994-2005	18-6872	—	—	—
TAMD70	ALL	—	18-5943	50	A13N259
TAMD70	ALL	—	18-59700	50	—
TAMD70	ALL	—	18-6846	55	—
TAMD70B, C, D	1970-1987	18-6872	18-6846	60	—
TAMD70E	1983-1987	—	18-5943	50	A13N1M
TAMD70E	1983-1987	18-6872	18-59700	50	—
TAMD70E	1983-1987	18-6872	18-6846	60	—
TAMD71A, B	1986-2000	18-6872	18-6846	60	—
TAMD72A, P, W, J	1991-1997	18-6872	18-6846	60	—
TAMD73P, W, J	1997-1999	18-6872	18-6846	60	—
TAMD74A, C, L, P	1998-2005	18-6872	18-6846	60	—
TAMD75P	1998-2005	18-6872	18-6846	60	—
THAMD70B, C	1972-1979	18-6872	18-6846	60	—
TMD 100	ALL	—	18-6955	120	—
TMD 100 B, C	1965-1988	—	18-6955	175	—
TMD100A	ALL	—	18-6846	55	—
TMD100B, C	1965-1988	—	18-6846	60	—
TMD102A	1988-2000	—	18-6846	60	—
TMD120	ALL	—	18-6955	120	—
TMD120 A,B	1970-1984	18-6958	18-6955	175	—
TMD120A, B	1970-1984	18-6958	18-6846	60	—
TMD121C	1983-1988	18-6958	18-6846	60	—
TMD122A	1988-2000	18-6958	18-6846	60	—
TMD122A	1988-2000	18-6958	18-6846	55	—
TMD30A, B	1983-1986	—	18-5943	50	A13N147M
TMD30A, B	1983-1986	—	18-59700	50	A13N234
TMD31A, B, D, L	1986-1997	—	18-5943	50	A13N259
TMD31A, B, D, L	1986-1997	—	18-59700	50	A13N234
TMD40	ALL	—	18-5943	50	A13N147M
TMD40	ALL	—	18-59700	50	A13N1M
TMD40A, B, C	1976-1986	—	18-5943	50	A13N259
TMD40A, B, C	1976-1986	—	18-59700	50	A13N234
TMD41A, B, D, L	1986-1997	—	18-5943	50	A13N259
TMD41A, B, D, L	1986-1997	—	18-59700	50	A13N234
TMD70B, C	1972-1985	18-6872	18-6846	60	—

APPLICATION CONTINUED ON NEXT PAGE

YANMAR ALTERNATOR/STARTER APPLICATION

Model	Year	Starter	Alternator	Amps
1GM	1980-1984	18-6937	18-6925 ⑥	35
1GM	1980-1984	18-6937	18-6928 ③ ⑦ ⑧	35
1GM10	1980-1981	18-6937	18-6928	35
1GM10	1982-UP	18-6937	18-6925 ④	35
1GM10	1982-UP	18-6937	18-6927 ⑤	35
1GM10C	1982-1984	18-6937	18-6925	35
1GM10L	1982-UP	—	18-6927 ⑤	35
1GM10L	1982-UP	—	18-6925 ④	35
1GM10VE	1985-UP	—	18-6927	35
1GML	1982-UP	—	18-6927	35
1GML	1982-UP	—	18-6925	35
1GMY	1982-UP	—	18-6925 ④	35
1GMY	1982-UP	—	18-6927 ⑤	35
2GM	1980-1984	18-6937	18-6925 ⑥	35
2GM	1980-1984	18-6937	18-6928 ③ ⑦ ⑧	35
2GM20	1982-UP	18-6937	18-6925	35
2GMF	1980-1984	18-6937	18-6925 ⑥	35
2GMF	1980-1984	—	18-6928 ③ ⑦ ⑧	35
2GMFL	ALL	—	18-6925	35
2GMFY(E)-E	ALL	—	18-6925	35
2GML	ALL	—	18-6925	35
2GMYE-EC	ALL	—	18-6925	35
2GMZ	ALL	—	18-6925	35
2QM15	1977-1980	—	18-6925 ⑥	35
2QM15	1977-1980	—	18-6928 ③ ⑦ ⑧	35
2QM20	1975-1980	—	18-6928	35
2TD	1982-UP	—	18-6925	35
2TM	1982-UP	—	18-6925	35
3GM	1980-1984	18-6937	18-6925	35
3GM	1980-1984	18-6937	18-6928 ③ ⑦ ⑧	35
3GMD	1982-UP	18-6937	18-6925 ⑥	35
3GMD	1982-UP	18-6937	18-6928 ③ ⑦ ⑧	35
3GMF	1982-UP	18-6937	18-6925 ⑥	35
3GMF	1982-UP	18-6937	18-6928 ③ ⑦ ⑧	35
3GMFY-E	1982-UP	—	18-6925	35
3GMLE	1982-UP	—	18-6927	35
3HM	1980-1984	—	18-6925 ⑥	35
3HM	1980-1984	—	18-6928 ③ ⑦ ⑧	35
3HMF	1980-1984	—	18-6925 ⑥	35
3HMF	1980-1984	—	18-6925 ③ ⑦ ⑧	35
3JH2	1991-1999	18-6880	18-6925	35
3JH2	1991-1999	18-6880	18-6929	80
3JH2BE	1991-1999	18-6880	18-6929	80
3JH2E	1991-1999	18-6880	18-6929	80
3JH3	1999-2003	—	18-6925	35
3JH3	1999-2003	—	18-6929	80
3JH3E	ALL	—	18-6929	80
3JH3E-YEU	ALL	18-6880	—	—
3JH3Z	ALL	—	18-6925	35
3JH4E	2003-UP	—	18-6929	80
3TM20	2004-UP	—	18-6929	80

① Hitachi S114-303 ② Hitachi S114-483A ③ Hitachi LR135-105 ④ Hitachi LR135-126 ⑤ Hitachi LR135-74B ⑥ S/N 3690-Below
 ⑦ S/N 3691-Up ⑧ W/ 2 Pin Regulator Hookup ⑨ W/O 2 Pin Regulator Hookup ⑩ W/O Plastic Cover

APPLICATION CONTINUED ON NEXT PAGE

YANMAR ALTERNATOR/STARTER APPLICATION

Model	Year	Starter	Alternator	Amps
3YM30	2004-UP	—	18-6929	80
3TN63	1990-UP	18-6935	—	—
3TN66	1985-UP	18-6935	—	—
3TN68	1995-UP	18-6935	—	—
3TNE84	1982-UP	18-6880	18-6926	40
3TNE88	1982-UP	18-6880	18-6926	40
3TNV-84-T	ALL	18-6931	—	—
4GM	1985-UP	—	18-6925	35
4JH	1982-UP	18-6880	18-6925	35
4JH2-CE	1988-UP	18-6880	18-6929	80
4JH2-DTE	1988-UP	18-6880	18-6929	80
4JH2-E	1988-UP	18-6880	18-6929	80
4JH2-HTE	1988-UP	18-6880	18-6929	80
4JH2L-HTNE	1988-UP	18-6880	18-6925	35
4JH2L-TNE	1988-UP	18-6880	18-6925	35
4JH2-TE	1988-UP	18-6880	18-6929	80
4JH2-UTE	1988-UP	18-6880	18-6925	35
4JH3-CE	1994-2003	18-6880	18-6929	80
4JH3-DTE	1994-2003	18-6880	18-6929	80
4JH3E	1994-2003	18-6880	18-6929	80
4JH3-HTE	1994-2003	18-6880	18-6929	80
4JH3-TCE	1994-2003	18-6880	18-6929	80
4JH3-TE	1994-2003	18-6880	18-6929	80
4JH3-TE-YEU	1994-2003	18-6880	—	—
4JH3ZA	1994-2003	18-6880	18-6925	35
4JHE	ALL	—	18-6929	80
4JH-HT	1982-UP	—	18-6925	35
4JH-HT-Z	1982-UP	18-6880	18-6925	35
4JH-T	1982-UP	18-6880	18-6925	35
4JH-TE	1982-UP	—	18-6929	80
4JH-TZ	1982-UP	18-6880	18-6925	35
4JHZ	ALL	18-6880	18-6925	35
4LHA-DTE	ALL	18-6939	18-6929	80
4LHA-DTZ	ALL	18-6939	18-6929	80
4LHA-HTE	ALL	18-6939	18-6929	80
4LHA-HTZE	ALL	18-6939	18-6929	80
4LHA-STE	ALL	18-6939	18-6929	80
4LHA-STZE	ALL	18-6939	18-6929	80
4LH-DTE	1987-UP	18-6939	18-6929	80
4LH-HTE	1987-UP	18-6939	18-6929	80
4LH-STE	1987-UP	18-6939	18-6929	80
4LH-TE	ALL	18-6939	18-6929	80
4TD	1982-UP	—	18-6925	35
4TM	1982-UP	—	18-6925	35
4TNE84	1989-UP	18-6880	18-6926	40
4TNE88	1989-UP	18-6880	18-6926	40
6LP-DT	1997-UP	—	18-6849	80
6LP-DTE	1997-UP	18-6938	18-6849	80
6LP-DTZE	1997-UP	—	18-6849	80
6LP-DTZE1	1997-UP	—	18-6849	80
6LP-DTZY	1997-UP	—	18-6849	80

① Hitachi S114-303 ② Hitachi S114-483A ③ Hitachi LR135-105 ④ Hitachi LR135-126 ⑤ Hitachi LR135-74B ⑥ S/N 3690-Below
 ⑦ S/N 3691-Up ⑧ W/ 2 Pin Regulator Hookup ⑨ W/O 2 Pin Regulator Hookup ⑩ W/O Plastic Cover

APPLICATION CONTINUED ON NEXT PAGE

YANMAR ALTERNATOR/STARTER APPLICATION

Model	Year	Starter	Alternator	Amps
6LP-ST	1997-UP	—	18-6849	80
6LP-STE	1997-UP	18-6938	18-6849	80
6LP-STZE	1997-UP	—	18-6849	80
6LY2-STE	1992-UP	18-6934	18-6929	80
6LYA-STE	1992-UP	18-6934	18-6929	80
6LYA-UTE	1992-UP	18-6934	18-6929	80
6LYM-STE	1992-UP	18-6934	18-6929	80
6LYM-UTE	1992-UP	18-6934	18-6929	80
6LY-ST	1992-UP	18-6934	18-6929	80
6LY-STE	1992-UP	18-6934	18-6929	80
6LY-STM	1992-UP	18-6934	18-6929	80
6LY-STZY	1992-UP	18-6934	18-6929	80
6LY-UT	1992-UP	18-6934	18-6929	80
6LY-UTE	1992-UP	18-6934	18-6929	80
6LY-UTM	1992-UP	18-6934	18-6929	80
6LY-UTZY	1992-UP	18-6934	18-6929	80
KBW-20	ALL	—	18-6929	80
KBW-21	ALL	—	18-6929	80
6PH	1982-UP	18-6934	—	—
6PH-HTZY	1982-UP	18-6934	—	—
6PH-M-HTE	1982-UP	18-6934	—	—
6PHM-HTZ	1982-UP	18-6934	—	—
6PHM-TZ	1982-UP	18-6934	—	—
6PHS-HTPS	1982-UP	18-6934	—	—
6PHS-TPS	1982-UP	18-6934	—	—
KM2A	ALL	18-6937	18-6925 ①	35
KM2A	ALL	18-6937	18-6927 ②	35
KM2C	ALL	18-6937	—	—
KM2P	ALL	18-6937	18-6925 ①	35
KM2P	ALL	18-6937	18-6927 ②	35
KM3A	ALL	18-6937 ①	18-6929	80
KM3A	ALL	18-6880 ②	18-6929	80
KM3P	ALL	18-6937	—	—
KM3V	ALL	18-6937	18-6925 ①	35
KM3V	ALL	18-6937	18-6927 ②	35
KM5A	ALL	18-6939	18-6929	80
L40S	1984-1999	18-6936	—	—
L60S	1984-1999	18-6936	—	—
SB12	1976-1980	18-6930	—	—
SB8	1976-1980	18-6930	—	—
SVE12	1974-1976	18-6930	—	—
SVE8	1974-1976	18-6930	—	—
UJH2E	ALL	18-6880	18-6929	80
Y-5M	ALL	—	18-6925 ①	35
Y-5M	ALL	—	18-6927 ②	35
YC	1971-UP	18-6930	—	—
YSB12	1976-1977	18-6930	—	—
YSB8	1976-1977	18-6930	—	—
YSE12	1974-1976	18-6930	—	—
YSE8	1974-1976	18-6930	—	—
YSM12	1977-1980	18-6930	—	—
YSM8	1977-1980	18-6930	—	—

① Hitachi S114-303 ② Hitachi S114-483A ③ Hitachi LR135-105 ④ Hitachi LR135-126 ⑤ Hitachi LR135-74B ⑥ S/N 3690-Below
 ⑦ S/N 3691-Up ⑧ W/ 2 Pin Regulator Hookup ⑨ W/O 2 Pin Regulator Hookup ⑩ W/O Plastic Cover

DIESEL FUEL FILTERS

20 MICRON



18-7935

Replaces:

Fram CCS 1136
Fram FCS 1136 Filter Bracket

20 MICRON

18-7942

Replaces:

Volvo 466987, 3825133
For: MD100A, TMD100A, MD100B, MD120A, TMD120A, TAMD120A, MD120B, TMD120B, TAMD120B, MD70B, TMD70B, TAMD70B, THAMD70B, AQAD70B, MD70C, TMD70C, TAMD70C, AQD70C, TAMD60A, TAMD60B, TAMD60C, D5/D7 MARINE GENSET, D5A-T, D5A-TA, D7A-T, D7A-TA, D7C-TA, D63 MARINE, D71/73 MARINE, KAD32P, TAMD42WJ, KAD43P/44P/300, KAMD43P/44P/300, TAMD103A, TAMD61A, TAMD62A, TAMD71A, TAMD72A, TAMD72P, TAMD72WJ, TAMD74, TAMD75 MARINE, TMD102A, TAMD102A, TAMD102D, TMD122A, TAMD122A, TAMD122P, TMD31L, TAMD31P/L/M/S, AD31P/L, TMD41L, TAMD41P/L/M/H



18-79960

FUEL FILTER ELEMENT

Replaces: Yanmar 104500-55712

Fits: All GM Series, YM Series, HM Series, QM Series

20 MICRON



18-7858

Replaces: Volvo 858201

For: CAV Type Unit
For: AQ120B, 125A, B, 131A, 140A, 145A, B, 151, BB, 140, 145A



18-7873

Replaces:

MerCruiser 35-808275
For models: D7.3/270 Bravo & MIE Diesel Engines (1994-96)



18-8124

Replaces: Volvo 829913

For: 2001, 2001B, 2002, 2002B, 2003, 2003B/T/TB, AQD2B, MD11C/D, MD17C/D, MD1B, MD2B, MD3B, MD5A/B/C, MD7/B

20 MICRON



18-7931

Replaces: Detroit Diesel 5574508

FOR: 8V-92, 8V-71



18-8125

Replaces: Volvo 3583443

For: D4-180i-B, D4-180i-C, D4-210A-A, D4-210A-B, D4-210i-A, D4-210i-B, D4-225A-B, D4-225A-C, D4-225i-B, D4-225i-C, D4-260A-A, D4-260A-B, D4-260A-C, D4-260D-B, D4-260D-C, D4-260i-A, D4-260i-B, D4-260i-C, D4-300A-A, D4-300A-C, D4-300D-A, D4-300D-C, D4-300i-A, D4-300i-C, D6-280A-A, D6-280A-B, D6-280i-A, D6-280i-B, D6-310A-A, D6-310A-B, D6-310D-A, D6-310D-B, D6-310i-A, D6-310i-B, D6-330A-B, D6-330A-C, D6-330D-B, D6-330D-C, D6-330i-B, D6-330i-C, D6-350A-B, D6-350A-C, D6-370A-B, D6-370A-C, D6-370D-A, D6-370D-B, D6-370D-C, D6-370i-A, D6-370i-B, D6-370i-C, D6-435D-A, D6-435D-C, D6-435i-A, D6-435i-C



18-8126

Replaces: Volvo 861477

For: D1-13 A, D1-13 B, D1-20 A, D1-20 B, D1-30 A, D1-30 B, D2-40 A, D2-40 B, D2-55 A, D2-55 B, D2-55 C, D2-55 D, D2-55 E, D2-55F, D2-75 A, D2-75 B, D2-75 C, D2-75F, MD2010A, MD2010B, MD2020A, MD2020B, MD2030A, MD2030B, MD2040A, MD2040B



18-35443

FUEL PUMP

Replaces: Volvo 3582310

Fits: Volvo D30, D40, D31, D41, D42 Diesel Engines



18-35444

FUEL PUMP

Replaces: Volvo 858459

Fits: Volvo Older D21 and D32 Diesel Engines

18-7783

FUEL PUMP GASKET SET

Replaces: Volvo 273663

Fits: D30, D31, D32, D40, D42, D44, AD30A, AQAD30A, TAMD30A, TMD30A, AD31A, AD31B, AD31D, AD31XD, AQAD31A, MD31A, TAMD31A, TAMD31B, TAMD31D, TMD31A, TMD31B, TMD31D, KAD32P-A, AD40B, AQAD40A, AQAD40B, AQD40A, MD40A, TAMD40A, TAMD40B, TMD40A, TMD40B, TMD40C, AD41A, AD41B, AD41D, AQAD41A, D41A, D41B, D41D, TAMD41A, TAMD41B, TAMD41D, TMD41A, TMD41B, TMD41D, KAD42A, KAD42B, KAD42P-A, KAMD42A, KAMD42B, KAMD42P-A, TAMD42B, TAMD42WJ-A, KAD43P-A, KAMD43P-A, KAD44P-A, KAMD44P-A



18-57703

AIR FILTER

Replaces:

Yanmar 128270-12540
Fits: Yanmar 2GM & 3GM30



18-57704
AIR FILTER

Replaces:
Yanmar 128171-12540
Fits: Yanmar 1GM10



18-8950
IMPELLER

Replaces:
Yanmar 124223-42092
For: 2GM20F, 2GMF, 2QM, 2QM20, 3GM30F, 3GMF, 3HM, 3HM35, 3HM35F, 3HMF, 3QM30, 3QM30F



18-8951
IMPELLER

Replaces:
Yanmar 128176-42071
For: 1GM, 1GM10



18-8952
IMPELLER

Replaces:
Yanmar 104211-42071
For: 2GM, 3GM



18-45714
F75B IMPELLER

Replaces:
Yanmar 119574-42550, 119574-42552
Fits: F75B Pump



18-55500
POWER HEAD GASKET

Replaces:
Yanmar 728170-92600
For: 1GM (7hp)



18-55501
POWER HEAD GASKET

Replaces: Yanmar 18-55501
For: 1GM10 (9hp)



18-55502
POWER HEAD GASKET

Replaces:
Yanmar 728271-92605
For: 2GM20 (18hp), 2GM20B, 2GM20C, 2GM20F (18hp)



18-55503
POWER HEAD GASKET

Replaces:
Yanmar 728374-92605
For: 3GM30 (27hp), 3GM30 EU (27hp), 3GM30F (27hp), 3GM30F EU (27hp)



18-56000
BONNET COVER GASKET

Replaces:
Yanmar 128170-11310
For: 1GM, 1GM10



18-56601
THERMOSTAT GASKET

Replaces:
Yanmar 104211-49160
For: 1GM, 1GM10



18-56602
WATER PUMP GASKET

Replaces:
Yanmar 128170-42090
For: 1GM, 1GM10



18-55600
HEAD GASKET

Replaces:
Yanmar 128170-01331
For: 1GM (7hp)



18-55601
HEAD GASKET

Replaces:
Yanmar 128171-01911
For: 1GM10 (9hp)



18-55602
HEAD GASKET

Replaces:
Yanmar 128271-01911
For: 2GM20 (18hp), 2GM20B, 2GM20C, 2GM20F (18hp)



18-55603
HEAD GASKET

Replaces:
Yanmar 128374-01911
For: 3GM30 (27hp), 3GM30 EU (27hp), 3GM30F (27hp), 3GM30F EU (27hp)



18-6200
ANODE

Replaces:
Yanmar 27210-200200
Fits: 1GM, 1GM10, 6LY3



18-6201
ANODE

Replaces:
Yanmar 27210-200300
Fits: 2GM, 3GM, 2GMF, 3GMF, 2GM20, 3GM30, 3HM, 3HM35, 2QM15, 2QM, 3QM, 2QM20, 3QM30, YSB8, YSB12, YSM8, YSM12

OIL FILTERS

Sierra oil filters are engineered with premium grade materials that will not only withstand but excel in the extreme environment of the Marine world. Sierra ensures the excellent performance of their filters by:

- Epoxy coating all canisters for corrosion resistance.
- Using a heavy-wall steel canister for further corrosion protection.
- Using high-efficiency filter media that meets or exceeds the OE's filtration.
- Backed by Sierra's industry leading warranty.

DIESEL OIL FILTERS



18-0032
Replaces:
Volvo 847741



18-0033
Replaces:
Volvo 21707133



18-0034
Replaces:
Volvo 477556



18-0035
Replaces:
Volvo 3582732
Full Flow



18-0036
Replaces:
Volvo 3582733
Bypass



18-7871
Replaces:
MerCruiser 35-805809



18-7880
Replaces:
Caterpillar 1R-0658
Volvo-Penta 466634



***18-7884**
Replaces:
Universal 299381
Volvo-Penta 834337
Thread Spec: 3/4" x 16NPT



***18-7886**
Replaces:
Perkins 2654403
Thread Spec: 3/4" x 16NPT

DIESEL OIL FILTERS (Cont.)



***18-7910-1**

Replaces:

Westerbeke 30220
Yanmar 124450-35100, 119350-35150,
119350-35151
Thread Spec: 20mm x 1.5



***18-7917**

Replaces:

Yanmar 124450-35110, 124550-35110,
171056-35110, 171056-35111, 124085-35113
Thread Spec: 20mm x 1.5



***18-7925**

Replaces:

Westerbeke 21235
Thread Spec: 3/4" x 16NPT



***18-7926**

Replaces:

Volvo 423135, 4785974
Thread Spec: 1" x 12NPT



18-7927

Replaces:

Caterpillar 1R-0714
Thread Spec: 1 1/8" x 16NPT

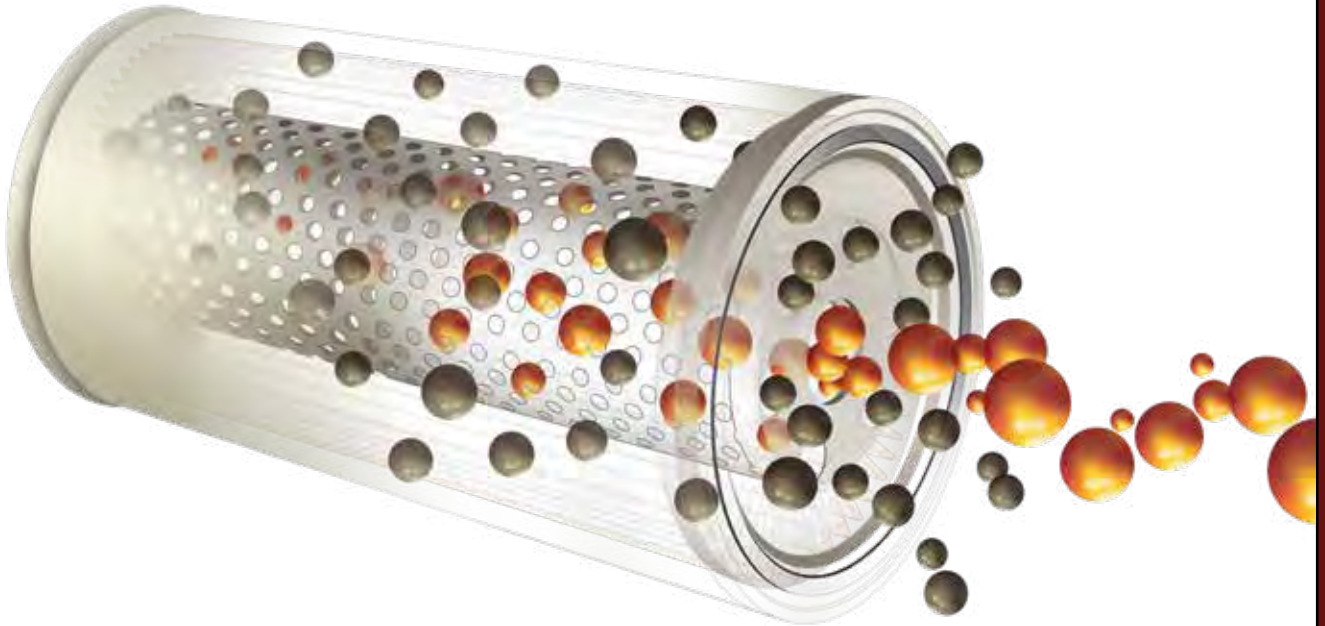

* Anti-Drain-Back Valve
Valve eliminates dry starts, prevents oil from draining back into crankcase during engine shutdown.

SEA RAY			FORD V8 (STERN DRIVE) Cont.		
MODEL NO.	S/N	YEAR	MODEL	S/N	YEAR
3.0L	B787205-B917529	1988	225-S (4bbl.)	3385721-4166999	1973-74
4.3L	B785483-B921276	1988	233	4173000-4902304	1975-77
4.3LX	B785981-B922330	1988	255	3258728-4175499	1971-74
5.7L	B784799-B917017	1988	GM V8 283, 327, 305 & 350 CID		
SRX5.7L, 350 Mag	B785241-B919012	1988	MODEL	S/N	YEAR
SRX7.4L, 454 Mag Alpha	B785149-B924857	1988	190	1564539-1730903	1963-64
SRX7.4L-H, 454 Mag Bravo	B721206-B919343	1988	898 (2bbl.)	4762210-6218461	1977-82
STERN DRIVES			898 (2bbl.)	6218462-B525981	1983-84
MODEL NO.	S/N	YEAR	200/5.0L (2bbl.)	6218462-F600999	1985-95
SRX7.4L, Alpha	B803866-C348032	1988	5.0L (2bbl.)	L015751-UP	1998-UP
SRX7.4L-H, Bravo	B803872-B999972	1988	5.0L EFI	L012052-L340000	1998-99
INBOARD ENGINES			228 (4bbl.)	4765100-5170008	1977-78
MODEL NO.	S/N	YEAR	228 (4bbl.)	5170009-6218461	1979-82
5.7L	B788204-B919356	1988	228 (4bbl.)	6218462-B525981	1982-84
7.4L	B788179-B913769	1988	230 (4bbl.)	6218462-B525981	1985-86
RENAULT 4 CYLINDER (STERN DRIVE)			230/5.0LX (4bbl.)	B525982-F600999	1987-95
MODEL	S/N	YEAR	225	1539620-2694014	1963-69
60	1887079-2049044	1965-68	250	2314301-2639854	1968-69
80	2049045-2851423	1966-69	255	4175500-4767999	1975-76
90	2851424-3226957	1970-72	250	4768000-4908849	1977
GM 4 CYLINDER (STERN DRIVE)			260/5.7L	4908850-6218461	1978-82
MODEL	S/N	YEAR	260/5.7L	621462-B525981	1982-86
110	1537370-2044033	1963-66	260/5.7L	B525982-F600999	1987-95
120	1666601-3377340	1964-72	5.7L (2bbl.)	F601000-UP	1996-98
120	3377341-3770649	1972-73	5.7L EFI	F225560-UP	1995-UP
120	3770650-4952700	1974-77	5.7LX (4bbl.)	F601000-K999999	1996-97
120	4952701-5192048	1978	5.7LX EFI	F752400-K999999	1996-97
120	5192049-6229717	1979-82	5.7LX Bravo EFI	F800300-K999999	1996-97
120	6229718-6853913	1983-84	350 Mag. Alpha	A635178-B525981	1986-87
120	6853914-B531853	1985-86	350 Mag. Alpha	B525982-F600999	1987-95
120/2.5L	B531854-C853255	1987-89	350 Mag. Alpha	F601000-K001526	1996
140	2508261-6229717	1968-82	350 Mag. Alpha	K001527-K999999	1997
140/3.0L	6229718-C856558	1982-89	350 Mag. Alpha EFI	F800300-K999999	1996-97
3.0L/LX	C856559-UP	1990-UP	350 Mag. Bravo MPI	F415189-K999999	1995-97
MERCURY MARINE 4 CYLINDER (STERN DRIVE)			350 Mag. Bravo MPI	(GEN +)	F602000-K999999
MODEL	S/N	YEAR	350 Mag. MPI (GEN+)	L010019-UP	1998-UP
470 (2bbl.)	4208730-5520114	1976-79	270	2851074-3385720	1969-72
470 (2bbl.)	5520115-6218036	1980-82	280TRS	4176250-4770199	1975-76
470 (2bbl.)	6218037-6916778	1983-84	300 Tempest	6668677-B430367	1985-86
170 (2bbl.)	6916779-UP	1985-86	320 (EFI)	A543604-C622418	1987-89
165/3.7L (2bbl.)	6916779-UP	1987-89	GM V8 427, 454, 502, 540 & 572 (STERN DRIVE)		
485 (2bbl.)	5685394-6218036	1980-82	MODEL	S/N	YEAR
488 (4bbl.)	6170297-6916778	1983-84	325	2278747-3780449	1969-72
190 (4bbl.)	6916779-UP	1985-86	330	4623115-6083144	1977-81
180/3.7LX (4bbl.)	6916779-UP	1987-89	330	6083145-B816450	1982-87
GM INLINE 6 CYLINDER (STERN DRIVE)			7.4L Bravo	B771113-D603117	1988-91
MODEL	S/N	YEAR	7.4L Bravo (Gen.V)	D603118-F800699	1992-96
140	1538930-1725960	1963	7.4L Bravo (Gen.VI)	F800700-K999999	1996-97
150	1666495-2048046	1964-66	7.4LX Bravo (MPI)(Gen.V)	F602010-F801999	1996
160	2048022-2770031	1967-69	7.4LX Bravo (MPI)(Gen.VI)	F802000-K999999	1996-97
165	2770032-5178958	1970-78	7.4L MPI (Gen.VI)	L010003-UP	1998
165	5178959-5813433	1979-81	7.4LX Bravo (TBI)(Gen.VI)	F820000-K999999	1996-97
200	2453769-2712072	1969	454 Mag. Alpha	A631894-UP	1986-88
GM V6 (STERN DRIVE)			454 Mag. Bravo (Gen.V)	D805069-F304999	1992-94
MODEL	S/N	YEAR	454 Mag. Bravo (Gen.V)	F305000-F801699	1995-96
185 (4bbl.)	6330183-6919655	1983-84	454 Mag. Bravo (Gen.VI)	F801700-K999999	1996-97
185 (2bbl.)	A331455-B527954	1985-87	454 EFI (Gen.V)	F115700-F802349	1994-96
175/4.3L (2bbl.)	B527955-D714106	1987-92	454 Mag. MPI (Gen.VI)	F802350-K999999	1996-97
4.3L (GEN II)(2bbl.)	D714107-F000877	1992-93	454 Mag. MPI (Gen.VI)	L010029-L085399	1998
4.3L (GEN II)(2bbl.)	F000878-F601126	1993-95	454 Mag. MPI (Gen.VI)	L085400-UP	1999-UP
4.3L (GEN II)(2bbl.)	F601127-F000878	1996	370 TRS	4179554-6721527	1978-85
4.3LX (GEN+)(2bbl.)	F803000-K999999	1996-97	370 TRS	6721528-B714586	1985-87
4.3L (GEN+)(2bbl.)	L010044-UP	1998-UP	400 TRS	4179554-B457644	1980-86
4.3L EFI (GEN+)(TBI)	L012009-UP	1998-UP	420	A398941-D937011	1987-89
205 (4bbl.)	A331455-B527954	1985-87	425	A398941-D937011	1990-93
205/4.3LX (4bbl.)	B527955-D714369	1987-91	440 TRS	4179554-B485220	1983-86
4.3LX (GEN II)(4bbl.)	D714370-F001219	1992-93	450 (Gen.V)	F347100-F347277	1995-96
4.3LX (GEN II)(4bbl.)	F001220-F601126	1993-95	450 SC	D456000-F348963	1991-92
4.3LX (GEN II)(4bbl.)	F601127-F802999	1996	525 SC (Gen.V)	D456000-F348963	1992-95
4.3LXH (GEN+)(4bbl.)	F803114-UP	1996-97	525 SC (Gen.V)	F615814-F745215	1996
4.3LH(GEN+)(4bbl.)	L010044-UP	1998	525 SC (Gen.VI)	F745260-UP	1996-97
262 Mag. (TBI)(GEN+)	F803800-K999999	1996-97	390	2781129-3042731	1969-70
FORD V8 (STERN DRIVE)			460 TRS	4719554-6181046	1983-86
MODEL	S/N	YEAR	465	C849992-F213244	1990-92
888 (2bbl.)	3108723-4887829	1971-77	465 (Gen.V)	C849992-F213244	1992-94
215 (4bbl.)	2781153-3385720	1970-72	500 (Gen.V)	F213293-F745159	1994-96
225 (4bbl.)	3385721-4166999	1973-74			

GM V8 427, 454, 502, 540 & 572 (STERN DRIVE) Cont.		
MODEL	S/N	YEAR
500 (Gen.VI)	F745195-L001772	1997-98
502 Mag. Bravo	C878221-D824588	1990-92
502 Mag. Bravo (Gen.V)	D824589-F114528	1992-93
502 EFI (Gen.V)	D840650-F802599	1993-96
502 Mag.MPI (Gen.VI)	F802600-K999999	1996-97
500 EFI	L001477-UP	1999-UP
502 Mag.MPI (Gen.VI)	L085433-UP	1998
600 SC	D456489-F877642	1991-92
600 SC (Gen.V)	D456489-F877642	1992-96
600 SC (Gen.VI)	K000227-UP	1997
500 Bulldog	C577254-F745405	1990-96
500 Bulldog	K000248-UP	1997
575	A677429-D763716	1986-92
800 SC (Gen.V)	D763836-UP	1993-96

MCM 4.5,6 & V8 CYLINDER DIESEL STERN DRIVE ENGINE			
MODEL	HP	S/N	YEAR
Rover	60	3140000F-UP	1965-67
530 D-TA	150	B993000-B993492	1989
636 D-TA	180	B993500-C696047	1989
D183	140	B993493-D725149	1990-93
D219	170	C696048-D850124	1990-93
D254	200	C849484-D554729	1990-93
D3.0L	140	D725150-UP	1994-UP
D3.6L	170	D850125-UP	1994-UP
D4.2L	200	D554730-UP	1994-UP
D7.3L	238	F060000-UP	1994-UP

MERCURY MARINE MIE 4 CYLINDER (INBOARD)		
MODEL	S/N	YEAR
470	5520115-6218036	1980-81

FORD MIE V8 (INBOARD)		
MODEL	S/N	YEAR
215	2781153-3563181	1970-72
225	3385721-4176999	1970-72
233	4173000-4775784	1975-76
255	3258728-4178299	1973-74

GM MIE V8 305,327,350 CID (INBOARD)		
MODEL	S/N	YEAR
198	4762210-6218461	1977
228	4765100-5170008	1977-78
228	5170009-5907057	1979-80
230/5.0L (4bbl.)	5907058-B788151	1981-87
225	2278647-2694014	1968
250	2314301-2639854	1968-69
255	4175500-5907057	1975-80
260/5.7L	5907058-F024999	1981-93
270	2851074-3077735	1969-72
5.7L	F025000-K999999	1994-97
5.7L (Gen+)	L002003-UP	1998
5.7L MPI	K040300-K999999	1997
350 Mag. MPI (Gen+)	L002008-L304499	1998
350 Mag. MPI (Gen+)	L304500-UP	1999
350 Horizon	L304700-UP	1999-UP
5.7L Ski	A338533-B514626	1985-87
5.7L Competition Ski	B514627-F775199	1987-95
5.7L Competition Ski	F775200-K040003	1996
5.7L Competition Ski	K040004-K999999	1997
5.7L Competition Ski (Gen+)	L002005-UP	1998-UP
350 Mag. Ski	D505450-K999999	1991-97
350 Mag. EFI Ski	F215561-K999999	1994-97
350 Mag. MPI Ski	F350583-F799999	1995-98
Black Scorpion Ski	F800000-UP	1996-98

GM MIE V8 427, 454, 482 & 502 CID (INBOARD)		
MODEL	S/N	YEAR
325	2278747-3780449	1968-74
330	4623115-5889913	1977-80
340/7.4L w/B/W MK4	5889914-UP	1981-92
7.4L w/Hurth (LH) MK4	C391564-D715493	1989-92
7.4L (LH)	D715494-K999999	1992-97
7.4L MPI (LH)	F563052-K999999	1995-97
7.4L MPI (L29) Gen VI	L002006-UP	1998
7.4L TBI (LH) Gen VI	F874815-K999999	1996-97
454 Mag. MPI Horizon	L002200-L086049	1998-99
454 EFI (SKI) (Gen.V)	F215800-F820099	1995-96
454 Mag. MPI (SKI)(Gen.VI)	F820100-K999999	1996-97
350	9780450-4623109	1974-76
390	2781129-2825059	1969-70
8.2L w/ Hurth	C878221-D857199	1990-92
8.2L (Gen.V)	D857200-F819619	1993-96
8.2L MPI (LH) Gen VI	F819620-K999999	1996-97

GM MIE V8 427, 454, 482 & 502 CID (INBOARD)		
MODEL	S/N	YEAR
8.2L MPI (LH) Gen VI	L002450-L0086012	1998
8.2L MPI (LH) Gen VI	L0086013-UP	1999

MIE 5, 6 & V8 CYLINDER DIESEL INBOARD ENGINES			
MODEL	HP	S/N	YEAR
530 D-TA	150	B993002-C539258	1989
636 D-TA	180	B993750-C696011	1989
D183	150	C539259-D725149	1990-93
D219	180	C696012-D850124	1990-93
D254	210	C849461-D554729	1990-93
D3.0L	150	D725150-UP	1994-UP
D3.6L	180	D850125-UP	1994-UP
D4.2L	210	D554730-UP	1994-UP
D7.3L	262	F060000-UP	1994-UP

MC 60, 80 & 90 STERN DRIVES & TRANSOM PLATES		
MODEL	S/N	YEAR
60 (O)	1830753-2063740	1965-66
80	2063741-2898029	1966-69
90	2898020-3225967	1970-72

MC I, II & III		
MODEL	S/N	YEAR
I	1534570-1684187	1963
II (1.33:1)	1474909-2278488	1962-67

MC I, II & III Cont.		
MODEL	S/N	YEAR
II (1.78:1)	2398798-2671321	1968-69
III	2373127-3002613	1968-72
III	5128065-UP	1978-UP

MC 1A, 1B & 1C		
MODEL	S/N	YEAR
1A, 1B & 1C	1684188-1777798	1964
1A, 1B & 1C (E-Z Shift)	1776349-2065189	1965-66

MC 120, 140, 160 & 165		
MODEL	S/N	YEAR
120/140	2062141-378049	1967-73
120/140	3780850-4893634	1974-77
120/140	4893635-6225576	1978-82
160	2065190-2763441	1967-69
165	2763442-3780849	1970-73
165	3780849-4890459	1974-77
165	4890460-6268064	1978-82

MC470 & 485		
MODEL	S/N	YEAR
470	4208730-4893834	1976-77
470	4893835-6225576	1978-82
485	5487437-6225576	1980-82

MC 888, 225S & 233		
MODEL	S/N	YEAR
888	3106717-3784374	1971-73
888	3784375-4782329	1974-77
225S	3856268-4200499	1974
233	4200500-4782329	1975-77

MC 898, 228, 250 & 260		
MODEL	S/N	YEAR
898/228	4782330-4898729	1977
898/228	4898730-6229157	1978-82
250	4791300-4898729	1977
260	4898730-6229157	1978-82

MC R, MR, ALPHA ONE, ALPHA ONE SS & ALPHA ONE GEN II		
MODEL	S/N	YEAR
R	6152230-6847029	1983-84
MR	6810538-A479506	1985
Alpha One	A470165-UP	1986-90
Alpha One SS	A545004-UP	1986-89
Alpha One Gen II	D469859-UP	1991-UP

MC BRAVO & BLACKHAWK		
MODEL	S/N	YEAR
Bravo One	B664190-UP	1988-UP
Bravo Two	C564952-UP	1989-UP
Bravo Three	D763691-UP	1993-UP
Blackhawk	F186717-UP	1994-UP

MC 215E & 215H		
MODEL	S/N	YEAR
215H	2782203-2909034	1970
215E	2782203-2909034	1970-72

MC TR & TRS		
MODEL	S/N	YEAR
TR	3377316-3787239	1973
TR	3787240-4794899	1974-76
TR	4794900-5009866	1977
TR	5009867-UP	1978-UP
TRS	3787240-4203749	1974-75
TRS	4203750-4795399	1976
TRS	4795400-UP	1977-UP



**18-5291
TUNE-UP KIT**

Replaces: 808483K2
GM V-8 engines w/Delco HEI-1998 and newer
(except MPI engines with 555 ECM)
Includes **18-5354** cap & **18-5402** rotor



**18-5246
TUNE-UP KIT**

Replaces: 898253T28
For: Late model V-6, 4.3L (Alpha/Bravo)



**18-5247
TUNE-UP KIT**

Replaces: 898253T29, 8M0061335, 8M0060495
For: Late model V-8 (Alpha/Bravo 350
Mag, 5.0L, & MX 6.2L)

①18-5250D



**18-5250
TUNE-UP KIT**

Replaces: 34235T1, 34235Q1

—CONTAINS—

Part #	O.E. #	Description
18-5311	34235	Contact Set
18-5345	33662	Condenser
18-5418	58217	Rotor

Delco 4 & 6 cyl.

①18-5251D



**18-5251
TUNE-UP KIT**

—CONTAINS—

Part #	O.E. #	Description
18-5314	391-5090	Contact Set
18-5338	391-5092	Condenser
18-5404-1	391-7057	Rotor

Mallory 8 cyl. Tall Cap



**18-5252
TUNE-UP KIT**

—CONTAINS—

Part #	Description
18-5310	Contact Set
18-5344	Condenser
-	Rotor

Delco 8 cyl.



**18-5253
TUNE-UP KIT**

—CONTAINS—

Part #	O.E. #	Description
18-5318	58033	Contact Set
18-5346	58034, 81-64851	Condenser
18-5420	65864	Rotor

Autolite 8 cyl.

①18-5254D



**18-5254
TUNE-UP KIT**

—CONTAINS—

Part #	O.E. #	Description
18-5317	64850, 87-71831	Contact Set
18-5346	58034, 81-64851	Condenser
18-5420	65864, 78016	Rotor

Mercury 8 cyl.

①18-5258D



**18-5258
TUNE-UP KIT**

—CONTAINS—

Part #	O.E. #	Description
18-5303	392-6325	Contact Set
18-5347	392-6324	Condenser
18-5407	392-6326	Rotor

Prestolite 8 cyl.

①18-5260D



**18-5260
TUNE-UP KIT**

—CONTAINS—

Part #	O.E. #	Description
18-5303	392-6325	Contact Set
18-5345	392-6324	Condenser
18-5403	392-9767	Rotor

Prestolite 8 cyl.



**18-5266
TUNE-UP KIT**

Fits: Flame Thrower Distributors 18-5481, 18-5482, 18-5483, 18-5477, 18-5478 and 18-5479
Includes **18-5300** rotor



**18-5267
TUNE-UP KIT**

—CONTAINS—

Part #	O.E. #	Description
18-5318	58033	Contact Set
18-5346	58034, 81-64851	Condenser
18-5420	65864, 78016	Rotor
18-5389	393-4988T	Distributor Cap

Autolite V-8 - Single Point



**18-5268
TUNE-UP KIT**

—CONTAINS—

Part #	O.E. #	Description
18-5311	34235	Contact Set
18-5345	33662	Condenser
18-5418	58217	Rotor
18-5385	393-9459	Distributor Cap

Delco In-Line 4 - Single Point



**18-5269
TUNE-UP KIT**

—CONTAINS—

Part #	O.E. #	Description
18-5311	34235	Contact Set
18-5345	33662	Condenser
18-5418	58217	Rotor
18-5386	33765	Distributor Cap

Delco In-Line 6 - Single Point



**18-5270
TUNE-UP KIT**

—CONTAINS—

Part #	O.E. #	Description
18-5310	380543	Contact Set
18-5344	382125	Condenser
-	381711	Rotor
18-5384	383587	Distributor Cap

Delco V-8 - Single Point

① Items ending in "D" are Display Packaged - Regular number is Non-Display



**18-5271
TUNE-UP KIT**

—CONTAINS—

Part #	O.E. #	Description
18-5314	391-5090	Contact Set
18-5338	391-5092	Condenser
18-5404-1	391-7057, 391-5088	Rotor
18-5376	391-5075	Distributor Cap

Mallory V-8 - Single Point - Top Terminal



**18-5273
TUNE-UP KIT**

—CONTAINS—

Replaces: 805759T3 / 805759Q3

Part #	O.E. #	Description
18-5431	13524A5	Rotor
18-5395	16457A4	Distributor Cap

Mercury Thunderbolt HEI - V-8



**18-5274
TUNE-UP KIT**

—CONTAINS—

Part #	O.E. #	Description
18-5432	13524A6	Rotor
18-5396	13753A2, 815407A2	Distributor Cap

Mercury Thunderbolt HEI - V-6



**18-5275
TUNE-UP KIT**

—CONTAINS—

Part #	O.E. #	Description
18-5303	392-6325	Contact Set
18-5347	392-6324	Condenser
18-5403	392-9089	Rotor
18-5352	392-9766	Distributor Cap

Prestolite V-8 - Single Point - Screw Cap



**18-5276
TUNE-UP KIT**

—CONTAINS—

Part #	O.E. #	Description
18-5303	392-6325	Contact Set
18-5347	392-6324	Condenser
18-5403	392-9089	Rotor
18-5353	392-9086	Distributor Cap

Prestolite V-6 - Single Point - Screw Cap



**18-5277
TUNE-UP KIT**

—CONTAINS—

Part #	O.E. #	Description
18-5303	392-6325	Contact Set
18-5347	392-6324	Condenser
18-5407	392-6326	Rotor
18-5369	392-6318	Distributor Cap

Prestolite V-8 - Single Point - Clip Cap



**18-5278
TUNE-UP KIT**

Replaces: 850484T3
Delco EST - V-6

—CONTAINS—

Part #	Description	O.E. #
18-5362	Distributor Cap	850484
18-5408	Rotor	850485



**18-5280
TUNE-UP KIT**

Replaces: 811635Q2
Delco EST - In-Line 4

—CONTAINS—

Part #	Description	O.E. #	Qty.
18-5361	Distributor Cap	811635, T3	1
18-5406	Rotor	811636, 1	1



**18-5281
TUNE-UP KIT**

Replaces: 808483Q2
Delco EST - V-8

—CONTAINS—

Part #	Description	O.E. #	Qty.
18-5354	Distributor Cap	808483	1
18-5405	Rotor	808484, 1, 898253010	1



**18-5282
TUNE-UP KIT**

Holley, Mercury Marine - Single Point V-8

—CONTAINS—

Part #	Description	O.E. #
18-5389	Dist. Cap	393-4988T, 2
18-5420	Rotor	65864, 78016
18-5317	Contact Set	64850, 87-71831
18-5346	Condenser	58034, 81-64851



**18-5283
TUNE-UP KIT**

For: Mallory Single Point In-Line 4

—CONTAINS—

Part #	Description	O.E. #
18-5397	Distributor Cap	-
18-5404-1	Rotor	391-7057
18-5314	Contact Set	391-5090
18-5338	Condenser	391-5092



**18-5301
TUNE-UP KIT**

Fits: Male cap v-8 flamethrower distributors



**18-5302
TUNE-UP KIT**

Fits: Male cap v-8 flamethrower distributors



**18-5303
CONTACT SET**

Replaces: 392-898253005,
392-6325, 8M6001219,
F16900031



**18-5310
CONTACT SET**

Replaces: 33700



**18-5311
CONTACT SET**

Replaces: 34235, 34235T



**18-5314
CONTACT SET**

Replaces: 391-5090,
391-898253004, 8M6001250



**18-5317
CONTACT SET**

Replaces: 64850, 87-71831



**18-5318
CONTACT SET**

Replaces: 58033,
898253007

 <p>18-5338 CONDENSER Replaces: 391-5092, 391-898253001, 391-5093, 391-5092, 8M6001217, FI6900040</p>	 <p>18-5344 CONDENSER Replaces: 33706</p>	 <p>18-5345 CONDENSER Replaces: 33662, 898253003, 898253005, 33662Q, 6325, 8M6001218, FI6900031</p>	 <p>18-5346 CONDENSER Replaces: 58034, 81-64851</p>	 <p>18-5347 CONDENSER Replaces: 392-6324, 392-898253002, 8M6001249, FI6900023, FI6900032, FI6900083, FI6900189</p>
 <p>18-5402 ROTOR Replaces: 898253009 GM V-8 engines w/Delco HEI- 1998 and newer (except MPI engines with 555 ECM)</p>	 <p>18-5245 ROTOR Replaces: 884790, 898253013 For: Late model V-6, V-8 (Alpha/ Bravo 350 Mag, 5.0L, & MX 6.2L)</p>	 <p>18-5403 ROTOR Replaces: 392-9089, 392-9089T, 392-9767, 392- 9089Q, FI6900186 FI6900190</p>	 <p>18-5404-1 ROTOR Replaces: 391-7057, 391-5088, 391-7057T, 391- 898253029, 8M6001224, FI6901224</p>	 <p>18-5405 ROTOR Replaces: 808484, 808484 1, 898253010 Use with 18-5354 Distributor Cap Fits new GM style "Module in Cap" distributors - V-8 application</p>
 <p>18-5406 ROTOR Replaces: 811636, 811636 1, 898253011 Use with 18-5361 Distributor Cap 3.0L LX</p>	 <p>18-5407 ROTOR Replaces: 392-6326, 392-6326T, FI6900044</p>	 <p>18-5300 ROTOR Replaces: 33707 Fits: Flamethrower Distributors</p>	 <p>18-5408 ROTOR Replaces: 850485, 8504851, 898253012, 8M0062084, 804424 Use with 18-5362 Distributor Cap Fits new GM Style "Module in Cap" Distributors V6 Applications</p>	 <p>18-5418 ROTOR Replaces: 58217, 898253008, 58217Q</p>
 <p>18-5420 ROTOR Replaces: 65864, 78016</p>	 <p>① 18-5431D Display Package 18-5431 ROTOR ASSEMBLY Replaces: 13524A5, T1 V-8</p>	 <p>18-5432 ROTOR ASSEMBLY Replaces: 13524A6, 13524Q06, 13524A4, 19405A4, 90576A4 V-6</p>	 <p>18-5243 DISTRIBUTOR CAP Replaces: 888731, 898253T23 For: Late model V-6 (4.3L Alpha/ Bravo)</p>	 <p>18-5244 DISTRIBUTOR CAP Replaces: 884792, 898253T22 For: Late model V-8 (Alpha/Bravo 350 Mag, 5.0L, & MX 6.2L) Use wire set 18-8821-1</p>
 <p>18-5352 DISTRIBUTOR CAP Replaces: 392-9766, 392-9766Q1, 392-9766T, FI6900185 Prestolite</p>	 <p>18-5353 DISTRIBUTOR CAP Replaces: 392-9086, 392-9086T</p>	 <p>18-5354 DISTRIBUTOR CAP Replaces: 808483, 808483T3, 804483T 804418 Fits new GM style "Module in Cap" Distributors—V-8 applications. Use 18-5405 Rotor</p>	 <p>18-5361 DISTRIBUTOR CAP Replaces: 811635, 811635T3 Use 18-5406 Rotor 3.0L LX</p>	 <p>18-5362 DISTRIBUTOR CAP Replaces: 850484, 850484T, 850484T2 Fits new GM Style "Module in Cap" Distributors - V6 Applications Use 18-5408 Rotor</p>

 <p>18-5369 DISTRIBUTOR CAP Replaces: 392-6318, 392-6318T, FI6900184 Prestolite with gasket 18-5399</p>	 <p>18-5376 DISTRIBUTOR CAP Replaces: 391-5075, 391-5075Q1, FI6900148 Mallory</p>	 <p>18-5384 DISTRIBUTOR CAP Replaces: 33708</p>	 <p>18-5385 DISTRIBUTOR CAP Replaces: 393-9459, 393-9459Q1, 393-9459T, 33667, FI6900052</p>
 <p>18-5386 DISTRIBUTOR CAP Replaces: 33765, 33765T</p>	 <p>18-5389 DISTRIBUTOR CAP Replaces: 393-4988T, 393-4988T2, 393-4988, 393-3230</p>	 <p>18-5395 DISTRIBUTOR CAP Replaces: 16457A4, 805759T2, 805759T1, 805759A5, 805759A2, 805759A1, 90746A1, 43557A1, 43557 V-8</p>	 <p>18-5396 DISTRIBUTOR CAP Replaces: 13753A2, 815407A2 V-6</p>
 <p>18-5397 DISTRIBUTOR CAP Replaces: Mallory 9-29418 Fits: Ford 2.3L w/Mallory Distributor (87-90)</p>	 <p>18-5473 DISTRIBUTOR CAP Black Distributor Cap with Male Terminals for Flamethrower Distributors</p>	 <p>18-5474 DISTRIBUTOR CAP Red Distributor Cap with Male Terminals for Flamethrower Distributors</p>	<p>PKG OF 2</p>  <p>18-5399-9 DISTRIBUTOR CAP GASKET Replaces: 392-6329</p>

FEATURES

- Oil filled for better cooling and long life
- Low resistance and improved turn ratios produces the higher voltage needed to run larger spark plug gaps for added power and better fuel economy
- More windings maximize energy and reliability over the full RPM range
- Fits existing brackets for easy installation

 <p>18-5466 HI-PERFORMANCE IGNITION COIL 1.5 ohm (oil filled), black - 8 cylinder: Flame-Thrower 40,000 volt coil.</p> <ul style="list-style-type: none"> • Designed for use with the original Ignitor Electronic Conversion Kits • Can be used with other inductive ignition systems 	 <p>18-5469 HI-PERFORMANCE IGNITION COIL 3.0 ohm (oil filled), black - 4 & 6 cylinder: Flame-Thrower 40,000 volt coil.</p> <ul style="list-style-type: none"> • Designed for use with the original Ignitor Electronic Conversion Kits • Can be used with other inductive ignition systems 	 <p>18-5472 HI-PERFORMANCE IGNITION COIL 0.6 ohm (oil filled), black - 4, 6, & 8 cylinder: Flame-Thrower 45,000 volt coil.</p> <ul style="list-style-type: none"> • Super low 0.6 ohm resistance coil designed for use with the Ignitor II Hi Performance Electronic Conversion Kits • Compatible with capacitive discharge systems
--	---	--

Part No.	Description	Recommended Coil	Resistance Ohms	Part No.	Description	Recommended Coil	Resistance Ohms
18-5294	Electronic Conversion Kit	18-5469	3	18-5286	Hi Performance Electronic Conversion Kit	18-5472	0.6
18-5295	Electronic Conversion Kit	18-5469	3	18-5288	Hi Performance Electronic Conversion Kit	18-5472	0.6
18-5296-2	Electronic Conversion Kit	18-5466	1.5	18-5289	Hi Performance Electronic Conversion Kit	18-5472	0.6
18-5297	Electronic Conversion Kit	18-5469	3	18-5290	Hi Performance Electronic Conversion Kit	18-5472	0.6
18-5298	Electronic Conversion Kit	18-5466	1.5	18-5481	Flame-Thrower Distributor	18-5472	0.6
18-5299	Electronic Conversion Kit	18-5466	1.5	18-5482	Flame-Thrower Distributor	18-5472	0.6
18-5285	Hi Performance Electronic Conversion Kit	18-5472	0.6	18-5483	Flame-Thrower Distributor	18-5472	0.6

① Priced per Package

CAP APPLICATION BEGINS ON PAGE 686

 <p>18-5433 IGNITION COIL Replaces: 38547, 32193A2, 392-806529A1, 898253T24 DELCO 1115202 (Uses External Resistor)</p>	 <p>18-5438 IGNITION COIL Replaces: 392-7803A4, 392-805570A2 HEI Thunderbolt Ignition</p>	 <p>18-5465 IGNITION COIL Replaces: 392-863704T, 8M0054588 2001 and newer 4.3L, 5.0L, 5.7L & 6.2L with 555 ECM (OM300000 and up)</p>	 <p>18-7493 COIL Replaces: 392889925 For: 8.1L & 496 Mag OM315053 & UP</p>	 <p>18-7648 IGNITION COIL Replaces: 392-881732</p>
 <p>18-5442 IGNITION COIL Replaces: 806673T, T1</p>	 <p>18-5443 IGNITION COIL Replaces: 817378T, 817378, 898253T27</p>	 <p>18-5117 IGNITION MODULE Replaces: GM 10482803 Fits: MCM MIE 4.3L MPI, 5.0L MPI, 350 Mag MPI and MX 6.2L MPI engines with ECM555 (2001 & Up) S/N OM300000 & Up</p>	 <p>18-5107-1 IGNITION MODULE 4/6/8 cyl. Replaces: 811637001, 811637002, 811637T, 811637, 850487, 804412, 802464 Delco EST</p>	 <p>18-5464 IGNITION MODULE Fits: Sierra 18-5481, 18-5482 and 18-5483 Billet HI-PERFORMANCE ELECTRONIC DISTRIBUTORS (except HEI/EST)</p>
 <p>18-5488 IGNITION MODULE Replacement module for Mallory electronic distributors</p>	 <p>18-5108 PICK-UP COIL SENSOR Replaces: 811639, T V4/V6/V8 Delco EST</p>	 <p>18-5493 IGNITION PICKUP COIL ASSEMBLY Replacement pick-up coil for Accel Electronic Distributors</p>	 <p>18-5116-1 IGNITION SENSOR KIT Replaces: 87-861780A2, Q4, 87-892150A02 For: V-6 & V-8 with Thunderbolt ignition (1981-1997) nut connectors</p>	 <p>18-7556 CRANKSHAFT SENSOR Replaces: 864297001 Fits: Mercury 5.0L, 6.2L 1998-2010</p>
 <p>18-7642 PICK-UP ASSEMBLY Replaces: 898141 Fits: Engines equipped w/ Delco HVS distributor</p>	 <p>18-26810 GM HEI 4 TERMINAL PIGTAIL Fits: GM HEI Distributors w/4 terminals</p>	 <p>18-26811 GM HEI 2 TERMINAL PIGTAIL Fits: GM HEI Distributors w/2 terminals</p>	 <p>18-26812 HEI COIL GRAY CONNECTOR</p>	 <p>18-26813 HEI COIL BLACK CONNECTOR</p>
 <p>18-61051 SCREW KIT (4 PER PKG) Fits: Mercruiser V6 & V8 Thunderbolt Distributor Caps</p>	<div style="display: flex; justify-content: space-between; align-items: center;">  <h2 style="margin: 0;">FEATURES</h2> </div> <ul style="list-style-type: none"> • Senses current levels in the coil & adjusts the dwell to maintain peak energy throughout entire RPM range. • Develops, on average, 4 times more available energy between 3000 and 5000 RPM's and twice as much plug voltage as point-type systems. • Ignition energy is sustained and coil life is increased when peak current level is reached just prior to spark. • More stable timing. • Use with 18-5472 "Flame Thrower II" Coil for optimum performance 			

18-5285
HI-PERFORMANCE
ELECTRONIC
CONVERSION KIT
 Fits: 4 Cylinder Delco Distributors



18-5286
HI-PERFORMANCE
ELECTRONIC
CONVERSION KIT
 Fits: 6 Cylinder Delco Distributors



18-5288
HI-PERFORMANCE
ELECTRONIC CONVERSION KIT
 Fits: Most Prestolite V-8 Distributors with snap down cap



18-5289
HI-PERFORMANCE
ELECTRONIC CONVERSION KIT
 Fits: Most Prestolite Distributors with screw down cap



18-5290
HI-PERFORMANCE
ELECTRONIC CONVERSION KIT
 Fits: Most Mallory YL or YD 8 cylinder Distributors with clockwise and counter clockwise rotation



FEATURES

- Replaces point & condensers for true solid state ignition.
- Uses standard coil, cap and rotor.
- Easy to install, one-piece, 2-wire hook-up.
- Accurate to within 1/4° timing accuracy 0 to 6000 RPM range.
- Can be used with Flame Thrower 18-5466 & 18-5469.

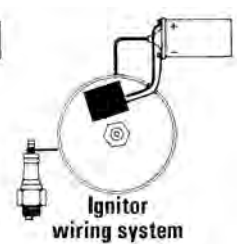

18-5294
ELECTRONIC CONVERSION KIT
 Fits: 6 Cyl. Delco Distributors



18-5295
ELECTRONIC CONVERSION KIT
 Fits: Most 4 Cyl. Prestolite Distributors (Except IBM7026)
 For: Onan, Universal, Waukesha, Wisconsin



18-5296-2
ELECTRONIC CONVERSION KIT
 Fits: Most Mallory YL or YD 8 cyl. Distributors with clockwise or counter clockwise rotation



① 18-5296-2D

18-5297
ELECTRONIC CONVERSION KIT
 For: 4 Cyl. GM



① 18-5297D

18-5298
ELECTRONIC CONVERSION KIT
 (with snap down cap)
 For: Most Prestolite V-8 Distributors



18-5299
ELECTRONIC CONVERSION KIT
 (with screw down cap)
 For: Most Prestolite V-8 Distributors
 Use with 18-5403 Style Rotor



① 18-5299D

APPLICATION BEGINS ON PAGE 686

① Items ending in "D" are Display Packaged - Regular number is Non-Display



FEATURES

- Distributors feature the Ignitor II ignition module with adaptive dwell control adjusts the spark timing over the entire RPM range to maximize performance
- Upper roller bearing and oil impregnated bronze sintered bottom bushing are installed and aligned bored for accuracy for maximum durability
- Machined heat treated gear with tight tolerances insures durability and consistent timing to maximize horsepower and performance. Complete with high dielectric strength cap and rotor for years of performance

Standard Rotation CCW Rotation

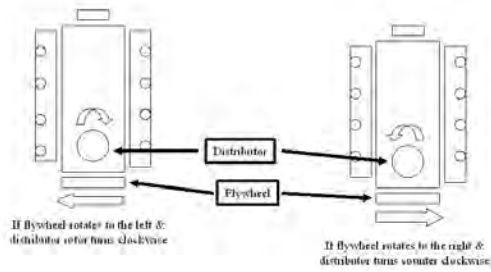

18-5481
HI-PERFORMANCE
ELECTRONIC DISTRIBUTOR
 Fits: Ford V-8 351 Windsor
 Replacement cap/rotor kit: 18-5266



18-5482
HI-PERFORMANCE
ELECTRONIC DISTRIBUTOR
 Fits: Ford V-8 351 Cleveland, 351M, 400, 429 and 460 engines
 Replacement cap/rotor kit: 18-5266



18-5483
HI-PERFORMANCE
ELECTRONIC DISTRIBUTOR
 Fits: Chevrolet marine small and big block engines (standard deck height)
 Replacement cap/rotor kit: 18-5266



18-5477
ELECTRONIC DISTRIBUTOR
 Fits: Ford 302 V-8 engines
 Replacement Cap/Rotor Kit **18-5266**



18-5478
ELECTRONIC DISTRIBUTOR
 Fits: Chrysler LA series V-8 engines
 Replacement Cap/Rotor Kit **18-5266**



18-5479
ELECTRONIC DISTRIBUTOR
 Fits: GM V-8 engines-reverse rotation
 Replacement Cap/Rotor Kit **18-5266**



18-5480
COMPLETE IGNITION
CONVERSION KIT
 Fits: GM SB & BB with Standard Deck Height
 —CONTAINS—

Part #	Description
18-5472	Coil
18-8803-2	Wire Set
18-5483	Distributor

18-26002-1
IGNITION SYSTEM KIT
 Fits: GM 4.3L/262 CID Even Fire Engines



18-5470
THUNDERBOLT IV V-8 DISTRIBUTOR
 Replaces: 805185A36
 Fits: GM V-8 engines
 Tune-Up Kit **18-5273**



18-5471
THUNDERBOLT IV V-6 DISTRIBUTOR
 Replaces: 805185A37
 GM V-6 engines
 Tune-Up Kit **18-5274**



18-5350
DISTRIBUTOR
 Replaces: 888751A03, 888751A02, 888751A1
 Fits: Vortec V-6 4.3L MPI (2002-UP) (S/N OM300000 and UP)



18-5351
DISTRIBUTOR
 Replaces: 884794A02, 884794A1
 Fits: Vortec V-8 2001 and up 5.0L/ 5.7L/ 6.2L MPI engines (S/N OM300000 and up)



18-5475
DISTRIBUTOR
 Replaces: 817377, 817377T
 Fits: 4 Cyl. GM w/ Delco EST Ignition
 Tune-Up Kit **18-5280**



18-5476
DISTRIBUTOR
 Replaces: 807964A1, 907964A1
 Fits: GM V-6 engines with Delco EST ignition HEI
 Tune-Up Kit **18-5278**



18-5484-1
ELECTRONIC DISTRIBUTOR
 Conventional Rotation
 Replaces: 805222A1
 Late Model HEI
 For: V8 — 262-454 & 502 except 384/ 409 and tall block engines
 • Designed as a plug-in replacement for GM-style fuel injection system distributors

—CONTAINS—	
Description	Part #
Distributor Cap	18-5354
Rotor	18-5405

Tune-Up Kit **18-5281**



18-26111-1
DISTRIBUTOR
 Replaces: Mallory YL648AV
 Fits: Mercruiser 3.7L L4/LH



18-5486-2
ELECTRONIC DISTRIBUTOR
 Conventional Rotation
 For: Chevrolet L4, 153 & 181 CID

—CONTAINS—	
Part #	Description
18-5397	Distributor Cap
18-5488	Module
18-5404-1	Rotor



**18-5487-2
ELECTRONIC DISTRIBUTOR**

Conventional Rotation
Replaces: 9-26309, Mallory YLM676AV
For: GM L6, 194, 230, 250, 292 CID

—CONTAINS—

Part #	Description
18-5488	Module
18-5404-1	Rotor



**18-5489-2
ELECTRONIC DISTRIBUTOR**
Conventional Rotation

For: Ford V8 351W CID

—CONTAINS—

Part #	Description
18-5376	Distributor Cap
18-5488	Module
18-5404-1	Rotor



**18-5494-2
ELECTRONIC DISTRIBUTOR**
Conventional Rotation

For: Chevrolet all V8 includes 482, 502, 540 CID (Except 348,409 & Tall Deck Big Block)

—CONTAINS—

Part #	Description
18-5376	Distributor Cap
18-5488	Module
18-5404-1	Rotor



**18-5495-2
ELECTRONIC DISTRIBUTOR**
Conventional Rotation

For: Ford V8 302 CID

—CONTAINS—

Part #	Description
18-5376	Distributor Cap
18-5488	Module
18-5404-1	Rotor



**18-5496-2
ELECTRONIC DISTRIBUTOR**

Replaces: YLM567CV
Conventional Rotation
For: Ford V8 351C — 460 CID

—CONTAINS—

Part #	Description
18-5376	Distributor Cap
18-5488	Module
18-5404-1	Rotor



**18-5497-2
ELECTRONIC DISTRIBUTOR**

Replaces: YLM579AV
Conventional Rotation
For: Chrysler V8 273,318 (67 & UP) 340, 360 CID "LA" engines

—CONTAINS—

Part #	Description
18-5376	Distributor Cap
18-5488	Module
18-5404-1	Rotor



**18-5309-1
DISTRIBUTOR**
Contact Controlled (Standard Rotation)

Replaces: Mallory YL512CV
For: Most Ford 302 CID V-8 Eng.
Tune-Up Kit 18-5251

—CONTAINS—

Part #	Description
18-5314	Contact Set
18-5338	Condenser
18-5404-1	Rotor



**18-5312-1
DISTRIBUTOR (Contact Controlled)**

Replaces: Mallory YL554CV
For: Most Ford 351 CID V-8 Eng.
Tune-Up Kit 18-5251



**18-5313-1
DISTRIBUTOR**
Contact Controlled (Standard Rotation)

Replaces: 17177A1, 91823A3, 816148A1, 74905A3, 68521A4, 68521A3, 13447A1
Mallory YL624AV
For: Most GM V-8 Engs. (small & large blocks) Mallory Tall Cap
Tune-Up Kit 18-5251

—CONTAINS—

Part #	Description
18-5314	Contact Set
18-5338	Condenser
18-5404-1	Rotor



**18-5315-1
DISTRIBUTOR**
Contact Controlled (Standard Rotation)

Replaces: 87581, 87581T, 62424, 58231, 52352, 33266, 195141
Mallory YL673AV
For: Most GM 4 Cyl. Engs. (120 & 140 HP)
Tune-Up Kit 18-5251

—CONTAINS—

Part #	Description
18-5314	Contact Set
18-5338	Condenser
18-5404-1	Rotor





**18-5498-2
ELECTRONIC DISTRIBUTOR**
Replaces: 9-26307; Mallory YLM624BV
For: GM V8, 482, 502, 540 CID (Except 348, 409 & Tall Deck Big Block) (Reverse Rotation)



**18-5316-1
DISTRIBUTOR**
Replaces: Mallory YL624BV
Fits: Most GM V8 (Reverse Rotation)



**18-5339-1
DISTRIBUTOR**
Replaces: 9-26103; Mallory YL566AV
For: GM V8 327



**18-26110-1
DISTRIBUTOR**
Replaces: 9-26110; Mallory YL579AV
For: Chrysler V8, 273, 318 (1967 & Up), 340 and 360 "LA" Engines



**18-26104-1
DISTRIBUTOR**
Replaces: 9-26104; Mallory YL567EV
For: Ford V8 351C



**18-26112-1
DISTRIBUTOR**
Replaces: 9-26112; Mallory YL676AV
Fits: GM L6, 194, 230, 250, 292 CID (Conventional Rotation)



**18-5512
I/L 4 DELCO EST CONVERSION KIT**
Description: Converts 4 Cylinder GM Engines to Electronic
Includes: Distributor, Coil, Ignition Wires, and Harnesses



**18-5513
V-6 DELCO EST CONVERSION KIT**
Description: Converts 6 Cylinder GM Engines to Electronic
Includes: Distributor, Coil, Ignition Wires, and Harnesses



**18-5514
V-8 DELCO EST CONVERSION KIT**
Description: Converts 8 Cylinder GM Engines to Electronic
Includes: Distributor, Coil, Ignition Wires, and Harnesses



**18-5518
I/L 4 SIERRA ELECTRONIC DISTRIBUTOR CONVERSION KIT**
Description: Converts 4 Cylinder GM Engines to Electronic
Includes: Distributor, Coil, Ignition Wires, and Harnesses



**18-5519
I/L 6 SIERRA ELECTRONIC DISTRIBUTOR CONVERSION KIT**
Description: Converts 6 Cylinder GM Engines to Electronic
Includes: Distributor, Coil, Ignition Wires, and Harnesses



**18-5520
V-8 SIERRA ELECTRONIC DISTRIBUTOR CONVERSION KIT**
Description: Converts 8 Cylinder GM Engines to Electronic
Includes: Distributor, Coil, Ignition Wires, and Harnesses

MODEL	Cyl.	Ignition Type	Year	Serial #	Tune-Up Kit	Contact Set	Rotor	Dist. Cap	Coil	Distributor	Spark Plug Wires
110	153/4	⊙	1963-1966	1537370-2044033	18-5250 ★	18-5311	18-5418	18-5385	18-5433	18-5315-1	18-8800-1
					18-5268 ☞						
120	153/L4	⊙	1964-1986	1666601 - B531853	18-5250 ★	18-5311	18-5418	18-5385	18-5433	18-5315-1	18-8800-1
					18-5268 ☞						
2.5L	153/L4	⊙	1987-1989	B531854 - C853255	18-5250	18-5311			18-5433		
PRESTOLITE REPLC IGN	4 CYL	⊙	1963-1989	1537370 - C853255		18-5303	18-5403				
140	181/L4	⊙	1968-1986	2508261 - B450800	18-5250 ★	18-5311	18-5418	18-5385	18-5433	18-5315-1	18-8800-1
					18-5268 ☞						
3.0L	181/L4	⊙	1987-1989	B450801 - C856558	18-5250	18-5311			18-5433		
3.0L	181/L4	⊙	1990-1991	C856559 - D504541		18-5303	18-5403		18-5433		
3.0L	181/L4	⊕	1990-1991	C856559 - D504541							18-8811-1
3.0L	181/L4	⊙	1991-1994	D504542 - F603999				18-5361	18-5443		18-8833-1
3.0L	181/L4	⊙	1998-2010	L010042 - & UP				18-5361	18-5443		18-8833-1
3.0L MPI	181/L4	⊙	2008-2010	A072812 - & UP				18-5361	18-5443		18-8833-1
3.0LX	181/L4	⊕	1990-1991	C856559 - D504541							18-8811-1
3.0LX	181/L4	⊙	1991-1997	D504542 - K999999				18-5361	18-5443		18-8833-1
3.0L/ LX	L4		1990-1995	C856559 - F603999	18-5262	18-5303	18-5403		18-5433	18-5315-1	18-8800-1
3.0L/ LX	L4		1990-1995	C856559 - F603999							18-8811-1
3.0L/LX	L4		1996 & UP	F604000 & Up	18-5280		18-5406	18-5361	18-5443		18-8833-1
PRESTOLITE REPLC IGN	4 CYL	⊙	1968-1991	2508261 - D504541		18-5303	18-5403				
165	224/L4	⊙	1987	B434941 - B774251	18-5250	18-5311			18-5433		
170	224/L4	⊙	1985-1986	6916779 - B434940	18-5250	18-5311			18-5433		
180	224/L4	⊙	1987	B436391 - B775248	18-5250	18-5311			18-5433		
180	224/L4	⊙	1987-1989	B436391 - B775248		18-5303	18-5403		18-5433		
190	224/L4	⊙	1985-1986	6916779 - B436390	18-5250	18-5311			18-5433		
3.7L	224/L4	⊙	1988-1989	B774252 - & UP	18-5250	18-5311			18-5433		
3.7LX	224/L4	⊙	1988-1989	B775249 - & UP	18-5250	18-5311			18-5433		
3.7LX	224/L4	⊙	1988-1989	B775249 - & UP		18-5303	18-5403		18-5433		
470	224/L4	⊙	1976-1984	4208730 - 6916778	18-5250 ★	18-5311	18-5418	18-5385	18-5433		18-8808-2
165, 170, 190 (224CID)	L4		1985-1989	6916779 & UP	18-5250 ★	18-5311	18-5418	18-5385	18-5433		18-8808-2
					18-5268 ☞						
180LX	L4		1987-1989	B436391 & UP	18-5250 ★	18-5311	18-5418	18-5385	18-5433		18-8808-2
					18-5268 ☞						
180LX	L4		1987-1989	B436391 & UP	18-5262	18-5303	18-5403		18-5433		18-8808-2
160, 165(250cid)	L6		1967-1981	2048022-5813433	18-5250 ★	18-5311	18-5418	18-5386	18-5433		18-8809-1
					18-5269 ☞						
485	224/L4	⊙	1980-1982	5685394 - 6218036	18-5250	18-5311			18-5433		
488	224/L4	⊙	1983-1984	6170297 - 6916778	18-5250	18-5311			18-5433		
PRESTOLITE REPLC IGN	4 CYL	⊙	2010			18-5303	18-5403				
140	194/L6	⊙	1963	1538930 - 1725960	18-5250 ★	18-5311	18-5418	18-5386		18-5312-1	18-8809-1
					18-5269 ☞						
150	230/L6	⊙	1964-1966	1666495 - 2048046	18-5250 ★	18-5311	18-5418	18-5386			18-8809-1
					18-5269 ☞						
160	250/L6	⊙	1967-1970	2048022 - 2771483	18-5250	18-5311		18-5386	18-5433		
165	250/L6	⊙	1971-1981	2771484 - 5813433	18-5250	18-5311		18-5386	18-5433		
200	292/L6	⊙	1969	2453769 - 2712072	18-5250 ★	18-5311	18-5418	18-5386	18-5433	18-5487-2	18-8809-1
					18-5269 ☞						
PRESTOLITE REPLC IGN	6 CYL	⊙	2010			18-5303	18-5403	18-5353	18-5433		
185 (4 bbl)	229/V-6	⊙	1983-1984	6330183 - 6919655	18-5262 ★	18-5303	18-5403	18-5353	18-5433		18-8801-1
					18-5276 ☞						
175	262/V-6	⊙	1987	B527955 - B773242			18-5432	18-5396	18-5438		
175, 185, 4.3	262/V-6		1985-1993	6919656 - F000877	18-5274		18-5432	18-5396	18-5438		18-8810-1
185 (2bbl)	262/V-6	⊙	1985-1987	6919656 - B527954			18-5432	18-5396	18-5438		

- ⊙ Mallory Ignition
- ⊙ Prestolite
- ⊙ Autolite
- ⊙ Mercury Ignition
- ⊙ Holley
- ⊙ Thunderbolt IV
- ⊙ With screw down cap
- ⊙ Delco
- ⊙ Electronic dist. (std rotation) excluding Thunderbolt ignition
- ⊙ Delco EST
- ⊕ Delco digital system
- ★ With out dist cap
- ☞ With dist cap
- ☛ Mercury HEI
- ☞ Delco HEI
- ⚡ Thunderbolt V
- ♥ Prestolite with clip down dist cap
- ⊕ Contact controlled dist. (Std. Rotation) excl. Thunderbolt ign.

MODEL	Cyl.	Ignition Type	Year	Serial #	Tune-Up Kit	Contact Set	Rotor	Dist. Cap	Coil	Distributor	Spark Plug Wires
205	262/V-6	⊙	1985-1987	A331455 - B775129			18-5432	18-5396	18-5438		
205, 4.3LX 4bbl	262/V-6		1985-1996	A331455 - F802999	18-5274		18-5432	18-5396	18-5438		18-8810-1
262 TBI (GEN +)	262/V-6	⊙	1996-1997	F803800 - K999999					18-5443		18-8835-1
4.3L (2bbl)	262/V-6	⊙	1988-1996	B773243 - F802999			18-5432	18-5396	18-5438		
4.3L (2bbl) (GEN +)	262/V-6	⊙	1998-2010	L010044 & UP			18-5432	18-5396			
4.3L EFI (GEN +) (TBI)	262/V-6	⊙	1998	L012009 - L359999					18-5438		18-8835-1
4.3L EFI (GEN +) (TBI)	262/V-6	⊙	1999-2001	L360000 - M299999			18-5432	18-5396	18-5438		
4.3L MPI	262/V-6	⊙	2002-2010	M300000 & UP	18-5246		18-5245	18-5243	18-5465	18-5350	18-8829-1
4.3LH (GEN +) (4bbl)	262/V-6	⊙	1998-2002	L010044 - M614999			18-5432	18-5396	18-5438		
4.3LX (4bbl)	262/V-6	⊙	1988-1996	B775130 - F802999			18-5432	18-5396	18-5438		
4.3LX (GEN +) (2bbl)	262/V-6	⊙	1996-1997	F803000 - K999999			18-5432	18-5396	18-5438		
4.3L/LH/LX/LXH	V6		1996-2001	F803000 & UP	18-5274		18-5432	18-5396	18-5438		18-8810-1
Alpha(Gen+)											
4.3L/LH/LX/LXH	V6		1996-2001	F803000 & UP	18-5274		18-5432	18-5396	18-5438		18-8810-1
Bravo(Gen+)											
4.3L EFI,262	V6		1996-1998	F803000- L359999	18-5278		18-5408	18-5362	18-5443		18-8810-1
Mag(TBI)(Gen+)											
4.3L EFI(TBI)	V6		1996 & up	L012009 - L359999	18-5278		18-5408	18-5362	18-5443	18-5476	18-8835-1
(Gen+)				L360000 & UP	18-5274		18-5432	18-5396	18-5438		18-8835-1
4.3L EFI(TBI)	V6		1999-2001	L360000 & UP	18-5274		18-5432	18-5396	18-5438		18-8810-1
215 MCM & MIE (FORD)	302/V-8	⊙	1970-1972	2781153 - 3563181	18-5253 ★	18-5318	18-5402	18-5389	18-5433	18-5495-2 ⊙	18-8803-2
					18-5267 ☞					18-5309-1 ⊕	
215 MCM & MIE (FORD)	302/V-8	⊙	1970-1972	2781153 - 3563181	18-5251 ★	18-5314	18-5404-1	18-5376	18-5433	18-5495-2 ⊙	18-8803-2
					18-5271 ☞					18-5309-1 ⊕	
225 MCM & MIE (FORD)	302/V-8	⊙	1973-1974	3385721 - 4166999	18-5253 ★	18-5318	18-5420	18-5389	18-5433	18-5495-2 ⊙	18-8803-2
Ford(302cid)					18-5267 ☞					18-5309-1 ⊕	
225 MCM & MIE (FORD)	302/V-8	⊙	1973-1974	3385721 - 4166999	18-5251 ★	18-5314	18-5404-1	18-5376	18-5433	18-5495-2 ⊙	18-8803-2
					18-5271 ☞					18-5309-1 ⊕	
225 MCM & MIE (FORD)	302/V-8	⊙	1973-1974	3385721 - 4166999	18-5254 ★	18-5317	18-5420	18-5389	18-5433	18-5495-2 ⊙	18-8803-2
					18-5267 ☞					18-5309-1 ⊕	
888 (FORD)	302/V-8	⊙	1971-1977	3108723 - 4887829	18-5254	18-5317	18-5420	18-5389	18-5433	18-5495-2 ⊙	18-8803-2
										18-5309-1 ⊕	
888 (FORD)	302/V-8	⊙	1971-1977	3108723 - 4887829	18-5253	18-5318	18-5420	18-5389	18-5433	18-5495-2 ⊙	18-8803-2
888 (FORD)	302/V-8	⊙	1971-1977	3108723 - 4887829	18-5258 ★	18-5303	18-5407	18-5369	18-5433	18-5495-2 ⊙	
					18-5277 ☞					18-5309-1 ⊕	18-8803-2
888 (FORD)	302/V-8	⊙	1971-1977	3108723 - 4887829	18-5251 ★	18-5314	18-5404-1	18-5376	18-5433	18-5495-2 ⊙	
					18-5271 ☞					18-5309-1 ⊕	18-8803-2
190 (GM 283)	283/V-8	⊙	1963-1964	1564539 - 1730903	18-5252	18-5310	18-5417	18-5384	18-5438	18-5498-1 ⊙	
										18-5494-2 ⊙	
										18-5313-1 ⊕	
198 MIE	305/V-8	⊙	1977	4776402 - 4931099		18-5314	18-5404-1		18-5433		
200 (5.0L)	305/V-8	⊙	1985-1995	6899058 - F600999			18-5431	18-5395	18-5438		
228	305/V-8	⊙	1977-1982	4765100 - 6218461		18-5314	18-5401-1		18-5433		
228	305/V-8	⊙	1982-1984	6218462 - 6899268			18-5431	18-5395	18-5438		
228 MIE	305/V-8	⊙	1977-1980	4765100 - 5907057		18-5314	18-5401-1		18-5433		
228 MCM & MIE	305/V-8		1977-1984	4765100 - 6218461	18-5251 ★	18-5314	18-5404-1	18-5376	18-5433		18-8803-2
					18-5271 ☞					18-5498-1 ⊙	
228	305/V-8		1985-1986	6218462 - 6899268	18-5273		18-5431	18-5395	18-5438	18-5494-2 ⊙	18-8804-1
										18-5498-1 ⊙	
230, 5.0L/LX MIE	305/V-8		1981-1995	5907058 - F600999	18-5273		18-5431	18-5395	18-5438	18-5494-2 ⊙	18-8804-1
										18-5498-1 ⊙	
198, 898 MCM &	305/V-8		1977-1982	4776402 - 6218461	18-5251 ★	18-5314	18-5404-1	18-5376	18-5433	18-5494-2 ⊙	18-8803-2
					18-5271 ☞					18-5498-1 ⊙	
230	305/V-8	⊙	1985-1987	6899269 - MB773739			18-5431	18-5395	18-5438		

- ⊙ Mallory Ignition
- ⊙ Prestolite
- ⊙ Autolite
- ⊙ Mercury Ignition
- ⊙ Holley
- ⊙ Thunderbolt IV
- ⊙ With screw down cap
- ⊙ Delco
- ⊙ Electronic dist. (std rotation) excluding Thunderbolt ignition
- ⊙ Delco EST
- ⊙ Delco digital system
- ★ With out dist cap
- ☞ With dist cap
- ☛ Mercury HEI
- ☛ Delco HEI
- ☛ Thunderbolt V
- ♥ Prestolite with clip down dist cap
- ⊕ Contact controlled dist. (Std. Rotation) excl. Thunderbolt ign.

MODEL	Cyl.	Ignition Type	Year	Serial #	Tune-Up Kit	Contact Set	Rotor	Dist. Cap	Coil	Distributor	Spark Plug Wires
230 MIE	305/V-8	⊙	1981-1987	5907058 - B788151			18-5431	18-5395	18-5438		
5.0L (GEN +)	305/V-8	♣	1998-2010	L015751 & UP			18-5431	18-5395	18-5438		
5.0L EFI (Gen+)	305/V-8	⊙	1998	L012052 - L331630	18-5281		18-5405	18-5354	18-5442	18-5494-2 ⊙	18-8836-1
										18-5498-1 ⊙	
5.0L EFI (GEN +)	305/V-8	⊙	1998	L331651 - L339999					18-5442		
5.0L EFI (GEN +)	305/V-8	⊙	1999	L331631 - L331650			18-5431		18-5438		
5.0L MPI	305/V-8	⊙	2002-2010	M300000 & UP							18-8828-1
5.0L MIE	305/V-8	⊙	1988	B788152 - C396832			18-5431	18-5395	18-5438		
5.0LX	305/V-8	⊙	1988-1995	B773740 - F600999			18-5431	18-5395			
898	305/V-8	⊙	1977-1982	4762210 - 621461		18-5314	18-5404-1		18-5433		
898	305/V-8	⊙	1983-1984	6218462 - 6899057			18-5431	18-5395	18-5438		
350MAG MPI	V8		1998-2001	L302200 & UP	18-5273		18-5431	18-5395	18-5438	18-5494-2	
(Gen+) & MIE(Gen+)										18-5498-1	
350 MAG MPI	V8		2001-2004	M300000 & UP	18-5247		18-5245	18-5244	18-5465	18-5351	
350 MAG MPI					18-5247		18-5245	18-5244			
HORIZON											
350 MAG	V8		1999-2001	L304700 & UP	18-5273		18-5431	18-5395	18-5438	18-5494-2	
HORIZON MIE										18-5498-1	
350 MAG HORIZON	V8		2001-2004	M300000 & Up	18-5247		18-5245	18-5244	18-5465	18-5351	
MIE											
350MAG MPI	V8		1999-2001	L304600 & up	18-5273		18-5431	18-5395	18-5438	18-5494-2	
SKI(Gen+)										18-5498-1	
350MAG SKI	V8		1991-1996	D505450 - K040399	18-5273		18-5431	18-5395	18-5438	18-5494-2	
										18-5498-1	
350MAG SKI	V8		1991-1996	D505450 - K040399	18-5273		18-5431	18-5395	18-5438	18-5494-2	
										18-5498-1	
350MAG SKI	V8		1991-1997	D505450 - K999999	18-5273		18-5431	18-5395	18-5438	18-5494-2	
										18-5498-1	
225 (GM)	327/V-8	⊙	1963-1969	1539620 - 2694014	18-5252 ★	18-5310	18-5417	18-5384	18-5433	18-5494-2 ⊙	18-8803-2
					18-5270 ☞					18-5498-1 ⊙	
										18-5313-1 Ⓢ	
225 MIE (GM)	327/V-8	♣	1968	2278647 - 2694014	18-5282		18-5420	18-5389		18-5494-2 ⊙	18-8803-2
										18-5498-1 ⊙	
250 MCM & MIE	327/V-8	♣	1968-1969	2314301 - 2639854	18-5282		18-5420	18-5389		18-5494-2 ⊙	18-8803-2
										18-5498-1 ⊙	
250	350/V-8	⊙	1977	4768000 - 4908849	18-5251 ★	18-5314	18-5404-1	18-5376	18-5433	18-5494-2 ⊙	18-8803-2
					18-5271					18-5498-1 ⊙	
250 MCM & MIE (GM)	350/V-8	⊙	1975-1976	3258728 - 4521254		18-5317	18-5420	18-5389	18-5433		
255 MCM (GM)	350/V-8	⊙	1976	4498701 - 4767999		18-5314	18-5404-1		18-5433		
255 MIE	350/V-8	⊙	1976-1980	4498701 - 5907057		18-5314	18-5404-1				
260	350/V-8	⊙	1978-1982	4908850 - 6218461		18-5314	18-5404-1		18-5433		
270 MCM & MIE	350/V-8	♣	1969-1972	2851074 - 3385720	18-5282		18-5420	18-5389	332- 4895A 8	18-5494-2 ⊙	18-8803-2
										18-5498-1 ⊙	
280 TRS	350/V-8	⊙	1975	4176250 - 4499390		18-5317	18-5420	18-5389	18-5433		
280 TRS	350/V-8	⊙	1976	4499391 - 4770199	18-5251 ★	18-5314	18-5404-1	18-5376	18-5433	18-5494-2 ⊙	18-8803-2
					18-5271 ☞					18-5498-1 ⊙	
										18-5313-1 Ⓢ	
300	350/V-8	⊙	1985-1986	6668677 - B430367			18-5431	18-5395	18-5438		
320 EFI	350/V-8	⊙	1987-1989	A543604 - C622418			18-5431	18-5395	18-5438		
350 MAG ALPHA	350/V-8	⊙, ♣	1986-1997	A635178 - K999999			18-5431	18-5395	18-5438		
350 MAG ALPHA EFI (Gen+)	350/V-8	⊙	1996-1997	F800300 - K999999	18-5281		18-5405	18-5354	18-5442	18-5494-2 ⊙	18-8836-1
350 MAG BRAVO MPI	350/V-8	⊙	1995-1997	F415189 - K999999				18-5354	18-5443	18-5498-1 ⊙	18-8836-1
350 MAG EFI SKI	350/V-8	⊙	1994-1997	F215561 - K999999				18-5354	18-5443		18-8832-1

- ⊙ Mallory Ignition
- ⊙ Prestolite
- ⊙ Autolite
- ⊙ Mercury Ignition
- ⊙ Holley
- ⊙ Thunderbolt IV
- ⊙ With screw down cap
- ⊙ Delco
- ⊙ Electronic dist. (std rotation) excluding Thunderbolt ignition
- ⊙ Delco EST
- ♣ Delco digital system
- ★ With out dist cap
- ☞ With dist cap
- ♣ Mercury HEI
- ⊙ Delco HEI
- ♣ Thunderbolt V
- ♥ Prestolite with clip down dist cap
- Ⓢ Contact controlled dist. (Std. Rotation) excl. Thunderbolt ign.

MODEL	Cyl.	Ignition Type	Year	Serial #	Tune-Up Kit	Contact Set	Rotor	Dist. Cap	Coil	Distributor	Spark Plug Wires
350 MAG MPI (GEN +)	350/V-8	☐	1998	L010019 - L325962	18-5281		18-5405	18-5354	18-5442	18-5494-2☉	18-8832-1
										18-5498-1☉	
350 MAG MPI (GEN +)	350/V-8	☐	1999-2001	L325953 - M999999			18-5431	18-5395	18-5438		
350 MAG MPI	350/V-8	☐	2002-2010	M300000 & UP				18-5244			18-8828-1
350 MAG MPI HORIZON	350/V-8	☐	2002-2007	M300000 - A299999				18-5244			
350 MAG MPI HORIZON MIE	350/V-8	☐	1999-2001	L304700 - M299999			18-5431	18-5395	18-5438		
350 MAG MPI HORIZON MIE	350/V-8	☐	2002-2007	M300000 - A089999				18-5244			
350 MAG MPI MIE (GEN +)	350/V-8	☐	1998	L002008 - L302199	18-5281		18-5405	18-5354	18-5443	18-5494-2☉	18-8832-1
										18-5498-1☉	
350 MAG MPI MIE (GEN +)	350/V-8	☐	1998-2001	L302200 - M299999	18-5273		18-5431	18-5395	18-5438		18-8834-1
350 MAG MPI MIE	350/V-8	☐	2002-2007	M300000 - A089999				18-5244			18-8828-1
350 MAG MPI SKI	350/V-8	☐	1995-1998	F350583 - L304599	18-5281		18-5405	18-5354	18-5443	18-5494-2☉	18-8836-1
										18-5498-1☉	
350 MAG MPI SKI (GEN +)	350/V-8	☐	1999-2001	L304600 - M2999999			18-5431	18-5395	18-5438		
350 MAG MPI SKI	350/V-8	☐	2002-2007	M300000 - A089999				18-5244			18-8828-1
350 MAG SKI	350/V-8	☉, ⬆	1991-1997	D505450 - K999999			18-5431	18-5395	392-805570A 2		
350MAG BRAVO	V8	☐	1995-1998	F415189 - L325952	18-5281		18-5405	18-5354	18-5443	18-5494-2☉	18-8836-1
MPI &(Gen+)										18-5498-1☉	
350MAG EFI SKI	V8	☐	1996-1997	F820707 - K999999	18-5281		18-5405	18-5354	18-5443	18-5494-2☉	18-8832-1
&(Gen+)										18-5498-1☉	
5.0L Alpha &	V8	☐	1998-2001	L015751 & up	18-5273		18-5431	18-5395	18-5438	18-5494-2☉	18-8821-1
Bravo(Gen+)										18-5498-1☉	
5.0L EFI (Gen +)	V8	☐	1999-2001	L331631 & up	18-5273		18-5431	18-5395	18-5438	18-5494-2☉	18-8834-1
										18-5498-1☉	
5.0L MCM/MIE MPI,	V8	☐	2001 & up	M300000 & UP	18-5247		18-5245	18-5244	18-5465	18-5351	18-8828-1
198, 898, 5.0L GM	V8	☐	1983-1984	6218462 - 6899057	18-5273		18-5431	18-5395	18-5438	18-5494-2	18-8804-1
(305cid)										18-5498-1	
200, 5.0L GM	V8	☐	1985-1995	6218462 - F600999	18-5273		18-5431	18-5395	18-5438	18-5494-2	18-8804-1
(305cid)										18-5498-1	18-8834-1
200, 5.0L GM	V8	☐	1987-1995	B525982 - F600999	18-5273		18-5431	18-5395	18-5438	18-5494-2	
(305cid)										18-5498-1	
5.7L	350/V-8	☉, ⬆	1988-2010	6218462 & UP			18-5431	18-5395			18-8828-1
5.7L EFI	350/V-8	☐	1995-1997	F225560 - K999999				18-5354			18-8828-1
5.7L EFI (GEN +)	350/V-8	☐	1998	L010035 - L325976				18-5354	18-5442		
5.7L EFI (GEN +)	350/V-8	☐	1998	L326000 - L331598				18-5354	18-5442		
5.7L EFI (GEN +)	350/V-8	☐	1998	L336000 - L339999				18-5354	18-5442		
5.7L EFI (GEN +)	350/V-8	☐	1999	L325977 - L325999			18-5431	18-5395	18-5438		
5.7L EFI (GEN +)	350/V-8	☐	1999	L331599 - L331991			18-5431	18-5395	18-5438		
5.7L EFI (GEN +)	350/V-8	☐	1999	L335716 - L335999			18-5431	18-5395	18-5438		
5.7L EFI (GEN +)	350/V-8	☐	1999-2001	L340000 - M299999			18-5431	18-5395	18-5438		
5.7L EFI MIE (GEN +)	350/V-8	☐	1997	K040300 - K999999					18-5442		
5.7L MIE	350/V-8	☉, ⬆	1988-2010	B788152 & UP			18-5431	18-5395			
5.7L MPI HORIZON MIE	350/V-8	☐	2008-2010	A090000 & UP				18-5244			18-8821-1
5.7L MPI MIE	350/V-8	☐	2008-2010	A090000 & UP				18-5244			
5.7L MPI SKI	350/V-8	☐	2008-2010	A090000 & UP				18-5244	18-5433		18-8821-1
5.7L SKI	350/V-8	☉	1985-1995	A338553 - F775199	18-5251 ★	18-5314	18-5404-1	18-5376	18-5433	18-5494-2☉	18-8802-1
					18-5271 ☐					18-5498-1☉	
5.7L SKI	350/V-8	☉	1985-1996	A338553 - F775199	18-5262 ★	18-5303	18-5403	18-5352	18-5433	18-5494-2☉	18-8802-1
					18-5275 ☐					18-5498-1☉	
5.7L SKI	350/V-8	☉, ⬆	1987-2010	B514627 & UP			18-5431	18-5395			
5.7LX	350/V-8	⬆	1995-1997	F601000 - K999999			18-5431	18-5395	18-5438		
5.7LX BRAVO EFI (GEN +)	350/V-8	☐	1996-1997	F800300 - K999999				18-5354			
5.7LX EFI	350/V-8	☐	1996-1997	F752400 - K999999	18-5281		18-5405	18-5354	18-5442	18-5494-2☉	18-8836-1
										18-5498-1☉	

- ☉ Mallory Ignition
- ☐ Prestolite
- ☐ Autolite
- ☉ Mercury Ignition
- ☉ Holley
- ☉ Thunderbolt IV

- ☐ With screw down cap
- ☉ Delco
- ☉ Electronic dist. (std rotation) excluding Thunderbolt ignition
- ☉ Delco EST
- ⬆ Delco digital system
- ★ With out dist cap

- ☐ With dist cap
- ☐ Mercury HEI
- ☐ Delco HEI
- ⬆ Thunderbolt V
- ☐ Prestolite with clip down dist cap
- ☐ Contact controlled dist. (Std. Rotation) excl. Thunderbolt ign.

MODEL	Cyl.	Ignition Type	Year	Serial #	Tune-Up Kit	Contact Set	Rotor	Dist. Cap	Coil	Distributor	Spark Plug Wires
5.7L MIE & SKI	V8		1998 & up	L002003 & up	18-5273 ★		18-5431	18-5395	18-5438		18-8830-1
5.7L EFI & (Gen+)	V8		1995-1998	F225560-L339999	18-5281 ☞		18-5405	18-5354	18-5442	18-5494-2 Ⓣ	18-8836-1
										18-5498-1 Ⓣ	
5.7L EFI & (Gen+)	V8		1999-2001	L325977 & UP	18-5273		18-5431	18-5395	18-5438	18-5494-2 Ⓣ	18-8834-1
										18-5498-1 Ⓣ	
5.7L SKI	V8		1987-1997	B514627 - K999999	18-5273		18-5431	18-5395	18-5438	18-5494-2 Ⓣ	18-8821-1
										18-5498-1 Ⓣ	
5.7L SKI	V8		1987-1995	B514627 - F775199	18-5273		18-5431	18-5395	18-5433	18-5494-2 Ⓣ	18-8821-1
										18-5498-1 Ⓣ	
5.7L SKI	V8		1998-2001	L002005 & up	18-5273		18-5431	18-5395	18-5438	18-5494-2 Ⓣ	18-8821-1
										18-5498-1 Ⓣ	
260, 350MAG	V8		1987-1995	B525982 - F600999	18-5273		18-5431	18-5395	18-5438	18-5494-2	18-8804-1
5.7L SKI/ ALPHA/ BRAVO(350cid)										18-5498-1	
260, 350MAG, 5.7L ALPHA/ BRAVO(350cid)	V8		1987-1995	B525982 - F600999	18-5273		18-5431	18-5395	18-5438	18-5494-2	18-8821-1
										18-5498-1	
350MAG, 5.7L/ LX ALPHA &	V8		1994-2001	F353525 & UP	18-5273		18-5431	18-5395	18-5438	18-5494-2	18-8821-1
										18-5498-1	
BLACK SCORPION SKI (GEN+)	350/V-8	☞	1996-2003	F800000 - M391599				18-5354	18-5443		18-8832-1
BLACK SCORPION SKI (GEN+)	350/V-8	☞	2003-2007	M391600 - W698432				18-5395			
SCORPION 350	350/V-8	☞	2008-2010	W698433 & UP				18-5395			
BLACK SCORPION	V8		1996	F800000 - K040000	18-5281		18-5405	18-5354	18-5443	18-5494-2	18-8832-1
SKI(Gen+) (350cid)										18-5498-1	
BLACK SCORPION	V8		1997-1998	K040001 - L005600	18-5281		18-5405	18-5354	18-5443	18-5494-2	18-8824-1
SKI(Gen+) (350cid)										18-5498-1	
BLACK SCORPION	V8		1998-2002	L005601 - M391599	18-5281		18-5405	18-5354	18-5443	18-5494-2	18-8822-1
SKI(Gen+) (350cid)										18-5498-1	
233 MCM & MIE (FORD)	351/V-8	Ⓣ	1975-1977	4173000 - 4902304	18-5260 ★ 18-5275 ☞	18-5303	18-5409	18-5352	18-5433	18-5489-2 Ⓣ	18-8803-2
										18-5312-1 Ⓣ	
233 MCM & MIE (FORD)	351/V-8	▼	1975-1977	4173000 - 4902304	18-5258 ★ 18-5277 ☞	18-5303	18-5407	18-5369	18-5433	18-5489-2 Ⓣ	18-8803-2
										18-5312-1 Ⓣ	
233 MCM & MIE (FORD)	351/V-8	Ⓣ	1975-1977	4173000 - 4902304	18-5254	18-5317	18-5420	18-5389	18-5433	18-5489-2 Ⓣ	18-8803-2
										18-5312-1 Ⓣ	
255 MCM & MIE	351/V-8		1973-1974	3385721 - 4166999	18-5254	18-5317	18-5420	18-5389	18-5433	18-5489-2	18-8803-2
										18-5312-1	
255 MCM & MIE	351/V-8		1973-1974	3385721 - 4166999	18-5251 18-5271	18-5314	18-5404-1	18-5376	18-5433	18-5489-2	18-8803-2
										18-5312-1	
255 MIE & MCM (FORD)	351/V-8	Ⓣ	1973-1980	3258728 - 5907057		18-5314	18-5404-1		18-5433		
255 MIE & MCM (FORD)	351/V-8	Ⓣ	1973-1980	3258728 - 5907057			18-5420	18-5389	18-5433		
255, 260MCM & MIE(350cid)	V8		1975-1982	3258728 - 6218461	18-5251 18-5271	18-5314	18-5404-1	18-5376	18-5433	18-5494-2 Ⓣ	18-8803-2
										18-5498-1 Ⓣ	
										18-5313-1 Ⓣ	
255MCM & MIE (350cid)	V8		1975-1980	4498701 - 5907057	18-5254	18-5317	18-5420	18-5389	18-5433	18-5494-2 Ⓣ	18-8803-2
										18-5498-1 Ⓣ	
										18-5313-1 Ⓣ	
260,350MAG, 300, 320EFI	V8		1982-1994	6218462 - F600999	18-5273		18-5431	18-5395	18-5438	18-5494-2 Ⓣ	18-8804-1
										18-5498-1 Ⓣ	
										18-5313-1 Ⓣ	
										18-5494-2 Ⓣ	18-8804-1
										18-5498-1 Ⓣ	
377 MAG	377/V-8	☞	2008-2010	A300000 & UP				18-5244			
377 SCORPION MCM	377/V-8	☞	1999-2005	L416146 - M907201	18-5281		18-5405	18-5354	18-5443	18-5494-2 Ⓣ	
										18-5498-1 Ⓣ	

- Ⓣ Mallory Ignition
- Ⓣ Prestolite
- Ⓣ Autolite
- Ⓣ Mercury Ignition
- Ⓣ Holley
- Ⓣ Thunderbolt IV
- Ⓣ With screw down cap
- Ⓣ Delco
- Ⓣ Electronic dist. (std rotation) excluding Thunderbolt ignition
- Ⓣ Delco EST
- Ⓣ Delco digital system
- ★ With out dist cap
- ☞ With dist cap
- ☞ Mercury HEI
- ☞ Delco HEI
- ☞ Thunderbolt V
- ▼ Prestolite with clip down dist cap
- Ⓣ Contact controlled dist. (Std. Rotation) excl. Thunderbolt ign.

MODEL	Cyl.	Ignition Type	Year	Serial #	Tune-Up Kit	Contact Set	Rotor	Dist. Cap	Coil	Distributor	Spark Plug Wires
377 SCORPION SKI	377/V-8		1997-1998	K000656 - L00314	18-5281		18-5405	18-5354	18-5443	18-5494-2 ①	
										18-5498-1 ①	
MX 6.2L MPI	377/V-8	☛	2000-2001	L680003 - M299999	18-5273		18-5431	18-5395	18-5438	18-5494-2 ①	18-8834-1
										18-5498-1 ①	
MX 6.2L MPI (377CID)	377/V-8	Ⓢ	2002-2007	M300000 - A299999	18-5247		18-5245	18-5244			18-8828-1
MX 6.2L MPI	377/V-8		2001-2004	M300000 & UP	18-5247		18-5245	18-5244	18-5465	18-5351	18-8828-1
MX 6.2L MPI HORIZON	377/V-8	Ⓢ	2002-2007	M300000 - A299999	18-5247		18-5245	18-5244	18-5465	18-5351	18-8828-1
MX6.2L MPI HORIZON MIE	377/V-8	Ⓢ	2002-2010	M300000 & UP	18-5247		18-5245	18-5244	18-5465	18-5351	18-8828-1
MX 6.2L MPI MIE	377/V-8	☛	2000-2001	L670000 - M299999			18-5431	18-5395	18-5438		
MX 6.2L MPI MIE	377/V-8	Ⓢ	2002-2010	M300000 - & UP				18-5244			18-8828-1
MX 6.2L MPI SKI	377/V-8	Ⓢ	2002-2007	M317000 - A089999	18-5247		18-5245	18-5244			18-8828-1
MX 6.2L BLACK SCORPION SKI	377/V-8	Ⓢ	2001-2003	F800000 - M391599				18-5354			N/A
MX 6.2L BLACK SCORPION SKI	377/V-8	☛	2003-2007	M391600 - W698432				18-5395			
SCORPION 377	377/V-8	☛	2008-2010	W698433 & UP				18-5395			
325 MCM & MIE	427/V-8	⚡	1969-1974	2278747 & UP	18-5282		18-5420	18-5389		18-5494-2 ①	18-8803-2
										18-5498-1 ①	
330 MCM & MIE	454/V-8	Ⓢ	1977-1981	4623115-6083144	18-5251 ★	18-5314	18-5404-1	18-5376	18-5433	18-5494-2 ①	18-8803-2
					18-5271 ☞					18-5498-1 ①	
										18-5313-1 ②	
330 MCM & MIE	454/V-8	⚡	1977-1981	4623115-6083144	18-5282		18-5420	18-5389		18-5494-2 ①	18-8803-2
										18-5498-1 ①	
										18-5313-1 ②	
330	454/V-8	Ⓢ	1982-1987	6083145 - B816540			18-5431	18-5395	18-5438		
330, 340, 7.4L	454/V-8		1981-1992	5889914 - D715493	18-5273		18-5431	18-5395	18-5438	18-5494-2 ①	18-8804-1
MCM & MIE(454cid)										18-5498-1 ①	
340 MIE	454/V-8	Ⓢ	1981-1987	5889914 - B788365			18-5431	18-5395	18-5438		
350 MIE	454/V-8	⚡	1974-1976	3780450 - 4623109	18-5282		18-5420	18-5389		18-5494-2 ①	18-8803-2
										18-5498-1 ①	
370 TRS	454/V-8	Ⓢ	1978-1985	4179554 - 6721527	18-5251 ★	18-5314	18-5404-1	18-5376	18-5433	18-5494-2 ①	18-8803-2
					18-5271 ☞					18-5498-1 ①	
										18-5313-1 ②	
370 TRS	454/V-8	Ⓢ	1978-1985	4883520 - 6721527	18-5254	18-5317	18-5420	18-5389	18-5433	18-5494-2 ①	18-8803-2
										18-5498-1 ①	
										18-5313-1 ②	
370 TRS	454/V-8	Ⓢ	1985-1987	6721528 - B714586	18-5273		18-5431	18-5395	18-5433	18-5494-2 ①	18-8804-1
										18-5498-1 ①	
400 TRS	454/V-8	Ⓢ	1980-1986	5668232 - B457644		18-5314	18-5404-1		18-5433		
400 TRS	454/V-8	Ⓢ	1980-1986	5668232 - B457644		18-5317		18-5389	18-5433		
420	454/V-8	Ⓢ	1987-1989	A398941 - B622418	18-5273		18-5431	18-5395	18-5438	18-5494-2 ①	18-8837-1
										18-5498-1 ①	
425	454/V-8	Ⓢ	1990-1993	B622419 - D937011			18-5431	18-5395	18-5438		18-1837-1
440 TRS	454/V-8	Ⓢ	1983-1986	6181070 - B485220		18-5314	18-5404-1		18-5433		
450	454/V-8	Ⓢ	1995-1996	F347100 - F347277	18-5273		18-5431	18-5395	18-5438	18-5494-2 ①	
										18-5498-1 ①	
454 MAG ALPHA	454/V-8	Ⓢ	1986-1997	A631894 - B785148	18-5273		18-5431	18-5395	18-5438	18-5494-2 ①	18-8804-1
										18-5498-1 ①	
454 MAG BRAVO	454/V-8	Ⓢ, ⚡	1988-1997	B721206 - K999999			18-5431	18-5395	18-5438		
454 MAG EFI	454/V-8	Ⓢ	1994-1996	F115700 - F802349				18-5354	18-5443		18-8832-1
454 MAG MPI	454/V-8	Ⓢ	1996-1998	F802350 - L085009				18-5354	18-5443		18-8832-1
454 MAG MPI	454/V-8	Ⓢ	1998-2001	L085010 - M024999				18-5354	18-5443		18-8832-1
454 MAG MPI HORIZON MIE	454/V-8	Ⓢ	1998-2001	L002200 - L674000	18-5281		18-5405	18-5354	18-5443	18-5494-2 ①	
										18-5498-1 ①	
454-EFI, MAG MPI	454/V-8		1994-2001	F115700 & UP	18-5281		18-5405	18-5354	18-5443	18-5494-2 ①	18-8832-1
HORIZON MIE										18-5498-1 ①	

- ① Mallory Ignition
- ② Prestolite
- ③ Autolite
- ④ Mercury Ignition
- ⑤ Holley
- ⑥ Thunderbolt IV

- Ⓢ With screw down cap
- Ⓢ Delco
- Ⓢ Electronic dist. (std rotation) excluding Thunderbolt ignition
- Ⓢ Delco EST
- ⚡ Delco digital system
- ★ With out dist cap

- ☞ With dist cap
- ☛ Mercury HEI
- Ⓢ Delco HEI
- ⚡ Thunderbolt V
- ♥ Prestolite with clip down dist cap
- Ⓢ Contact controlled dist. (Std. Rotation) excl. Thunderbolt ign.

MODEL	Cyl.	Ignition Type	Year	Serial #	Tune-Up Kit	Contact Set	Rotor	Dist. Cap	Coil	Distributor	Spark Plug Wires
454 MAG MPI	454/V-8		1999-2001	L086001 - L674000	18-5281		18-5405	18-5354	18-5443	18-5494-2 ②	18-8832-1
HORIZON MIE										18-5498-1 ②	
454 MAG MPI SKI	454/V-8	ESP	1995-1997	F215800 - K999999				18-5354	18-5443		18-8832-1
525 SC	454/V-8	②, ③	1991-1999	D456000 - L415623			18-5431	18-5395			
7.4L BRAVO	454/V-8	②, ③	1988-1997	B771113 - K999999			18-5431	18-5395			
7.4L MIE	454/V-8	②, ③	1988-1997	B788366 - K999999			18-5431	18-5395			
7.4L MPI (L29)	454/V-8	ESP	1998-2001	L010003 - M024330				18-5354	18-5443		18-8832-1
7.4L MPI MIE	454/V-8	ESP	1995-1997	F563052 - K999999				18-5354	18-5443		18-8832-1
7.4L MPI MIE (L29)	454/V-8	ESP	1998-2001	L002006 - L674613				18-5354	18-5443		18-8832-1
7.4L TBI MIE	454/V-8	ESP	1996-1997	F874815 - K999999				18-5354			N/A
7.4LX BRAVO EFI	454/V-8	ESP	1996-1997	F820000 - K999999				18-5354	18-5443		18-8832-1
7.4LX BRAVO MPI	454/V-8	ESP	1996-1997	F602010 - K999999				18-5354	18-5443		18-8832-1
390	482/V-8	③	1969-197070	2781129 - 2825059	18-5282		18-5420	18-5389			18-8803-2
460 TRS	482/V-8	①	1983-198686	6180970 - 6181046	18-5251	18-5314	18-5404-1	18-5376	18-5433	18-5494-2 ②	18-8803-2
										18-5498-1 ②	
										18-5313-1 ④	
460 TRS	482/V-8	②	1983-1986	6180970 - 6181046	18-5254	18-5317	18-5420	18-5389	18-5433	18-5494-2 ②	18-8803-2
										18-5498-1 ②	
										18-5313-1 ④	
465	V8		1992-1994	D763732 - F213244	18-5273		18-5431	18-5395	18-5438		18-8837-1
496 / 8.1L	V8		2000 & Up	M025000 & UP			N/A				18-8838-1
500	502/V-8	②, ③	1994-1999	F213293 - L601036	18-5273		18-5431	18-5395	18-5438		18-8837-1
500 EFI	502/V-8	ESP	1998-2005	L001477 - M907127				18-5354	18-5443		
502 MAG	502/V-8	②	1990-1993	C878221 - F114528	18-5273		18-5431	18-5395	18-5438		18-8804-1
502 MAG EFI	502/V-8	ESP	1993-1996	D840650 - F802599				18-5354	18-5443		18-8832-1
502 MAG MPI	502/V-8	ESP	1996-1998	F802600 - L085000				18-5354	18-5443		18-8832-1
500(Gen+)	502/V-8		1999	L414639 - L601036	18-5273		18-5431	18-5395	18-5438		18-8837-1
500GM EFI	502/V-8		1998-2000	L001477 & up	18-5281		18-5405	18-5354	18-5443		
502 MAG MPI	502/V-8		1993-1998	D840650 - L085000	18-5281		18-5405	18-5354	18-5443		18-8832-1
502GM MAG	502/V-8		1998-2001	L085001 & up	18-5281		18-5405	18-5354	18-5443		18-8832-1
8.2L GM MPI MIE	502/V-8		1996-2001	F819620 & up	18-5281		18-5405	18-5354	18-5443		18-8832-1
8.2L GM MPI MIE	502/V-8		1990-1996	C878221 - F819619	18-5273		18-5431	18-5395	18-5438		18-8804-1
525 SC	502/V-8		1991-1995	OD456000-OF877734	18-5273		18-5431	18-5395	18-5438		18-8804-1
525 SC	502/V-8		1996-1999	OK000012 & up	18-5273		18-5431	18-5395	18-5438		18-8837-1
575 SCI	502/V-8	ESP	2000-2005	L306696 - M950526				18-5354	18-5443		
575 SCI	502/V-8		2000-2005	L306696 & UP	18-5281		18-5405	18-5354	18-5443		
600 SC	502/V-8	②, ③	1991-2000	D456489 - L301186			18-5431	18-5395	18-5438		
600 SC	502/V-8		1991-1993	D456489 - D763875	18-5273		18-5431	18-5395	18-5438		18-8837-1
600 SC	502/V-8		1993-2001	D763876 & UP	18-5273		18-5431	18-5395	18-5438		18-8837-1
8.2L MIE	502/V-8	②, ③	1990-1996	C878221 - F819619			13524T 1	18-5395	18-5438		
8.2L MPI MIE	502/V-8	ESP	1996-1998	F819620 - L086012				18-5354	18-5443		
8.2L MPI MIE	502/V-8	ESP	1998-2001	L086013 - L674200				18-5354	18-5443		
500 BULLDOG	540/V-8	②, ③	1990-2001	C577003 - M050281	18-5273		18-5431	18-5395	18-5438		18-8837-1
575	540/V-8	②	1986-1992	A677429 - D763716			18-5431	18-5395	18-5438		
800 SC	572/V-8	②, ③	1993-1998	D763836 & UP	18-5273		18-5431	18-5395	18-5438		18-8837-1

- ① Mallory Ignition
- ② Prestolite
- ③ Autolite
- ④ Mercury Ignition
- ⑤ Holley
- ⑥ Thunderbolt IV
- ⑦ With screw down cap
- ⑧ Delco
- ⑨ Electronic dist. (std rotation) excluding Thunderbolt ignition
- ⑩ Delco EST
- ⚡ Delco digital system
- ★ With out dist cap
- ⊠ With dist cap
- ☛ Mercury HEI
- ESP Delco HEI
- ⚡ Thunderbolt V
- ♥ Prestolite with clip down dist cap
- ⊠ Contact controlled dist. (Std. Rotation) excl. Thunderbolt ign.

PREMIUM MARINE IGNITION WIRES

Sierra's MAGFORCE Ignition Wires are "Electronics Friendly" protecting all of your electronic devices and electronic engine controls from RFI and EMI while delivering the maximum amount of voltage. Exact fit design ensures easy installation and years of trouble - free service.

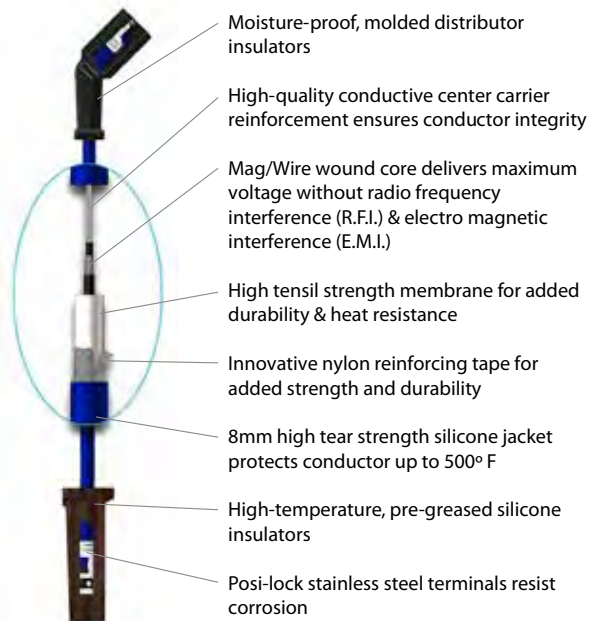

MERCURISER MARINE IGNITION WIRES APPLICATION

Model	Cyl.	Distributor	Year Start	Year Stop	Serial # Start	Serial # End	Plug Wire Set
110	4	Delco	1963	1966	1537370	2044033	18-8800-1
120	4	Delco	1964	1986	1666601	0B531853	18-8800-1
2.5L	4	Delco	1987	1989	0B531854	0C853255	18-8800-1
140	4	Delco	1968	1986	2508261	0B450800	18-8800-1
3.0L	4	Delco	1987	1989	0B450801	0C856558	18-8800-1
3.0L, LX	4	Prestolite	1990	1991	0C856559	0D504541	18-8800-1
3.0L, LX	4	Delco Digital	1990	1991	0C856559	0D504541	18-8811-1
3.0L	4	Delco EST	1991	& Up	0D504542	& Up	18-8833-1
3.0LX	4	Delco EST	1991	1997	0D504542	0K999999	18-8833-1
3.0L MPI	4	Delco EST	2012	& Up	1A072812	& Up	18-8833-1
165	4	Delco	1987	1987	0B434940	0B774251	18-8808-2
170	4	Delco	1985	1986	6916779	0B434940	18-8808-2
180	4	Prestolite	1987	1987	0B436391	0B775248	18-8800-1
190	4	Delco	1985	1986	6916779	0B436390	18-8808-2
3.7L	4	Delco	1988	1989	0B774252	& Up	18-8808-2
3.7LX	4	Delco	1988	1989	0B775249	& Up	18-8808-2
3.7LX	4	Prestolite	1988	1989	0B775249	& Up	18-8800-1
470	4	Delco	1976	1984	4208370	6916778	18-8808-2
485	4	Delco	1980	1982	5685394	6218036	18-8808-2
488	4	Delco	1981	1984	6170297	6916778	18-8808-2
140	L6	Delco	1963	1963	1538930	1725960	18-8809-1
150	L6	Delco	1964	1966	1666495	2048046	18-8809-1
160	L6	Delco	1967	1969	2048022	2770031	18-8809-1
165	L6	Delco	1970	1981	2770032	5813433	18-8809-1
200	L6	Delco	1969	1969	2453769	2712072	18-8809-1
185	6	Prestolite	1983	1984	6330183	6919655	18-8801-1
175	6	Thunderbolt IV	1987	1987	0B527955	0B773242	18-8810-1

APPLICATION CONTINUED ON NEXT PAGE

MERCUISER MARINE IGNITION WIRES APPLICATION

Model	Cyl.	Distributor	Year Start	Year Stop	Serial # Start	Serial # End	Plug Wire Set
185	6	Thunderbolt IV	1985	1987	6919656	0B527954	18-8810-1
205	6	Thunderbolt IV	1985	1987	0A331445	0B775129	18-8810-1
262 Mag	6	Delco EST	1996	1997	0F803800	0K999999	18-8835-1
4.3L	6	Thunderbolt IV	1988	1996	0B773243	0F802999	18-8810-1
4.3L Alpha	6	Thunderbolt V	1998	& Up	0L010044	& Up	18-8810-1
4.3L Bravo	6	Thunderbolt V	1998	& Up	0L010044	& Up	18-8810-1
4.3L EFI	6	Delco EST	1998	1998	0L012009	0L359999	18-8835-1
4.3L EFI	6	Thunderbolt V	1999	2004	0L360000	&Up	18-8810-1
4.3L MPI	6	Delco HVS	2001	& Up	0M300000	& Up	18-8829-1
4.3LH Alpha	6	Thunderbolt V	1998	2004	0L010044	& Up	18-8810-1
4.3LH Bravo	6	Thunderbolt V	1998	2004	0L010044	& Up	18-8810-1
4.3LX, LXH	6	Thunderbolt IV	1988	1997	0B775130	0K999999	18-8810-1
215 MCM & MIE (Ford)	8	Autolite/Mallory	1970	1972	2781153	3563181	18-8803-2
225 MCM & MIE (Ford)	8	Autolite/Mallory/Mercury	1973	1974	3385721	4166999	18-8803-2
888 (Ford)	8	Autolite/Mallory	1971	1977	3108723	4887829	18-8803-2
190 (GM)	8	Delco	1963	1964	1564539	1730903	18-8803-2
198 MIE	8	Mallory	1977	1977	4776402	4931099	18-8803-2
200	8	Thunderbolt IV	1985	1987	6899058	8774444	18-8821-1
228	8	Mallory	1977	1982	4765100	6218461	18-8803-2
228	8	Thunderbolt IV	1983	1984	6218462	6899268	18-8821-1
228 MIE	8	Mallory	1977	1980	4765100	5907057	18-8803-2
230	8	Thunderbolt IV	1985	1987	6899269	0B773739	18-8821-1
230 MIE (LH)	8	Thunderbolt IV	1981	1987	5907058	0B788151	18-8821-1
230 MIE (RH)	8	Thunderbolt IV	1981	1987	5907058	0B788151	18-8821-1
5.0L	8	Thunderbolt IV	1988	1995	0B774445	0F600999	18-8821-1
5.0L Alpha	8	Thunderbolt V	1998	& Up	0L015751	& Up	18-8821-1
5.0L Bravo	8	Thunderbolt V	1998	& Up	0L015751	& Up	18-8821-1
5.0L EFI	8	Delco EST	1998	1998	0L012052	0L339999	18-8822-1
5.0L MIE (LH)	8	Thunderbolt IV	1988	1988	0B788152	0C396832	18-8821-1
5.0L MIE (RH)	8	Thunderbolt IV	1988	1988	0B788152	0C396832	18-8821-1
5.0L MPI Alpha	8	Delco HVS	2001	& Up	0M300000	& Up	18-8828-1
5.0LX	8	Thunderbolt IV	1988	1995	0B773740	0F600999	18-8821-1
898	8	Mallory	1977	1982	4762210	6218461	18-8803-2
898	8	Thunderbolt IV	1983	1984	6218462	6899057	18-8821-1
225 (GM)	8	Delco	1963	1969	1539620	2694014	18-8803-2
225 MIE (GM)	8	Thunderbolt	1968	1968	2278647	2694014	18-8803-2
250 MCM & MIE	8	Thunderbolt	1968	1969	2314301	2639854	18-8803-2
250	8	Mallory	1977	1977	4768000	4908849	18-8803-2
255 MCM & MIE	8	Mallory	1975	1976	3258728	4501254	18-8803-2
255 MCM & MIE	8	Mercury	1976	1976	4498701	4767999	18-8803-2
255 MIE	8	Mercury	1977	1980	4768000	5907057	18-8803-2
260	8	Mallory	1978	1982	4908850	6218461	18-8803-2
260	8	Thunderbolt IV	1982	1987	6218462	0B773304	18-8821-1
260 MIE (LH)	8	Thunderbolt IV	1981	1986	5907058	0B788151	18-8821-1
260 MIE (RH)	8	Thunderbolt IV	1981	1986	5907058	0B788151	18-8821-1
270 MCM & MIE	8	Thunderbolt	1969	1972	2851074	3385720	18-8803-2
280 TRS	8	Mercury/Mallory	1975	1975	4176250	4499390	18-8803-2
300	8	Thunderbolt IV	1985	1986	6668677	0B430367	18-8821-1
320 EFI	8	Thunderbolt IV	1987	1989	0A543604	0C622418	18-8821-1
350 Mag Alpha	8	Thunderbolt IV	1986	1994	0A635178	0F353690	18-8821-1
350 Mag Alpha	8	Thunderbolt V	1995	1997	0F353691	0K999999	18-8821-1
350 Mag Alpha EFI	8	Delco EST	1996	1997	0F800300	0K999999	18-8822-1

APPLICATION CONTINUED ON NEXT PAGE

MERCURISER MARINE IGNITION WIRES APPLICATION

Model	Cyl.	Distributor	Year Start	Year Stop	Serial # Start	Serial # End	Plug Wire Set
350 Mag Bravo MPI	8	Delco EST	1995	1996	0F415189	0K999999	18-8822-1
350 Mag EFI Ski	8	Delco EST	1994	1997	0F215561	0K999999	18-8822-1
350 Mag MPI	8	Delco EST	1998	1998	0L010019	0L325952	18-8822-1
350 Mag MPI Alpha	8	Delco HVS	2001	& Up	0M300000	& Up	18-8828-1
350 Mag MPI Bravo	8	Delco HVS	2001	& Up	0M300000	& Up	18-8828-1
350 Mag MPI Horizon	8	Delco HVS	2001	& Up	0M300000	& Up	18-8828-1
350 Mag MPI Horizon MIE	8	Delco HVS	2001	& Up	0M300000	& Up	18-8828-1
350 Mag MPI MIE	8	Delco HVS	2001	& Up	0M300000	& Up	18-8828-1
350 Mag MPI Ski	8	Thunderbolt IV	1991	1996	0D505450	0K40399	18-8821-1
350 Mag MPI Ski	8	Thunderbolt V	1991	1997	0D505450	0K999999	18-8821-1
5.7L Alpha	8	Thunderbolt IV	1988	1995	0B773305	0F600999	18-8821-1
5.7L Alpha	8	Thunderbolt V	1996	1997	0F601000	& Up	18-8821-1
5.7L Bravo	8	Thunderbolt IV	1988	1993	0B773305	0F353524	18-8821-1
5.7L Bravo	8	Thunderbolt V	1994	& Up	0F353525	& Up	18-8821-1
5.7L EFI	8	Delco EST	1995	1998	0F225560	0L339999	18-8822-1
5.7L EFI MIE	8	Delco EST	1997	1997	0K040300	0K999999	18-8822-1
5.7L MIE	8	Thunderbolt IV	1988	1995	0B788152	0F746099	18-8821-1
5.7L MIE	8	Thunderbolt V	1996	1997	0F622100	0K999999	18-8821-1
5.7L MIE	8	Thunderbolt V	1998	& Up	0L002003	& Up	18-8821-1
5.7L Ski	8	Mallory/Prestolite	1985	1995	0A338553	0F775199	18-8802-1
5.7L Ski	8	Thunderbolt IV	1987	1995	0B514627	0F775199	18-8821-1
5.7L Ski	8	Thunderbolt V	1996	1997	0F775200	0K999999	18-8821-1
5.7L Ski	8	Thunderbolt V	1998	& Up	0L002005	& Up	18-8821-1
5.7LX Alpha & Bravo	8	Thunderbolt V	1996	1997	0F601000	0K999999	18-8821-1
5.7LX Bravo & EFI	8	Delco EST	1996	1997	0F752400	0K999999	18-8822-1
233 MCM & MIE (Ford)	8	Mercury/Prestolite	1975	1977	4173000	4902304	18-8803-2
255 MCM & MIE (Ford)	8	Mercury/Mallory	1973	1980	3258728	5907057	18-8803-2
MX 6.2L MPI	8	Delco HVS	2001	& Up	0M300000	& Up	18-8828-1
MX 6.2L MPI Horizon	8	Delco HVS	2001	& Up	0M300000	& Up	18-8828-1
MX 6.2L MPI Horizon MIE	8	Delco HVS	2001	& Up	0M300000	& Up	18-8828-1
MX 6.2L MPI MIE	8	Delco HVS	2001	& Up	0M300000	& Up	18-8828-1
377 MAG MPI BRAVO	8	Delco HVS	ALL	ALL	1A300000	& Up	18-8828-1
325 MCM & MIE	8	Thunderbolt	1969	1974	2278747	& Up	18-8803-2
325 MCM & MIE	8	Mallory	1969	1972	2278747	& Up	18-8803-2
390	8	Mallory	1968	1970	ALL		18-8803-2
330	8	Mallory	1977	1981	4623115	6083144	18-8803-2
330	8	Thunderbolt	1977	1981	4623115	6083144	18-8803-2
330	8	Thunderbolt IV	1982	1987	6083145	0B816540	18-8821-1
340 MIE	8	Thunderbolt IV	1981	1987	5889914	0B788365	18-8821-1
350 MIE	8	Thunderbolt	1974	1976	3780450	4623109	18-8803-2
370 TRS	8	Mallory/Holley	1978	1985	4179554	6721527	18-8803-2
370 TRS	8	Thunderbolt IV	1985	1987	6721528	0B714586	18-8821-1
400 TRS	8	Mallory/Holley	1980	1986	5668232	0B457644	18-8803-2
440 TRS	8	Mallory/Holley	1983	1986	6181070	0B485220	18-8803-2
450	8	Thunderbolt IV	1995	1996	0F347100	0F347277	18-8821-1
454 Mag Alpha	8	Thunderbolt IV	1986	1988	0A631894	0B785148	18-8821-1
454 Mag Bravo	8	Thunderbolt IV	1988	1997	0B721206	0K999999	18-8821-1
454 Mag EFI	8	Delco EST	1994	1996	0F115700	0F802349	18-8822-1
454 Mag MPI	8	Delco EST	1996	2001	0F802350	M024999	18-8822-1
454 Mag MPI Horizon MIE	8	Delco EST	1999	2001	0L002200	0L674000	18-8822-1

APPLICATION CONTINUED ON NEXT PAGE

MERCURUISER MARINE IGNITION WIRES APPLICATION

Model	Cyl.	Distributor	Year Start	Year Stop	Serial # Start	Serial # End	Plug Wire Set
454 Mag MPI Ski	8	Delco EST	1995	1997	0F215800	0K999999	18-8822-1
7.4L Bravo I, II, III	8	Thunderbolt IV	1988	1997	0B771113	0K999999	18-8821-1
7.4L Bravo III	8	Thunderbolt V	1992	1997	603118	0K999999	18-8821-1
7.4L EFI MIE	8	Thunderbolt IV	1988	1996	0B788366	0F820141	18-8821-1
7.4L MIE	8	Thunderbolt IV	1988	1996	0B788366	0F820141	18-8821-1
7.4L MIE	8	Thunderbolt V	1992	1997	0D715494	0K999999	18-8821-1
7.4L MPI (L29)	8	Delco EST	1998	2001	0L010003	0M024330	18-8822-1
7.4L MPI MIE	8	Delco EST	1995	2001	0F563052	0M025999	18-8822-1
7.4LX Bravo EFI & MPI	8	Delco EST	1996	1997	0F602010	0K999999	18-8822-1
390	8	Thunderbolt	1969	1970	2781129	2825059	18-8803-2
460 TRS	8	Mallory/Holley	1983	1986	6180970	6181046	18-8803-2
460 Cyclone	8	ALL	1983	1985	ALL		18-8803-2
496 Mag & Mag HO	8	Delco (coil over plug)	2000	& Up	0M025000	& Up	18-8838-1
8.1 MIE & HO MIE	8	Delco (coil over plug)	2000	& Up	0M025000	& Up	18-8838-1
502 Mag Bravo	8	Thunderbolt IV	1990	1993	0G878221	0F114528	18-8821-1
502 Mag EFI	8	Delco EST	1993	1996	0B40650	0F802599	18-8822-1
502 Mag MPI	8	Delco EST	1996	2001	0F802600	0M024999	18-8822-1
525 SC	8	Thunderbolt IV	1991	1995	0D456000	0F877734	18-8821-1
8.2L MIE	8	Thunderbolt IV	1990	1996	0C878221	0F819619	18-8821-1
8.2L MPI MIE	8	Delco EST	1996	2001	0F819620	0L674200	18-8822-1



**18-5225
SPARK PLUG WIRE KIT**
Replaces: Mercury 84-99215A26, 84-813706A26, 84-93475A26, 84-93212A1, 84-90816A26
Kit includes 25 ft. roll of 7 MM hypalon ignition wire with a metallic core and a large assortment of three different end fittings.



**18-5226
IGNITION WIRE**
Metallic Core
100' Spool
7mm Hypalon



BATTERY CABLES

Part No.	Size	Color	Gauge	Part No.	Size	Color	Gauge
BC88523	2'	red	4	BC88563	6'	red	2
BC88533	2'	black	4	BC88573	6'	black	2
BC88543	4'	red	2	BC88583	8'	red	1
BC88553	4'	black	2	BC88593	8'	black	1

Gauge cable with soldered lug terminals on each end to accept a 3/8" stud

PKG. OF 10



**18-5224
18-5224-9①
SPARK PLUG WIRE
TERMINAL**
Replaces: 20121, 8M0084600

PKG. OF 10



**18-5750
18-5750-9①
UNIVERSAL SPARK
PLUG BOOTS**
Supplied complete w/Terminal Connector



**18-5752
UNIVERSAL
SPARK PLUG BOOT**
8mm

Standard Rotation

CCW Rotation

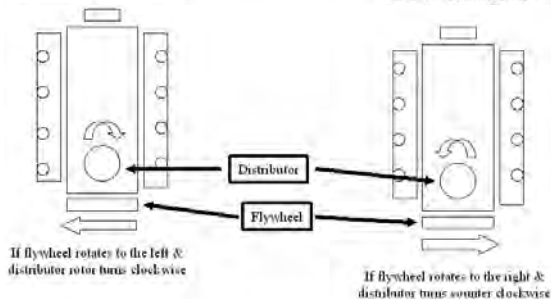

**18-5603
STARTER**
Replaces: 50-808011A4
Noseless:CCW Top mount rear entry starter for standard rotation GM & Ford engines. Can be used in place of 18-5908.



**18-6275
STARTER**

Replaces:
50-807904A1, 50-863007A1, 50-864340A2, 50-806964A4,
50-806964A3, 50-806964A2, 50-812604A2, 50-812428A3,
50-812428A3, 50-12177A2, 50-12121A2, 50-822330A2, 814472, 50-99418A2,
50-77328A3, 50-77328A1

- Permanent Magnet Gear Reduction Starter
- Inboard
- 2 Long Bolt Offset Pattern
- CW Rotation • SAE J1171
- Use w/ Late Model 3.0L Engines with 14" Flywheel

Fits: Volvo Penta, Mercruiser, Marine Power
Uses Solenoid **18-5811**



**18-5923
STARTER**

PMGR Replacement for 18-5903;
302CID, 351CID Ford Engines



**18-5911
STARTER**
(Heavy-Duty) (No Core) (Clockwise) (9 tooth) For GM engines, bottom
mount straight across bolt pattern. Standard rotation.

Replaces: 50-76965A4, 50-99417A2, 50-99419A3, 50-17251A3
Replacement Solenoid: 18-5837
SAEJ1171



**18-5907
STARTER**
(Heavy-Duty) (No Core) (Clockwise) (9 tooth) Top mount rear entry starter for opposite rotation GM & Ford engines.
Will also replace bottom mount standard rotation. Will not replace non-starter mounted solenoids.

Mercuriser built 4 cyl. 165/170/180/190/470/485/488
Replaces: 50-72550A2, 50-79604A3, 50-97499A2, 50-97499R4, 50-72550R2, 50-97499R3
Replacement Solenoid: 18-5837
SAEJ1171



**18-5913
STARTER
(Clockwise)**

Delco permanent magnet gear reduction 2 bolt starter
12V - 11 Tooth - Offset Bolt Pattern
For: Late model GM - 14" Flywheel
Replaces: 50-812428A3, 50-812604A2,
50-822330A2, 50-864340A2
Includes 18-8402 (2) bolts
SAEJ1171
For: 4.3L (1996 & UP); 5.0 & 5.7L (1998 & UP)



**18-5919
STARTER**

Permanent magnet I/O starter, 11 Tooth
Replaces: 50-806963A4, 50-806965A2, 50-806965A4
Includes one 18-8402 bolt and one 18-8404 bolt
Fits: Chevy Engines with 12 3/4" flywheels
Straight across bolt pattern
SN-OF803000AN/OF803114AN 4.3LX/LXH Alpha/Bravo 262 CID
SN-355305AN/22560AN 5.7L Alpha (EFI)/5.7L Bravo (EFI)
SAEJ1171



**18-5910
STARTER**

(Heavy-Duty) (No Core) (Clockwise) (9 tooth) Small block V-6 & V-8 GM engine with 14 1/4" flywheel and bottom mount, offset bolt pattern. For standard rotation engines.
Replaces: 50-12177A2, 50-99418A2



**18-5908
STARTER
(Heavy-Duty) (No Core) (Counter-Clockwise) (9 tooth)**

Top mount rear entry starter for standard rotation GM & Ford engines. Front mount reverse rotation.
Replaces: 50-76965A3, 50-808011A1, 50-808011A05, 50-808011A4, 50-808011A3, 50-99419A3, 50-76967A4, 50-76967A1
50-65784A1, 50-47455, 50-17251A3, 50-17251A2
Replacement Solenoid: 18-5837
SEAJ1171





18-5903
STARTER
 (No Core) (Clockwise) Bottom mount, two bolt pattern for standard rotation Ford engines.
 Replaces: 50-69865A1, 50-12872, 50-56886
 Replacement Solenoid: **18-5801**
 *For PMGR style order **18-5923**



18-6870
STARTER
 Replaces: Mercury 50-805833, T
 Fits: D7.3L D-tronic 260 LD, 300 1999 year



18-6946
STARTER
 Replaces: 50-8m8021116
 Fits: High Performance 11 Tooth Starter for 6.2L & 8.9L Scorpion HO applications



18-6947
STARTER
 Replaces: Mercruiser 50-805991
 Fits: 7.3L (BRAVO & MIE) DIESEL NAV 444 V-8 1994-1996



18-6949
STARTER
 Replaces: Mercruiser 50-831001562, 50-831001961
 Fits: WO4CTA (150 HP) HINO 234 I/L4, WO4CTI (210 HP) HINO 234 I/L4



18-6957
STARTER
 Replaces: Mercruiser 50-801333980, 50-854178, 50-855507



18-8412
STARTER STUD EXTENDER
 Extends the solenoid stud on PMGR starters for applications that require more accessory wire connections.
 Threads: Female M8x1.25, Male 3/8"x16 UNC



18-2434
FLYWHEEL BELL HOUSING
 Replaces: 814309A1
 For: GM V-8's Big & Small Blocks Inboard/Ski Models

STARTER BOLTS



Description	MerCruiser #	Part #
Starter Bolt 3/8 - 16 - 4 3/8 Long	10-8053432	18-8402
Starter Bolt 3/8 - 16 - 1 11/16 Long	10-8083434	18-8404-1



**18-5717
STARTER
BRUSH SET**
Replaces: 33270

**18-5804
SOLENOID**
Replaces: 13037
Delco



**18-5837
SOLENOID**
Replaces: 89-18080
Delco



**18-5838
SOLENOID**
Replaces: 33261, 33316,
60687, 89902, 89-99253
Delco



**18-5840
SOLENOID**
Prestolite 15-79,
SAW 4201, SAW4207, SAW4210



BRUSH SET/STARTER SWITCH APPLICATION

Years	Volt.	Starter No.	Brush Set	Starter Switch	Years	Volt.	Starter No.	Brush Set	Starter Switch
1977-82	12	1108755	18-5717	18-5838	1971-78	12	ALL	18-5717	18-5838
1977-82	12	1108756	18-5717	—	1969-78	12	MEO-7003	—	18-5840
1977-82	12	1109484,5,6	18-5717	18-5838					

① **18-5801D** [Display Package](#)

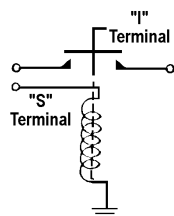

**18-5801
SOLENOID**
Replaces: 89-76416A1

① **18-5802D** [Display Package](#)

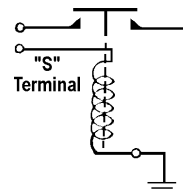

**18-5802
SOLENOID**
Grounded base
Replaces: 65057A1, 65057T1, 65057, 54981

① Items ending in "D" are Display Packaged - Regular number is Non-Display

① 18-5810D Display Package



18-5810 SOLENOID



18-5811 STARTER SOLENOID
Replaces: 809463A1, 8094631, 809463, 8094621, 809462
For: PG 260 Series Starters, GM V6 & V8 (1983-Up)

① 18-5815D Display Package



18-5815 SOLENOID
Replaces: 89-68258A4, 89-853654A1, 89-76545, 89-76545T, 89-65258, 89-61053, 89-15857

① 18-5816D Display Package



18-5816 SOLENOID
Replaces: 89-96054, T, 89-91975
 (Flat Bracket)

① 18-5817D Display Package



18-5817 SOLENOID
Replaces: 89-96158, 89-96158T, 94318, 846070
 (Curved Bracket)



18-5820 SOLENOID
Replaces: 89-818999A2, 89-825842A1, 89-850188T1

① 18-5836D Display Package



18-5836 SOLENOID
Replaces: 25661, 256611, 25661T1



18-9802 TIMING LIGHT
 Self-powered accurate up to 10,000 RPM's



18-6749 TRIM BRACKET
Metal Bracket
Replaces: 862548A1, 42419A1, 88893A4, 88553A1, 862548A1, 58397A3, 58397A2, 42419A1
For: MerCruiser Floor Mount Bracket



18-6750 TRIM BRACKET
Stainless Steel
Replaces: 862548A1, 42419A1
For: MerCruiser Floor Mount Bracket



18-6747 TILT/TRIM ASSEMBLY
Replaces: 865380A25, 865380A15, 865380A05, 865380A02, 14336A28, 14336A22, 14336A17, 14336A15, 14336A9, 14336A6, 88183A12, 88183A3
 For late model sterndrive applications



18-6752 HYDRAULIC TRIM PUMP ASSEMBLY
 Low Pressure - High Flow
Metal Bracket
Replaces: 14336A9, 88183A12, 96477A3, 88183A11, 88183A6, 14336A28, 14336A22, 14336A17, 14336A15, 14336A6
Fits: 1983 and Later without "quick connect"
 Replacement Motor: 18-6772
 20 amp fuse



18-6753 HYDRAULIC TRIM PUMP ASSEMBLY
 Low Pressure - High Flow
Stainless Steel Bracket
Replaces: 14336A9, 88183A12
Fits: 1983 and Later without "quick connect"
 Replacement Motor: 18-6772
 20 amp fuse

① Items ending in "D" are Display Packaged - Regular number is Non-Display

APPLICATION BEGINS ON PAGE 704

**18-6768
COMPLETE POWER
PUMP ASSEMBLY**

Steel Bracket
Replaces: 93247A7, 93247A4, 392-8261A1, 392-8263, 88475A4, 79271A4, 74436A9
Replacement pump for Prestolite high pressure/low flow system. Primarily used 1982 and earlier. 20 amp fuse.



**18-6799
COMPLETE POWER
TRIM PUMP ASSEMBLY**

Stainless Steel Bracket
Replaces: 93247A7, 93247A4, 392-8261A1, 392-8263, 88475A4, 79271A4, 74436A9
Replacement pump for Prestolite high pressure/low flow system. Salt water series. Stainless steel bracket. Primarily used 1982 and earlier. 20 amp fuse.



**18-6763
TILT/TRIM MOTOR**

Replaces: 92975A6, 79271A4, 67914A2, 92975A32, 93247A7
To 1984. Fits most Mercruiser Sterndrives (Motor and Reservoir Only)
For Repair Kit use: **18-6253**

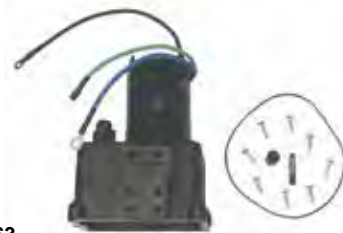

**18-6769-1
TILT/TRIM PUMP**
Low Pressure - High Flow

Replaces: 14336A8, 88183A5 From 1984
Fits: Most Mercruiser Sterndrives



**18-6772
TILT PUMP MOTOR**

Replaces: 17649, 17649T, 891736T
For late style Alpha I, Generation II, and Bravo drives; early style square motors.
Mercruiser Sterndrive replacement for Oildyne units



**18-6813
TRIM MOTOR**

Low pressure/high flow
Replaces: 14336A6, A8, A9, A15, A20, 88183A5, A8, A12, 865380A13
Same as 18-6769-1, plus wiring
Replacement Solenoid: **18-5817**



**18-6746
TILT/TRIM ASSEMBLY**

Replaces: 14336A20, 14336A25, 14336A31, 14336A8 865380A03, 865380A13, 88183A5



**18-6771
TILT/TRIM RESERVOIR**

Replaces: 18525, 18525A1, 17646



**18-6778
TILT/TRIM RESERVOIR**

Replaces: 883166A1, 883166A2
For: Tilt Motors with 4 Screw Attachments



**18-6823
WIRING HARNESS**

Replaces: Universal
Converts 3-wire Tilt and Trim motors to 2-Wire design



**18-6254
COMMUTATOR
END PLATE**

Replaces: 392-2940
For: Use with Prestolite Pumps
(Mercury #'s 79271A4 and 88475A5)



**18-6253
COMMUTATOR
END PLATE**

For: Use with 18-6763



**18-15501
CIRCUIT BREAKER**

Replaces: 88-93582
60 AMP



**18-6256
POWER TRIM SPRING SET**

Replaces: 392-2529
For: Use with Prestolite Pumps
(Mercury #'s 74436A9, 79271A4, 88475A5 and 93247A4)



**18-6255
POWER TRIM BRUSH**

Replaces: 392-8989
For: Use with Prestolite Pumps
(Mercury #'s 93247A4)



**18-5945
ALTERNATOR**

(3-Wire) (No Core) (68 AMP) • SAE J1171
Replaces Mando, Motorola and original equipment Delco. Uses same electrical connections and mounting method. Equipped with fan and serpentine drive pulley.



**18-5946
ALTERNATOR**

(1-Wire) (No Core) (68 AMP)
Single wire connection fits Mercruiser and many other applications. Equipped with fan and serpentine drive pulley.
SAE J1171





18-5956
ALTERNATOR
 (1-Wire) (No Core) (68 AMP)
 Single wire connection fits Mercruiser and many other applications. Equipped with fan and drive pulley.
Replaces: 69729, 90794, 78403A2, 78403A1, 78477, 59755, 56045
 SAE J1171



18-5957
ALTERNATOR
 (3-Wire) (68 AMP)
 Replaces Mando, Motorola and original equipment Delco. Uses same electrical connections and mounting method. Equipped with fan and drive pulley.
Replaces: 78477, 78403A2, 92497A3, 78403A1, 90794, 69729, 59755, 56045, 817119A4, 817119A1, 98555A1, 92497, 12449A1, 12449
 SAE J1171



18-5960
ALTERNATOR
 Serpentine Pulley • 65 Amp
Replaces: 807653T • SAE J1171



18-5965
ALTERNATOR
 65 Amp
Replaces: 817119A1, 817119A4, 805884T, 98555A1, 92497A3, 92497, 12449A1, 12449
 SAE J1171



18-5967
ALTERNATOR
 Serpentine Pulley • 55 Amp
Replaces: 807652T
 SAE J1171



18-5966
ALTERNATOR
 Single Groove Pulley • 55 Amp
Replaces: 817119A4, 12449A1, 98555A1, 92497, 817119A1, 12449A1, 12449
 SAE J1171



18-5983
ALTERNATOR
Replaces: 862030T • SAE J1171
 7SI/70 amp, Hinge Mount, Single Groove Pulley



18-6293
ALTERNATOR
Replaces: 862031T, 862031T1 • SAE J1171
 7SI/70 amp, Hinge Mount, Serpentine Pulley 2.44" Diameter



18-6298
ALTERNATOR
Replaces: 863077T • SAE J1171
 7SI/70 amp, Hinge Mount, Serpentine Pulley 1.97" Diameter



18-6841
ALTERNATOR
Replaces: 56045, 59755, 69729, 78403A2, 78403A1, 78477, 90794
For: 37-63A Marine Applications



18-6842
ALTERNATOR
Replaces: 56045, 59755, 69729, 78403A2, 78403A1, 78477, 90794
For: 37-63A Marine Applications



18-6844
ALTERNATOR
Replaces: Mercruiser 834832, T2, 857006A3, Denso 101211-3460



18-6948
ALTERNATOR
Replaces: 882571, 8M0084523
Fits: CMD 1.7 MI 120 I/L4, CMD 1.7 MS 120 I/L4, D1.7L DTI



18-6960
ALTERNATOR
Replaces: Mercruiser 821663, 8216631, 821663A1
 Denso 101211-3020, 3021



18-6975
ALTERNATOR (Universal)
Fits: High amp 160A alternator, universal mounting pattern based on Delco CS1300 design, v-belt and 6 groove serpentine pulley included



**18-5953-1
ALTERNATOR CONVERSION KIT**
Includes new 18-5956 68 AMP alternator, mounting brackets 18-5968, pulley (8.0" O.D. x 2.75" H), wiring, hardware and instructions. Converts model 470 aluminum block Mercruiser engines serial number 4625580 & up with stator charging system and water cooled voltage regulator to alternator system. **NOTE: Fuse kit 18-8220 (sold separately) is required on engines with a Delco starter (round solenoid mounted to starter); Prestolite starters with remote solenoid DO NOT require fuse kit. Visually inspect starter prior to ordering conversion kit.**
For: Mercruiser 224 / 3.7L



**18-5949
CONVERSION KIT DRIVE BELT**
3/8" x 33 1/2"
Replacement belt for alternator conversion kit used on 470 Series Mercruisers. Included in 18-5953-1 kit.



**18-5968
ALTERNATOR BRACKET**
Replacement bracket for alternator conversion kit used on 470 Series Mercruiser included in 18-5953-1 kit.



**18-5978
ALTERNATOR BRACKET**
Replaces: 47487T



**18-5724
VOLTAGE REGULATOR**
Replaces: 78385



**18-5740
VOLTAGE REGULATOR**
Replaces: 42785



**18-8220
FUSE KIT**
Replaces: 88-79023A91
For use with 18-5953-1 alternator conversion kits installed on Mercruiser (Model 470) 3.7 liter aluminum block engines serial number 6902288 & Up. 90 AMP

Model	Cyl.	Years	Beg Serial #	End Serial #	Slave Solenoid	Reman Starter	New Starter	Reman Alternator	New Alternator
110	GM 4	1963-1966	1538370	2044033	18-5836	18-5911	18-5911	—	—
120	GM 4	1964-1975	1666601	4469865	18-5836	18-5911	18-5911	18-5957	18-5957
120	GM 4	1976-1982	4469866	6229717	18-5815	18-5911	18-5911	18-5957	18-5957
120 / 2.5L	GM 4	1983-1989	6229718	C853255	18-5817	18-5911	18-5911	—	18-5966 ④
140	GM 4	1968-1975	2508261	4460664	18-5836	18-5911	18-5911	18-5957	18-5957
140	GM 4	1976-1981	4460665	6229717	18-5815	18-5911	18-5911	18-5957	18-5957
140/3.0L	GM 4	1982-1989	6229718	C856558	18-5817	18-5911	18-5911	18-5957	18-5957
140/3.0L	GM 4	1999-2001	0L382122	OM326292	18-5817	—	18-6275	—	18-5983 **
140/3.0L/3.0LX	GM 4	1990-92	C856559	D831100	18-5817	18-5911	18-5911	18-5957	18-5957
140/3.0LX	GM 4	1992-97	D831101	OK999999	18-5817	N/A	18-6275	—	18-5966 ④
165/3.7L	Merc 4	1987-1989	B434941	C762299	18-5802	18-5907	18-5907	N/A	N/A
170	Merc 4	1985-1986	6916779	B434940	18-5802	18-5907	18-5907	N/A	N/A
180/3.7LX	Merc 4	1987-1989	B436391	C762299	18-5802	18-5907	18-5907	N/A	N/A
190	Merc 4	1985-1986	6916779	B436390	18-5802	18-5907	18-5907	N/A	N/A
470	Merc 4	1976-1984	4208730	6916778	18-5802	18-5907	18-5907	N/A	N/A
470MIE	Merc 4	1980-1981	5520115	6218036	18-5802	18-5907	18-5907	N/A	N/A
485	Merc 4	1980-1984	5685394	6916778	18-5802	18-5907	18-5907	N/A	N/A
140	GM 6	1963	1538930	1725960	18-5836	18-5911	18-5911	—	—
150	GM 6	1964-66	1666495	2048046	18-5836	18-5911	18-5911	—	—
160	GM 6	1967-69	2048022	2768031	18-5836	18-5911	18-5911	—	—
160	GM 6	1969	2768032	2770031	18-5836	18-5911	18-5911	18-5957	18-5957
165	GM 6	1970-1975	2770032	4471565	18-5836	18-5911	18-5911	18-5957	18-5957
165	GM 6	1976-1981	4471566	5813433	18-5815	18-5911	18-5911	18-5957	18-5957
200	GM 6	1969	2453769	2712072	18-5836	18-5911	18-5911	—	—
175/4.3L	GM V-6	1987-1992	B527955	D714106	18-5816	—	18-5913	—	18-5966 ④
185	GM V-6	1983-1984	6330183	6919655	18-5816	18-5911	18-5911	—	18-5966 ④

① For 12 3/4" Dia. Flywheel
 ② For 14" Dia. Flywheel
 ③ For permanent magnet models use 18-5919
 ④ 55 AMP up grade to 65 AMP use 18-5965
 ⑤ Black
 ⑥ For permanent magnet models use 18-5913
 ⑦ Bravo drive

⑧ Firepower ignition
 ⑨ Ignition module mounted on distributor
 ⑩ Ignition module mounted on elbow
 ⑪ LH rotation
 ⑫ NLA for models prior to S/N 4167000
 ⑬ PG 260 (9-1/4" long)
 ⑭ PG260F1 (8-1/2" long)

⑮ RH Rotation
 ⑯ Standard ignition
 ⑰ Thunderbolt ignition
 ⑱ Thunderbolt IV
 ⑲ Thunderbolt V
 ⑳ Transmission models
 ** Delco Style

Model	Cyl.	Years	Beg Serial #	End Serial #	Slave Solenoid	Reman Starter	New Starter	Reman Alternator	New Alternator
185	GM V-6	1985-1987	A331455	B527954	18-5816	N/A	18-5913	—	18-5966 ④
205	GM V-6	1985-1991	A331455	D714369	18-5816	N/A	18-5913	—	18-5966 ④
262 Mag. EFI	GM V-6	1996-1997	F803800	K999999	18-5817	N/A	18-5913	—	18-5960
262 Mag. EFI	GM V-6	1996-1997	F803800	K999999	18-5817	N/A	18-5913	—	18-5960
4.3L/LX/LXH	GM V-6	1992-1997	D714107	K999999	18-5817	—	18-5913	—	18-5967
4.3L/LX/LXH	GM V-6	1996-1997	F803000	K999999	18-5817	—	18-5913	—	18-5967
4.3L/LH	GM V-6	1998-99	L010044	OL618999	18-5817	—	18-5913	—	18-5967
4.3L/LH(Gen +)	GM V-6	2000-02	OL619000	OM320024	18-5817	—	18-5913	—	18-6293 **
4.3EFI	GM V-6	1998-99	L012009	OL618999	18-5817	—	18-5913	—	18-5960
4.3L EFI	GM V-6	2000-01	OL619000	OM299999	18-5817	—	18-5913	—	18-6293 **
4.3L MPI	GM V-6	2002	OM300000	OM320024	18-5817	—	18-5913	—	18-6293 **
190	GM V-8	1963-1964	1564539	1730903	18-5836	18-5911	18-5911	—	—
200	GM V-8	1985-1986	6218462	B525981	18-5816	18-5911	18-5911 ① ③	—	18-5966 ④
200	GM V-8	1985-1986	6218462	B525981	18-5816	18-5910	18-5910 ② ⑥	—	18-5966 ④
200/5.0L	GM V-8	1987-1995	B525982	F600999	18-5816	18-5910	18-5910	—	18-5966 ④
200/5.0L	GM V-8	1987-1995	B525982	F600999	18-5817	18-5910	18-5910	—	18-5966 ④
215 MCM &MIE	Ford V-8	1970-1972	2781153	3563181	18-5836	18-5908	18-5908 ①	18-5957	18-5957
215 MCM &MIE	Ford V-8	1970-1972	2781153	3563181	18-5836	18-5907	18-5907 ⑤	18-5957	18-5957
225	Ford V-8	1973-1974	3385721	4166999	18-5802	18-5903	—	18-5957	18-5957
225 MIE	Ford V-8	1973-1974	3385721	4176999	18-5836	18-5908	18-5908 ①	18-5957	18-5957
225 MIE	Ford V-8	1973-1974	3385721	4176999	18-5836	18-5907	18-5907 ⑤	18-5957	18-5957
888	Ford V-8	1971-1977	3108723	4612109	18-5802	18-5903	— ②	18-5957	18-5957
888	Ford V-8	1971-1977	4612110	& Up	18-5801	18-5903	—	18-5957	18-5957
225	GM V-8	1963-1966	1539620	2278646	18-5836	18-5911	18-5911	—	—
225 MIE	GM V-8	1968	2278647	2694014	18-5836	18-5908	18-5908 ①	—	—
225 MIE	GM V-8	1968	2278647	2694014	18-5836	18-5907	18-5907 ⑤	—	—
225	GM V-8	1967-1969	2278647	2694014	18-5836	—	—	—	—
228/230	GM V-8	1977-1986	4765100	B525981	18-5816	18-5911	18-5911 ① ③	—	18-5966 ④
228/230	GM V-8	1977-1986	4765100	B525981	18-5816	18-5910	18-5910 ② ⑥	—	18-5966 ④
228 MIE	GM V-8	1977-1980	4765100	5907057	18-5815	18-5908	18-5908 ①	18-5957	18-5957
228 MIE	GM V-8	1977-1980	4765100	5907057	18-5815	18-5907	18-5907 ⑤	18-5957	18-5957
230/5.0LX	GM V-8	1987-1995	B525982	F600999	18-5816 ⑩	18-5910	18-5910 ③	—	18-5966 ④
230/5.0LX	GM V-8	1987-1995	B525982	F600999	18-5817 ⑨	18-5910	18-5910 ③	—	18-5966 ④
230/5.0L MIE	GM V-8	1987-1988	5907058	B788151	18-5816	18-5908	18-5908 ①	—	18-5966 ④
230/5.0L MIE	GM V-8	1987-1988	5907058	B788151	18-5816	18-5907	18-5907 ⑤	—	18-5966 ④
5.0L(Gen +)	GM V-8	1998-99	L015751	L618999	18-5817	—	18-5913	—	18-5967
5.0L(Gen +)	GM V-8	2000-2002	L619000	M320024	18-5817	—	18-5913	—	18-6293 **
5.0L EFI	GM V-8	1998-99	L012052	L618999	18-5817	—	18-5913	—	18-5960
5.0L EFI	GM V-8	2000-01	L619000	M299999	18-5817	—	18-5913	—	18-6293 **
5.0L MPI	GM V-8	2002	M300000	M320024	18-5817	—	18-5913	—	18-6293 **
198 MIE	GM V-8	1977	4762210	6218461	18-5815	18-5908	18-5908 ①	18-5957	18-5957
198 MIE	GM V-8	1977	4762210	6218461	18-5815	18-5907	18-5907 ⑤	18-5957	18-5957
898	GM V-8	1977-1982	4762210	6218461	18-5801	18-5911	18-5911	18-5957	18-5957

① For 12 3/4" Dia. Flywheel
 ② For 14" Dia. Flywheel
 ③ For permanent magnet models use 18-5919
 ④ 55 AMP up grade to 65 AMP use 18-5965
 ⑤ Black
 ⑥ For permanent magnet models use 18-5913
 ⑦ Bravo drive

⑧ Firepower ignition
 ⑨ Ignition module mounted on distributor
 ⑩ Ignition module mounted on elbow
 ⑪ LH rotation
 ⑫ NLA for models prior to S/N 4167000
 ⑬ PG 260 (9-1/4" long)
 ⑭ PG260F1 (8-1/2" long)

⑮ RH Rotation
 ⑯ Standard ignition
 ⑰ Thunderbolt ignition
 ⑱ Thunderbolt IV
 ⑲ Thunderbolt V
 ⑳ Transmission models
 ** Delco Style

Model	Cyl.	Years	Beg Serial #	End Serial #	Slave Solenoid	Reman Starter	New Starter	Reman Alternator	New Alternator
898	GM V-8	1983-1984	621462	B525981	18-5816	18-5911	18-5911 ① ③	—	18-5966 ④
898	GM V-8	1983-1984	621462	B525981	18-5816	18-5910	18-5910 ② ⑥	—	18-5966 ④
233	Ford V-8	1975-1977	4173000	4902304	18-5801	18-5903	—	18-5957	18-5957
233 MIE	Ford V-8	1975-1976	4173000	4775784	18-5836	18-5908	18-5908 ①	18-5957	18-5957
233 MIE	Ford V-8	1975-1976	4173000	4775784	18-5836	18-5907	18-5907 ⑤	18-5957	18-5957
250 MCM & MIE	GM V-8	1968-1969	2314301	2639854	18-5836	18-5908	18-5908 ①	—	—
250 MCM & MIE	GM V-8	1968-1969	2314301	2639854	18-5836	18-5907	18-5907 ⑤	—	—
250	GM V-8	1977	4768000	4908849	18-5801	18-5911	18-5911	18-5957	18-5957
255	Ford V-8	1973-1974	3258728	4175499	18-5802	18-5903	—	18-5957	18-5957
255 MIE	Ford V-8	1973-1974	3258728	4178299	18-5836	18-5908	18-5908 ①	18-5957	18-5957
255 MIE	Ford V-8	1973-1974	3258728	4178299	18-5836	18-5907	18-5907 ⑤	18-5957	18-5957
255	GM V-8	1975-1976	4175500	4767999	18-5815	18-5911	18-5911	18-5957	18-5957
255 MIE	GM V-8	1975-1980	4175500	5907057	18-5815	18-5908	18-5908 ①	18-5957	18-5957
255 MIE	GM V-8	1975-1980	4175500	5907057	18-5815	18-5907	18-5907 ⑤	18-5957	18-5957
260	GM V-8	1978-1982	4908850	6218461	18-5801	18-5911	18-5911	18-5957	18-5957
260	GM V-8	1982-1986	6218462	B525981	18-5816	18-5911	18-5911 ① ③	—	18-5966 ④
260	GM V-8	1982-1986	6218462	B525981	18-5816	18-5910	18-5910 ② ⑥	—	18-5966 ④
260/5.7L	GM V-8	1987-1995	B525982	F600999	18-5816 ⑩	18-5910	18-5910 ⑥	—	18-5966 ④
260/5.7L	GM V-8	1987-1995	B525982	F600999	18-5817 ⑨	18-5910	18-5910 ⑥	—	18-5966 ④
260/5.7L MIE	GM V-8	1987-1995	5907058	F746099	18-5816	18-5908	18-5908 ①	—	18-5966 ④
260/5.7L MIE	GM V-8	1987-1995	5907058	F746099	18-5816	18-5907	18-5907 ⑤	—	18-5966 ④
5.7L/LX	GM V-8	1996	F601000	K001526	18-5817	—	18-5913	—	18-5966 ④
5.7L/LX	GM V-8	1997 & Up	K001527	& Up	18-5817	—	18-5913	—	18-5967
5.7L	GM V-8	2000-02	L619000	M320024	18-5817	—	18-5913	—	18-6293 **
5.7L/LX EFI	GM V-8	1995-1996	F225560	K001505	18-5816	—	18-5913	—	18-5965
5.7L/LX EFI	GM V-8	1997	K001506	K999999	18-5816	—	18-5913	—	18-5960
5.7L EFI	GM V-8	1998 & Up	L010035	& Up	18-5816	—	18-5913	—	18-5960
5.7L EFI	GM V-8	2000-01	L619000	M299999	18-5816	—	18-5913	—	18-6293 **
5.7L MIE	GM V-8	1994-1996	F622151	K040306	18-5816	18-5908	18-5908 ①	—	18-5966 ④
5.7L MIE	GM V-8	1994-1996	F622151	K040306	18-5816	18-5907	18-5907 ⑤	—	18-5966 ④
5.7L MIE	GM V-8	1997 & Up	K040307	& Up	18-5817	18-5908	18-5908	—	18-5967
5.7L MIE	GM V-8	1998-01	L002003	L677226	18-5817	18-5908	18-5908	—	18-6293 **
5.7L EFI MIE	GM V-8	1997	K040300	K999999	18-5816	18-5908	18-5908	—	18-5960
5.7L Ski	GM V-8	1985-1995	A338533	F775199	18-5816	—	18-5913 ⑤	—	18-5966 ④
5.7L Ski	GM V-8	1985-1995	A338533	F775199	18-5816	18-5907	18-5907 ①	—	18-5966 ④
5.7L Ski	GM V-8	1996	F775200	K040003	18-5817	—	18-5913	—	18-5966 ④
5.7L Ski	GM V-8	1997	K040004	K999999	18-5817	—	18-5913	—	18-5967
5.7L Ski	GM V-8	1998 & Up	L002005	& Up	18-5817	—	18-5913	—	18-5967
5.7L Ski	GM V-8	2000-01	L619000	L678784	18-5817	—	18-5913	—	18-6293 **
350 Mag. Alpha	GM V-8	1986-1995	A635178	F600999	18-5816 ⑩	18-5910	18-5910 ⑥	—	18-5966 ④
350 Mag. Alpha	GM V-8	1987-1996	B525982	K001526	18-5817 ⑨	18-5910	18-5910 ⑥	—	18-5966 ④
350 Mag. Alpha	GM V-8	1997	K001527	K999999	18-5817	—	18-5913	—	18-5967
350 Mag. EFI & MPI	GM V-8	1995-1996	F415189	K001500	18-5816	—	18-5913	—	18-5965
350 Mag. EFI & MPI	GM V-8	1997 & Up	K001501	& Up	18-5816	—	18-5913	—	18-5960

① For 12 3/4" Dia. Flywheel
 ② For 14" Dia. Flywheel
 ③ For permanent magnet models use 18-5919
 ④ 55 AMP up grade to 65 AMP use 18-5965
 ⑤ Black
 ⑥ For permanent magnet models use 18-5913
 ⑦ Bravo drive

⑧ Firepower ignition
 ⑨ Ignition module mounted on distributor
 ⑩ Ignition module mounted on elbow
 ① LH rotation
 ② NLA for models prior to S/N 4167000
 ③ PG 260 (9-1/4" long)
 ④ PG260F1 (8-1/2" long)

⑤ RH Rotation
 ⑥ Standard ignition
 ⑦ Thunderbolt ignition
 ⑧ Thunderbolt IV
 ⑨ Thunderbolt V
 ⑩ Transmission models
 ** Delco Style

Model	Cyl.	Years	Beg Serial #	End Serial #	Slave Solenoid	Reman Starter	New Starter	Reman Alternator	New Alternator
350 Mag MPI	GM V-8	2000-01	L619000	M299999	18-5816		18-5913		18-6293 **
350 Mag MPI / Horizon	GM V-8	2002	M300000	M320024	18-5817		18-5913		18-6293 **
350 Mag MPI MIE	GM V-8	1998 & Up	L002008	& Up	18-5816	18-5908	18-5908	—	18-5960
350 Mag MPI MIE / Horizon	GM V-8	1999-01	L304700	L678398	18-5816	18-5908	18-5908		18-6293 **
350 Mag Ski	GM V-8	1991-1996	D505450	K040399	18-5816 ⑧	—	18-5913	—	18-5966 ④
350 Mag Ski	GM V-8	1991-1996	D505450	K040399	18-5817 ⑧	—	18-5913	—	18-5966 ④
350 Mag Ski	GM V-8	1997	K040400	K999999	18-5817	—	18-5913	—	18-5967
350 Mag EFI Ski	GM V-8	1994-1997	F215561	K999999	18-5816	—	18-5913	—	18-5965
350 Mag MPI Ski	GM V-8	1995-1996	F350583	F799999	18-5816	—	18-5913	—	18-5965
350 Mag MPI Ski	GM V-8	1998 & Up	L002600	& Up	18-5817	—	18-5913	—	18-5960
350 Mag MPI Ski	GM V-8	1998-02	L002600	M310021	18-5817	—	18-5913	—	18-6293 **
Black Scorpion	GM V-8	1996	F800000	K040000	18-5816	—	18-5913	—	18-5965
Black Scorpion	GM V-8	1997 & Up	K040001	& Up	18-5816	—	18-5913 ⑨	—	18-5960
Black Scorpion	GM V-8	1997 & Up	K040001	& Up	18-5816	—	18-5913 ④	—	18-5960
Black Scorpion	GM V-8	1997-01	K040001	L678036	18-5816	—	18-5913	—	18-6293 **
270 MCM & MIE	GM V-8	1969-1972	2851074	3385720	18-5836	18-5908	18-5908 ①	18-5957	18-5957
270 MCM & MIE	GM V-8	1969-1972	2851074	3385720	18-5836	18-5907	18-5907 ⑥	18-5957	18-5957
280 TRS	GM V-8	1975-1976	4176250	4770199	18-5815	18-5911	18-5911	18-5957	18-5957
300 TR TEMPEST	GM V-8	1985-1986	6668677	B430367	18-5816	18-5908	18-5908	—	18-5966 ④
300 MR TEMPEST	GM V-8	1985-1986	6668677	B430367	18-5816	—	18-5919 ①	—	18-5966 ④
300 MR TEMPEST	GM V-8	1985-1986	6668677	B430367	18-5816	—	18-5913 ②	—	18-5966 ④
320 EFI	GM V-8	1987-1989	A543604	C622418	18-5816	—	18-5913	—	18-5966 ④
MX 6.2L MPI	GM V-8	2000-2002	L680003	M320024	18-5817	—	18-5913	—	18-6293
MX 6.2L MPI Horizon	GM V-8	2002	M300000	M320024	18-5817	—	18-5913	—	18-6293
MX 6.2L MPI Horizon MIE	GM V-8	2002	M300000	M310099	18-5817	—	18-5603	—	18-6293
MX 6.2L MPI MIE	GM V-8	2002	M300000	M310099	18-5817	—	18-5603	—	18-6293
MX 6.2L Black Scorpion Ski	GM V-8	2001	L670015	L678036	18-5816	—	18-5913	—	18-6293
325 MCM & MIE	GM V-8	1968-1970	2278747	2761141	18-5836	18-5908	18-5908 ①	—	—
325 MCM & MIE	GM V-8	1968-1970	2278747	2761141	18-5836	18-5907	18-5907 ⑥	—	—
325 MCM & MIE	GM V-8	1970-1974	2761142	3780449	18-5836	18-5908	18-5908 ①	18-5957	18-5957
325 MCM & MIE	GM V-8	1970-1974	2761142	3780449	18-5836	18-5907	18-5907 ⑥	18-5957	18-5957
330	GM V-8	1977-1981	4623115	6083144	18-5836 ⑦	—	18-5913	18-5957	18-5957
330	GM V-8	1977-1981	4623115	6083144	18-5815 ⑧	—	18-5913	18-5957	18-5957
330	GM V-8	1982-1987	6083145	B816540	18-5816	18-5908	18-5908	—	18-5966 ④
330 MIE	GM V-8	1977-1980	4623115	5889913	18-5836 ⑦	18-5908	18-5908 ①	18-5957	18-5957
330 MIE	GM V-8	1977-1980	4623115	5889913	18-5815 ⑧	18-5907	18-5907 ⑥	18-5957	18-5957
340/7.4L MIE w/BW	GM V-8	1981-1992	5889914	D715493	18-5816	18-5908	18-5908 ①	—	18-5966 ④
340/7.4L MIE w/BW	GM V-8	1981-1992	5889914	D715493	18-5816	18-5907	18-5907 ⑥	—	18-5966 ④
7.4L	GM V-8	1988-1991	B771113	D603117	18-5816	18-5910	18-5910 ⑥	—	18-5966 ④
7.4L	GM V-8	1988-1996	B771113	F800699	18-5816 ⑩	18-5910	18-5910 ⑥	—	18-5966 ④
7.4L	GM V-8	1992-1997	D603118	K999999	18-5817 ⑨	—	18-5913	—	18-5966 ④
7.4LX EFI & MPI	GM V-8	1996-1997	F602010	K999999	18-5816	—	18-5913	—	18-5965
7.4L MPI	GM V-8	1998 & Up	L010003	& Up	18-5817	—	18-5913	—	18-6293
7.4L MIE	GM V-8	1989-1996	C391564	F820141	18-5816 ⑧	18-5908	18-5908	—	18-5966 ④
7.4L MIE	GM V-8	1992-1997	D715494	K999999	18-5817 ⑨	18-5908	18-5908	—	18-5966 ④
7.4L EFI & MPI MIE	GM V-8	1995-1997	F563052	K999999	18-5816	18-5908	18-5908	—	18-5965
7.4L MPI MIE	GM V-8	1998 & Up	L002006	& Up	18-5817	18-5908	18-5908	—	18-6293
350 MIE	GM V-8	1974-1976	3780450	4623109	18-5836	18-5908	18-5908 ①	18-5957	18-5957
350 MIE	GM V-8	1974-1976	3780450	4623109	18-5836	18-5907	18-5907 ⑥	18-5957	18-5957

① For 12 3/4" Dia. Flywheel
 ② For 14" Dia. Flywheel
 ③ For permanent magnet models use 18-5919
 ④ 55 AMP up grade to 65 AMP use 18-5965
 ⑤ Black
 ⑥ For permanent magnet models use 18-5913
 ⑦ Bravo drive

⑧ Firepower ignition
 ⑨ Ignition module mounted on distributor
 ⑩ Ignition module mounted on elbow
 ⑪ LH rotation
 ⑫ NLA for models prior to S/N 4167000
 ⑬ PG 260 (9-1/4" long)
 ⑭ PG260F1 (8-1/2" long)

⑮ RH Rotation
 ⑯ Standard ignition
 ⑰ Thunderbolt ignition
 ⑱ Thunderbolt IV
 ⑲ Thunderbolt V
 ⑳ Transmission models
 ** Delco Style

Model	Cyl.	Years	Beg Serial #	End Serial #	Slave Solenoid	Reman Starter	New Starter	Reman Alternator	New Alternator
370 TRS	GM V-8	1978-1985	4179554	6721527	18-5815	18-5908	18-5908	18-5957	18-5957
370 TRS	GM V-8	1978-1985	4179554	6721527	18-5815	18-5908	18-5908	—	18-5966 ④
370 TRS	GM V-8	1985-1987	6721528	B714586	18-5816	18-5908	18-5908	—	18-5966 ④
390 MCM & MIE	GM V-8	1969-1970	2781129	3042731	18-5836	18-5908	18-5908 ①	18-5957	18-5957
390 MCM & MIE	GM V-8	1969-1970	2781129	3042731	18-5836	18-5907	18-5907 ⑤	18-5957	18-5957
400 TRS	GM V-8	1980-1986	4179554	B457644	18-5815	18-5908	18-5908	18-5957	18-5957
400 TRS	GM V-8	1980-1986	4179554	B457644	18-5815	18-5908	18-5908	—	18-5966 ④
420	GM V-8	1987-1989	A398941	B622418	18-5816	18-5908	18-5908	—	18-5966 ④
425	GM V-8	1990-1992	A398941	D937011	18-5816	18-5908	18-5908	—	18-5966 ④
440 TRS	GM V-8	1983-1986	4179554	B485220	18-5815	18-5908	18-5908	18-5957	18-5957
440 TRS	GM V-8	1983-1986	4179554	B485220	18-5815	18-5908	18-5908	—	18-5966 ④
450	GM V-8	1995-1996	F347100	F347277	18-5820	—	18-5913	—	—
454 Mag.	GM V-8	1986-1994	A631894	F304999	18-5816	—	18-5913	—	18-5966 ④
454 Mag.	GM V-8	1995-1997	F305000	K999999	18-5817	—	18-5913	—	18-5966 ④
454 Mag. MPI	GM V-8	1994-1997	F115700	K999999	18-5816	—	18-5913	—	18-5965
454 Mag. MPI	GM V-8	1998 & Up	L010029	& Up	18-5816	—	18-5913	—	18-6293
454 Mag. MPI MIE	GM V-8	1996-1997	F820100	K999999	18-5816	—	18-5913	—	18-5965
454 Mag. MPI MIE	GM V-8	1998 & Up	L002200	& Up	18-5816	18-5908	18-5908	—	18-6293
454 EFI Ski	GM V-8	1995-1996	F215800	F820099	18-5816	—	18-5913	—	18-5965
460 TRS	GM V-8	1983-1986	4179554	6181046	18-5815	18-5908	18-5908	18-5957	18-5957
460 TRS	GM V-8	1983-1986	4179554	6181046	18-5815	18-5908	18-5908	—	18-5966 ④
465	GM V-8	1990-1994	C849992	F213244	18-5816 ⑥	—	18-5913 ⑦	—	18-5966 ④ ⑤
465	GM V-8	1990-1994	C849992	F213244	—	18-5908	18-5908 ⑩	—	—
500	GM V-8	1994-1997	F213293	& Up	18-5820	—	18-5913 ⑦	—	—
500	GM V-8	1994-1995	F213293	& Up	18-5820	18-5908	18-5908 ⑩	—	—
500 Bulldog	GM V-8	1990-1996	C577254	& Up	18-5820 ⑧	—	18-5913 ⑦	—	—
500 Bulldog	GM V-8	1990-1996	C577254	& Up	18-5816 ⑧	18-5908	18-5908 ⑩	—	18-5966 ④ ⑤
502 Mag. Bravo	GM V-8	1990-1993	C878221	F114528	18-5816	—	18-5913	—	18-5966 ④
502 Mag. MPI	GM V-8	1993-1997	D840650	K999999	18-5816	—	18-5913	—	18-5965
502 Mag. MPI	GM V-8	1998 & Up	L017000	& Up	18-5816	—	18-5913	—	18-6293
525 SC	GM V-8	1991-1993	D456000	D763831	18-5816	—	18-5913 ⑦	—	18-5966 ④ ⑤
525 SC	GM V-8	1991-1993	D456000	D763831	18-5816	18-5908	18-5908 ⑩	—	—
525 SC	GM V-8	1993-1997	D763871	& Up	18-5820	—	18-5913 ⑦	—	18-5966 ④ ⑤
525 SC	GM V-8	1993-1997	D763871	& Up	18-5820	18-5908	18-5908 ⑩	—	—
525 EFI	GM V-8	2003-2010	M900146	& Up	—	—	—	—	18-6298
575	GM V-8	1986-1992	A677429	D763716	18-5816	18-5908	18-5908	—	18-5966 ④
600 SC	GM V-8	1991-1996	D456489	F877642	18-5816 ⑧	18-5908	18-5908	—	18-5966 ④ ⑤
600 SC	GM V-8	1991-1996	D456489	F877642	18-5820 ⑧	18-5908	18-5908	—	—
600 SC	GM V-8	1997	K000227	& Up	18-5820	—	18-5913 ⑩	—	—
600 Sci	GM V-8	2005-2010	M952908	& Up	—	—	—	—	18-6298
800 SC	GM V-8	1993-1996	D763836	& Up	18-5820	18-5908	18-5908 ⑩	—	—
8.2L MIE	GM V-8	1990-1996	C878221	F819619	18-5816 ⑨	18-5908	18-5908	—	18-5966 ④
8.2L MIE	GM V-8	1993-1996	D857200	F819619	18-5817	18-5908	18-5908	—	18-5966 ④
8.2L MPI MIE	GM V-8	1996-1997	F819620	K999999	18-5816	18-5908	18-5908	—	18-5965
8.2L MPI MIE	GM V-8	1998 & Up	L002450	& Up	18-5816	18-5908	18-5908	—	18-6293

① For 12 3/4" Dia. Flywheel	⑧ Firepower ignition	⑤ RH Rotation
② For 14" Dia. Flywheel	⑨ Ignition module mounted on distributor	⑥ Standard ignition
③ For permanent magnet models use 18-5919	⑩ Ignition module mounted on elbow	⑦ Thunderbolt ignition
④ 55 AMP up grade to 65 AMP use 18-5965	⑪ LH rotation	⑧ Thunderbolt IV
⑤ Black	⑫ NLA for models prior to S/N 4167000	⑨ Thunderbolt V
⑥ For permanent magnet models use 18-5913	⑬ PG 260 (9-1/4" long)	⑩ Transmission models
⑦ Bravo drive	⑭ PG260F1 (8-1/2" long)	⑪ Delco Style
		⑫



18-7683
FUEL PRESSURE REGULATOR
 Replaces: 849899
 Fits: MCM 500 EFI



18-7663
FUEL PRESSURE REGULATOR
 Replaces: 802630T01, 802630001, 802630T, 802630, 8M0069803
 7.4L MPI (L29)



18-33207
FUEL PRESSURE REGULATOR
 Replaces: 860349A1
 Fits: MCM/MIE 7.4L/LX MPI, 4545 Mag MPI, 502 Mag MPI, MIE 8.2L MPI. Mounts on Fuel Cooler.



18-33211
FUEL PRESSURE REGULATOR
 Replaces: 892681
 Fits: Mercruiser 8.1L, 496 Mag HO, 502 Mag MPI 375-400 HP.



18-7600
TEMPERATURE SENSOR
 Replaces: 805218T



18-7700
THROTTLE POSITION SENSOR
 Replaces: 853678T
 Fits: MCM/MIE 4.3L MPI, 5.0L MPI, MX6.2L MPI w/ECM 555 and 350 Mag MPI, Black Scorpion Tow Sports, 377 Scorpion Tow Sports, 7.4L MPI(L29) & MCM 496 Mag & HO and MIE 8.1S & HO



18-7630
THROTTLE POSITION SENSOR
 Replaces: 805226A1



18-7701
IDLE SPEED CONTROL MOTOR
 Replaces: 862998
 Fits: MCM 3.0L MPI, V6 & V8(305, 350 & 496 cid)MPI engines w/ECM555 (Includes gasket)



18-7697
IAC MOTOR
 Replaces: 803149
 Fits: MCM/MIE 350 Mag MPI, Black Scorpion Tow Sports, 377 Scorpion MCM & Tow Sports, MX6.2L MPI, 7.4L MPI(L29) & 575 Sci



18-7632-1
IDLE AIR CONTROL MOTOR
 Replaces: 805224A1



18-33800
PCV VALVE
 Replaces: 21-806118
 Fits: MCM 262 Mag EFI, 4.3L EFI



18-7682
MAP SENSOR
 Replaces: 849934, 879150150
 Fits: MCM 575 Sci



18-7684
MAP SENSOR
 Replaces: 864856A1, 805217A1
 Fits: MCM/MIE GM V6 & V8 (350, 377, 454 & 502cid)EFI Engines



18-7660
MAP SENSOR
 Replaces: 881731, 8M0054726
 V-6 & V-8 MPI engines with 555 ECM



18-7550
MAP SENSOR
 Replaces: 861249, 861249A1
 Fits: Mercury 5.7L, 7.4L 1998-2001



18-7551
MAP SENSOR
 Replaces: 861425
 Fits: Mercury Scorpion,
 Black Scorpion 1998-2010



18-7668
MAP SENSOR
 Replaces: 854445
 525 EFI



18-7553
KNOCK SENSOR
 Replaces: 808015T
 Fits: Mercury 5.7L MAG 1998-2010



18-7554
KNOCK SENSOR
 Replaces: 878187
 Fits: Mercury 5.7L MAG 1994-2010



18-7677
KNOCK SENSOR
 Replaces: 806612T
 Fits: GM V8(305, 350 & 377 cid) engines



18-7703
KNOCK SENSOR
 Replaces: 805544T



18-7646
CAMSHAFT SENSOR
 Replaces: 892615002, 892615001, 892615



18-7685
TBI INJECTOR
 Replaces: 852956A1
 Fits: MCM GM V6 & V8 (305 & 350 cid) TBI engines



18-7757
THROTTLE POSITION SENSOR
 Replaces: 803148
 For: 350 Mag OL005900 & Up



18-33104
FUEL INJECTOR
 Replaces: 802632T, 802632
 Fits: MCM/MIE 7.4L MPI L29



18-7688
FUEL INJECTOR
 Replaces: 885176
 Fits: MCM 4.3L MPI engines (s/n OM300000-1A063239)
 & 5.0L, 5.7L & 6.2L MPI engines w/ ECM 555
 (s/n OM300000-1A064824)



18-7698
FUEL INJECTOR
 Replaces: 881693002
 Fits: MCM 496 Mag & HO and MIE 8.1S & HO

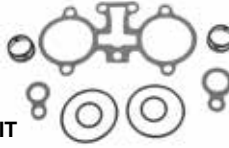

**18-7690
INJECTOR SEAL KIT**
Replaces: 27-852957
Use with Mercury Injector # 852956A1, 853998A1, 853998T, 853998
Fits: 262 Mag EFI (1996-97), 4.3L EFI (1998-01), 5.0L EFI (1998-01), 350 Mag Alpha EFI (Gen+) (1996-97), 350 Mag EFI SKI (1994-97), 5.7L EFI (1995-01), 5.7L EFI MIE (Gen+) (1997), 5.7L LX Bravo EFI (Gen+) (1996-97), 5.7 LX EFI (1995-97), 7.4L LX TBI (1996-97), 575 Sci (2000-05)



**18-7691
INJECTOR SEAL KIT**
Use with Mercury Injector # 806807A1
Fits: 350 Mag Bravo MPI (1995-96), Black Scorpion SKI (1996)



**18-7692
INJECTOR SEAL KIT**
Use with Mercury Injector # 861260T, 861260
Fits: 350 Mag MPI(98-01), 350 Mag MPI Horizon MIE(99-01), 350 Mag MPI MIE(98-01), 350 Mag MPI SKI(98-01), MX 6.2L MPI(00-01), 454 Mag MPI(99-01), 454 Mag MPI Horizon MIE(99-01), 502 Mag MPI(99-01), 8.2L MPI(99-01)



**18-7693
INJECTOR SEAL KIT**
Use with Mercury Injector # 802632T, 849896
Fits: 7.4L MPI(L29)(98-01), 7.4L MPI MIE(L29)(98-01), 500 EFI(99-05)



**18-7694
INJECTOR SEAL KIT**
Use with Mercury Injector # 881693002
Fits: 496 Mag (2001-08), 496 Mag DTS (2001-08), 496 Mag HO (2001-08), 496 Mag HO DTS (2001-08), 8.1L MIE (2001-08), 496 Mag DTS (2001-08), 8.1L HO MIE (2001-08), 496 Mag HO DTS (2001-08)



**18-7695
INJECTOR SEAL KIT**
Use with Mercury Injector # 885176
Fits: 4.3L MPI(02-08), 5.0L MPI(02-08), 5.0L MPI DTS(05-08), 350 Mag MPI(02-08), 350 Mag MPI DTS(05-08), 350 Mag MPI Horizon(02-07), 350 Mag MPI Horizon DTS(05-07), 350 Mag MPI Horizon MIE(02-07), 350 Mag MPI Horizon MIE DTS(05-07), 350 Mag MPI MIE(02-07), 350 Mag MPI MIE DTS(05-07), 350 Mag MPI SKI(02-07), 5.7L Horizon MIE(08), 5.7L MIE(08), 5.7L DTS MIE(08), 5.7L MPI SKI(08), MX6.2L MPI(02-07), MX6.2L MPI DTS(05-07), MX6.2L MPI Horizon(04-07), MX6.2L MPI Horizon DTS(05-07), MX6.2L MPI Horizon MIE(02-08), MX6.2L MPI Horizon MIE DTS(05-08), MX 6.2L MPI MIE(02-07), MX6.2L MPI MIE DTS(05-07), MX6.2L MPI SKI(02-07)



**18-7696
INJECTOR SEAL KIT**
Use with Mercury Injector # 805225A1
Fits: 320 EFI(87-89), 350 Mag Bravo MPI(Gen+)(97), Black Scorpion Ski(97-08), 377 Scorpion MCM(99-05), 377 Scorpion Ski(97-98), MX6.2L Black Scorpion Ski (01-07), 454 Mag EFI SKI(94-97), 454 Mag MPI(96-98), 454 Mag MPI Horizon MIE(98), 7.4L MPI MIE (95-97), 7.4LX MPI(96-97), 502 Mag MPI(93-98), 525 EFI(03-08), 8.2L MPI MIE(96-98)

FUEL INJECTION SYSTEM APPLICATION

Model	Liter	CID	# CYL	Year Range	Serial # Range	Injector	IAC Valve	TPS	F/P Regulator Rail-Mounted	F/P Regular Cooler Mounted	MAP Sensor
3.0L MPI	3.0L	181	L4	2008-2010	A072812 & UP	N/A	18-7701	N/A	N/A	N/A	N/A
262 MAG EFI	4.3L	262	V-6	1996-1997	F803800 - K999999	18-7685	18-7632-1	18-7630	N/A	N/A	18-7684
4.3L EFI	4.3L	262	V-6	1998-2001	L012009 - M299999	18-7685	18-7632-1	18-7630	N/A	N/A	N/A
4.3L MPI	4.3L	262	V-6	2002-2007	M300000 - A063239	18-7688	18-7701	18-7700	N/A	N/A	N/A ⊕
4.3L MPI	4.3L	262	V-6	2007-2010	A063240 & UP	N/A	18-7701	18-7700	N/A	N/A	N/A ⊕
5.0L EFI	5.0L	305	V-8	1998-2001	L012052 - M299999	18-7685	18-7632-1	18-7630	N/A	N/A	N/A
5.0L MPI	5.0L	305	V-6	2002-2007	M300000 - A064824	18-7688	18-7701	18-7700	N/A	N/A ⊕	N/A ⊕
5.0L MPI	5.0L	305	V-6	2007-2010	A064825 & UP	N/A	18-7701	18-7700	N/A	N/A ⊕	N/A ⊕
5.0L MPI DTS	5.0L	305	V-8	2005-2007	W310000 - A064824	18-7685	N/A	N/A	N/A	N/A	N/A
5.0L MPI DTS	5.0L	305	V-8	2010	A064825 & UP	N/A	N/A	N/A	N/A	N/A	N/A
350 MAG ALPHA EFI (GEN +)	5.7L	350	V-8	1996-1997	F800300 - K999999	18-7685	18-7632-1	18-7630	N/A	N/A	18-7684
350 MAG BRAVO MPI	5.7L	350	V-8	1995-1996	F415189 - K001500	N/A	18-7632-1	18-7630	N.L.A.	N/A	18-7684 ⊕
350 MAG BRAVO MPI (GEN +)	5.7L	350	V-8	1997	K001501 - K999999	N/A	18-7632-1	18-7630	N/A	N/A	18-7684 ⊕
350 MAG EFI SKI	5.7L	350	V-8	1994-1996	F215561 - F820706	18-7685	18-7632-1	18-7630	N/A	N/A	18-7684
350 MAG EFI SKI	5.7L	350	V-8	1996	F820707 - K040005	18-7685	18-7632-1	18-7630	N/A	N/A	18-7684
350 MAG MPI	5.7L	350	V-8	1998	L010019 - L331598	N/A	18-7697	18-7700	N/A	N/A	N/A
350 MAG MPI	5.7L	350	V-8	1998	L336000 - L346999	N/A	18-7697	18-7700	N/A	N/A	N/A
350 MAG MPI	5.7L	350	V-8	1999	L331599 - L335999	N/A	18-7697	18-7757	N/A	N/A	N/A
350 MAG MPI	5.7L	350	V-8	1999-2001	L340000 - M299999	N/A	18-7697	18-7757	N/A	N/A	N/A
350 MAG MPI	5.7L	350	V-8	2002-2007	M300000 - A064824	18-7688	18-7701	18-7700	N/A	N/A ⊕	N/A ⊕
350 MAG MPI DTS	5.7L	350	V-8	2005-2007	W310000 - A064824	18-7688	N/A	N/A	N/A	N/A	N/A ⊕
350 MAG MPI DTS	5.7L	350	V-8	2007-2010	A064825 & UP	N/A	N/A	N/A	N/A	N/A	N/A ⊕
350 MAG MPI HORIZON	5.7L	350	V-8	2002-2007	M300000 - A064824	18-7688	18-7701	18-7700	N/A	N/A ⊕	N/A ⊕
350 MAG MPI HORIZON	5.7L	350	V-8	2007	A064825 - A299999	N/A	18-7701	18-7700	N/A	N/A ⊕	N/A ⊕
350 MAG MPI HORIZON DTS	5.7L	350	V-8	2005-2007	W310000 - A064824	18-7688	N/A	N/A	N/A	N/A	N/A ⊕
350 MAG MPI HORIZON DTS	5.7L	350	V-8	2007	A064825 - A299999	N/A	N/A	N/A	N/A	N/A	N/A ⊕
350 MAG MPI HORIZON MIE	5.7L	350	V-8	1999-2001	L304700 - M299999	N/A	18-7697	18-7757	N/A	N/A	N/A
350 MAG MPI HORIZON MIE	5.7L	350	V-8	2002-2004	M300000 - M398371	18-7688	18-7701	18-7700	N/A	N/A	N/A ⊕

⊕ BRAVO APPS W/SN W060000, ORDER REGULATOR # 892681 ⊕ MAPT SENSOR (TEMP & PRESSURE)

FUEL INJECTION SYSTEM APPLICATION (CONT.)

Model	Liter	CID	# CYL	Year Range	Serial # Range	Injector	IAC Valve	TPS	F/P Regulator Rail-Mounted	F/P Regular Cooler Mounted	MAP Sensor
350 MAG MPI HORIZON MIE	5.7L	350	V-8	2004-2007	M398372 - A064824	18-7688	18-7701	18-7700	N/A	N/A	N/A ⊕
350 MAG MPI HORIZON MIE	5.7L	350	V-8	2007	A064825 - A089999	N/A	18-7701	18-7700	N/A	N/A	N/A ⊕
350 MAG MPI HORIZON MIE DTS	5.7L	350	V-8	2005-2007	W390000 - A064824	18-7688	N/A	N/A	N/A	N/A	N/A ⊕
350 MAG MPI HORIZON MIE DTS	5.7L	350	V-8	2007	A064825 - A089999	N/A	N/A	N/A	N/A	N/A	N/A ⊕
350 MAG MPI MIE	5.7L	350	V-8	1998	L002008 - L302199	N/A	18-7697	18-7700	N/A	N/A	N/A
350 MAG MPI MIE	5.7L	350	V-8	1999-2001	L302200 - M299999	N/A	18-7697	18-7757	N/A	N/A	N/A
350 MAG MPI MIE	5.7L	350	V-8	2002-2004	M300000 - M398371	18-7688	18-7701	18-7700	N/A	N/A	N/A ⊕
350 MAG MPI MIE	5.7L	350	V-8	2004-2007	M398372 - A064824	18-7688	18-7701	18-7700	N/A	N/A	N/A ⊕
350 MAG MPI MIE	5.7L	350	V-8	2007	A064825 - A089999	N/A	18-7701	18-7700	N/A	N/A	N/A ⊕
350 MAG MPI MIE DTS	5.7L	350	V-8	2005-2007	W390000 - A064824	18-7688	N/A	N/A	N/A	N/A	N/A ⊕
350 MAG MPI MIE DTS	5.7L	350	V-8	2007	A064825 - A089999	N/A	N/A	N/A	N/A	N/A	N/A ⊕
350 MAG EFI SKI	5.7L	350	V-8	1994-1996	F215561 - F820706	18-7685	18-7632-1	18-7630	N/A	N/A	18-7684
350 MAG MPI SKI	5.7L	350	V-8	1998	L002600 - L304599	N/A	18-7697	18-7700	N/A	N/A	N/A
350 MAG MPI SKI	5.7L	350	V-8	1999-2001	L304600 - M299999	N/A	18-7697	18-7757	N/A	N/A	N/A
350 MAG MPI SKI	5.7L	350	V-8	2002-2007	M300000 - A064824	N/A	18-7701	18-7700	N/A	N/A	N/A ⊕
350 MAG MPI SKI	5.7L	350	V-8	2007	A064825 - A089999	N/A	18-7701	18-7700	N/A	N/A	N/A ♦
5.7L EFI	5.7L	350	V-8	1995-1997	F225560 - K999999	18-7685	18-7632-1	18-7630	N/A	N/A	18-7684
5.7L EFI (GEN +)	5.7L	350	V-8	1998-2001	L010035 - M299999	18-7685	18-7632-1	18-7630	N/A	N/A	N/A
5.7L EFI MIE (GEN +)	5.7L	350	V-8	1997	K040300 - K999999	18-7685	18-7632-1	18-7630	N/A	N/A	18-7684
5.7L MPI HORIZON MIE	5.7L	350	V-8	2008-2010	A090000 - & UP	N/A	18-7701	18-7700	N/A	N/A	N/A ♦
5.7L MPI HORIZON DTS MIE	5.7L	350	V-8	2008-2010	A090000 - & UP	N/A	N/A	N/A	N/A	N/A	N/A ♦
5.7L MPI MIE	5.7L	350	V-8	2008-2010	A090000 - & UP	N/A	18-7701	18-7700	N/A	N/A	N/A ♦
5.7L MPI DTS MIE	5.7L	350	V-8	2008-2010	A090000 - & UP	N/A	N/A	N/A	N/A	N/A	N/A ♦
5.7L MPI SKI	5.7L	350	V-8	2008-2010	A090000 - & UP	N/A	N/A	18-7700	N/A	N/A	N/A ♦
5.7LX BRAVO EFI (GEN +)	5.7L	350	V-8	1996-1997	F800300 - K999999	18-7685	18-7632-1	18-7630	N/A	N/A	18-7684
5.7LX EFI	5.7L	350	V-8	1995-1997	F225560 - K999999	18-7685	18-7632-1	18-7630	N/A	N/A	18-7684
BLACK SCORPION SKI		350	V-8	1996	F350583 - K040000	N/A	18-7697	18-7700	N.L.A.	N.L.A.	18-7684
BLACK SCORPION SKI		350	V-8	1997	K040001 - L002699	N/A	18-7697	18-7700	N/A	N/A	18-7684
BLACK SCORPION SKI		350	V-8	1998	L002700 - L005600	N/A	18-7697	18-7700	N/A	N/A	N/A
BLACK SCORPION SKI		350	V-8	1998-2002	L005601 - M391599	N/A	18-7697	18-7757	N/A	N/A	N/A
BLACK SCORPION SKI		350	V-8	2003-2010	M391600 - W698432	N/A	18-7701	18-7757	N/A	N/A	N/A
SCORPION 350	5.0L	350	V-8	2008-2010	W698433 & UP	N/A	18-7701	18-7757	N/A	N/A	N/A
377 MAG		377	V-8	2008-2010	A300000 & UP	N/A	18-7701	18-7700	N/A	N/A	N/A ♦
377 MAG DTS		377	V-8	2008-2010	A300000 & UP	N/A	N/A	N/A	N/A	N/A	N/A ♦
377 SCORPION MCM		377	V-8	1999-2005	L416146 - M907201	N/A	18-7697	18-7757	N/A	N/A	18-7684
377 SCORPION SKI		377	V-8	1997-1998	K000656 - L600314	N/A	18-7697	18-7700	N/A	N/A	18-7684
MX 6.2L MPI	6.2L	377	V-8	2000-2001	L680003 - M299999	N/A	18-7697	18-7757	N/A	N/A	N/A
MX 6.2L MPI	6.2L	377	V-8	2002-2004	M300000 - W059999	18-7688	18-7701	18-7700	N/A	N/A	N/A ♦
MX 6.2L MPI	6.2L	377	V-8	2004-2007	W060000 - A064824	18-7688	18-7701	18-7700	N/A	N/A	N/A ♦
MX 6.2L MPI	6.2L	377	V-8	2007	A064825 - A299999	N/A	18-7701	18-7700	N/A	N/A	N/A ♦
MX 6.2L MPI DTS.	6.2L	377	V-8	2005-2007	W310000 - A064824	18-7688	N/A	N/A	N/A	N/A	N/A ♦
MX 6.2L MPI DTS.	6.2L	377	V-8	2007	A064825 - A299999	N/A	N/A	N/A	N/A	N/A	N/A ♦
MX 6.2L MPI HORIZON	6.2L	377	V-8	2002-2004	M300000 - W059999	18-7688	18-7701	18-7700	N/A	N/A	N/A ♦
MX 6.2L MPI HORIZON	6.2L	377	V-8	2004-2007	W060000 - A064824	18-7688	18-7701	18-7700	N/A	N/A	N/A ♦
MX 6.2L MPI HORIZON	6.2L	377	V-8	2007	A064825 - A299999	N/A	18-7701	18-7700	N/A	N/A	N/A ♦
MX 6.2L MPI HORIZON DTS	6.2L	377	V-8	2005-2007	W310000 - A064824	18-7688	N/A	N/A	N/A	N/A	N/A ♦
MX 6.2L MPI HORIZON DTS	6.2L	377	V-8	2007	A064825 - A299999	N/A	N/A	N/A	N/A	N/A	N/A ♦
MX 6.2L MPI HORIZON MIE	6.2L	377	V-8	2002-2004	M300000 - M398394	18-7688	18-7701	18-7700	N/A	N/A	N/A ♦
MX 6.2L MPI HORIZON MIE	6.2L	377	V-8	2004-2007	M398395 - A064825	18-7688	18-7701	18-7700	N/A	N/A	N/A ♦
MX 6.2L MPI HORIZON MIE	6.2L	377	V-8	2007-2010	A064825 & UP	N/A	18-7701	18-7700	N/A	N/A	N/A ♦
MX 6.2L MPI HORIZON MIE DTS	6.2L	377	V-8	2005-2007	W390000 - A064824	18-7688	N/A	N/A	N/A	N/A	N/A ♦
MX 6.2L MPI HORIZON MIE DTS	6.2L	377	V-8	2007-2010	A064825 & UP	N/A	N/A	N/A	N/A	N/A	N/A ♦
MX 6.2L MPI MIE	6.2L	377	V-8	2002-2004	M300000 - M398394	18-7688	18-7701	18-7700	N/A	N/A	N/A ♦
MX 6.2L MPI MIE	6.2L	377	V-8	2004-2007	M398395 - A064825	18-7688	18-7701	18-7700	N/A	N/A	N/A ♦
MX 6.2L MPI MIE	6.2L	377	V-8	2007-2010	A064825 & UP	N/A	18-7701	18-7700	N/A	N/A	N/A ♦
MX 6.2L MPI MIE DTS	6.2L	377	V-8	2005-2007	W390000 - A064824	18-7688	N/A	N/A	N/A	N/A	N/A ♦
MX 6.2L MPI MIE DTS	6.2L	377	V-8	2007-2010	A064825 & UP	N/A	N/A	N/A	N/A	N/A	N/A ♦

⊕ BRAVO APPS W/SN W060000, ORDER REGULATOR # 892681 ♦ MAPT SENSOR (TEMP & PRESSURE)

FUEL INJECTION SYSTEM APPLICATION (CONT.)

Model	Liter	CID	# CYL	Year Range	Serial # Range	Injector	IAC Valve	TPS	F/P Regulator Rail-Mounted	F/P Regular Cooler Mounted	MAP Sensor
MX 6.2L MPI SKI	6.2L	377	V-8	2002-2007	M317000 - W689999	18-7688	18-7701	18-7700	N/A	N/A	N/A ♦
MX 6.2L BLACK SCORPION SKI	6.2L	377	V-8	2001-2003	L005601 - M391599	N/A	18-7697	18-7757	N/A	N/A	N/A
MX 6.2L BLACK SCORPION SKI	6.2L	377	V-8	2003-2007	M391750 - W698432	N/A	18-7701	18-7757	N/A	N/A	N/A
454 MAG EFI	7.4L	454	V-8	1994-1996	F115700 - F802349	N/A	18-7632-1	18-7630	N/A	N/A	18-7684
454 MAG EFI SKI	7.4L	454	V-8	1995-1996	F215800 - F820099	N/A	18-7632-1	18-7630	N/A	N/A	18-7684
454 MAG EFI SKI	7.4L	454	V-8	1996-1997	F820099 - K999999	N/A	18-7632-1	18-7630	N/A	N/A	18-7684
454 MAG MPI	7.4L	454	V-8	1996-1997	F802350 - K147349	N/A	18-7632-1	18-7630	N/A	N/A	18-7684
454 MAG MPI	7.4L	454	V-8	1997-1998	K147350 - L085399	N/A	18-7632-1	18-7630	N/A	N/A	18-7684
454 MAG MPI	7.4L	454	V-8	1999-2001	L085400 - M024999	N/A	18-7632-1	18-7630	N/A	N/A	18-7684
454 MAG MPI HORIZON MIE	7.4L	454	V-8	1998	L002200 - L086049	N/A	18-7632-1	18-7630	N/A	N/A	18-7684
454 MAG MPI HORIZON MIE	7.4L	454	V-8	1999-2001	L086050 - L674000	N/A	18-7632-1	18-7630	N/A	N/A	18-7684
7.4L MPI (L29)	7.4L	454	V-8	1998-2001	L010003 - M024330	N/A	18-7697	18-7700	18-7663	N/A	N/A
7.4L MPI MIE	7.4L	454	V-8	1995-1996	F563052 - K147349	N/A	18-7632-1	18-7630	N/A	N/A	18-7684
7.4L MPI MIE	7.4L	454	V-8	1997	K147350 - K999999	N/A	N/A	18-7630	N/A	N/A	18-7684
7.4L MPI MIE (L29)	7.4L	454	V-8	1998-2001	L010003 - L674613	N/A	N/A	18-7700	18-7663	N/A	N/A
7.4LX TBI	7.4L	454	V-8	1996-1997	F820000 - K999999	N.L.A.	18-7632-1	18-7630	N/A	N/A	18-7684
7.4LX MPI	7.4L	454	V-8	1996	F602010 - K147349	N/A	18-7632-1	18-7630	N/A	N/A	18-7684
7.4LX MPI	7.4L	454	V-8	1997	K147350 - K999999	N/A	18-7632-1	18-7630	N/A	N/A	18-7684
496 MAG		496	V-8	2001-2004	M025000 - W059999	N/A	N/A	18-7700	18-7663	N/A	N/A
496 MAG		496	V-8	2004	W060000 - W060573	N/A	N/A	18-7700	18-7663	N/A	N/A
496 MAG		496	V-8	2004-2010	W060574 - & UP	N/A	N/A	18-7700	N/A	N/A	N/A
496 MAG DTS		496	V-8	2001-2004	M025000 - W059999	N/A	N/A	N/A	18-7663	N/A	N/A
496 MAG DTS		496	V-8	2004	W060000 - W060573	N/A	N/A	N/A	18-7663	N/A	N/A
496 MAG HO		496	V-8	2001-2004	M025000 - W059999	N/A	N/A	18-7700	18-7663	N/A	N/A
496 MAG HO		496	V-8	2004	W060000 - W060461	N/A	N/A	18-7700	18-7663	N/A	N/A
496 MAG HO		496	V-8	2004-2010	W060462 - & UP	N/A	N/A	18-7700	N/A	N/A	N/A
496 MAG HO DTS		496	V-8	2001-2004	M025000 - W059999	N/A	N/A	N/A	18-7663	N/A	N/A
496 MAG HO DTS		496	V-8	2004	W060000 - W060461	N/A	N/A	N/A	18-7663	N/A	N/A
496 MAG HO DTS		496	V-8	2004-2010	W060462 - & UP	N/A	N/A	N/A	N/A	N/A	N/A
496 MAG & HO EC		496	V-8	2007-2010	A066166 & UP	N/A	N/A	18-7700	N/A	N/A	N/A
496 MAG & HO DTS EC		496	V-8	2010		N/A	N/A	N/A	N/A	N/A	N/A
8.1L & HO MIE		496	V-8	2001-2004	M026000 - W089999	N/A	N/A	18-7700	18-7663	N/A	N/A
8.1L & HO MIE		496	V-8	2004	W090000 - W389999	N/A	N/A	18-7700	18-7663	N/A	N/A
8.1L & HO MIE		496	V-8	2004-2010	W390000 - & UP	N/A	N/A	18-7700	N/A	N/A	N/A
8.1L & HO MIE DTS		496	V-8	2001-2004	M026000 - W089999	N/A	N/A	N/A	18-7663	N/A	N/A
8.1L & HO MIE DTS		496	V-8	2004	W090000 - W389999	N/A	N/A	N/A	18-7663	N/A	N/A
8.1L & HO MIE EC		496	V-8	2007-2010	W697154 - & UP	N/A	N/A	18-7700	N/A	N/A	N/A
500 EFI	8.2L	502	V-8	1999-2005	L001477 - M907127	N/A	18-7632-1	N/A	N/A	N/A	18-7684
502 MAG MPI	8.2L	502	V-8	1993-1996	D840650 - K147349	N/A	18-7632-1	18-7630	N/A	N/A	18-7684
502 MAG MPI	8.2L	502	V-8	1997-1998	K147350 - L085432	N/A	18-7632-1	18-7630	N/A	N/A	18-7684
502 MAG MPI	8.2L	502	V-8	1999-2001	L085432 - M024999	N/A	18-7632-1	18-7630	N/A	N/A	18-7684
575 Sci	8.2L	502	V-8	2000-2005	L306696 - M950526	N.L.A.	18-7632-1	18-7630	N/A	N/A	N/A
575 Sci	8.2L	502	V-8	2000-2005	L306696 - M950526	N.L.A.	18-7632-1	18-7630	N/A	N/A	N/A
8.2L MAG	8.2L	502	V-8	2010	A350340 & UP	N/A	N/A	18-7700	N/A	N/A	N/A
8.2L MIE	8.2L	502	V-8	2010	A350340 & UP	N/A	N/A	18-7700	N/A	N/A	N/A
8.2L MPI MIE	8.2L	502	V-8	1996	F819620 - K147349	N/A	18-7632-1	18-7630	N/A	N/A	18-7684
8.2L MPI MIE	8.2L	502	V-8	1997-1998	K127350 - L086012	N/A	18-7632-1	18-7630	N/A	N/A	18-7684
8.2L MPI MIE	8.2L	502	V-8	1999-2001	L086013 - L674200	N/A	18-7632-1	18-7630	N/A	N/A	18-7684

① BRAVO APPS W/SN W060000, ORDER REGULATOR # 892681

♦ MAPT SENSOR (TEMP & PRESSURE)



ALL SIERRA CARBURETORS INCLUDE BASE GASKET

- Precision remanufactured to meet or exceed OEM specifications
- Re-calibrated and re-engineered to maximize fuel efficiency and performance
- All carburetors are flow tested throughout the entire throttle range
- Fuel mixture and idle settings are pre-set to ensure that only minor idle and choke adjustments are necessary during installation
- All bases are resurfaced and throttle shaft bushings replaced



**18-7370N
CARBURETOR**
Replaces: 3310-860070A2,
3310-806077A2, 3310-806078A2,
1389-9562A1, 1389-9350A2,
1389-8490A2, 1389-815396A2
For: MCM 120/2.5L & 140/3.0L



**18-7373N
MERCARB 2V CARBURETOR**
Replaces: 3310-864941A01
2002-2004 4.3L engines
(s/n OM615000-OW300012
Uses Carb Kit **18-7098-1**



**18-7375N
CARBURETOR**
Replaces: 3310-864942A01,
3310-861448A1
For: 1998-2004 MCM 5.0L



**18-7376N
CARBURETOR**
Replaces: 3310-864943A01,
3310-861245A1
For: 1998 and newer 5.7L applications



**18-7615N
Q-JET CARBURETOR**
Replaces: 1347-816373A4,
1347-804624R1,
1347-804624R02
Uses Carb Kit **18-7095**



**18-7639
CARBURETOR**
Replaces: 3310-864943A01,
861245A1
Mercarb-5.7L 2V 1998 and newer 5.7L
(OL010337-OW300754) & 5.7L MIE
(OL002003-OW090899)
(Remanufactured)
Uses Carb Kit **18-7098-1** & Gasket **18-0994**



**18-7640
CARBURETOR**
Universal Q-jet with electric choke
(Remanufactured)
Uses Carb Kit **18-7095** & Gasket **18-0994**



**18-7603-1
CARBURETOR**
2 Barrel - Rochester
Replaces: 1347-818622,
1376-5659A1, 1347-818622 1,
1347-818622R02
(Remanufactured)
Uses Carb Kit **18-7075** & Gaskets **18-0994**
(left) & **18-0434** (right)



**18-7604-1
CARBURETOR**
4 Barrel - Rochester
Replaces: 3304-9354A2,
1347-804623R02, 1347-804623R1
(Remanufactured)
Uses Carb Kit **18-7095** & Gasket **18-2648**



**18-7605-1
CARBURETOR**
4 Barrel - Rochester
Replaces: 1347-9661A3,
1347-804623A1, 1347-804623R02
(Remanufactured)
Uses Carb Kit **18-7095** & Gasket **18-2648**



**18-7608-1
CARBURETOR**
2 Barrel - Rochester
Replaces: 1347-818620,
1347-818620 1, 1347-818620R02
(Remanufactured)
Uses Carb Kit **18-7070** & Gasket **18-0356**



**18-7609-1
CARBURETOR**
2 Barrel - Rochester
Replaces: 1347-818619,
1347-818619 1, 1347-818619 1R
(Remanufactured)
Uses Carb Kit **18-7070** & Gasket **18-0356**



**18-7610-1
CARBURETOR**
2 Barrel - Rochester
Replaces: 1347-818621,
1347-818621 1, 1347-818621 1R02
(Remanufactured)
Uses Carb Kit **18-7070** & Gasket **18-0396**



**18-7611-2
CARBURETOR**
2 Barrel - Rochester
Replaces: 3310-807312A1, 3310-807312R02
(Remanufactured)
Uses Carb Kit **18-7097** & Gasket **18-0994**



**18-7613-1
CARBURETOR**
4 Barrel - Carter (Weber)
Replaces: 3310-806969A1, 3310-806969R01
(Remanufactured)
Uses Gasket **18-0467**



**18-7615-1
CARBURETOR**
4 Barrel - Rochester
Replaces: 1347-816373A4,
1347-804624R1, 1347-804624R02
(Remanufactured)
Uses Carb Kit **18-7095** & Gasket **18-2548**

ALL SIERRA CARBURETORS INCLUDE BASE GASKET

 <p>18-7616-1 CARBURETOR 4 Barrel - Rochester Replaces: 1347-8288A1, 1347-804626R02 (Remanufactured) Uses Carb Kit 18-7072 & Gasket 18-2848</p>	 <p>18-7617-1 CARBURETOR 4 Barrel - Rochester Replaces: 1347-9863A3, 1347-804624R1, 1347-804625R02 (Remanufactured) Uses Carb Kit 18-7095 & Gasket 18-2848</p>	 <p>18-7618-1 CARBURETOR 4 Barrel - Rochester Replaces: 1347-8289A1, 1347-804624R1, 1347-804624R02 (Remanufactured) Uses Carb Kit 18-7095 & Gasket 18-2848</p>
 <p>18-7619-1 CARBURETOR 4 Barrel - Rochester Replaces: 1347-9142A2, 1347-8460A3 (Remanufactured) Uses Carb Kit 18-7095 & Gasket 18-0462</p>	 <p>18-79994N CARBURETOR Replaces: 3310-866142A04, 3310-866142A03 Fits: TKS-5.0L</p>	 <p>18-79995N CARBURETOR Replaces: 3310-866143A03 Fits: TKS-5.7L</p>

CARBURETOR APPLICATION

Model	CID/Cyl	Year Range	Beginning Serial #	Ending Serial #	Original Carb Part Number	Carb Code/Model	Carb Repair Kit	Replacement O.E. Carb No.	Float	Sierra Carb #
90	96/L4	1970-1971	2851424	3225967	1351- 4263A 1	7040082 R2/2GC	18-7746	1347-818619R02	18-7200	18-7609-1
90	96/L4	1972	3225868	3226957	1351- 4263A 1	7036543 R2/2GC	18-7746	1347-818619R02	18-7200	18-7609-1
110	153/L4	1963-1966	1357370	2044033	1336-2076	R2/2GC	—	—	—	18-7609-1
120	153/L4	1972-1973	3377341	3770649	1351-4263A3	7043182 R2/2GC	18-7746	1347-818619R02	18-7200	18-7609-1
120	153/L4	1974-1975	3770650	4469865	1351-5202A1	7044182 R2/2GC	18-7746	1347-818619R02	18-7200	18-7609-1
120	153/L4	1976-1978	4469866	5192048	1351-6065A2	7044182 R2/2GC	18-7746	1347-818619R02	18-7200	18-7609-1
120	153/L4	1979-1982	5192049	6229717	1351-7354A1	17059054 R2/2GC	18-7746	1347-818619R02	18-7200	18-7609-1
120	153/L4	1983	6229718	6663797	1351- 8480A 2	17081060 R2/2GC	18-7746	1347-818621R02	18-7200	18-7610-1
120	153/L4	1984	6663798	6853913	1389- 8490A 2	M2/MERCARB	18-7097	3310-860070A 2	18-7202	—
120	153/L4	1985	6853914	A492055	1389- 9350A 2	M2/MERCARB	18-7097	3310-860070A 2	18-7202	—
120	153/L4	1986	A492056	B531853	1389- 9562A 1	M2/MERCARB	18-7098-1	3310-860070A 2	18-7202	—
2.5L	153/L4	1983-1989	B531854	C853255	3310-806077A 2	M2/MERCARB	18-7098-1	3310-860070A 2	18-7202	—
140	181/L4	1968-1969	2508261	2816416	1351- 3635A 1	7036646 R/2GC	18-7746	—	18-7200	—
140	181/L4	1970	2816417	2911439	1351- 4032A 1	7040080 R/2GC	18-7746	1347-818620R02	18-7200	18-7608-1
140	181/L4	1970-1973	2911440	3771644	1351-4293A1	7040084 R/2GC	18-7746	1347-818620R02	18-7200	18-7608-1
140	181/L4	1974-1978	3771645	5157868	1351-5203A1	7043184 R/2GC	18-7746	1347-818620R02	18-7200	18-7608-1
140	181/L4	1979-1982	5157669	6229717	1351-7355A1	17059052 R/2GC	18-7746	1347-818620R02	18-7200	18-7608-1
140	181/L4	1983	6229718	6671328	1351- 8480A 2	17081060 R/2GC	18-7746	1347-818521R02	18-7200	—
140	181/L4	1984	6671329	6852269	1389- 8490A 2	M2/MERCARB	18-7097	3310-860070A 2	18-7202	—
140	181/L4	1985	6852270	A484072	1389- 9350A 2	M2/MERCARB	18-7097	3310-860070A 2	18-7202	—
140	181/L4	1986	A484073	B450800	1389- 9562A 1	M2/MERCARB	18-7098-1	3310-860070A 2	18-7202	—
140/3.0L	181/L4	1983-1989	6229718	C856556	1351-8480A2	R2/2GC	—	1348-818621 1	—	18-7610-1
3.0L	181/L4	1987-1989	B450801	C856556	3310-806077A 2	M2/MERCARB	18-7098-1	3310-860070A 2	18-7202	—
3.0L	181/L4	1990	C856559	D447414	1389-815396A 2	M2/MERCARB	18-7098-1	3310-860070A 2	18-7202	—
3.0L	181/L4	1991-1993	D447415	D836075	1389-806077A 2	M2/MERCARB	18-7098-1	3310-860070A 2	18-7202	—
3.0L	181/L4	1993-1994	D836076	F603999	1389-806078A 1	M2/MERCARB	18-7098-1	3310-860070A 2	18-7202	—
3.0L	181/L4	1998-2002	L010042	M385672	3310-807504A 1	M2/MERCARB	18-7098-1	3310-8M0045397	18-7202	—
3.0L	181/L4	2003-2004	M385673	W301999	3310-864940A01	M2/MERCARB	18-7098-1	3310-8M0045397	18-7202	—
3.0L	181/L4	1999-2004	L382122	W301999	3310-864940A01	M2/MERCARB	18-7098-1	865959A01	18-7202 □	—

- | | | |
|-------------------|-------------------------------------|---------------------------------|
| ① Automatic Choke | ⑥ On-Line | ① Use with in-line transmission |
| ② Black | ⑦ Rear (Blue) | ② Use with V-drive transmission |
| ③ Blue | ⑧ Spacer Mounted | ③ V-drive |
| ④ Electric Choke | ⑨ Use if original carb is MERCARB | ④ Wedge mounted |
| ⑤ Front (Blue) | ⑩ Use if original carb is Rochester | ⑤ TKS Retrofit Kit |

CARBURETOR APPLICATION

Model	CID/Cyl	Year Range	Beginning Serial #	Ending Serial #	Original Carb Part Number	Carb Code/Model	Carb Repair Kit	Replacement O.E. Carb No.	Float	Sierra Carb #
3.0L	181/L4	2004-2010	W302000	& UP	3310-866140A02	M2/MERCcarb	18-7098-1	3310-866140A02	18-7202	—
3.0LX	181/L4	1990-1997	C856559	K999999	1389-815397A 2	M2/MERCcarb	18-7098-1	3310-8M0045397	18-7202	—
3.0LX	181/L4	1990-1997	C856559	K999999	3310-805924A 2	M2/MERCcarb	18-7098-1	3310-8M0045397	18-7202	—
165 (4 CYL)	224/L4	1987	B434941	B774251	1389- 9564A 1	M2/MERCcarb	18-7098-1	3310-860071A 2	18-7202	—
170	224/L4	1985-1989	6916779	B434940	1389- 9564A 1	M2/MERCcarb	18-7098-1	3310-860071A 2	18-7202	—
180	224/L4	1987	B436391	B775248	1347- 9142A 2	17083522 R4/4ME	18-7077	—	18-7201	—
190 (4 CYL)	224/L4	1985-1986	6916779	B436390	1347- 9142A 2	17083522 R4/4ME	18-7077	—	18-7201	—
3.7L	224/L4	1988-1989	B774252	& UP	1389- 9564A 1	M2/MERCcarb	18-7098-1	3310-860071A 2	18-7202	—
3.7LX	224/L4	1988-1989	B775249	& UP	1347- 9142A 2	17083522 R4/4ME	18-7077	—	18-7201	—
470	224/L4	1976-1984	4208730	6916778	1376- 5990A 1	17057132 R2/2GC	18-7076	3310-860071A 4	18-7202 ⑩	—
470	224/L4	1983-1984	6218037	6916778	1389- 8489A 5	M2/MERCcarb	18-7097	3310-860071A 2	18-7202 ⑨	—
485	224/L4	1980-1982	5685394	6218036	1376- 5990A 1	17057132 R2/2GC	18-7076	3310-860071A 4	18-7202	—
488	224/L4	1983-1984	6170297	6916778	1347- 8460A 3	17081299 R4/4ME	18-7077	—	18-7201	18-7619-1
150	230/L6	1964-1966	1830152	2048046	1338- 2633	8025188 R2/2GC	18-7746	—	18-7200	—
160	250/L6	1967-1968	2048022	2492038	1338- 2991	7026088 R2/2GC	18-7746	—	18-7200	—
160	250/L6	1969	2492036	277031	1351- 3635A 1	7036646 R/2GC	18-7746	—	18-7200	—
165 (6 CYL)	250/L6	1970-1972	3774865	3354791	1351-4282A1	7043183 R2/2GC	18-7746	1347-818620R02	18-7200	18-7608-1
165 (6 Cyl)	250/L6	1979-1981	5178959	5813433	1351-7356A1	17059050 R2/2GC	18-7746	1347-818620R02	18-7200	18-7608-1
165 (6 Cyl)	L6	1972-1973	3354702	3774864	1351-4871A1	R2/2GC	—	1347-818620 1	—	18-7608-1
180/190 3.7L,					—	R4/4ME	—	1347-8460	—	18-7619-1
L4 Engine	—	1985-1989	6916779	Later	1347-9142A2	R4/4ME	—	—	—	18-7619-1
200 (6 CYL)	292/L6	1969	2453769	2494935	1347- 3237A 4	7037082 R4/4MV	18-7077	—	18-7201	—
185 (4bbl)	229/V-6	1993-1994	6330183	6919655	3300- 8886A 2	17083515 R4/4ME	18-7077	—	18-7201	—
175	262/V-6	1987	B527955	B773242	3304- 9565A 1	M2/MERCcarb	18-7098-1	3310-807764A 1	18-7202	—
185	262/V-6	1985-1986	A331455	B527954	3304- 9353A 2	M2/MERCcarb	18-7097	3310-807764A 1	18-7202	—
205	262/V-6	1985-1987	A331455	B775129	3304-9354A2	17084516 R4/4MV	18-7077	—	18-7201	18-7605-1
4.3L	262/V-6	1988-1992	B773243	D714106	3304- 9565A 1	M2/MERCcarb	18-7098-1	3310-807764A 1	18-7202	—
4.3L	262/V-6	1992-1993	D714107	F000877	3304- 9565A 1	M2/MERCcarb	18-7098-1	3310-807764A 1	18-7202	—
4.3L	262/V-6	1993-1995	F000878	F601126	3310-806972A 1	M2/MERCcarb	18-7098-1	3310-807764A 1	18-7202	—
4.3L	262/V-6	1996-2002	F601127	M614999	3310-807764A 1	M2/MERCcarb	18-7098-1	3310-807764A 1	18-7202	—
4.3L	262/V-6	2002-2004	M615000	W300012	3310-864941A01	M2/MERCcarb	18-7098-1	3310-864941A01	18-7202	—
4.3L	262/V-6	2000-2004	L619000	W300012	3310-864941A01	M2/MERCcarb	18-7098-1	865960A02	18-7202 ⑤	—
4.3L	262/V-6	2004- 2010	W300013	& UP	3310-866141A02	M2/MERCcarb	18-7098-1	3310-866141A02	18-7202	—
4.3LH	262/V-6	1998-2002	L010044	M614999	3310-807826A 1	9666 WEBER	18-7749	—	—	—
4.3LX	262/V-6	1988-1991	B775130	D714369	3304- 9354A 2	17084516 R4/4MV	18-7077	1347-804623R02	18-7201	18-7605-1
4.3LX	262/V-6	1992-1996	D714370	F802999	3310-818660A 1	9600 WEBER	18-7749	—	—	—
4.3XH	262/V-6	1996-1997	F803114	K999999	3310-807826A 1	9666 WEBER	18-7749	—	—	—
215 MCM/MIE (FORD)	302/V-8	1970-1972	2781153	3385720	1356- 4066	C9FF9510E H4/4160	18-7096	1356-804628R02	18-7206	—
225 MCM/MIE (FORD)	302/V-8	1973-1974	3385721	4166999	1356- 5155	D2JL9510C H4/4160	18-7096	1356-804628R02	18-7206	—
888	302/V-8	1971-1977	3108723	4887829	1376-5659A1	7044185 R2/2GC	18-7075	1376-818622R02	18-7202 ⑩	18-7603-1
888	302/V-8	1971-1977	3108723	4887829	1356- 4642	D1JJ95108 H2/2300	18-7081	—	—	—
198 MIE	305/V-8	1977	4776402	4931099	1376- 6491A 1	17057139 R2/2GC	18-7075	3310-861080A 1	18-7202	—
200	305/V-8	1985-1986	6899058	A482026	1389- 8488A 2	M2/MERCcarb	18-7097	3310-861080A 1	18-7202	—
200	305/V-8	1985-1987	A482027	B525981	1389- 9563A 1	M2/MERCcarb	18-7098-1	3310-861080A 1	18-7202	—
200	305/V-8	1987	B525982	B774444	1389- 9670A 2	M2/MERCcarb	18-7098-1	3310-807312A1	18-7202	—
228	305/V-8	1977-1978	4765100	5069430	1347-6427A1	17057282 R4/4MV	18-7077	9661A 3	18-7201	18-7605-1
228	305/V-8	1978-1981	5069431	6021783	1347-7361A1	17059292 R4/4MV	18-7077	9661A 3	18-7201	18-7605-1
228	305/V-8	1982	6021784	6218461	1347-8296A4	17080565 R4/4MV	18-7077	9661A 3	18-7201	18-7605-1
228	305/V-8	1982-1984	6218462	6899268	1347- 9661A 3	17080565 R4/4MV	18-7077	9661A 3	18-7201	18-7605-1
228 MIE	305/V-8	1977-1978	4765100	5069430	1347-6438A1	17057283 R4/4MV	18-7077	9661A 3	18-7201	18-7605-1
228 MIE	305/V-8	1978-1982	5069431	6040745	1347-7364A1	17059291 R4/4MV	18-7077	9661A 3	18-7201	18-7605-1
228 TR	305/V-8	1977-1978	4765100	5069430	1347- 6438A 1	17057283 R4/4MV	18-7077	9661A 3	18-7201	18-7605-1

- ① Automatic Choke
- ② Black
- ③ Blue
- ④ Electric Choke
- ⑤ Front (Blue)

- ⑥ On-Line
- ⑦ Rear (Blue)
- ⑧ Spacer Mounted
- ⑨ Use if original carb is MERCarb
- ⑩ Use if original carb is Rochester

- ⑪ Use with in-line transmission
- ⑫ Use with V-drive transmission
- ⑬ V-drive
- ⑭ Wedge mounted
- ⑮ TKS Retrofit Kit

CARBURETOR APPLICATION

Model	CID/Cyl	Year Range	Beginning Serial #	Ending Serial #	Original Carb Part Number	Carb Code/Model	Carb Repair Kit	Replacement O.E. Carb No.	Float	Sierra Carb #
230	305/V-8	1985-1987	6899269	B773739	1347-9661A 3	17080565 R4/4MV	18-7077	9661A 3	18-7201	18-7605-1
230 MIE	305/V-8	1982-1987	6040746	B788151	1347-8290A1	17080564 R4/4MV	18-7077	9661A 3	18-7201	18-7605-1
223/230/5.0LX	V-8	1983-1995	6218462	F600999	1347-9661A3	R4/4MV	—	1347-9661A3	—	18-7605-1
5.0L	305/V-8	1988-1995	B774445	F600999	1389-9670A 2	M2/MERCARB	18-7098-1	3310-807312A1	18-7202	—
5.0L (GEN +)	305/V-8	1998-2002	L015751	M599999	3310-861448A 1	M2/MERCARB	18-7098-1	3310-864942A01	18-7202	—
5.0L (GEN +)	305/V-8	2002-2004	M600000	W300009	3310-864942A01	M2/MERCARB	18-7098-1	3310-864942A01	18-7202	—
5.0L (GEN +)	305/V-8	2000-2004	L619000	W300009	3310-864942A01	M2/MERCARB	18-7098-1	865961A02	18-7202 ⑤	—
5.0L (GEN +)	305/V-8	2004-2010	W300010	& UP	3310-866142A03	M2/MERCARB	18-7098-1	3310-866142A04	18-7202	—
5.0LX	305/V-8	1988-1995	B773740	F600999	1347-9661A 3	17080565 R4/4MV	18-7077	9661A 3	18-7201	18-7605-1
898/200/5.0L	V-8	1987-95	B525982	F600999	1389-9670A2	M2/MERCARB	—	3310-807312A1	—	18-7611-1
898	305/V-8	1977	4762210	6021383	1376-6491A 1	17057139 R2/2GC	18-7075	3310-861080A 1	18-7202	—
898	305/V-8	1982	6021384	6218461	1376-8295A 3	17080350 R2/2GC	18-7075	3310-861080A 1	18-7202	—
898	305/V-8	1983-1984	6218462	6899057	1389-8488A 2	M2/MERCARB	18-7097	3310-861080A 1	18-7202	—
225 MCM/MIE (GM)	327/V-8	1963-1969	1539620	2694014	1347-3237A 3 ①	7037082 R4/4MV	—	1347-804624R02	—	18-7615N
250	350/V-8	1977	4768000	4908849	1347-3353 ①	7037082 R4/4MV	—	1347-804624R02	—	18-7615N
250	350/V-8	1977	4768000	4908849	1347-3237A 3 ①	7037082 R4/4MV	—	1347-804624R02	—	18-7615N
255	350/V-8	1975-1976	4175550	4767999	1347-5732A 1	7044291 R4/4MV	18-7077	1347-804624R02	18-7201	18-7615N
255 MIE (GM)	350/V-8	1975-1978	4175550	4924564	1347-5732A 1	7044291 R4/4MV	18-7077	1347-804624R02	18-7201	18-7615N
255 MIE (GM)	350/V-8	1978	4924565	5195908	1347-7062A1	17057292 R4/4MV	18-7077	1347-804624R02	18-7201	18-7615N
255 MIE (GM)	350/V-8	1979-1980	5195909	5907057	1347-7365A1	17059289 R4/4MV	18-7077	1347-804624R02	18-7201	18-7615N
260 MIE	V-8	1980-1986	5907058	B522505	1347-8289A1	R4/4MV	—	1347-8289A1	—	18-7618-1
260	350/V-8	1978	4908850	5060805	1347-6492A 1	17057298 R4/4MV	18-7077	1347-804624R02	18-7201	18-7615N
260	350/V-8	1976-1982	5060806	6024393	1347-7362A 1	17059288 R4/4MV	18-7077	1347-804624R02	18-7201	18-7615N
260	350/V-8	1982-1987	6024393	B525981	1347-8292A 4	17080561 R4/4MV	18-7077	1347-804624R02	18-7201	18-7615N
260	350/V-8	1987	B525982	B773304	1347-9662A 1	17080561 R4/4MV	18-7077	1347-804624R02	18-7201	18-7615N
260 MIE	350/V-8	1981-1987	5907058	B522505	1347-8289A 1	17080562 R4/4MV	18-7077	1347-804624R02	18-7201	18-7615N
260 MIE	350/V-8	1987	B522506	B788151	1347-9662A 1	17080561 R4/4MV	18-7077	1347-804624R02	18-7201	18-7615N
260/5.7MIE	V-8	1987-1993	B522506	F024999	1347-9664A	R4/4MV	—	1347-816373A4	—	18-7615N
260/5.7L ALPHA	V-8	1987-1993	B525982	F000454	1347-9662A4	R4/4MV	—	1347-816373A4	—	18-7615N
270 MCM/MIE	350/V-8	1969-1972	2851074	3385720	1347-4180A 1	7029285 R4/4MV	18-7077	—	18-7201	—
280 TRS	350/V-8	1975	4176250	4176468	1347-4179A 2	7040283 R4/4MV	18-7077	—	18-7201	—
280 TRS	350/V-8	1975-1976	4176469	4770199	1347-5981A 1	7044290 R4/4MV	18-7077	—	18-7201	—
300 MR/TRS	350/V-8	1985-1986	6668677	B430367	1347-7498A 7	17059280 R4/4MV	18-7077	—	18-7201	18-7615N
350 MAG ALPHA	350/V-8	1986-1991	A635178	D617327	1347-8289A 1	17080562 R4/4MV	18-7077	1347-804624R02	18-7201	18-7615N
350 MAG ALPHA	350/V-8	1992-1995	D617328	F600999	3310-806970A 1	9770SA WEBER	18-7749	3310-807262A 1	—	—
350 MAG ALPHA	350/V-8	1996-1997	F601000	K999999	3310-807262A 2	9781 WEBER	18-7748	—	—	—
350 MAG SKI	350/V-8	1991-1996	D505450	K040399	3310-806970A 1 ②	9770SA WEBER	18-7749	—	— ①	—
350 MAG SKI	350/V-8	1991-1997	D505450	K999999	3310-807262A 2 ②	9781 WEBER	18-7748	—	— ①	—
350 MAG SKI	350/V-8	1997	K040400	K999999	3310-860371A 1 ②	9781SB WEBER	18-7748	—	— ②	—
5.7L (2BBL)	350/V-8	1996-1997	F601000	K999999	3310-807312A1	M2/MERCARB	18-7098-1	3310-807312A1	18-7202	18-7611-2
5.7L (GEN +) (2bbl)	350/V-8	1998-2002	L010037	M599999	3310-861245A 1	M2/MERCARB	18-7098-1	3310-864943A01	18-7202	18-7639
5.7L (GEN +) (2bbl)	350/V-8	2002-2004	M600000	W300754	3310-864943A01	M2/MERCARB	18-7098-1	3310-864943A01	18-7202	18-7639
5.7L (GEN +) (2bbl)	350/V-8	2000-2004	L015751	W300754	3310-864943A01	M2/MERCARB	18-7098-1	865962A02	18-7202 ⑤	—
5.7L (Gen II)	V-8	1998-2004	L010037	W300754	3310-864943101	M2/MERCARB	—	3310-864943101	—	18-7639
5.7L (GEN +) (2bbl)	350/V-8	2004-2010	W300755	& UP	3310-866143A03	M2/MERCARB	18-7098-1	3310-866143A03	18-7202	—
5.7L ALPHA	350/V-8	1988-1993	B773305	F000454	1347-9662A 4	17080561 R4/4MV	18-7077	1347-804624R02	18-7201	18-7615N
5.7L ALPHA	350/V-8	1993-1994	F000455	F273497	3310-805484A 1	9661 WEBER	18-7749	—	—	—
5.7L ALPHA	350/V-8	1993-1994	F000455	F273497	3310-806761A 1	9665S WEBER	18-7748	—	—	—
5.7L ALPHA	350/V-8	1994-1995	F273498	F600999	3310-806761A 3	9665S WEBER	18-7748	3310-806761A 3	—	—
5.7L BRAVO	350/V-8	1988-1991	B773305	D617327	1347-9662A 4	17080561 R4/4MV	18-7077	1347-804624R02	18-7201	18-7615N
(W/O HIGH RISE INTAKE)										
5.7L BRAVO	350/V-8	1988-1991	B773305	D617327	1347-8289A 1	17080562 R4/4MV	18-7077	1347-804624R02	18-7201	18-7615N
(W/HIGH RISE INTAKE)										

- ① Automatic Choke
- ② Black
- ③ Blue
- ④ Electric Choke
- ⑤ Front (Blue)

- ⑥ On-Line
- ⑦ Rear (Blue)
- ⑧ Spacer Mounted
- ⑨ Use if original carb is MERCARB
- ⑩ Use if original carb is Rochester

- ① Use with in-line transmission
- ② Use with V-drive transmission
- ③ V-drive
- ④ Wedge mounted
- ⑤ TKS Retrofit Kit

CARBURETOR APPLICATION

Model	CID/Cyl	Year Range	Beginning Serial #	Ending Serial #	Original Carb Part Number	Carb Code/Model	Carb Repair Kit	Replacement O.E. Carb No.	Float	Sierra Carb #
5.7L BRAVO	V-8	1987-1991	OB525982	OD617327	1347-9662A4	R4/4MV	—	1347-816373A4	—	18-7615N
W/O HIGH RISE INTAKE										
5.7L BRAVO	V-8	1987-1991	OB525982	OD617327	1347-8289A1	R4/4MV	—	1347-8289A1	—	18-7618-1
W/HIGH RISE INTAKE										
5.7L BRAVO	350/V-8	1992-1995	D617328	F600999	3310-806970A 1	9770SA WEBER	18-7749	3310-807262A 1	—	—
5.7L MIE	350/V-8	1988-1992	B768152	D715493	1347-9662A 4	17080561 R4/4MV	18-7077	1347-804624R02	18-7201	18-7615N
5.7L MIE	350/V-8	1992-1994	D715494	F349999	3310-806761A 2 □	9665S WEBER	18-7748	3310-806761A 2	—	—
5.7L MIE	350/V-8	1995	F349300	F622099	3310-806761A 3	9665S WEBER	18-7748	3310-806761A 3	—	—
5.7L MIE (2bb)	350/V-8	1998-2002	L002003	M316999	3310-861245A 1	M2/MERCARB	18-7098-1	3310-864943A01	18-7202	18-7639
5.7L MIE (2bb)	350/V-8	2002-2004	M317000	W090899	3310-864943A01	M2/MERCARB	18-7098-1	3310-864943A01	18-7202	18-7639
5.7L MIE (2bb)	350/V-8	2000-2004	L390600	W090899	3310-864943A01	M2/MERCARB	18-7098-1	865962A02	18-7202 ⑤	—
5.7L MIE (2bb)	350/V-8	2004-2010	W090900	& UP	3310-866143A03	M2/MERCARB	18-7098-1	3310-866143A03	18-7202	—
5.7L SKI	350/V-8	1985-1987	A338553	B514626	1347-9415T	17085013 R4/4MV	18-7077	9415T	18-7201	—
5.7L SKI	V-8	1985-1993	A338533	F025099	1347-9415T	R4/4MV	—	1347-9415T	—	18-7615N
5.7L SKI	350/V-8	1987-1995	F450000	F775199	3310-805484A 1	9661 WEBER	18-7749	3310-806761A 3	—	—
5.7L SKI (2bb)	350/V-8	1996-1997	F775200	K999999	3310-807312A1	M2/MERCARB	18-7098-1	3310-807312A1	18-7202	18-7611-2
5.7L SKI (GEN +) (2bb)	350/V-8	1998-2002	L002005	M316999	3310-861245A 1	M2/MERCARB	18-7098-1	3310-864943A01	—	18-7639
5.7L SKI (GEN +) (2bb)	350/V-8	2002-2004	M317000	W090899	3310-864943A01	M2/MERCARB	18-7098-1	3310-864943A01	—	18-7639
5.7L SKI (GEN +) (2bb)	350/V-8	2000-2004	L390600	W090899	3310-864943A01	M2/MERCARB	18-7098-1	865962A02	18-7202 ⑤	18-7618-1
5.7L SKI (GEN +) (2bb)	350/V-8	2004-2010	W090900	& UP	3310-866143A03	M2/MERCARB	18-7098-1	3310-866143A03	18-7202	—
5.7LX (4bb)	350/V-8	1996-1997	F601000	K999999	3310-807262A 2	9761 WEBER	18-7748	—	—	—
233 MCM & MCI (FORD)	351/V-8	1975-1977	4173000	4465029	1376-5744 1	7044187 R2/2GC	18-7075	1347-818622R02	—	18-7603-1
233 MCM & MCI (FORD)	351/V-8	1975-1977	4465030	4902304	1376-6152A 1	17056197 R2/2GC	18-7075	1347-818622R02	—	18-7603-1
325 MCM/MIE	427/V-8	1969-1970	2278747	3042730	1347-3342 □	7027080 R4/4MV	18-7077	—	18-7201	—
325 MCM/MIE	427/V-8	1971-1972	3042731	3780449	1347-4533A 1 □	7041831 R4/4MV	18-7077	—	18-7201	—
325 MCM/MIE	427/V-8	1969-1972	2278747	3780449	1347-3689A 1 □	7029280 R4/4MV	18-7077	—	18-7201	—
330 MCM	427/V-8	1977-1978	4623115	5027230	1347-6493A1	17057287 R4/4MV	18-7077	1347-804626R02	18-7201	18-7616-1
330 MCM	427/V-8	1977-1981	5027231	6083144	1347-7363A1	17059290 R4/4MV	18-7077	1347-804626R02	18-7201	18-7616-1
330 MCM	427/V-8	1982-1987	6083145	B816540	1347-8291A3	17080563 R4/4MV	18-7077	1347-804626R02	18-7201	18-7616-1
330 MIE	427/V-8	1977-1978	4623115	5226384	1347-6493A1	17057287 R4/4MV	18-7077	1347-804626R02	18-7201	18-7616-1
330 MIE	427/V-8	1979-1980	5226385	5889913	1347-7366A1	17059287 R4/4MV	18-7077	1347-804626R02	18-7201	18-7616-1
340 MIE	454/V-8	1981-1987	5889914	D788365	1347-8288A1	17080560 R4/4MV	18-7077	1347-804626R02	18-7201	18-7616-1
370	454/V-8	1978-1987	4179554	B714586	1347-7498A 2	17059280 R4/4MV	18-7077	1347-804625R02	18-7201	—
400	454/V-8	1980-1986	4179554	B457644	1347-7498A 2	17059280 R4/4MV	18-7077	1347-804625R02	18-7201	—
420	454/V-8	1987-1989	A398941	B622418	13549A 4	H4	18-7751	—	—	—
425	454/V-8	1990-1993	B622419	D937011	13549A 4	H4	18-7751	—	—	—
440	454/V-8	1983-1986	4179554	B485220	1393-8862A 1	H4	18-7751	—	—	—
450	454/V-8	1995-1996	F347100	F347277	13549A14	H4	18-7751	—	—	—
454 MAG ALPHA	454/V-8	1986-1988	A631894	B785148	1347-8291A3	17080563 R4/4MV	18-7077	1347-804626R02	18-7201	18-7616-1
454 MAG BRAVO	454/V-8	1988-1992	B721206	D808068	1347-7498A2	17059280 R4/4MV	18-7077	1347-804625R02	18-7201	18-7617-1
454 MAG BRAVO	454/V-8	1992-1994	D805069	F304999	3310-806755A 1	9779 WEBER	18-7748	—	—	—
454 MAG BRAVO	454/V-8	1995-1997	F305000	K999999	3310-806755A 2	9779 WEBER	18-7748	—	—	—
7.4L BRAVO I/II	454/V-8	1988-1991	B771113	D603117	1347-8291A3	17080563 R4/4MV	18-7077	1347-804626R02	18-7201	18-7616-1
7.4L BRAVO I/II	454/V-8	1992-1994	D603118	F351999	3310-806969A 2	9780 WEBER	18-7748	—	—	—
7.4L BRAVO I/II	454/V-8	1995-1997	F352000	K999999	3310-806969A1	9780 WEBER	18-7748	3310-806969A 1	—	18-7613-1
7.4L BRAVO III	454/V-8	1993-1996	D838819	F800699	3310-806755A 2	9779 WEBER	18-7748	—	—	—
7.4L BRAVO III	454/V-8	1996-1997	F800700	K999999	3310-806969A1	9780 WEBER	18-7748	3310-806969A 1	—	18-7613-1
7.4L MIE	454/V-8	1988-1992	5889914	D715493	1347-8268A 1	17080560 R4/4MV	18-7077	1347-804626R02	18-7201	18-7616-1
460	482/V-8	1983-1986	4179554	B485220	1393-8862A 1	H4	18-7751	—	—	—
465	502/V-8	1990-1992	C849992	F213244	—	H4	18-7751	—	—	—
465	502/V-8	1990-1992	C849992	F213244	—	H4	18-7751	—	—	—
500	502/V-8	1994-1995	F213293	F615766	13549A12	H4	18-7751	—	—	—

- ① Automatic Choke
- ② Black
- ③ Blue
- ④ Electric Choke
- ⑤ Front (Blue)

- ⑥ On-Line
- ⑦ Rear (Blue)
- ⑧ Spacer Mounted
- ⑨ Use if original carb is MERCARB
- ⑩ Use if original carb is Rochester

- ⑪ Use with in-line transmission
- ⑫ Use with V-drive transmission
- ⑬ V-drive
- ⑭ Wedge mounted
- ⑮ TKS Retrofit Kit

CARBURETOR APPLICATION

Model	CID/Cyl	Year Range	Beginning Serial #	Ending Serial #	Original Carb Part Number	Carb Code/Model	Carb Repair Kit	Replacement O.E. Carb No.	Float	Sierra Carb #
500	502/V-8	1996-1998	F615767	L001772	13549A 15	H4	18-7751	—	— ^②	—
500 (GEN +)	502/V-8	1999	L414639	L601036	13549T21	H4	18-7751	—	— ^②	—
502 MAG	502/V-8	1990-1992	C878221	D824588	1347-814623A 2	17089112 R4/4MV	18-7077	—	18-7201	—
502 MAG	502/V-8	1992-1993	D824589	F114528	3310-806971A 1	9782 WEBER	18-7748	—	—	—
8.2L MIE	502/V-8	1990-1992	C878221	D857199	1347-814623A 2	17089113 R4/4MV	18-7077	—	—	—
8.2L MIE	502/V-8	1990-1992	C878221	D857199	3310-817693A 1	9774 WEBER	18-7748	—	—	—
8.2L MIE	502/V-8	1993-1996	D857200	F819619	3310-806971A 1	9782 WEBER	18-7748	—	—	—
500 BULLDOG	540/V-8	1990-1995	C577254	F348987	13549A10	H4	18-7751	—	— ^②	—
500 BULLDOG	540/V-8	1995-2001	F615762	M050281	13549A23	H4	18-7751	—	— ^②	—

- | | | |
|-------------------|-------------------------------------|---------------------------------|
| ① Automatic Choke | ⑥ On-Line | ① Use with in-line transmission |
| ② Black | ⑦ Rear (Blue) | ② Use with V-drive transmission |
| ③ Blue | ⑧ Spacer Mounted | ③ V-drive |
| ④ Electric Choke | ⑨ Use if original carb is MERCarb | ④ Wedge mounted |
| ⑤ Front (Blue) | ⑩ Use if original carb is Rochester | ⑤ TKS Retrofit Kit |



**18-8114
FUEL LINE HOSE**

For fuel pump to carburetor connection. Replaces copper or steel tubing 3/8" X 31" PTFE composite hose with 5/8"-18 male inverted flare straight one end, 5/8"-18 90° one end. SAE J1527 type A1



**18-8115
FUEL LINE HOSE**

For fuel pump to carburetor connection. Replaces copper or steel tubing 3/8" X 25" PTFE composite hose with 5/8"-18 male inverted flare straight one end, 5/8"-18 90° one end. SAE J1527 type A1



**18-7751
CARB KIT**

Replaces: 13220
Fits: GM 420 V8 454 (1987-89), GM 425 V8 454 (1990-93), GM 425 (Gen V) V8 454 (1992-93), 440 TRS GM 454 (1983-86), GM 450 V8 454(1995-96), 460 TRS V8 482 (1983-86), GM 465 V8 502 (1990-92), GM 465 (Gen V) V8 502 (1992-94), 500 (Gen+) GM 502 V8 (1999), 500 (Gen V) 502 V8 (1994-98), 500 Bulldog 540 V8 (1990-01)



**18-7071
CARB KIT**

Replaces: 1397-3458



**18-7075
CARB KIT**

Replaces: 1397-5830, 1397-7099, 1397-8760, 1397-5831



**18-7070
CARB KIT**

Replaces: 1397-2072, 1397-7542, 1397-2637, 1397-7543, 1397-8872, 1397-3464



18-7072
CARB KIT
 Replaces: 1397-3306, 1397-4329,
 1397-5635, 1397-6638, 823426A1

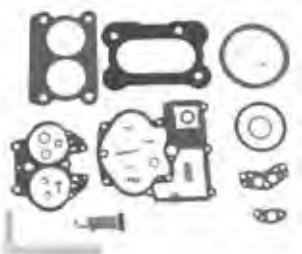

18-7076
CARB KIT
 Replaces: 1397-6367, A1



18-7077
CARB KIT
 Replaces: 1397-8952, 823426A1

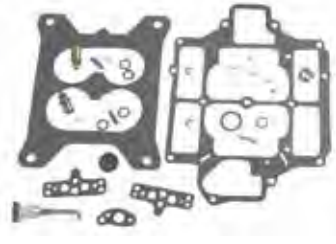

18-7078
CARB KIT
 Replaces: 1397-2605, 1397-3462, 1397-2133
 Fits: 1337-2604, 1337-2103



18-7080
CARB KIT
 Replaces: 1398-3089
 Fits: 1346-2770



18-7081
CARB KIT
 Replaces: 1396-4656
 Contains adjustable needles and seats

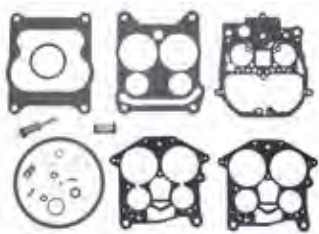

18-7095
CARB KIT
 Replaces: 1397-7539, 1397-7540, 1397-7544,
 1397-8535, 1397-9723



18-7096
CARB KIT
 Replaces: 1396-5238, 1396-5222, 1356-4092
 Fits: 1356-5169, 1356-5155, 1356-4066
 Contains adjustable needles and seats



18-7097
CARB KIT
 Replaces: 3302-9437, 3302-804845
 MerCarb 2 bbl. bottom fill accelerator pump 1983-1986
 MCM 120, 140, 470, 185, 200, 898



18-7098-1
CARB KIT
 Replaces: 3302-804844002,
 3302-804844001, 3302-804844
 MerCarb 2 bbl. side fill accelerator pump
 1986 and UP MCM 4-cyl., V6 & V8



18-7728
CARB KIT

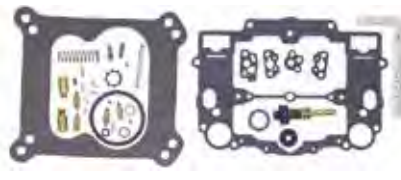

18-7749
CARB KIT
 Replaces: 809065, 835076, 823728



18-7748
CARB KIT
 Replaces: 809064

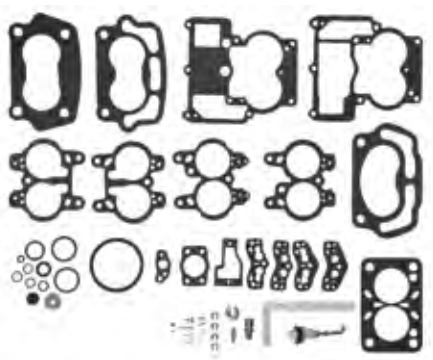

18-7746
CARB KIT
 Replaces: 823427A1, 1397-8873, 1397-8872,
 1397-7547, 1397-7543, 1397-7542, 1397-3464,
 1397-3459, 1397-2637, 1397-2634, 1397-2631,
 1397-2067
 Repair Kit for 2 BBL Rochester

 <p>18-7200 FLOAT Replaces: 1397-2060 (Alcohol Resistant) Plastic</p>	 <p>18-7201 FLOAT Replaces: 1397-3327, 1397-8546, 1397-8959 (Alcohol Resistant) Brass</p>	 <p>18-7202 FLOAT Replaces: 1397-5837, 3302-9031 (Alcohol Resistant) Brass</p>
 <p>18-36906 CARB FLOAT Replaces: 811536, 811536T Fits: Mercruiser w/ 4 bbl Weber Carb</p>	 <p>18-7666 CHOKE PULL-OFF Replaces: 1397-8582 Rochester 4V carburetors</p>	 <p>18-7664 CHOKE THERMOSTAT Replaces: 809066 Weber 4V Carburetors with electric choke</p>
 <p>18-7665 CHOKE THERMOSTAT Replaces: 70125A1, 70125A02, 70125 Rochester & Mercarb 2V with electric choke</p>	 <p>18-7667 CHOKE THERMOSTAT Replaces: 71464A01, 71464, 72625 Rochester Carburetors with divorced choke</p>	 <p>18-7227 CHOKE THERMOSTAT Replaces: 1396-4148 For: Holley Carburetor</p>

CARBURETOR KIT/FLOAT APPLICATION

Model & Serial #	Mercruiser Carb #	Mfg. Carb #	Carb. Code & Model	Carb Kit ①	Float
MCM 80 ALL	1346-2770	RBS-4394S	C1/RBS	18-7080	—
MCM 90					
3225967 & BELOW	1351-4263A1	7040082	R2/2GC	18-7746	18-7200
3225968 & ABOVE	1351-4263A2	7041369	R2/2GC	18-7746	18-7200
MCM110 ALL	1336-2076	7036543	R2/2GC	18-7070	18-7200
MCM 120/2.5L					
2520424 & BELOW	1336-2076	7036543	R2/2GC	18-7746	18-7200
2520425-3377340	1336-3594A1	7036543	R2/2GC	18-7746	18-7200
3377341-3770649	1351-4263A3	7041369	R2/2GC	18-7746	18-7200
3770650-4469865	1351-5202A1	7043182	R2/2GC	18-7746	18-7200
4469866-5192047	1351-6065A2	7044182	R2/2GC	18-7746	18-7200
5192048-6229717	1351-7354A1	17059054	R2/2GC	18-7746	18-7200
6229718 & ABOVE	1351-8480A2	17081060	R2/2GC	18-7746	18-7200
6229718 & ABOVE	1389-8490A2	N/A	M2/Mercarb	18-7097	18-7202
6229718 & ABOVE	1389-9350A2	N/A	M2/Mercarb	18-7097	18-7202
6229718 & ABOVE	1389-9562A1	N/A	M2/Mercarb	18-7098-1	18-7202
MCM 140 /3.0L/3.0LX(4 cyl.)					
2816416 & BELOW	1351-3635A1	7036646	R2/2GC	18-7746	18-7200
2816417-3332137	1351-4032A1	7040080	R2/2GC	18-7746	18-7200
3332138-3771644	1351-4293A1	7040084	R2/2GC	18-7746	18-7200
3771645-5157668	1351-5203A1	7043184	R2/2GC	18-7746	18-7200
5157669-6229717	1351-7355A1	17059052	R2/2GC	18-7746	18-7200
6229718-C856558	1351-8480A2	17081060	R2/2GC	18-7746	18-7200
6229718-C856558	1389-8490A2	N/A	M2/Mercarb	18-7097	18-7202
6229718-C856558	1389-9350A2	N/A	M2/Mercarb	18-7097	18-7202
6229718-C856558	1389-9562A1	N/A	M2/Mercarb	18-7098-1	18-7202
C856559 & ABOVE	1389-815396A2	N/A	M2/Mercarb	18-7098-1	18-7202
C856559 & ABOVE	1389-815397A2	N/A	M2/Mercarb	18-7098-1	18-7202
MCM 140 (6 cyl)					
ALL (BC)	1338-2161	7025638	R1/BC	18-7071	—

① Does not include metering rods

CARBURETOR KIT/FLOAT APPLICATION (Cont.)

Model & Serial #	Mercruiser Carb #	Mfg. Carb #	Carb. Code & Model	Carb Kit ①	Float
ALL (B)	1338-2166	7025662	R1/B	18-7071	—
MCM 150					
1823489 & BELOW	1338-2428	7024180	R1/BC	18-7071	—
1823489 & BELOW	1338-2431	7024181	R1/B	18-7071	—
1823490-1830151	1338-2608	7025183	R1/BC	18-7071	—
1823490-1830151	1338-2609	7025184	R1/B	18-7071	—
1830152 & ABOVE	1338-2633	7025188	R2/2GC	18-7070	18-7200
MCM 160					
2492035 & BELOW	1338-2991	7026088	R2/2GC	18-7746	18-7200
2492036 & ABOVE	1351-3635A1	7036646	R2/2GC	18-7746	18-7200
MCM 165 (6 cyl)					
3354701 & BELOW	1351-4282A1	7040083	R2/2GC	18-7746	18-7200
3354702-3774864	1351-4871A1	7042183	R2/2GC	18-7746	18-7200
3774865-5178958	1351-5204A1	7043183	R2/2GC	18-7746	18-7200
5178959 & ABOVE	1351-7356A1	17059050	R2/2GC	18-7746	18-7200
MCM 165/170/3.7L (4 cyl)					
6218037-6916778	1389-8489A5	N/A	M2/Mercarb	18-7097	18-7202
6916779 & ABOVE	1389-9564A1	N/A	M2/Mercarb	18-7098-1	18-7202
MCM 175/4.3L/185 (V-6)	3304-9565A1	N/A	M2/Mercarb	18-7098-1	18-7202
(229 CID) ALL					
A221455-D714106	3300-8886A2	17083515	R4/4MV	18-7095	18-7201
185 (262 CID)					
A221455-B527954	3304-9353A2	N/A	M2/Mercarb	18-7097	18-7202
MCM 205 (262 CID)	3304-9354A2	—	R4/4MV	18-7095	18-7201
A331455-D714369	3304-9565A1	N/A	M2/Mercarb	18-7098-1	18-7202
MCM/MIE 470 ALL	1376-5990A1	17057132	R2/2GC	18-7076	18-7202
MCM 485 ALL	1376-5990A1	17057132	R2/2GC	18-7076	18-7202
MCM 488 ALL	1347-8460A3	17081299	R4/4ME	18-7077	18-7201
MCM 888					
ALL HOLLEY	1356-4642	D1JJ-9510-8	H2/2300	18-7081	18-7206
ALL ROCHESTER	1376-5659A1	7044185	R2/2GC	18-7075	18-7202
MCM 180/190/3.7LX					
(4 cyl)	1347-9142A2	17083522	R4/4MV	18-7095	18-7201
MIE 198/200/5.0L					
6021383 & BELOW	1376-6491A1	17057139	R2/2GV	18-7075	18-7202
6021384 & ABOVE	1376-8295A3	17080350	R2/2GV	18-7075	18-7202
MCM 200 (6 cyl)					
2494935 & BELOW	1347-3237A2	7037082	R4/4MV	18-7072	18-7201
2494936 & ABOVE	1347-3237A4	7037082	R4/4MV	18-7072	18-7201
MCM 898/200/5.0L					
6218462 & ABOVE	1389-8488A2	N/A	M2/Mercarb	18-7097	18-7202
6218462 & ABOVE	1389-9563A1	N/A	M2/Mercarb	18-7098-1	18-7202
6218462 & ABOVE	1389-9670A2	N/A	M2/Mercarb	18-7098-1	18-7202
MCM 205/4.3LX (V-6 262 CID)					
A331455-D714369	3304-9354A2	17084516	R4/4MV	18-7095	18-7201
MCM/MIE 215 ALL	1356-4066	C9FF-9510-E	H4/4160	18-7096	18-7206
MCM/MIE 225 (FORD)					
ALL	1356-5155	D2JL-9510-C	H4/4160	18-7096	18-7206
MCM/MIE 225 (GM)	1337-2103	7025564	R4/4GC	18-7078	—
1536920-2694014	1337-2604	7025756	R4/4GC	18-7078	—
	1347-3353	7037082	R4/4MV	18-7072	18-7201
	1347-3237A3	7037082	R4/4MV	18-7072	18-7201
MCM 228					
5069430 & BELOW	1347-6427A1	17057282	R4/4MV	18-7072	18-7201
MCM 228TR/ MIE 228					
5069430 & BELOW	1347-6438A1	17057283	R4/4MV	18-7072	18-7201
MCM 228/230/5.0L					
5069431-6021783	1347-7361A1	17059292	R4/4MV	18-7095	

① Does not include metering rods

CARBURETOR KIT/FLOAT APPLICATION (Cont.)

Model & Serial #	Mercuriser Carb #	Mfg. Carb #	Carb. Code & Model	Carb Kit ①	Float
6021784-6218461	1347-8296A4	17080565	R4/4MV	18-7095	18-7201
6218462 & ABOVE	1347-9661A3	—	R4/4MV	18-7095	18-7201
MIE 228					
5067431-6040745	1347-7364A1	17059291	R4/4MV	18-7095	18-7201
6040746 & ABOVE	1347-8290A1	17080564	R4/4MV	18-7095	18-7201
MIE 230/5.0L ALL	1347-8290A1	17080564	R4/4MV	18-7095	18-7201
230/5.0LX	1347-9661A3	—	R4/4MV	18-7095	18-7201
MCM/MIE 233					
4465029 & BELOW	1376-5744A1	7044187	R2/2GC	18-7075	18-7202
4465030 & ABOVE	1376-6152A1	17056197	R2/2GC	18-7075	18-7202
MCM/MIE 250 AUTO. CHOKE					
4767999 & BELOW	1347-3353	7037082	R4/4MV	18-7072	18-7201
MCM/MIE 250 (EL. CHOKE)					
4767999 & BELOW	1347-3237A3	7037082	R4/4MV	18-7072	18-7201
MCM 250					
4768000 & ABOVE	1347-6492A1	17057298	R4/4MV	18-7072	18-7201
MCM/MIE 255 (GM)					
4924564 & BELOW	1347-5732A1	7044291	R4/4MV	18-7072	18-7201
4924565-5195908	1347-7062A1	17057295	R4/4MV	18-7072	18-7201
5195909-5907067	1347-7365A1	17059289	R4/4MV	18-7095	18-7201
5907068 & ABOVE	1347-8289A1	17080562	R4/4MV	18-7095	18-7201
MCM/MIE 255 (FORD)					
ALL	1356-5169	D2JL-9510E	H4/4160	18-7096	18-7206
MCM 260/5.7L BRAVO					
5060805 & BELOW	1347-6492A1	17057298	R4/4MV	18-7072	18-7201
5060806-6024393	1347-7362A1	17059288	R4/4MV	18-7095	18-7201
6024394-B525981	1347-8292A4	17080561	R4/4MV	18-7095	18-7201
B525982 & ABOVE	1347-9662A4	—	R4/4MV	18-7095	18-7201
MIE 260/5.7L 350 MAG					
A635178-D617327	1347-8289A1	17080562	R4/4MV	18-7095	18-7201
MIE 5.7 SKI					
A339533-F205099	1347-9415T	17085013	R4/4MV	18-7095	18-7201
MCM/MIE 270 ALL	1347-4180A1	7029285	R4/4MV	18-7072	18-7201
MCM 280					
4176468 & BELOW	1347-4179A2	7040283	R4/4MV	18-7072	18-7201
4176469 & ABOVE	1347-5981A1	7044290	R4/4MV	18-7072	18-7201
MCM 300 MR/TRS (GM)					
6668677 & ABOVE	1347-7498A7	—	R4/4MV	18-7095	18-7201
MCM/MIE 325 AUTO. CHOKE					
3042730 & BELOW	1347-3342	7027080	R4/4MV	18-7072	18-7201
3042731 & ABOVE	1347-4533A1	7041831	R4/4MV	18-7072	18-7201
MCM/MIE 325 EL. CHOKE					
2278747-378099	1347-3689A1	7029280	R4/4MV	18-7072	18-7201
MCM 330/454 MAGNUM (ALPHA ONE)					
5027230 & BELOW	1347-6493A1	17057287	R4/4MV	18-7072	18-7201
5027231-6083144	1347-7363A1	17059290	R4/4MV	18-7095	18-7201
6083145 & ABOVE	1347-8291A3	17080563	R4/4MV	18-7095	18-7201
MIE 330					
5226384 & BELOW	1347-6493A1	17057287	R4/4MV	18-7072	18-7201
5226385 & ABOVE	1347-7366A1	17059287	R4/4MV	18-7095	18-7201
MIE 340/7.4L					
ALL	1347-8288A1	17080560	R4/4MV	18-7095	18-7201
MCM 350 MAGNUM/5.7L BRAVO					
B525992-317327	1347-8289A1	—	R4/4MV	18-7095	18-7201
MIE 350 ALL	1347-5326A2	17065977	R4/4MV	18-7072	18-7201
MCM 370/400 ALL	1347-7498A2	17059280	R4/4MV	18-7095	18-7201
MCM 7.4L (BRAVO ONE)	1347-8291A3	17080563	R4/4MV	18-7095	18-7201
MCM 454 7.4L					

① Does not include metering rods

CARBURETOR KIT/FLOAT APPLICATION (Cont.)

Model & Serial #	Mercruiser Carb #	Mfg. Carb #	Carb. Code & Model	Carb Kit ①	Float
6083145-B816540	—	—	H4/4150, R6647A	18-7728	—
MCM 454 MAGNUM					
(BRAVO ONE)	1347-7498A2	17059280	R4/4MV	18-7095	18-7201
ALL	1347-9863A3	—	R4/4MV	18-7095	18-7201
MCM 502 MAGNUM (BRAVO ONE)					
C878221-D857199	1347-814623A2	—	R4/4MV	18-7095	18-7201
MCM 8.2L	1347-814623A2	—	R4/4MV	18-7095	18-7201

① Does not include metering rods



**18-7228
FLAME ARRESTOR**
Replaces: 85784A1



**18-7229
FLAME ARRESTOR**
Replaces: 85785T, 85785-2



**18-7230
FLAME ARRESTOR**
Replaces: 41639A1, 41639



**18-7231
FLAME ARRESTOR**
Replaces: 85785A2



**18-7232
FLAME ARRESTOR**
Replaces: 57882, 57882T



**18-7234
FLAME ARRESTOR**
Replaces: 805016A1

ALL SIERRA FUEL PUMPS INCLUDE MOUNTING GASKET



**18-8861
FUEL PUMP W/ COOLER**
Replaces: 861156A02
For: GM V-6/ V-8 EFI 0L000000-0M299999

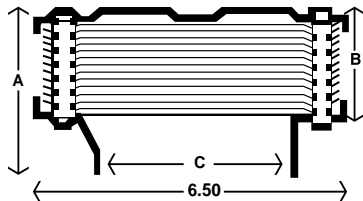

**ANODIZED ALUMINUM
FLAME ARRESTOR SPECIFICATIONS**

Engine	Part No.	Height A	Element B	Throat C	Vent Tubes*
4 & 6 cyl.	18-7228	2.156	1.088	3.12	1
4 & 6 cyl. ①	18-7234	2.28	1.55	3.1	0
V-8	18-7229	2.25	1.47	5.05	0
V-8	18-7230	2.25	1.47	5.05	1
V-8	18-7231	2.25	1.47	5.05	2
Hi-Performance	18-7232	2.969	2.19	5.05	2

① 7" Outside diameter * Vent tubes accept 3/8 inch ID hose



**18-8862
FUEL PUMP W/ COOLER**
Replaces: 861156A03
For: GM V-6/ V-8 EFI 0M300000



**18-8864
FUEL PUMP W/ REGULATOR**
Replaces: 866169T01, 866169A01
For: Gm V-8 with Gen III Cool Fuel Module-high pressure



**18-8865
FUEL PUMP**
Replaces: 866170A01
For: Gm V-8 with Gen III Cool Fuel Module-low pressure



**18-8867
FUEL PUMP**
Replaces: 861155A6, 861155A5, 805656A6,
805656A5, 805656A2, 805025A2
For: 4.3L V-6



**18-8868
FUEL PUMP**
Both ends threaded
Replaces: 861155A3, 861155A2
For: 5.0/ 5.7L V-8 & 4.3L



**18-7326
ELECTRIC FUEL PUMP**
Replaces: 805656A2, 805656A6, 805656A5, 805025A2, 861155A6, 861155A5
For: 1992-93, 1996 F.I. & Carbureted 4.3L with inline electric pump



**18-35433
ELECTRIC FUEL PUMP**
One end threaded, One end snap fitting
Replaces: 861156A1
Fits: Mercruiser V6 & V8 305/350/377/454/502 EFI (Non-Threaded)(Replaces Cool Fuel Pump)



**18-7266
FUEL PUMP**
Flange I.D. # 41413, M6696
For: Ford (V-8) 302, 351



**18-7267
FUEL PUMP**
Flange I.D. # 41414
Replaces: 62092T, 62092, 54552
For: Ford (V-8) 302
(Includes gasket)



**18-7274
FUEL PUMP**
Flange I.D. # 41421, M73021
Replaces: 86246, 86246A1, 78485, 71646
For: GM (V-8) 305, 350, 400, 228 / 250 / 255 / 260 / 280



**18-7275
FUEL PUMP**
Flange I.D. # 41422
Replaces: 86247, 86247T, 86247A2, 78820, 63196, 46860
For: GM (V-8) 454, 330 / 325 / 350 / 390
(Includes gasket)



**18-7278
FUEL PUMP**
Flange I.D. # M60032
Replaces: 86234A4, 86234A05, 86234A3, 86234, 77594, 71327, 47585
For: GM (4 & 6 Cyl.) 153, 181, 225, 250, 120 / 140 / 160 / 165 / 470 / 485 / 488
Uses filter **18-7860** & gasket **18-0889**



**18-7282
FUEL PUMP**
Flange I.D. # M60337
Replaces: 8M0073435, 861676T09
For: GM 4 cyl. (2.5/3.0L) & Mercruiser 3.7L
Uses filter **18-7784** & gasket **18-0889**



**18-7283
FUEL PUMP**
Flange I.D. # M60600
Replaces: 97401A2, 97401A8, 861678A1, 8M0058164, 97401
For: GM (V-8) 305, 350, 228 / 230 / 260 / 898
Uses gasket **18-0889**



**18-7284
FUEL PUMP**
Flange I.D. # M60315
Replaces: 41141A2, 862077A1
For: GM (V-6) 231, 262, 229
Uses filter **18-7784** & gasket **18-0889**



**18-7288-1
FUEL PUMP**
Flange I.D. #60601
Replaces: 812454A1, 862048A1, 812454A3, 97399A2, 97399
For: Inline (4 cyl) 120, 140, 3.0L and 224 CID 7.4L / 454 / 420 / 330



**18-35437
FUEL PUMP**
Replaces: 42725A3, 861676A1, 861676T09, 8M0073435
Fits: Mercruiser 3.0L (SN L097000 & Up)
(Includes gasket)



**18-8860
FUEL PUMP**
Replaces: 861677T
For: GM V-8 (454 & 502) applications
(Includes gasket)



**18-7256
FUEL PUMP**
Flange I.D. # 6790, M3530
Replaces: 32722
For: GM (4 & 6 Cyl.) 153, 230, 250, 292

FUEL PUMP APPLICATION

Model	CID/#CYL	Year Range	Beginning Serial #	Ending Serial #	Fuel Pump #1	Fuel Pump #2	Pump Filter
120	153/L4	1964-1972	1666601	3377340	18-7278 ①	—	18-7860
120	153/L4	1964-1972	1666601	3377340	18-7256 ②	—	—
120	153/L4	1972-1982	3377341	6229717	18-7278	—	18-7860
120	153/L4	1983-1986	6229718	B531853	18-7278 ③	—	18-7860
120			4469866	& Below	18-7278	—	—
120			4469866	4952700	18-7278	—	—
120			4952701	& Up	18-7278	—	—
120			5192049	6229717	18-7278	—	—
120/2.5L			6229718	& Up	18-7278	—	—
120/2.5L			6229718	& Up	18-7282	—	—
2.5L	153/L4	1987-1989	B531854	BC853255	18-7278 ④	—	18-7860
140 (4 CYL)	181/L4	1968-1982	2508261	6229717	18-7278	—	18-7860
140 (4 CYL)	181/L4	1983-1986	6229718	B450800	18-7278 ⑤	—	18-7860
3.0L	181/L4	1987-1989	B450801	C856558	18-7278 ⑥	—	18-7860
140			4460664 & Below	& Below	18-7278	—	—
140			4460665	4918569	18-7278	—	—
140			4918570	& Up	18-7278	—	—
140 (4 Cyl.)			5157669	6229717	18-7278	—	—
140/3.0L			6229717 & Below	& Below	18-7278	—	—
140/3.0L			6229718 & Up	& Up	18-7282	—	—
3.0L/3.0LX			C856559 & Up	& Up	18-7282	—	—
140 (6 Cyl.)			1538930	1725960	18-7256	—	—
150			1666495	2048046	18-7256	—	—
160			2048022	2770031	18-7278	—	—
165			4471566	4884834	18-7278	—	—
165			5178959 & Up	& Up	18-7278	—	—
165/3.7L (4 Cyl.)			6916779 & Up	& Up	18-7282	—	—
180/3.7-LX (4 Cyl.)			6916779 & Up	& Up	18-7282	—	—
175/4.3L (262 CID)			B527955 & Up	& Up	18-7284	—	—
185 (229 CID)			6330183 & Up	& Up	18-7284	—	—
185 (262 CID)			A331455 & Up	& Up	18-7284	—	—
470	224/L4	1976-1984	4208730	6916778	18-7278	—	18-7860
485	224/L4	1980-1982	5685394	6218036	18-7278	—	18-7860
488	224/L4	1983-1984	6170297	6916778	18-7278 ⑦	—	18-7860
140 (6 CYL)	194/L6	1963	1538930	1725960	18-7256	—	—
150	230/L6	1964-1966	1666495	2048046	18-7256	—	—
160	250/L6	1967-1969	2048022	2770031	18-7278 ⑧	—	18-7860
160	250/L6	1967-1969	2048022	2770031	18-7256 ⑨	—	—
165 (6 CYL)	250/L6	1979-1981	2770032	5813433	18-7278	—	18-7860
200 (6 CYL)	250/L6	1969	2453769	2712072	18-7278	—	18-7860
200 GM			6218462	& Up	18-7283	—	—
200/5.0L GM			B525982	& Up	18-7283	—	—
185 (4bbl)	229/V-6	1983-1984	6330183	6919655	18-7284	—	—
175	262/V-6	1987	B527955	B773242	18-7284	—	—
185 (2bbl)	262/V-6	1985-1986	A331455	B527954	18-7284	—	—
205	262/V-6	1985-1987	A331455	B775129	18-7284	—	—
205/4.3L-LX (262 CID)			B527955	& Up	18-7284	—	—
262 MAG EFI (GEN +)	262/V-6	1996-1997	F803800	K999999	18-8867	—	—
4.3L	262/V-6	1988-1992	B773243	D714106	18-7284	—	—
4.3L (GEN II)	262/V-6	1992-1996	D714107	F802999	18-8867	—	—
4.3L (GEN +)	262/V-6	1998-2010	L012009	& Up	18-8868	—	—

- ① low pressure lift pump
- ② high pressure fuel cool pump
- ③ fuel pump mounted with filter bowl facing up
- ④ fuel pump mounted with filter bowl facing down
- ⑤ AC fuel pump

- ⑥ Carter fuel pump
- ⑦ mechanical fuel pump
- ⑧ use if fuel pump has sight glass
- ⑨ use if fuel pump has sight tube
- ⑩ fuel pump/cooler kit

FUEL PUMP APPLICATION

Model	CID/#CYL	Year Range	Beginning Serial #	Ending Serial #	Fuel Pump #1	Fuel Pump #2	Pump Filter
4.3L EFI (GEN +)	262/V-6	1998-2001	L012009	M299999	18-8861 ⑩	—	—
4.3L MPI	262/V-6	2002-2010	M300000	& Up	18-8862 ⑩	—	—
4.3LH (GEN+)	262/V-6	1998-2002	L010044	M614999	18-8868	—	—
4.3LX	262/V-6	1988-1992	B775130	D714369	18-7284	—	—
4.3LX (GEN II)	262/V-6	1992-1996	D714107	F802999	18-8867	—	—
4.3LX (GEN +)	262/V-6	1996-1997	F803000	K999999	18-8867	—	—
4.3LXH (GEN +)	262/V-6	1996-1997	F803114	K999999	18-8867	—	—
215 (FORD)	302/V-8	1970-1972	2781153	3563181	18-7267	—	—
215 Ford			3085036	& Below	18-7267	—	—
215 Ford			3258182	& Up	18-7267	—	—
225 Ford	302/V-8	1973-1974	3385721	4166999	18-7267	—	—
228 MCM & MIE	305/V-8	1977-1978	4765100	5170008	18-7274	—	—
228 MCM & MIE	305/V-8	1979-1982	5170009	6218461	18-7274	—	—
228 MCM & MIE	305/V-8	1979-1982	5170009	6218461	18-7283 ⑨	—	—
888 (FORD)	302/V-8	1971-1977	3108723	4887829	18-7267	—	—
228	305/V-8	1982-1984	6218462	6899268	18-7283	—	—
230 MIE	305/V-8	1981-1987	5907058	B788151	18-7283	—	—
230/5.0L-GM (IB)			B522506	& Up	18-7283	—	—
230 GM			6218462	& Up	18-7283	—	—
230/5.0L-LX GM			B525982	& Up	18-7283	—	—
230	305/V-8	1985-1987	6899269	B773739	18-7283	—	—
5.0L	305/V-8	1988-1995	B774445	F600999	18-7283	—	—
5.0L (GEN +)	305/V-8	1998-2010	L015751	& Up	18-8868	—	—
5.0L EFI (GEN +)	305/V-8	1998-2001	L012052	M299999	18-8861 ⑩	—	—
5.0L MIE	305/V-8	1988	B788152	C396832	18-7283	—	—
5.0L MPI ALPHA	305/V-8	2002-2010	M300000	& Up	18-8862 ②, ⑩	18-8868 ①	—
5.0L MPI BRAVO	305/V-8	2002-2004	M300000	W059999	18-8862 ②, ⑩	18-8868 ①	—
5.0L MPI BRAVO	305/V-8	2004-2010	W060000	& Up	18-8864 ②	18-8865 ①	—
5.0LX	305/V-8	1988-1995	B773740	F600999	18-7283	—	—
898	305/V-8	1977-1982	4762210	6218461	18-7274 ⑨	—	—
898	305/V-8	1977-1982	4762210	6218461	18-7283 ⑨	—	—
898	305/V-8	1983-1984	6218462	6899057	18-7283	—	—
233 FORD			4500860	& Up	18-7267	—	—
250	350/V-8	1977	4768000	4908849	18-7274	—	—
255	350/V-8	1975-1976	4175500	4767999	18-7274	—	—
255 MIE (GM)	350/V-8	1975-1980	4175500	5907057	18-7274	—	—
255 FORD			3258728	& Up	18-7267	—	—
255 GM			5195909	& Up	18-7274	—	—
260	350/V-8	1978-1982	4908850	6218461	18-7274 ⑨	—	—
260	350/V-8	1978-1982	4908850	6218461	18-7283 ⑨	—	—
260	350/V-8	1983-1987	6218461	& Up	18-7283	—	—
260 MIE	350/V-8	1981-1987	5907058	B788151	18-7283	—	—
260/5.7 GM			B525982	& Up	18-7283	—	—
260 GM Inboard			5907058	& Up	18-7283	—	—
260/5.7L GM (IB)			5907058	& Up	18-7283	—	—
5.7L-GM			F025000	& Up	18-7283	—	—
280	350/V-8	1975-1976	4176250	4770199	18-7274	—	—
300MR/TRS GM	350/V-8	1985-1986	6668677	B430367	18-7283	—	—
320 EFI	350/V-8	1987-1989	A543604	C622418	N.L.A	—	—
325-GM			2278747	3640670	18-7275	—	—
330 GM			4623115	& Up	18-7275	—	—
330 GM/W.B.W.			6083145	& Up	18-7288-1	—	—
340/7.4L-GM (IB)			5889914	& Up	18-7288-1	—	—

- ① low pressure lift pump
- ② high pressure fuel cool pump
- ③ fuel pump mounted with filter bowl facing up
- ④ fuel pump mounted with filter bowl facing down
- ⑤ AC fuel pump

- ⑥ Carter fuel pump
- ⑦ mechanical fuel pump
- ⑧ use if fuel pump has sight glass
- ⑨ use if fuel pump has sight tube
- ⑩ fuel pump/cooler kit

FUEL PUMP APPLICATION

Model	CID/#CYL	Year Range	Beginning Serial #	Ending Serial #	Fuel Pump #1	Fuel Pump #2	Pump Filter
350 MAG ALPHA	350/V-8	1986-1997	A635178	K999999	18-7283	—	—
350 MAG ALPHA EFI (GEN +)	350/V-8	1996	F800300	K001508	18-7283	—	—
350 MAG ALPHA EFI (GEN +)	350/V-8	1997	K001509	K999999	—	—	—
350 MAG BRAVO MPI	350/V-8	1995-1996	F415189	K001500	18-7283	—	—
350 MAG BRAVO MPI	350/V-8	1997	K001501	K999999	—	—	—
350 MAG EFI SKI	350/V-8	1994-1997	F215561	K999999	—	—	—
350 MAG MPI	350/V-8	1998-2001	L010019	M299999	18-8861 ①	—	—
350 MAG MPI ALPHA	350/V-8	2002-2010	M300000	& Up	18-8862 ②	18-8868 ③	—
350 MAG MPI BRAVO	350/V-8	2002-2004	M300000	W059999	18-8862 ②, ⑩	18-8868 ③	—
350 MAG MPI BRAVO	350/V-8	2004-2010	W060000	& Up	18-8864 ②	18-8865 ③	—
350 MAG MPI HORIZON	350/V-8	2002-2004	M300000	W059999	18-8862 ②, ⑩	18-8868 ③	—
350 MAG MPI HORIZON	350/V-8	2004-2007	W060000	A299999	18-8864 ②	18-8865 ③	—
350 MAG MPI HORIZON MIE	350/V-8	1999-2001	L304700	M299999	18-8861 ⑤	— ①	—
350 MAG MPI HORIZON MIE	350/V-8	2002-2004	M300000	M398371	18-8862 ②, ⑩	18-8868 ③	—
350 MAG MPI HORIZON MIE	350/V-8	2004-2007	M398372	A089999	18-8864 ②	18-8865 ③	—
350 MAG MPI MIE	350/V-8	1998-2001	L002008	M299999	18-8861 ⑩	—	—
350 MAG MPI MIE	350/V-8	2002-2004	M300000	M398371	18-8862 ②, ⑩	18-8868 ③	—
350 MAG MPI MIE	350/V-8	2004-2007	M398372	A089999	18-8864 ②	18-8865 ③	—
350 MAG MPI MIE	350/V-8	1998-2001	L002008	M299999	18-8861 ⑩	—	—
350 MAG MPI MIE	350/V-8	2002-2004	M300000	M398371	18-8862 ②, ⑩	18-8868 ③	—
350 MAG MPI MIE	350/V-8	2004-2007	M398372	A089999	18-8864 ②	18-8865 ③	—
350 MAG MPI SKI	350/V-8	1995-1996	F350583	F799999	18-7283	—	—
350 MAG MPI SKI (GEN +)	350/V-8	1998-2001	L002600	M299999	18-8861 ⑩	—	—
350 MAG MPI SKI (GEN +)	350/V-8	2002-2007	M300000	A089999	18-8862 ⑩	18-8868 ③	—
350 MAG SKI	350/V-8	1991-1997	D505450	K999999	18-7283	—	—
350 GM			3780450	& Up	18-7275	—	—
(MAG-TOURNEY SKI)			D505450	& Up	18-7283	—	—
370 TRS-GM			6721528	& Up	18-7288-1	—	—
390-GM			2781129 - 2825059	2825059	18-7275	—	—
5.7L	350/V-8	1988-1997	B773305	K999999	18-7283	—	—
5.7L (GEN +)	350/V-8	1998-2010	L010037	& Up	18-8868	—	—
5.7L EFI	350/V-8	1995-1996	F225560	K001505	18-7283	—	—
5.7L EFI	350/V-8	1997-2001	K001506	M299999	18-8861 ⑩	—	—
5.7L MIE	350/V-8	1988-1997	B788152	K999999	18-7283	—	—
5.7L MIE (GEN +)	350/V-8	1998-2010	L002003	& Up	18-8868	—	—
5.7L MPI HORIZON MIE	350/V-8	2008-2010	A090000	& Up	18-8864 ②	18-8865 ③	—
5.7L MPI MIE	350/V-8	2008-2010	A090000	& Up	18-8864 ②	18-8865 ③	—
5.7L MPI SKI	350/V-8	2008-2010	A090000	& Up	18-8862 ②, ⑩	18-8868 ③	—
5.7L SKI	350/V-8	1985-1997	A338553	K999999	18-7283	—	—
5.7L SKI (GEN +)	350/V-8	1998-2010	L002005	& Up	18-8868	—	—
5.7LX	350/V-8	1996-1997	F601000	K999999	18-7283	—	—
5.7LX BRAVO EFI (GEN +)	350/V-8	1996	F800300	K001508	18-7283	—	—
5.7LX BRAVO EFI (GEN +)	350/V-8	1997	K001509	K999999	—	—	—
5.7LX EFI	350/V-8	1996	F752400	K001505	18-7283	—	—
5.7LX EFI	350/V-8	1997	K001506	K999999	—	—	—
5.7 GM (SKI)			B514627	& Up	18-7283	—	—
5.7L BRAVO (GM)350			B525982	& Up	18-7283	—	—
BLACK SCORPION SKI	350/V-8	1997	K040001	K999999	—	—	—
BLACK SCORPION SKI	350/V-8	1998-2001	L000000	L679175	18-8861 ②, ⑩	—	—
BLACK SCORPION SKI	350/V-8	2001-2007	L679176	W698432	18-8861 ②, ⑩	18-8868 ③	—
SCORPION 350	350/V-8	2008-2010	W698433	& Up	18-8861 ②, ⑩	18-8868 ③	—

- ① low pressure lift pump
- ② high pressure fuel cool pump
- ③ fuel pump mounted with filter bowl facing up
- ④ fuel pump mounted with filter bowl facing down
- ⑤ AC fuel pump

- ⑥ Carter fuel pump
- ⑦ mechanical fuel pump
- ⑧ use if fuel pump has sight glass
- ⑨ use if fuel pump has sight tube
- ⑩ fuel pump/cooler kit

FUEL PUMP APPLICATION

Model	CID#/CYL	Year Range	Beginning Serial #	Ending Serial #	Fuel Pump #1	Fuel Pump #2	Pump Filter
SCORPION 350 EC	350/V-8	2009-2010	W698433	& Up	18-8864 ②	18-8864 ①	—
233 (FORD)	351/V-8	1975-1977	4173000	4902304	18-7267	—	—
255 (FORD)	351/V-8	1973-1974	3258728	4175499	18-7267	—	—
377 MAG	377/V-8	2008-2010	A300000	& Up	18-8864 ②	18-8865 ①	—
377 SCORPION MCM	377/V-8	1999-2005	L416146	M907201	18-8861 ⑩	—	—
377 SCORPION SKI	377/V-8	1997-1998	K00656	L600314	18-8861 ⑩	—	—
MX 6.2L MPI	377/V-8	2000-2001	L680003	M299999	18-8861 ⑩	—	—
MX 6.2L MPI	377/V-8	2002-2004	M300000	W059999	18-8862 ②, ⑩	18-8868 ①	—
MX 6.2L MPI	377/V-8	2004-2007	W060000	A299999	18-8864 ②	18-8865 ①	—
MX 6.2L MPI HORIZON	377/V-8	2002-2004	M300000	W059999	18-8862 ②, ⑩	18-8868 ①	—
MX 6.2L MPI HORIZON	377/V-8	2004-2007	W060000	A299999	18-8864 ②	18-8865 ①	—
MX 6.2L MPI HORIZON MIE	377/V-8	2002-2004	M300000	M398394	18-8862 ②, ⑩	18-8868 ①	—
MX 6.2L MPI HORIZON MIE	377/V-8	2004-2010	M398395	& Up	18-8864 ②	18-8865 ①	—
MX 6.2L MPI MIE	377/V-8	2002-2004	M300000	M398394	18-8862 ②, ⑩	18-8868 ①	—
MX 6.2L MPI MIE	377/V-8	2004-2010	M398395	& Up	18-8864 ②	18-8865 ①	—
MX 6.2L MPI SKI	377/V-8	2002-2010	M317000	& Up	18-8862 ②, ⑩	18-8868 ①	—
MX 6.2L BLACK SCORPION SKI	377/V-8	2001	L670015	L679175	18-8861 ⑩	—	—
MX 6.2L BLACK SCORPION SKI	377/V-8	2001-2007	L679176	W698432	18-8861 ②, ⑩	18-8868 ①	—
SCORPION 377	377/V-8	2008-2010	W698433	& Up	18-8861 ②, ⑩	18-8868 ①	—
SCORPION 377 HO EC	377/V-8	2009-2010	A091488	A092170	18-8864 ②	18-8865 ①	—
325	427/V-8	1969-1972	2278747	3780449	18-7275	—	—
330	454/V-8	1977-1981	4623115	6083144	18-7275	—	—
330 WITH B/W	454/V-8	1982-1987	6083145	B816540	18-7288-1	—	—
340 MIE	454/V-8	1981-1987	5889914	B788365	18-7288-1	—	—
350 MIE	454/V-8	1974-1976	3780450	4623109	18-7275	—	—
370 TRS	454/V-8	1978-1987	4179554	B714586	18-7288-1	—	—
400 TRS	454/V-8	1980-1986	4179554	B457644	18-7288-1	—	—
420	454/V-8	1987-1989	A398941	B622418	18-7288-1	—	—
425-GM			A398941	& Up	18-7288-1	—	—
425	454/V-8	1990-1992	B622419	D725499	18-7288-1	—	—
425 (GEN V)	454/V-8	1992-1993	D763855	D937011	18-8860	—	—
440 TRS	454/V-8	1983-1986	4179554	B485220	18-7288-1	—	—
450	454/V-8	1995-1996	F347100	F347277	18-8860	—	—
454 MAG ALPHA	454/V-8	1986-1988	A631894	B785148	18-7288-1	—	—
454 MAG BRAVO GM			B840126	& Up	18-7288-1	—	—
454 MAG BRAVO	454/V-8	1988-1992	A631894	B785148	18-7288-1	—	—
454 MAG BRAVO	454/V-8	1992-1997	D805069	K999999	18-8860	—	—
454 MAG EFI	454/V-8	1994-1996	F115700	F802349	18-8860	—	—
454 MAG EFI SKI	454/V-8	1995-1996	F215800	F820099	18-8860	—	—
454 MAG MPI	454/V-8	1996	F802350	K147349	18-8860	—	—
454 MAG MPI	454/V-8	1997	K147350	K999999	18-8861 ⑩	—	—
454 MAG MPI	454/V-8	1998-2001	L010029	M024999	18-8861 ⑩	—	—
454 MAG MPI HORIZON MIE	454/V-8	1998-2001	L002200	L674000	18-8861 ⑩	—	—
454 MAG MPI SKI	454/V-8	1996-1997	F820100	K999999	18-8860	—	—
470			5097479	& Below	18-7278	—	—
470			5097480	& Up	18-7278	—	—
470			5520115	6218036	18-7278	—	—
470			6218037	& Up	18-7278	—	—
485			5685394	& Up	18-7278	—	—
488			6170297	& Up	18-7278	—	—

- ① low pressure lift pump
- ② high pressure fuel cool pump
- ③ fuel pump mounted with filter bowl facing up
- ④ fuel pump mounted with filter bowl facing down
- ⑤ AC fuel pump

- ⑥ Carter fuel pump
- ⑦ mechanical fuel pump
- ⑧ use if fuel pump has sight glass
- ⑨ use if fuel pump has sight tube
- ⑩ fuel pump/cooler kit

FUEL PUMP APPLICATION

Model	CID/#CYL	Year Range	Beginning Serial #	Ending Serial #	Fuel Pump #1	Fuel Pump #2	Pump Filter
525SC	454/V-8	1992-1999	D725809	L415623	18-8860	—	—
7.4L BRAVO	454/V-8	1988-1991	B771113	D603117	18-7288-1	—	—
7.4L BRAVO	454/V-8	1992-1997	D603118	K999999	18-8860	—	—
7.4L EFI MIE	454/V-8	1996-1997	F874815	K999999	—	—	—
7.4L MIE	454/V-8	1988-1992	B788366	D715493	18-7288-1	—	—
7.4L MIE	454/V-8	1992-1997	D715494	K999999	18-8860	—	—
7.4L MPI	454/V-8	1998-2001	L010003	M024330	18-8861 ⑩	—	—
7.4L MPI MIE	454/V-8	1995-1997	F563052	K147349	18-8860	—	—
7.4L MPI MIE	454/V-8	1997	K147350	K999999	—	—	—
7.4L MPI MIE	454/V-8	1997-2001	L002006	L674613	18-8861 ⑩	—	—
7.4LX BRAVO EFI	454/V-8	1996-1997	F820000	K999999	—	—	—
7.4LX BRAVO MPI	454/V-8	1996-1997	F602010	K999999	18-8860	—	—
7.4L W/HURTH (IB)			C391564	& Up	18-7288-1	—	—
390	482/V-8	1969-1970	2781129	2825059	18-7275	—	—
496 MAG & HO	496/V-8	2001-2004	M025000	W059999	18-8862 ②, ⑩	18-8868 ①	—
496 MAG & HO	496/V-8	2004-2010	W060000	& Up	18-8864 ②	18-8865 ①	—
8.1S MPI MIE & HO	496/V-8	2001-2004	M026000	W089999	18-8862 ②, ⑩	18-8868 ①	—
8.1S MPI MIE & HO	496/V-8	2004-2010	W090000	& Up	18-8864 ②	18-8865 ①	—
465	502/V-8	1992-1994	D456155	F213244	18-7275	—	—
500	502/V-8	1994-1998	F213293	L001772	18-7275	—	—
502 MAG BRAVO	502/V-8	1992-1993	D824589	F114528	18-8860	—	—
502 MAG EFI	502/V-8	1993-1995	D840650	F802599	18-8860	—	—
502 MAG MPI	502/V-8	1996	F802600	K147349	18-8860	—	—
502 MAG MPI	502/V-8	1997	K147350	K999999	—	—	—
502 MAG MPI	502/V-8	1998-2001	L017000	M024999	18-8861 ⑩	—	—
600SC	502/V-8	1992-2000	D725676	L601186	18-8860	—	—
8.2L MAG & HO	502/V-8	2010	A340340	& Up	18-8864 ②	18-8865 ①	—
8.2L MAG & HO MIE	502/V-8	2010	A350802	& Up	18-8864 ②	18-8865 ①	—
8.2L MIE	502/V-8	1993-1996	D857200	F819619	18-8860	—	—
8.2L MPI MIE	502/V-8	1996-1997	F819620	K147349	18-8860	—	—
8.2L MPI MIE	502/V-8	1997	K147350	K999999	—	—	—
8.2L MPI MIE	502/V-8	1998-2001	L002450	L674200	18-8861 ⑩	—	—

- ① low pressure lift pump
- ② high pressure fuel cool pump
- ③ fuel pump mounted with filter bowl facing up
- ④ fuel pump mounted with filter bowl facing down
- ⑤ AC fuel pump
- ⑥ Carter fuel pump
- ⑦ mechanical fuel pump
- ⑧ use if fuel pump has sight glass
- ⑨ use if fuel pump has sight tube
- ⑩ fuel pump/cooler kit

FUEL WATER SEPARATORS

Sierra fuel water separators remove over 99.8% of emulsified water from your gasoline. Sierra's 10 micron filters are over 90% efficient at removing particles as small as 10 micron. All filters flow @ 90 GPH to feed even the hungriest motor. Sierra 10 micron filters are recommended to prevent damage to sensitive inboard and outboard fuel injection systems.

- UNIVERSAL DESIGN -

DIRECT REPLACEMENT FOR MERCURY AND YAMAHA

FUEL WATER SEPARATOR BRACKETS



Bracket Type	Part No.	Replaces
1/4" Stainless Steel	18-8777	—
3/8" Stainless Steel	18-7776	—
1/4" Aluminum	18-7853-1	Mercury 89876A3, 55481, 89876
3/8" Aluminum	18-7775	—

10 MICRON FILTER KITS WITH DRAIN BOWLS

Sierra AquaVue™ and metal bowl separator filters allow water to be drained from the filter to extend service life. Use the AquaVue™ bowl for outboard, above deck installations. USCG regulations require the use of the flame resistant metal bowl below deck.

- Display Packaged



Kit Type	Part #	Micron Rating	Contents
1/4" Aluminum w/ metal drain bowl	18-7951 •	10	1 - 18-7919 filter & 1 18-7853-1 bracket 1 - 18-7924 metal bowl 2 - 18-4256 1/4" pipe plugs
1/4" Stainless Steel w/ metal drain bowl	18-7938 •	10	1 - 18-7919 filter & 1 18-7777 bracket 1 - 18-7924 metal bowl 2 - 18-4256 1/4" pipe plugs

COMPACT BRACKET AND SEPARATOR KIT - FOR SMALL OUTBOARDS AND FRESH WATER APPLICATIONS

18-7774
COMPACT ALUMINUM BRACKET



18-7965-1
10 MICRON COMPACT SEPARATOR KIT
Contains:
1 - 18-7774 bracket
1 - 18-7865 filter



REPLACEMENT FILTERS



UNIVERSAL DESIGN - DIRECT REPLACEMENT FOR MERCURY

10 MICRON REPLACEMENT FILTERS			10 MICRON REPLACEMENT FILTERS		
Part No.	Description	Replaces	Part No.	Description	Replaces
18-7944	Short - 3.875"	35-807172, 35-802893Q, 35-806771, 35-8053691, 35-805369, 35-604941, 35-60494, 35-57250, 35-55501, 35-52456	18-7865	Compact 10 Micron	—
18-7945	Long - 8.5"	35-802893Q, 35-806771, 35-8053691, 35-805369, 35-604941, 35-60494, 35-57250, 35-55501, 35-52456	18-79911	Long - 8.5"	35-8M0079962
18-7866	High Capacity - 6"	—	21 MICRON REPLACEMENT FILTERS		
			18-7844	Short - 3.875"	35-807172, 35-802893Q
			18-7845	Long - 4.35"	35-807172, 35-806771, 35-8053691, 35-60494A4, 35-604941, 35-57250, 35-55501

10 MICRON REPLACEMENT FILTERS AND KITS WITH DRAIN BOWLS



REPLACEMENT FILTERS			REPLACEMENT BOWLS	
Part No.	Description	Replaces	Part No.	Description
18-7919	Spin-on replacement	35-809097, 35-8M0103095 Racor S3213	18-7924	Metal Collection Bowl
18-7920	Spin-on replacement	Mercury 35-809099 Racor S3214	FILTER & BOWL KITS	
18-7947	Spin-on replacement	Racor S3240	Part No.	Description
18-7948	Spin-on replacement Fits: 320RRAC01	35-886638 Racor S3227	18-7929 •	Filter & Metal Bowl, Mercury Style Contains: 18-7919 filter & 18-7924 bowl
18-7949	Spin-on replacement Fits: 660RRAC02	Racor S3232	18-7943 •	Filter & Metal Bowl, Contains: 18-7920 filter & 18-7924 bowl
			18-7969 •	Filter & Metal Bowl, Contains: 18-7948 filter & 18-7924 bowl

- Display Packaged



18-7919
FUEL/WATER SEPARATING FILTER
Replaces: Mercruiser 35-809097, 35-8M0103095 and Racor™ S3213
 For styles with spin on drain bowls



18-8955
FUEL WATER SEPARATOR COVER
Fits: 18-7944 & 18-7945 sized filter



18-7784
FUEL FILTER
Replaces: Mercruiser 35-11004A1, 35-803897Q1
For: 2.5L/3.0L(6229718 & later), All MC224 CID (6218037 & later), All GM 262 CID (A331455 & later) with Carter Fuel Pumps



18-7977
"GEN III COOL FUEL SYSTEM" FUEL FILTER
Replaces: 35-866171A01
For: 350 Mag MPI Alpha/Bravo, 350 Mag MPI Horizon Alpha/Bravo, 350 Mag MPI Horizon MIE, 350 Mag MPI MIE, 496 MAG, 496 MAG H.O., 5.0 MPI Alpha/Bravo, 8.1L Inboard, 8.1L Inboard H.O., MX 6.2L MPI Alpha/Bravo, MX 6.2L MPI Horizon Alpha/Bravo, MX 6.2L MPI Horizon MIE, MX 6.2L MPI MIE



18-7964-1
TRANSMISSION FILTER KIT
Replaces: 35-815419, 8791014241, 879194241, 35-813405A1, 35-813405, F19608751, FFF001138
For: Mercruiser V-8 Inboard with Hurth Transmission



18-7855
FUEL FILTER
Replaces: 1397-2150
 Rochester Carb inlet



18-7717
FILTER ELEMENT
Replaces: 35-93568
For: Rochester 2 bbl & 4 bbl Carburetors



18-7859
FUEL FILTER
Replaces: 35-53336, 3302-9033, 35-53336Q
For: Most GM Inline 4 & 6 cycle, Ford & Gm V-8's up to 400 HP and all Mercruiser 224 CID



18-7721
FUEL FILTER
Replaces: 35-864572
 All MPI & EFI engines with boost pump, 8.1L & 496cid, for 3/8" ID fuel lines



18-7860
FUEL FILTER
Replaces: 35-49088A2, 35-49088Q2, 35-49088, F18390006
 (Used in 18-7278 Fuel Pump)
For: Inline 4 & 6 cycle engines



18-7869
FUEL FILTER ASSEMBLY
 Uses filter 18-7859
Replaces: 1397-8767, 1397-8545
For:

Model/HP	Serial #
GM 2.5L/3.0L	6229718 & later
GM 5.0L/5.7L	6218462 & later
All 205	A331455 & later
228 HP	6021784 & later
330 HP	6083145 & later
GM 255	590768 & later
5.7L SKI 340,230 & 260 Inboards	ALL



18-7873
FUEL FILTER
Replaces: 35-808275
For: Models D7.3/270 Bravo & MIE Diesel Engines 1994-96



18-7715
FUEL FILTER
Replaces: 35-892665
Fits: Mercruiser V-8 using Gen III Cool Fuel Systems



18-79901
VST FILTER
Replaces: 65L-13915-00-00
Fits: 454 EFI(GenV) GM 1994-96, 454 EFI (SKI)(Gen V) GM 1995, 454 Mag Bravo MPI (Gen VI) GM 1996-97, 454 Mag MPI (SKI)(Gen VI) GM 1996-97, 502 EFI (Gen V) GM 1993-95, 502 Mag MPI (Gen VI) GM 1996, 7.4L MIE MPI (LH) Gen V GM 1995-96, 7.4L MIE MPI (LH) Gen VI GM 1996-97, 7.4LX Bravo MPI (Gen V) GM 1996, 7.4LX Bravo MPI (Gen VI) GM 1996-97, 8.2L MIE MPI (LH) Gen VI GM 1996-97



18-6457
COMPOSITE PULLEY
 Replaces: 807757T
 3" OD Serpentine for 13/16" width belt
 For: Late model GM V6 & V8 engines



18-3506
CIRCULATING PUMP
 Replaces: 46-879194401
 For: V6 MCM SN: 1A063240 (2007), Newer 4.3L w/o water bypass hole
 - CURRENT



18-3593
WATER PUMP
 Replaces: 33957, 37369, 52353, 65142, 65142A1, 814755, 880817, 884727, F2774666, F1100785, F1101079
 Late Model 4 cyl GM engines requiring hose fitting, GM Inline (4 & 6 Cyl.)



18-3577-2
CIRCULATING WATER PUMP (Bi-Directional)
 Replaces: 67859, 17670, 811573, 850454, 8504541, 878342, 850454002, 59972, 54534, 49139, F6269358, F1100997, F1101053
 For: Big block GM engines



18-3573
CIRCULATING WATER PUMP
 All 8.1L big-block GM engines
 Replaces: 883514, 883925
 For: Engines with composite timing cover



18-3584
CIRCULATING WATER PUMP
 Replaces: 71683A1, 883885, 71683, 58086, 56879
 Mercuriser 215 to 255 & 888
 For: Ford small block V-8 engines



18-3599-2
CIRCULATING WATER PUMP
 Replaces: 60658, 811841, 850399, 8503991, 17437, 878341, 850399002, 54793, 52226, 37951, 35341, F1101292, F1101208, F1100742
 For: GM V-6 & small block V-8 engines



18-3007
18-3007-10^①
IMPELLER
 Replaces: 47-89983, 4789983T
 For 60 HP



18-3016-1
IMPELLER KIT
 with gasket
 Replaces: 47-862232A2, 8M0104229
 For: Late-model Bravo & High Performance. Includes 350 Mag., 4.3L., 496 Mag., 5.0L., 8.1S and MX 6.2L



18-3017
18-3017-10^①
IMPELLER
 Replaces: 47-89984, 47-899842, 47-89984T3, 47-89984T4, 47-899844, 47-30221, 47-65960, 47-85460
 For all #1, R, MR, Alpha Units thru S/N D494568.
 Also for raw water pump on: 190 IB S/N 1564539-1720903 225 IB S/N 1539620-2278646



18-3056
18-3056-10^①
IMPELLER
 Replaces: 47-43026-2
 For: Alpha I-Generation 2 S/N D494569 & Above
 Mercuriser Vazer



18-3087
IMPELLER
 Replaces: 47-59362, 47-59362T



18-3109
WATER TUBE GUIDE
 Replaces: 23-29804, 23-29804T, 23-52928
 (used with 18-3116 Housing)



18-3110
WATER PUMP HOUSING BUSHING
 Replaces: 26-38970, 26-36557A1, 26-29677
 (Part of 18-3116 Housing)



18-3114
INSERT CUP
 Replaces: 48752, 48752T
 (Part of 18-3116 Housing)

① Discount shop pack of 10 - Priced per package

 <p>18-3117 IMPELLER PLATE Replaces: 32435, 324351, 30605 For: #1 Units thru S/N D494568</p>	 <p>18-3122 IMPELLER PLATE Replaces: 817276, 8172761, 8172763 For: Alpha I - Generation 2 S/N D494569 & Above</p>	 <p>18-3350 WEAR PLATE Replaces: 72778, 94576</p>		
 <p>18-3351 WEAR PLATE Replaces: 72777, 94916</p>	 <p>18-3293 IMPELLER KEY Replaces: 28-43037</p>	 <p>18-3151 COUPLING Replaces: 816597</p>		
 <p>18-3417 WATER PUMP BASE Replaces: 46-57234A1</p>	 <p>18-3420 WATER PUMP BASE Replaces: 46-44292A3, 46-44292Q03, 46-44292T1</p>	 <p>18-3421 WATER PUMP BASE Replaces: 46-48748A1</p>		
 <p>18-3116 WATER PUMP HOUSING Replaces: 46-96148, 46-96148A1, 46-96148T1, 46-64141A1, 46-48743A1</p>	<p>PKG. OF 2</p>  <p>18-2732 18-2732-9① WATER SHUTTER Replaces: 807166A3</p>	 <p>18-2733 WATER SHUTTER Replaces: 92802, 99370A2</p>		
 <p>18-2727 EXHAUST WATER SHUTTER Replaces: 60930</p>	 <p>18-3220 WATER TUBE Replaces: 32-54236 For: #1 -R/MR/Alpha</p>	 <p>18-3221 WATER TUBE Replaces: 32-814384, 32-860220 For: Gen II</p>		
 <p>18-3222 WATER TUBE GUIDE Replaces: 23-816583 For: Gen II</p>	<p>PKG. OF 5</p>  <p>18-3226 18-3226-9① IMPELLER PUMP SCREW Replaces: 10-30720 For: R units</p>	<p>PKG. OF 5</p>  <p>18-3227 18-3227-9① WATER PUMP DOWEL PIN Replaces: 17-35973 For: R/MR, Alpha I</p>	<p>PKG. OF 5</p>  <p>18-3229 18-3229-9① WATER POCKET SCREW Replaces: 10-28668 For: MR/Alpha</p>	 <p>18-3197 SCREW Replaces: 10-76156, 10-67373</p>

① Priced per Package



18-3160-1
SEA WATER PUMP, BRASS
Replaces: 46-862914A13
 Uses impeller **18-3016-1**



18-3600
SEA WATER PUMP
Replaces: 46-72774A32, 46-72774A11, 46-73823A7, 46-63450A2, 46-59112A2
Fits: V8 Engines w/ith V-Belt and 2 piece pump
 Use repair kit **18-3155**



18-36001
SEA WATER PUMP
Replaces: 46-807151A12
Fits: V6 & V8 engines with v-belt and 1 piece pump
 Use repair kit **18-3237**



18-3155
WATER PUMP REPAIR KIT
Replaces: 47-72774A89
Fits: Bravo Seawater Pump with 2 piece housing



18-3216
IMPELLER KIT
Replaces: 47-59362A4
Fits: 1996-97 7.4L MIE MPI(LH) Gen VI GM 454 V8, 1996-97, 7.4L TBI MIE(LH) Gen VI GM 454 V8, 1996-97 8.2L MIE MPI(LH) Gen VI GM 502 V8



18-3318
WATER PUMP KIT
Replaces: 47-59362Q08
Fits: Plastic 1 and 2 piece sea water pump body



18-3237
IMPELLER REPAIR KIT
For: Bravo I, II, III (1988 & up) B664190 & up
Fits: Bravo drives with 1 piece housing

—CONTAINS—

Part #	Desc.	O.E. #	Qty.
18-3087	Impeller	47-59362	1
18-3350	Wear Plate	94576	1
18-7163	O-Ring	25-33465	1



18-3214
IMPELLER REPAIR KIT
Replaces: 47-43026T6, T8, T11
For: Alpha I - Generation II S/N D494569 & Above
 Mercuriser Vazer
For same kit with upper housing, order 18-3147

① **18-3214D** [Display Package](#)

—CONTAINS—

Part #	Desc.	O.E. #	Qty.
18-2564	Impeller Gasket	22-43033-1, 27-43033-1	1
18-2565	Impeller Gasket	27-43047-1	1
18-2566	Impeller Gasket	27-817277	1
18-2944	Seal Ring	26-45577, 26-45577B, 26-45577B1	1
18-3056	Impeller	47-43026-1, 47-43026-2	1
18-3122	Impeller Plate	817276	1
18-7420	O-Ring	25-21836	2



18-3217
IMPELLER KIT
For: #1 Units thru S/N D494568
 (Similar to #46-96148A5 without base or housing)

① **18-3217D** [Display Package](#)

—CONTAINS—

Part #	Desc.	O.E. #	Qty.
18-3109	Water Tube	23-29804	1
18-3017	Impeller	47-89984	1
18-2919	Water Pump Base to Gear Housing Gasket	27-42631-1	1
18-3110	Grommet	26-38970	1
18-2945	Gear Housing Drain Screw Gasket	12-19183	2
18-2826	Water Pump Base to Gear Housing Gasket	27-85610-1	1
18-2914	Lower Water Pump to Wear Plate Gasket	27-85608-1	1
18-2915	Upper Water Pump to Wear Plate Gasket	27-85609-1	1
18-2944	Seal Ring	26-45577	1
18-3117	Plate	32435	1
18-7158	O-Ring	25-30613	1
18-7162	O-Ring	25-33145	1
18-7173	O-Ring	25-30224	1
18-7176	O-Ring	25-90011	1
18-2801	Water Pump Gasket	27-32438	1
18-7196	O-Ring	25-38099	1
18-7426	O-Ring	35-30271	1



18-3150
WATER PUMP KIT
Replaces: 46-807151A14, 46-807151A7
For: Bravo



18-3309
WATER PUMP KIT
For: Bravo

—CONTAINS—

Part #	Desc.	O.E. #	Qty.
18-3350	Wear Plate	94576	1
18-3351	Wear Plate	94916	1
18-3087	Impeller	47-59362	1
18-0386	Body Gasket	27-94914	2
18-0916	Water Pump Gasket	27-805215-1	1



18-3147
WATER PUMP KIT
Replaces: 817275T4, 817275K05
For: Gen II-Lower s/n D469859 and Up
For same kit without upper housing, order 18-3214

① Items ending in "D" are Display Packaged - Regular number is Non-Display

—CONTAINS —

Part #	Desc.	O.E. #	Qty.
18-3109	Water Tube	23-29804	1
18-3017	Impeller	47-89984	1
18-3116	Housing	46-96148A1	1
18-2919	Water Pump Base to Gear Housing Gasket	27-42631-1	1
18-3110	Grommet	26-38970	1
18-2945	Gear Housing Drain Screw Gasket	26-20260, 12-19183	2
18-2826	Water Pump Base to Gear Housing Gasket	27-85610-1	1
18-2914	Lower Water Pump to Wear Plate Gasket	27-85608-1	1
18-2915	Upper Water Pump to Wear Plate Gasket	27-85609-1	1
18-2944	Seal Ring	26-45577	1
18-3117	Plate	32435	1
18-7158	O-Ring	25-30613	1
18-7162	O-Ring	25-33145	1
18-7173	O-Ring	25-30224	1
18-7176	O-Ring	25-90011	1
18-2801	Water Pump Gasket	27-32438	1
18-7196	O-Ring	25-38099	1
18-7426	O-Ring	35-30271	1



**18-3517
WATER PUMP KIT
Without Base**
Replaces: 46-96148A5, 46-60367A1, 46-96148A8

—CONTAINS —

Part #	Desc.	O.E. #	Qty.
18-3109	Water Tube	23-29804	1
18-3017	Impeller	47-89984	1
18-3116	Housing	46-96148A1	1
18-3420	Water Pump Base	46-44292A3	1
18-2919	Water Pump Base to Gear Housing Gasket	27-42631-1	1
18-3110	Grommet	26-38970	1
18-2945	Gear Housing Drain Screw Gasket	12-19183	2
18-2826	Water Pump Base to Gear Housing Gasket	27-85610-1	1
18-2914	Lower Water Pump to Wear Plate Gasket	27-85608-1	1
18-2915	Upper Water Pump to Wear Plate Gasket	27-85609-1	1
18-2944	Seal Ring	26-45577	1
18-3117	Plate	32435	1
18-7158	O-Ring	25-30613	1
18-7162	O-Ring	25-33145	1
18-7173	O-Ring	25-30224	1
18-7176	O-Ring	25-90011	1
18-2801	Water Pump Gasket	27-32438	1
18-7196	O-Ring	25-38099	1
18-7426	O-Ring	35-30271	1



**18-3320
WATER PUMP KIT**
For: MR/Alpha I Units
S/N 6854393-OD469858

—CONTAINS —

Part #	Desc.	O.E. #	Qty.
18-3109	Water Tube	23-29804	1
18-3017	Impeller	47-89984	1
18-3116	Housing	46-96148A1	1
18-3421	Water Pump Base	46-48748A1	1
18-2919	Water Pump Base to Gear Housing Gasket	27-42631-1	1
18-3110	Grommet	26-38970	1
18-2945	Gear Housing Drain Screw Gasket	12-19183	2
18-2826	Water Pump Base to Gear Housing Gasket	27-85610-1	1
18-2914	Lower Water Pump to Wear Plate Gasket	27-85608-1	1
18-2915	Upper Water Pump to Wear Plate Gasket	27-85609-1	1
18-2944	Seal Ring	26-45577	1
18-3117	Plate	32435	1
18-7158	O-Ring	25-30613	1
18-7162	O-Ring	25-33145	1
18-7173	O-Ring	25-30224	1
18-7176	O-Ring	25-90011	1
18-2801	Water Pump Gasket	27-32438	1
18-7196	O-Ring	25-38099	1
18-7426	O-Ring	35-30271	1



**18-3321
WATER PUMP KIT**
For: #1 Units with flush
S/N 2495186-2763441

—CONTAINS —

Part #	Desc.	O.E. #	Qty.
18-3109	Water Tube	23-29804	1
18-3017	Impeller	47-89984	1
18-3116	Housing	46-96148A1	1
18-2919	Water Pump Base to Gear Housing Gasket	27-42631-1	1
18-3417	Water Pump Base	46-57234A1	1
18-3110	Grommet	26-38970	1
18-2945	Gear Housing Drain Screw Gasket	12-19183	2
18-2826	Water Pump Base to Gear Housing Gasket	27-85610-1	1
18-2914	Lower Water Pump to Wear Plate Gasket	27-85608-1	1
18-2915	Upper Water Pump to Wear Plate Gasket	27-85609-1	1
18-2944	Seal Ring	26-45577	1
18-3117	Plate	32435	1
18-7158	O-Ring	25-30613	1
18-7162	O-Ring	25-33145	1
18-7173	O-Ring	25-30224	1
18-7176	O-Ring	25-90011	1
18-2801	Water Pump Gasket	27-32438	1
18-7196	O-Ring	25-38099	1
18-7426	O-Ring	35-30271	1
18-2919	Water Pump Gasket	27-46231-1	1



**18-3317
WATER PUMP KIT**
For: #1/R Units without flush
S/N 2763442-6854392

COMPLETE WATER PUMP KIT, IMPELLER REPAIR KIT, IMPELLER APPLICATION

Model	Serial No.	Complete Water Pump Kit	Upper Pump Housing	Upper Pump Kit	Water Pump Base	Impeller Repair Kit (no housing)	Impeller
#1 Units with plastic flush screw in gear housing	2495186 - 2763441	18-3321	18-3116	18-3517	18-3421	18-3217	18-3017
#1 Units w/o flush screw in gear housing	2763442 - 6854392	18-3317 ①	18-3116	18-3517	18-3417 ①	18-3217	18-3017
MR/ALPHA I	6854393 - OD594568	18-3320	18-3116	18-3517	18-3420	18-3217	18-3017
ALPHA I - Generation II & Vazer	0D494569 & ABOVE	18-3147	—	18-3570	—	18-3214	18-3056
BRAVO/Inboards w/ Plastic pump body	3040411 & ABOVE	—	—	18-3150	—	18-3318	18-3087
BRAVO/Inboards w/ Brass pump body	0M100001 & ABOVE	—	—	18-3160-1	—	18-3016-1	—

① Models which have been retro-fitted with an Alpha style lower unit (no pre-load pin in top of driveshaft) must use Alpha style parts (18-3320 and 18-3420)

GENERATION II WATER PUMP ASSEMBLY

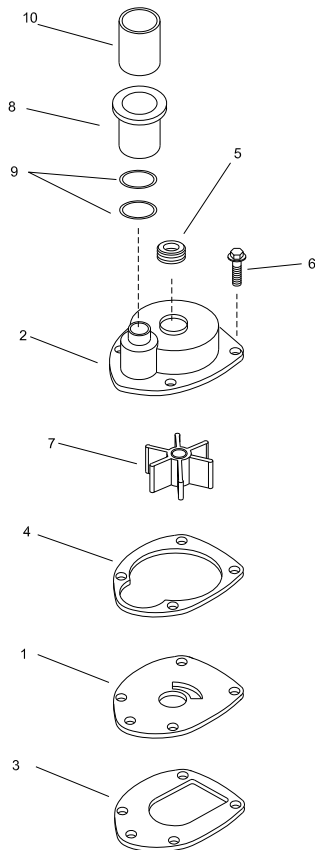

Sequence	Description	Part No.	O.E. #	Qty.
1	Face Plate	18-3122	817276	1
2	Housing Assembly	N.S.S.	817275A1	1
3	Gasket, Base	18-2564	27-43033-1	1
4	Gasket, Housing	18-2566	27-817277	1
5	Seal, Face	18-2599	26-816575A2	1
6	Screw, Housing	N/A	10-816928	4
7	Impeller	18-3056	47-43026-2	1
8	Coupling Assembly	18-3151	47-43026T11	1
9	O-Ring	18-7420	25-21836	2
10	Sleeve	18-3222	23-816583	1

MR ALPHA WATER PUMP ASSEMBLY

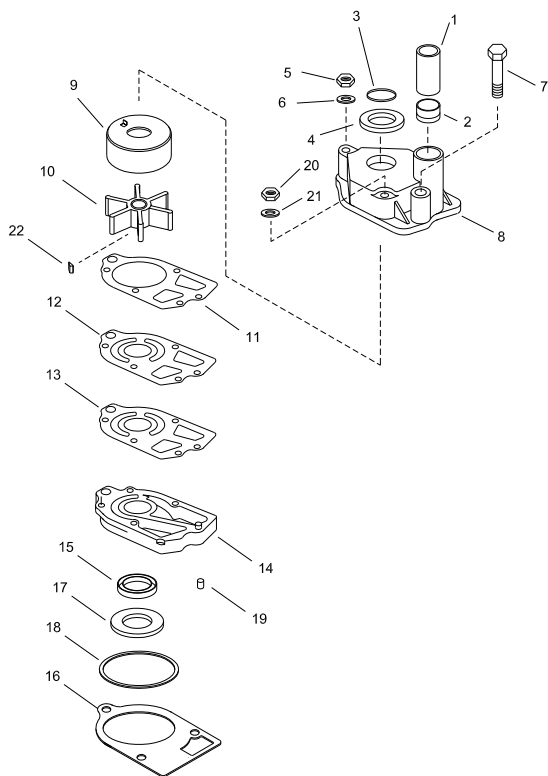

Sequence	Description	Part No.	O.E. #	Qty.
1	Guide Sleeve	18-3109	23-29804	1
2	Seal, Sleeve Guide	18-3110	26-38970	1
3	Ring, Upper	18-7158	25-30613	1
4	Ring, Dust	18-7426	25-30271	1
5	Nut, Housing	N/A	11-13436	1
6	Washer, Housing	18-4270	12-36001	3
7	Screw, Housing	N/A	10-96411	1
8	Housing, Water Pump	18-3116	46-96148A1	1
9	Cup, Impeller	18-3114	48752T	1
10	Impeller	18-3017	48752	1
11	Gasket, Impeller	18-2915	47-89984	1
12	Plate, Impeller	18-3117	27-85609-1	1
13	Gasket, Stainless Steel Plate	18-2914	27-85608-1	1
14	Water Pump Base Assembly	18-3420	46-44292A3	1
15	Oil Seal, Water Pump Base	18-2013	26-16977	1
16	Gasket, Water Pump Base	18-2919	27-42631-1	1
17	Oil Seal, Water Pump Base	18-2014	26-89238	1
18	O-Ring, Water Pump Base	18-7176	25-90011	1
19	Pin, Alignment	N/A	17-42836	1
20	Nut, Housing	N/A	11-13438	1
21	Washer, Housing	18-4275	12-29245	2
22	Key, Impeller	N/A	28-56654	1

R WATER PUMP ASSEMBLY

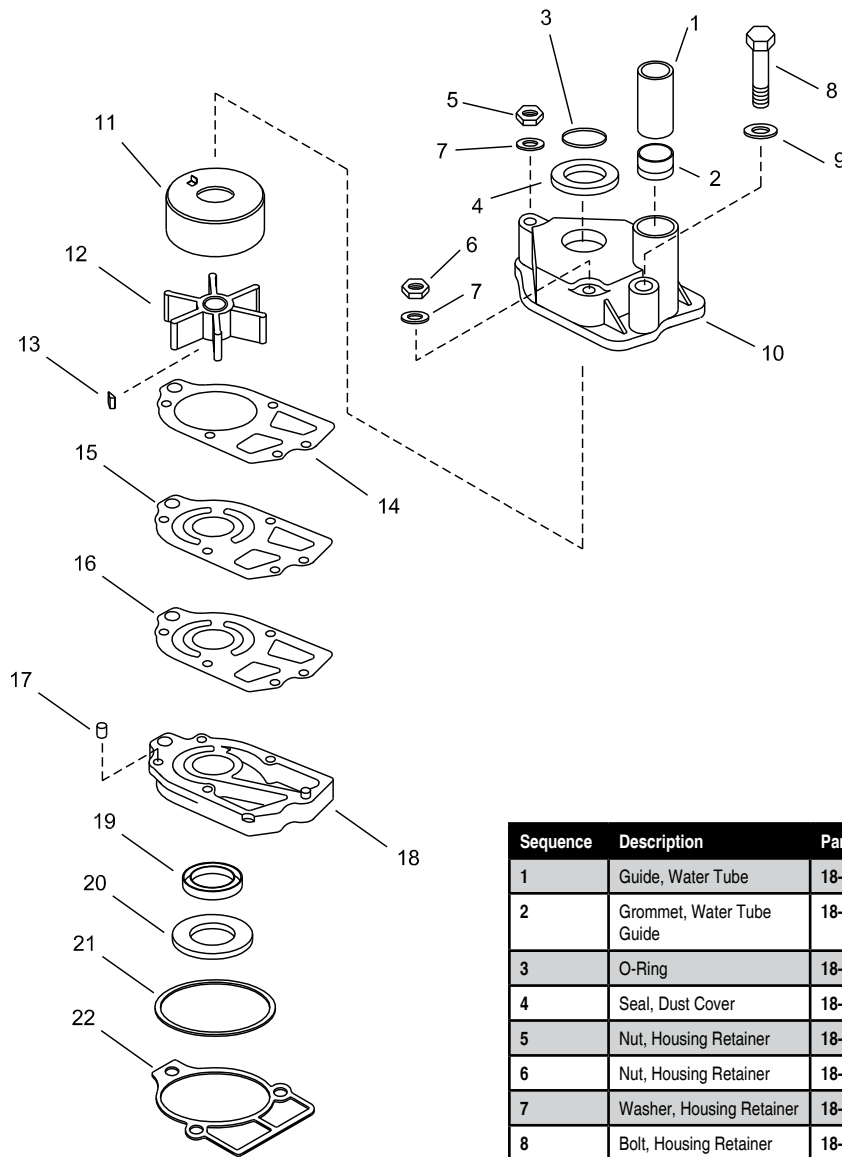

Sequence	Description	Part No.	O.E. #	Qty.
1	Guide, Water Tube	18-3109	23-29804	1
2	Grommet, Water Tube Guide	18-3110	26-38970	1
3	O-Ring	18-7158	25-30613	1
4	Seal, Dust Cover	18-7426	25-30271	1
5	Nut, Housing Retainer	18-3723	11-45592	1
6	Nut, Housing Retainer	18-3722	11-20361, 11-35888	2
7	Washer, Housing Retainer	18-4275	12-29245	3
8	Bolt, Housing Retainer	18-3226	10-30720	1
9	Washer, Housing Retainer	18-4270	12-36001	1
10	Housing, Impeller	18-3116	46-96148A1	1
11	Cup, Impeller	18-3114	48752	1
12	Impeller	18-3017	47-89984	1
13	Key, Impeller	N/A	28-56654	1
14	Gasket, Impeller	18-2915	27-85609-1	1
15	Wear Plate, Impeller	18-3117	32435	1
16	Gasket Wear Plate	18-2914	27-85608-1	1
17	Pin, Alignment	18-3227	17-35973	1
18	Base Assembly	18-3417	46-57234A1	1
19	Oil Seal, Base Assembly	18-2013	26-16977	1
20	Oil Seal, Base Assembly	18-2014	26-89238	1
21	O-Ring, Base Assembly	18-7162	25-33145	1
22	Gasket, Base Assembly	18-2826	27-85610-1	1



**18-3549
THERMOSTAT**
Replaces: 14586
120°



**18-3550
THERMOSTAT**
Replaces: 59078, 59078A1
140°



**18-3551
THERMOSTAT**
Replaces: 32728, 35884, 59137,
59137A1, 8072521, 8072531,
807252T1, 8M0089715
142°



**18-3552
THERMOSTAT**
Replaces: 76270, 76270T
160°



**18-3555
THERMOSTAT**
Replaces: 99155A1,
99155T2
160°



**18-3557
THERMOSTAT**
Replaces: 47594
143°



**18-3649
THERMOSTAT**
Replaces: 8072522, 807252T2,
8052732, 8M0091470
160°



**18-43015
THERMOSTAT**
Replaces: Mercury 864493
Fits: Mercruiser MCM 4.3L MPI, 5.0L
MPI and MX6.2L w/dry joint exhaust
and closed cooling



**18-43017
THERMOSTAT**
Replaces:
Mercury 863358T, 8M0074922, 8M0076464
Fits: Mercruiser 496 Mag & HO,
8.1L MIE & HO



**18-3568
THERMOSTAT KIT**
Replaces: 99155T1

Model	Year	Serial #
5.7MIE	1998-2001	OL002003 & Up
MX6.2L MPI	2000-2001	OL680003 & Up
454 Horizon MIE	1998-2001	OL002200 & Up
502 Mag. MPI	1998-2001	OL017000 & Up



**18-3644
THERMOSTAT KIT**
—CONTAINS—

Part #	Description	O.E.#
18-3649	Thermostat 160°	807252T2
18-2553	Thermostat Cover Gasket	27-47510
18-2917	Thermostat Cover Gasket	27-53045-1



① 18-3646D



**18-3646
THERMOSTAT KIT**
Replaces: 807252Q3, 807252T6
—CONTAINS—

Part #	Description	O.E.#
18-3551	Thermostat	59137
18-2917	Thermostat Housing Gasket	27-53045-1, 27-33918
18-2844	Thermostat Cover Gasket	27-48818-1
18-2553	Thermostat Cover Gasket	27-47510
18-2834	Thermostat Cover Gasket	27-60208



① 18-3647D



**18-3647
THERMOSTAT KIT**
Replaces: 807252Q5, 807252T8
—CONTAINS—

Part #	Description	O.E.#
18-3649	Thermostat	807252-2
18-2844	Thermostat Cover Gasket	27-48818-1
18-2553	Thermostat Cover Gasket	27-33179-2
18-2553	Thermostat Cover Gasket	27-47510
18-7173	O-Ring	25-30224
18-2917	Thermostat Housing Gasket	27-53045-1, 27-33918



① 18-3648D



**18-3648
THERMOSTAT KIT**
160°



① 18-3650D



**18-3650
THERMOSTAT KIT**
Replaces: 59078T3
—CONTAINS—

Part #	Description	O.E.#
18-2831	Thermostat Gasket	27-47590-1
18-3550	Thermostat	59078



① 18-3651D



**18-3651
THERMOSTAT KIT**
—CONTAINS—

Part #	Description	O.E.#
18-2554	Thermostat Cover Gasket	27-90556
18-2553	Thermostat Cover Gasket	27-47510
18-2834	Thermostat Cover Gasket	27-60208
18-2844	Thermostat Cover Gasket	27-48818-1
18-3551	Thermostat	59137



**18-3652
THERMOSTAT KIT**
—CONTAINS—

Part #	Description	O.E.#
18-2555	Thermostat Cover Gasket	27-89656-1
18-2843	Thermostat Cover Gasket	27-74830
18-3552	Thermostat	76270

THERMOSTAT APPLICATION BEGINS ON NEXT PAGE

① Items ending in "D" are Display Packaged - Regular number is Non-Display



**18-3667
THERMOSTAT KIT**
—CONTAINS—

Part #	Description	O.E.#
18-2555	Thermostat Cover Gasket	27-89656-1
18-3555	Thermostat	99155A1

① 18-3668D 



**18-3668
THERMOSTAT KIT**
Replaces: 807252T4, 807252Q4
—CONTAINS—

Part #	Description	O.E.#
18-2552	Thermostat Cover Gasket	27-33179-2
18-2553	Thermostat Cover Gasket	27-47510
18-2554	Thermostat Cover Gasket	27-41812
18-3551	Thermostat	59137
18-7173	O-Ring	25-30224
18-2917	Thermostat Housing Gasket	27-53045-1, 27-33918



**18-1977-1
THERMOSTAT HOUSING**
Replaces: 47441, 47441A1
Fits: 225, GM 260, 228, 898/198, 185R, 898R, 228R, 2GR



**18-1989
THERMOSTAT HOUSING**
Replaces: 8M0061381, 861006A1
Stainless Steel
Use 18-1989K Thermostat Service Kit for replacement parts



**18-1993
THERMOSTAT HOUSING**
Replaces: 78984A08, 78984A1, 78459A1, 59861A4, 59861A1



**18-1994
THERMOSTAT HOUSING**
Replaces: 87290A4
For: Stainless Steel Version use 18-1989



**18-3530-1
THERMOSTAT HOUSING**
Replaces: 860256A4, 860256A2
For: GM V6 and V8 (305 & 350 ci)



**18-3531
THERMOSTAT HOUSING**
Replaces: 807074A1, 808064A1, 861188A1
Fits: MCM/MIE GM V-6 & V-8 (305, 350, 454 & 502 cid) engines w/closed cooling systems



**18-1910
THERMOSTAT HOUSING KIT**
Replaces: 47587, 47587A2, 47588, 60372A1, 60372A2, 63908A2, 861493A07, 861493A3
Fits: 3.0L GM 1999-Up, S/N 0L340999-Lower



**18-1989K
THERMOSTAT SERVICE KIT**
Service Kit for 18-1989 Thermostat Housing



**18-1508
THERMOSTAT SEAL**
Replaces: 25-8071341
Fits: Vazer (2007 & UP), GM V6 & V8 with closed cooling systems (1996 & UP)

THERMOSTAT APPLICATION

Engine/Model	CID#CYL	Year Range	Beginning Serial #	Ending Serial #	Housing	Thermostat Cover	Thermostat & Gasket Kit	Thermostat	Gaskets Req.	Gaskets Req. - Design II	Gaskets Req. - Design III
ROVER			3140000	UP				18-3551			
60	68/L4	1965-1968	1887079	2049044				18-3551			
80	80/L4	1966-1969	2049045	2851423				18-3551			
90	96/L4	1970-1972	2851424	3226957				18-3557	18-2831		
100 VASER	98/L4	2007-2010	w995000	& UP					18-1508		
110	153/L4	1963-1966	1537370	2044033	①			18-3551			
110	153/L4	1963-1966	1821720	2044033	⑤			18-3551			
120	153/L4	1964-1972	1666601	3377340	④			18-3551			
120	153/L4	1964-1966	1725593	2046624	⑤			18-3551			
120	153/L4	1967	2046625	2324346	⑥			18-3551			
120	153/L4	1968-1972	2324347	3377340	18-3650 ⑤, ③		18-3650	18-3550	18-2831		
120	153/L4	1972-1986	3377341	B531853	18-3650 ③		18-3650	18-3550	18-2831		
2.5L	153/L4	1987-1989	B531854	C853255	18-3650 ③		18-3650	18-3550	18-2831		
140	181/L4	1968-1986	2508261	B450800	18-3650 ③		18-3650	18-3550	18-2831		
140 (6 CYL)			1538930	1725960	—			18-3551	—		

- ① Design I
- ② Design II
- ③ Design III
- ④ Aluminum Exhaust Manifold
- ⑤ Cast Iron Exhaust Manifold
- ⑥ Closed Cooling
- ⑦ Standard Cooling
- ⑧ With check ball
- ⑨ Without check ball
- ⑩ SN 4167000 & Up
- ⑪ Original thermostat housing listed as NLA. Order update kit 87290A23
- ⑫ Original thermostat housing listed as NLA. Order update kit 90736A24
- ⑬ Complete thermostat housing kit
- ⑭ Single and 3-point drain system
- ⑮ 7-point drain system
- ⑯ Mechanical Throttle Body
- ⑰ Digital Throttle Body
- ⑱ Emission Control Engine
- ⑲ Manual drain system
- ⑳ Air Actuated drain system
- Ⓐ Old Design
- Ⓑ New Design
- Ⓒ 160 degree
- Ⓓ For Stainless Steel version use 18-1989

THERMOSTAT APPLICATION (Cont.)

Engine/Model	CID#CYL	Year Range	Beginning Serial #	Ending Serial #	Housing	Thermostat Cover	Thermostat & Gasket Kit	Thermostat	Gaskets Req.	Gaskets Req. - Design II	Gaskets Req. - Design III
3.0L	181/L4	1987-1989	B450801	C856558	18-3650 ③		18-3650	18-3550	18-2831		
3.0L, FWC	181/L4	1990-2010	C856559	UP	⑥		18-3647	18-3649			
3.0L	181/L4	1990-1994	C856559	F603999	18-3650 ⑦, ③		18-3650	18-3550	18-2831		
3.0L	181/L4	2000-2010	L341000	& UP	⑦		18-3647	18-3649	18-2552		
3.0L	181/L4	1998-2000	L010042	L340999	18-3650 ⑦, ③		18-3650	18-3550	18-2831		
3.0L MPI	181/L4	2008-2010	A072812	& UP			18-3647	18-3649	18-2552		
3.0L MPI FWC	181/L4	2008-2010	A072812	& UP	⑥		18-3647	18-3649			
3.0LX, FWC	181/L4	1990-1997	C856559	K999999	⑥		18-3647	18-3649			
3.0LX	181/L4	1990-1997	C856559	K999999	18-1910 ⑦, ③		18-3650	18-3550	18-2831		
150			1666495	2048046	—			18-3551	—		
160	①		2048022	2770031	—			18-3551	—		
160	②		2048022	2233574	—			18-3557	—		
160	②		2326069	2770031	—			18-3557	18-2831		
165			2770032	5813433	—		18-3650	18-3550	18-2831		
165	224/L4	1987	B434941	B774251			18-3667	18-3555	18-2555		
165			6916779	UP	—		18-3667	18-3555	18-2555		
170	224/L4	1985-1986	6916779	B434940	18-3667		18-3667	18-3555	18-2555		
175/4.3L, 4.3LX (262 CID)	③		B527955	UP	—		18-3668	18-3551	18-2553	18-2554	
175/4.3L, 4.3LX (262 CID)	④		B527955	UP	—		18-3668	18-3551	18-2552	18-7173	
175/4.3L, 4.3LX (262 CID)	④		F001220	UP	—		18-3648	18-3649 ♣	18-2552	18-7173	
180/3.7L-LX (4 CYL)			6916779	UP	—		18-3667	18-3555	18-2555		
180	224/L4	1987	B436391	B775248			18-3667	18-3555	18-2555		
185 (229 CID)			6330183	6919655	18-1994 ♥		18-3668	18-3551	18-2553	18-2554	
185 (262 CID)			A331455	B527954	18-1994 ♥		18-3668	18-3551	18-2553	18-2554	
190			1564539	1730903	—			18-3551	—	—	
190	224/L4	1985-1986	6916779	B436390			18-3667	18-3555	18-2555		
3.7L	224/L4	1988-1989	B774552	& UP			18-3667	18-3555	18-2555		
3.7LX	224/L4	1988-1989	B775249	& UP			18-3667	18-3555	18-2555		
470 MCMME	224/L4	1976-1982	4208730	6218036				18-3552	18-2843		
470	224/L4	1983-1984	6218037	6916778			18-3667	18-3555	18-2555		
485	224/L4	1980-1982	5685394	6218036				18-3552	18-2555		
488	224/L4	1983-1984	6170297	6916778			18-3667	18-3555	18-2555		
140 (6 CYL)	194/L6	1963	1538930	1725960				18-3551			
150	230/L6	1964-1966	1666495	2048046	①			18-3551			
150	230/L6	1964-1966	1727985	2048046	⑤			18-3551			
160	250/L6	1967-1969	2048022	2770031	④			18-3551			
160	250/L6	1967	2048022	2233574	⑤			18-3551			
160	250/L6	1968-1969	2326096	2770031	18-1910 ⑥, ③			18-3557	18-2831		
165 (6 CYL)	250/L6	1970-1981	2770032	5813433	18-1910 ③		18-3650	18-3550	18-2831		
200 (6 CYL)	292/L6	1969	2453769	2712072	18-1910 ③			18-3557	18-2831		
185 (4bbl)	229-V-6	1983-1984	6330183	6919655	18-3678		18-3668	18-3551	18-2554	18-2553	18-2917
175	262/V-6	1987	B527955	B773242	18-1994 ①	18-1977-1	18-3668	18-3551	18-2554	18-2553	18-2917
175	262/V-6	1987	B527955	B773242	②, ⑤		18-3668	18-3551	18-7173		18-2917
185 (2bbl)	262/V-6	1985-1986	A331455	B527954	18-1994	18-1977-1	18-3668	18-3551	18-2554	18-2553	18-2917
205	262/V-6	1985-1986	A331455	B527954	18-3668	18-1977-1	18-3668	18-3551	18-2554	18-2553	18-2917
205	262/V-6	1987	B527955	B775129	18-3668 ①	18-1977-1	18-3668	18-3551	18-2554		18-2917
205	262/V-6	1967	B527955	B775129	②, ⑤		18-3668	18-3551	18-7173	18-2552	18-2917
205/4.3L, 4.3LX (262 CID)	④		B527955	D714369	— ⑦		18-3668	18-3551	18-2552	18-7173	
205/4.3L, 4.3LX (262 CID)	④		F001220	UP	—		18-3648	18-3649 ♣	18-2552	18-7173	

- ① Design I
- ② Design II
- ③ Design III
- ④ Aluminum Exhaust Manifold
- ⑤ Cast Iron Exhaust Manifold
- ⑥ Closed Cooling
- ⑦ Standard Cooling
- ⑧ With check ball
- ⑨ Without check ball
- ⑩ SN 4167000 & Up
- ⑪ Original thermostat housing listed as NLA. Order update kit 87290A23
- ⑫ Original thermostat housing listed as NLA. Order update kit 90736A24
- ⑬ Complete thermostat housing kit kit
- ⑭ Single and 3-point drain system
- ⑮ 7-point drain system
- ⑯ Mechanical Throttle Body
- ⑰ Digital Throttle Body
- ⑱ Emission Control Engine
- ⑲ Manual drain system
- ⑳ Air Actuated drain system
- ㉑ Old Design
- ♣ New Design
- ♣ 160 degree
- ♥ For Stainless Steel version use 18-1989

THERMOSTAT APPLICATION (Cont.)

Engine/Model	CID#CYL	Year Range	Beginning Serial #	Ending Serial #	Housing	Thermostat Cover	Thermostat & Gasket Kit	Thermostat	Gaskets Req.	Gaskets Req. - Design II	Gaskets Req. - Design III
215 FORD			2781153	3040410	—			18-3551	—	—	
215 FORD			3040411	UP	—		18-3651	18-3551	18-2834	—	
215 FORD MCOMMIE			3040411	3385720	—		18-3646	18-3649 ♣	18-2834	—	
225 FORD MCOMMIE			3385721	4176999	—		18-3646	18-3649 ♣	18-2834	—	
262 MAG EFI ALPHA	262V-6	1996-1997	0F803800	0K999999	18-3647		18-3647	18-3649	18-2917		
262 MAG EFI BRAVO	262V-6	1996-1997	0F803800	0K999999	18-3647		18-3647	18-3649	18-2917		
4.3L	262V-6	1988-1993	B773243	F000877	18-1994 ①	18-1977-1	18-3668	18-3551	18-2554	18-2553	18-2917
4.3L	262V-6	1987-1993	B773243	F000877	②, ③		18-3668	18-3551	18-7173	18-2552	18-2917
4.3L	262V-6	1993-1995	F000878	F601126	18-3647 ②, ③		18-3668	18-3649	18-2917	18-2552	18-2917
4.3L	262V-6	1993-1995	F000878	F601126	④		18-3668	18-3551	18-0398		
4.3L FWC	262V-6	1993-2002	F000878	M614999	18-3531 ⑤		18-3568	18-3555	18-0398		
4.3L ALPHA	262V-6	1996-2002	0F601127	M614999	18-3647 ⑦		18-3647	18-3649	18-2917		
4.3L BRAVO	262V-6	2996-2002	0F601127	M614999	18-3647 ⑦		18-3647	18-3649	18-2917		
4.3L FWC	262V-6	2002-2010	M615000	& UP	⑥				18-0398		
4.3L	262V-6	2002-2010	M615000	& UP	⑦		18-3647	18-3649	18-0398		
4.3L EFI FWC	262V-6	1998-2001	L012009	M299999	18-3531 ⑥		18-3568	18-3555	18-0398		
4.3L EFI ALPHA	262V-6	1998-2001	L012009	M299999	⑦		18-3647	18-3649	18-0398		
4.3L EFI BRAVO	262V-6	1998-2001	L012009	M299999	18-3530-1 ⑦		18-3647	18-3649	18-0398		
4.3L MPI	262V-6	2002-2010	M300000	& UP	⑦, ④		18-3647	18-3649	18-0398		
4.3L MPI	262V-6	2002-2010	M300000	& UP	⑦, ⑤		18-3647	18-3649	18-0398		
4.3L MPI EC	262V-6	2010-2011	A637496	& UP	⑦, ③		18-3647	18-3649	18-0398		
4.3L MPI FWC	262V-6	2002	M300000	M614999	⑥		18-3568	18-3555	18-0398		
4.3L MPI FWC	262V-6	2002-2010	M615000	& UP	⑥				18-0398		
4.3LH FWC	262V-6	1998-2002	L010044	M614999	18-3531 ⑥		18-3568	18-3555	18-0398		
4.3LH ALPHA	262V-6	1998-2002	L010044	M614999	⑦		18-3647	18-3649	18-0398		
4.3LH BRAVO	262V-6	1998-2002	L010044	M614999	18-3530-1 ⑦		18-3647	18-3649	18-0398		
4.3LX	262V-6	1988-1993	B775130	F001219	18-1994 ①	18-1977-1	18-3668	18-3551	18-2554	18-2553	18-2917
4.3LX	262V-6	1988-1993	B775130	F001219	②, ③		18-3668	18-3551	18-7173	18-2552	18-2917
4.3LX	262V-6	1993-1995	F001220	F601126	②, ③		18-3668	18-3551	18-7173	18-2552	18-2917
4.3LX	262V-6	1993-1995	F001220	F601126	④		18-3668	18-3551	18-0398		
4.3LX FWC	262V-6	1993-1997	F001220	K999999	⑥		18-3567	18-3555	18-0398		
4.3LX ALPHA	262V-6	1996-1997	F601127	K999999	⑦		18-3647	18-3649	18-0398		
4.3LX BRAVO	262V-6	1996-1997	F601127	K999999	18-3530-1 ⑦		18-3647	18-3649	18-0398		
4.3LXH FWC	262V-6	1996-1997	F803114	K999999	18-3531 ⑥		18-3568	18-3555	18-0398		
4.3LXH ALPHA	262V-6	1996-1997	F803114	K999999	18-3530-1 ⑦		18-3647	18-3649	18-0398		
4.3LXH BRAVO	262V-6	1996-1997	F803114	K999999	18-3530-1 ⑦		18-3647	18-3649	18-0398		
215 MCOMMIE (FORD)	302V-8	1970	2781153	3040410				18-3649			
215 MCOMMIE (FORD)	302V-8	1971-1972	3040411	3385720			18-3646	18-3551	18-2834		
225 MCOMMIE (FORD)	302V-8	1973-1974	3385721	4176999			18-3646	18-3551	18-2834		
888 (FORD)	302V-8	1971-1977	3108723	4887829	⑩		18-3646	18-3551	18-2834		
190	283V-8	1963-1964	1564539	1730903				18-3551			
198 MIE	305V-8	1977	4762210	6218461	18-1993						
198 MIE	305V-8	1977	4776402	4931099		18-1977-1	18-3646	18-3551	18-2844	18-0398	
200	305V-8	1985-1987	6899058	B774444	18-1994	18-1977-1	18-3668	18-3551	18-2554	18-2553	18-2917
200 GM			6218462	B525981	18-1994 ♥		18-3668	18-3551	18-2553	18-2554	
200/5.0L			0B525982	0F600999			18-3647	18-3649 ♣	18-2917	—	
200/5.0L GM	③		B525982	UP	18-1994 ♥		18-3668	18-3551	18-2553	18-2554	
200/5.0L GM	④		B525982	UP	18-1994 ♥		18-3648	18-3649 □	18-2552	18-7173	
228	305V-8	1977-1982	4765100	6218461	18-1993	18-1977-1	18-3646	18-3551	18-2844	18-0398	

- ① Design I
- ② Design II
- ③ Design III
- ④ Aluminum Exhaust Manifold
- ⑤ Cast Iron Exhaust Manifold
- ⑥ Closed Cooling
- ⑦ Standard Cooling
- ⑧ With check ball

- ⑨ Without check ball
- ⑩ SN 4167000 & Up
- ① Original thermostat housing listed as NLA. Order update kit 87290A23
- ② Original thermostat housing listed as NLA. Order update kit 90736A24
- ③ Complete thermostat housing kit
- ④ Single and 3-point drain system
- ⑤ 7-point drain system
- ⑥ Mechanical Throttle Body

- ⑦ Digital Throttle Body
- ⑧ Emission Control Engine
- ⑨ Manual drain system
- ⑩ Air Actuated drain system
- ♣ Old Design
- ♣ New Design
- ♣ 160 degree
- ♥ For Stainless Steel version use 18-1989

Thermostat Application (Cont.)

Engine/Model	CID#CYL	Year Range	Beginning Serial #	Ending Serial #	Housing	Thermostat Cover	Thermostat & Gasket Kit	Thermostat	Gaskets Req.	Gaskets Req. - Design II	Gaskets Req. - Design III
228	305V-8	1982-1984	6218462	6899268	18-1994	18-1977-1	18-3668	18-3551	18-2554	18-2553	18-2917
228 MIE	305V-8	1977-1980	4765100	5907057	18-3651, 18-1993	18-1977-1	18-3646	18-3551	18-2844	18-1993	
230	305V-8	1985-1987	6899269	B773739	18-1994	18-1977-1	18-3668	18-3551	18-2554	18-2553	18-2917
230 MIE	305V-8	1981-1987	5907058	B788151	18-1994 ⑦	18-1977-1	18-3668	18-3551	18-2554	18-2553	18-2917
230 MIE FWC	305V-8	1981-1987	5907058	B788151	⑥	18-1977-1	18-3646	18-3551	18-2553	18-2844	18-2917
230 GM			6218462	B525981	18-1994 ♥		18-3668	18-3551	18-2553	18-2554	
230 MIE			5907058	0B5225505			18-3646	18-3649 □	18-2553	18-2844	18-2917
230 GM IB	⑤		5907058	B522505	⑦		18-3668	18-3551	18-2553	18-2554	
230 GM IB	⑥		5907058	B522505	⑥		18-3651	18-3551	18-2553	18-2844	
230/5.0L GM IB	③ ⑤		B522506	B525981	⑧, ⑨		18-3668	18-3551	18-2553	18-2554	18-2917
230/5.0L GM IB	④ ⑤		B522506	B525981	▲, ⑦		18-3648	18-3649 □	18-2552	18-7173	18-2917
230/5.0L GM IB	⑥		B522506	B525981			18-3651	18-3551	18-2553	18-2844	18-2917
230/5.0L-LX GM	③		B525982	F600999	18-1994 ♥		18-3668	18-3551	18-2553	18-2554	
230/5.0L-LX GM	④		B525982	UP			18-3668	18-3551	18-2552	18-7173	
230/5.0L GM IB	④		B522506	B525981			18-3648	18-3649 □	18-2552	18-7173	
230/5.0L-LX GM			B525982	F600999	18-1994 ♥		18-3648	18-3649 □	18-2552	18-7173	
230/5.0L MIE			0B522506	0B788151			18-3646	18-3649 □	18-2553	18-2844	18-2917
230/5.0LX GM			0B525982	0F600999			18-3647	18-3649 □	18-2917	—	
5.0L	305V-8	1988-1995	B774445	F600999	18-1994 ①	18-1977-1	18-3668	18-3551	18-2554	18-2553	
5.0L	305V-8	1988-1995	B774445	F600999	②, ⑤		18-3668	18-3551	18-7173	18-2552	
5.0L	305V-8	1988-1995	B774445	F600999	②, ④		18-3668	18-3551	18-7173	18-2552	
5.0L	305V-8	1988-1995	B774445	F600999	③		18-3647	18-3649	18-0398		18-2917
5.0L (GEN+) FWC	305V-8	1998-2002	L015751	M599999	18-3531 ③		18-3568	18-3555	18-1508		18-2917
5.0L (GEN+) FWC	305V-8	2002-2010	M600000	& UP	⑥				18-0398		18-2917
5.0L (GEN+) ALPHA	305V-8	1998-2002	L015751	M599999	⑦		18-3647	18-3649	18-0398		
5.0L (GEN+) BRAVO	305V-8	1998-2002	L015751	M599999	18-3530-1 ⑦		18-3647	18-3649	18-0398		
5.0L (GEN+)	305V-8	2002-2010	M600000	& UP	⑦		18-3647	18-3649	18-0398		
5.0L EFI FWC	305V-8	1998-2001	L012052	M299999	18-3531 ③		18-3568	18-3555	18-1508		
5.0L EFI ALPHA	305V-8	1998-2001	L012052	M299999	⑦		18-3647	18-3649	18-0398		
5.0L EFI BRAVO	305V-8	1998-2001	L012052	M299999	18-3530-1 ⑦		18-3647	18-3649	18-0398		
5.0L MIE FWC	305V-8	1988	B788152	C396832	⑥	18-1977-1	18-3646	18-3551	18-2553	18-2844	
5.0L MIE	305V-8	1988	B788152	C396832	⑦, ⑧, ①		18-3668	18-3551	18-7173		
5.0L MIE	305V-8	1988	B788152	C396832	18-1994 ①, ②	18-1977-1	18-3668	18-3551	18-2554	18-2553	
5.0L MPI FWC	305V-8	2002	M300000	M599999	⑥		18-3568	18-3555	18-0398		
5.0L MPI FWC	305V-8	2002-2010	M600000	& UP	⑥				18-0398		18-2917
5.0L MPI FWC DTS	305V-8	2005-2010	W310000	& UP	⑥, ⑦				18-0398		18-2917
5.0L MPI FWC EC	305V-8	2008-2010	A300000	& UP	⑥, ⑥, ⑥				18-0398		
5.0L MPI FWC EC DTS	305V-8	2008-2010	A300000	& UP	⑥, ⑦, ⑧				18-0398		
5.0L MPI	305V-8	2002-2010	M300000	& UP	⑦, ④		18-3647	18-3649	18-0398		18-2917
5.0L MPI ALPHA	305V-8	2002	M300000	M599999	⑦, ⑤		18-3647	18-3649	18-0398		
5.0L MPI BRAVO	305V-8	2002	M300000	M599999	18-3530-1 ⑦, ⑤		18-3647	18-3649	18-0398		
5.0L MPI	305V-8	2002-2010	M600000	& UP	⑦, ⑤		18-3647	18-3649	18-0398		
5.0L MPI EC	305V-8	2008-2010	A300000	& UP	⑦, ⑥		18-3647	18-3649	18-0398		
5.0L LX	305V-8	1988-1995	B773740	F600999	18-1994 ①	18-1977-1	18-3668	18-3551	18-2554	18-2553	18-2917
5.0LX	305V-8	1988-1995	B773740	F600999	②, ⑤		18-3668	18-3551	18-7173	18-2552	
5.0LX	305V-8	1988-1995	B773740	F600999	③		18-3647	18-3649	18-0398		
898	305V-8	1977-1982	4762210	6218461		18-1977-1	18-3646	18-3551	18-2844	18-0398	
898	305V-8	1983-1984	6218462	6899057	18-1994	18-1977-1	18-3668	18-3551	18-2554	18-2553	

① Design I
 ② Design II
 ③ Design III
 ④ Aluminum Exhaust Manifold
 ⑤ Cast Iron Exhaust Manifold
 ⑥ Closed Cooling
 ⑦ Standard Cooling
 ⑧ With check ball
 ⑨ Without check ball
 ⑩ SN 4167000 & Up
 ⑪ Original thermostat housing listed as NLA. Order update kit 87290A23
 ⑫ Original thermostat housing listed as NLA. Order update kit 90736A24
 ⑬ Complete thermostat housing kit kit
 ⑭ Single and 3-point drain system
 ⑮ 7-point drain system
 ⑯ Mechanical Throttle Body
 ⑰ Digital Throttle Body
 ⑱ Emission Control Engine
 ⑲ Manual drain system
 ⑳ Air Actuated drain system
 ㉑ Old Design
 ㉒ New Design
 ㉓ 160 degree
 ㉔ For Stainless Steel version use 18-1989

Thermostat Application (Cont.)

Engine/Model	CID#CYL	Year Range	Beginning Serial #	Ending Serial #	Housing	Thermostat Cover	Thermostat & Gasket Kit	Thermostat	Gaskets Req.	Gaskets Req. - Design II	Gaskets Req. - Design III
225 (GM)	327V-8	1967-1969	2399198	2694014			18-1977-1	18-3651	18-3551	18-2553	18-2844
225 (GM)	327V-8	1963-1967	1539620	2399197	N.L.A.			18-3551			
225 (GM)			2278647	2399197				18-3668	18-3551	18-2552	18-7173
225/225S FORD			3385721	UP				18-3651	18-3551	18-2834	
250 MCMME	327V-8	1968-1969	2314301	2639854			18-1977-1	18-3651	18-3551	18-2553	18-2844
250	350V-8	1977	4768000	4908849	18-1993		18-1977-1	18-3651	18-3551	18-2844	
250 (GM)			4768000	4908849				18-3646	18-3551	18-2844	
250 (GM)			4175500	5907057	18-1993			18-3651	18-3649	18-2844	18-2917
255 (GM)	350V-8	1975-1976	4175500	4767999			18-1977-1	18-3646	18-3551	18-2844	18-0398
255 (GM) MIE	350V-8	1975-1980	4175500	5907057			18-1977-1	18-3646	18-3551	18-2844	18-0398
255 (GM) MIE	350V-8	1979-1980	5195909	5907057	18-1993						
255 FORD			3258728	UP				18-3651	18-3551	18-2834	—
255 FORD MCMME			3258728	4178299				18-3646	18-3649	18-2834	—
260	350V-8	1978-1982	4908850	6218461	18-1993		18-1977-1	18-3651	18-3551	18-2844	18-0398
260	350V-8	1982-1987	6218462	B773304	18-1994		18-1977-1	18-3668	18-3551	18-2554	18-2553
260 MIE FWC	350V-8	1981-1987	5907058	B788151	①		18-1977-1	18-3646	18-3551	18-2553	18-2844
260 MIE	350V-8	1981-1987	5907058	B788151	18-1994 ⑦		18-1977-1	18-3668	18-3551	18-2554	18-2553
260 GM			6218462	B525981	18-1994 ♥			18-3668	18-3551	18-2553	18-2554
260 GM			4908850	6218461				18-3646	18-3649	18-2844	18-2917
260 GM IB	⑤		5907058	B522505	⑦			18-3668	18-3551	18-2553	18-2554
260 GM IB	⑥		5907058	B522505	①			18-3651	18-3551	18-2553	18-2844
260 MIE			5907058	0B522505				18-3646	18-3649	18-2553	18-2844
260/5.7L GM IB	③ ⑤		B522506	B525981	⑦			18-3668	18-3551	18-2553	18-2554
260/5.7L GM IB	④ ⑤		B522506	B525981	① ⑦			18-3668	18-3551	18-2552	18-7173
260/5.7L GM IB	④ ⑤		B522506	B525981	① ⑦			18-3648	18-3649 ♣	18-2552	18-7173
260/5.7L GM IB	⑥		B522506	B525981	①			18-3651	18-3551	18-2553	18-2844
260/5.7L GM	③		B525982	F600999	18-1994 ♥			18-3668	18-3551 ⑧	18-2553	18-2554
260/5.7L GM	④		B525982	F600999				18-3668	18-3551 ♣	18-2552	18-7173
260/5.7L GM	④		B525982	F600999				18-3648	18-3649 ♣	18-2552	18-7173
260/5.7L GM			0B525982	0F600999				18-3647	18-3649	18-2917	—
260/5.7L MIE			0B522506	0F024999				18-3646	18-3649	18-2553	18-2844
270 MCMME	350V-8	1969-1972	2851074	3385720			18-1977-1	18-3646	18-3551	18-2553	18-2844
270 GM			2851074	3077735				18-3651	18-3551	18-2553	18-2844
280 GM	350V-8	1975-1976	4176250	4770199			18-1977-1	18-3646	18-3649	18-2844	18-0398
280 GM TRS			4176250	4770199	18-1993			18-3651	18-3551	18-2844	
300	350V-8	1985-1986	6668677	B430367			18-1977-1	18-3668	18-3551	18-2554	18-2553
320 EFI	350V-8	1987-1989	A543604	C622418			18-1977-1	18-3646	18-3551	18-2553	18-2844
325 GM MCMME			2278747	3780449				18-3646	18-3649	18-2553	18-2844
325 GM			2278747	2313964				18-3668	18-3551	18-2553	—
325 GM			2313965	3042730				18-3651	18-3551	18-2553	18-2844
325 GM			3042731	UP				18-3651	18-3551	18-2844	—
330 GM			4623115	UP				18-3651	18-3551	18-2844	—
330 GM MCMME			4623115	0B816540				18-3646	18-3649	18-2553	18-2844
330 GM W/BW	⑤		6083145	UP	⑦			18-3668	18-3551	18-2553	18-2554
330 GM W/BW	⑥		6083145	UP	①			18-3651	18-3551	18-2553	18-2844
350 MAG ALPHA	350V-8	1987-1995	B525982	F600999	②, ⑤			18-3668	18-3551	18-7173	18-2917
350 MAG ALPHA	350V-8	1986-1995	A635178	B525981	①		18-1977-1	18-3668	18-3551	18-2554	18-2553
350 MAG ALPHA	350V-8	1987-1995	B525982	F600999	②, ①			18-3668	18-3551	18-7173	18-2552
350 MAG ALPHA	350V-8	1987-1997	B525982	K999999	⑥			18-3647	18-3649	18-0398	

- ① Design I
- ② Design II
- ③ Design III
- ④ Aluminum Exhaust Manifold
- ⑤ Cast Iron Exhaust Manifold
- ⑥ Closed Cooling
- ⑦ Standard Cooling
- ⑧ With check ball

- ⑨ Without check ball
- ⑩ SN 4167000 & Up
- ⑪ Original thermostat housing listed as N.L.A. Order update kit 87290A23
- ⑫ Original thermostat housing listed as N.L.A. Order update kit 90736A24
- ⑬ Complete thermostat housing kit
- ⑭ Single and 3-point drain system
- ⑮ 7-point drain system
- ⑯ Mechanical Throttle Body

- ⑰ Digital Throttle Body
- ⑱ Emission Control Engine
- ⑲ Manual drain system
- ⑳ Air Actuated drain system
- Ⓔ Old Design
- ♣ New Design
- ♠ 160 degree
- ♥ For Stainless Steel version use 18-1989

THERMOSTAT APPLICATION (Cont.)

Engine/Model	CID#CVL	Year Range	Beginning Serial #	Ending Serial #	Housing	Thermostat Cover	Thermostat & Gasket Kit	Thermostat	Gaskets Req.	Gaskets Req. - Design II	Gaskets Req. - Design III
350 MAG ALPHA EFI (GEN +)	350V-8	1996-1997	F800300	K999999			18-3647	18-3649	18-0398		
350 MAG BRAVO MPI	350V-8	1995-1997	F415189	K999999	18-3530-1		18-3647	18-3649	18-0398		
350 MAG EFI SKI	350V-8	1994-1997	F215561	K999999	18-3530-1		18-3647	18-3649	18-0398		
350 MAG MPI FWC	350V-8	1998-2001	L010019	M299999	18-3531 ⑥		18-3568	18-3555	18-1508		
350 MAG MPI	350V-8	1998-2001	L010019	M299999	18-3530-1 ⑦		18-3647	18-3649	18-0398		
350 MAG MPI FWC	350V-8	2002	M300000	M599999	⑥		18-3568	18-3555	18-0398		
350 MAG MPI FWC	350V-8	2002-2010	M600000	& UP	⑤				18-0398		
350 MAG MPI FWC DTS	350V-8	2005-2010	W310000	& UP	⑥, ⑦				18-0398		
350 MAG MPI FWC EC	350V-8	2008-2010	A300000	& UP	⑥, ⑥, ⑥				18-0398		
350 MAG MPI FWC EC DTS	350V-8	2008-2010	A300000	& UP	⑥, ⑦, ⑧		N/A		18-0398		
350 MAG MPI	350V-8	2002	M300000	M599999	⑦, ④		18-3647	18-3649	18-0398		
350 MAG MPI ALPHA	350V-8	2002	M300000	M599999	⑦, ⑤		18-3647	18-3649	18-0398		
350 MAG MPI BRAVO	350V-8	2002	M300000	M599999	18-3530-1 ⑦, ⑤		18-3647	18-3649	18-0398		
350 MAG MPI	350V-8	2002-2010	M600000	& UP	⑦, ⑤		18-3647	18-3649	18-0398		
350 MAG MPI	350V-8	2002-2010	M600000	& UP	⑦, ④		18-3647	18-3649	18-0398		
350 MAG MPI EC	350V-8	2008-2010	A300000	& UP	⑦, ⑧		18-3647	18-3649	18-0398		
350 MAG MPI HORIZON	350V-8	2002	M300000	M599999	⑥		18-3568	18-3555	18-0398		
350 MAG MPI HORIZON	350V-8	2002-2007	M600000	A299999	⑥				18-0398		
350 MAG MPI HORIZON MIE	350V-8	1999-2001	L304700	M299999	18-3531 ⑥		18-3568	18-3555	18-1508		
350 MAG MPI HORIZON MIE	350V-8	2002	M300000	M316999	⑥		18-3568	18-3555	18-1508		
350 MAG MPI HORIZON MIE	350V-8	2002-2007	M317000	A089999	⑥				18-0398		
350 MAG MPI MIE FWC	350V-8	1998-2001	L002008	M299999	18-3531 ⑥		18-3568	18-3555	18-1508		
350 MPI MIE	350V-8	1998-2001	L002008	M299999	18-3530-1 ⑦		18-3647	18-3649	18-0398		
350 MAG MPI MIE FWC	350V-8	2002	M300000	M316999	⑥		18-3568	18-3555	18-1508		
350 MAG MPI MIE FWC	350V-8	2002-2007	M317000	A089999	⑥				18-0398		
350 MAG MPI MIE	350V-8	2002-2007	M300000	A089999	⑦		18-3647	18-3649	18-0398		
350 MAG MPI SKI	350V-8	1995-2001	F350583	M299999	18-3530-1		18-3647	18-3649	18-0398		
350 MAG MPI SKI	350V-8	2002-2007	M300000	A089999			18-3647	18-3649	18-0398		
350 MAG SKI	350V-8	1991-1996	D505450	K040399	②, ③		18-3668	18-3551	18-7173	18-2552	18-2917
350 MAG SKI	350V-8	1991-1997	D505450	K999999	18-3530-1 ③		18-3647	18-3649	18-0398		
5.7L	350V-8	1988-1995	B773305	F600999	18-1994 ①	18-1977-1	18-3668	18-3551	18-2554	18-2553	18-2917
5.7L	350V-8	1988-1995	B773305	F600999	②, ③		18-3668	18-3551	18-7173	18-2552	18-2917
5.7L	350V-8	1988-1995	B773305	F600999	②, ④		18-3668	18-3551	18-7173	18-2552	18-2917
5.7L	350V-8	1988-1996	B773305	K001526	③		18-3647	18-3649	18-2844	18-0398	
5.7L FWC	350V-8	1997	K001527	K999999	18-3531 ⑥		18-3568	18-3555	18-1508		
5.7L ALPHA	350V-8	1988-1997	B773305	F600999	⑦		18-3647	18-3649	18-0398		
5.7L BRAVO	350V-8	1995-1997	F601000	K999999	18-3530-1 ⑦		18-3647	18-3649	18-0398		
5.7L (GEN+) FWC	350V-8	1998-2002	L010037	M599999	18-3531 ⑥		18-3568	18-3555	18-1508		
5.7L (GEN+) ALPHA	350V-8	1998-2002	L010037	M599999	⑦		18-3647	18-3649	18-0398		
5.7L (GEN+) BRAVO	350V-8	1998-2002	L010037	M599999	18-3530-1 ⑦		18-3647	18-3649	18-0398		
5.7L (GEN+) FWC	350V-8	2002-2010	M600000	& UP	⑥				18-0398		
5.7L (GEN+)	350V-8	2002-2010	M600000	& UP	⑦		18-3647	18-3649	18-0398		
5.7L EFI FWC	350V-8	1995-1996	F225560	K001505	⑥		18-3647	18-3649	18-2844	18-0398	

- ① Design I
- ② Design II
- ③ Design III
- ④ Aluminum Exhaust Manifold
- ⑤ Cast Iron Exhaust Manifold
- ⑥ Closed Cooling
- ⑦ Standard Cooling
- ⑧ With check ball

- ⑨ Without check ball
- ⑩ SN 4167000 & Up
- ⑪ Original thermostat housing listed as NLA. Order update kit 87290A23
- ⑫ Original thermostat housing listed as NLA. Order update kit 90736A24
- ⑬ Complete thermostat housing kit kit
- ⑭ Single and 3-point drain system
- ⑮ 7-point drain system
- ⑯ Mechanical Throttle Body

- ⑰ Digital Throttle Body
- ⑱ Emission Control Engine
- ⑲ Manual drain system
- Ⓜ Air Actuated drain system
- Ⓝ Old Design
- ♣ New Design
- ♠ 160 degree
- ♥ For Stainless Steel version use 18-1989

THERMOSTAT APPLICATION (Cont.)

Engine/Model	CID#CYL	Year Range	Beginning Serial #	Ending Serial #	Housing	Thermostat Cover	Thermostat & Gasket Kit	Thermostat	Gaskets Req.	Gaskets Req. - Design II	Gaskets Req. - Design III
5.7L EFI FWC	350V-8	1997-2001	K001506	M299999	18-3531 ⑥		18-3568	18-3555	18-1508		
5.7L EFI ALPHA	350V-8	1995-2001	F355305	M299999	⑦		18-3647	18-3649	18-0398		
5.7L EFI BRAVO	350V-8	1995-2001	F225560	M299999	18-3530-1 ⑦		18-3647	18-3649	18-0398		
5.7L EFI MIE (GEN +) FWC	350V-8	1997	K040300	K999999	18-3531 ⑥		18-3568	18-3555	18-1508		
5.7L EFI MIE (GEN +)	350V-8	1997	K040300	K999999	18-3530-1 ⑦		18-3647	18-3649	18-0398		
5.7L MIE	350V-8	1988-1995	B788152	F600999	18-1994 ①	18-1977-1	18-3668	18-3551	18-2554	18-2553	18-2917
5.7L MIE	350V-8	1988-1995	B788152	F622099	⑦, ⑧		18-3668	18-3551	18-7173		18-2917
5.7L MIE	350V-8	1988-1995	B788152	F622099	⑦, ⑧		18-3668	18-3555	18-7173		18-2917
5.7L MIE FWC	350V-8	1988-1996	B788152	K04306	⑥		18-3647	18-3649	18-2844		
5.7L MIE FWC	350V-8	1997-2002	K040307	M316999	18-3531 ⑥		18-3568	18-3555	18-1508		
5.7L MIE	350V-8	1996-2002	F622100	M316999	⑦		18-3647	18-3649	18-0398		
5.7L MIE FWC	350V-8	2002-2010	M317000	& UP	⑥				18-0398		
5.7L MIE	350V-8	2002-2010	M317000	& UP	⑦		18-3647	18-3649	18-0398		
5.7L MPI HORIZON MIE	350V-8	2008-2010	A0900000	& UP	⑥				18-0398		
5.7L MPI MIE FWC	350V-8	2008-2010	A0900000	& UP	⑥				18-0398		
5.7L MPI MIE FWC DTS	350V-8	2008-2010	A0900000	& UP	⑥, ⑦				18-0398		
5.7L MPI MIE FWC EC	350V-8	2008-2010	A0900000	& UP	⑥, ⑥, ⑧				18-0398		
5.7L MPI MIE FWC EC DTS	350V-8	2008-2010	A0900000	& UP	⑦, ⑦, ⑧				18-0398		
5.7L MPI MIE	350V-8	2008-2010	A0900000	& UP	⑦		18-3647	18-3649	18-0398		
5.7L MPI MIE EC	350V-8	2008-2010	A0900000	& UP	⑦, ⑧		18-3647	18-3649	18-0398		
5.7L MPI SKI	350V-8	2008-2010	A0900000	& UP			18-3647	18-3649	18-0398		
5.7L MPI SKI EC	350V-8	2008-2010	A0900000	& UP	⑧		18-3647	18-3649	18-0398		
5.7L SKI	350V-8	1985-1995	A338553	F775199	18-1994 ①	18-1977-1	18-3668	18-3551	18-2554	18-2553	18-0398
5.7L SKI	350V-8	1987-1995	B514627	F775199	②, ⑤		18-3668	18-3551	18-7173		18-0398
5.7L SKI	350V-8	1987-1995	B514627	F775199	②, ⑤		18-3668	18-3551	18-7173		18-0398
5.7L SKI	350V-8	1996-2002	F775200	M316999	18-3530-1 ③		18-3647	18-3649	18-0398		
5.7L SKI	350V-8	2002-2010	M317000	& UP	⑦		18-3647	18-3649	18-0398		
5.7LX ALPHA	350V-8	1995-1997	F601000	K999999	⑦		18-3647	18-3649	18-0398		
5.7LX BRAVO	350V-8	1995-1997	F601000	K999999	18-3530-1 ⑦		18-3647	18-3649	18-0398		
5.7LX RWC	350V-8	1996	F601000	K001526	⑥		18-3647	18-3649	18-2844	18-0398	
5.7LX RWC	350V-8	1997	K001527	K999999	18-3531 ⑥		18-3568	18-3555	18-1508		
5.7LX BRAVO EFI (GEN +) FWC	350V-8	1996	F800300	K001508	⑥		18-3647	18-3649	18-2844	18-0398	
5.7LX BRAVO EFI (GEN +) FWC	350V-8	1997	K001509	K999999	⑥		18-3568	18-3555	18-0398		
5.7LX BRAVO EFI (GEN +)	350V-8	1996-1997	F800300	K999999	18-3530-1 ⑦		18-3647	18-3649	18-0398		
5.7LX EFI FWC	350V-8	1996	F752400	K001505	⑥		18-3647	18-3649	18-2844	18-0398	
5.7LX EFI FWC	350V-8	1997	K001506	K999999	18-3531 ⑥		18-3568	18-3555	13-0398		
5.7LX EFI ALPHA	350V-8	1996-1997	F752400	K999999	⑦		18-3647	18-3649	18-0398		
5.7LX EFI BRAVO	350V-8	1996-1997	F752400	K999999	18-3530-1 ⑦		18-3647	18-3649	18-0398		
5.7 GM ALPHA			F225560	0K999999			18-3647	18-3649	18-2917	—	
5.7 GM BRAVO			F225560	0K999999			18-3647	18-3649	18-2917	—	
5.7L/EFI GM ALPHA			L010037	UP			18-3647	18-3649	18-2917	—	
5.7L/EFI GM BRAVO			L010037	UP			18-3647	18-3649	18-2917	—	
5.7L MIE			F025000	0F622099			18-3647	18-3649	18-2844	—	
5.7L MIE			F622100	0K999999			18-3647	18-3649	18-2917	—	
5.7L MIE			F622100	0K999999			18-3647	18-3649	18-2844	—	
5.7L MIE			L002003	UP			18-3647	18-3649	18-2917	—	

- ① Design I
- ② Design II
- ③ Design III
- ④ Aluminum Exhaust Manifold
- ⑤ Cast Iron Exhaust Manifold
- ⑥ Closed Cooling
- ⑦ Standard Cooling
- ⑧ With check ball

- ⑨ Without check ball
- ⑩ SN 4167000 & Up
- ① Original thermostat housing listed as NLA. Order update kit 87290A23
- ② Original thermostat housing listed as NLA. Order update kit 90736A24
- ③ Complete thermostat housing kit kit
- ④ Single and 3-point drain system
- ⑤ 7-point drain system
- ⑥ Mechanical Throttle Body

- ⑦ Digital Throttle Body
- ⑧ Emission Control Engine
- ⑨ Manual drain system
- ⑩ Air Actuated drain system
- ⊖ Old Design
- ♣ New Design
- ♣ 160 degree
- ♥ For Stainless Steel version use 18-1989

THERMOSTAT APPLICATION (Cont.)

Engine/Model	CID#CYL	Year Range	Beginning Serial #	Ending Serial #	Housing	Thermostat Cover	Thermostat & Gasket Kit	Thermostat	Gaskets Req.	Gaskets Req. - Design II	Gaskets Req. - Design III
BLACK SCORPION SKI	350V-8	1996-2001	0F800000	M391599	18-3530-1		18-3647	18-3649	18-0398		
BLACK SCORPION SKI	350V-8	2003-2006	M391600	W690192	⑨		18-3647	18-3649	18-0398		
BLACK SCORPION SKI	350V-8	2006-2007	W690193	W698432	⑨		18-3647	18-3649	18-0398		
BLACK SCORPION SKI	350V-8	2003-2007	M391600	W698433	⑩		18-3647	18-3649	18-0398		
SCORPION 350	350V-8	2008-2010	W698433	& UP	⑨		18-3647	18-3649	18-0398		
SCORPION 350	350V-8	2008-2010	W698433	& UP	⑩		18-3647	18-3649	18-0398		
SCORPION 350 EC	350V-8	2008-2010	W698433	& UP	⑧		18-3647	18-3649	18-0398		
233 MCM (FORD)	351V-8	1975-1977	4173000	4902304			18-3646	18-3551	18-2834		
233 MIE (FORD)	351V-8	1975-1977	4173000	4902304			18-3646	18-3551	18-2834		
255 MCM (FORD)	351V-8	1973-1974	3258728	4178299			18-3646	18-3551	18-2834		
377 MAG FWC	377V-8	2008-2010	A300000	& UP	⑥, ⑥				18-0398		
377 MAG FWC DTS	377V-8	2008-2010	A300000	& UP	⑥, ⑦				18-0398		
377 MAG FWC EC	377V-8	2008-2010	A300000	& UP	⑥, ⑧				18-0398		
377 MAG FWC EC DTS	377V-8	2008-2010	A300000	& UP	⑥, ⑦, ⑧				18-0398		
377 MAG	377V-8	2008-2010	A300000	& UP	⑦, ④		18-3647	18-3649	18-0398		
377 MAG	377V-8	2008-2010	A300000	& UP	⑦, ⑤		18-3647	18-3649	18-0398		
377 MAG EC	377V-8	2008-2010	A300000	& UP	⑦, ⑧		18-3647	18-3649	18-0398		
377 SCORPION MCM	377V-8	1999-2005	L416146	M907201		18-1977-1		18-3551	18-0398		18-2553
377 SCORPION SKI	377V-8	1997-1998	K000656	L600314			18-3647	18-3649	18-0398		
MX 6.2L MPI FWC	377V-8	2000-2001	L680003	M299999	18-3531 ⑥		18-3568	18-3555	18-0398		
MX 6.2L MPI	377V-8	2000-2001	L680003	M299999	18-3530-1 ⑦		18-3647	18-3649	18-0398		
MX 6.2L MPI FWC	377V-8	2002	M300000	M599999	⑥		18-3568	18-3555	18-0398		
MX 6.2L MPI FWC	377V-8	2002-2007	M600000	A299999	⑥				18-0398		
MX 6.2L MPI	377V-8	2002-2007	M300000	A299999	⑦, ④		18-3647	18-3649	18-0398		
MX 6.2L MPI	377V-8	2002-2007	M300000	A299999	⑦, ⑤		18-3647	18-3649	18-0398		
MX 6.2L MPI HORIZON	377V-8	2002	M300000	M599999	⑥		18-3568	18-3555	18-0398		
MX 6.2L MPI HORIZON	377V-8	2002-2007	M600000	A299999	⑥				18-0398		
MX 6.2L MPI HORIZON MIE	377V-8	2002	M300000	M316999	⑥		18-3568	18-3555	18-0398		
MX 6.2L MPI HORIZON MIE	377V-8	2002-2010	M317000	& UP	⑥				18-0398		
MX 6.2L MPI MIE FWC	377V-8	1999-2002	L670000	M316999	⑥		18-3568	18-3555	18-0398		
MX 6.2L MPI MIE FWC	377V-8	2002-2010	M317000	& UP	⑥, ⑥				18-0398		
MX 6.2L MPI MIE FWC DTS	377V-8	2008-2010	A0900000	& UP	⑥, ⑦				18-0398		
MX 6.2L MPI MIE FWC EC	377V-8	2008-2010	A0900000	& UP	⑥, ⑥, ⑥				18-0398		
MX 6.2L MPI MIE FWC EC DTS	377V-8	2008-2010	A0900000	& UP	⑥, ⑦, ⑥				18-0398		
MX 6.2L MPI MIE	377V-8	2002-2010	M300000	& UP	⑦		18-3647	18-3649	18-0398		
MX 6.2L MPI MIE	377V-8	2008-2010	A0900000	& UP	⑦		18-3647	18-3649	18-0398		
MX 6.2L BLACK SCORPION	377V-8	2001-2002	L005601	M391599	18-3530-1		18-3647	18-3649	18-0398		
MX 6.2L BLACK SCORPION	377V-8	2003-2006	M391600	W690192	⑨		18-3647	18-3649	18-0398		
MX 6.2L BLACK SCORPION	377V-8	2006-2007	W690192	W698432	⑨		18-3647	18-3649	18-0398		
SCORPION 377	377V-8	2008-2010	W698433	& UP	⑨		18-3647	18-3649	18-0398		
SCORPION 377	377V-8	2008-2010	W698433	& UP	⑩		18-3647	18-3649	18-0398		
SCORPION 377 HO EC	377V-8	2008-2010	A091488	A092170	⑧		18-3647	18-3649	18-0398		
325 MCM (FORD)	427V-8	1969-1972	2278747	3780449			18-3646	18-3551	18-2553		18-0398

- ① Design I
- ② Design II
- ③ Design III
- ④ Aluminum Exhaust Manifold
- ⑤ Cast Iron Exhaust Manifold
- ⑥ Closed Cooling
- ⑦ Standard Cooling
- ⑧ With check ball

- ⑨ Without check ball
- ⑩ SN 4167000 & Up
- ① Original thermostat housing listed as NLA. Order update kit 87290A23
- ② Original thermostat housing listed as NLA. Order update kit 90736A24
- ③ Complete thermostat housing kit
- ④ Single and 3-point drain system
- ⑤ 7-point drain system
- ⑥ Mechanical Throttle Body

- ⑦ Digital Throttle Body
- ⑧ Emission Control Engine
- ⑨ Manual drain system
- ⑩ Air Actuated drain system
- ☐ Old Design
- ▲ New Design
- ♣ 160 degree
- ♥ For Stainless Steel version use 18-1989

THERMOSTAT APPLICATION (Cont.)

Engine/Model	CID#CYL	Year Range	Beginning Serial #	Ending Serial #	Housing	Thermostat Cover	Thermostat & Gasket Kit	Thermostat	Gaskets Req.	Gaskets Req. - Design II	Gaskets Req. - Design III
330 (WITH MERC TRANS)	454V-8	1977-1981	4623115	6083144			18-3646	18-3551	18-2844	18-0398	
330 (WITH BW) FWC	454V-8	1982-1987	6083145	B816540	①		18-3646	18-3551	18-2553		18-0398
330 (WITH BW)	454V-8	1982-1987	6083145	B816540	18-3678 ⑦		18-3668	18-3551	18-2554	18-2553	18-0398
330 MIE (WITH MERC TRANS)	454V-8	1977-1980	4623115	5889913			18-3646	18-3551	18-2844	18-0398	
340 MIE FWC	454V-8	1981-1987	5889914	B788365	①		18-3646	18-3551	18-2553	18-2844	18-0398
340 MIE	454V-8	1981-1987	5889914	B788365	18-3678 ⑦		18-3668	18-3551	18-2554	18-2844	18-0398
340 MIE	454V-8	1981-1987	5889914	B788365	⑦, ①		18-3668	18-3551	18-2554	18-2553	18-0398
340/7.4L MIE			5889914	0D715493			18-3646	18-3649	18-2553	18-2844	18-2917
350 MIE	454V-8	1974-1976	3780450	4623109			18-3646	18-3551	18-2844	18-0398	
350 GM (MAGNUM)			A635178	B525981			18-3668	18-3551	18-2553	18-2554	
350 GM (MAGNUM)	□		B525982	UP	⊞		18-3668	18-3551	18-2553	18-2554	
350 GM (MAGNUM)	□		B525982	UP	▲		18-3668	18-3551	18-2552	18-7173	
350 GM (MAGNUM)	□		B525982	UP	18-3648 ▲		18-3648	18-3649 □	18-2552	18-7173	
370	454V-8	1978-1985	4179554	6721527		18-1977-1	18-3646	18-3551	18-2553	18-2844	18-0398
370	454V-8	1985-1987	6721528	B714586			18-3668	18-3551	18-2554	18-2553	18-0398
370 TRS GM			4179554	6721527			18-3651	18-3551	18-2553	18-2844	
370 TRS GM			6721528	UP			18-3668	18-3551	18-2553	18-2554	
390 GM			2781129	2825059			18-3651	18-3551	18-2553	18-2844	
390 GM MCM/MIE			2781129	3042731			18-3646	18-3649	18-2553	18-2844	18-2917
400	454V-8	1980-1986	4179554	0B457644			18-3646	18-3551	18-2553	18-2554	18-0398
400 TRS GM			4179554	UP			18-3651	18-3551	18-2553	18-2844	
420 GM			A398941	UP	18-3651		18-3651	18-3551	18-2553	18-2844	
420	454V-8	1987-1989	A398941	B622418	18-1994	18-1977-1	18-3646	18-3551	18-2553	18-2844	18-0398
425	454V-8	1990-1993	A398941	D937011	18-3678			18-3551		18-2553	18-0398
440	454V-8	1983-1986	4179554	B485220			18-3646	18-3551	18-2553	18-2844	18-0398
450	454V-8	1995-1996	F347100	F347277	18-1994	18-1977-1		18-3551		18-2553	18-0398
525 SC	454V-8	1991-1999	D456000	L415623		18-1977-1		18-3551		18-2553	18-0398
454 MAG ALPHA	454V-8	1986-1988	A631894	B785148	18-3678 ①		18-3668	18-3551	18-2554	18-2553	18-0398
454 MAG ALPHA	454V-8	1986-1988	A631894	B785148	②, ③		18-3668	18-3551	18-7173	18-2552	18-3098
454 MAG BRAVO	454V-8	1988-1992	B721206	D805068	18-3678 ①		18-3668	18-3551	18-2554	18-2553	18-0398
454 MAG BRAVO	454V-8	1995-1997	F305000	K999999	②, ①		18-3647	18-3649	18-0398		
454 MAG BRAVO	454V-8	1988-1992	B721206	D805068	②, ①		18-3668	18-3551	18-7173		18-0398
454 MAG BRAVO	454V-8	1992-1994	D805069	F304999	②, ①		18-3668	18-3551	18-7173		18-0398
454 MAG EFI	454V-8	1995-1997	F115700	F802349	⑦		18-3647	18-3649	18-0398		
454 MAG EFI SKI	454V-8	1995-1997	F215800	K999999	⑦		18-3647	18-3649	18-0398		
454 MAG MPI	454V-8	1996-2001	F802350	M024999	⑦		18-3647	18-3649	18-0398		
454 MAG MPI FWC	454V-8	1998-2001	L010029	M024999	18-3531 ①		18-3568	18-3555	18-0398		
454 MAG MPI HORI-ZON MIE	454V-8	1998-2001	L002200	L674000	18-3531 ①		18-3568	18-3555	18-0398		
454 MAG MPI SKI	454V-8	1996-1997	F820100	K999999	⑦		18-3647	18-3649	18-0398		
525 SC	454V-8	1991-1999	D456000	L415623		18-1977-1		18-3551		18-2553	18-0398
7.4L BRAVO	454V-8	1995-1997	0F352000	0K999999	⑦		18-3647	18-3649	18-0398		
7.4L BRAVO	454V-8	1988-1991	B771113	D603117	18-3678 ①		18-3668	18-3551	18-2554	18-2553	18-0398
7.4L BRAVO	454V-8	1988-1991	B771113	D603117	②, ③		18-3668	18-3551	18-7173	18-2552	18-0398
7.4L BRAVO	454V-8	1992-1994	D603118	F351999	②, ①		18-3668	18-3551	18-7173	18-2552	18-0398
7.4L EFI MIE	454V-8	1996-1997	F874815	K999999	⑦		18-3647	18-3649	18-0398		
7.4L EFI MIE FWC	454V-8	1996-1997	F874815	K999999	18-3531 ①		18-3568	18-3555	18-0398		
7.4L MIE FWC	454V-8	1988-1992	B788366	D715493	①		18-3646	18-3551	18-2553	18-2844	18-0398

- ① Design I
- ② Design II
- ③ Design III
- ④ Aluminum Exhaust Manifold
- ⑤ Cast Iron Exhaust Manifold
- ⑥ Closed Cooling
- ⑦ Standard Cooling
- ⑧ With check ball

- ⑨ Without check ball
- ⑩ SN 4167000 & Up
- ⑪ Original thermostat housing listed as NLA. Order update kit 87290A23
- ⑫ Original thermostat housing listed as NLA. Order update kit 90736A24
- ⑬ Complete thermostat housing kit
- ⑭ Single and 3-point drain system
- ⑮ 7-point drain system
- ⑯ Mechanical Throttle Body

- ⑰ Digital Throttle Body
- ⑱ Emission Control Engine
- ⑲ Manual drain system
- ⑳ Air Actuated drain system
- ㉑ Old Design
- ㉒ New Design
- ㉓ 160 degree
- ㉔ For Stainless Steel version use 18-1989

THERMOSTAT APPLICATION (Cont.)

Engine/Model	CID#CVL	Year Range	Beginning Serial #	Ending Serial #	Housing	Thermostat Cover	Thermostat & Gasket Kit	Thermostat	Gaskets Req.	Gaskets Req. - Design II	Gaskets Req. - Design III
7.4L MIE	454V-8	1988-1992	B788366	D715493	⑦, ③		18-3668	18-3551	18-2554	18-2553	18-0398
7.4L MIE	454V-8	1989-1994	C391564	D715493	⑦		18-3668	18-3551	18-7173	18-2552	18-0398
7.4L MIE FWC	454V-8	1989-1994	C391564	D715493	③		18-3646	18-3551	18-2553	18-2844	18-0398
7.4L MIE	454V-8	1989-1994	D715494	F349999	⑦		18-3668	18-3551	18-7173	18-2552	18-0398
7.4L MIE FWC	454V-8	1989-1994	D715494	F820141	③		18-3646	18-3649	18-2553	18-2844	18-0398
7.4L MIE	454V-8	1995-1996	F350000	F820141	⑦		18-3647	18-3649	18-0398		
7.4L MIE	454V-8	1996-1997	F820142	K999999	⑦		18-3647	18-3649	18-0398		
7.4L MIE	454V-8	1996-1997	F820142	K999999	③		18-3647	18-3649	18-2844	18-0398	
7.4L MPI	454V-8	1998-2001	L010003	M024330	⑦		18-3647	18-3649	18-0398		
7.4L MPI MIE	454V-8	1995-2001	F563052	M025999	⑦		18-3647	18-3649	18-0398		
7.4L MPI MIE FWC	454V-8	1995-2001	F563052	M025999	③		18-3568	18-3555	18-0398		
7.4LX BRAVO EFI	454V-8	1996-1997	F820000	K999999	⑦		18-3647	18-3649	18-0398		
7.4L BRAVO MPI	454V-8	1996-1997	F602010	K999999	⑦		18-3647	18-3649	18-0398		
7.4L MIE			0C391564	0D715493			18-3646	18-3649	18-2553	18-2844	18-2917
7.4L MIE			0C391564	0F349999			18-3646	18-3649	18-2553	18-2844	18-2917
390 MCMME	482V-8	1969-1970	2781129	3042731			18-3646	18-3551	18-2553	18-2844	18-0398
460	482V-8	1983-1986	4179554	6181046			18-3668	18-3551	18-2554	18-2553	18-0398
465	502V-8	1990-1994	C849992	F213244	18-3678			18-3551		18-2553	18-0398
470			4208730	6218036			18-3652	18-3552	18-2843		
470			6218037	UP			18-3667	18-3555	18-2555	—	
485			5685394	UP			18-3652	18-3552	18-2555	—	
488			6170297	UP			18-3667	18-3555	18-2555	—	
500	502V-8	1994-1998	F213293	L001772	18-1994	18-1977-1		18-3551		18-2553	18-0398
500 (GEN +)	502V-8	1999	L414639	L601036	18-1994	18-1977-1		18-3551		18-2553	18-0398
500 EFI	502V-8	1999-2005	L001477	M907127		18-1977-1		18-3551		18-2553	18-0398
502 MAG	502V-8	1990-1993	C878221	F114528	③		18-3668	18-3551	18-7173	18-2552	18-0398
502 MAG EFI	502V-8	1993-1995	D840650	F802599	⑦		18-3647	18-3649	18-0398		
502 MAG MPI	502V-8	1996-1997	F802600	K999999	⑦		18-3647	18-3649	18-0398		
502 MAG MPI FWC	502V-8	1998-2001	L017000	M024999	18-3531 ③		18-3568	18-3555	18-0398		
525 EFI	502V-8	2003-2010	M900146	& UP			N/A		18-1508		
575 GM			0A677429	0D763716			18-3646	18-3649	18-2553	18-2844	18-2914
575			A677429	UP			18-3651	18-3551	18-2553	18-2844	
8.2L MAG	502V-8	2010	A350340	& UP					18-1508		
8.2L MIE EC	502V-8	2010	A350802	& UP					18-1508		
8.2L MIE	502V-8	1990-1992	C878221	D857199	⑦		18-3668	18-3551	18-7173	18-2552	18-0398
8.2L MIE FWC	502V-8	1990-1992	C878221	D857199	③		18-3668	18-3551	18-2553	18-2844	18-0398
8.2L MIE	502V-8	1993-1996	D857200	F350274	⑦		18-3647	18-3649	18-0398		
8.2L MIE	502V-8	1996	F350275	F819619	⑦		18-3647	18-3649	18-0398		
8.2L MIE FWC	502V-8	1993-1996	D857200	F819619	③		18-3647	18-3649	18-2844	18-0398	
8.2L MPI MIE	502V-8	1996-2001	F819620	L674200	⑦		18-3647	18-3649	18-0398		
8.2L MPI MIE FWC	502V-8	1996-2001	F819620	L674200	18-3531 ③		18-3568	18-3555	18-1508		
500 BULLDOG	540V-8	1990-2001	C577254	M050281	18-1994	18-1977-1		18-3551		18-2553	18-0398
888 FORD			3108723	UP			18-3651	18-3551	18-2834		
888 FORD MCM			3108723	4887829			18-3646	18-3649	18-2834		
898/198 GM			4762210	6218461			18-3651	18-3551	18-2844		
898/198 GM MCMME			4762210	6218461			18-3646	18-3649	18-2844	18-2917	
898 GM		1977-1982	4762210	6218461	18-1993						
898 GM			6218462	UP			18-3668	18-3551	18-2553	18-2554	

- ① Design I
- ② Design II
- ③ Design III
- ④ Aluminum Exhaust Manifold
- ⑤ Cast Iron Exhaust Manifold
- ⑥ Closed Cooling
- ⑦ Standard Cooling
- ⑧ With check ball

- ⑨ Without check ball
- ⑩ SN 4167000 & Up
- ⑪ Original thermostat housing listed as NLA. Order update kit 87290A23
- ⑫ Original thermostat housing listed as NLA. Order update kit 90736A24
- ⑬ Complete thermostat housing kit kit
- ⑭ Single and 3-point drain system
- ⑮ 7-point drain system
- ⑯ Mechanical Throttle Body

- ⑰ Digital Throttle Body
- ⑱ Emission Control Engine
- ⑲ Manual drain system
- ⑳ Air Actuated drain system
- Ⓜ Old Design
- ♣ New Design
- ♣ 160 degree
- ♥ For Stainless Steel version use 18-1989



18-7702
AIR CHARGE
TEMPERATURE SENDER
Replaces: 805223T
Fits: Mercruiser V6 & V8(350, 454, 496 & 502 cid)MPI engines



18-5897
SENDER
Replaces: 97257A1, 806490T, 97257, 806490, 811091, 36525
For Water Temperature
3/8" - 18 NPT



18-5898
SENDER
Replaces: 97258A1, 97258, 34625, F16900198, F16900152
For Water Temperature
1/2" -14 NPT



18-5899
OIL PRESSURE SENDER
Replaces: 90806, 815425T, 90806A1, 815425, 34623, 8M0068784
For Oil Pressure

TEMPERATURE SENDER/OIL SENDER APPLICATION

Model	Serial No.	Oil Pressure	Water Temperature	Model	Serial No.	Oil Pressure	Water Temperature
ROVER	3140000F & UP	—	18-5897	270	2851074-3077735	18-5899	18-5897
110	1565944-1566081	18-5899	18-5898	280	4176250 & UP	18-5899	18-5898
110	1602980 & UP	18-5899	18-5898	300 MR/TRS	6668677 & UP	18-5899 ②	18-5897 ②
120	2324346 & BELOW	18-5899	18-5898	320	A543604 & UP	18-5899 ②	18-5897 ②
120	2324347 & UP	18-5899 ① ②	18-5897 ②	325	2278747 & UP	18-5899	18-5897 ⑧ ⑨
140 (4 cyl/3.0)	2508061 - 3462607	18-5899 ②	18-5897 ②	330	4623115 & UP	18-5899	18-5898
140 (4cyl/3.0)	4512156 & UP	18-5899 ②	18-5897 ②	330/W.B.W.	6083145 & UP	18-5899 ②	18-5897 ②
3.0L/3.0LX	C856559 & UP	18-5899 ②	18-5897 ②	340/7.4L	5889914 & UP	18-5899 ②	18-5897 ②
140 (6 cyl)	1566119-1725960	18-5899	18-5898	350	3780450 & UP	18-5899	18-5898
150	1666495-2048046	18-5899	18-5898	350 (Magnum)	A635178- B525981	18-5899 ②	18-5897 ②
160	2048022-2770031	18-5899	18-5897 ④ ⑤	350 (Magnum)	B525982-0505449	—	18-5897 ② ⑥ ⑦
165	2770032 & UP	18-5899	18-5897	350 (Magnum)	D505450 & UP	18-5899 ②	18-5897 ②
165/3.7L/170/180	6916779 & UP	18-5899	—	370 (TRS)	4179554 & UP	18-5899 ②	18-5897 ②
175 (262 CID)	B527955 & UP	18-5899 ②	18-5897 ② ⑥ ⑦	390	2781129-2825059	18-5899	18-5897
4.3L (Generation II)	D714107 & UP	18-5899 ②	18-5897 ②	400	4179554 & UP	18-5899	18-5897
185 (229 CID)	6330183 & UP	18-5899 ②	18-5897 ②	420/425	A398941 & UP	18-5899 ②	18-5897 ②
185 (262 CID)	A331455 & UP	18-5899 ②	18-5897 ②	440	4179554 & UP	18-5899	18-5897
190	1504311-1730903	18-5899	18-5898	454 (Magnum)	A631894 & UP	18-5899 ②	18-5897 ②
190 (4 cyl)	6916779 & UP	18-5899	—	454 (Bravo)	B721206-D805068	18-5899 ②	18-5897 ② ⑥ ⑦
200	2453769-271202	18-5899	18-5897	460	4179554	18-5899	18-5897
200	6218462 & UP	18-5899 ②	18-5897 ②	465	C849992 & UP	18-5899 ②	18-5897 ②
200/5.0	B525982 & UP	—	18-5897 ② ⑥ ⑦	500	C577254 & UP	18-5899 ②	18-5897 ②
205 (262 CID)	A331455 & UP	18-5899 ②	18-5897 ②	502 (Bravo)	C878221 & UP	18-5899 ②	18-5897 ②
205 (4.3L)	B527955 & UP	18-5899 ②	18-5897 ② ⑥ ⑦	502 (Bravo Gen V)	D824589 & UP	—	18-5897
4.3LX (Generation II)	D714370 & UP	18-5899 ②	18-5897 ②	525	D456000 & UP	18-5899 ②	18-5897 ②
215	2781153 & UP	18-5899	18-5897	575	A677429 & UP	18-5899 ②	18-5899 ②
225 (Ford)	3385721 & UP	18-5899	18-5897	888	3108723 & UP	18-5899	18-5897
225 (GM)	1632308-2694014	18-5899	18-5897 ⑧ ⑨	898	4762210-6218461	18-5899	18-5898
228	4765100-6218461	18-5899	18-5898	898	6218462 & UP	18-5899 ②	18-5897 ②
228 & 230	6218462 & UP	18-5899 ②	18-5897 ②	5.7	A338553-B514626	18-5899 ②	18-5897 ②
230 (I.B.)	5907058 & UP	18-5899 ②	18-5897 ②	5.7	B514627-B525981	18-5899 ②	18-5897 ② ⑥ ⑦
230 (5.0)	B522506 & UP	18-5899 ⑩	18-5897 ⑥ ⑦	5.7 (Bravo)	B525982 & UP	—	18-5897 ⑥ ⑦
233 Ford	4173000 & UP	18-5899	18-5898	7.4 (Bravo)	B771113-D803117	18-5899 ②	18-5897 ② ⑥ ⑦
250	9314301-4908849	18-5899	18-5897 ⑧ ⑨	7.4 (Bravo Gen V)	D803118 & UP	—	18-5897 ②
255	3258728 & UP	18-5899	18-5898	7.4L (Hurth)	ALL	18-5899 ②	18-5897 ②
260	4908850-6218461	18-5899	18-5898	454	D805069 & UP	—	18-5897 ②
260	6218462 & UP	18-5899 ②	18-5897 ②	8.2	C878221-D857199	18-5899 ②	18-5897 ②
260/5.7	B522506 & UP	18-5899 ⑩	18-5897 ⑥ ⑦	8.2	D857200 & UP	—	18-5897 ②
260	5907058 & UP	18-5899 ②	18-5897 ②				

① S/N - 3377341-3461707 & 5192049 & UP
 ② Does not include Dual application
 ④ 2326096 & UP

⑤ 2233574 & Below use 18-5898
 ⑥ (3/8 - 18)
 ⑦ (1/2 -14) Use 18-5898

⑧ Electric Choke
 ⑨ Auto Choke
 ⑩ Thru S/N B525981 only



18-70948
MOLDED HOSE

Replaces: 32-808033

Fits: 262 Mag EFI Bravo w/Fuel Cool System (1996-97), 4.3L EFI (TBI) (1998-01), 5.0L (Gen+) Bravo (1998-07), 5.0L EFI (Gen+) (1998-01), 350 Mag Alpha (Gen+) (1997), 350 Mag Alpha EFI (Gen+) (1997), 350 Mag Bravo MPI (Gen+) (1997), 350 Mag MPI (Gen+) (1998-01), 5.7L (1997), 5.7L (Gen+) (1998-07), 5.7L EFI (1997), 5.7L EFI (Gen+) 1998-2001, 5.7LX (1997), 5.7LX Bravo EFI (Gen+) (1997), 5.7LX EFI (1997)

For: Cooler to thermostat housing



18-70949
MOLDED HOSE

Replaces: 32-807407

Fits: 454 Mag MPI (Gen VI) (1996-01), 7.4LX MPI Bravo (Gen VI) (1996-97), 502 Mag MPI (Gen VI) (1996-01) **For:** Cooler to thermostat housing



18-70954
MOLDED HOSE

Replaces: 32-8600891, 32-860089

Fits: 5.0L (Gen+) Bravo (1998-07), 5.0L EFI (Gen+) Alpha & Bravo (1998-01), 350 Mag Alpha (1997), 350 Mag EFI (Gen+) Alpha (1997), 350 Mag MPI (Gen+) Alpha (1997), 350 Mag MPI (Gen+) Bravo (1997-01), 350 Mag MPI (Gen+) Alpha (1998-01), 5.7L Alpha & Bravo (1997), 5.7L (Gen+) Alpha & Bravo (1998-07), 5.7L EFI Bravo (1997-01), 5.7LX Alpha & Bravo (1997), 5.7LX EFI (Gen+) Alpha & Bravo (1997), 6.2L MPI (2000-01) **For:** oil cooler to oil cooler



18-70956
MOLDED HOSE

Replaces: 32-16012

Fits: MC175/205 (1987), 4.3L (1988-92), 4.3L (Gen II) (1992-95), 4.3LX (Gen II) (1992-95) **For:** Oil cooler to thermostat housing with all four hose connectors cast into the thermostat housing (No "T" connector) Two hoses to manifold and two hoses to elbow



18-70955
MOLDED HOSE

Replaces: 32-16011

Fits: MC200/230 (1987), 5.0L Alpha (1988-95), 5.0LX Alpha (1988-95), MC260 (1987), 350 Mag Alpha (1987-95), 5.7L Alpha & Bravo (1988-95), 454 Mag Bravo (1988-92), 7.4L (GenV) Bravo (1992-96)

For: Oil cooler to thermostat housing with all four hose connectors cast into the thermostat housing (No "T" connector) Two hoses to manifold and two hoses to elbow



18-70952
MOLDED HOSE

Replaces: 32-887952

Fits: 5.0 L Bravo (1988-95), 5.0LX Bravo (1988-95), 350 Mag MPI Bravo (1995), 350 Mag MPI (Gen+) Bravo (1996), 5.7L Bravo (1988-96), 5.7L EFI 1995, 5.7L EFI Bravo (1996), 5.7LX EFI (Gen+) Bravo (1996) **For:** Seawater pump to oil cooler



18-70953
MOLDED HOSE

Replaces: 32-8080441

Fits: 5.0L EFI (Gen+) Bravo (1998-01), 350 Mag MPI (Gen+) (1998-01), 5.7L Bravo (1997), 5.7L (Gen+) Bravo (1998-07), 5.7L EFI Bravo 1997, 5.7L EFI (Gen+) Bravo (1998-01), 5.7LX Bravo (1997), 5.7LX EFI (Gen+) Bravo (1997), 6.2L MPI (2000-01)

For: Seawater pump to oil cooler



18-70951
MOLDED HOSE

Replaces: 32-860205, 32-8078962, 32-8078961

Fits: 262 Mag. EFI Bravo (1996-97), 4.3L (Gen+) Bravo (1998-07), 4.3L TBI (Gen+) Bravo (1998-01), 4.3LH (Gen+) Bravo (1998-02), 4.3LX(H) (Gen+) Bravo (1996-97)

For: Seawater pump to oil cooler



18-70945
MOLDED HOSE

Replaces: 32-862139

Fits: 4.3L (Gen+) (1998-07), 4.3L EFI (Gen+) (1998-01), 4.3LH (Gen+) (1998-02)

For: Thermostat housing to port manifold with 2 piece exhaust manifold



18-70947
MOLDED HOSE

Replaces: 32-862124

Fits: 4.3L (Gen+) (1998-07) (S/N 0L619000 & UP), 4.3L EFI (Gen+) (2000-01), 4.3LH (Gen+) (2000-02)

For: Thermostat housing to starboard manifold with 2 piece exhaust manifold

**18-70940
MOLDED HOSE**

Replaces: 32-860144
Fits: 262 Mag with Fuel Cool, 4.3L-LX (1996 & Up) with 1 pc. manifold, 5.0L-EFI (1998 & Up), 350 Mag-MPI 97-01, 5.7L-EFI (1996-97), 6.2L MPI(20 01& Up).
For: Thermostat housing to port exhaust manifold



**18-70946
MOLDED HOSE**

Replaces: 32-8066362
Fits: 262 Mag EFI (Gen+) (1996-97), 4.3L (Gen+) (1998-07) (S/N 0L01004-0L618999), 4.3L EFI (Gen+) (1998-00), 4.3LH (Gen+) 1998-00, 4.3LX (Gen+) (1996-97), 4.3LXH (Gen +) (1996-97)
For: Thermostat housing to starboard manifold with 2 piece exhaust manifold



**18-44092
MOLDED HOSE
TRANSOM TO T-STAT HSG**

Replaces: 32-861635
For: Mercruiser 3.0L



**18-70958
MOLDED HOSE**

Replaces: 32-96246A4, 32-96246A1, 32-96246
Fits: MC898 (1983-84), MC200 (1985-87), MC228 (1982-84), MC230 (1985-87), 5.0L & 5.0LX Alpha (1988-95), MC260 (1983-87), 300 Tempest MR (1985-86), MC320 EFI (1987-89), 350 MAG Alpha (1986-96), 5.7L Alpha (1988-96), 5.7LX & 5.7LX EFI Alpha (1996), 454 MAG Alpha (1986-88)
For: Transom to oil cooler



**18-70934
MOLDED HOSE**

Replaces: 32-897181
Fits: 330 (1977-87), 330 MIE (1977-80), 340 MIE W/ BW (1981-87), 370 TRS (1978-87), 400 TRS (1980-86), 420 (1987-89), 425 (1990-92), 425 (Gen V) (1992-93), 440 TRS (1983-86), 450 (Gen V) (1995-96), 454 EFI (Gen V) (1994-96), 454 Mag Alpha (1986-88), 454 Mag Bravo (1988-92), 454 Mag Bravo(Gen V) (1992-97), 454 Mag MPI Bravo(Gen V) (1996-98), 454 Mag MPI SKI (Gen VI)(1996-97), 460 TRS (1983-86), 465 (1990-92), 465 (Gen V) (1992-94), 500 Gen + (1999), 500 (Gen V) (1994-96), 500 (Gen VI)(1997-98), 502 EFI (Gen V)(1993-95), 502 Mag Bravo (1990-92), 502 Mag MPI Bravo (Gen VI), 502 Mag Bravo(Gen V)(1992-93), 502 Mag MPI(Gen VI)(1996), 7.4L MIE W/BW (1988-92), 7.4L Bravo (1988-91), 7.4L Bravo(Gen V)(1992-96), 7.4L Bravo (Gen VI)(1996-97), 7.4L MIE (LH)(Gen V)(1992-96), 7.4L MIE (LH)(Gen VI)(1996-97), 7.4L MIE W/Hurth (1989-92), 7.4L MIE MPI (LH)(Gen V)(1996-97), 7.4L TBI MIE (LH)(Gen VI)(1996-97), 7.4LX Bravo MPI(Gen V)(1996-97), 7.4LX Bravo TBI(Gen VI)(1996-97), 8.2L MIE (Gen V)(1993-96), 8.2L MIE MPI (Gen VI), 8.2



**18-70935
MOLDED HOSE**

Replaces: 32-806856
Fits: 200 2bbl (1987), 230 4bbl (1987), 260 (1987), 350 Mag SKI (1991-96), 350 Mag Alpha (1987-95), 350 Mag Alpha 4bbl (1996), 350 Mag Alpha EFI (Gen+)(1996), 350 Mag Bravo MPI (1995), 350 Mag Bravo MPI (Gen+)(1996), 350 Mag EFI SKI TBI (1994-96), 350 Mag MPI SKI (1995-96), 4.3L (Gen II)(2bbl)(1993-96), 4.3LX (Gen II)(4bbl)(1993-96), 5.0L 2bbl (1988-95), 5.0LX 4bbl (1988-95), 5.7L (1988-95), 5.7L 2bbl (1996), 5.7L Alpha EFI TBI (1995), 5.7L Bravo EFI TBI(1995), 5.7L Competition SKI (1996), 5.7L EFI (2bbl TBI)(1996), 5.7L MIE (1996), 5.7LX 4bbl (1996), 5.7LX Bravo EFI (Gen+)(1996), 5.7LX EFI 4bbl TBI (1996), Black Scorpion(Gen+)(1996)
For: Oil cooler to thermostat housing.



**18-70938
MOLDED HOSE**

Replaces: 32-8066351
Fits: 262 Mag with VST (1996-97), 4.3L-LX (1993-96) Design III, 5.0L-LX (1988-95) Design III, 350Mag-EFI-MPI (1987-96), 5.7L-LX 88-96 Design III
For: Thermostat housing to port exhaust manifold



**18-70939
MOLDED HOSE**

Replaces: 32-8066361
Fits: 4.3L-LX (1993-96) Standard Cooling Design III, 5.0L-LX/5.7L-LX (1988-95) Standard Cooling Design III, 350 Mag (1987-95) Standard Cooling Design III
For: Thermostat housing to starboard exhaust manifold



**18-70943
MOLDED HOSE**

Replaces: 32-897491
Fits: 7.4L, 454 Mag, 502 Mag. For Thermostat housing to port exhaust manifold



**18-3601
GIMBAL HOUSING WATER FEED HOSE**

Replaces: 32-32461, 32-32461A1
Dia. 5/8"
Length 13 7/8"





18-3602
WATER INTAKE HOSE
 Replaces: 32-4172533, 32-8M0062309
 13 7/8" Length - 3/4" I.D.
 For: MR, Alpha I, Gen II



18-3603
WATER INTAKE HOSE
 Replaces: 32-43437, 32-8M0090859



18-70925
MOLDED HOSE
 Replaces: 32-160211, 32-87116, 32-16021
 For: 4.3L, 5.0L, & 5.7L
 For: Thermostat Cover to Port Manifold



18-70926
MOLDED HOSE
 Replaces: 32-73796
 For: 5.0L & 5.7L
 For: Thermostat Cover to Exhaust Elbow



18-70927
MOLDED HOSE
 Replaces: 32-73795
 For: 5.0L & 5.7L Port
 For: Thermostat Housing to Port Manifold



18-70928
MOLDED HOSE
 Replaces: 32-71613
 For: 5.0L & 5.7L
 For: Thermostat Housing to Oil Cooler



18-70929
MOLDED HOSE
 Replaces: 32-73794
 For: 5.0L & 5.7L Starboard
 For: Thermostat Housing to Starboard Manifold



18-70930
MOLDED HOSE
 Replaces: 32-52481
 For: GM Inline 4 & 6 cyl.
 For: Water Distribution Block to End Cap



18-70931
MOLDED HOSE
 Replaces: 32-96879, 32-47640, 32-8M0071007
 For: 2.5L & 3.0L
 For: Distribution Block to Water Pump



18-70932
MOLDED HOSE
 Replaces: 32-871171, 32-87117
 For: 4.3L, 5.0L, & 5.7L Starboard
 For: Thermostat Cover to Starboard Manifold

SINGLE DIAMETER HOSE



4 3/4"

18-70021
MOLDED HOSE
3/4" ID



5"

18-70704
MOLDED HOSE
Replaces: 32-89653
1 1/4" ID
For: 3.7L



5"

18-70924
MOLDED HOSE
1 3/4" ID



12 1/2"

18-71218
MOLDED HOSE
Replaces: 32-48131, 32-48132
1" ID
For: 230 & 260 MIE



12 3/4"

18-71337
MOLDED HOSE
Replaces: 32-861590A05, 32-861590A2, 32-861590A1,
32-806825
1 3/4" ID
For: 4.3L, 5.0L, 5.7L
Circulating Pump Hose

STRAIGHT HOSE



18-75100
MOLDED HOSE
Replaces: 32-8M0062614
Straight 48"
1" ID



18-75125
MOLDED HOSE
Replaces: 32-8M0062665, 32-865672070, 32-5346170
Straight 48"
1 1/4" ID

HOSE INTERCHANGE

Part No.	Mercruiser Part No.	Part No.	Mercruiser Part No.	Part No.	Mercruiser Part No.
18-70925	32-16021 1	18-70928	32-71613	18-70940	32-860144
18-3601	32-32461	18-70929	32-73794	18-71337	32-87108
18-71337	32-33189	18-70927	32-73795	18-70932	32-87117 1
18-3602	32-41725-33	18-70926	32-73796	18-70704	32-89653
18-3603	32-43437	18-70938	32-806635 1	18-70934	32-89718 1
18-71218	32-48132	18-70939	32-806636 1	18-70943	32-89749 1
18-70930	32-52481	18-70935	32-806856	18-70931	32-96879

V-BELTS

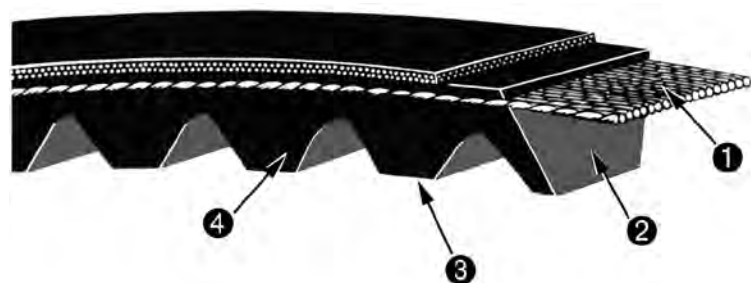

- 1 High strength synthetic cords resist shockload failure. Their low stretch properties assure uniform performance over the life of the belt.
- 2 The compression section is a special rubber compound that assures smooth and even transfer of load forces to the cords.
- 3 Cogs are molded to precise engineering tolerances to improve flexibility and maintain cord support. Cog geometry provides a large area for air circulation to keep the belt cool and prevent damaging heat build up in the cushion section.
- 4 Rubber edges maintain positive, no-slip contact with pulley grooves for reliable energy transfer.



BELT SIZE LISTING BY NUMBER

Part No.	OE #	Effective Length (in.)	Top Width (in.)	Part No.	OE #	Effective Length (in.)	Top Width (in.)
18-15290	57-13457, 57-13457T, 57-13457Q, 57-53215, 57-53215T	29	29/64	18-15435	57-64416, 57-49211	43 1/2	29/64
18-15300	57-49756	30	29/64	18-15440	57-49213A1, 57-45856	44	29/64
18-15325	57-77274A1, 57-77274	32 1/2	29/64	18-15450	-	45	29/64
18-15345	57-74271T, 57-74271, 57-74271Q	34 1/2	29/64	18-15455	-	45 1/2	29/64
18-15370	57-65607T, 57-65607, 57-65607Q	37	29/64	18-15460	57-48120A1, 57-48120, 57-48120Q1	46	29/64
18-15380	-	38	29/64	18-15470	57-78200A1, 57-78200, 57-78200Q1	47	29/64
18-15390	57-52692	39	29/64	18-15480	57-48122, 57-48122Q	48	29/64
18-15400	57-32850, 57-69143T, 57-69143Q	40	29/64	18-15490	57-816295T, 57-816295Q	52 1/2	29/64
18-15405	57-76269, 57-76269Q	40 1/2	29/64	18-15495	57-91035A1, 57-91035Q1, 57-91035	49 1/2	29/64
18-15410	57-49043A1, 57-64032A1, 57-32850, 57-49043, 57-64032, 57-64032Q1, 57-816544	41	29/64	18-15500	57-96834T, 57-96834Q, 57-96834, 57-13458, 57-13458Q	50	29/64
18-15415	57-36356	41 1/2	29/64	18-15520	57-33170, 57-33170Q, 57-37619T	52	29/64
18-15430	57-49211, 57-64416	43	29/64	18-15550	57-13458T	55	29/64

V-BELT APPLICATION

HP	Liter	Model	Years	CID	# Cyl	Stroke	Serial #	Belt Type	Alternator/ Water Pump	Power Steering	Sea Water Pump
110		110	1963-1966	153	4	4	1537370 - 2044033	V-BELT	18-15410	—	—
120		120	1964-1973	153	4	4	1666601 - 3770649	V-BELT	18-15410	—	—
120		120	1974-1982	153	4	4	3770650 - 6229717	V-BELT	18-15410	18-15400 (40" BELT)	—
120		120	1974-1982	153	4	4	3770650 - 6229717	V-BELT	18-15410	18-15400 (40" BELT)	—
120		120	1982-1986	153	4	4	6229718 - b531853	V-BELT	18-15410 (19)	—	—
120		120	1982-1986	153	4	4	6229718 - b531853	V-BELT	18-15400 (18)	—	—
120	2.5L	120	1982-89	153	4	4	6229718 - C853255	V-BELT	18-15410	—	—
120	2.5L	120 (18)	1982-89	153	4	4	6229718 - C853255	V-BELT	18-15400	18-15370	—
140		140	1968-73	181	4	4	2508261-3770649	V-BELT	18-15410	—	—

- (1) 1/2" wide (13mm) belt
- (2) 3/8" wide (10mm) belt
- (3) 28" wide (711mm) belt
- (4) 30" wide (762mm) belt
- (5) 37" wide (940mm) belt
- (6) 40" wide (1016mm) belt
- (7) 50" wide (1270mm) belt
- (8) 55" wide (1397mm) belt

- (9) Use with 5 1/2" (140mm) dia water pump pulley
- (10) Use with 5 7/8" (149mm) dia water pump pulley
- (11) Use with 7" (178mm) dia water pump pulley
- (12) Use with stamped steel sea water pump pulley
- (13) Use with cast aluminum sea water pump pulley
- (14) Use with plastic 4 3/4" (121mm) dia p/s pump pulley
- (15) Use with metal 5 3/4" (146mm) dia p/s pump pulley
- (16) For engine with high mounted p/s pump

- (17) For engines with low mounted p/s pump
- (18) For engine with power steering
- (19) For engines w/o power steering
- (20) For engines with closed cooling
- (21) For engines with standard cooling
- (22) Replacement kit includes 5 3/4" (146mm) pulley and longer serpentine belt
- (23) For engines with high mounted alternator

V-BELT APPLICATION

HP	Liter	Model	Years	CID	# Cyl	Stroke	Serial #	Belt Type	Alternator/ Water Pump	Power Steering	Sea Water Pump
140		140	1974-82	181	4	4	3770650-6229717	V-BELT	18-15410	18-15370 (37" BELT)	—
140		140	1974-82	181	4	4	3770650-6229717	V-BELT	18-15410	18-15400 (40" BELT)	—
140	3.0L	140 / 3.0L / 3.0LX	1982-1986	181	4	4	6229718 - B450800	V-BELT	18-15410 (19)	—	—
140	3.0L	140 / 3.0L / 3.0LX	1982-1999	181	4	4	6229718 - B450800	V-BELT	18-15400 (18)	18-15370	—
140	3.0L	3.0L	1987-1994	181	4	4	6229718 - F603999	V-BELT	18-15400 (18)	18-15370	—
140	3.0L	3.0L	1987-1994	181	4	4	6229718 - F603999	V-BELT	18-15400 (18)	18-15370	—
	3.0L	3.0L	1998-1999	181	4	4	L010042 - L382121	V-BELT	18-15400	18-15370	—
	3.0L	3.0L	1999-2010	181	4	4	L382122 & UP	V-BELT	—	18-15370	—
	3.0L	3.0LX	1990-1995	181	4	4	C856559 - F603999	V-BELT	18-15410 (19)	—	—
	3.0L	3.0LX	1990-1995	181	4	4	C856559 - F603999	V-BELT	18-15400 (18)	18-15370	—
	3.0L	3.0LX	1986-1997	181	4	4	F604000 - K999999	V-BELT	18-15400	18-15370	—
	3.0L	3.0L MPI	2008-2010	181	4	4	A072812 & UP	V-BELT	—	18-15370	—
150		150	1964-66		4	4	1666495-2048646	V-BELT	18-15410	—	—
160		160	1967-69		4	4	2048022-2770031	V-BELT	18-15410	—	—
165		165	1987	224	4	4	B434941 - B774251	V-BELT	—	18-15410	—
165		165	1970-73		4	4	2770032 - 3774864	V-BELT	18-15410	—	—
165		165	1974-81		4	4	3774865 - 5813433	V-BELT	18-15410	18-15370 (37" BELT)	—
165		165	1974-81		4	4	3774865 - 5813433	V-BELT	18-15410	18-15400 (40" BELT)	—
170	3.7L	165 / 170 / 180 / 190 / 3.7L	1985-89		4	4	6916779 - C762299	V-BELT	—	18-15410	—
170		170	1985-1986	224	4	4	6916779 - B434940	V-BELT	—	18-15410	—
170		470	1976-82		4	4	4208730 - 6218036	V-BELT	—	18-15405	—
170		470	1983-84		4	4	6218037 - 6916778	V-BELT	—	18-15410	—
		488	1983-84		4	4	6170297 - 6916778	V-BELT	—	18-15410	—
175		175	1987		4	4	OB527955-OB773242	V-BELT	—	18-15490	—
180		180	1987	224	4	4	B436391 - B775248	V-BELT	—	18-15410	—
190		190	1985-1986	224	4	4	691779 - B436390	V-BELT	—	18-15410	—
	3.7L	3.7L	1988-1989	224	4	4	B774252 - C762299	V-BELT	—	18-15410	—
	3.7L	3.7LX	1988-1989	224	4	4	B775249 - C762299	V-BELT	—	18-15410	—
		470	1983-1984	224	4	4	6218037 - 6916778	V-BELT	—	18-15410	—
		470 MIE	1980-1981	224	4	4	5520115 - 6218036	V-BELT	—	—	18-15345
		485	1980-1982	224	4	4	5685394 - 6218036	V-BELT	—	18-15410	—
		488	1983-1984	224	4	4	6170297 - 6916778	V-BELT	—	18-15410	—
		140	1963	194	6	4	1538930 - 1725960	V-BELT	18-15410	—	—
		150	1964-1966	230	6	4	1666495 - 2048046	V-BELT	18-15410	—	—
		160	1967-1969	250	6	4	2048022 - 2770031	V-BELT	18-15410	—	—
		165	1970-1973	250	6	4	2770032 - 3774864	V-BELT	18-15410	—	—
140		165	1974-1981	250	6	4	3774865 - 5813433	V-BELT	18-15410	18-15370 (37" BELT)	—
150		165	1974-1981	250	6	4	3774865 - 5813433	V-BELT	18-15410	18-15400 (40" BELT)	—
		200	1969	292	6	4	2453769 - 2712072	V-BELT	18-15410	—	—
		185 (4bbl)	1983-1984	229	6	4	6330183 - M6919655	V-BELT	—	18-15520	18-15345
		175	1987	262	6	4	B527955 - B773242	V-BELT	—	18-15520	18-15345
		185 (2bbl)	1985-1986	262	6	4	A331455 - B527954	V-BELT	—	18-15520	18-15345
		205	1985-1987	262	6	4	A331455 - B775129	V-BELT	—	18-15520	18-15345
		205	1985-1991			4	A331455 - D714369	V-BELT	18-15440	18-15520	18-15345
		205	1987			4	B527955 - OB775129	V-BELT	—	18-15490	—
		4.3L (2bbl)	1988-92	262	6	4	OB773243-OD714106	V-BELT	—	18-15490	—
		4.3L	1992-96	262	6	4	D714107 - F802999	V-BELT	18-15460	—	18-15290
		4.3L ALPHA RWC	1996-1999	262	6	4	F803000 - L618999	SERPENTINE	18-15116 (14, 21, 22)	—	—
		4.3L ALPHA FWC	1996-1999	262	6	4	F803000 - L618999	SERPENTINE	18-15117 (14, 20, 22)	—	—
	4.3L	4.3L ALPHA RWC	1996-1999	262	6	4	F803000 - L618999	SERPENTINE	18-15116 (15, 21)	—	—
	4.3L	4.3L ALPHA FWC	1996-1999	262	6	4	F803000 - L618999	SERPENTINE	18-15117 (15, 20)	—	—
	4.3L	4.3L ALPHA RWC (19)	1996-1999	262	6	4	F803000 - L618999	SERPENTINE	18-15113 (19)	—	—
	4.3L	175 / 185 / 4.3L	1985-92	262	6	4	A331455 - D714106	V-BELT	18-15440	18-15520	18-15345
	4.3L	4.3L Gen II (2bbl)	1992-96	262	6	4	OD714107-OF802999	V-BELT	—	18-15490	—
	4.3L	4.3LX (4bbl)	1988-92	262	6	4	OB775130-OD714369	V-BELT	—	18-15490	—

- (1) 1/2" wide (13mm) belt
- (2) 3/8" wide (10mm) belt
- (3) 28" wide (711mm) belt
- (4) 30" wide (762mm) belt
- (5) 37" wide (940mm) belt
- (6) 40" wide (1016mm) belt
- (7) 50" wide (1270mm) belt
- (8) 55" wide (1397mm) belt

- (9) Use with 5 1/2" (140mm) dia water pump pulley
- (10) Use with 5 7/8" (149mm) dia water pump pulley
- (11) Use with 7" (178mm) dia water pump pulley
- (12) Use with stamped steel sea water pump pulley
- (13) Use with cast aluminum sea water pump pulley
- (14) Use with plastic 4 3/4" (121mm) dia p/s pump pulley
- (15) Use with metal 5 3/4" (146mm) dia p/s pump pulley
- (16) For engine with high mounted p/s pump

- (17) For engines with low mounted p/s pump
- (18) For engine with power steering
- (19) For engines w/o power steering
- (20) For engines with closed cooling
- (21) For engines with standard cooling
- (22) Replacement kit includes 5 3/4" (146mm) pulley and longer serpentine belt
- (23) For engines with high mounted alternator

V-BELT APPLICATION

HP	Liter	Model	Years	CID	# Cyl	Stroke	Serial #	Belt Type	Alternator/ Water Pump	Power Steering	Sea Water Pump
	4.3L	4.3LX Gen II (4bb)	1992-96	262	6	4	OD714370-OF802999	V-BELT	—	18-15490	—
	4.3L	4.3L BRAVO RWC	1996-1999	262	6	4	F803000 - L618999	SERPENTINE	18-15115 (14, 21, 22)	—	—
	4.3L	4.3L BRAVO FWC	1996-1999	262	6	4	F803000 - L618999	SERPENTINE	18-15114 (14, 20, 22)	—	—
	4.3L	4.3L BRAVO RWC	1996-1999	262	6	4	F803000 - L618999	SERPENTINE	18-15115 (15, 21)	—	—
	4.3L	4.3L BRAVO FWC	1996-1999	262	6	4	F803000 - L618999	SERPENTINE	18-15114 (15, 20)	—	—
	4.3L	4.3L BRAVO RWC (19)	1996-1999	262	6	4	F803000 - L618999	SERPENTINE	18-15113 (19)	—	—
	5.0L	215	1970-1972	302	8	4	2781153 - 3563181	V-BELT	18-15440	—	—
	5.0L	215 MIE	1970-1972	302	8	4	2781153 - 3563181	V-BELT	18-15440	—	—
	5.0L	225 (FORD)	1973-74	302	8	4	3385721 - 4166999	V-BELT	18-15440	18-15520	18-15345
	5.0L	225 MIE (FORD)	1973-74	302	8	4	3385721 - 4166999	V-BELT	18-15440	—	—
	5.0L	888 (FORD)	1971-1977	302	8	4	3108723 - 4887829	V-BELT	18-15440 (28" BELT)	— (28" BELT)	—
	5.0L	888 (FORD)	1971-1977	302	8	4	3108723 - 4887829	V-BELT	18-15440 (30" BELT)	18-15290 (30" BELT)	18-15440
	5.0L	198 MIE	1977	305	8	4	4762210 - 6218461	V-BELT	18-15460	—	18-15345
	5.0L	200	1985-1987	305	8	4	6899058 - B774444	V-BELT	— (9)	18-15520 (9)	18-15345
	5.0L	200	1985-1987	305	8	4	6899058 - B774444	V-BELT	18-15460 (11)	18-15490 (11)	18-15345
	5.0L	200	1987		8	4	2453769 - 2712072	V-BELT	18-15410	—	—
	5.0L	200	1987		8	4	B525982-B774444	V-BELT	—	18-15490	—
		225 MCM / 225 MIE	1967-69		8	4	2278647 - 2694014	V-BELT	18-15460	—	—
	5.0L	228	1977-1982	305	8	4	4765100-6218461	V-BELT	18-15460 (17)	18-15325	18-15345
	5.0L	228	1977-1982	305	8	4	4765100-6218461	V-BELT	18-15440 (16)	18-15495	18-15345
	5.0L	228	1983-1984	305	8	4	6218462 - 6899268	V-BELT	— (9)	18-15520 (9)	18-15345
	5.0L	228	1983-1984	305	8	4	6218462 - 6899268	V-BELT	18-15460 (11)	18-15490 (11)	18-15345
	5.0L	228 MIE	1977	305	8	4	4765100 - 4929029	V-BELT	18-15460	—	18-15345
	5.0L	228 MIE	1978-1980	305	8	4	4929030 - 5907057	V-BELT	— (9)	—	18-15345 (12)
	5.0L	228 MIE	1978-1980	305	8	4	4929030 - 5907057	V-BELT	18-15460 (11)	—	18-15290 (13)
	5.0L	228 MIE	1977	305	8	4	4765100 - 4929030	V-BELT	18-15460	—	18-15325
	5.0L	228 / 230 / 5.0L	1983-95		8	4	6218462 - F600999	V-BELT	18-15440	18-15495	18-15345 (20)
	5.0L	228 / 230 / 5.0L	1983-95		8	4	6218462 - F600999	V-BELT	18-15460	18-15520	18-15290 (21)
	5.0L	228 / 230 / 5.0L MIE	1978-87		8	4	4929030 - B788151	V-BELT	18-15440	18-15495	18-15345 (12)
	5.0L	228 / 230 / 5.0L MIE	1978-87		8	4	4929030 - B788151	V-BELT	18-15460	18-15520	18-15290 (13)
	5.0L	230	1985-1987	305	8	4	6899269 - B773739	V-BELT	18-15520 (9)	18-15520 (9)	18-15345
	5.0L	230	1983-1984	305	8	4	6899269 - B773739	V-BELT	18-15460 (11)	18-15490 (11)	18-15345
	5.0L	230 MIE	1981-1987	305	8	4	5907058 - B788151	V-BELT	— (9)	—	18-15345 (12)
	5.0L	230 MIE	1981-1987	305	8	4	5907058 - B788151	V-BELT	18-15460 (11)	—	18-15290 (13)
		230	1987		8	4	B525982-B773739	V-BELT	—	18-15490	—
		233	1975-77			4	4173000 - 4902304	V-BELT	18-15440	—	—
		233	1975-77			4	4173000 - 4902304	V-BELT	18-15440	18-15290	18-15345 (12)
		233 MIE	1975-76			4	4173000 - 4775784	V-BELT	18-15440	—	—
	5.0L	5.0L	1988-1995	305	8	4	B774445 - F600999	V-BELT	— (9)	18-15520 (9)	18-15345 (12)
	5.0L	5.0L	1988-1995	305	8	4	B774445 - F600999	V-BELT	18-15460 (11)	18-15490 (11)	18-15290 (13)
	5.0L	5.0L ALPHA RWC	1998-1999	305	8	4	L012052 - L618999	SERPENTINE	18-15116 (1, 14, 21, 22)	—	—
	5.0L	5.0L ALPHA FWC	1998-1999	305	8	4	L012052 - L618999	SERPENTINE	18-15114 (14, 20, 22)	—	—
	5.0L	5.0L ALPHA RWC	1998-1999	305	8	4	L012052 - L618999	SERPENTINE	18-15116 (15, 21)	—	—
	5.0L	5.0L ALPHA FWC	1998-1999	305	8	4	L012052 - L618999	SERPENTINE	18-15114 (15, 20)	—	—
	5.0L	5.0L BRAVO RWC	1998-1999	305	8	4	L012052 - L618999	SERPENTINE	18-15115 (1, 14, 20, 22)	—	—
	5.0L	5.0L BRAVO FWC	1998-1999	305	8	4	L012052 - L618999	SERPENTINE	18-15114 (1, 14, 21, 22)	—	—
	5.0L	5.0L BRAVO RWC	1998-1999	305	8	4	L012052 - L618999	SERPENTINE	18-15115 (15, 21)	—	—
	5.0L	5.0L BRAVO FWC	1998-1999	305	8	4	L012052 - L618999	SERPENTINE	18-15114 (15, 20)	—	—
	5.0L	5.0L MIE	1988	305	8	4	B788152 - C396832	V-BELT	18-15460 (11)	—	57-13457Q (13)
	5.0L	5.0LX	1988	305	8	4	6218462 - F600999	V-BELT	— (9)	18-15520 (9)	57-74271Q (12)
	5.0L	5.0LX	1983-1995	305	8	4	6218462 - F600999	V-BELT	18-15460 (11)	18-15490 (11)	57-13457Q (13)
	5.0L	5.0L (2bb)	1988-95		8	4	B774445-F600999	V-BELT	—	18-15490	—
	5.0L	5.0LX (4bb)	1988-95		4	4	B773740-F600999	V-BELT	—	18-15490	—
	5.0L	898	1977-19884	305	8	4	4762210 - 6218461	V-BELT	18-15460 (17)	18-15325 (17)	18-15345
	5.0L	898	1977-1984	305	8	4	4762210 - 6218461	V-BELT	18-15440 (16)	18-15495	18-15345

- (1) 1/2" wide (13mm) belt
- (2) 3/8" wide (10mm) belt
- (3) 28" wide (711mm) belt
- (4) 30" wide (762mm) belt
- (5) 37" wide (940mm) belt
- (6) 40" wide (1016mm) belt
- (7) 50" wide (1270mm) belt
- (8) 55" wide (1397mm) belt

- (9) Use with 5 1/2" (140mm) dia water pump pulley
- (10) Use with 5 7/8" (149mm) dia water pump pulley
- (11) Use with 7" (178mm) dia water pump pulley
- (12) Use with stamped steel sea water pump pulley
- (13) Use with cast aluminum sea water pump pulley
- (14) Use with plastic 4 3/4" (121mm) dia p/s pump pulley
- (15) Use with metal 5 3/4" (146mm) dia p/s pump pulley
- (16) For engine with high mounted p/s pump

- (17) For engines with low mounted p/s pump
- (18) For engine with power steering
- (19) For engines w/o power steering
- (20) For engines with closed cooling
- (21) For engines with standard cooling
- (22) Replacement kit includes 5 3/4" (146mm) pulley and longer serpentine belt
- (23) For engines with high mounted alternator

V-BELT APPLICATION

HP	Liter	Model	Years	CID	# Cyl	Stroke	Serial #	Belt Type	Alternator/ Water Pump	Power Steering	Sea Water Pump
	5.0L	898	1983-1984	305	8	4	6218462 - 6899057	V-BELT	— (9)	18-15520 (9)	18-15345 (9)
	5.0L	898	1983-1984	305	8	4	6218462 - 6899057	V-BELT	18-15460 (11)	18-15490 (11)	18-15345
	5.0L	898 / 200 / 5.0L	1985-1995	305	8	4	6218462 - F600999	V-BELT	18-15440 (20)	18-15495	18-15345
	5.0L	898 / 200 / 5.0L	1985-1995	305	8	4	6218462 - F600999	V-BELT	18-15460 (21)	18-15520	18-15290
	5.7L	250 MCM / 250 MIE	1968-69	350	8	4	2314301 - 2639854	V-BELT	18-15460	—	—
	5.7L	250	1977	350	8	4	4768000 - 4908849	V-BELT	18-15440	18-15345	18-15345
	5.7L	255 MCM / 255MIE	1973-74	350	8	4	3258728 - 4175499	V-BELT	18-15440	—	—
	5.7L	255 (GM)	1975-76	350	8	4	4175500 - 4498700	V-BELT	18-15460	18-15300	18-15345
	5.7L	255 (GM)	1976	350	8	4	4498701-4499060	V-BELT	18-15460	—	18-15345
	5.7L	255 (GM)	1976	350	8	4	4499061-4767999	V-BELT	18-15460	—	18-15345
	5.7L	255 MIE (GM)	1975-77	350	8	4	4175500 - 4498700	V-BELT	18-15460	—	18-15345
	5.7L	255 MIE (GM)	1977-78	350	8	4	4498701 - 4924564	V-BELT	18-15460	—	18-15345
	5.7L	255 MIE (GM)	1978-1980	350	8	4	4924565 - 5907057	V-BELT	—	—	18-15345
	5.7L	260 MIE	1978-86	350	8	4	4924565 - B522505	V-BELT	18-15440	—	18-15345
	5.7L	260 / 5.7L MIE / 5.7L Ski	1987-93	350	8	4	B522506 - F024999	V-BELT	18-15440	—	18-15345 (12)
	5.7L	260 / 5.7L MIE / 5.7L Ski	1987-93	350	8	4	B522506 - F024999	V-BELT	18-15460	—	18-15290 (13)
	5.7L	260	1978-1982	350	8	4	4908850 - 6218461	V-BELT	18-15440 (16)	18-15495 (17)	18-15345
	5.7L	260	1978-1982	350	8	4	4908850 - 6218461	V-BELT	18-15460 (17)	—	18-15345
	5.7L	260	1987	350	8	4	B525982-B773304	V-BELT	—	18-15490	—
	5.7L	260	1983-1987	350	8	4	6218462 - B7733304	V-BELT	18-15460 (11)	18-15490 (11)	18-15290 (13)
	5.7L	260 MIE	1987	350	8	4	B522506 - B788151	V-BELT	18-15460 (11)	—	18-15290 (13)
	5.7L	260 / 5.7L	1983-1995	350	8	4	6218462 - F600999	V-BELT	18-15440	18-15495	18-15345 (20)
	5.7L	260 / 5.7L	1983-1995	350	8	4	6218462 - F600999	V-BELT	18-15460	18-15520	18-15290 (21)
	5.7L	270 MCM / 270 MIE	1969-1972	350	8	4	2851074 - 3385720	V-BELT	18-15460	—	—
	5.7L	280 TRS	1975	350	8	4	4176250 - 4176468	V-BELT	18-15460	—	—
	5.7L	280 TRS	1975	350	8	4	4176250 - 4176468	V-BELT	18-15460	18-15300	—
	5.7L	280 TRS	1975-76	350	8	4	4176469 - 4499390	V-BELT	18-15460	18-15300	—
	5.7L	280 TRS	1976	350	8	4	4499391 - 4499780	V-BELT	18-15460	—	—
	5.7L	280 TRS	1976	350	8	4	4499781 - 4770199	V-BELT	18-15460	18-15325	—
		320 EFI	1987-89		8	4	A543604 - C622418	V-BELT	18-15440	18-15520	—
		330	1977-81		8	4	4623115-6083144		18-15470	—	18-15345
		330	1982-87		8	4	6083144 - B816540		18-15470	18-15500	18-15345 (12)
		330	1982-87		8	4	6083144 - B816540		18-15470	18-15550	18-15290 (13)
	5.7L	350 MAG ALPHA	1986-1995	350	8	4	A635178 - F600999	V-BELT	18-15440 (9)	18-15520 (9)	18-15345 (20)
	5.7L	350 MAG ALPHA	1986-1995	350	8	4	A635178 - F600999	V-BELT	18-15460 (11)	18-15490 (11)	18-15290 (21)
	5.7L	350 MAG ALPHA	1996	350	8	4	F601000 - K001500	V-BELT	18-15460	18-15490	18-15290
	5.7L	350 Mag Alpha	1987-1995	350	8	4	B525982 - F600999	V-BELT	—	18-15490	—
	5.7L	350 Mag Alpha (4bb1)	1996	350	8	4	F601000 - K001526	V-BELT	—	18-15490	—
	5.7L	350 Mag Alpha EFI /									
		350 Mag ALPHA Gen+	1996	350	8	4	F800300 - K001508	V-BELT	—	18-15490	—
	5.7L	350 Mag Bravo MPI	1995	350	8	4	F415189 - F601999	V-BELT	—	18-15490	—
	5.7L	350 Mag Bravo MPI /									
		350 Mag Bravo MPI Gen+	1996	350	8	4	F602000 - K001500	V-BELT	—	18-15490	—
	5.7L	350 MAG Ski	1991-96	350	8	4	D505450 - K040005	V-BELT	18-15460	—	18-15290
	5.7L	350 MAG ALPHA RWC	1997-1999	350	8	4	K001501 - L618999	SERPENTINE	18-15116 (14, 21, 22)	—	—
	5.7L	350 MAG ALPHA FWC	1997-1999	350	8	4	K001501 - L618999	SERPENTINE	18-15114 (14, 20, 22)	—	—
	5.7L	350 MAG ALPHA RWC	1997-1999	350	8	4	K001501 - L618999	SERPENTINE	18-15116 (15, 20)	—	—
	5.7L	350 MAG ALPHA FWC	1997-1999	350	8	4	K001501 - L618999	SERPENTINE	18-15114 (15, 21)	—	—
	5.7L	350 MAG BRAVO RWC	1997-1999	350	8	4	K001501 - L618999	SERPENTINE	18-15115 (14, 21, 22)	—	—
	5.7L	350 MAG BRAVO FWC	1997-1999	350	8	4	K001501 - L618999	SERPENTINE	18-15114 (14, 20, 22)	—	—
	5.7L	350 MAG BRAVO RWC	1997-1999	350	8	4	K001501 - L618999	SERPENTINE	18-15115 (15, 21)	—	—
	5.7L	350 MAG BRAVO FWC	1997-1999	350	8	4	K001501 - L618999	SERPENTINE	18-15114 (15, 20)	—	—
	5.7L	350 MIE	1974-75	350	8	4	3780450-4501640		18-15480	—	—
	5.7L	350 MIE	1976	350	8	4	4501641 - 4623109		18-15480	—	18-15345
	5.7L	350 MAG MPI / 350 MAG SKI	1995-1996	350	8	4	F350583 - F799999	V-BELT	18-15460	—	18-15290

- (1) 1/2" wide (13mm) belt
- (2) 3/8" wide (10mm) belt
- (3) 28" wide (711mm) belt
- (4) 30" wide (762mm) belt
- (5) 37" wide (940mm) belt
- (6) 40" wide (1016mm) belt
- (7) 50" wide (1270mm) belt
- (8) 55" wide (1397mm) belt

- (9) Use with 5 1/2" (140mm) dia water pump pulley
- (10) Use with 5 7/8" (149mm) dia water pump pulley
- (11) Use with 7" (178mm) dia water pump pulley
- (12) Use with stamped steel sea water pump pulley
- (13) Use with cast aluminum sea water pump pulley
- (14) Use with plastic 4 3/4" (121mm) dia p/s pump pulley
- (15) Use with metal 5 3/4" (146mm) dia p/s pump pulley
- (16) For engine with high mounted p/s pump

- (17) For engines with low mounted p/s pump
- (18) For engine with power steering
- (19) For engines w/o power steering
- (20) For engines with closed cooling
- (21) For engines with standard cooling
- (22) Replacement kit includes 5 3/4" (146mm) pulley and longer serpentine belt
- (23) For engines with high mounted alternator

V-BELT APPLICATION

HP	Liter	Model	Years	CID	# Cyl	Stroke	Serial #	Belt Type	Alternator/ Water Pump	Power Steering	Sea Water Pump
	5.7L	350 MAG SKI	1991-1996	350	8	4	D505450 - K040005	V-BELT	18-15460	—	18-15290 (12)
	5.7L	5.7L	1988-1995	350	8	4	B773305 - F600999	V-BELT	— (9)	18-15520 (9)	18-15345
	5.7L	5.7L	1988-1995	350	8	4	B773305 - F600999	V-BELT	18-15460 (11)	18-15490 (11)	18-15290
	5.7L	5.7L	1996	350	8	4	F601000 - K001505	V-BELT	18-15460	18-15490	18-15290
	5.7L	5.7L ALPHA RWC	1997-1999	350	8	4	K001506 - L618999	SERPENTINE	18-15116 (14, 21, 22)	—	—
	5.7L	5.7L ALPHA FWC	1997-1999	350	8	4	K001506 - L618999	SERPENTINE	18-15114 (14, 20, 22)	—	—
	5.7L	5.7L ALPHA RWC	1997-1999	350	8	4	K001506 - L618999	SERPENTINE	18-15116 (15, 21)	—	—
	5.7L	5.7L ALPHA FWC	1997-1999	350	8	4	K001506 - L618999	SERPENTINE	18-15114 (15, 20)	—	—
	5.7L	5.7L BRAVO FWC	1997-1999	350	8	4	K001506 - L618999	SERPENTINE	18-15114 (14, 20, 22)	—	—
	5.7L	5.7L BRAVO RWC	1997-1999	350	8	4	K001506 - L618999	SERPENTINE	18-15115 (15, 21)	—	—
	5.7L	5.7L BRAVO FWC	1997-1999	350	8	4	K001506 - L618999	SERPENTINE	18-15114 (15, 20)	—	—
	5.7L	5.7L MIE	1988-1993	350	8	4	B522506 - F024999	V-BELT	—	—	18-15345
	5.7L	5.7L MIE	1988-1993	350	8	4	B522506 - F024999	V-BELT	—	—	18-15290
	5.7L	5.7L MIE	1994-1996	350	8	4	F025000 - K040306	V-BELT	18-15460	—	18-15290
	5.7L	5.7L SKI	1985-1987	350	8	4	A338553 - B514626	V-BELT	—	—	18-15290 (13)
	5.7L	5.7L SKI	1987-1995	350	8	4	B514627 - F775199	V-BELT	—	—	18-15345
	5.7L	5.7L SKI	1987-1995	350	8	4	B514627 - F775199	V-BELT	—	—	18-15290
	5.7L	5.7L SKI	1996	350	8	4	F775200 - K040003	V-BELT	18-15460	—	18-15290
	5.7L	5.7LX	1996	350	8	4	F601000 - K001505	V-BELT	18-15460	18-15490	18-15290
	5.7L	5.7L BRAVO EFI	1996	350	8	4	F800300 - K001505	V-BELT	18-15460	18-15490	18-15290
	5.7L	5.7LX BRAVO	1996	350	8	4	F601000 - K001505	V-BELT	18-15460	18-15490	18-15290
	5.7L	BLACK SCORPION SKI	1996	350	8	4	F800000 - K040000	V-BELT	18-15460	—	18-15290
	5.7L	5.7L MIE / 5.7L Ski	1994-96	350	8	4	F025000 - K040306		18-15460	—	—
	5.7L	5.7L	1988-96	350	8	4	B525982 - F600999		—	18-15490	—
	5.7L	5.7L (2bbl)	1996	350	8	4	F601000 - K001526		—	18-15490	—
	5.7L	5.7L EFI (2bbl)	1996	350	8	4	F752400 - K001505		—	18-15490	—
	5.7L	5.7L Alpha EFI / 5.7L ALPHA TBI	1995	350	8	4	F355305 - F752389		—	18-15490	—
	5.7L	5.7L Alpha EFI / 5.7L ALPHA TBI	1995	350	8	4	F225560 - F752399		—	18-15490	— (13)
	5.7L	5.7LX EFI / 5.7LX TBI (4bbl)	1996	350	8	4	F752400 - K001505		—	18-15490	— (12)
	5.7L	233	1975-1977	351	8	4	4173000 - 4902304	V-BELT	—	18-15290 (30° BELT)	18-15345
	6.2L	377 SCORPION MCM	1999-2005	377	8	4	L416146 - M907201	SERPENTINE	18-15115	—	—
	7.4L	325 MCM / 325 MIE	1968-1974	427	8	4	2278747 - 3780449	V-BELT	18-15480	—	—
	7.4L	330	1977-1981	454	8	4	4623115 - 6083144	V-BELT	18-15470	—	18-15345
	7.4L	330	1982-1987	454	8	4	6083145 - B816540	V-BELT	18-15470	18-15500 (50° BELT)	18-15345 (12)
	7.4L	330	1982-1987	454	8	4	6083145 - B816540	V-BELT	18-15470	18-15550 (55° BELT)	18-15290 (13)
	7.4L	330 MIE	1977-1980	454	8	4	4623115 - 5889913	V-BELT	18-15470	—	18-15345
	7.4L	340 MIE	1981-1987	454	8	4	5889914 - B788365	V-BELT	18-15470	—	18-15345 (12)
	7.4L	340 MIE	1981-1987	454	8	4	5889914 - B788365	V-BELT	18-15470	—	18-15290 (13)
	7.4L	340	1981-92	454	8	4	5889914 - D715493	V-BELT	18-15470	—	18-15345 (12)
	7.4L	340	1981-92	454	8	4	5889914 - D715493	V-BELT	18-15470	—	18-15290 (13)
	7.4L	350 MIE	1974-1975	454	8	4	3780450 - 4501640	V-BELT	18-15480	—	—
	7.4L	350 MIE	1976	454	8	4	4501641 - 4623109	V-BELT	18-15480	—	18-15345
	7.4L	370 TRS	1978-1985	454	8	4	4179554 - 6721527	V-BELT	18-15480	—	—
	7.4L	370 TRS	1985-1987	454	8	4	6721528 - B714586	V-BELT	18-15480	18-15500	18-15345
	7.4L	400 TRS	1980-1986	454	8	4	4179554 - B457644	V-BELT	18-15480	—	—
	7.4L	420	1987-1989	454	8	4	A398941 - B622418	V-BELT	—	18-15500	18-15345
	7.4L	425	1990-1992	454	8	4	B622419 - D725499	V-BELT	—	18-15500	18-15345
	7.4L	425	1992	454	8	4	D725500 - D937011	V-BELT	—	—	18-15400
	7.4L	440 TRS	1983-1986	454	8	4	4179554 - B485220	V-BELT	18-15480	—	—
	7.4L	450	1995-1996	454	8	4	F347100 - F347277	V-BELT	—	—	18-15400
	7.4L	454 MAG ALPHA	1986-1988	454	8	4	A631894 - B785148	V-BELT	18-15470	18-15500 (50° BELT)	—
	7.4L	454 MAG ALPHA	1986-1988	454	8	4	A631894 - B785148	V-BELT	18-15470	18-15550 (55° BELT)	—
	7.4L	454 MAG	1988-92	454	8	4	B721206 - D805068		18-15470	18-15550	18-15290
	7.4L	454 MAG	1988-92	454	8	4	B721206 - D805068		18-15480	—	18-15290
	7.4L	454 MAG	1992-97	454	8	4	D805069 - K999999		18-15480	—	18-15400

- (1) 1/2" wide (13mm) belt
- (2) 3/8" wide (10mm) belt
- (3) 28" wide (711mm) belt
- (4) 30" wide (762mm) belt
- (5) 37" wide (940mm) belt
- (6) 40" wide (1016mm) belt
- (7) 50" wide (1270mm) belt
- (8) 55" wide (1397mm) belt

- (9) Use with 5 1/2" (140mm) dia water pump pulley
- (10) Use with 5 7/8" (149mm) dia water pump pulley
- (11) Use with 7" (178mm) dia water pump pulley
- (12) Use with stamped steel sea water pump pulley
- (13) Use with cast aluminum sea water pump pulley
- (14) Use with plastic 4 3/4" (121mm) dia p/s pump pulley
- (15) Use with metal 5 3/4" (146mm) dia p/s pump pulley
- (16) For engine with high mounted p/s pump

- (17) For engines with low mounted p/s pump
- (18) For engine with power steering
- (19) For engines w/o power steering
- (20) For engines with closed cooling
- (21) For engines with standard cooling
- (22) Replacement kit includes 5 3/4" (146mm) pulley and longer serpentine belt
- (23) For engines with high mounted alternator

V-BELT APPLICATION

HP	Liter	Model	Years	CID	# Cyl	Stroke	Serial #	Belt Type	Alternator/ Water Pump	Power Steering	Sea Water Pump
	7.4L	454 MAG MPI	1994-97	454	8	4	F115700 - K147349		18-15480	—	18-15400
	7.4L	454 MAG MPI	1997	454	8	4	K147350 - K999999		18-15480	—	18-15290
	7.4L	454 MAG Ski	1995-97	454	8	4	F215800 - K999999		18-15480	—	18-15400
	7.4L	454 MAG BRAVO	1988-1992	454	8	4	B721206 - D805068	V-BELT	18-15470 (9)	18-15550 (9)	18-15290
	7.4L	454 MAG BRAVO	1988-1992	454	8	4	B721206 - D805068	V-BELT	18-15480 (11)	— (11)	18-15290
	7.4L	454 MAG BRAVO	1992-1997	454	8	4	D805069 - K999999	V-BELT	18-15480	—	18-15400
	7.4L	454 MAG EFI	1994-1996	464	8	4	F115700 - F802349	V-BELT	18-15480	—	18-15400
	7.4L	454 MAG EFI SKI	1995-1996	454	8	4	F215800 - F820099	V-BELT	18-15480	—	18-15400
	7.4L	454 MAG MPI	1996-1997	454	8	4	F115700 - F147349	V-BELT	18-15480	—	18-15400
	7.4L	454 MAG MPI	1997	454	8	4	K147350 - K999999	V-BELT	18-15480	—	18-15290
	7.4L	525 SC	1991-1999	454	8	4	D456000 - L415623	V-BELT	—	18-15500	18-15400
	7.4L	7.4L BRAVO	1988-1991	454	8	4	B771113 - D603117	V-BELT	18-15470	18-15550 (9)	18-15290
	7.4L	7.4L BRAVO	1988-1991	454	8	4	B771113 - D603117	V-BELT	18-15480	— (11)	18-15290
	7.4L	7.4L BRAVO	1992-1997	454	8	4	D603118 - K999999	V-BELT	18-15480	—	18-15400
	7.4L	7.4L MIE (WITH B/W)	1988-1992	454	8	4	B788366 - D715493	V-BELT	18-15470	—	18-15290
	7.4L	7.4L MIE (WITH B/W)	1988-1992	454	8	4	B788366 - D715493	V-BELT	18-15470	—	18-15400
	7.4L	7.4L MIE (WITH HURTH)	1989-1992	454	8	4	C391564 - D715493	V-BELT	18-15470 (10)	—	18-15290 (12)
	7.4L	7.4L MIE (WITH HURTH)	1989-1992	454	8	4	C391564 - D715493	V-BELT	18-15480 (11)	—	18-15290 (13)
	7.4L	7.4L MIE	1992-1997	454	8	4	D715494 - K999999	V-BELT	18-15480	—	18-15400
	7.4L	7.4L MPI	1998-2001	454	8	4	L010003 - M024330	SERPENTINE	18-15114 (14, 22)	—	—
	7.4L	7.4L MPI	1998-2001	454	8	4	L010003 - M024330	SERPENTINE	18-15114 (14)	—	—
	7.4L	7.4L MPI / 7.4L MIE	1995-1996	454	8	4	F563052 - F820131	V-BELT	18-15480	—	18-15400
	7.4L	7.4L MPI / 7.4L MIE	1996-1997	454	8	4	F820132 - K999999	V-BELT	18-15480	—	18-15290
	7.4L	7.4LX BRAVO EFI	1996-1997	454	8	4	F820000 - K999999	V-BELT	18-15480	—	18-15290
	7.4L	7.4LX BRAVO MPI	1996-1997	454	8	4	F602010 - K147349	V-BELT	18-15480	—	18-15400
	7.4L	7.4LX BRAVO MPI	1997	454	8	4	K147350 - K999999	V-BELT	18-15480	—	18-15290
	7.4L	7.4LX Bravo MPI	1996-97	454	8	4	F602010 - K147349		18-15480	—	18-15400
	7.4L	7.4L MIE	1992-97	454	8	4	C391564 - K999999		18-15480	—	18-15400
	7.4L	370 TRS	1978-85		8	4	4179554 - 6721527		18-15480	—	—
	7.4L	370 TRS	1985-87		8	4	6721528 - B714586		18-15480	18-15500	—
		390 MCM / 390 MIE	1969-1970	482	8	4	2781129 - 3042731	V-BELT	18-15480	—	—
		400 TRS	1983-1986	482	8	4	4179554 - 6181046	V-BELT	18-15480	—	—
		420/425	1987-1992		8	4	A398941 - D725499		18-15480	18-15500	—
		420 / 425	1992		8	4	D725500 - D937011		18-15480	—	18-15400
		440 TRS	1983-1986		8	4	4179554 - B485220		18-15480	—	—
		450	1995-1996		8	4	F347100 - F347227		18-15480	—	18-15400
		460 TRS	1983-1986		8	4	4179554 - 6181046		18-15480	—	—
		465	1990-1992	502	8	4	C849992 - D725646	V-BELT	—	—	18-15290
	8.2L	465	1992-1994	502	8	4	D725647 - F213244	V-BELT	—	—	18-15400
	8.2L	500	1994-1998	502	8	4	F213293 - L001772	V-BELT	—	—	18-15400
	8.2L	500 GEN +	1999	502	8	4	L414639 - L601036	V-BELT	—	—	18-15400
	8.2L	502 MAG BRAVO	1990-1997	502	8	4	C878221 - D824588	V-BELT	18-15480	—	18-15290
	8.2L	502 MAG BRAVO	1990-1997	502	8	4	C824589 - K999999	V-BELT	18-15480	—	18-15400
	8.2L	502 MAG EFI	1994-1995	502	8	4	D840650 - F802599	V-BELT	18-15480	—	18-15400
	8.2L	502 MAG MPI	1996-1997	502	8	4	F802600 - K147349	V-BELT	18-15480	—	18-15400
	8.2L	502 MAG MPI	1997	502	8	4	K147350 - K999999	V-BELT	18-15480	—	18-15290
	8.2L	502 MAG MPI	1998-2001	502	8	4	L017000 - M024999	SERPENTINE	18-15114 (14, 22)	—	—
	8.2L	502 MAG MPI	1998-2001	502	8	4	L017000 - M024999	SERPENTINE	18-15114 (14)	—	—
	8.2L	600 SC	1991-1992	502	8	4	D456489 - D456768	V-BELT	—	18-15500	18-15345
	8.2L	600 SC	1992-2000	502	8	4	D725676 - L601186	V-BELT	—	18-15500	18-15400
	8.2L	8.2L MIE	1990-1993	502	8	4	C878221 - D857199	V-BELT	18-15480	—	18-15290
	8.2L	8.2L MIE	1993-1997	502	8	4	D857200 - K999999	V-BELT	18-15480	—	18-15400
	8.2L	8.2L MPI MIE	1996-1997	502	8	4	F819620 - K147349	V-BELT	18-15480	—	18-15400
	8.2L	8.2L MPI MIE	1997	502	8	4	K147350 - K999999	V-BELT	18-15480	—	18-15290
	8.2L	500 BULLDOG	1990-2001	540	8	4	C577254 - M050281	V-BELT	— (3/8" BELT WIDTH)	—	18-15345
	8.2L	500 BULLDOG	1990-2001	540	8	4	C577254 - M050281	V-BELT	— (1/2" BELT WIDTH)	—	18-15345

- (1) 1/2" wide (13mm) belt
- (2) 3/8" wide (10mm) belt
- (3) 28" wide (711mm) belt
- (4) 30" wide (762mm) belt
- (5) 37" wide (940mm) belt
- (6) 40" wide (1016mm) belt

- (7) 50" wide (1270mm) belt
- (8) 55" wide (1397mm) belt
- (9) Use with 5 1/2" (140mm) dia water pump pulley
- (10) Use with 5 7/8" (149mm) dia water pump pulley
- (11) Use with 7" (178mm) dia water pump pulley
- (12) Use with stamped steel sea water pump pulley

- (13) Use with cast aluminum sea water pump pulley
- (14) Use with plastic 4 3/4" (121mm) dia p/s pump pulley
- (15) Use with metal 5 3/4" (146mm) dia p/s pump pulley
- (16) For engine with high mounted p/s pump
- (17) For engines with low mounted p/s pump
- (18) For engine with power steering

- (19) For engines w/o power steering
- (20) For engines with closed cooling
- (21) For engines with standard cooling
- (22) Replacement kit includes 5 3/4" (146mm) pulley and longer serpentine belt
- (23) For engines with high mounted alternator

SERPENTINE BELTS



BELT INTERCHANGE

Part No.	OE #	Width	Length (in.)	Part No.	OE #	Width	Length (in.)
18-15100	57-8638763, 57-862807, 57-862087A1, 57-865615003, 57-865615Q03	13/16	106.25	18-15114	57-861049, 57-861049Q	13/16	104.25
18-15101	57-8638764, 57-862086, 57-8620861, 57-862086A1, 57-865615004, 57-865615Q04	13/16	76.5	18-15115	57-861757, 57-861757Q	13/16	97.5
18-15102	57-8638766, 57-8610491, 57-865615006, 57-865615Q06	13/16	105	18-15116	57-861758, 57-861758Q	13/16	86.75
18-15103	57-8638767, 57-865615007, 57-861050, 57-865615Q07	13/16	96.75	18-15117	57-861759	13/16	92.5
18-15104	57-8638768, 57-862089, 57-862089A1, 57-865615008, 57-865615Q08	13/16	99.5	18-15119	57-8638761, 57-8623523, 57-865615001, 57-865615Q01	13/16	111.25
18-15105	57-8638769, 57-865615009, 57-862088, 57-862088A1, 57-865615Q09	13/16	69.75	18-15121	57-865615005, 57-865615Q05, 57-8638765, 57-865423005	13/16	87.5
18-15112	57-8077554, 57-807755Q04	13/16	88	18-15122	57-865615010, 57-86387610, 57-865615Q10	13/16	86
18-15113	57-8077555	13/16	75.75	18-15123	57-864639	13/16	85
				18-15124	57-881754	1-1/16	55.75
				18-15125	57-817113	1 3/8	53.5

BELT APPLICATION

Engine	Years	Serial #	Part #	Mercuriser #	Foothole	Engine	Years	Serial #	Part #	Mercuriser #	Foothole
4.3L Alpha	1996-99	OF803000-OL618999	18-15116	57-861758	2, 6	5.7L Alpha	1997-99	OK001506-OL618999	18-15116	57-861758	2, 6
4.3L Alpha	2000-04	OL619000 & up	18-15101	57-863876 4	3, 6, 7	5.7L Alpha	2000-04	OL619000 & up	18-15101	57-863876 4	3, 6, 7
4.3L Alpha	2000-04	OL619000 & up	18-15104	57-863876 8	4, 5, 7	5.7L Alpha	2002-04	OM600000 & up	18-15102	57-863876 6	3, 5, 7
4.3L Alpha	2000-04	OL619000 & up	18-15105	57-865615009	4, 6, 7	5.7L Alpha	2000-04	OL619000 & up	18-15104	57-863876 8	4, 5, 7
4.3L Bravo	1996-99	OF803000-OL618999	18-15114	57-861049	2, 5	5.7L Alpha	2000-05	OL619000 & up	18-15105	57-865615009	4, 6, 7
4.3L Bravo	1996-99	OF803000-OL618999	18-15115	57-861757	2, 6	5.7L Bravo	1997-99	OK001506-OL618999	18-15114	57-861049	2, 5
4.3L Bravo	2000-04	OL619000 & up	18-15104	57-863876 8	4, 7	5.7L Bravo	1997-99	OK001506-OL618999	18-15115	57-861757	2, 6
5.0L Bravo	2002-04	OM600000 & up	18-15102	57-863876 6	3, 5, 7	5.7L Bravo	2002-04	OM600000 & up	18-15102	57-863876 6	3, 5, 7
5.0L Alpha	1998-99	OL012052-OL618999	18-15114	57-861049	5	5.7L Bravo	2000-04	OL619000 & up	18-15104	57-863876 8	4, 7
5.0L Alpha	1998-99	OL012052-OL618999	18-15116	57-861758	2,6	5.7L Ski	1997-02	OK040004-OM316999	18-15112	57-8077554	
5.0L Alpha	2000-04	OL619000 & up	18-15101	57-863876 4	3, 6, 7	5.7L Ski	2002-05	OM317000 & up	18-15121	57-865615005	
5.0L Alpha	2002-04	OM600000 & up	18-15102	57-863876 6	3, 5, 7	5.7L MIE	2001-05	OL677227 & up	18-15121	57-865615005	
5.0L Alpha	2001-04	OL619000 & up	18-15104	57-863876 8	4, 5, 7	377 Scorpion MCM	1999-04	OL416146 & up	18-15115	57-861757	
5.0L Alpha	2000-04	OL619000 & up	18-15105	57-865615009	4, 6, 7	377 Scorpion Ski	1997-98	OK000656 & up	18-15112	57-8077554	
5.0L Bravo	1998-99	OL012052-OL618999	18-15114	57-861049	2, 5	454 Mag MPI	1998-01	OL010029-OM024999	18-15114	57-861049	1
5.0L Bravo	1998-99	OL012052-OL618999	18-15115	57-861757	2, 6	454 Mag MPI	1998-01	OL010029-OM024999	18-15102	57-863876 6	2
5.0L Bravo	2000-04	OL619000 & up	18-15104	57-863876 8	4, 7	454 Mag MPI	1998-01	OL010029-OM024999	18-15103	57-865615007	4
350 Mag, Alpha	1997-04	OK001501-OL618999	18-15114	57-861049	2, 5	454 Mag MPI Horizon MIE	1998-01	OL002200-OL674000	18-15103	57-865615007	
350 Mag, Alpha	1997-04	OK001501-OL618999	18-15116	57-861758	2, 6	496 Mag & HO	2000-04	OM025000 & up	18-15119	57-863876 1	
350 Mag, Alpha	2000-04	OL619000 & up	18-15103	57-865615007	3, 6, 7	500 EFI	1999-04	OL001477 & up	18-15112	57-8077554	
350 Mag, Alpha	2002-04	OM600000 & up	18-15102	57-863876 6	3, 5, 7	502 Mag MPI	1998-01	OL017000-OM024999	18-15114	57-861049	1
350 Mag, Alpha	2000-04	OL619000 & up	18-15104	57-863876 8	4, 5, 7	502 Mag MPI	1998-01	OL017000-OM024999	18-15103	57-865615007	4
350 Mag, Alpha	2000-04	OL619000 & up	18-15105	57-865615009	4, 6, 7	502 Mag, MPI	1998-01	OL017000-OM024999	18-15102	57-863876 6	2
350 Mag, Bravo	1997-04	OK001501-OL618999	18-15114	57-861049	2, 5	525 SC	1991-96	OD456000-745215	18-15125	57-817113	
350 Mag, Bravo	1997-04	OK001501-OL618999	18-15115	57-861757	2, 6	575 Sci	2000-05	OL306696 & up	18-15125	57-817113	8
350 Mag, Bravo	2002-04	OM600000 & up	18-15102	57-863876 6	3, 5, 7	575 Sci	2000-05	OL306696 & up	18-15112	57-8077554	9
350 Mag, Bravo	2000-04	OL619000 & up	18-15104	57-863876 8	4, 7	600 SC	1991-96	OD456489-OF877462	18-15125	57-817113	
350 Mag MPI MIE	2001-05	OL678399-up	18-15121	57-865615005	6	600 SC	1998	OK000227 & up	18-15125	57-817113	
350 Mag MPI MIE	2002-05	OM317000 & up	18-15122	57-865615010	5	7.4L MPI	1998-01	OL010003-OM024330	18-15114	57-861049	1
350 Mag MPI Ski	2001-05	OM300000 & up	18-15121	57-865615005		7.4L MPI	1998-01	OL010003-OM024330	18-15102	57-863876 6	2
350 Mag MPI Horizon MIE	2001-02	OL678399-OM316999	18-15121	57-865615005		7.4L MPI	1998-01	OL010003-OM024330	18-15103	57-865615007	4
350 Mag MPI Horizon MIE	2001-05	OM317000 & up	18-15122	57-865615010		7.4L MPI MIE	1998-01	OL002006-OM025999	18-15103	57-865615007	
5.7L Alpha	1997-99	OK001501-OL618999	18-15114	57-861049	2, 5	Black Scorpion Ski	1997-01	OK040001-OM391599	18-15112	57-8077554	

Footnotes

1: Use with plastic 4-3/4" dia. p/s pump pulley
 2: Use with metal 5-3/4" dia. p/s pump pulley
 3: For engines with power steering

4: For engines without power steering
 5: For engines with closed cooling
 6: For engines with standard cooling

7: Engines with high mounted alternators
 8: Blower
 9: Alternator

BELT APPLICATION

Engine	Years	Serial #	Part #	Mercruiser #	Foothole	Engine	Years	Serial #	Part #	Mercruiser #	Foothole
Black Scorpion Ski	2003-05	OM391600 & up	18-15121	57-865615005		MX 6.2L MPI Horizon MIE	2001-05	OM310100 & up	18-15121	57-865615005	6
MX 6.2L Blk Scorpion Ski	2001	OL670015-OM391599	18-15112	57-8077554		MX 6.2L MPI Horizon MIE	2002-05	OM317000 & up	18-15122	57-865615010	5
MX 6.2L MPI	2002-04	OM600000 & up	18-15102	57-863876 6	3, 5	MX 6.2L MPI MIE	1999-01	OL670000-OM310099	18-15112	57-8077554	
MX 6.2L MPI	2000-04	OL680003 & up	18-15104	57-863876 8	4, 7	MX 6.2L MPI MIE	2001-05	OM310100 & up	18-15121	57-865615005	6
MX 6.2L MPI Horizon	2002-04	OM600000 & up	18-15102	57-863876 6	3	MX 6.2L MPI MIE	2002-05	OM317000 & up	18-15122	57-865615010	5
MX 6.2L MPI Horizon	2001-04	OM300000 & up	18-15104	57-863876 8	4	MX 6.2L MPI Ski	2002-05	OM317000 & up	18-15121	57-865615005	
MX 6.2L MPI Horizon MIE	2001	OM300000-OM310099	18-15112	57-8077554		8.2L MPI MIE	1998-01	OL002450-OL674200	18-15103	57-865615007	

Footnotes

- 1: Use with plastic 4-3/4" dia. p/s pump pulley
- 2: Use with metal 5-3/4" dia. p/s pump pulley
- 3: For engines with power steering
- 4: For engines without power steering

- 5: For engines with closed cooling
- 6: For engines with standard cooling
- 7: Engines with high mounted alternators
- 8: Blower
- 9: Alternator

Fits GM Big Block V8 454 cu. in. Models 330, 340 & 7.4L

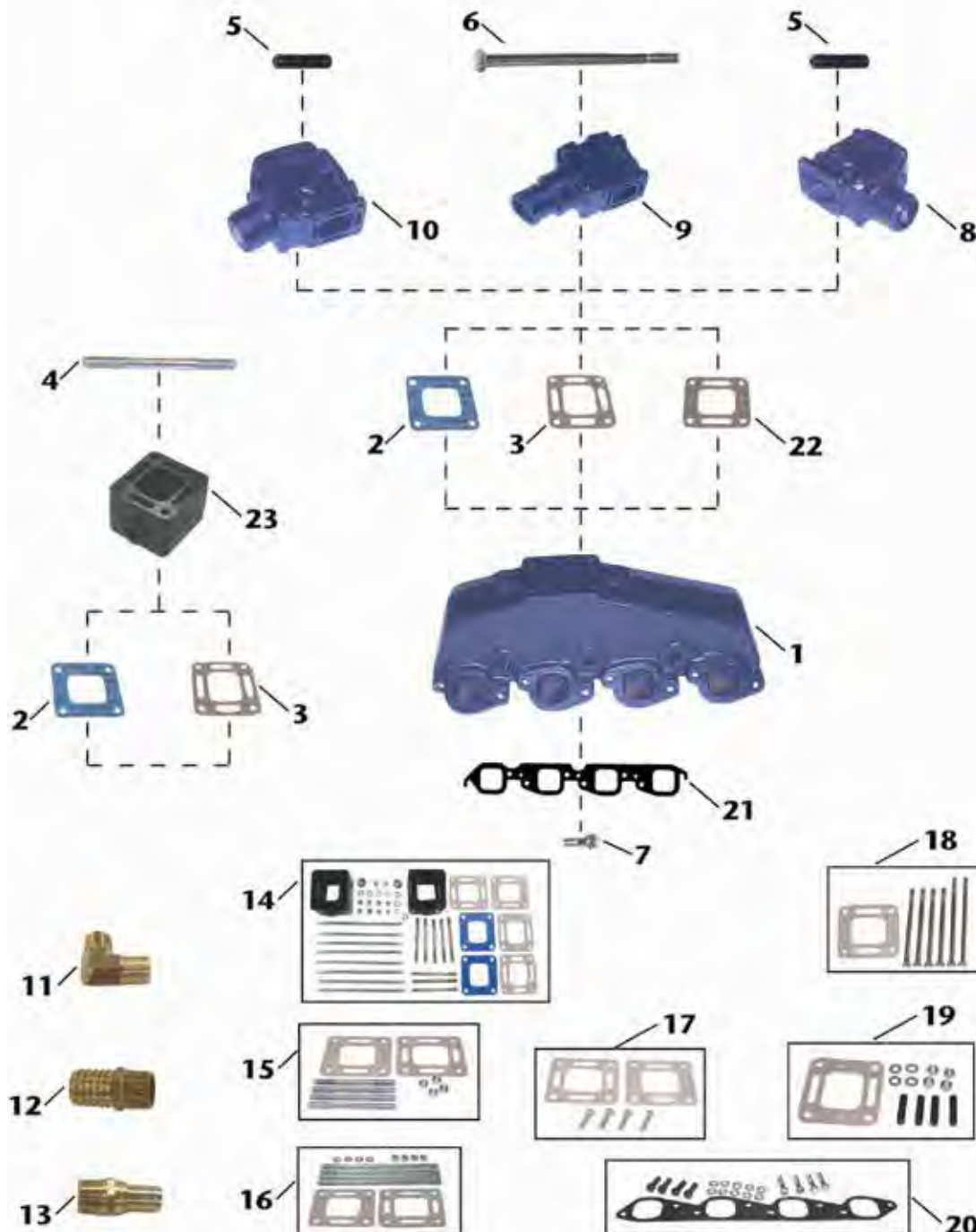

SEE NEXT PAGE FOR CHART

Item No.	Description	OE No.	Application	
1	18-1957-2	MANIFOLD	807078A6	GM Big Block (V8) 454 cu.in. Models 330, 340 & 7.4L. Use with 18-0418 manifold gasket; Mounting Kit: 18-8532
2	18-0672 (blocked)	ELBOW GASKET (Blocked)	27-860231	Fits Manifold: 18-1957-2; Elbows: 18-1970-2, & 18-1976-2, 18-1974; Spacer 18-1908
3	18-2849-1	ELBOW GASKET (Open)	27-818832	Fits Manifold: 18-1957-2; Elbows: 18-1970-2, & 18-1976-2, 18-1974; Spacer 18-1908
4	NSS	MOUNTING STUD	N/A	Included in 18-8554 mounting kit
5	NSS	MOUNTING STUD	N/A	Included in 18-8529 mounting kit
6	NSS	MOUNTING BOLT	N/A	Included in 18-8505 mounting kit
7	NSS	MOUNTING BOLT	N/A	Included in 18-8532 mounting kit
8	18-1974-1	MANIFOLD ELBOW (3" hose • 15° down angle)	98502A2	Fits Manifold: 18-1957-2. Use Elbow gaskets: 18-2849-1, 18-0897, or 18-0672; Use mounting kit: 18-8529 (Do not use with spacer)
9	18-1976-2	MANIFOLD ELBOW (4" hose • 7° down angle)	44354A3	Fits Manifold: 18-1957-2. Use Elbow gaskets: 18-2849-1, 18-0897, or 18-0672; Use mounting kit: 18-8505, or if spacer is included use 18-8555
10	18-1970-2	MANIFOLD ELBOW (3" hose)	98504A3	Fits Manifold: 18-1957-2. Use Elbow gaskets: 18-2849-1, 18-0897, or 18-0672; Use mounting kit: 18-8529, or if spacer is included use 18-8554
11	18-8216	HOSE FITTING	N/A	3/4" - 14NPT X 1" Hose (Corrosion Resistant Brass Fitting)
12	18-4461	HOSE FITTING	N/A	3/4" - 14NPT X 1" Hose (Corrosion Resistant Brass Fitting)
13	18-8215	HOSE FITTING	N/A	3/4" - 14NPT X 3/4" Hose (Corrosion Resistant Brass Fitting)
14	18-1908K	MANIFOLD SPACER KIT	807476A6, 93320A5	3" Riser Kit for Manifold: 18-1957-2. Includes (2) spacers, restrictor, open, & blocked gasket. All necessary mounting hardware is also included
15	18-8554	MOUNTING KIT	N/A	Use 18-8554 Mounting Kit when 18-1908 Spacer, 18-1970-2 Elbow and 18-1974 Elbow are used together. Included in 18-1908K. Includes (1) 18-2849-1 & 18-0897 elbow gaskets
16	18-8555	MOUNTING KIT	N/A	Use with Manifold Spacer: 18-1908 with Riser 18-1976-2. Included in 18-1908K. Includes (1) 18-2849-1 & 18-0897 elbow gaskets.
17	18-8556	MOUNTING KIT	N/A	Use with Manifold Spacer: 18-1985. Includes (1) 18-2849-1 & 18-0897 elbow gaskets
18	18-8505	MOUNTING KIT	N/A	Use with Riser: 18-1976-2. Includes 18-0897 elbow gasket
19	18-8529	MOUNTING KIT	N/A	Use with Risers: 18-1970-2 & 18-1974-1. Includes 18-0897 elbow gasket
20	18-8532	MOUNTING KIT	N/A	Use with Manifold: 18-1957-2. Includes 18-0418 manifold gasket
21	18-0418	MANIFOLD GASKET	96653 / 27-41813	Use with Manifold: 18-1957-2. Included in 18-8532 mounting kit.
22	18-0897	ELBOW GASKET (Restrictor)	27-41813	Fits Manifold: 18-1957-2; Manifold Spacers: 18-1985, & 18-1908; Elbows: 18-1970-2, & 18-1976-2, 18-1974
23	18-1908	MANIFOLD SPACER	93322A12	3" Spacer for Manifold: 18-1952-1. Use with mounting kit 18-8556 (Note: To mount elbows to spacer a separate mounting kit is needed)



**Fits GM In-Line 6 Cylinder 250 & 292 cu. in.
Models 165 & 200**

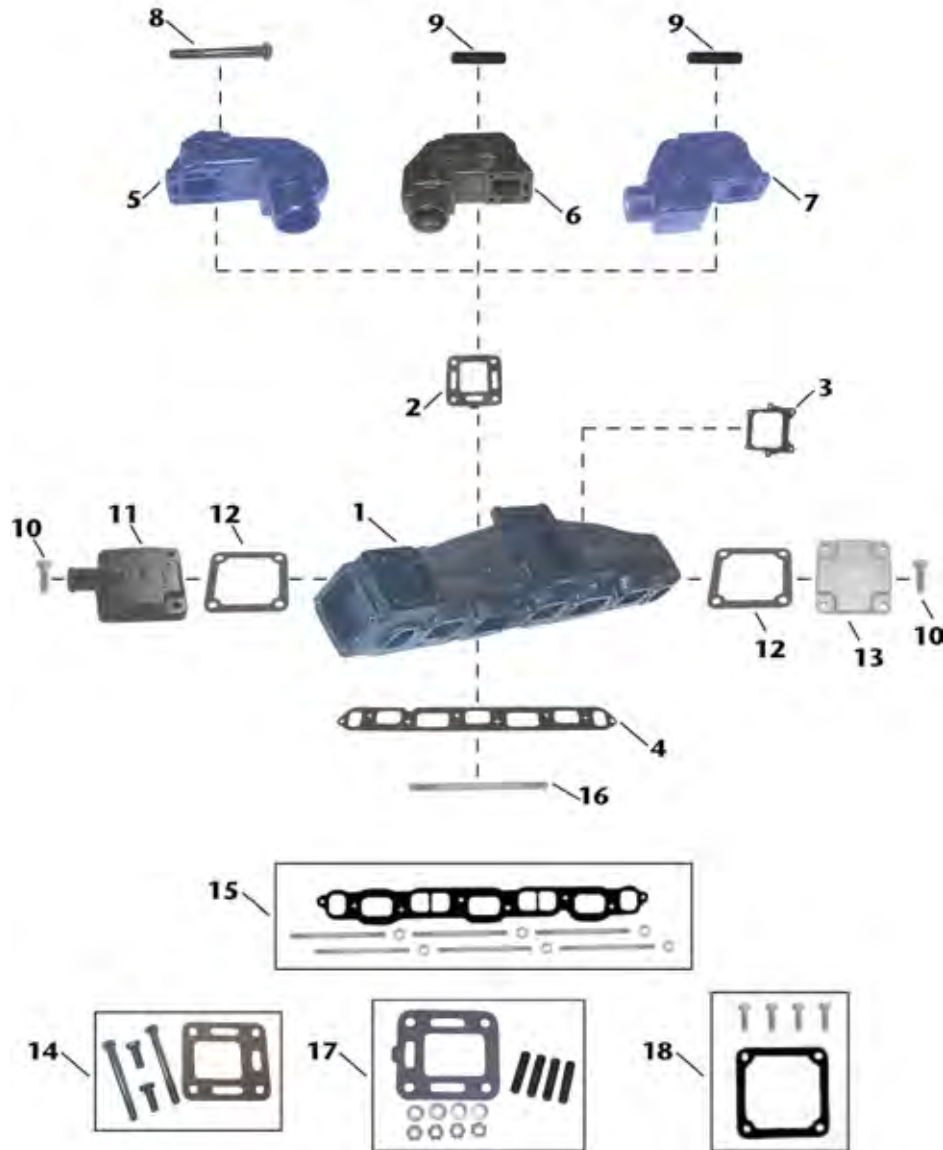

Item No.	Description	OE No.	Application	
1	18-1960-1	MANIFOLD	58759A10	GM In-Line Six Cylinder 250 & 292 cu.in. Models 165 & 200. Use with 18-2830-1 manifold gasket; 18-8531 Mounting Kit
2	18-2833	ELBOW GASKET	27-99777-2	Use with Elbows: 18-1971, 18-1978 & 18-1972. Included in 18-4362 mounting kit
3	18-0353	CARBURETOR GASKET	27-58764	Fits Manifold: 18-1960-1
4	18-2830-1	MANIFOLD GASKET	27-46401	Fits Manifold: 18-1960-1. Included in 18-8531 mounting kit.
5	18-1972	MANIFOLD ELBOW	76325A2	Use with Manifold: 18-1960-1; Elbow Gasket 18-2833
6	18-1971	MANIFOLD ELBOW	76351A2	Use with Manifold: 18-1960-1; Elbow Gasket 18-2833; Mounting Kit 18-4362
7	18-1978	MANIFOLD ELBOW	76771A3	Use with Manifold: 18-1960-1; Elbow Gasket 18-2833; Mounting Kit 18-4362
8	NSS	MOUNTING BOLT	N/A	Included in 18-8552 mounting hardware
9	18-3233	MOUNTING STUD	16-49545	3/8-24, 3/8-16 X 1 3/4. Included in 18-4362 mounting kit.
10	NSS	MOUNTING BOLT	N/A	Included in 18-8512 mounting kit.
11	18-4009	FRONT PLATE	60252A2	Fits Manifold: 18-1960-1
12	18-2832-1	FRONT/END PLATE GASKET	27-48043-1	Fits Port & Starboard Caps of Manifold: 18-1960-1. Included in 18-8512 mounting kit
13	NSS	END PLATE	N/A	Fits Manifold: 18-1960-1
14	18-8552	HARDWARE KIT	N/A	Includes only hardware for 18-1972 elbow.
15	18-8531	MOUNTING KIT	N/A	Use with Manifold: 18-1960-1. Includes 18-2830-1 manifold gasket.
16	NSS	MOUNTING STUD	N/A	Included in 18-8531 mounting kit
17	18-4362	MOUNTING KIT	N/A	Use with Elbows: 18-1971 & 18-1978. Includes 18-2833 elbow gasket
18	18-8512	MOUNTING KIT	N/A	Use with Front Plate: 18-4009. Includes 18-2832-1 gasket

Fits GM V6 229 & 262 cu. in. Models 185 & 205

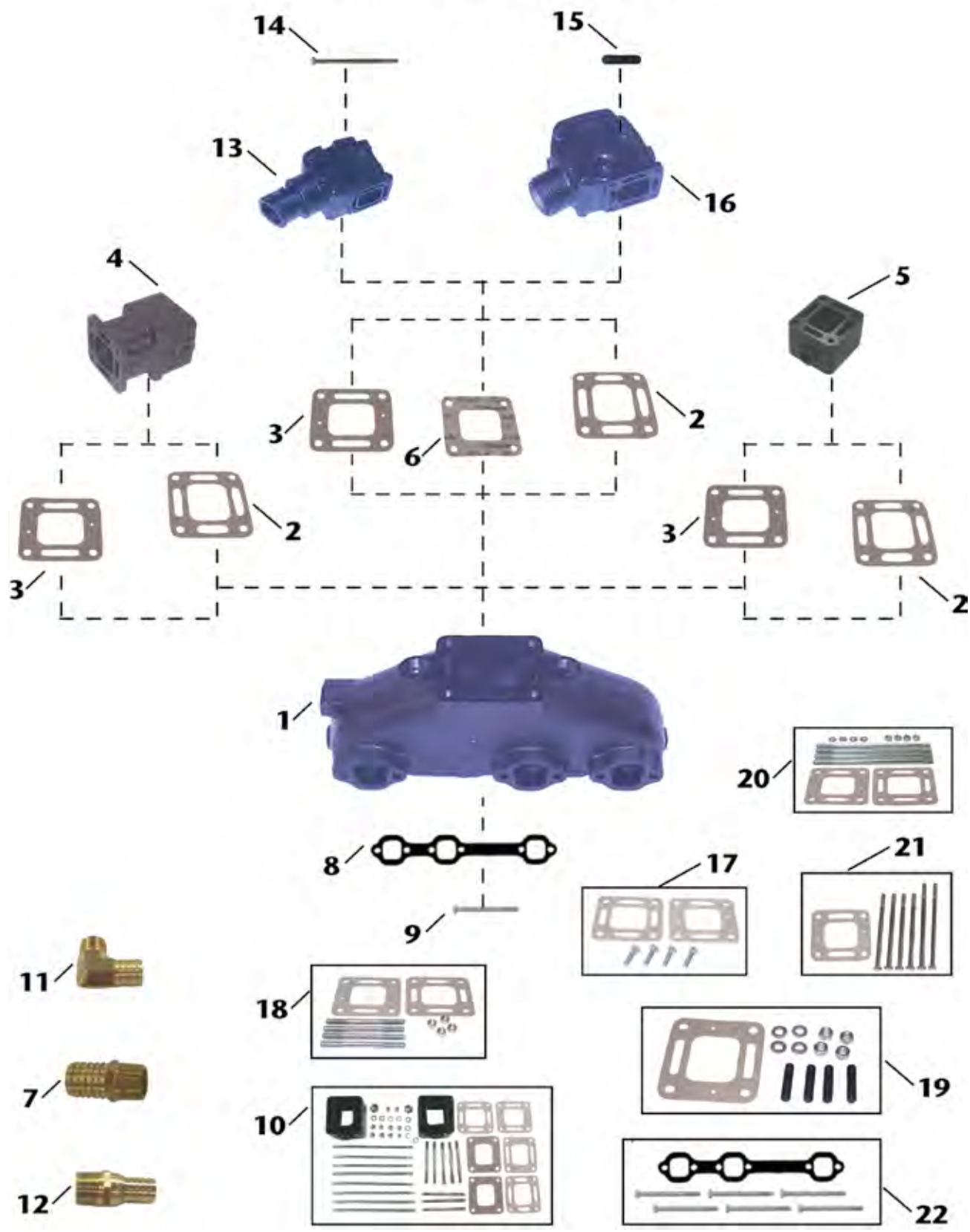

Item No.	Description	OE No.	Application	
1	18-1952-1	MANIFOLD	99746A8	GM (V6) 229 & 262 cu.in. Models 185 & 205 (Port & Starboard). Use with Manifold Gasket: 18-2909; Mounting Kit: 18-8533.
2	18-2849-1	ELBOW GASKET (OPEN)	27-818832	Fits Manifold: 18-1952-1; Manifold Spacers: 18-1985, & 18-1908; Elbows: 18-1970-2, & 18-1976-2
3	18-0897	ELBOW GASKET (RESTRICTOR)	27-41813	Fits Manifold: 18-1952-1; Manifold Spacers: 18-1985, & 18-1908; Elbows: 18-1970-2, & 18-1976-2
4	18-1985	MANIFOLD SPACER	93322A12	6" Spacer for Manifold: 18-1952-1. Use with mounting kit 18-8556. (Note: To mount elbows to spacer a separate mounting kit is required)
5	18-1908	MANIFOLD SPACER	933220	3" Spacer for Manifold: 18-1952-1. Use with mounting kit 18-8555 with 18-1976-2, or mounting kit 18-8554 with 18-1970-2.
6	18-0672	ELBOW GASKET (BLOCKED)	27-860231	Fits Manifold: 18-1952-1; Elbows: 18-1970-2, & 18-1976-2
7	18-4461	HOSE FITTING	N/A	3/4" - 14NPT X 1" Hose (Corrosion Resistant Brass Fitting)
8	18-2909	MANIFOLD GASKET	N/A	Gasket for Manifold: 18-1952-1. Included in 18-8533 mounting kit.
9	NSS	MOUNTING BOLT	N/A	Included in 18-8533 mounting kit.
10	18-1908K	MANIFOLD SPACER KIT	807476A6, 93320A5	3" Riser Kit for Manifold: 18-1952-1. Includes (2) spacers, restrictor, open, & blocked gasket. All necessary mounting hardware is also included.
11	18-8216	HOSE FITTING	N/A	3/4" - 14NPT X 1" Hose (Corrosion Resistant Brass Fitting)
12	18-8215	HOSE FITTING	N/A	3/4" - 14NPT X 3/4" Hose (Corrosion Resistant Brass Fitting)
13	18-1976-2	MANIFOLD ELBOW (4" hose • 7° down angle)	44354A3, 807914A1	Fits Manifold: 18-1952-1. Use Elbow gaskets: 18-2849-1, 18-0897, or 18-0672; Use mounting kit: 18-8554
14	NSS	MOUNTING BOLT	N/A	Included in 18-8505 mounting kit.
15	NSS	MOUNTING STUD	N/A	Included in 18-8529 mounting kit.
16	18-1970-2	MANIFOLD ELBOW (3" hose • 0° down angle)	98504A3	Fits Manifold: 18-1952-1. Use Elbow gaskets: 18-2849-1, 18-0897, or 18-0672; Use mounting kit: 18-8529, or if spacer is included use 18-8555
17	18-8556	MOUNTING KIT	N/A	Use with Manifold Spacer: 18-1985. Includes (1) 18-2849-1 & 18-0897
18	18-8554	MOUNTING KIT	N/A	Use with Manifold Spacer: 18-1908 with Riser 18-1970-2. Included in 18-1908K. Includes (1) 18-2849-1 & 18-0897 elbow gaskets.
19	18-8529	MOUNTING KIT	N/A	Use with Riser: 18-1970-2. Includes 18-0897 elbow gaskets
20	18-8555	MOUNTING KIT	N/A	Use with Manifold Spacer: 18-1908 with Riser 18-1976-2. Included in 18-1908K. Includes (1) 18-2849-1 & 18-0897 elbow gasket.
21	18-8505	MOUNTING KIT	N/A	Use with Riser: 18-1976-2. Includes 18-0897 elbow gasket.
22	18-8533	MOUNTING KIT	N/A	Use with Manifold: 18-1952-1. Includes 18-2909 manifold gasket.



Fits GM Small Block V8 305-350 cu. in. Models 198, 228 & 898

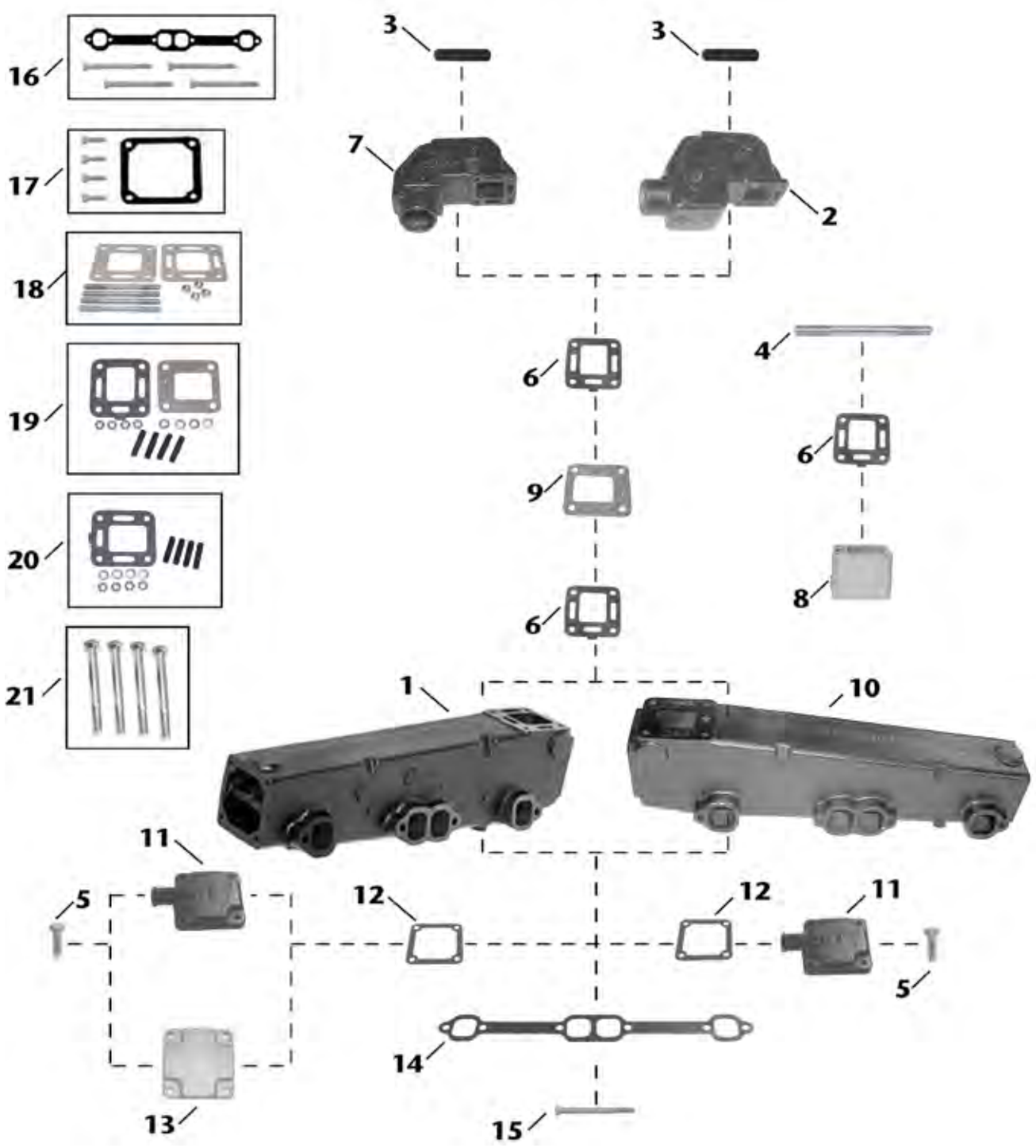

Item No.	Description	OE No.	Application	
1	18-1951-1	MANIFOLD (STARBOARD)	774235A2	GM Small Block (V8) 305-350 cu.in. Models 198, 228, & 898. (Starboard)
2	18-1978	MANIFOLD ELBOW	76771A3	Use with Manifolds: 18-1950-1, 18-1951-1; Elbow Gasket 18-2833; Mounting Kit 18-4362.
3	18-3233	MOUNTING STUD	16-49545	3/8-24, 3/8-16 X 1 3/4. Included in 18-4362 mounting kit.
4	NSS	MOUNTING STUD	N/A	Included in 18-8554 mounting kit.
5	NSS	MOUNTING BOLT	N/A	Included in 18-8512 mounting kit.
6	18-2833	ELBOW GASKET	27-99777-2	Use with Elbows: 18-1971 & 18-1978. Included in 18-4362 mounting kit.
7	18-1971	MANIFOLD ELBOW	76351A2	Use with Manifolds: 18-1950-1, 18-1951-1; Elbow Gasket 18-2833; Mounting Kit 18-4362.
8	18-1906	MANIFOLD SPACER	61851	3" Spacer for Manifold: 18-1950-1, 18-1951-1. Use with mounting kit 18-8554 with 18-1971 or 18-1978 Elbows.
9	18-4008	BLOCK OFF PLATE	60207	Use with Manifolds 18-1950-1, 18-1951-1. Requires (2) 18-2833 elbow gaskets.
10	18-1950-1	MANIFOLD (PORT)	77234A2	GM Small Block (V8) 305-350 cu.in. Models 198, 228, & 898. (Port)
11	18-4009	END PLATE	60252A2	Use with (Port & Starboard) Manifolds: 18-1950-1 & 18-1951-1; Mounting Kit: 18-8512
12	18-2832-1	FRONT/END PLATE GASKET	27-48043-1	Fits Port & Starboard Caps of Manifolds: 18-1950-1, 18-1951-1. Use with Front Plate: 18-4009. Included in 18-8512 mounting kit.
13	NSS	END PLATE	54870	Fits Manifold: 18-1950-1, 18-1951-1; Mounting Kit: 18-8512.
14	18-2949	MANIFOLD GASKET	96306	Use with Manifold: 18-1951-1
15	NSS	MOUNTING BOLT	N/A	Included in 18-8520 mounting kit.
16	18-8520	MOUNTING KIT	N/A	Use with Manifolds: 18-1950-1, 18-1951-1. Includes 18-2949 manifold gasket.
17	18-8512	MOUNTING KIT	N/A	Use with Front/End Plates: 18-4009. Includes 18-2832-1 front end plate gasket.
18	18-8554	MOUNTING KIT	N/A	Use with Manifold Spacer: 18-1906 with Riser 18-1971 or 18-1978 Elbows. Included in 18-1908K. Includes (1) 18-2849-1 & 18-0897 elbow gaskets.
19	18-8514	MOUNTING KIT	N/A	Use with Elbows: 18-1971 & 18-1978. Includes 18-2833 gasket & 18-4008 block off plate.
20	18-4362	MOUNTING KIT	N/A	Use with Elbows: 18-1971 & 18-1978. Includes 18-2833 elbow gasket.
21	18-8548	HARDWARE KIT	N/A	Includes only hardware for 18-1950-1 & 18-1951-1 manifolds. Included in 18-8520 mounting kit.



**Fits Ford Small Block V8 302-351 cu. in.
Models 215, 225, 233, 255 & 888**

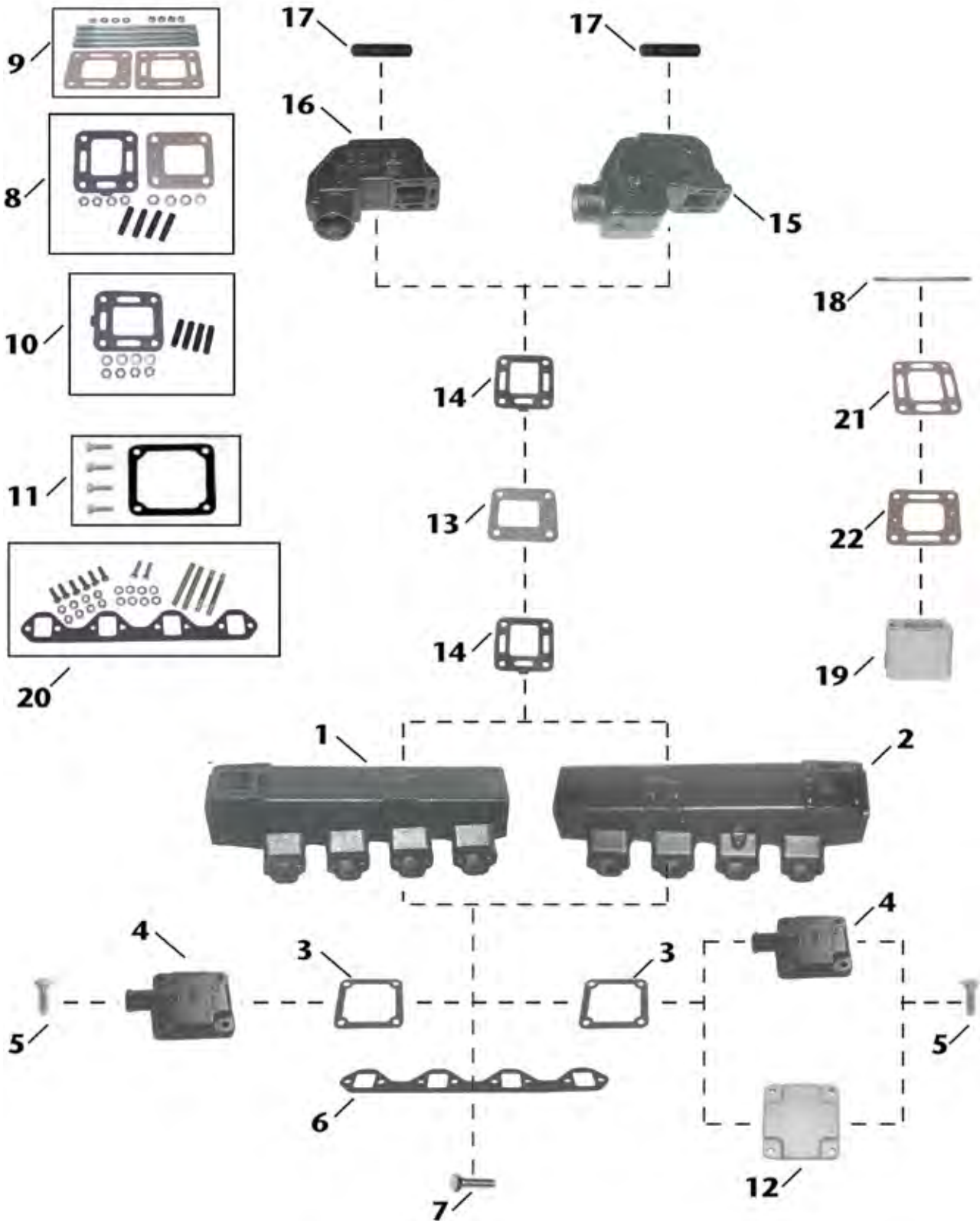

Item No.	Description	OE No.	Application	
1	18-1958-1	MANIFOLD (PORT)	65604A4	Ford Small Block (V8) 302-351 cu.in. Models 215, 225, 233, 255, & 888 (Port). Use with Manifold Gasket: 18-0183-1; Mounting Kit: 18-8509
2	18-1962-1	MANIFOLD (STARBOARD)	65603A4	Ford Small Block (V8) 302-351 cu.in. Models 215, 225, 233, 255, & 888 (Port). & 888 (Starboard). Use with Manifold Gasket: 18-0183-1; Mounting Kit: 18-8509.
3	18-2832-1	FRONT/END PLATE GASKET	27-48043-1	Fits Port & Starboard Caps of Manifolds: 18-1958-1, 18-1962-1. Use with Front Plate: 18-4009. Included in 18-8512 mounting kit.
4	18-4009	FRONT PLATE	60252A2	Use with (Port & Starboard) Manifolds: 18-1958-1, 18-1962-1; Mounting Kit: 18-8512
5	NSS	MOUNTING BOLT	N/A	Included in 18-8512 mounting kit.
6	18-0183-1	MANIFOLD GASKET	27-73866	Use with Manifold: 18-1958-1, 18-1962-1. Included in 18-8509 mounting kit.
7	NSS	MOUNTING BOLT	N/A	Included in 18-8509 mounting kit.
8	18-8514	MOUNTING KIT	N/A	Use with Elbows: 18-1971 & 18-1978. Includes 18-2833 gasket & 18-4008 block off plate.
9	18-8554	MOUNTING KIT	N/A	Use with Manifold Spacer: 18-1906 with Riser 18-1971 or 18-1978. Includes (1) 18-2849-1 & 18-0897 elbow gaskets.
10	18-4362	MOUNTING KIT	N/A	Use with Elbows: 18-1971 & 18-1978. Includes 18-2833 elbow gasket.
11	18-8512	MOUNTING KIT	N/A	Use with Front/End Plates: 18-4009. Includes 18-2832-1 gasket.
12	NSS	END PLATE	54870	Fits Manifolds: 18-1958-1, 18-1962-1; Mounting Kit: 18-8512.
13	18-4008	BLOCK OFF PLATE	60207	Use with Manifolds 18-1958-1, 18-1962-1. Requires (2) 18-2833 elbow gaskets.
14	18-2833	ELBOW GASKET	27-99777-2	Use with Elbows: 18-1971 & 18-1978. Included in 18-4362 mounting kit.
15	18-1978	MANIFOLD ELBOW	76771A3	Use with Manifolds: 18-1958-1, 18-1962-1; Elbow Gasket 18-2833; Mounting Kit 18-4362.
16	18-1971	MANIFOLD ELBOW	76351A2	Use with Manifolds: 18-1958-1, 18-1962-1; Elbow Gasket 18-2833; Mounting Kit 18-4362.
17	18-3233	MOUNTING STUD	16-49545	3/8-24, 3/8-16 X 1 3/4. Included in 18-4362 mounting kit.
18	NSS	MOUNTING STUD	N/A	Included in 18-8554 mounting kit.
19	18-1906	MANIFOLD SPACER	61851	3" Spacer for Manifolds: 18-1950-1, 18-1951-1. Use with mounting kit 18-8554 with 18-1971 or 18-1978 Elbows.
20	18-8509	MOUNTING KIT	N/A	Use with Manifolds: 18-1958-1, 18-1962-1. Includes 18-0183-1 manifold gasket.
21	18-2849-1	ELBOW GASKET (OPEN)	27-818832	Fits Manifolds: 18-1958-1, 18-1962-1; Manifold Spacers: 18-1985. Included in 18-8554 mounting kit.
22	18-0897	ELBOW GASKET (RESTRICTOR)	27-41813	Fits Manifolds: 18-1958-1, 18-1962-1; Manifold Spacers: 18-1985. Included in 18-8554 mounting kit.



Fits GM 4 Cylinder 181 cu. in. Models 120, 140, 2.5L & 3.0L

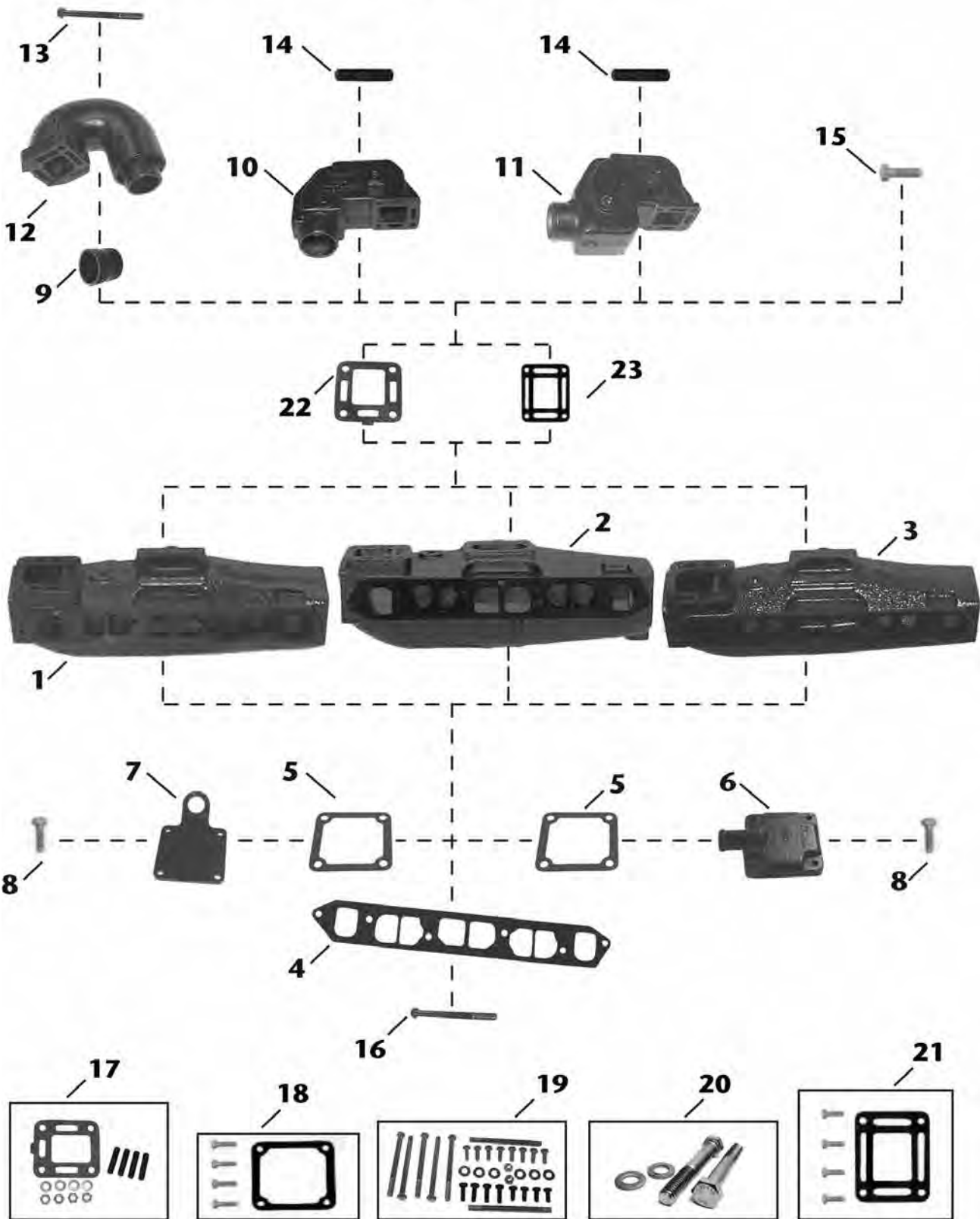

Item No.	Description	OE No.	Application	
1	18-1954-1	MANIFOLD	9582A5	Fits 2.5 & 3.0L 181 CID, Model 140 with Rochester carburetor w/ electrical choke (1983-89). Use with Manifold Gasket: 18-1204-1.
2	18-1955-1	MANIFOLD	96705A1	Fits 3.0L 181 CID, Model 140 with Rochester carburetor w/ mechanical choke (1968-82). Use with Manifold Gasket: 18-1204-1. Mounting Hardware: 18-8549.
3	18-1956-3	MANIFOLD	99798A18	Fits 3.0L 181 CID, Model 140 & 3.0 with Mercarb carburetor w/ electrical choke (1983-95). Use with Manifold Gasket: 18-1204-1.
4	18-1204-1	MANIFOLD GASKET	27-96429	Fits Manifolds: 18-1954-1, 18-1955-1, 18-1956-3
5	18-2832-1	FRONT/ END CAP GASKET	27-48043-1	Fits Port & Starboard Caps of Manifolds: 18-1954-1, 18-1955-1, 18-1956-3.
6	18-4009	FRONT PLATE	60252A2	Fits Manifolds: 18-1954-1, 18-1955-1, 18-1956-3
7	18-5021	END PLATE	805629	Fits Manifolds: 18-1954-1, 18-1955-1, 18-1956-3
8	NSS	MOUNTING BOLT	N/A	Included in 18-8512 mounting kit.
9	18-2748	EXHAUST BOOT	32-44348T	4" Inside Diameter. Use with 18-1975-1 elbow.
10	18-1971	MANIFOLD ELBOW	76351A2	Use with Manifolds: 18-1954-1, 18-1955-1, 18-1956-3; Elbow Gasket 18-2833; Mounting Kit 18-4362
11	18-1978	MANIFOLD ELBOW	76771A3	Use with Manifolds: 18-1954-1, 18-1955-1, 18-1956-3; Elbow Gasket 18-2833; Mounting Kit 18-4362
12	18-1975-1	MANIFOLD RISER	12076A2	Use with Manifolds: 18-1954-1, 18-1955-1, 18-1956-3; Elbow Gasket 18-2819-1; Mounting Hardware 18-8551; Exhaust Boot 18-2748.
13	NSS	MOUNTING BOLT	N/A	Included in 18-8551 mounting hardware.
14	18-3233	MOUNTING STUD	N/A	3/8-24, 3/8-16 X 1 3/4. Included in 18-4362 mounting kit.
15	NSS	MOUNTING BOLT	N/A	Included in 18-8508 mounting kit.
16	NSS	MOUNTING BOLT	N/A	Included in 18-8549 mounting kit.
17	18-4362	MOUNTING KIT	N/A	Use with Elbows: 18-1971 & 18-1978. Includes 18-2833 elbow gasket
18	18-8512	MOUNTING KIT	N/A	Use with Front Plate: 18-4009 & End Plate (NSS). Includes 18-2832-1 front/end cap gasket.
19	18-8549	HARDWARE KIT	N/A	Includes only hardware for 18-1955-1 manifold.
20	18-8551	HARDWARE KIT	N/A	Includes only hardware for 18-1975-1 elbow.
21	18-8508	MOUNTING KIT	N/A	Use with Elbow 18-1973. Includes 18-2819-1 elbow gasket.
22	18-2833	ELBOW GASKET	27-99777-2	Use with Elbows: 18-1971 & 18-1978. Included in 18-4362 mounting kit
23	18-2819-1	ELBOW GASKET	27-39915	Use with Elbow: 18-1973. Included in 18-8508 mounting kit.



Fits GM Small Block V8 305 & 350 cu. in. Models 200, 228, 230, 260 & 898

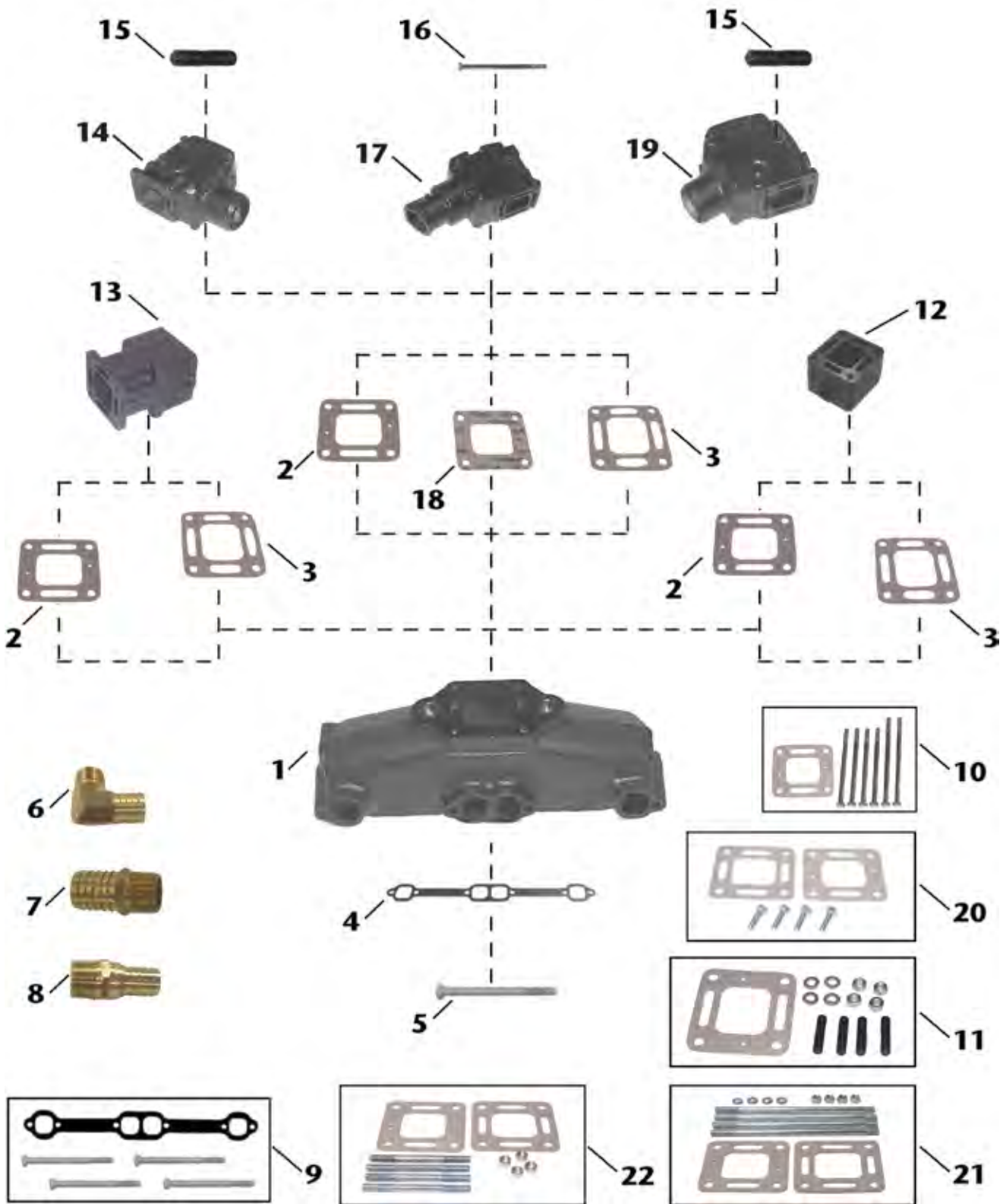

Item No.	Description	OE No.	Application	
1	18-1953-2	MANIFOLD	87114A19	GM Small Block (V8) 305-350 cu.in. Models 200, 228, 230, 260, & 898
2	18-0897	ELBOW GASKET (RESTRICTOR)	27-41813	Fits Manifold: 18-1953-2; Manifold Spacers: 18-1985, & 18-1908; Elbows: 18-1970-2, 18-1976-2, 18-1974-1
3	18-2849-1	ELBOW GASKET (OPEN)	27-818832	Fits Manifold: 18-1953-2; Manifold Spacers: 18-1985, & 18-1908; Elbows: 18-1970-2, 18-1976-2, 18-1974-1
4	18-2949	MANIFOLD GASKET	96306	Use with Manifold: 18-1953-2. Included in 18-8520 mounting kit.
5	NSS	MOUNTING BOLT	N/A	Included in 18-8520 mounting kit
6	18-8216	HOSE FITTING	22-36305	3/4" - 14NPT X 1" Hose (Corrosion Resistant Brass Fitting)
7	18-4461	HOSE FITTING	N/A	3/4" - 14NPT X 1" Hose (Corrosion Resistant Brass Fitting)
8	18-8215	HOSE FITTING	N/A	3/4" - 14NPT X 3/4" Hose (Corrosion Resistant Brass Fitting)
9	18-8520	MOUNTING KIT	N/A	Use with Manifold: 18-1953-2. Includes 18-2949 manifold gasket.
10	18-8505	MOUNTING KIT	N/A	Use with Riser: 18-1976-2. Includes 18-0897 elbow gasket.
11	18-8529	MOUNTING KIT	N/A	Use with Risers: 18-1970-2, 18-1974-1. Includes 18-0897 elbow gaskets
12	18-1908	MANIFOLD SPACER	933220A12	3" Spacer for Manifold: 18-1953-2. Use with mounting kit 18-8554 with 18-1970-2, or mounting kit 18-8555 with 18-1976-2.
13	18-1985	MANIFOLD SPACER	93322	6" Spacer for Manifold: 18-1953-2. Use with mounting kit 18-8556. (Note to mount elbows to spacer a separate mounting kit is required)
14	18-1974-1	MANIFOLD ELBOW (3" hose • 0° down angle)	98502A2	Fits Manifold: 18-1953-2. Use Elbow gasket: 18-2849-1, 18-0897, or 18-0672; Use mounting kit: 18-8529. (Do not use with spacer)
15	NSS	MOUNTING STUD	N/A	Included in 18-8529 mounting kit.
16	NSS	MOUNTING BOLT	N/A	Included in 18-8505 mounting kit.
17	18-1976-2	MANIFOLD ELBOW (4" hose • 7° down angle)	44354A3, 807914A1	Fits Manifold: 18-1953-2. Use Elbow gasket: 18-2849-1, 18-0897, or 18-0672; Use mounting kit: 18-8505, or if spacer is included use 18-8555.
18	18-0672	ELBOW GASKET (CLOSED)	27-860231	Fits Manifold: 18-1953-2; Manifold Spacers: 18-1985, & 18-1908; Elbows: 18-1970-2, 18-1976-2, 18-1974-1
19	18-1970-2	MANIFOLD ELBOW (3" hose • 15° down angle)	98504A3	Fits Manifold: 18-1953-2. Use Elbow gasket: 18-2849-1, 18-0897, or 18-0672; Use mounting kit: 18-8529, or if spacer is included use 18-8554.
20	18-8556	MOUNTING KIT	N/A	Use with Manifold Spacer: 18-1985. Includes 18-0897 & 18-2849-1. (Note: To mount elbows to spacer a separate mounting kit is required)
21	18-8555	MOUNTING KIT	N/A	Use with Riser Kit 18-1908K: Spacer 18-1908: Riser 18-1976-2: Manifold: 18-1953-1
22	18-8554	MOUNTING KIT	N/A	Use with Riser Kit 18-1908K: Spacer 18-1908: Riser 18-1970-2: Manifold: 18-1952-1



**SIERRA MANIFOLDS
ARE PAINTED, PACKAGED & LEAK TESTED**



**18-1998-1
MANIFOLD**
Port & Starboard
Replaces: Barr FM-1-83
Universal Center Riser Manifold
Fits: Ford 302 and 351 CID engines
Comes with 18-4363 Mounting Package
Use with: Exhaust Manifold Gasket Set: 18-0603
*For Exploded View - See Pages 640-641



**18-1997-1
MANIFOLD**
Port & Starboard
Replaces: Barr CHV-1-83 Universal Center Riser Manifold
Fits: GM 283, 305, 307 and 350 CID engines
Use with: Exhaust Manifold Gasket Set: 18-0604
*For Exploded View - See Pages 638-639



**18-1898
MANIFOLD**
Port & Starboard
Replaces: Barr CHVA-1-84, Marine Power 0991-110
Fits: 454 cu. in. GM big block V8 engines
Use with:
Exhaust Manifold Gasket: 18-0418
Riser: 18-1939, 18-1999
*For Exploded View - See Pages 636-637



**18-1951-1*
MANIFOLD**
Supplied with Mounting Package
Replaces: 77235A2, 77235A8
Barr MC-1-77235
STARBOARD SIDE
Fits: Most Mercruiser (GM) small blocks with end riser
Use with:
Exhaust Manifold Gasket: 18-2949
Mounting Kit: 18-8548



**18-1950-1*
MANIFOLD**
Supplied with Mounting Package
Replaces: 77234A2, 77234A7
Barr MC-1-77234
PORT SIDE
Fits: Most Mercruiser (GM) small blocks with end riser
Use with:
Exhaust Manifold Gasket: 18-2949
Mounting Kit: 18-8548



**18-1952-1*
MANIFOLD**
Port & Starboard
Replaces: Mercruiser 99746A8, A17
Marine Power 611447, Barr MC-1-99746
Fits: Most 4.3L (262 CID) V-6 application
Supplied with Mounting Package
Use with:
Mounting Kit: 18-8533



**18-1953-2
MANIFOLD**
Port & Starboard
Supplied with Mounting Package
Replaces: Mercruiser 87114A19, 86024A10, 860246A15, 860246A3, 860246A7, 860246A9, 860336A2, 860337A2, 87114A19, 87114A30
Marine Power 0994-100, Barr MC-1-87114
Will fit either side - Fits most Mercruiser(GM) small blocks with center riser.
Supplied with gaskets
Use with:
Mounting Kit: 18-8520



**18-1954-1*
MANIFOLD**
Supplied with Mounting Package
Replaces: Mercruiser 95862A5
Marine Power 0993-000, Barr MC 1 95862
Fits: Most late Model 2.5L 153 CID & 3.0L 181 CID with Rochester Carb
5 BOLT PATTERN (1983-89)
Use with:
Exhaust Manifold Gasket: 18-1204-1
End Plate: 18-4009

* SEE APPLICATION CHART ON PAGES 783-789 FOR SPECIFIC MODELS



**18-1958-1*
MANIFOLD**
Replaces: 65604A4, A12, 54100A1, 54100A5
Barr MC-1-65604 **PORT SIDE ONLY**
Fits: Most Mercruiser (Ford) V-8 small blocks
Supplied with Mounting Package
Use with:
Mounting Kit: 18-8509



**18-1955-1*
MANIFOLD
New Style**
Supplied with Mounting Package
Replaces: 96705A1, 52390A1
Barr MC 1 96705
Fits: Most early Model 3.0L 181 CID with Rochester Carb. 5 bolt pattern and 2.5L, 153CID (1968-82)
Use with:
Exhaust Manifold Gasket: 18-1203
End Plate: 18-4009



**18-1956-3
MANIFOLD**
Supplied with Mounting Package
Replaces: Mercruiser 860235A04, 99798A3, 99798A9, 99798A16, 99798A18, 806867A8
Marine Power 600333
Barr MC 1 99798
Fits: 2.5 & 3.0L (1983-89)



**18-1957-2*
MANIFOLD
Port & Starboard**
Replaces: Mercruiser 89011A8, 807078A6, 807078T10, 80707809, 807078A4, 807078A2
Marine Power 0991-1000, Barr MC-1-89011
WILL FIT EITHER SIDE
Fits: Most Mercruiser (GM) V-8 big blocks with center riser
Use with:
Exhaust Manifold Gasket: 18-0418
Mounting Kit: 18-8532



**18-1960-1*
MANIFOLD**
Replaces: 58759A10, A14, 58759A13, 58759A1, 52969A1, 52073A1
Barr MC 1 58759
Fits: Most Mercruiser (GM) Inline 6 Cyl. Engines
Supplied with Mounting Package
Use with:
Mounting Kit: 18-8531



**18-1962-1*
MANIFOLD
Starboard**
Replaces: 65603A4, 65603A12, 54099A5, 54099A1
Barr MC-1-65603
Fits: Most Mercruiser Engines (Ford) V-8 Small blocks
Supplied with Mounting Package
Use with:
Mounting Kit: 18-8509

**18-1987-1
MANIFOLD
CONVERSION KIT**
Not for use on engines with high mounted power steering pumps.

- KIT INCLUDES:**
- 2 Center rise manifolds
 - 2 Exhaust elbows
 - 1 Thermostat housing
 - 1 Thermostat cover
 - 1 Thermostat
- All hoses, hardware, gaskets plus complete instructions to do the job right!



This Manifold Kit is designed to convert all Mercruiser Stern Drive Engines with GM 305 & 350 CID Blocks that have Log Style Exhaust Manifolds and Raw Water Cooling to the Newer More Efficient Center Rise Manifolds



**18-1966-1
MANIFOLD**

Replaces: 806867A2, 806867A3, 806867A8, 806867A9, 806867A12, 816329A3, 860235A03, 99798A18
Fits: 3.0L/LX (1990 & Newer); Marine Power Engine Model E181S



**18-1843
EXHAUST MANIFOLD (DRY JOINT)**

Replaces: 865735A02, 865049T01, 864308T01
Fits: 305, 350, 377, 5.0L, 5.7L, 6.2L(2002 and Newer)
Use with:
Manifold Gasket: 18-2949
Elbow Gaskets: 18-0720, 18-0721 or 18-0722
Elbow: 18-1845



**18-1842
V6 DRY JOINT EXHAUST MANIFOLD**

Replaces: 864612T01
Fits: 4.3L Alpha/Bravo (2002 and Newer without Engine Catalyst)
Use with:
Dry Joint Elbow Gaskets: 18-0720, 18-0721 or 18-0722



**18-1999
ELBOW**

Replaces: Barr 20-0082
Fits: 3" I.D. exhaust hose.
Comes with 18-4364 open Mounting Package
Use with:
Manifold: 18-1997-1 or 18-1998-1 or 18-1898
Riser Gasket: 18-2854-1 open or 18-0476-1 blocked
Mounting Kit: 18-4364 open or 18-8535 blocked



**18-1970-2*
ELBOW**

Replaces: Mercruiser 98504A3, 98503A2, 95755A2
Marine Power 0992-115, Barr MC-20-98504
Fits: V-6 & V-8 applications, 15" (3" O.D. Riser) Comes with 18-0897 & brass plugs
Use with:
Manifold: 18-1952-1, 18-1953-2, 18-1957-2
Elbow Gasket: 18-0897 restrictor, 18-2849-1 open, 18-0672 blocked
Mounting Kit: 18-8529



**18-1971*
ELBOW**

Replaces: Mercruiser 76351A2, 76351A1, 76351A04, 60426A1, 49964A1, 49964A2
Marine Power 0993-001
Fits: Most early model Mercruiser 140 HP (4 cyl) applications
Replaces: Barr MC20-60426P
Use with:
Manifold: 18-1960-1, 18-1958-1, 18-1950-1
Elbow Gasket: 18-2833
Mounting Kit: 18-4362



**18-1992-1
EXHAUST ADAPTER**

Replaces: Barr 200087P
For: 3" I.D. Exhaust Hose
(As used in 18-1987 Exhaust Manifold Conversion Kit) 80°



**18-1972*
ELBOW**

Replaces: 76325A2, 12076A2
Barr MC-20-76325
Fits: Most late Model 120, 140 HP Mercruiser applications
Use with:
Manifold: 18-1955-1, 18-1954-1, 18-1956-3, 18-1901
Elbow Gasket: 18-2833
Mounting Kit: 18-8552



**18-1973*
ELBOW**

Replaces: 39920, 39920A1, 55538A2
Barr MC-20-55538
Fits: Most early Model 120 HP Mercruiser applications



**18-1991
ELBOW ADAPTER**

Replaces: Barr 200089P
For: Use with 3" I.D. Exhaust Hose
Use with:
Manifold Riser: 18-1999
30°



**18-1978
ELBOW**

Replaces: 76771A3, A2, 60427A2, 53779A2, 53779A1
Barr MC-20-76771
V-8 Inboard Applications Only
Use with:
Manifold: 18-1950-1, 18-1951-1, 18-1958-1, 18-1962-1
Elbow Gasket: 18-2833
Mounting Kit: 18-4362



**18-1905
ELBOW**
Replaces: 90880
 Mercuriser 4 Cylinder 224cu. in. 3.7L (Models: 165, 170, 180, 190).
Use with:
 Manifold: Mercuriser 99908
 Exhaust Elbow Mounting Gasket: 18-0113-1
 Mounting Kit: 18-8500



**18-1937
ELBOW**
Replaces: 98562A6
 Mercuriser 4 Cylinder 224cu. in. 3.7L (Models: 165, 170, 180, 190).
Use with:
 Exhaust Elbow Mounting Gasket: 18-0881-1
 Mounting Kit: 18-8530



**18-1974-1*
ELBOW**
Replaces: 98502A2, Barr MC-20-98502
Fits: V-6 & V-8 applications 0" (3" O.D. Riser)
 Comes with 18-0897 gasket & brass plugs



**18-1976-2*
ELBOW**
Replaces: Mercuriser 44354A3, 44354A9, 44354A10, 44354A13, 807914A1, 807988A2, 807988A03
 Marine Power 0992-400, Barr MC-20-44354
Fits: Most Mercuriser V-6 & V-8 applications 7" (4" O.D. Riser) Comes with 18-0897, 18-4263 & 18-4258
Use with:
 Manifold: 18-1952-1, 18-1953-2, 18-1957-2
 Riser Gasket: 18-0897 restrictor, 18-2849-1 open, 18-0672 blocked
 Mounting Kit: 18-8505



**18-1845
EXHAUST ELBOW
(DRY JOINT)**
Replaces: 864591T02
Fits: 2004 & Up V6 & V8(305, 350, 377) SN 0W310000 & Up, 2002 & Up V8(350 & 377) SN 0M317000 & Up
Use with:
 Manifolds: 18-1843, 18-1842
 Dry Joint Elbow Gaskets: 18-0720, 18-0721 or 18-0722



**18-1907
RISER**
Replaces: Barr 20-0102, Indmar 53-2009 and 53-2018
 Barr, Indmar Ford Small Block V8 302-351cu. in • Use with 3" hose.
Use with:
 Manifold: 18-1997-1, 18-1998-1
 Riser Gasket: 18-2854-1 open or 18-0476-1 blocked
 Mounting Kit: 18-4364 open or 18-8535 blocked



**18-1939
RISER**
Replaces: Barr 20-0100, Marine Power 0992-593
 Barr, Indmar and Marine Power Ford Small Block V8 302-351cu. in. GM Small Block V8 305-350cu. in., GM Big Block V8 454cu. in. • Use with 3 1/2" hose.
Use with:
 Manifold: 18-1997-1, 18-1998-1, 18-1898
 Riser Gasket: 18-2854-1 open or 18-0476-1 blocked
 Mounting Kit: 18-4364 open or 18-8535 blocked



**18-1975-1*
RISER**
Replaces: Mercuriser 12076A1, 12076A2, 95864A2
 Marine Power 6000-33A
Fits: late Model Mercuriser 4 cyl. Engines
Use with:
 Manifold: 18-1955-1, 18-1954-1, 18-1956-3, 18-1901
 Riser Gasket: 18-2833
 Mounting Kit: 18-8551
 Bellow: 18-2748



**18-1908K
MANIFOLD RISER SPACER KIT**
Replaces: 807476A6, 93320A2, 93320A3, 93320A5, 93320A6, 93320A13
 Alpha/Bravo/Gen-I/Gen-IV GM Small Block V-8 305, 350, 4.3L, 454, 5.0, 5.7L, 502, 7.4L, 8.2L, (3" Riser Kit)
 Complete with Mounting Hardware. Center Rise 3" PACKAGED AS SET
Use with:
 Manifold: 18-1952-1, 18-1953-2, 18-1957-2 3"



**18-1906
MANIFOLD SPACER**
Replaces: 61851A1
 3" Spacer for 18-1950, 18-1951, 18-1958-1 & 18-1962-1 manifolds



**18-1908
MANIFOLD RISER SPACER - 3"**
Replaces: 93320
 Mercuriser GM V6 229 and 262cu.in. (Models: 185 and 205), GM Small Block V8 305-350cu.in. (Models: 200, 228, 230, 260 and 898), GM Big Block V8 454cu.in. (Models: 330, 340 and 7.4L)
Used with:
 Manifolds: 18-1952-1, 18-1953-2, 18-1957-2



**18-1985
MANIFOLD SPACER - 6"**
Replaces: Mercuriser 93322
 Marine Power 612011
 Barr MC-20-93322A3
For: 229 and 262 V6, 305-350 Small Block V8, 454 Big Block V8
Used with:
 Manifold: 18-1952-1, 18-1957-2, 18-1953-2



**18-1949
MANIFOLD SPACER**
 Barr CM 20-0097
 3" Spacer for Barr, Indmar and Marine Power Ford Small Block V8 302-351cu.in., GM Small Block V8 305-350cu.in., GM Big Block V8 454cu.in.
Used with:
 Manifold: 18-1998-1, 18-1997-1 and 18-1898



18-1990
MANIFOLD BLOCK OFF PLATE
Replaces: 48045, 54870, 73813, 73813A1, 73813F1
Barr 1-73813



18-5021
END PLATE
Replaces: 805629
Use with:
Manifold: 18-1954-1,
18-1955-1, 18-1956-3



18-4008
BLOCK-OFF PLATE
Replaces: 60207
Barr MC-20-60207
Use with:
Riser: 18-1971, 18-1978



18-1995
MANIFOLD END PLATE
Replaces: 47638, 47638A1
GM 4 cyl. 153 cu. in
For: Model 110/120 where carb. linkage mounts to the rear of the engine

PIPE PLUGS



Part #	Replaces	Thread Size	Description
18-4257	—	1/4"	Blacksteel Plug
18-4263	22-32802, 22-328022, 22-328021, 22-841908, 22-30139, F700633, FI5810151,	1/8" - 27 NPT	Pipe Plug
18-4264	22-32803, 22-87543, FI5880010	3/8" - 18 NPT	Pipe Plug
18-4265	22-428611, 22-42861, 22-861187	3/4" - 14 NPT	Pipe Plug (Brass hexdrive)
18-8111 ①	22-36392	1/4" - 18 NPT	Pipe Plug
18-4258	22-33198A1, 22-41622	3/4" - 14 NPT	Pipe Plug (Stainless steel w/ square drive)

56507 Pipe Sealant with Teflon® is recommended for use on plug threads.



18-4009
MANIFOLD END PLATE
Replaces: 52999, 60252, 60252A2
Barr 16Q252
Use with:
Manifold: 18-1960-1, 18-1958-1,
18-1950-1, 18-1951-1
End Plate Gasket: 18-2832-1
Mounting Kit: 18-8512



RISER BOLTS

Part #	Replaces	Thread Size	Description
18-8410	10-43749	3/8"-16 x 5 3/4"	Use w/o remote oil filter
18-8411	10-44387	1/8" - 16 x 6 3/4"	Use with remote oil filter



18-4363
EXHAUST ELBOW MOUNTING KIT
Replaces: Barr FM-1-83-P
Use with:
Manifold: 18-1998-1



18-4362
EXHAUST ELBOW MOUNTING KIT
Replaces: Barr MC20-60426P
Use with:
Elbow: 18-1971



18-8500
EXHAUST ELBOW MOUNTING KIT
Mercruiser 4 Cylinder 224cu.in. 3.7L (Models: 165, 170, 180, 190)
Used with:
Elbow/Reservoir: 18-1905



18-8505
EXHAUST ELBOW MOUNTING KIT
Mercruiser GM V6 229 and 262cu.in. (Models 185 and 205), GM Small Block V8 305-350cu. in. (Models: 200, 228, 230, 260, 898), GM Big Block V8 454cu.in. (Models: 330, 340 and 7.4L)
Used with:
Riser: 18-1976-2



18-8508
EXHAUST MANIFOLD MOUNTING KIT
Mercruiser GM 4 Cylinder 153cu.in. (Early models 110/120), GM Inline Cylinder 250cu.in.(Model: 160)
Used with:
Riser: 18-1973

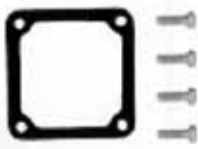

18-8512
EXHAUST ELBOW MOUNTING KIT
Mercruiser GM 4 Cylinder 181cu.in. (Models: 120,140, 2.5L,3.0L), GM Inline 6 Cylinder 250-292cu.in. (Models: 165 and 200), Ford Small Block V8 302-351cu.in. (Models: 215,225,233, 255,888), GM Small Block V8 305, 350cu.in.(Models: 198,228,898)
Used with:
Front Plate: 18-4009

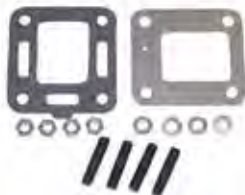

18-8514
EXHAUST ELBOW MOUNTING KIT
Mercruiser Ford Small Block V8 302-351cu.in. (Models: 215, 225, 233, 255, 888), GM Small Block V8 305-351cu.in. (Models: 198,228,898)
Used with:
Riser: 18-1971 & 18-1978
(Not for Fresh Water/Closed Cooling Systems)

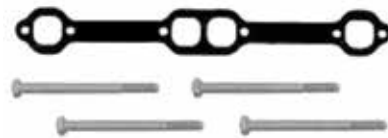

18-8520
EXHAUST MANIFOLD MOUNTING KIT
Mercruiser GM Small Block V8 305-350cu.in. (Models: 198, 200, 228, 230, 260, 898)
Used with:
Manifold: 18-1950-1,18-1951-1, 18-1953-2

① This product is priced per piece. To order priced per package, please add -9 to the part number



18-4364 (Open)
EXHAUST ELBOW MOUNTING KIT
 Replaces: Barr 20-0082-P
 Use with:
 Riser: 18-1999, 18-1907, 18-1939



18-8529
EXHAUST ELBOW MOUNTING KIT
 Mercuriser GM V6 229 and 262cu.in. (Models 185 and 205), GM Small Block V8 305-350cu.in. (Models: 200, 228, 230, 260, 898), GM Big Block V8 454cu.in. (Models: 330, 340 and 7.4L)
 Used with:
 Riser: 18-1970-2



18-8530
EXHAUST ELBOW MOUNTING KIT
 Mercuriser 4 Cylinder 224cu.in. 3.7L (Models: 165, 170, 180, 190)
 Used with:
 Elbow/Reservoir: 18-1937



18-8531
EXHAUST MANIFOLD MOUNTING KIT
 Mercuriser GM Inline 6 Cylinder 250cu.in. (Models: 165 and 200)
 Used with :
 Manifold: 18-1960-1



18-8532
EXHAUST MANIFOLD MOUNTING KIT
 Mercuriser GM Big Block V8 454cu.in. (Models: 330, 340 and 7.4L)
 Used with:
 Manifold: 18-1957-2



18-8533
EXHAUST MANIFOLD MOUNTING KIT
 Mercuriser GM V6 229 and 262cu.in. (Models 185 and 205)
 Used with:
 Manifold: 18-1952-1



18-8535 (Blocked)
EXHAUST ELBOW MOUNTING KIT
 Barr, Indmar and Marine Power Ford Small Block V8 302-351cu.in., GM Small Block V8 305-350cu.in., GM Big Block V8 454cu. in.
 Used with:
 Risers: 18-1939, 18-1999, and 18-1907



18-8536
EXHAUST ELBOW MOUNTING KIT
 Barr, Indmar and Marine Power GM Small Block V8 305-350cu.in.
 Used with:
 Manifold: 18-1997-1



18-8538
EXHAUST MANIFOLD MOUNTING KIT
 Barr and Indmar Ford Small Block V8 302-351cu.in.
 Used with:
 Manifold: 18-1998-1



18-8554
EXHAUST ELBOW MOUNTING KIT
 For: 229 and 262 ci V6, 305 and 350 SB V8, 454 Big Block V8.
 Used with:
 Riser Kit: 18-1908K and 18-1908 Spacer
 Riser: 18-1970-2
 Manifold: 18-1952-1, 18-1953-2 & 18-1957-2



9 1/2" studs —

18-8555
EXHAUST ELBOW MOUNTING KIT
 For: 229 and 262 ci V6, 305 and 350 SB V8, 454 Big Block V8.
 Used with:
 Riser Kit: 18-1908K and 18-1908 Spacer
 Riser: 18-1976-2
 Manifolds: 18-1952-1, 18-1953-2 & 18-1957-2



18-8556
EXHAUST ELBOW MOUNTING KIT
 For: 229 and 262 ci V6, 305 and 350 SB V8, 454 Big Block V8. Used to mount Spacer 18-1985 to 18-1953-2, 18-1957-2 and 18-1952-1 Manifolds



HARDWARE KITS



















Part No.	Fits
18-8548	18-1950-1 & 18-1951-1 Manifold
18-8549	18-1950-1 Manifold
18-8551	18-1975-1 Exhaust Elbow







18-0183-1
EXHAUST MANIFOLD GASKET
 Replaces: Mercuriser 27-73866, 27-54566 Volvo 3853742, 3852455, OMC 908717
 Used with:
 Manifold: 18-1962-1, 18-1938, 18-1998-1, 18-1996, 18-1979

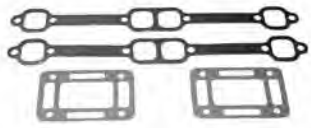

18-0353
CARB MOUNTING GASKET
 Replaces: 27-58764
 Used with:
 Manifold: 18-1960-1

 <p>18-0418 EXHAUST MANIFOLD GASKET Replaces: 27-46820 Use with : Manifolds: 18-1957-2, 18-1982, 18-1929, 18-1933, 18-1898</p>	 <p>18-0476-1 RISER BLOCK OFF GASKET Barr, Indmar & Marine Power Ford Small Block V8 302-351cu.in. Used with: Risers: 18-1939, 18-1999, 18-1907</p>	<p>PKG. OF 2</p>  <p>18-0672 18-0672-9① EXHAUST ELBOW GASKET Replaces: 27-860231,8637251, 27-41811, 27-863725 Used with: Riser: 18-1970-2, 18-1976-2</p>	 <p>18-0881-1 EXHAUST ELBOW GASKET Replaces: 27-18272, 27-97863 Included in 18-8530 mounting kit Used with: Elbow: 18-1937</p>
 <p>18-0885-1 18-0885-9① EXHAUST ELBOW GASKET Replaces: 27-48042</p>	 <p>18-0897 (Restrictor) EXHAUST ELBOW GASKET Replaces: 27-41813, 27-860233, 27-863724 Used with: Riser: 18-1976-2, 18-1970-2</p>	 <p>18-1204-1 18-1204-1-9① EXHAUST MANIFOLD GASKET Replaces: 27-96429</p>	<p>PKG. OF 2</p>  <p>18-2819-1 18-2819-9① EXHAUST ELBOW GASKET Replaces: 27-39915</p>
 <p>18-2830-1 EXHAUST MANIFOLD GASKET 6 cyl. Replaces: 27-46401</p>	<p>PKG. OF 2</p>  <p>18-1210-1 END CAP GASKET Replaces: 27-39923</p>	<p>PKG. OF 2</p>  <p>18-2832-1 18-2832-1-9① MANIFOLD END CAP GASKET Replaces: 27-480431 Use with: Manifolds: 18-1951-1, 18-1950-1, 18-1954-1, 18-1958-1, 18-1955-1, 18-1956-3, 18-1960-1, 18-1962-1 End Plate: 18-4009</p>	 <p>18-2833 18-2833-9① EXHAUST ELBOW GASKET Replaces: 27-99772</p>
<p>PKG. OF 2</p>  <p>18-2849-1 (Open) 18-2849-9-1① EXHAUST ELBOW GASKET Replaces: 27-87105-1, 27-818832, 27-863726 Use with: Elbow: 18-1976-2, 18-1970-2</p>	 <p>18-2854-1 (Open) 18-2854-9① EXHAUST ELBOW GASKET Replaces: Barr 01-0107 Use with : Riser: 18-1999, 18-1939, 18-1907</p>	 <p>18-2896-1 EXHAUST MANIFOLD GASKET Replaces: 27-52546, 27-32816 GM 4 cyl. 153 cu. in. For model 110/120 where carb. linkage mounts to the rear of the engine</p>	 <p>18-2909 18-2909-9① EXHAUST MANIFOLD GASKET For: GM V-6 Used with: Manifold: 18-1952-1</p>
 <p>18-2912-1 EXHAUST MANIFOLD GASKET Replaces: 27-53354</p>	 <p>18-2949 18-2949-9② EXHAUST MANIFOLD GASKET Replaces: Mercruiser 27-33395 Barr CHV-47-000 GM 5.0L & 5.7L Use with: Manifold: 18-1997-1, 18-1950-1, 18-1951-1</p>	 <p>18-0603 EXHAUST MANIFOLD GASKET SET For: Ford 302/351 CID Engines For use with 18-1998-1</p>	 <p>18-0604 EXHAUST MANIFOLD GASKET SET For: GM 305/350 CID Engines For use with 18-1997-1</p>

① Priced per Package

 <p>18-0720 DRY JOINT GASKET (CLOSED) Replaces: 27-864549A02, 27-864549A1 Fits: 4.3L, 5.0L, 5.7L, 6.2L utilizing the Dry Joint Manifold and Riser Used with: 18-1843, 18-1842 Manifolds & 18-1845 Riser</p>	 <p>18-0721 DRY JOINT GASKET (OPEN) Replaces: 27-864547A02, 27-864547A1 Fits: 4.3L, 5.0L, 5.7L, 6.2L utilizing the Dry Joint Manifold and Riser Used with: 18-1843, 18-1842 Manifolds & 18-1845 Riser</p>	 <p>18-0722 DRY JOINT GASKET (RESTRICTED) Replaces: 27-864850A02, 27-864547A1 Fits: 4.3L, 5.0L, 5.7L, 6.2L utilizing the Dry Joint Manifold and Riser Used with: 18-1843, 18-1842 Manifolds & 18-1845 Riser</p>
 <p>18-4218 DRAIN TAP Replaces: 22-87238, 22-16951A1, 22-64426, 22-16951Q1 1/4" NPT 18-3223-9Ⓛ Bulk pack of 12</p>	 <p>18-4224 DRAIN ELBOW ASSEMBLY Replaces: 22-806926A1, 22-862210A01 3/4" NPT</p>	 <p>18-4226 DRAIN PLUG Replaces: 22-806608A1, 22-806608A02</p>
 <p>18-4227 DRAIN ELBOW Replaces: 22-806926, 22-862210</p>	 <p>18-4461 HOSE BARB Replaces: 22-807155 3/4" - 14 NPT x 1" Hose Corrosion-Resistant Brass Fitting</p>	 <p>18-8216 HOSE BARB Replaces: 22-36305, 22-36305T 3/4" - 14 NPT x 1" hose barb Fits: Mercruiser- V6 (229 and 262ci), Small Block V8 (305-350ci), Big Block V8 (454ci)</p>

Ⓛ Items ending in "D" are Display Packaged - Regular number is Non-Display
Ⓜ Priced per Package

MANIFOLD/MANIFOLD GASKET APPLICATION

Liter	Model	Note	CID	#Cyl.	Stroke	Year Range	Serial # Range	Exh. Manifold Port	Exh. Manifold Starboard	Exh. Elbow	End Cap Front	End Cap Rear	Manifold Gasket	Exh. Elbow Gasket
2.5L	120		153	4	4	1966-1982	2046625 - 6229717						27-52546	18-2819-1
2.5L	120		153	4	4		2324347 - 3377340					18-1995	18-2896-1	18-2819-1
2.5L	120		153	4	4		3377341 - 5192408					18-1995	18-2896-1	18-2819-1
2.5L	120		153	4	4		5192049 - 6229717					18-1995	18-2896-1	18-2819-1
2.5	120		153	4	4	1983-1986	6229718 - B5311853				18-4009		18-1204-1	18-2833
2.5L	2.5L		153	4	4	1987-1989	B531854 - C853255	18-1956-3			18-4009	18-4009	18-1204-1	18-2833
3.0L	140		181	4	4	1968-1982	2508261 - 6229717	18-1955-1		18-1971	18-4009	18-1990	18-2912-1	18-2833
3.0L	140		181	4	4		3332138 - 5157668	18-1955-1				18-4009	18-1203	18-2833
3.0L	140		181	4	4		5157669 - 6229717	18-1955-1				18-4009	18-1203	18-2833
3.0L	140		181	4	4	1983-1986	6229718 - B450800			18-1975-1	18-4009		18-1204-1	18-2833
3.0L	3.0L		181	4	4	1990-1994	C856559 & UP	18-1956-3		18-1975-1	18-4009		18-1204-1	18-2833
3.0L	3.0L		181	4	4	1987-1989	B450801 - C856558			18-1975-1	18-4009		18-1204-1	18-2833
3.0L	3.0L		181	4	4	1998-2003	L010042 - M679999	18-1956-3		18-1975-1	18-1990		18-1204-1	18-2833
3.0L	3.0L		181	4	4	2003-2010	M680000 & UP	18-1956-3		18-1975-1			18-0680	18-2833
3.0L	3.0LX		181	4	4	1990-1997	C856559 - K999999	18-1956-3		18-1975-1	18-1990		18-0680	18-2833
3.0L	3.0L MPI / 3.0L EC		181	4	4	2008-2010	A072812 & UP						18-0680	
	150			4	4		1666495 - 2048046						18-2830-1	
	160			4	4		2048022 - 2770031						18-2830-1	
3.7L	165		224	4	4	1987	B434941 - B774251	Ⓛ		18-1937			18-0956-1	18-0881-1
3.7L	165		224	4	4	1987	B434941 - B774251	Ⓜ					18-0956-1	
3.7L	165		224	4	4		2770032 & up	18-1960-1				18-4009	18-2830-1	18-2833
3.7L	170		224	4	4	1985-1986	6916779 - B434940	Ⓛ		18-1937			18-0956-1	18-0881-1
3.7L	170		224	4	4	1985-1986	6916779 - B434940	Ⓜ					18-0956-1	18-0113-1
3.7L	180		224	4	4	1987	B436391 - B775248	Ⓛ		18-1937			18-0956-1	18-0881-1

- Ⓛ For engines with aluminum exhaust manifolds
- Ⓜ For engines with cast iron exhaust manifolds
- Ⓛ 3" (76mm) O.D. & 0 degree down angle
- Ⓜ 3" (76mm) O.D. & 15 degree down angle
- Ⓛ 4" (102mm) O.D.
- Ⓛ 2 piece exhaust manifold
- Ⓜ 1 piece exhaust manifold
- Ⓛ Has a rectangular elbow mounting bolt pattern
- Ⓜ Has a square elbow mounting bolt pattern
- Ⓛ In-line applications
- Ⓛ V-drive applications
- Ⓛ Standard rise
- Ⓛ 2" (51mm) rise
- Ⓛ 3" (76mm) rise
- Ⓛ 6" (152mm) rise
- Ⓛ Port
- Ⓛ Starboard
- Ⓛ Engines with risers or closed cooling may require a different gasket than listed
- Ⓛ Exhaust manifold with external water rail
- Ⓛ Exhaust manifold w/o external water rail
- Ⓛ 1 piece exhaust manifold is n/a. Engine must be converted to the 2 piece exhaust system
- Ⓛ Engines with easy drain system
- Ⓛ Engines with multi-point drain system
- Ⓛ Intermediate collector housing

MANIFOLD/MANIFOLD GASKET APPLICATION (Cont.)

Liter	Model	Note	CID	# Cyl.	Stroke	Year Range	Serial # Range	Exh. Manifold Port	Exh. Manifold Starboard	Exh. Elbow	End Cap Front	End Cap Rear	Manifold Gasket	Exh. Elbow Gasket
3.7L	180		224	4	4	1987	B436391 - B775248	Ⓐ					18-0956-1	18-0113-1
3.7L	190		224	4	4	1985-1986	6916779 - B436390	Ⓐ		18-1937			18-0956-1	18-0881-1
3.7L	190		224	4	4	1985-1986	6916779 - B436390	Ⓐ					18-0956-1	18-0113-1
3.7L	3.7L		224	4	4	1988-1989	B774252 & UP	Ⓐ		18-1937			18-0956-1	18-0881-1
3.7L	3.7L		224	4	4	1988-1989	B774252 & UP	Ⓐ					18-0956-1	
3.7L	3.7LX		224	4	4	1988-1989	B775249 & UP	Ⓐ		18-1937			18-0956-1	18-0881-1
3.7L	3.7LX		224	4	4	1988-1989	B775249 & UP	Ⓐ					18-0956-1	18-0113-1
	470		224	4	4	1976-1977	4208730 - 4625579						18-0956-1	18-2833
	470 MCM / 470 MIE		224	4	4	1977-1982	4625580 - 6218036						18-0956-1	18-2833
	470		224	4	4	1983-1984	6218037 - 6916778						18-0956-1	18-0113-1
	485		224	4	4	1980-1982	5685394 - 6218036						18-0956-1	
	488		224	4	4	1983-1984	6170297 - 6916778						18-0956-1	18-0113-1
	140		194	6	4	1963	1538930 - 1725960						18-2830-1	
	150		230	6	4	1964-1966	1666495 - 2048046						18-2830-1	
	160		250	6	4	1967-1969	2048022 - 2770031						18-2830-1	
	165		250	6	4	1970-1981	2770032 - 5813433	18-1960-1		18-1971	18-4009	18-1990	18-2830-1	18-2833
	200		292	6	4	1969	2453769 - 2712072	18-1960-1		18-1971		18-1990	18-2830-1	18-2833
	185	4bbl	229	6	4	1983-1984	6330183 - 6919655	18-1952-1	18-1952-1	18-1970-2			18-2909	18-0897
	175		262	6	4	1987	B527955 - B773242	18-1952-1	18-1952-1	18-1976-2			18-2909	18-0897
	185	2bbl	262	6	4	1985-1986	A331455 - B527954	18-1952-1	18-1952-1	18-1970-2 Ⓐ			18-2909	18-0897
	185	2bbl	262	6	4	1985-1986	A331455 - B527954	18-1952-1	18-1952-1	18-1976-2 Ⓐ			18-2909	18-0897
	205		262	6	4	1985-1986	A331455 - B527954	18-1952-1	18-1952-1	18-1970-2 Ⓐ			18-2909	18-0897
	205		262	6	4	1985-1986	A331455 - B527954	18-1952-1	18-1952-1	18-1976-2 Ⓐ			18-2909	18-0897
	205		262	6	4	1987	B527955 - B775129	18-1952-1	18-1952-1	18-1976-2			18-2909	18-0897
4.3L	262 MAG EFI GEN +		262	6	4	1996-1997	F803800 - K999999	18-1952-1 Ⓐ	18-1952-1 Ⓐ	18-1976-2 Ⓐ			18-2909	18-0897
4.3L	262 MAG EFI GEN +		262	6	4	1996-1997	F803800 - K999999	Ⓐ	Ⓐ	Ⓐ			18-2909	
4.3L	4.3L		262	6	4	1988-1996	B773243 - F802999	18-1952-1	18-1952-1	18-1976-2			18-2909	18-0897
4.3L	4.3L GEN +		262	6	4	1998-2002	L010044 - M614999	18-1952-1 Ⓐ	18-1952-1 Ⓐ	18-1976-2 Ⓐ			18-2909	18-2849-1
4.3L	4.3L GEN +		262	6	4	1998-2002	L010044 - M614999	Ⓐ	Ⓐ	Ⓐ			18-2909	
4.3L	4.3L GEN +		262	6	4	2002-2004	M615000 - W309999						18-2909	
4.3L	4.3L GEN +		262	6	4	2004-2010	W310000 & UP						18-2909	
4.3L	4.3L EFI GEN +		262	6	4	1998-2002	L012009 - M322780	18-1952-1 Ⓐ	18-1952-1 Ⓐ	18-1976-2 Ⓐ			18-2909	18-2849-1
4.3L	4.3L EFI GEN +		262	6	4	1998-2002	L01009 - M322780	Ⓐ	Ⓐ	Ⓐ			18-2909	
4.3L	4.3L MPI		262	6	4	2002	M300000 - M614999	18-1952-1	18-1952-1	18-1976-2			18-2909	18-0897 ♣
4.3L	4.3L MPI		262	6	4	2002	M300000 - M614999	18-1952-1	18-1952-1	18-1976-2			18-2909	18-2849-1 ♣
4.3L	4.3L MPI		262	6	4	2002-2004	M615000 - W309999						18-2909	
4.3L	4.3L MPI		262	6	4	2004-2010	W310000 & UP						18-2909	
4.3L	4.3L MPI / 4.3L EC		262	6	4	2010-2011	A637496 & UP			Ⓐ			18-2909	
4.3L	4.3L MPI / 4.3L EC		262	6	4	2010-2011	A637496 & UP			Ⓐ			18-2909	
4.3L	4.3LH GEN +		262	6	4	1998-2002	L010044 - M614999	18-1952-1 Ⓐ	18-1952-1 Ⓐ	18-1976-2 Ⓐ			18-2909	18-2849-1
4.3L	4.3LH GEN +		262	6	4	1998-2002	L010044 - M614999	Ⓐ	Ⓐ	Ⓐ			18-2909	
4.3L	4.3LH	4 bbl	262	6	4	1988-1996	B775130 - F802999	18-1952-1	18-1952-1	18-1976-2			18-2909	18-0897
4.3L	4.3LX GEN +	2bbl	262	6	4	1996-1997	F803800 - K999999	18-1952-1 Ⓐ	18-1952-1 Ⓐ	18-1976-2 Ⓐ			18-2909	18-0897
4.3L	4.3LX GEN +	2bbl	262	6	4	1996-1997	F803800 - K999999	Ⓐ	Ⓐ	Ⓐ			18-2909	
4.3L	4.3LXH GEN +		262	6	4	1996-1997	F803814 - K999999	18-1952-1 Ⓐ	18-1952-1 Ⓐ	18-1976-2 Ⓐ			18-2909	18-0897
4.3L	4.3LXH GEN +		262	6	4	1996-1997	F803814 - K999999	Ⓐ	Ⓐ	Ⓐ			18-2909	
5.0L	215		302	8	4	1970	2781153 - 3040410	18-1958-1	18-1962-1	18-1971	18-4009	18-1990	18-0183-1	18-2833
5.0L	215		302	8	4	1971-1972	3040411 - 3385720	18-1958-1	18-1962-1	18-1971	18-4009	18-4009	18-0183-1	18-2833
5.0L	215 MIE		302	8	4	1970	2781153 - 3040410	18-1958-1	18-1962-1		18-4009	18-1990	18-0183-1	18-2833
5.0L	215 MIE		302	8	4	1971-1972	3040411 - 3563181	18-1958-1	18-1962-1		18-4009	18-4009	18-0183-1	18-2833
5.0L	225	FORD	302	8	4	1973-1974	3385721 - 4166999	18-1958-1	18-1962-1	18-1971	18-4009	18-4009	18-0183-1	18-2833
5.0L	225 MIE	FORD	302	8	4	1973-1974	3385721 - 4176999	18-1958-1	18-1962-1		18-4009	18-4009	18-0183-1	18-2833
5.0L	888		302	8	4	1971-1977	3108723 - 4867829	18-1958-1	18-1962-1	18-1971	18-4009	18-4009	18-0183-1	18-2833

Ⓐ For engines with aluminum exhaust manifolds
 Ⓑ For engines with cast iron exhaust manifolds
 Ⓒ 3" (76mm) O.D. & 0 degree down angle
 Ⓓ 3" (76mm) O.D. & 15 degree down angle
 Ⓔ 4" (102mm) O.D.
 Ⓕ 2 piece exhaust manifold
 Ⓖ 1 piece exhaust manifold
 Ⓗ Has a rectangular elbow mounting bolt pattern
 Ⓘ Has a square elbow mounting bolt pattern
 Ⓚ In-line applications
 Ⓛ V-drive applications
 Ⓜ Standard rise
 Ⓨ 2" (51mm) rise
 Ⓩ 3" (76mm) rise
 ⓐ 6" (152mm) rise
 ⓑ Port
 ⓓ Starboard
 ⓔ Engines with risers or closed cooling may require a different gasket than listed
 ⓕ Exhaust manifold with external water rail
 ⓖ Exhaust manifold w/o external water rail
 ⓗ 1 piece exhaust manifold is n/a. Engine must be converted to the 2 piece exhaust system
 ⓘ Engines with easy drain system
 ⓙ Engines with multi-point drain system
 ⓚ Intermediate collector housing

MANIFOLD/MANIFOLD GASKET APPLICATION (Cont.)

Liter	Model	Note	CID	# Cyl.	Stroke	Year Range	Serial # Range	Exh. Manifold Port	Exh. Manifold Starboard	Exh. Elbow	End Cap Front	End Cap Rear	Manifold Gasket	Exh. Elbow Gasket
	190		283	8	4	1963-1964	1564539 - 1730903						18-2949	
5.0L	198 MIE		305	8	4	1977	4776402 - 4931099	ⓐ	ⓐ	ⓐ	18-4009	18-4009	18-2949	18-0885-1
5.0L	198 MIE		305	8	4	1977	4776402 - 4931009	18-1950-1 ⓐ	18-1951-1 ⓐ	ⓐ	18-4009	18-4009	18-2949	18-2833
5.0L	200		305	8	4	1985-1987	6899058 - B525981	18-1953-2	18-1953-2	18-1970-2 ⓐ			18-2949	18-0897
5.0L	200		305	8	4	1985-1987	6899058 - B525981	18-1953-2	18-1953-2	18-1976-2 ⓐ			18-2949	18-0897
5.0L	200		305	8	4	1987	B525982 - B774444	18-1953-2	18-1953-2	18-1976-2			18-2949	18-0897
5.0L	228		305	8	4	1977	4765100 - 4888929				18-4009	18-4009	18-2949	18-0885-1
5.0L	228		305	8	4	1977-1982	4888930 - 6218461	18-1950-1	18-1951-1	18-1971	18-4009	18-4009	18-2949	18-2833
5.0L	228		305	8	4	1983-1984	6218462 - 6899268	18-1953-2	18-1953-2	18-1970-2 ⓐ			18-2949	18-0897
5.0L	228		305	8	4	1983-1984	6218462 - 6899268	18-1953-2	18-1953-2	18-1976-2 ⓐ			18-2949	18-0897
5.0L	228 TR		305	8	4	1977-1978	4888930 - 5170008	18-1950-1	18-1951-1	18-1971	18-4009	18-4009	18-2949	18-2833
5.0L	228 TR		305	8	4	1977-1978	4888930 - 5170008	18-1950-1	18-1951-1	18-1971	18-4009	18-4009	18-2949	18-2833
5.0L	228 MIE		305	8	4	1977	4765100 - 4888929				18-4009	18-4009	18-2949	18-0885-1
5.0L	228 MIE		305	8	4	1977-1980	4888930 - 5907057	18-1950-1	18-1951-1		18-4009	18-4009	18-2949	18-2833
5.0L	230		305	8	4	1985-1987	6899269 - B525981	18-1953-2	18-1953-2	18-1970-2 ⓐ			18-2949	18-0897
5.0L	230		305	8	4	1985-1987	6899269 - B525981	18-1953-2	18-1953-2	18-1976-2 ⓐ			18-2949	18-0897
5.0L	230		305	8	4	1987	B525982 - B773739	18-1953-2	18-1953-2	18-1976-2			18-2949	18-0897
5.0L	230 MIE		305	8	4	1981-1987	5907058 - B788151	18-1953-2	18-1953-2	18-1974-1 ⓐ			18-2949	18-0897
5.0L	230 MIE		305	8	4	1981-1987	5907058 - B788151	18-1953-2	18-1953-2	18-1970-2 ⓐ			18-2949	18-0897
5.0L	230 MIE		305	8	4	1981-1987	5907058 - B788151	18-1953-2	18-1953-2	18-1976-2 ⓐ			18-2949	18-0897
5.0L	5.0L		305	8	4	1988-1995	B774445 - F600999	18-1953-2	18-1953-2	18-1976-2			18-2949	18-0897
5.0L	5.0L GEN +		305	8	4	1988-2002	L015751 - M599999	18-1953-2	18-1953-2	18-1976-2			18-2949	
5.0L	5.0L GEN +		305	8	4	1988-2002	M600000 - W309999						18-2949	
5.0L	5.0L GEN +		305	8	4	2004-2010	W310000 & UP						18-2949	
5.0L	5.0L EFI GEN +		305	8	4	1998-2001	L012052 - M299999	18-1953-2	18-1953-2	18-1976-2			18-2949	18-2849-1
5.0L	5.0L MIE		305	8	4	1988	B788152 - C396832	18-1953-2	18-1953-2	18-1976-2			18-2949	18-0897
5.0L	5.0L MPI		305	8	4	2002	M300000 - M599999	18-1953-2	18-1953-2	18-1976-2			18-2949	18-0897
5.0L	5.0L MPI		305	8	4	2002-2004	M600000 - W309999						18-2949	
5.0L	5.0L MPI		305	8	4	2004-2010	W310000 & UP						18-2949	
5.0L	5.0LX		305	8	4	1988-1995	B773740 - F600900	18-1953-2	18-1953-2	18-1976-2			18-2949	18-0897
5.0L	898		305	8	4	1977-1982	4762210 - 6218461	ⓐ	ⓐ	ⓐ	18-4009	18-4009	18-2949	18-0885-1
5.0L	898		305	8	4	1977-1982	4762210 - 6218461	18-1950-1 ⓐ	18-1951-1 ⓐ	ⓐ	18-4009	18-4009	18-2949	18-2833
5.0L	898		305	8	4	1983-1984	6218462 - 6899057	18-1953-2	18-1953-2	18-1970-2			18-2949	18-0897
5.0L	898		305	8	4	1983-1984	6218462 - 6899057	18-1953-2	18-1953-2	18-1976-2 ⓐ			18-2949	18-0897
	225	GM	327	8	4	1963-1968	1539620 - 2399397						18-2949	
	225	GM	327	8	4	1968-1969	2399398 - 2694014				18-4009	18-1990	18-2949	18-0885-1
	225 MIE	GM	327	8	4	1968	2278647 - 2399307						18-2949	
	225 MIE	GM	327	8	4	1968-1969	2399398 - 2694014				18-4009	18-1990	18-2949	18-0885-1
	250		327	8	4	1968-1969	2314301 - 2639854				18-4009	18-1990	18-2949	18-0885-1
	250 MIE		327	8	4	1968-1969	2314301 - 2639854				18-4009	18-1990	18-2949	18-0885-1
5.7L	250		350	8	4	1977	4768000 - 4908849	ⓐ	ⓐ	ⓐ	18-4009	18-4009	18-2949	18-0885-1
5.7L	250		350	8	4	1977	4768000 - 4908849	18-1950-1 ⓐ	18-1951-1 ⓐ	18-1971 ⓐ	18-4009	18-4009	18-2949	18-2833
5.7L	255	GM	350	8	4	1975-1976	4175500 - 4499060				18-4009	18-1990	18-2949	18-0885-1
5.7L	255	GM	350	8	4	1976	4499061 - 4767999	18-1950-1	18-1951-1	18-1971	18-4009	18-4009	18-2949	18-2833
5.7L	255 MIE	GM	350	8	4	1975-1976	4175500 - 4499060				18-4009	18-1990	18-2949	18-0885-1
5.7L	255 MIE	GM	350	8	4	1976-1980	4499061 - 5907057	18-1950-1	18-1951-1		18-4009	18-4009	18-2949	18-2833
5.7L	260		350	8	4	1978-1982	4908850 - 6218461	18-1950-1	18-1951-1	18-1971	18-4009	18-4009	18-2949	18-2833
5.7L	260		350	8	4	1983-1987	6218462 - B773304	18-1953-2	18-1953-2	18-1970-2 ⓐ			18-2949	18-0897
5.7L	260		350	8	4	1983-1987	6218462 - B773304	18-1953-2	18-1953-2	18-1976-2 ⓐ			18-2949	18-0897
5.7L	260 MIE		350	8	4	1981-1987	5907058 - B788151	18-1953-2	18-1953-2	18-1974-1 ⓐ			18-2949	18-0897
5.7L	260 MIE		350	8	4	1981-1987	5907058 - B788151	18-1953-2	18-1953-2	18-1970-2 ⓐ			18-2949	18-0897
5.7L	260 MIE		350	8	4	1981-1987	5907058 - B788151	18-1953-2	18-1953-2	18-1976-2 ⓐ			18-2949	18-0897

- ⓐ For engines with aluminum exhaust manifolds
- ⓑ For engines with cast iron exhaust manifolds
- ⓓ 3" (76mm) O.D. & 0 degree down angle
- ⓔ 3" (76mm) O.D. & 15 degree down angle
- ⓖ 4" (102mm) O.D.
- ⓗ 2 piece exhaust manifold
- ⓘ 1 piece exhaust manifold
- ⓙ Has a rectangular elbow mounting bolt pattern
- ⓚ Has a square elbow mounting bolt pattern

- ⓛ In-line applications
- ⓜ V-drive applications
- ⓝ Standard rise
- ⓞ 2" (51mm) rise
- ⓟ 3" (76mm) rise
- ⓠ 6" (152mm) rise
- ⓡ Port
- ⓢ Starboard
- ⓣ Engines with risers or closed cooling may require a different gasket than listed

- ⓤ Exhaust manifold with external water rail
- ⓖ Exhaust manifold w/o external water rail
- ⓗ 1 piece exhaust manifold is n/a. Engine must be converted to the 2 piece exhaust system
- ⓙ Engines with easy drain system
- ⓚ Engines with multi-point drain system
- ⓛ Intermediate collector housing

MANIFOLD/MANIFOLD GASKET APPLICATION (Cont.)

Liter	Model	Note	CID	# Cyl.	Stroke	Year Range	Serial # Range	Exh. Manifold Port	Exh. Manifold Starboard	Exh. Elbow	End Cap Front	End Cap Rear	Manifold Gasket	Exh. Elbow Gasket
5.7L	270		350	8	4	1969-1972	2851074 - 3385720				18-4009	18-1990	18-2949	18-0885-1
5.7L	270 MIE		350	8	4	1969-1972	2851074 - 3077735				18-4009	18-1990	18-2949	18-0885-1
5.7L	280 TRS		350	8	4	1975-1976	4176250 - 4770199	ⓐ	ⓐ	ⓐ	18-4009	18-1990	18-2949	18-0885-1
5.7L	280 TRS		350	8	4	1975-1976	4176250 - 4770199	18-1950-1 ⓑ	18-1951-1 ⓑ	ⓑ	18-4009	18-4009	18-2949	18-2833
5.7L	300		350	8	4	1985-1986	6668677 - B4300367	18-1953-2	18-1953-2				18-2949	18-2849-1
5.7L	320 EFI		350	8	4	1987-1989	A543604 - C622418	18-1953-2	18-1953-2	18-1976-2			18-2949	18-0897
5.7L	350 MAG ALPHA		350	8	4	1986-1997	A635178 - K999999	18-1953-2	18-1953-2	18-1976-2			18-2949	18-0897
5.7L	350 MAG ALPHA /		350	8	4	1996-1997	F800300 - K999999	18-1953-2	18-1953-2	18-1976-2			18-2949	18-0897
	350 MAG EFI													
5.7L	350 MAG BRAVO /		350	8	4	1995	F415189 - F601999	18-1953-2	18-1953-2	18-1976-2			18-2949	18-0897
	350 MAG MPI													
5.7L	350 MAG BRAVO GEN + /		350	8	4	1996-1997	F602000 - K999999	18-1953-2	18-1953-2	18-1976-2			18-2949	18-0897
	350 MAG MPI GEN +													
5.7L	350 MAG EFI /		350	8	4	1994-1996	F215561 - F820706	18-1953-2	18-1953-2	18-1976-2			18-2949	18-0897
	350 MAG SKI													
5.7L	350 MAG EFI GEN + /		350	8	4	1996-1997	F820707 - K999999	18-1953-2	18-1953-2	18-1976-2			18-2949	18-0897
	350 MAG SKI GEN +													
5.7L	350 MAG MPI		350	8	4	1998-2001	L010019 - M299999	18-1953-2	18-1953-2	18-1976-2			18-2949	18-2849-1
5.7L	350 MAG MPI		350	8	4	2002	M300000 - M599999	18-1953-2	18-1953-2	18-1976-2			18-2949	18-0897
5.7L	350 MAG MPI		350	8	4	2002-2004	M600000 - W309999						18-2949	
5.7L	350 MAG MPI		350	8	4	2004-2010	W310000 & UP						18-2949	
5.7L	350 MAG MPI /		350	8	4	2002	M300000 - M599999	18-1953-2	18-1953-2	18-1976-2			18-2949	18-2849-1
	350 MAG HORIZON													
5.7L	350 MAG MPI /		350	8	4	2002-2004	M600000 - W309999						18-2949	
	350 MAG HORIZON													
5.7L	350 MAG MPI /		350	8	4	2004-2007	W310000 - A299999						18-2949	
	350 MAG HORIZON													
5.7L	350 MAG MPI /		350	8	4	1999-2001	L304700 - M299999	18-1953-2	18-1953-2	18-1976-2			18-2949	18-2849-1
	350 MAG HORIZON / 350 MAG MIE													
5.7L	350 MAG MPI /		350	8	4	2002	M300000 - M316999	18-1953-2	18-1953-2	18-1976-2			18-2949	18-2849-1
	350 MAG HORIZON / 350 MAG MIE													
5.7L	350 MAG MPI /		350	8	4	2002-2007	M317000 - A089999						18-2949	
	350 MAG HORIZON / 350 MAG MIE													
5.7L	350 MAG MPI /		350	8	4	1998-2001	L002008 - M299999	18-1953-2	18-1953-2	18-1976-2			18-2949	18-2849-1
	350 MAG MIE													
5.7L	350 MAG MPI		350	8	4	2002	M300000 - M316999	18-1953-2	18-1953-2	18-1976-2			18-2949	18-0897
	/ 350 MAG MIE													
5.7L	350 MAG MPI		350	8	4	2002-2007	M317000 - A089999						18-2949	
	/ 350 MAG MIE													
5.7L	350 MAG MPI		350	8	4	1995-1996	F350583 - F799999	18-1953-2	18-1953-2	18-1976-2			18-2949	
	/ 350 MAG SKI													
5.7L	350 MAG MPI GEN +		350	8	4	1998-2001	L002600 - M299999	18-1953-2	18-1953-2	18-1976-2			18-2949	18-2849-1
	/ 350 MAG SKI GEN +													
5.7L	350 MAG MPI GEN +		350	8	4	2002	M300000 - M316999	18-1953-2	18-1953-2	18-1976-2			18-2949	18-0897
	/ 350 MAG SKI GEN +													
5.7L	350 MAG MPI GEN +		350	8	4	2002-2007	M317000 - A089999			ⓐ			18-2949	18-0897
	/ 350 MAG SKI GEN +													
5.7L	350 MAG MPI GEN +		350	8	4	2002-2007	M317000 - A089999			ⓐ			18-2949	
	/ 350 MAG SKI GEN +													
5.7L	350 MAG SKI		350	8	4	1991-1997	D505450 - K999999	18-1953-2	18-1953-2	18-1976-2			18-2949	18-0897
5.7L	5.7L		350	8	4	1988-1997	B773305 - K999999	18-1953-2	18-1953-2	18-1976-2			18-2949	18-0897

- ⓐ For engines with aluminum exhaust manifolds
- ⓑ For engines with cast iron exhaust manifolds
- ⓐ 3" (76mm) O.D. & 0 degree down angle
- ⓑ 3" (76mm) O.D. & 15 degree down angle
- ⓐ 4" (102mm) O.D.
- ⓑ 2 piece exhaust manifold
- ⓐ 1 piece exhaust manifold
- ⓑ Has a rectangular elbow mounting bolt pattern
- ⓐ Has a square elbow mounting bolt pattern

- ⓐ In-line applications
- ⓑ V-drive applications
- ⓐ Standard rise
- ⓑ 2" (51mm) rise
- ⓐ 3" (76mm) rise
- ⓑ 6" (152mm) rise
- ⓐ Port
- ⓑ Starboard
- ⓐ Engines with risers or closed cooling may require a different gasket than listed

- ⓐ Exhaust manifold with external water rail
- ⓑ Exhaust manifold w/o external water rail
- ⓐ 1 piece exhaust manifold is n/a. Engine must be converted to the 2 piece exhaust system
- ⓑ Engines with easy drain system
- ⓐ Engines with multi-point drain system
- ⓑ Intermediate collector housing

MANIFOLD/MANIFOLD GASKET APPLICATION (Cont.)

Liter	Model	Note	CID	#Cyl.	Stroke	Year Range	Serial # Range	Exh. Manifold Port	Exh. Manifold Starboard	Exh. Elbow	End Cap Front	End Cap Rear	Manifold Gasket	Exh. Elbow Gasket
5.7L	5.7L GEN +		350	8	4	1998-2002	L010037 - M599999	18-1953-2	18-1953-2	18-1976-2			18-2949	18-2849-1
5.7L	5.7L GEN +		350	8	4	2002-2004	M600000 - W309999						18-2949	
5.7L	5.7L GEN +		350	8	4	2004-2010	W310000 & UP						18-2949	
5.7L	5.7L EFI		350	8	4	1995-1997	F225560 - K999999	18-1953-2	18-1953-2	18-1976-2			18-2949	18-0897
5.7L	5.7L EFI GEN +		350	8	4	1998-2001	L010035 - M299999	18-1953-2	18-1953-2	18-1976-2			18-2949	18-2849-1
5.7L	5.7L EFI / 5.7L MIE		350	8	4	1997	K040300 - K999999	18-1953-2	18-1953-2	18-1976-2			18-2949	18-0897
5.7L	5.7L MIE		350	8	4	1988-1997	B788152 - K999999	18-1953-2	18-1953-2	18-1976-2			18-2949	18-0897
5.7L	5.7L MIE GEN +		350	8	4	1998-2002	L002003 - M316999	18-1953-2	18-1953-2	18-1976-2			18-2949	18-2849-1
5.7L	5.7L MIE GEN +		350	8	4	2002-2010	M317000 & UP						18-2949	
5.7L	5.7L MPI / 5.7L MIE		350	8	4	2008-2010	A090000 & UP						18-2949	
5.7L	5.7L MPI / 5.7L SKI		350	8	4	2008-2010	A090000 & UP			Ⓜ			18-2949	
5.7L	5.7L MPI / 5.7L SKI		350	8	4	2008-2010	A090000 & UP			①			18-2949	
5.7L	5.7L SKI		350	8	4	1985-1995	A338553 - F775199	18-1953-2	18-1953-2	18-1970-2 Ⓜ			18-2949	18-0897
5.7L	5.7L SKI		350	8	4	1985-1995	A338553 - F775199	18-1953-2	18-1953-2	18-1976-2 Ⓜ			18-2949	18-0897
5.7L	5.7L SKI		350	8	4	1996-1997	F775200 - K999999	18-1953-2	18-1953-2	18-1976-2			18-2949	18-0897
5.7L	5.7L SKI		350	8	4	1998-2002	L002005 - M316999	18-1953-2	18-1953-2	18-1976-2			18-2949	18-2849-1
5.7L	5.7L SKI		350	8	4	2002-2010	M317000 & UP						18-2949	
5.7L	5.7LX		350	8	4	1996-1997	F601000 - K999999	18-1953-2	18-1953-2	18-1976-2			18-2949	18-0897
5.7L	5.7LX BRAVO EFI		350	8	4	1996-1997	F800300 - K999999	18-1953-2	18-1953-2	18-1976-2			18-2949	18-0897
5.7L	5.7LX EFI		350	8	4	1996-1997	F752400 - K999999	18-1953-2	18-1953-2	18-1976-2			18-2949	18-0897
5.7L	BLACK SCORPION SKI		350	8	4	1996-1997	F800000 - K999999	18-1953-2	18-1953-2	18-1976-2			18-2949	18-0897
5.7L	BLACK SCORPION SKI		350	8	4	2003-2007	M391600 - W698432			Ⓜ			18-2949	
5.7L	BLACK SCORPION SKI		350	8	4	2003-2007	M391600 - W698432			①			18-2949	
5.7L	SCORPION 350		350	8	4	2008-2010	W698433 & UP			Ⓜ			18-2949	
5.7L	SCORPION 350		350	8	4	2008-2010	W698433 & UP			①			18-2949	
6.2L	233		351	8	4	1975-1977	4173000 - 4902304	18-1958-1	18-1962-1	18-1971	18-4009	18-4009	18-0183-1	18-2833
6.2L	233 MIE		351	8	4	1975-1977	4173000 - 4902304	18-1958-1	18-1962-1	N.L.A.	18-4009	18-4009	18-0183-1	18-2833
6.2L	233 MIE		351	8	4	1975-1977	4173000 - 4902304	18-1958-1	18-1962-1	N.L.A.	18-1990 □	18-4009	18-0183-1	18-2833
6.2L	255	FORD	351	8	4	1973-1974	3258728 - 4175499	18-1958-1	18-1962-1	18-1971	18-4009	18-4009	18-0183-1	18-2833
6.2L	255 MIE	FORD	351	8	4	1973-1974	3258728 - 4175499	18-1958-1	18-1962-1		18-4009	18-4009	18-0183-1	18-2833
6.2L	225 MIE	FORD	351	8	4	1973-1974	3258728 - 4175499	18-1958-1	18-1962-1		18-1990 □	18-4009	18-0183-1	18-2833
6.2L	377 MAG		377	8	4	2008-2010	A300000 & UP						18-2949	
6.2L	377 SCORPION MCM		377	8	4	1999-2005	L416146 - M907201	18-1953-2	18-1953-2	18-1976-2			18-2949	18-2849-1
6.2L	377 SCORPION SKI		377	8	4	1997-1998	K000656 - L600314	18-1953-2	18-1953-2	18-1976-2			18-2949	18-0897
6.2L	MX 6.2L MPI		377	8	4	2000-2001	L680003 - M299999	18-1953-2	18-1953-2	18-1976-2			18-2949	18-2849-1
6.2L	MX 6.2L MPI		377	8	4	2002	M300000 - M599999	18-1953-2	18-1953-2	18-1976-2			18-2949	18-0897
6.2L	MX 6.2L MPI		377	8	4	2002-2004	M600000 - W309999						18-2949	
6.2L	MX 6.2L MPI		377	8	4	2004-2007	W310000 - A299999						18-2949	
6.2L	MX 6.2L MPI / MX 6.2L HORIZON		377	8	4	2002	M300000 - M599999	18-1953-2	18-1953-2	18-1976-2			18-2949	18-2849-1
6.2L	MX 6.2L MPI / MX 6.2L HORIZON		377	8	4	2002-2004	M600000 - W309999						18-2949	
6.2L	MX 6.2L MPI / MX 6.2L HORIZON		377	8	4	2004-2007	W310000 - A299999						18-2949	
6.2L	MX 6.2L MPI / MX 6.2L HORIZON / MX 6.2L MIE		377	8	4	2002	M300000 - M316999	18-1953-2	18-1953-2	18-1976-2			18-2949	18-2849-1
6.2L	MX 6.2L MPI / MX 6.2L HORIZON / MX 6.2L MIE		377	8	4	2002-2007	M317000 - A089999						18-2949	
6.2L	MX 6.2L MPI / MX 6.2L MIE		377	8	4	1999-2001	L670000 - M299999	18-1953-2	18-1953-2	18-1976-2			18-2949	18-2849-1
6.2L	MX 6.2L MPI / MX 6.2L MIE		377	8	4	2002	M300000 - M316999	18-1953-2	18-1953-2	18-1976-2			18-2949	18-0897
6.2L	MX 6.2L MPI / MX 6.2L MIE		377	8	4	2002-2010	M317000 & UP						18-2949	
6.2L	MX 6.2L MPI / MX 6.2L SKI		377	8	4	2002-2007	M317000 - A089999						18-2949	
6.2L	MX 6.2L MPI / MX 6.2L SKI		377	8	4	2002-2007	M317000 - A089999						18-2949	
6.2L	MX 6.2L BLACK SCORPION SKI		377	8	4	2001-2003	L670015 - M391599	18-1953-2	18-1953-2	18-1976-2			18-2949	18-2849-1

- Ⓜ For engines with aluminum exhaust manifolds
- Ⓜ For engines with cast iron exhaust manifolds
- Ⓜ 3" (76mm) O.D. & 0 degree down angle
- Ⓜ 3" (76mm) O.D. & 15 degree down angle
- Ⓜ 4" (102mm) O.D.
- Ⓜ 2 piece exhaust manifold
- Ⓜ 1 piece exhaust manifold
- Ⓜ Has a rectangular elbow mounting bolt pattern
- Ⓜ Has a square elbow mounting bolt pattern

- Ⓜ In-line applications
- ① V-drive applications
- ② Standard rise
- ③ 2" (51mm) rise
- ④ 3" (76mm) rise
- ⑤ 6" (152mm) rise
- Ⓜ Port
- ⑦ Starboard
- Ⓜ Engines with risers or closed cooling may require a different gasket than listed

- Ⓜ Exhaust manifold with external water rail
- Ⓜ Exhaust manifold w/o external water rail
- Ⓜ 1 piece exhaust manifold is n/a. Engine must be converted to the 2 piece exhaust system
- Ⓜ Engines with easy drain system
- Ⓜ Engines with multi-point drain system
- Ⓜ Intermediate collector housing

MANIFOLD/MANIFOLD GASKET APPLICATION (Cont.)

Liter	Model	Note	CID	# Cyl.	Stroke	Year Range	Serial # Range	Exh. Manifold Port	Exh. Manifold Starboard	Exh. Elbow	End Cap Front	End Cap Rear	Manifold Gasket	Exh. Elbow Gasket
6.2L	MX 6.2L BLACK SCORPION SKI		377	8	4	2003-2007	M391600 - W698432						18-2949	
6.2L	MX 6.2L BLACK SCORPION SKI		377	8	4	2003-2007	M391600 - W698432						18-2949	
6.2L	SCORPION 377		377	8	4	2008-2010	W698433 & UP						18-2949	
6.2L	SCORPION 377		377	8	4	2008-2010	W698433 & UP						18-2949	
7.4L	325		427	8	4	1968	2278747 - 2313964						18-0418	
7.4L	325		427	8	4	1968-1974	2313965 - 3780449				18-4009	18-1990	18-0418	18-0885-1
7.4L	325 MIE		427	8	4	1968	2278747 - 2313964						18-0418	
7.4L	325 MIE		427	8	4	1968-1974	2313965 - 3780449				18-4009	18-1990	18-0418	18-0885-1
7.4L	330		454	8	4	1977-1981	4623115 - 6083144				18-4009	18-4009	18-0418	18-0885-1
7.4L	330		454	8	4	1982-1987	6083145 - B816540	18-1957-2	18-1957-2	18-1970-2 ①			18-0418	18-0897
7.4L	330		454	8	4	1982-1987	6083145 - B816540	18-1957-2	18-1957-2	18-1976-2 ②			18-0418	18-0897
7.4L	330 MIE		454	8	4	1977-1981	4623115 - 6083144				18-4009	18-4009	18-0418	18-0885-1
7.4L	340 MIE W/BW		454	8	4	1981-1987	5889914 - B788365	18-1957-2	18-1957-2	18-1974-1 ③			18-0418	18-0897
7.4L	340 MIE W/BW		454	8	4	1981-1987	5889914 - B788365	18-1957-2	18-1957-2	18-1970-2 ④			18-0418	18-0897
7.4L	340 MIE W/BW		454	8	4	1981-1987	5889914 - B788365	18-1957-2	18-1957-2	18-1976-2 ⑤			18-0418	18-0897
7.4L	350 MIE		454	8	4	1974-1975	3780450 - 4501640				18-4009	18-1990	18-0418	18-0885-1
7.4L	350 MIE		454	8	4	1976	4501641 - 4623109				18-4009	18-4009	18-0418	18-0885-1
7.4L	370 TRS		454	8	4	1978-1985	4179554 - 6721527				18-4009	18-1990	18-0418	18-0885-1
7.4L	370 TRS		454	8	4	1985-1987	6721528 - B714586	18-1957-2	18-1957-2	18-1976-2			18-0418	18-2849-1
7.4L	400 TRS		454	8	4	1980-1986	4179554 - B457644				18-4009	18-1990	18-0418	18-0885-1
7.4L	420		454	8	4	1987-1989	A398941 - B622418						18-0418	
7.4L	425		454	8	4	1990-1992	G398941 - D937011						18-0418	
7.4L	440 TRS		454	8	4	1983-1986	4179554 - B485220						18-0418	
7.4L	450		454	8	4	1995-1996	F347100 - F347277			②			18-0418	
7.4L	450		454	8	4	1995-1996	F347100 - F347277			④			18-0418	
7.4L	450		454	8	4	1995-1996	F347100 - F347277			⑤			18-0418	
7.4L	454 MAG ALPHA		454	8	4	1986-1988	A631894 - B785148	18-1957-2	18-1957-2	18-1976-2			18-0418	18-0897
7.4L	454 MAG BRAVO		454	8	4	1988-1997	B721206 - K999999	18-1957-2	18-1957-2	18-1976-2			18-0418	18-0897
7.4L	454 MAG EFI		454	8	4	1994-1996	F115700 - F802349	18-1957-2	18-1957-2	18-1976-2			18-0418	18-0897
7.4L	454 MAG EFI / 454 MAG SKI		454	8	4	1995-1996	F215800 - F820099	18-1957-2	18-1957-2	18-1976-2			18-0418	18-0897
7.4L	454 MAG MPI		454	8	4	1996-1997	F802350 - K999999	18-1957-2	18-1957-2	18-1976-2			18-0418	18-0897
7.4L	454 MAG MPI		454	8	4	1998-2001	L010029 - M0224999	18-1957-2	18-1957-2	18-1976-2			18-0418	18-2849-1
7.4L	454 MAG MPI / 454 MAG HORIZON / 454 MAG MIE		454	8	4	1999-2001	L086050 - L674000	18-1957-2	18-1957-2	18-1976-2			18-0418	18-2849-1
7.4L	454 MAG MPI / 454 MAG SKI		454	8	4	1996-1997	F820100 - K999999	18-1957-2	18-1957-2	18-1976-2			18-0418	18-0897
7.4L	525 SC W/BRAVO		454	8	4	1991-1996	D456000 - F877734			②			18-0418	
7.4L	525 SC W/BRAVO		454	8	4	1991-1996	D456000 - F877734			④			18-0418	
7.4L	525 SC W/BRAVO		454	8	4	1991-1996	D456000 - F877734			⑤			18-0418	
7.4L	525 SC W/SSM		454	8	4	1991-1996	D456000 - F877734			②			18-0418	
7.4L	525 SC W/SSM		454	8	4	1991-1996	D456000 - F877734			④			18-0418	
7.4L	525 SC W/SSM		454	8	4	1991-1996	D456000 - F877734			⑤			18-0418	
7.4L	7.4L BRAVO		454	8	4	1988-1997	B771113 - K999999	18-1957-2	18-1957-2	18-1976-2			18-0418	18-0897
7.4L	7.4L EFI / 7.4L MIE		454	8	4	1996-1997	F874815 - K999999	18-1957-2	18-1957-2	18-1976-2			18-0418	18-0897
7.4L	7.4L MIE W/BW		454	8	4	1988-1992	B788366 - D715493	18-1957-2	18-1957-2	18-1974-1 ③			18-0418	18-0897
7.4L	7.4L MIE W/BW		454	8	4	1988-1992	B788366 - D715493	18-1957-2	18-1957-2	18-1970-2 ④			18-0418	18-0897
7.4L	7.4L MIE W/BW		454	8	4	1988-1992	B788366 - D715493	18-1957-2	18-1957-2	18-1976-2 ⑤			18-0418	18-0897
7.4L	7.4L MIE W/HURTH		454	8	4	1989-1992	C391564 - D715493	18-1957-2	18-1957-2	18-1976-2			18-0418	18-0897
7.4L	7.4L MIE		454	8	4	1992-1997	D715494 - K999999	18-1957-2	18-1957-2	18-1976-2			18-0418	18-0897
7.4L	7.4L MPI		454	8	4	1998-2001	L010003 - M024330	18-1957-2	18-1957-2	18-1976-2			18-0418	18-2849-1
7.4L	7.4L MPI / 7.4L MIE		454	8	4	1995-1997	F563052 - K999999	18-1957-2	18-1957-2	18-1976-2			18-0418	18-0897
7.4L	7.4L MPI / 7.4L MIE		454	8	4	1998-2001	L002006 - L674613	18-1957-2	18-1957-2	18-1976-2			18-0418	18-2849-1

- ① For engines with aluminum exhaust manifolds
- ② For engines with cast iron exhaust manifolds
- ③ 3" (76mm) O.D. & 0 degree down angle
- ④ 3" (76mm) O.D. & 15 degree down angle
- ⑤ 4" (102mm) O.D.
- ⑥ 2 piece exhaust manifold
- ⑦ 1 piece exhaust manifold
- ⑧ Has a rectangular elbow mounting bolt pattern
- ⑨ Has a square elbow mounting bolt pattern

- ⑩ In-line applications
- ⑪ V-drive applications
- ⑫ Standard rise
- ⑬ 2" (51mm) rise
- ⑭ 3" (76mm) rise
- ⑮ 6" (152mm) rise
- ⑯ Port
- ⑰ Starboard
- ⑱ Engines with risers or closed cooling may require a different gasket than listed

- ⑲ Exhaust manifold with external water rail
- ⑳ Exhaust manifold w/o external water rail
- ㉑ 1 piece exhaust manifold is n/a. Engine must be converted to the 2 piece exhaust system
- ㉒ Engines with easy drain system
- ㉓ Engines with multi-point drain system
- ㉔ Intermediate collector housing

MANIFOLD/MANIFOLD GASKET APPLICATION (Cont.)

Liter	Model	Note	CID	# Cyl.	Stroke	Year Range	Serial # Range	Exh. Manifold Port	Exh. Manifold Starboard	Exh. Elbow	End Cap Front	End Cap Rear	Manifold Gasket	Exh. Elbow Gasket
7.4L	7.4LX BRAVO EFI		454	8	4	1996-1997	F820000 - K999999	18-1957-2	18-1957-2	18-1976-2			18-0418	18-0897
7.4L	7.4LX BRAVO MPI		454	8	4	1996-1997	F602010 - K999999	18-1957-2	18-1957-2	18-1976-2			18-0418	18-0897
	390 MCM / 390 MIE		482	8	4	1969-1970	2781129 - 3042731				18-1990	18-1990	18-0418	18-0885-1
	496 MAG / 496 HO		496	8	4	2001-2003	M025000 - M687143		⑨	②			18-0418	
	496 MAG / 496 HO		496	8	4	2001-2010	M0225000 & UP		⑩	②			18-0418	
	8.1S / 8.1 HO / 8.1 MIE		496	8	4	2001-2003	M026000 - M319190		⑨	②			18-0418	
	8.1S / 8.1 HO / 8.1 MIE		496	8	4	2001-2010	M026000 & UP		⑩	②			18-0418	
8.2L	465		502	8	4	1990-1994	C849992 - F213244			②			18-0418	
8.2L	465		502	8	4	1990-1994	C849992 - F213244			④			18-0418	
8.2L	465		502	8	4	1990-1994	C849992 - F213244			⑤			18-0418	
8.2L	500 BRAVO		502	8	4	1994-1998	F213293 - L001772			②			18-0418	
8.2L	500 BRAVO		502	8	4	1994-1998	F213293 - L001772			④			18-0418	
8.2L	500 BRAVO		502	8	4	1994-1998	F213293 - L001772			⑤			18-0418	
8.2L	500 GEN +		502	8	4	1999	L414639 - L601036			②			18-0418	
8.2L	500 GEN +		502	8	4	1999	L414639 - L601036			④			18-0418	
8.2L	500 GEN +		502	8	4	1999	L414639 - L601036			⑤			18-0418	
8.2L	502 MAG BRAVO		502	8	4	1990-1993	C878221 - F114528	18-1957-2	18-1957-2	18-1976-2			18-0418	18-0897
8.2L	502 MAG EFI		502	8	4	1993-1995	D840650 - F802599	18-1957-2	18-1957-2	18-1976-2			18-0418	18-0897
8.2L	502 MAG MPI		502	8	4	1996-1997	F802600 - K999999	18-1957-2	18-1957-2	18-1976-2			18-0418	18-0897
8.2L	502 MAG MPI		502	8	4	1998-2001	L017000 - M024999	18-1957-2	18-1957-2	18-1976-2			18-0418	18-2849-1
8.2L	600 SC		502	8	4	1991-1996	D456489 - F877642						18-0418	
8.2L	600 SC		502	8	4	1991-1996	D456489 - F877642						18-0418	
8.2L	8.2L MIE		502	8	4	1990-1996	C878221 - F819619	18-1957-2	18-1957-2	18-1976-2			18-0418	18-0897
8.2L	8.2L MIE / 8.2L MPI		502	8	4	1996-1997	F819620 - K999999	18-1957-2	18-1957-2	18-1976-2			18-0418	18-0897
8.2L	8.2L MIE / 8.2L MPI		502	8	4	1998-2001	L002450 - L674200	18-1957-2	18-1957-2	18-1976-2			18-0418	18-2849-1
	500 BULLDOG W/BRAVO		540	8	4	1990-1998	C577254 - L001607			②			18-0418	
	500 BULLDOG W/BRAVO		540	8	4	1990-1998	C577254 - L001607			④			18-0418	
	500 BULLDOG W/BRAVO		540	8	4	1990-1998	C577254 - L001607			⑤			18-0418	
	500 BULLDOG W/BRAVO		540	8	4	1999-2001	L414620 - M050281			②			18-0418	
	500 BULLDOG W/BRAVO		540	8	4	1999-2001	L414620 - M050281			④			18-0418	
	500 BULLDOG W/BRAVO		540	8	4	1999-2001	L414620 - M050281			⑤			18-0418	
	500 BULLDOG W/SSM		540	8	4	1990-2001	C577254 - M050261			②			18-0418	
	500 BULLDOG W/SSM		540	8	4	1990-2001	C577254 - M050261			④			18-0418	
	500 BULLDOG W/SSM		540	8	4	1990-2001	C577254 - M050261			⑤			18-0418	

- ① For engines with aluminum exhaust manifolds
- ② For engines with cast iron exhaust manifolds
- ③ 3" (76mm) O.D. & 0 degree down angle
- ④ 3" (76mm) O.D. & 15 degree down angle
- ⑤ 4" (102mm) O.D.
- ⑥ 2 piece exhaust manifold
- ⑦ 1 piece exhaust manifold
- ⑧ Has a rectangular elbow mounting bolt pattern
- ⑨ Has a square elbow mounting bolt pattern

- ⑩ In-line applications
- ⑪ V-drive applications
- ⑫ Standard rise
- ⑬ 2" (51mm) rise
- ⑭ 3" (76mm) rise
- ⑮ 6" (152mm) rise
- ⑯ Port
- ⑰ Starboard
- ⑱ Engines with risers or closed cooling may require a different gasket than listed

- ⑲ Exhaust manifold with external water rail
- ⑳ Exhaust manifold w/o external water rail
- ㉑ 1 piece exhaust manifold is n/a. Engine must be converted to the 2 piece exhaust system
- ㉒ Engines with easy drain system
- ㉓ Engines with multi-point drain system
- ㉔ Intermediate collector housing



Features...

- Manufactured to meet or exceed OEM specifications.
- High Efficiency Filter
- Field-tested and approved.
- Anti-drainback valves where required.

Part #	O.E. #	Application
18-7824-2*	54111, 14957, 32716, 35-802885Q, 35-866340K01, 35-866340Q03, 35-866340Q02, 35-866340K01, 35-866340Q, 52731A1, 52731, 52022, 32717, 14957	GM Engines ① (Short Filter)
18-7871	35-805809, 35-805809T	D7.3L Diesel
18-7875*	60565, 35-802886Q	Ford Engines (Long Filter)
18-7876-1*	52731, 35-16595T, 35-866340Q03, 35-866340Q02, 32-802885Q, 14957, 54111, 52731A1, 52022, 32717, 32716	GM Engines (Long Filter)
18-7878-1*	803470, 803470Q, 46692, 38463	60 & 80 HP Engines (Renault) (Short Filter)
18-7879-1*	41815, 35-802884Q, 35-883702Q, K	GM V-6 Engines



OIL FILTERS

- ① Do not use on V-6 engines equipped with remote oil filter kit
- * Display Packaged

SEE PAGES 182-184 & 1147-1170 FOR ADDITIONAL INFORMATION

OIL PANS AND GASKET

Part No.	OE	OE No.	Application
18-0612	Mercruiser	809910, 14259	1 piece rear main seal; GM Small Block V8 (Right Handed Dipstick)
18-0613	Mercruiser	93476	2 piece rear main seal; GM Small Block V8 (Right Handed Dipstick)
18-0614	Mercruiser	845668T, 850458, 811549	1 piece rear main seal; GM Big Block V8 (Right Handed Dipstick)
18-0615	Mercruiser	93477T, 93477, 14760, 75639	2 piece rear main seal; GM Big Block V8 (Right Handed Dipstick)
18-0616	Mercruiser	14244T, 14244	1 piece rear main seal; GM V6 (Right Handed Dipstick)



Drain Plug: M12 - 1.75

CYLINDER HEAD ASSEMBLIES

All cylinder heads are new castings and complete assemblies with new- stainless steel valves, hardened steel exhaust seats, valve springs, valve locks, and retainers.
 All GM cylinder heads utilize high performance screw-in rocker arm studs in place of factory press in rocker arm studs.



18-4485
CYLINDER HEAD ASSEMBLY
Replaces: 938-883490R1, 938-883490, 938-883490R50, 938-884741R
 938-884741R50
Fits: 5.7L V-8 GM (1987-95) with press in rocker arm studs with 12 intake manifold mounting bolts- (4 inside intake manifold bolts at 23 degrees), center mount valve covers



18-4486
CYLINDER HEAD ASSEMBLY
Replaces: 938-883297 1, 938-803860T
Fits: 5.7L V-8 GM Vortec (1996-Up) with press in rocker arm studs with 8 intake manifold mounting bolts, composite valve cover



18-4486HP
CYLINDER HEAD ASSEMBLY
Fits: Vortec GM small block 5.7L high performance
 Completely assembled with revised runner and combustion chambers.
 Add 30hp to stock motor with no additional modifications.



18-4489
CYLINDER HEAD ASSEMBLY
Replaces: 936-5544, 936-810840
 1.94/1.60 valves.
Fits: 2.5L/3.0L GM (1968-95) (non MerCruiser LX models) (1968-95)



18-4491
CYLINDER HEAD ASSEMBLY
Replaces: 938-827178
 Replaces 4.3L Vortec V-6 (1996-Up) with screw in rocker arm studs (non-adjustable valve train), 8 intake manifold mounting bolts, center mount valve cover. NOTE: not for use with engines using factory roller rocker arms.



18-4501
CYLINDER HEAD
Fits: 5.0L Vortec



18-4501HP
CYLINDER HEAD
Fits: Vortec GM small block 5.0L
 Completely assembled with revised runner and combustion chambers. Add 30hp to stock motor with no additional modifications.



18-4492
ROCKER ARM ASSEMBLY
Replaces: 35329, F3746241, F11100014, F11100495
Fits: MCM/MIE Gm V6 & V8(283, 305 & 350 cid) engines



18-7508
POWER STEERING PUMP
Replaces: 16792A39, 16792A33



18-8227
POWER STEERING PUMP PULLEY
Replaces: 73873A1, 73873
For: Stern drives with v-belt



18-8297
POWER STEERING PUMP PULLEY
Replaces: 861578
For: Stern drives with serpentine belt



18-1400
HYDRAULIC LIFTER
Replaces: 17340, 17340T
GM 4.3L/V-6 Late/5.0L/5.7L



18-1401
HYDRAULIC LIFTER
Replaces: 56153, F724102
Ford 302/351
Ford 5.0L & 5.8L



18-1402
HYDRAULIC LIFTER
Replaces: 72638, 34282, 35583, 46472, 46744, 49117, F2769931, F5232670, F11100349, F11100399, F11100862, F11100954, F11101222
GM 2.5L/120
For: Mercuriser 140 (S/N 2508261-6229717), 140/3.0L (S/N 6229718-up), 3.0L/3.0LX (S/N C856559-up)

PISTONS



All pistons are supplied complete with piston rings and wrist pin.

RINGS	
STD	REPLACES
18-3928	39-74381A1, 39-75422
18-3937	39-17464, 39-65153, 39-67123, 39-34988, F328506, F3892364, F11100386, F11100692, F11101321
18-3940	39-67127
18-3942	39-67132, 39-67119, 39-58096, 39-34479
18-3944	39-75609, F11101057
.020	
18-3939	39-66217, 39-97125, 39-48344, F11100387, F11100783, F11101134
.030	
18-3938	39-17465, 39-67126, 39-48345, F11100694, F11101322, F328516

PISTONS	
STD	REPLACES
18-4180	736-2343, 733-66217, 733-2278
18-4181	735-6538
18-4161	733-3819, 733-803850T, 733-4028, 24-38191, F11100779, F11100780
18-4109	778-9441A3, 759-80661A7, 759-80661A3, 759-8312A2, 759-831210, 759-661010, 759-592010, 778-9015A2
18-4173	735-6370, 735-9686, 735-808674, 735-850097, 735-808674A1, 735-808661, 735-9703, 735-6370, F11101184, F11101318, F11101334, 833232E
.020	
18-4160	733-3818, 733-38181, F11100781
18-4189	737-6523, 737-6523, 737-879194035, F11101101
.030	
18-4134	778-9441A5, 759-80661A8, 759-80661A5, 759-9015A4, 759-8312A6, 759-831212, 759-661012, 759-592012
18-4164	735-6371, 735-9687, 735-850098, 735-9431, 735-9704, F11101185, F11101320, F11101336
18-4178	735-9715, 735-97151, 735-9715T1, F11101317
18-4191	733-3819, 733-38191, 733-803850T, 733-4028, F11100779, F11100780

PISTON/RING APPLICATION

Liter	Model	Note	CID	# Cyl	Stroke	Year	Serial #	Pistons Std.	0.02	0.03	Rings Std.	0.02	0.03	Qty. Eng.
1.6L	100 VASER		98	4	4	2007-2010	W995000 & UP	-	-	-	-	-	-	
2.5L	120		153	4	4	1964-1986	1666601 - B531853	18-4180	-	-	-	-	-	
2.5L	2.5L		153	4	4	1987-1989	B531854 - C853255	18-4180	-	-	-	-	-	
3.0L	140		181	4	4	1968-1986	2508261 - B450800	18-4161	18-4160	18-4191	18-3937	18-3939	18-3938	4
3.0L	140				4		3332138 - 5157668	18-4161	18-4160	18-4191	18-3937	18-3939	18-3938	4
3.0L	140				4		5157669 - 6229717	18-4161	18-4160	18-4191	18-3937	18-3939	18-3938	4
3.0L	140 / 3.0L				4		6229718 - C856558	18-4161	18-4160	18-4191	18-3937	18-3939	18-3938	4
3.0L	3.0L		181	4	4	1987-1989	B450801 - C856558	18-4161	18-4160	-	-	-	-	
3.0L	3.0L		181	4	4	1990-1994	C856559 - F603999	-	-	-	18-3937	18-3939	18-3938	6
3.0L	3.0L		181	4	4	1998-2010	L010042 & UP	-	-	-	-	-	-	
3.0L	3.0L MPI		181	4	4	2008-2010	A072812 & UP	-	-	-	-	-	-	
3.0L	3.0LX		181	4	4	1990-1997	C856559 - K999999	-	-	-	-	-	-	
3.7L	165 / 3.7L		224	4	4	1987-1989	B434941 - C762299	-	-(11)	18-4134	-	-	-	
3.7L	170		224	4	4	1985-1986	6916779 - B434940	18-4109	18-4118	18-4134	18-3928	18-3929	-	4
3.7L	180 / 3.7LX		224	4	4	1987-1989	B436391 - C762299	18-4109	-(11)	18-4134	-	-	-	
3.7L	190 / 3.7L		224	4	4	1985-1986	6916779 - B436390	18-4109	-(11)	18-4134	-	-	-	
3.7L	470		224	4	4	1976-1984	4208730 - 6916779	18-4109	18-4118	18-4134	18-3928	18-3929	-	4
3.7L	485		224	4	4	1980-1982	5685394 - 6218036	18-4109	-(11)	18-4134	-	-	-	
3.7L	488		224	4	4	1983-1984	6170297 - 6916778	18-4109	-(11)	18-4134	-	-	-	
	150				4		1666495 - 2048046	18-4180	18-4183	-	18-3942	-	-	6
4.1L	160		250	6	4	1987-1989	2048022 - 2770031	-	-	-	18-3942	-	-	
4.1L	165		250	6	4	1970-1981	2770032 - 5813433	-	-	-	18-3942	-	-	
4.3L	175 / 4.3L				4		B527955 - & Up	18-4173	18-4188	18-4164	18-3937	18-3939	18-3938	6
3.8L	185	2bb1			4	1983-1984	6330183 - 6919655	-	-	-	18-3944	-	-	
4.3L	175 / 4.3L		262	6	4	1987-1992	B527955 - D714106	-	-	-	-	-	-	
4.3L	185	2bb1	262	6	4	1985-1986	A331455 - B527954	-	-	18-4164	18-3937	18-3939	-	
4.3L	205 / 4.3LX		262	6	4	1985-1986	A331455 - B527954	-	-	18-4164	18-3937	18-3939	18-3938	
4.3L	262 MAG EFI GEN +		262	6	4	1987-1991	B527955 - D714369	18-4173	-	-	-	-	-	
4.3L	262 MAG EFI GEN +		262	6	4	1996-1997	F803800 - K999999	-	-	-	-	-	-	
4.3L	4.3L GEN II		262	6	4	1992-1996	D714107 - F802999	18-4173	18-4188	-	-	-	18-3938	6
4.3L	4.3L GEN +		262	6	4	1998-2010	L010044 & UP	-	-	-	-	-	-	
4.3L	4.3L EFI GEN +		262	6	4	1998-2001	L012009 - M299999	-	-	-	-	-	-	
4.3L	4.3L MPI		262	6	4	2002-2010	M322761 & UP	-	-	-	-	-	-	
4.3L	4.3LH GEN +		262	6	4	1998-2002	L010044 - M614999	-	-	-	-	-	-	
4.3L	4.3LX GEN II		262	6	4	1992-1996	D7141370 - F802999	-	-	18-4164	18-3937	18-3939	18-3938	6
4.3L	4.3LX GEN +		262	6	4	1996-1997	F803000 - K999999	-	-	-	-	-	-	
4.3L	4.3LXH GEN +		262	6	4	1996-1997	F803114 - K999999	-	-	-	-	-	-	
4.9L	215	FORD	302	8	4	1970-1972	2781153 - 3395720	-	-	-	18-3937	18-3939	18-3938	8
4.9L	215	FORD			4	1973-1974	3385721 - 4166999	-	-	-	18-3937	18-3939	18-3938	8
	225	GM			4		1536920 - & Up	-	-	-	18-3937	18-3939	18-3938	8
4.6L	190	GM	283	8	4	1963-1964	1564539 - 1730903	18-4180	18-4183	-	18-3942	-	-	6
5.0L	198 MIE		305	8	4	1977	4776402 - 4931099	-	-	-	-	-	-	
5.0L	200		305	8	4	1985-1987	6899058 - B525981	-	-	-	-	-	-	
5.0L	200 / 5.0L	GM	305	8	4	1987	B525982 - B774444	-	-	18-4178	18-3944	-	-	8
	200	GM			4		6218462 - & Up	-	-	-	18-3944	-	-	8
5.0L	228	GM	305	8	4	1977-1984	4765100 - 6899268	-	-	-	18-3944	-	-	8
5.0L	228 MIE		305	8	4	1977-1980	5170009 - 5907057	-	-	-	-	-	-	
5.0L	230		305	8	4	1985-1987	6899269 - B525981	-	-	-	-	-	-	
5.0L	230		305	8	4	1987-1995	B525982 - B773739	-	-	18-4178	18-3944	-	-	8
5.0L	230 MIE	GM	305	8	4	1981-1987	5907058 - B522505	-	-	-	18-3944	-	-	8
5.0L	230 MIE		305	8	4	1987	B522506 - B788151	-	-	18-4178	18-3944	-	-	8
5.0L	230 GM				8	4	6218462 - & Up	-	-	-	18-3944	-	-	8
5.0L	5.0L		305	8	4	1988-1995	B774445 - F600999	-	-	-	-	-	-	
5.0L	5.0L GEN +		305	8	4	1998-2010	L015751 & UP	-	-	-	-	-	-	
5.0L	5.0L EFI GEN +		305	8	4	1998-2001	L012052 - M299999	-	-	-	-	-	-	

(1) Cast Aluminum (Use with GM Engine Code 1XW)
 (2) Cast aluminum (Use with GM Engine Code 4XW)
 (3) Forged Aluminum (Use with GM Engine Code 3UB)
 (4) Cast Aluminum (Use with GM Engine Code 4XX)

(5) Cast Aluminum (Use with GM Engine Code 2XY)
 (6) Cast Aluminum (Use with GM Engine Code 4XY)
 (7) Flat Head
 (8) Forged Aluminum, Recessed Head

(9) Starboard
 (10) Port
 (11) .010 (25mm) Oversize
 N.L.A. No longer available from O.E. source

PISTON/RING APPLICATION

Liter	Model	Note	CID	# Cyl	Stroke	Year	Serial #	Pistons Std.	0.02	0.03	Rings Std.	0.02	0.03	Qty. Eng.
5.0L	5.0L MIE		305	8	4	1988	B788152 - C396832	-	-	-	-	-	-	
5.0L	5.0L MPI		305	8	4	2002-2010	M300000 & UP	-	-	-	-	-	-	
5.0L	5.0LX		305	8	4	1988-1995	B773740 - F600999	-	-	-	-	-	-	
5.0L	898 / 198	GM	305	8	4	1977-1984	4762210 - 6899057	18-4181	-	-	18-3944	-	-	8
5.4L	225 MCM / 225 MIE	GM	327	8	4	1963-1969	1539620 - 2694014	-	-	-	-	-	-	
5.4L	250 MCM - 250 MIE	GM	327	8	4	1968-1969	2314301 - 2639854	-	-	-	18-3937	18-3939	18-3938	8
5.7L	250	GM	350	8	4	1977	4768000 - 4908849	18-4173	18-4188	18-4164	18-3937	18-3939	18-3938	8
5.7L	255	GM	350	8	4	1975-1976	4175500 - 4767999	18-4173	18-4188	18-4164	18-3937	18-3939	18-3938	8
5.7L	255 MIE	GM	350	8	4	1975-1980	4175500 - 5907057	18-4173	-	-	-	-	-	8
5.7L	260	GM	350	8	4	1978-1987	4908850 - B773304	18-4173	18-4188	18-4164	18-3937	18-3939	18-3938	8
5.7L	260 MIE	GM	350	8	4	1981-1987	5907058 - B788151	18-4173	18-4188	18-4164	18-3937	18-3939	18-3938	8
5.7L	260 / 5.7L	GM	350	8	4		B525982 - & Up	18-4173	18-4188	18-4164	18-3937	18-3939	18-3938	8
5.7L	270 MCM / 270 MIE		350	8	4	1969-1972	2851074 - 3077735	-	-	-	18-3937	18-3939	18-3938	8
5.7L	280		350	8	4	1975-1976	4176250 - 4770199	-	-	-	-	-	-	8
5.7L	300		350	8	4	1985-1988	6668677 - B430367	-	-	-	18-3937	18-3939	18-3938	8
5.7L	320 EFI		350	8	4	1987-1989	A543604 - C622418	-	-	-	18-3937	18-3939	18-3938	8
5.7L	320 GM EFI BRAVO			8	4		B157603 - & Up	-	-	-	18-3937	18-3939	18-3938	8
	325	GM			4		2278747 - & Up	-	-	-	18-3940	-	-	8
	330	GM			4		4623115 - & Up	-	18-4189	-	18-3940	-	-	8
	330 W/B.W.	GM			4		6083145 - & Up	-	18-4189	-	18-3940	-	-	8
5.7L	350 MAG ALPHA		350	8	4	1986-1997	A635178 - K999999	18-4173	18-4188	18-4164	18-3937	18-3939	18-3938	8
5.7L	350 MAG ALPHA EFI GEN +		350	8	4	1996-1997	F800300 - K999999	-	-	-	-	-	-	8
5.7L	350 MAG BRAVO MPI		350	8	4	1995	F415189 - F601999	18-4173	-	18-4164	-	-	-	8
5.7L	350 MAG BRAVO MPI GEN +		350	8	4	1996-1997	F602000 - K999999	-	-	-	-	-	-	8
5.7L	350 MAG SKI		350	8	4	1994-1996	F215561 - F820706	18-4173	-	18-4164	-	-	-	8
5.7L	350 MAG EFI SKI GEN +		350	8	4	1996-1997	F820707 - K999999	-	-	-	-	-	-	8
5.7L	350 MAG MPI GEN +		350	8	4	1998-2010	L010019 & UP	-	-	-	-	-	-	8
5.7L	350 MAG MPI / 350 MAG HORIZON		350	8	4	2002-2007	M300000 - A299999	-	-	-	-	-	-	8
5.7L	350 MAG MPI / 350 MAG HORIZON / 350 MAG MIE		350	8	4	1998-2007	L304700 - A899999	-	-	-	-	-	-	8
5.7L	350 MAG / 350 MAG MIE / 350 MAG MPI GEN +		350	8	4	1998-2007	L002008 - A089999	-	-	-	-	-	-	8
5.7L	350 MAG MPI SKI		350	8	4	1995-1996	F350583 - F799999	18-4173	-	18-4164	-	-	-	8
5.7L	350 MAG MPI SKI GEN +		350	8	4	1998-2007	L002600 - A089999	-	-	-	-	-	-	8
5.7L	350 MAG SKI		350	8	4	1991-1997	D505450 - K999999	18-4173	18-4188	18-4164	18-3937	18-3939	18-3938	8
5.7L	350	GM	350	8	4		3780450 - & Up	-	-	-	18-3940	-	-	8
5.7L	350 MAG	GM	350	8	4		B525982 - & Up	18-4173	18-4188	18-4164	18-3937	18-3939	18-3938	8
5.7L	5.7L		350	8	4	1988-1995	B773305 - F600999	18-4173	-	18-4164	-	-	-	8
5.7L	5.7L	2bbl	350	8	4	1996-1997	F601000 - K999999	18-4173	-	18-4164	-	-	-	8
5.7L	5.7L GEN +		350	8	4	1998-2010	L010037 & UP	-	-	-	-	-	-	8
5.7L	5.7L EFI		350	8	4	1995-1997	F225560 - K999999	18-4173	-	18-4164	-	-	-	8
5.7L	5.7L EFI GEN +		350	8	4	1998-2001	L010035 - M299999	-	-	-	-	-	-	8
5.7L	5.7L EFI MIE GEN +		350	8	4	1997	K040300 - K999999	-	-	-	-	-	-	8
5.7L	5.7L MIE		350	8	4	1988-1997	B788152 - K999999	18-4173	-	18-4164	-	-	-	8
5.7L	5.7L MIE GEN +		350	8	4	1998-2010	L002003 & UP	-	-	-	-	-	-	8
5.7L	5.7L MPI / 5.7L HORIZON / 5.7L MIE		350	8	4	2008-2010	A090000 & UP	-	-	-	-	-	-	8
5.7L	5.7L MPI / 5.7L MIE		350	8	4	2008-2010	A090000 & UP	-	-	-	-	-	-	8
5.7L	5.7L MPI / 5.7L SKI		350	8	4	2008-2010	A090000 & UP	-	-	-	-	-	-	8
5.7L	5.7L SKI		350	8	4	1985-1997	A338553 - K999999	18-4173	-	18-4164	-	-	-	8
5.7L	5.7L SKI GEN +		350	8	4	1998-2010	L002005 & UP	-	-	-	-	-	-	8
5.7L	5.7LX		350	8	4	1996-1997	F601000 - K999999	18-4173	-	18-4164	-	-	-	8
5.7L	5.7LX BRAVO EFI GEN +		350	8	4	1996-1997	F800300 - K999999	-	-	-	-	-	-	8
5.7L	5.7LX EFI		350	8	4	1996-1997	F752400 - K999999	18-4173	-	18-4164	-	-	-	8
5.7L	BLACK SCORPION SKI GEN +		350	8	4	1998-2007	F800000 - W6988432	-	-	-	-	-	-	8
5.7L	SCORPION 350		350	8	4	2008-2010	W698432 & UP	-	-	-	-	-	-	8
5.8L	233	FORD	351	8	4	1975-1977	4173000 - 4902304	-	-	-	-	-	-	8

- | | | |
|--|---|---|
| (1) Cast Aluminum (Use with GM Engine Code 1XW)
(2) Cast aluminum (Use with GM Engine Code 4XW)
(3) Forged Aluminum (Use with GM Engine Code 3UB)
(4) Cast Aluminum (Use with GM Engine Code 4XX) | (5) Cast Aluminum (Use with GM Engine Code 2XY)
(6) Cast Aluminum (Use with GM Engine Code 4XY)
(7) Flat Head
(8) Forged Aluminum, Recessed Head | (9) Starboard
(10) Port
(11) .010 (25mm)Oversize
N.L.A. No longer available from O.E. source |
|--|---|---|

PISTON/RING APPLICATION

Liter	Model	Note	CID	# Cyl	Stroke	Year	Serial #	Pistons Std.	0.02	0.03	Rings Std.	0.02	0.03	Qty. Eng.
5.8L	255	FORD	351	8	4	1973-1974	3258728 - 4175499	-	-	-	-	-	-	8
6.2L	377 MAG		377	8	4	2008-2009	A000000 - A345479	-	-	-	-	-	-	8
6.2L	377 MAG		377	8	4	2009	A345480 - A345492	-	-	-	-	-	-	8
6.2L	377 MAG		377	8	4	2009	A345493 - A345765	-	-	-	-	-	-	8
6.2L	377 MAG		377	8	4	2009	A345766 - A345767	-	-	-	-	-	-	8
6.2L	377 MAG		377	8	4	2009	A345768 - A346789	-	-	-	-	-	-	8
6.2L	377 MAG		377	8	4	2009-2010	A346790 & UP	-	-	-	-	-	-	8
6.2L	377 SCORPION STERNDRIIVE		377	8	4	2000-2010	L416146 & UP	-	-	-	-	-	-	8
6.2L	377 SCORPION SKI		377	8	4	1997-1998	K000656 - L600314	-	-	-	-	-	-	8
6.2L	MX 6.2L MPI		377	8	4	2000-2007	L680003 - A299999	-	-	-	-	-	-	8
6.2L	MX 6.2L MPI / MX 6.2L MIE		377	8	4	2002-2009	M300000 - A091825	-	-	-	-	-	-	8
6.2L	MX 6.2L MPI / MX 6.2L MIE		377	8	4	2009-2010	A091826 & UP	-	-	-	-	-	-	8
6.2L	MX 6.2L MPI / MX 6.2L SKI		377	8	4	2002-2007	M317000 - W689999	-	-	-	-	-	-	8
6.2L	MX 6.2L BLACK SCORPION SKI		377	8	4	2001-2007	L670015 - W698432	-	-	-	-	-	-	8
6.2L	SCORPION 377		377	8	4	2008-2009	W698826 & UP	-	-	-	-	-	-	8
6.2L	SCORPION 377 HO / SCORPION 377 EC		377	8	4	2009-2010	A091488 - A092170	-	-	-	-	-	-	8
7.4L	325 MCM / 325 MIE		454	8	4	1969-1972	2278747 - 3780449	-	-	-	-	-	-	8
7.4L	330		454	8	4	1977-1987	4623115 - B816540	-	-	-	-	-	-	8
7.4L	330 MIE		454	8	4	1977-1980	4623115 - 5779913	-	-	-	-	-	-	8
7.4L	340 MIE		454	8	4	1981-1987	5889914 - B788365	-	18-4189	-	18-3940	-	-	8
7.4L	350 MIE		454	8	4	1974-1976	3780450 - 4623109	-	-	-	-	-	-	8
7.4L	370 TRS		454	8	4	1978-1987	4179554 - B714586	-	-	-	18-3940	-	-	8
	390	GM	454	8	4		2781129 - 2825059	-	-	-	18-3940	-	-	8
7.4L	400 TRS		454	8	4	1980-1986	4179554 - B457644	-	-	-	18-3940	-	-	8
7.4L	420		454	8	4	1987-1989	A398941 - B6222418	-	-	-	18-3940	-	-	8
7.4L	425		454	8	4	1990-1992	B622419 - D725499	-	-	-	18-3940	-	-	8
7.4L	425 GEN V		454	8	4	1992-1993	D725500 - D937011	-	-	-	-	-	-	8
7.4L	440 TRS		454	8	4	1983-1986	4179554 - B485220	-	-	-	18-3940	-	-	8
7.4L	450 GEN V		454	8	4	1995-1996	F347100 - F347277	-	-	-	-	-	-	8
7.4L	454 MAG ALPHA		454	8	4	1986-1988	A631894 - B785148	-	18-4189	-	18-3940	-	-	8
7.4L	454 MAG BRAVO		454	8	4	1988-1992	D721206 - D805068	-	-	-	-	-	-	8
7.4L	454 MAG BRAVO GEN V		454	8	4	1992-1996	D805069 - F801699	-	-	-	-	-	-	8
7.4L	454 MAG BRAVO GEN VI		454	8	4	1996-1997	F801700 - K999999	-	-	-	-	-	-	8
7.4L	454 MAG EFI GEN V		454	8	4	1994-1996	F115700 - F802349	-	-	-	-	-	-	8
7.4L	454 MAG EFI SKI GEN V		454	8	4	1995-1996	F215800 - F820099	-	-	-	-	-	-	8
7.4L	454 MAG MPI GEN VI		454	8	4	1996-2001	F802350 - M0224999	-	-	-	-	-	-	8
7.4L	454 MAG MPI / 454 MAG HORIZON / 454 MAG MIE		454	8	4	1998-2001	L002200 - L674000	-	-	-	-	-	-	8
7.4L	454 MAG MPI SKI GEN VI		454	8	4	1996-1997	F820100 - K999999	-	-	-	-	-	-	8
7.4L	454 MAG BRAVO		454	8	4		B840126 - & Up	-	-	-	18-3940	-	-	8
	470		454	8	4		4208730 - & Up	18-4109	18-4118	18-4134	18-3928	18-3929	-	4
	485		454	8	4		5685394 - & Up	18-4109	18-4118	18-4134	18-3928	18-3929	-	4
	488		454	8	4		6170297 - & Up	18-4109	18-4118	18-4134	18-3928	18-3929	-	4
	525 SC		454	8	4	1991-1992	D456000 - D725808	-	-	-	-	-	-	8
7.4L	525 SC GEN V		454	8	4	1992-1996	D763746 - F348963	-	-	-	-	-	-	8
7.4L	525 SC GEN V		454	8	4	1996-1999	F615814 - L415623	-	-	-	-	-	-	8
7.4L	7.4L BRAVO		454	8	4	1988-1991	B771113 - D603117	-	-	-	-	-	-	8
7.4L	7.4L BRAVO I GEN V / 7.4L BRAVO II GEN V		454	8	4	1992-1995	D603118 - F800699	(1)	-	-	-	-	-	8
7.4L	7.4L BRAVO I GEN V / 7.4L BRAVO II GEN V		454	8	4	1992-1996	D603118 - F800699	(2)	-	-	-	-	-	8
7.4L	7.4L BRAVO III GEN V		454	8	4	1992-1995	D603118 - F800699	(3)	-	-	-	-	-	8
7.4L	7.4L BRAVO III GEN V		454	8	4	1992-1996	D603118 - F800699	(4)	-	-	-	-	-	8
7.4L	7.4L BRAVO GEN VI		454	8	4	1996-1997	F800700 - K999999	-	-	-	-	-	-	8
7.4L	7.4L EFI GEN VI / 7.4L MIE GEN VI / 7.4L GEN VI MIE		454	8	4	1996-1997	F874815 - K999999	-	-	-	-	-	-	8
7.4L	7.4L MIE W/HURTH		454	8	4	1988-1992	B788366 - D715493	-	-	-	-	-	-	8
7.4L	7.4L W/HURTH		454	8	4		C391564 - & Up	-	18-4189	-	18-3940	-	-	8

(1) Cast Aluminum (Use with GM Engine Code 1XW)

(2) Cast aluminum (Use with GM Engine Code 4XW)

(3) Forged Aluminum (Use with GM Engine Code 3UB)

(4) Cast Aluminum (Use with GM Engine Code 4XX)

(5) Cast Aluminum (Use with GM Engine Code 2XY)

(6) Cast Aluminum (Use with GM Engine Code 4XY)

(7) Flat Head

(8) Forged Aluminum, Recessed Head

(9) Starboard

(10) Port

(11) .010 (25mm) Oversize

N.L.A. No longer available from O.E. source

PISTON/RING APPLICATION

Liter	Model	Note	CID	# Cyl	Stroke	Year	Serial #	Pistons Std.	0.02	0.03	Rings Std.	0.02	0.03	Qty. Eng.
7.4L	7.4L MIE GEN V		454	8	4	1992-1995	D715494 - F820141	- (5)	-	-	-	-	-	8
7.4L	7.4L MIE GEN V		454	8	4	1992-1996	D715494 - F820141	- (5)	-	-	-	-	-	8
7.4L	7.4L MIE GEN VI		454	8	4	1996-1997	F820142 - K999999	-	-	-	-	-	-	8
7.4L	7.4L MPI GEN VI		454	8	4	1998-2001	L010003 - M024330	-	-	-	-	-	-	8
7.4L	7.4L MPI GEN V / 7.4L MIE GEN V		454	8	4	1995-1996	F563052 - F820103	-	-	-	-	-	-	8
7.4L	7.4L MPI GEN VI / 7.4L MIE GEN VI / 7.4LH GEN VI		454	8	4	1996-1997	F820104 - K999999	-	-	-	-	-	-	8
7.4L	7.4L MPI L-29 GEN VI / 7.4L MIE L-29 GEN VI		454	8	4	1998-2001	L002006 - M025999	-	-	-	-	-	-	8
7.4L	7.4LX BRAVO GEN VI / 7.4L BRAVO EFI		454	8	4	1996-1997	F802000 - K999999	-	-	-	-	-	-	8
7.4L	7.4LX BRAVO GEN V / 7.4L MPI GEN V		454	8	4	1996	F602010 - F801999	-	-	-	-	-	-	8
7.4L	7.4LX BRAVO GEN VI / 7.4L MPI GEN VI		454	8	4	1996-1997	F802000 - K999999	-	-	-	-	-	-	8
7.9L	390		482	8	4	1969-1970	2781129 - 2825059	-	-	-	-	-	-	8
7.9L	460 TRS		482	8	4	1983-1986	4179554 - 6181046	-	-	-	-	-	-	8
8.1L	496		482	8	4	2001-2010	M025000 & UP	- (9)	-	-	-	-	-	8
8.1L	496		496	8	4	2001-2010	M025000 & UP	- (10)	-	-	-	-	-	8
8.2L	465		502	8	4	1990-1992	C849992 - D725646	-	-	-	-	-	-	8
8.2L	465 GEN V		502	8	4	1992-1994	D725647 - F213244	-	-	-	-	-	-	8
8.2L	500 GEN V		502	8	4	1994-1996	F213293 - F745159	-	-	-	-	-	-	8
8.2L	500 GEN VI		502	8	4	1997-1999	K745195 - L601036	-	-	-	-	-	-	8
8.2L	500 EFI		502	8	4	1999-2005	L001477 - M907127	-	-	-	-	-	-	8
8.2L	502 MAG BRAVO		502	8	4	1990-1992	C878221 - D824588	-	-	-	-	-	-	8
8.2L	502 MAG BRAVO GEN V		502	8	4	1992-1993	D824589 - F114528	-	-	-	-	-	-	8
8.2L	502 MAG EFI		502	8	4	1993-1996	D640650 - F802599	-	-	-	-	-	-	8
8.2L	502 MAG MPI GEN VI		502	8	4	1996-2001	F802600 - M024999	-	-	-	-	-	-	8
8.2L	525 EFI		502	8	4	2003-2010	M900146 & UP	-	-	-	-	-	-	8
8.2L	575 Sci		502	8	4	2001-2005	L306696 - M950526	-	-	-	-	-	-	8
8.2L	600 SC		502	8	4	1991-1992	D456489 - D456768	-	-	-	-	-	-	8
8.2L	600 SC GEN V		502	8	4	1992-1996	D725676 - F877642	-	-	-	-	-	-	8
8.2L	600 SC GEN VI		502	8	4	1997-2000	K000227 - L601186	-	-	-	-	-	-	8
8.2L	8.2L MAG EC		502	8	4	2010	A350340 & UP	-	-	-	-	-	-	8
8.2L	8.2L MIE / 8.2L EC		502	8	4	2010	A350802 & UP	-	-	-	-	-	-	8
8.2L	8.2L MIE W/HURTH		502	8	4	1990-1992	C878221 - D857199	-	-	-	-	-	-	8
8.2L	8.2L MIE GEN V		502	8	4	1993-1995	D857200 - F819619	-	-	-	-	-	-	8
8.2L	8.2L MPI GEN VI / 8.2L MIE GEN VI / 8.2LH GEN VI		502	8	4	1996-2001	F819620 - L674200	-	-	-	-	-	-	8
8.9L	500 BULLDOG		540	8	4	1990-2001	C577254 - M050281	-	-	-	-	-	-	8
8.9L	575		540	8	4	1986-1992	A677429 - D763716	- (7)	-	-	18-3937	18-3939	18-3938	8

- (1) Cast Aluminum (Use with GM Engine Code 1XW)
- (2) Cast aluminum (Use with GM Engine Code 4XW)
- (3) Forged Aluminum (Use with GM Engine Code 3UB)
- (4) Cast Aluminum (Use with GM Engine Code 4XX)

- (5) Cast Aluminum (Use with GM Engine Code 2XY)
- (6) Cast Aluminum (Use with GM Engine Code 4XY)
- (7) Flat Head
- (8) Forged Aluminum, Recessed Head

- (9) Starboard
- (10) Port
- (11) .010 (25mm)Oversize N.L.A. No longer available from O.E. source



ROD BEARINGS

(Sold individually, 1 per rod)

Part No.	Size	Replaces :
18-1148	Std.	68704A1, 23-853853, 23-853853A1, 23-853853002
18-1308	Std.	23-85701, 23-15961, 23-52221, 23-52270, F3910555, F3916351, F11100305, F11100570
18-1309	0.01	23-85704, 23-52224, 23-52273, 23-1596110, F11100381, F11100573
18-1327	Std.	23-11992, 23-11992001
18-1329	Std.	23-85677, 23-52242, 23-48351
18-1333	0.01	23-85691, 23-69887, 23-49171
18-1334	Std.	23-85726, 23-85726001, 23-49168, 23-69884, F11100980
18-1337	0.01	23-811858, 23-811858001
18-1341	0.02	23-85705, 23-1596120, 23-52225, 23-52274, F11100382

MAIN BEARINGS

Part No.	Per Eng.	Size	Replaces:
18-1131	4	0.010	74313A4
18-1137 ①	1	0.020	15103-A3
18-1300	①	Std.	23-818465, 23-85698, 23-52211, 23-15960, F724073
18-1311	①	Std.	23-801793
18-1316	①	0.010	23-818471, 23-818471001, 23-52264, 23-85718, F3829064, F11100853
18-1317	①	Std.	23-818469, 23-818469001, 23-34464, 23-85669, 23-85715, 23-52261,
18-1320	①	0.010	23-801803

CAM BEARINGS

Part No.	Per Eng.	Replaces:
18-1305	1 ①	23-85684
18-1339	1 ①	23-43293, 23-43293T, F3750884, F11101007
18-1340	5 ①	23-67484



① Complete engine set
② Priced per piece. Add -9 to order priced per package.

BEARING APPLICATION

HP	Liter	Model	Note	CID	# Cyl	Stroke	Year	Serial #	Rod Bearing			Main Bearing			
									Std.	0.01	0.02	Std.	0.01	0.02	Cam Bearing
100		100 VASER		98	4	4	2007-2010	W995000 & UP	-	-	-	-	-	-	-
120		120		153	4	4	1964-1986	1666601 - B531853	18-1329	-	-	-	-	-	-
120	2.5L	120/2.5L		153	4	4	1987-1989	B531854 - C853255	18-1329	18-1330	-	18-1317	18-1316	-	18-1339
140		140		181	4	4	1968-1986	2508261 - B450800	18-1308	18-1309	18-1341	18-1317	18-1316	-	18-1331
140		140		181	4	4		3462608 - 5157668	18-1308	18-1309	18-1341	18-1317	18-1316	-	18-1339
140		140		181	4	4		5157669 - 6229717	18-1308	18-1309	18-1341	18-1317	18-1316	-	18-1339
140	3.0L	140 / 3.0L		181	4	4		6229718 & Up	18-1308	18-1309	18-1341	18-1317	18-1316	-	18-1339
	3.0L	3.0L		181	4	4	1987-1989	B450801 - C856558	18-1308	-	-	-	-	-	-
	3.0L	3.0L		181	4	4	1990-1994	C856559 - F603999	18-1308	18-1309	18-1341	18-1317	18-1316	-	18-1339
	3.0L	3.0L		181	4	4	1998-1999	L010042 - L605541	18-1308	-	-	-	-	-	-
	3.0L	3.0L		181	4	4	2000-2010	L605542 & UP	-	-	-	-	-	-	-
	3.0L	3.0L MPI		181	4	4	2008-2010	A07282 & UP	-	-	-	-	-	-	-
	3.0L	3.0LX		181	4	4	1990-1997	C856559 - K999999	18-1308	-	18-1341	-	-	-	-
		165		224	4	4	1987	B434941 - B774251	-	-	-	-	-	-	-
		170		224	4	4	1985-1986	6916779 - B434940	-	-	-	-	-	-	-
		180		224	4	4	1987	B436391 - B775248	-	-	-	-	-	-	-
		190		224	4	4	1985-1986	6916779 - B436390	-	-	-	-	-	-	-
	3.7L	3.7L		224	4	4	1988-1989	B774252 - C762299	-	-	-	-	-	-	-
	3.7L	3.7LX		224	4	4	1988-1989	B775249 - C762299	-	-	-	-	-	-	-
		470		224	4	4	1976-1984	4208730 - 6916778	-	-	-	-	-	-	-
		485		224	4	4	1980-1982	5685394 - 6218036	-	-	-	-	-	-	-
		488		224	4	4	1983-1984	6170297 - 6916778	-	-	-	-	-	-	-
		140			6	4		1538930 - 1725960	18-1329	18-1330	-	-	-	-	-
		150				4		1666495 - 2048046	18-1329	18-1330	-	-	-	-	-
		160		250	6	4	1967-1969	2048022 - 2770031	18-1329	18-1330	-	-	18-1320	-	-
		165		250	6	4	1970-1981	2770032 - 5813433	18-1329	18-1330	-	-	18-1320	-	-
4.3L		175 / 4.3L		262	6	4		B527955 & Up	18-1327	18-1337	18-1338	18-1311	-	-	-
		185	4bbl	229	6	4	1983-1984	6330183 - 6919655	-	-	-	-	-	-	-
		175		262	6	4	1987	B527955 - B773242	-	-	-	-	-	-	-
		185	2bbl	262	6	4	1985-1986	A331455 - B527954	-	-	-	-	-	-	-
		205		262	6	4	1985-1986	A331455 - B527954	-	-	-	18-1300	-	-	-
4.3L		262 MAG / 262 EFI / 262 GEN +		262	6	4	1996-1997	F803800 - K999999	-	-	-	-	-	-	-
4.3L		4.3L GEN II		262	6	4	1992-1996	D714107 - F802999	18-1327	18-1337	18-1338	18-1311	-	-	-
4.3L		4.3L GEN +		262	6	4	1998-2010	L010044 & UP	-	-	-	-	-	-	-
4.3L		4.3L EFI / 4.3L GEN +		262	6	4	1998-2001	L012009 - M299999	-	-	-	-	-	-	-
4.3L		4.3L MPI		262	6	4	2002-2010	M3000000 & UP	-	-	-	-	-	-	-
4.3L		4.3LH GEN +		262	6	4	1998-2002	L010044 - M614999	-	-	-	-	-	-	-
4.3L		4.3LX		262	6	4	1988-1991	B775130 - D714369	-	-	-	-	-	-	-
4.3L		4.3LX GEN II		262	6	4	1992-1996	D714370 - F802999	-	-	-	-	-	-	-
4.3L		4.3LX GEN +		262	6	4	1996-1997	F803000 - K999999	-	-	-	-	-	-	-
4.3L		4.3LXH GEN +		262	6	4	1996-1997	F803114 - K999999	-	-	-	-	-	-	-
		185		262	6	4		A331455 & Up	18-1327	18-1337	18-1338	18-1311	-	-	-
		205		262	6	4		A331455 & Up	18-1327	18-1337	18-1338	18-1311	-	-	-
4.3L		205 / 4.3L / 4.3LX LX		262	6	4		B527955 & Up	18-1327	18-1337	18-1338	18-1311	-	-	-
		4.3LX GEN II		262	6	4		D714370 & Up	18-1327	18-1337	18-1338	18-1311	-	-	-
		190	GM	283	8	4	1963-1964	1564539 - 1730903	18-1329	18-1330	-	-	-	-	-
		200						2453769 - 2712072	18-1308	18-1309	18-1341	18-1317	18-1316	-	-
		200	GM			4		6218462 & Up	18-1308	18-1309	18-1341	18-1300	-	-	-
5.0L		500			8	4		B525982 & Up	18-1308	18-1309	18-1341	18-1300	-	-	-
5.0L		215	FORD	302	8	4		2781153 - 3395720	18-1336	-	-	-	-	-	-
5.0L		225	FORD	302	8	4	1973-1974	3385721 - 4166999	18-1329	18-1330	-	-	-	-	-
5.0L		225 S	FORD	302	8	4	1973-1974	3385721 - 4166999	-	-	-	-	-	-	-
5.0L		225	GM		8	4		1536920 - 2278646	18-1329	18-1330	-	-	-	-	-
5.0L		225	GM		8	4		2278647 - 2399397	18-1329	18-1330	-	18-1317	18-1316	-	-
5.0L		225	GM		8	4		2399398 & Up	18-1308	18-1309	18-1341	18-1300	-	-	-
5.0L		225	GM		8	4		4765100 & Up	18-1308	18-1309	18-1341	18-1300	-	-	-

CHART CONTINUED ON NEXT PAGE

BEARING APPLICATION

HP	Liter	Model	Note	CID	# Cyl	Stroke	Year	Serial #	Rod Bearing			Main Bearing			
									Std.	0.01	0.02	Std.	0.01	0.02	Cam Bearing
	5.0L	888		302	8	4	1971-1977	3108723 - 4887829	-	-	-	-	-	-	-
		190		283	8	4	1963-1964	1564539 - 1730903	18-1329	-	-	-	-	-	-
	5.0L	198 MIE		305	8	4	1977	4776402 - 4931099	18-1308	-	-	-	-	-	-
	5.0L	200		305	8	4	1985-1987	6899058 - B774444	18-1308	-	-	-	-	-	-
	5.0L	228		305	8	4	1977-1984	4765100 - 6899268	18-1308	-	-	-	-	-	-
	5.0L	228 MIE		305	8	4	1977-1980	4765100 - 5907057	18-1308	-	-	-	-	-	-
	5.0L	230		305	8	4	1985-1987	6899269 - B773739	18-1308	-	-	-	-	-	-
	5.0L	230	GM	305	8	4	1981-1987	5907058 - B788151	18-1308	18-1309	18-1341	18-1300	-	-	-
	5.0L	5.0L		305	8	4	1988-1995	B774445 - F600999	18-1308	-	-	-	-	-	-
	5.0L	5.0L GEN +		305	8	4	1998-2010	L015751 & UP	18-1308	-	-	-	-	-	-
	5.0L	5.0L EFI GEN +		305	8	4	1998-2001	L012052 - M299999	18-1308	-	-	-	-	-	-
	5.0L	5.0L MIE		305	8	4	1988	B788152 - C396832	18-1308	-	-	-	-	-	-
	5.0L	5.0L MPI		305	8	4	2002-2010	M3000000 & UP	18-1308	-	-	-	-	-	-
	5.0L	5.0LX		305	8	4	1988-1995	B773740 - F600999	18-1308	-	-	-	-	-	-
	5.0L	230 / 5.0L	GM	305	8	4		B522506 & Up	18-1308	18-1309	18-1341	18-1300	-	-	-
		230	GM		8	4		6218462 & Up	18-1308	18-1309	18-1341	18-1300	-	-	-
	5.0L	230 / 5.0L / 5.0LX	GM	305	8	4		B525982 & Up	18-1308	18-1309	18-1341	18-1300	-	-	-
	5.0L	898		305	8	4	1977-1984	4762210 - 6899057	18-1308	-	-	-	-	-	-
		225	GM	327	8	4	1963-1967	1539620 - 2399397	18-1329	-	-	-	-	-	-
		225	GM	327	8	4	1968-1969	2399398 - 2694014	18-1308	-	-	-	-	-	-
		250		327	8	4	1968-1969	2314301 - 2639854	18-1308	18-1309	18-1341	18-1300	-	-	-
	5.7L	250		350	8	4	1977	4768000 - 4908849	18-1308	18-1309	18-1341	18-1300	-	-	-
	5.7L	255	GM	350	8	4	1975-1976	4175500 - 4767999	18-1308	18-1309	18-1341	18-1300	-	-	-
	5.7L	255 MIE		350	8	4	1975-1980	4175500 - 5907057	18-1308	-	-	-	-	-	-
	5.7L	260	GM	350	8	4	1978-1987	4908850 - B773304	18-1308	18-1309	18-1341	18-1300	-	-	-
	5.7L	260 MIE		350	8	4	1981-1987	5907058 - B788151	18-1308	18-1309	18-1341	-	-	-	-
	5.7L	260 / 5.7L	GM	350	8	4		B525982 & Up	18-1308	18-1309	18-1341	18-1300	-	-	-
	5.7L	260 / 5.7L	GM	350	8	4		B522506 & Up	18-1308	18-1309	18-1341	18-1300	-	-	-
	5.7L	270	GM	350	8	4	1969-1972	2851074 - 3077735	18-1308	18-1309	18-1341	18-1300	-	-	-
	5.7L	280	GM	350	8	4	1975-1976	4176250 - 4770199	18-1308	18-1309	18-1341	18-1300	-	-	-
	5.7L	300	GM	350	8	4	1985-1986	6668677 - B430367	18-1308	18-1309	18-1341	18-1300	-	-	-
	5.7L	320 EFI	GM	350	8	4	1987-1989	A543604 - C622418	18-1308	18-1309	18-1341	18-1300	-	-	-
	5.7L	320 EFI BRAVO	GM	350	8	4		B157603 & Up	18-1308	18-1309	18-1341	18-1300	-	-	-
		325 GM			8	4		2278747 & Up	18-1334	18-1333	18-1332	-	-	-	-
		330 GM			8	4		4623115 & Up	18-1334	18-1333	18-1332	-	-	-	-
		330 W.B.W.	GM		8	4		6083045 & Up	18-1334	18-1333	18-1332	-	-	-	-
	7.4L	340 / 7.4L	GM		8	4		5889914 & Up	18-1334	18-1333	18-1332	-	-	-	-
	5.7L	350 MAG ALPHA		350	8	4	1986-1997	A635178 - K999999	18-1308	18-1309	18-1341	18-1300	-	-	-
	5.7L	350	GM	350	8	4		3780450 & Up	18-1334	18-1333	18-1332	-	-	-	-
	5.7L	350 MAG / 350 ALPHA / 350 EFI / 350 GEN +		350	8	4	1996-1997	F800300 - K999999	18-1308	-	-	-	-	-	-
	5.7L	350 MAG / 350 BRAVO / 350 MPI		350	8	4	1995	F415189 - F601999	18-1308	-	-	-	-	-	-
	5.7L	350 MAG / 350 BRAVO / 350MPI / 350 GEN +		350	8	4	1996-1997	F602000 - K999999	18-1308	-	-	-	-	-	-
	5.7L	350 MAG SKI		350	8	4	1994-1996	F215561 - F820706	18-1308	-	-	-	-	-	-
	5.7L	350 MAG EFI SKI GEN +		350	8	4	1996-1997	F820707 - K999999	18-1308	-	-	-	-	-	-
	5.7L	350 MAG MPI GEN +		350	8	4	1988-2010	L010019 & UP	18-1308	-	-	-	-	-	-
	5.7L	350 MAG MPI / 350 MAG MIE GEN +		350	8	4	1998-2007	L002008 - A089999	18-1308	-	-	-	-	-	-
	5.7L	350MG / 350 MPI / 350 SKI		350	8	4	1995-1996	F350583 - F799999	18-1308	-	-	-	-	-	-
	5.7L	350 MAG / 350 MPI / 350 SKI / 350 GEN +		350	8	4	1998-2007	L002600 - A089999	18-1308	-	-	-	-	-	-
	5.7L	350 MAG SKI		350	8	4	1991-1997	D505450 - K999999	18-1308	-	-	-	-	-	-
	5.7L	5.7L		350	8	4	1988-1997	4908850 - F600999	18-1308	-	-	-	-	-	-
	5.7L	5.7L GEN +		350	8	4	1998-2010	L010037 & UP	18-1308	-	-	-	-	-	-
	5.7L	5.7L EFI		350	8	4	1995-1997	F225560 - K999999	18-1308	-	-	-	-	-	-
	5.7L	5.7L EFI GEN +		350	8	4	1998-2001	L010035 - M2999999	18-1308	-	-	-	-	-	-

CHART CONTINUED ON NEXT PAGE

BEARING APPLICATION

HP	Liter	Model	Note	CID	# Cyl	Stroke	Year	Serial #	Rod Bearing			Main Bearing				
									Std.	0.01	0.02	Std.	0.01	0.02	Cam Bearing	
	5.7L	5.7L EFI MIE GEN +		350	8	8	1997	K040300 - K999999	18-1308	-	-	-	-	-	-	-
	5.7L	5.7L MIE		350	8	4	1988-1997	B788152 - K999999	18-1308	-	-	-	-	-	-	-
	5.7L	5.7L MIE GEN +		350	8	4	1998-2010	L002003 & UP	18-1308	-	-	-	-	-	-	-
	5.7L	5.7L MPI / 5.7L MIE		350	8	4	2008-2010	A090000 & UP	18-1308	-	-	-	-	-	-	-
	5.7L	5.7L MPI SKI		350	8	4	2008-2010	A090000 & UP	18-1308	-	-	-	-	-	-	-
	5.7L	5.7L SKI		350	8	4	1985-1987	A338553 - K999999	18-1308	-	-	-	-	-	-	-
	5.7L	5.7L SKI GEN +		350	8	4	1998-2010	L002005 & UP	18-1308	-	-	-	-	-	-	-
	5.7L	5.7LX		350	8	4	1996-1997	F601000 - F600999	18-1308	-	-	-	-	-	-	-
	5.7L	5.7LX / 5.7LX BRAVO / 5.7LX EFI / 5.7LX GEN +		350	8	4	1996-1997	F800300 - K999999	18-1308	-	-	-	-	-	-	-
	5.7L	5.7L EFI		350	8	4	1996-1997	F752400 - K999999	18-1308	-	-	-	-	-	-	-
	5.7L	BLACK SCORPION SKI GEN +		350	8	4	1996-2006	F800000- W689999	18-1308	-	-	-	-	-	-	-
	5.7L	BLACK SCORPION SKI GEN +		350	8	4	2003-2007	W690000 - W698432	①	①	-	-	-	-	-	-
	5.7L	SCORPION 350		350	8	4	2008-2010	W698433 & UP	①	①	-	-	-	-	-	-
		233		351	8	4	1975-1977	4173000 - 4902304	-	-	-	-	-	-	-	-
		255	FORD	351	8	4	1973-1974	3258728 - 4175499	-	-	-	-	-	-	-	-
		TOURNEY SKI			8	4		D505450 & Up	18-1308	18-1309	18-1341	18-1300	-	-	-	-
		370 TRS	GM		8	4		6721528 & Up	18-1334	18-1333	18-1332	-	-	-	-	-
		377 MAG		377	8	4	2008-2010	A3000000 & UP	①	①	-	-	-	-	-	-
		377 SCORPION MCM		377	8	4	1999-2005	L416145 - M907201	①	①	-	-	-	-	-	-
		377 SCORPION SKI GEN +		377	8	4	1997-1998	K000656 - L600314	①	①	-	-	-	-	-	-
	6.2L	MX 6.2L MPI		377	8	4	2000-2007	L680003 - A299999	①	①	-	-	-	-	-	-
	6.2L	MX 6.2L MPI / MX 6.2L HORIZON		377	8	4	2002-2007	M3000000 - A299999	①	①	-	-	-	-	-	-
	6.2L	MX 6.2L MPI / MX 6.2L HORIZON / MX 6.2L MIE		377	8	4	2002-2010	M3000000 & UP	①	①	-	-	-	-	-	-
	6.2L	MX 6.2L MPI / MX 6.2L MIE		377	8	4	2002-2010	M3000000 & UP	①	①	-	-	-	-	-	-
	6.2L	MX 6.2L BLACK SCORPION SKI		377	8	4	2002-2007	M3000000 - W698432	①	①	-	-	-	-	-	-
	6.2L	SCORPION 377		377	8	4	2008-2010	W698433 & UP	①	①	-	-	-	-	-	-
	7.4L	325		454	8	4	1969-1972	2278747 - 3780449	-	-	-	-	-	-	-	-
	7.4L	330		454	8	4	1977-1987	4623115 - B816540	-	-	-	-	-	-	-	-
	7.4L	330 MIE		454	8	4	1977-1980	4623115 - 5889913	-	-	-	-	-	-	-	-
	7.4L	340 MIE WB-W		454	8	4	1981-1987	5889914 - B788365	-	-	-	-	-	-	-	-
	7.4L	350 MIE		454	8	4	1974-1976	3780450 - 4623109	-	-	-	-	-	-	-	-
	7.4L	370 TRS		454	8	4	1978-1987	4179554 - B714586	-	-	-	-	-	-	-	-
		390	GM		8	4		2781129 - 2825059	18-1334	18-1333	18-1332	-	-	-	-	-
	7.4L	400 TRS		454	8	4	1980-1986	4179554 - B457644	-	-	-	-	-	-	-	-
	7.4L	420	GM	454	8	4	1987-1989	A398941 - B622418	18-1334	18-1333	18-1332	-	-	-	-	-
	7.4L	425	GM	454	8	4	1990-1992	B622419 - D725499	-	-	-	-	-	-	-	-
	7.4L	425 GEN V		454	8	4	1992-1993	D725500 - D937011	-	-	-	-	-	-	-	-
	7.4L	440 TRS		454	8	4	1983-1986	4179554 - B485220	-	-	-	-	-	-	-	-
	7.4L	450 GEN V		454	8	4	1995-1996	F347100 - F347277	-	-	-	-	-	-	-	-
	7.4L	454 MAG ALPHA	GM	454	8	4	1986-1988	A631894 - B785148	18-1334	18-1333	18-1332	-	-	-	-	-
	7.4L	454 MAG BRAVO		454	8	4	1988-1992	B721206 - D805068	-	-	-	-	-	-	-	-
	7.4L	454 MAG BRAVO	GM	454	8	4		B840126 & UP	18-1334	18-1333	18-1332	-	-	-	-	-
	7.4L	454 MAG BRAVO GEN V		454	8	4	1992-1996	D805069 - M801699	18-1334	18-1333	18-1332	-	-	-	-	-
	7.4L	454 MAG BRAVO GEN VI		454	8	4	1996-1997	F801700 - K999999	-	-	-	-	-	-	-	-
	7.4L	454 MAG EFI GEN V		454	8	4	1994-1996	F115700 - F802349	-	-	-	-	-	-	-	-
	7.4L	454 MAG EFI SKI GEN V		454	8	4	1995-1996	F215800 - F820099	-	-	-	-	-	-	-	-
	7.4L	454 MAG MPI GEN VI		454	8	4	1996-2001	F802350 - M024999	-	-	-	-	-	-	-	-
	7.4L	454 MAG MPI / 454 MAG HORIZON / 454 MAG MIE		454	8	4	1998-2001	L002200 - L674000	-	-	-	-	-	-	-	-
	7.4L	454 MAG MPI / 454 MAG SKI GEN VI		454	8	4	1996-1997	F820100 - K999999	-	-	-	-	-	-	-	-
	7.4L	454 EFI		454	8	4		F115700 & UP	18-1334	18-1333	18-1332	-	-	-	-	-
		502 MAG	GM		8	4		C878221 & Up	18-1334	18-1333	18-1332	-	-	-	-	-
		502 MAG BRAVO GEN V			8	4		D824589 & Up	18-1334	18-1333	18-1332	-	-	-	-	-
		502 MAG BRAVO GEN V			8	4		D840650 & Up	18-1334	18-1333	18-1332	-	-	-	-	-
		502 EFI			8	4		3108723 & Up	18-1336	-	-	-	-	-	-	-

① 8 Pair Bearing Set

CHART CONTINUED ON NEXT PAGE

BEARING APPLICATION

HP	Liter	Model	Note	CID	# Cyl	Stroke	Year	Serial #	Rod Bearing			Main Bearing			
									Std.	0.01	0.02	Std.	0.01	0.02	Cam Bearing
		525 SC		454	8	4	1991-1992	D456000 - D725808	-	-	-	-	-	-	-
		525 SC GEN V		454	8	4	1992-1996	D763746 - F745215	-	-	-	-	-	-	-
		525 SC GEN V		454	8	4	1996-1999	F745260 - L415623	-	-	-	-	-	-	-
7.4L	7.4L	7.4L BRAVO		454	8	4	1988-1991	B771113 - D603117	-	-	-	-	-	-	-
7.4L	7.4L	7.4L BRAVO GEN V		454	8	4	1992-1996	D603118 - F800699	-	-	-	-	-	-	-
7.4L	7.4L	7.4L BRAVO GEN VI		454	8	4	1996-1997	F800700 - K299999	-	-	-	-	-	-	-
7.4L	7.4L	7.4L EFI / 7.4L MIE GEN VI		454	8	4	1996-1997	F874815 - K999999	-	-	-	-	-	-	-
7.4L	7.4L	7.4L MIE		454	8	4	1988-1992	B788366 - D715493	-	-	-	-	-	-	-
7.4L	7.4L	7.4L MIE GEN V		454	8	4	1992-1996	D715494 - F820141	-	-	-	-	-	-	-
7.4L	7.4L	7.4L LH / 7.4L MIE GEN VI		454	8	4	1996-1997	F820142 - K999999	-	-	-	-	-	-	-
7.4L	7.4L	7.4L MPI GEN V		454	8	4	1998-2001	L010003 - M024330	-	-	-	-	-	-	-
7.4L	7.4L	7.4L MPI GEN V / 7.4L MIE GEN V		454	8	4	1995-1996	F563052 - F820103	-	-	-	-	-	-	-
7.4L	7.4L	7.4L MPI GEN VI / 7.4L MIE GEN VI		454	8	4	1996-1997	F820104 - K999999	-	-	-	-	-	-	-
7.4L	7.4L	7.4L MPI GEN VI L29 / 7.4L MIE GEN VI L29		454	8	4	1998-2001	L002006 - M025999	-	-	-	-	-	-	-
7.4L	7.4L	7.4LX BRAVO TBI GEN VI		454	8	4	1988-2001	F802000 - K999999	-	-	-	-	-	-	-
7.4L	7.4L	7.4LX BRAVO MPI GEN V		454	8	4	1996	F602010 - F801999	-	-	-	-	-	-	-
7.4L	7.4L	7.4LX BRAVO MPI GEN VI		454	8	4	1996-1997	F802000 - K999999	-	-	-	-	-	-	-
7.4L	7.4L	7.4L BRAVO	GM					D603118 & Up	18-1334	18-1333	18-1332	-	-	-	-
7.4L	7.4L	7.4L BRAVO GEN V						C391564 & Up	18-1334	18-1333	18-1332	-	-	-	-
7.4L	7.4L	7.4L W/HURTH						D715494 & Up	18-1334	18-1333	18-1332	-	-	-	-
7.4L	7.4L	7.4LHR GEN V						C878221 & Up	18-1334	18-1333	18-1332	-	-	-	-
		390		482	8	4	1969-1970	2781129 - 2825059	-	-	-	-	-	-	-
		460 TRS		482	8	4	1983-1986	4179554 - 6181046	①	①	-	-	-	-	-
		496 MAG / 496 HO		496	8	4	2001-2010	M025000 & UP	-	-	-	-	-	-	-
		8.1S MPI / 8.1S MIE / 8.1S HO		496	8	4	2001-2010	M025000 & UP	-	-	-	-	-	-	-
8.2L	465			502	8	4	1990-1992	C849992 - D725646	-	-	-	-	-	-	-
8.2L	465	GEN V		502	8	4	1992-1994	D725647 - F213244	-	-	-	-	-	-	-
8.2L	500	GEN V		502	8	4	1994-1996	F213293 - F745159	-	-	-	-	-	-	-
8.2L	500	GEN VI		502	8	4	1997-1999	K745195 - L601036	-	-	-	-	-	-	-
8.2L	500	EFI		502	8	4	1999-2000	L001477 - L306499	-	-	-	-	-	-	-
8.2L	500	EFI		502	8	4	2000-2005	L306500 - M907127	-	-	-	-	-	-	-
8.2L	502	MAG BRAVO		502	8	4	1990-1992	C876221 - D824588	-	-	-	-	-	-	-
8.2L	502	MAG BRAVO GEN V		502	8	4	1992-1993	D824589 - F114528	-	-	-	-	-	-	-
8.2L	502	MAG EFI		502	8	4	1993-1996	D840650 - F802599	-	-	-	-	-	-	-
8.2L	502	MAG MPI GEN VI		502	8	4	1996-2001	F802600 - M024999	-	-	-	-	-	-	-
8.2L	525	EFI		502	8	4	2003-2007	M900146 - M958499	-	-	-	-	-	-	-
8.2L	525	EFI		502	8	4	2007-2010	M958500 & UP	-	-	-	-	-	-	-
8.2L	575	SCi		502	8	4	2000-2005	L306696 - M950526	-	-	-	-	-	-	-
8.2L	600	SC		502	8	4	1991-1992	D456489 - D456768	-	-	-	-	-	-	-
8.2L	600	SC GEN V		502	8	4	1992-1996	D725676 - F877642	-	-	-	-	-	-	-
8.2L	600	SC GEN VI		502	8	4	1997-2000	K000227 - L601186	-	-	-	-	-	-	-
8.2L	8.2L	MAG		502	8	4	2010	A350340 & UP	-	-	-	-	-	-	-
8.2L	8.2L	MIE		502	8	4	2010	A350802 & UP	-	-	-	-	-	-	-
8.2L	8.2L	MIE W/HURTH		502	8	4	1990-1992	C878221 - D857199	-	-	-	-	-	-	-
8.2L	8.2L	W/HURTH (IB)		502	8	4		D857200 & Up	18-1334	18-1333	18-1332	-	-	-	-
8.2L	8.2L	MIE GEN V		502	8	4		D857200 - F819619	-	-	-	-	-	-	-
8.2L	8.2L	MPI GEN VI / 8.2L MIE GEN VI / 8.2LH GEN VI		502	8	4	1996-2001	F819620 - L674200	-	-	-	-	-	-	-
		500 BULLDOG		540	8	4	1990-1996	C577254 - F745405	①	①	-	-	-	-	-
		500 BULLDOG		540	8	4	1997-2001	K000248 - M050281	①	①	-	-	-	-	-
		575		540	8	4	1986-1992	A677429 - D763716	①	①	-	-	-	-	-
		800 SC GEN V		540	8	4	1993-1998	D763836 & UP	①	-	-	-	-	-	-
		888	FORD		8	4		4762210 & Up	18-1308	18-1309	18-1341	18-1300	-	-	-
		898 / 198	GM					A338553 & Up	18-1308	18-1309	18-1341	18-1300	-	-	-

① 8 Pair Bearing Set

MERCURISER 3.7L BEARING APPLICATION

Model	Serial #	Rod Bearings			Main Bearings			Main (Thrust Bearings)		
		Std.	.010	.020	Std.	.010	.020	Std.	.010	.020
165\3.7 (4cyl)	6916779 & Up	18-1148	-	-	-	-	-	18-1149	-	-
170 (4cyl)	6916779 & Up	18-1148	-	-	-	-	-	18-1149	-	-
180\3.7L (4cyl)	6916779 & Up	18-1148	-	-	-	-	-	18-1149	-	-
190 (4cyl)	6916779 & Up	18-1148	-	-	-	-	-	18-1149	-	-
470	4208730 & Up	18-1148	-	-	-	-	-	18-1149	-	-
485	5685394 & Up	18-1148	-	-	-	-	-	18-1149	-	-
488	6170297 & Up	18-1148	-	-	-	-	-	18-1149	-	-

 <p>18-0518 VALVE STEM SEAL Replaces: 26-34217, 26-72564, 26-58094, 26-75413, 26-75624</p>	 <p>18-4023 VALVE STEM SEAL Replaces: 26-75413, 26-75624, 26-72564, 26-58094 For: 165, 170, 180, 190 4 cyl. (224 CID) SN 6916779 & later</p>	 <p>18-4022 VALVE STEM SEAL Replaces: 26-75988, 26-75982, 26-67863, 26-49131, F3866612, F11100968, F11101117 For: 330 (SN 4623115 & later), 340 (IB) (SN 5889914 & later), 454 Mag (SN A631894 & later)</p>	 <p>18-4024 18-4024-9② VALVE STEM SEAL Replaces: 26-97664, 26-976641 26-8M0050563, F11101200</p>
 <p>ONE PIECE REAR MAIN SEALS 18-1234 Replaces: 24-811554, 24-17057A1, 24-801879, 24-801879T For: 7.4L, GL, GI, GSI: 8.2L, GL 18-0519 Replaces: 26-14240, F11101300 4.3L/3.0L/5.0L 5.7L 18-0864 Replaces: 26-90925, 27-67389</p>	 <p>TWO PIECE REAR MAIN SEALS 18-0528 Replaces: 26-56868 18-1211 Replaces: 26-58203, 26-49947, 26-814622, F1110026, F1110027, F1110041</p>	 <p>TIMING COVER SEALS 18-1213 Replaces: 26-97335, 26-11973, 26-42750, 26-54799 18-1230 Replaces: 26-56866 18-1233 Replaces: 26-8219471, 26-821947, 26-49154, F11100986 18-0578 Replaces: 26-67388</p>	

MERCURISER SEAL APPLICATION

Model	Serial No.	Rear Main Crankshaft Seal	Timing Cover Seal
120/2.5L	1666601 & UP	—	18-1213
120/2.5L	2786857 & UP	18-1211	18-1213
140/3.0L & LX	2508261 & UP	—	18-1213
140/3.0L & LX	6229718 & UP	18-1211	18-1213
150/160/165/200 (I/L-6)	1666495 & UP	—	18-1213
150/160/165/200 (I/L-6)	2770032 & UP	18-1211	18-1213
175/185/205/262/4.3L (V-6)	6330183 & UP	18-1211	18-1213
200/228/225/230/250/255/260/270/280/300/320/5.0L/5.7L/898 (V-8)	2453769 & UP	18-1211①	18-1213
215	2781153 & UP	18-0528	—
224I/L4	ALL	18-0864	18-0578
225 FORD	3885721 & UP	18-0528	—
5.0L/5.7L, 4.3L, 3.0L Std. Rotation	"All" one piece seal	18-0519	18-1213
340 (7.4L)	4623115 & UP	—	18-1233
370 TRS	5889914 & UP	—	18-1233
400 TRS	4179554 & UP	—	18-1233
420	A398941 & UP	—	18-1233
440 TRS	4179554 & UP	—	18-1233
454 MAGNUM	A631894 & UP	—	18-1233
460 TRS	4179554 & UP	—	18-1233
7.4L/8.2L/454/502 Std. Rotation	"All" one piece seal	18-1234	18-1233
7.4 BRAVO	B771113 & UP	—	18-1233
888 (188)	3108723 & UP	18-0528	—

① Lrg. Journal Crankshaft GM Engines ② Priced per Package

SIERRA OFFERS MORE!



PARTS THAT MOVE YOU:

Sierra offers an extensive selection of over 400 Rotating Electrical products, all backed by an industry leading warranty.

Protect your customer and your reputation. Use only a certified marine product from Sierra.

- **Alternators**
- **Starters**
- **Trim Motors**
- **Solenoids**
- **Rectifiers**
- **Accessories**

The Very Best Parts of Boating
www.sierramarine.com

sierra
Marine Engine and Drive Parts

MANIFOLD & EXHAUST MANIFOLD GASKET SETS



18-0403

INTAKE GASKET KIT

Replaces: 27-805722A1, 27-812712, 27-61782, 27-52571
 For: MCM 370, 400, 325, 454, 502 Mag, 7.4L Bravo II & MIE 8.2L1978-1997



18-0404

INTAKE GASKET KIT

Replaces: 27-805403A1
 For: MCM/MIE 454 Mag MPI, 7.4L/LX MPI & 8.2L MPI 1993-UP



18-0603

EXHAUST MANIFOLD GASKET SET

For: Ford 302/351 CID Engines
 For use with 18-1998-1

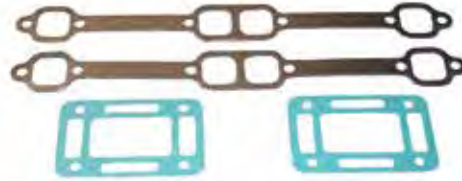

18-0604

EXHAUST MANIFOLD GASKET SET

For: GM 305/350 CID Engines
 For use with 18-1997-1



18-4347-1

EXHAUST MANIFOLD GASKET SET

For: GM 175, 185, 205 (229 & 262 CID)

— CONTAINS —

Part #	Description	O.E. #	Qty.
18-0897	Exhaust Elbow Mounting Gasket	27-41813-1	2
18-2909	Exhaust Manifold to Cyl. Head Gasket	27-99757	2



18-4348

EXHAUST MANIFOLD GASKET SET

For: GM 454, 525 (7.4L & 8.2L)

— CONTAINS —

Part #	Description	O.E. #	Qty.
18-0418	Manifold to Cylinder Head Gasket	27-46820	2
18-0897	Exhaust Elbow Mounting Gasket	27-41813-1	2



18-4408

INTAKE MANIFOLD GASKET SET

Replaces: 27-11977, 27-11987
 For: GM 262 CID Engines 175, 185 and 205 HP



18-4349

EXHAUST MANIFOLD GASKET SET

For: GM 200, 228, 230, 260, 898 (5.0 & 5.7L)

— CONTAINS —

Part #	Description	O.E. #	Qty.
18-2949	Exhaust Manifold Gasket	27-33395	2
18-0897	Exhaust Elbow Mounting Gasket	27-41813-1	2



18-4367

EXHAUST MANIFOLD GASKET SET

Replaces: 27-99777A1
 For: GM 153 & 181 (2.5 & 3.0L) CID Eng; 120 & 140 HP S/N 6229718 & UP
 (With Siamese Port Cylinder Heads)



18-4394

EXHAUST MANIFOLD GASKET SET

Replaces: 27-33395A2, 27-33395A1

For: GM 350 (5.7L) CID Eng; 250 HP S/N 4768000-4908849 255 HP S/N 5195909 & UP

— CONTAINS —

Part #	Description	O.E. #	Qty.
18-2832-1	Manifold End Cap Gasket	27-48043	4
18-2833	Exhaust Elbow Gasket	27-99777-2	4
18-2949	Exhaust Manifold Gasket	27-33395	2
18-0885-1	Exhaust Elbow Gasket	27-48042	4

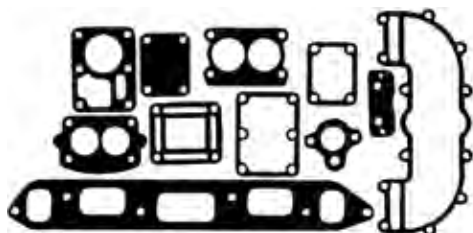

18-4395
EXHAUST MANIFOLD GASKET SET
Replaces: 27-35898A4, 27-35898A3, 27-35898A2
For: GM 153 (2.5L) CID Eng;
 120 HP S/N 2046625-6229717

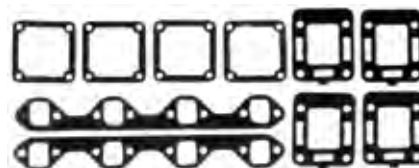

18-4399
EXHAUST MANIFOLD GASKET SET
Replaces: 27-54566A1
For: Ford 302/351 (5.0L & 5.8L) CID Eng; All 888 (188 HP)
 & 233 HP, 255 HP • S/N 3258728-4175498

— CONTAINS —

Part #	Description	O.E. #	Qty.
18-0183-1	Exhaust Mounting Gasket	27-46820	2
18-2832-1	Manifold End Cap Gasket	27-48043-1	4
18-2833	Exhaust Elbow to Gasket	27-99777-2	4

18-4396
EXHAUST MANIFOLD GASKET SET

Replaces: 27-46401A1
For: 250 (4.1L) CID Eng; 165 HP S/N 2770032 & UP

— CONTAINS —

Part #	Description	O.E. #	Qty.
18-2830-1	Intake Exhaust Gasket	27-46401	1
18-2831	Thermostat Gasket	27-47590-1	1
18-2832-1	Manifold End Cap Gasket	27-48083-1	2
18-2833	Exhaust Elbow Gasket	27-99777-2	1
18-0353	Carb. Mounting Gasket	27-58764	1
18-0356	Carb. Mounting Gasket	27-64692	1
18-0928-1	Exhaust End Cap Gasket	27-73814	1

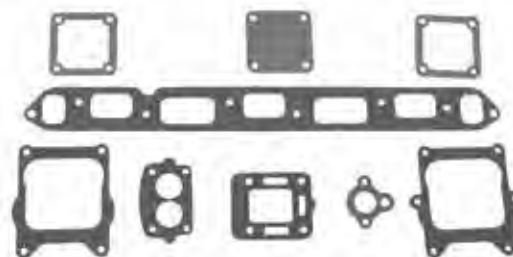

18-4397
EXHAUST MANIFOLD GASKET SET
Replaces: 27-46820A1
For: GM 454 (7.4L) CID Eng; All 325, 350, 400 HP Jet Drives 330 HP S/N 6083144 & BELOW

— CONTAINS —

Part #	Description	O.E. #	Qty.
18-0418	Exhaust Mounting Gasket	27-46820	2
18-0885-1	Exhaust Elbow Mounting Gasket	27-48042	4
18-2832-1	Manifold End Cap Gasket	27-48043-1	4

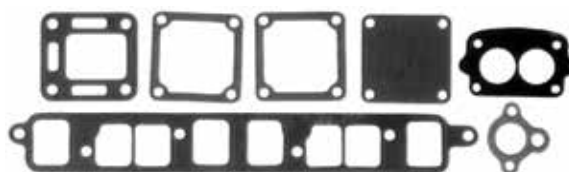

18-4398
EXHAUST MANIFOLD GASKET SET
Replaces: 27-53354A1
For: GM 181 (3.0L) CID Eng; 140 HP S/N 3332137-6229717
 (Without Siamese Port Cylinder)

CYLINDER HEAD AND INTAKE MANIFOLD GASKET SETS



18-4383
For: GM 153 (2.5L) CID Eng;
 S/N 2324347 & UP Includes 18-3880 Head Gasket



18-4384
For: GM 181 (3.0L) CID Eng;
 S/N 2508261-6229717 (Except 3.0LX)

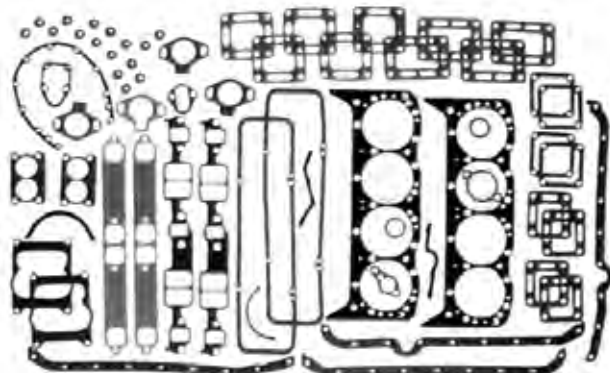

18-4386
For: GM 305 & 350 (5.0L & 5.7L) CID Eng; With Heads (1987 & Earlier)

— CONTAINS —

Part #	Description	O.E. #	Qty.
18-0976	Timing Chain Cover Gasket	27-14250	1
18-0868	Intake Manifold Gasket	27-17145	1
18-2949	Exhaust Manifold Gasket	27-33395	2
18-0897	Exhaust Elbow Mounting Gasket	27-41813	2
18-0885-1	Exhaust Elbow Mounting Gasket	27-48042	4
18-2917	Lower Thermostat Housing Gasket	27-53045-1	1
18-0153	Port Dip Gasket	27-85817A1	1
18-2848	Quadrajet Base Gasket	27-58457-2	2
18-2849-1	Exhaust Elbow To Manifold Gasket	27-81105-1, 27-818832	4
18-3876	Head Gasket	27-75611	2
18-2554	Thermostat Gasket	27-41812	1
18-2832-1	Manifold End Cap Gasket	27-48043-1	4
18-2553	Thermostat Gasket	27-47510	1
18-2833	Exhaust Elbow To Manifold Gasket	27-99777-2	4
18-2844	Thermostat Cover Gasket	27-48818-1	1
18-0889	Fuel Pump Housing Gasket	27-34213	1
18-0891	Water Pump Mounting Gasket	27-34897	1
18-0905	Oil Pan Drain Plug Gasket	27-49955	1
18-0876	Water Pump Mounting Gasket	27-34898	1
18-0994	Carb. Mounting Gasket	27-70143-1	2
18-0518	Seal	26-34217	16
18-2845	Valve Cover Gasket	121-122	2

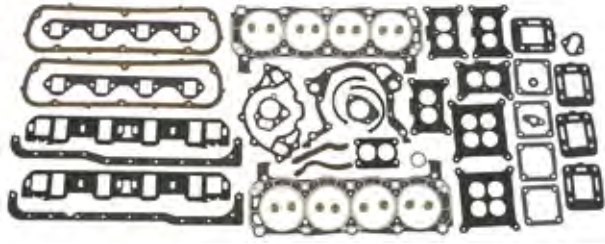

18-4385
For: Ford 302 (5.0L) CID Eng; 215, 225 & 888 (188 HP)
Includes 18-3883 Head Gasket

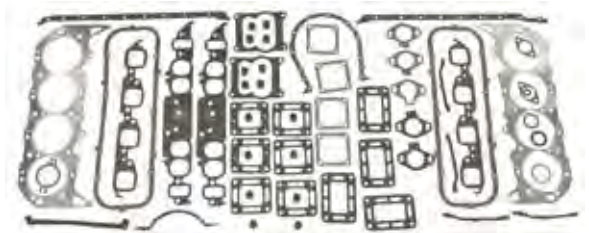

18-4387
Replaces: 27-801853
For: GM 454 (7.4L) CID Eng; Production Models Oval Port
Includes 18-3877 Head Gasket



18-0465
INTAKE MANIFOLD GASKET SET
Replaces: 27-65184, 27-8M0050224
For: GM 454 CID Engines, 325, 330, 340, 350 HP and 454 Magnums, 7.4L

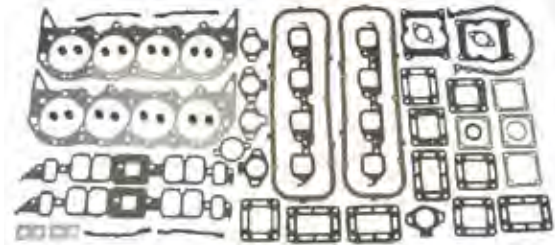

18-4365
INTAKE MANIFOLD GASKET SET
Replaces: 27-801855
For: GM 454 (7.4L) CID Eng; Production Models Rectangular Port
Includes 18-3877 Head Gasket



18-4388
INTAKE MANIFOLD GASKET SET
Replaces: 27-11977A88, A92
For: GM 262 CID Eng; 175, 185 & 205 HP, 4.3L
Includes 18-3879 Head Gasket

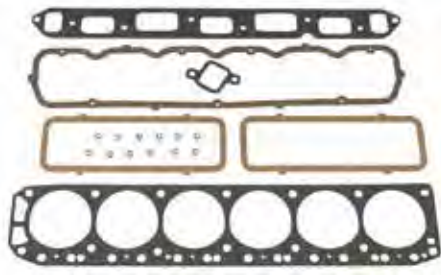

18-4389
INTAKE MANIFOLD GASKET SET
Replaces: 27-47453A1
For: All GM 165 HP (S/N 270032 & UP) & Inline 6 cyl. 250 CID

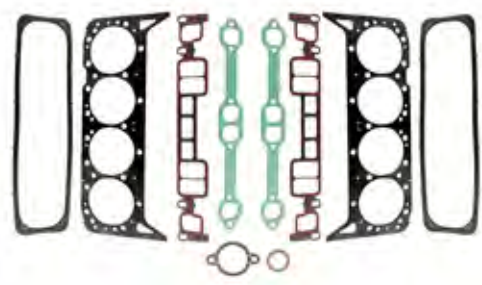

18-1254
VORTEC
HEAD GASKET SET
Replaces: 27-75611A03
For: Small Block GM V8 engines with Vortech heads

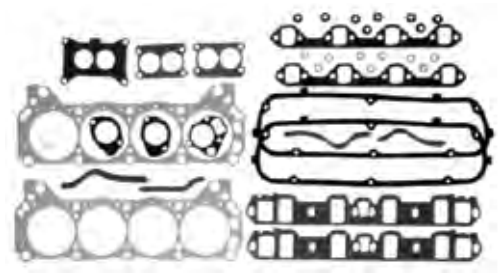

18-4391
INTAKE MANIFOLD GASKET SET
Replaces: 27-64763A2
For: Ford 351 CID Eng; 233 HP S/N 4173000-4500860, 5.8L
Includes 18-3883 Head Gasket

18-4392
INTAKE MANIFOLD GASKET SET
Replaces: 27-75611A2, 27-75611A1
For: GM 305 & 350 CID Eng. 898 (198 HP) 200, 228, 230/260 (Inboard) 230, 250, 255, 260, 280 & 5.7L Ski

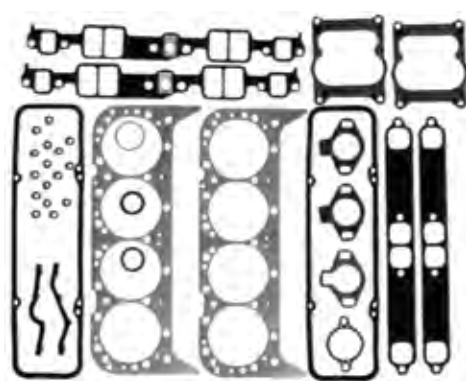

— CONTAINS —

Part #	Description	O.E. #	Qty.
18-0868	Intake Manifold Gasket	27-17145	1
18-2949	Exhaust Manifold Gasket	27-33395	2
18-2848	Quadrajel Base Gasket	27-52457-2	2
18-3876	Head Gasket	27-75611	2
18-2553	Thermostat Gasket	27-47510	1
18-2844	Thermostat Cover Gasket	27-48818-1	1
18-2554	Thermostat Gasket	27-41812	2
18-2917	Lower Thermostat Housing Gasket	27-53045-1	1
18-2845	Valve Cover Gasket	27-11999	2
18-0518	Seal	26-34217	16

OVERHAUL GASKET SETS

(Sets do not include Front and Rear Crankshaft Seals)



18-4381

Replaces: 27-43186A1, 27-89656A1, 27-41636A1
For: 224 (3.7L) CID Eng; 165, 170, 180, 190 HP
 S/N 6916779 & UP

— CONTAINS —

Part #	Description	O.E. #	Qty.
18-0175	O-Ring	25-26543	4
18-0860	O-Ring	25-62700	1
18-0864	Seal	26-90925	1
18-0881-1	Exhaust Elbow Mounting Gasket	27-18272	1
18-0992	Exhaust Manifold Mounting Gasket	27-68715	1
18-0994	Carburetor Mounting Gasket	27-70143-1	1
18-0158	Intake Manifold Gasket	27-70905	1
18-0111	Exhaust Elbow Mounting Gasket	27-89657	2
18-0160	Lower Exhaust to Intake Manifold Gasket	27-94136	1
18-0113-1	Exhaust Elbow Mounting Gasket	27-97542	1
18-2843	Thermostat Cover Gasket	27-74830	1
18-2848	QuadraJet Base Gasket	27-52457-2	1
18-3878	Head Gasket	27-13709T	1
18-7121	O-Ring	25-35027	1
18-0874	Distributor Gasket	27-34486	1
18-0185	Seal	27-91892	1
18-2555	Thermostat Gasket	27-89656-1	1
18-0889	Fuel Pump Mounting Gasket	27-34213	1
18-4366	Oil Pan Gasket Set	27-72479A5	1
18-0387	Flywheel Cover Gasket	27-94976	1
18-0172	Oil Seal	26-97530	2

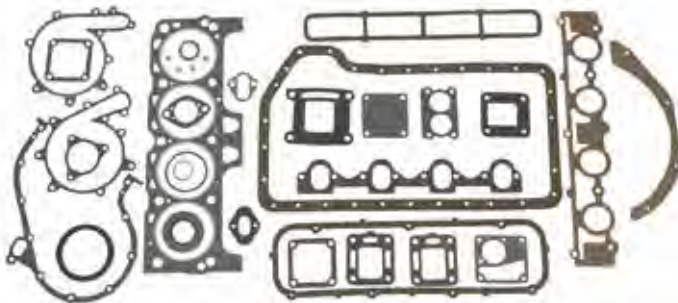

18-4382

Replaces: 27-74830A3, 27-74830A1, 27-74264A1
For: 224 (3.7L) CID Eng; 470 S/N 4208730 & UP

— CONTAINS —

Part #	Description	O.E. #	Qty.
18-0864	Seal	26-90925	1
18-0956-1	Exhaust Manifold Mounting Gasket	27-68715	1
18-0158	Intake Manifold Gasket	27-70905	1
18-0950	Impeller Cover Gasket	27-88046	1
18-0954	Exhaust Mounting Gasket	27-92720	1
18-0113-1	Exhaust Elbow Mounting Gasket	27-97542	1
18-2832-1	Manifold End Cap Gasket	27-48043-1	2
18-2833	Exhaust Elbow To Manifold Gasket	27-99777-2	2
18-2843	Thermostat Cover Gasket	27-74830	1
18-3878	Head Gasket	27-13709T	1
18-0175	O-Ring	25-26543	4
18-0889	Fuel Pump Mounting Gasket	27-34213	1
18-7121	O-Ring	25-35029	1
18-0874	Distributor Gasket	27-34486-3	1
18-0928-1	Manifold End Cap Gasket	27-73814	1
18-0994	Carb. Mounting Gasket	27-70143-1	1
18-2555	Thermostat Cover Gasket	27-89656-1	1
18-4366	Oil Pan Gasket Set	27-72479A5	1
18-0387	Flywheel Cover Gasket	27-94976	1

MISCELLANEOUS GASKET SETS

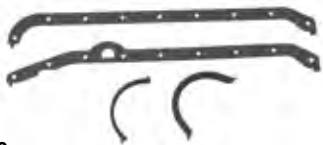

18-0153

OIL PAN GASKET SET

Replaces: 27-85817A1, FI5110037, FI5110032, 27-72627
For: Mercruiser GM 350 CID (5.7L)



18-1239

OIL PAN GASKET

Replaces: 27-810846T, 27-810846
For: Mercruiser 3.0L GM 181



18-0348

OIL PAN GASKET SET

Replaces: 27-52550, 27-49107, FI1100229, FI5000229, FI5000245
For: Mercruiser GM 454/502 CID Eng; (7.4L and 8.2L)



18-1237

OIL PAN GASKET

Replaces: 27-138651, 27-13865, FI1101281
For: Mercruiser GM 5.7L



18-0466

OIL PAN GASKET SET

Replaces: 27-14901A1, 27-14901, 27-52144
For: Mercruiser GM 153/181 (2.5L & 3.0L)



18-1232

OIL PAN GASKET

Replaces: 27-811566, 27-845628
For: GM Big Block



18-1231

INTAKE GASKET

Replaces: 27-8181881, 27-818188
For: Rectangular port high performance big block Chevy



18-0405

OIL PAN GASKET

Replaces: 27-883964, 27-14247, 27-883964T
For: Mercruiser GM 262 CID Eng. (4.3L)



18-1238

INTAKE GASKET SET

Replaces: 27-824326
For: Mercruiser 4.3L/LX models, pre SN F802999



18-61513
OIL PAN GASKET
 Replaces: 27-14247T1, 27-142471
 Fits: Mercruiser MCM 262 Mag & 4.3L/LX/LH/LHX Gen+ (1996 & Up); All GM V6 (1996 & Up)



18-0407
OIL PAN GASKET SET
 Replaces: 27-64798, 27-56870A1
 For: Mercruiser: 215, 225, 888



18-0410
INTAKE MANIFOLD GASKET SET
 Replaces: 27-75648
 For: Ford 5.0L/302, 5.8L/351 CID Engine; (233HP) S/N 3108723 & UP



18-0411
OIL PAN GASKET SET
 Replaces: 27-90458A1, 27-90458, FI5000178, FI5000183
 For: Mercruiser GM 350 CID (5.7L) Starboard Dipstick



18-0611
OIL PAN GASKET SET
 Replaces: 27-75483
 For: Mercruiser Ford 351 CID Eng.



18-0868
INTAKE MANIFOLD GASKET SET
 Replaces: 27-17145, 27-72637, FI5000263, FI5000232, FI1101296
 For: Mercruiser 305, 350



18-4366
OIL PAN GASKET SET
 Replaces: 27-72479A5, 27-72479T, 27-72479
 For: Mercruiser 224 CID (3.7L)

18-4375
TIMING CHAIN GASKET SET
 Replaces: 27-34213A2, 27-34213A1
 For: Mercruiser GM 153 & 181 CID Eng; 110, 120, 130, 140, 150, 160 & 165 HP; 2.5L & 3.0L



— CONTAINS —

Part #	Description	O.E. #	Qty.
18-0889	Fuel Pump Mounting Gasket	27-34213	1
18-0887	Timing Cover Gasket	27-49953	1
18-0948	Distributor Gasket	27-87707	1
18-0327	Water Pump Gasket	27-33956	1

18-4377
TIMING CHAIN GASKET SET
 Replaces: 27-42457A1
 For: GM 262 CID Eng; 175, 185 & 205 HP



18-4378
TIMING CHAIN GASKET SET
 Replaces: 27-54529A1
 For: GM 454 CID Eng. 325, 330, 340 & 350 Inboards & 300TRS



— CONTAINS —

Part #	Description	O.E. #	Qty.
18-0889	Fuel Pump Mounting Gasket	27-34213	1
18-0903	Water Pump Gasket	27-49110	2
18-0980	Timing Chain Gasket	27-54529	1



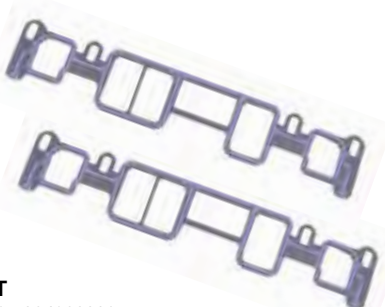
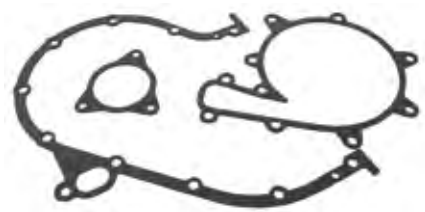



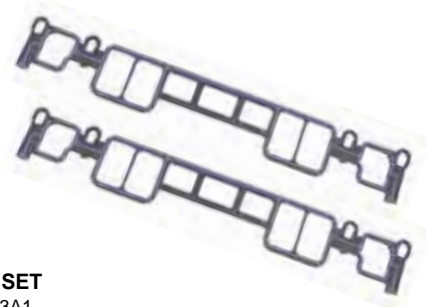







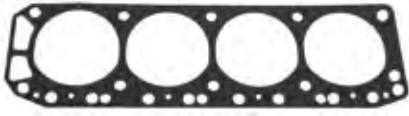
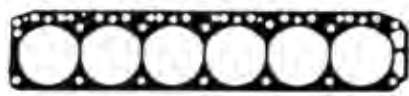

18-4380
TIMING CHAIN GASKET SET
 Replaces: 27-68714A6, 27-68714A7, 27-68714, 27-72098
 For: Mercruiser 224 CID Eng. 165, 170, 180, 190, 470, 485 & 488 HP



18-0487
INTAKE GASKET SET
 Replaces: 27-8243261, 27-824326002
 Fits: MCM 262 Mag & 4.3L/LX/LH/LXH Gen II (1996-up)



18-0488
INTAKE GASKET SET
 Replaces: 27-807473A1
 Fits: MCM 350 Mag, 5.0L & 5.7L/LX Gen II (1996-up)

 <p>18-2946 HEAD GASKET Replaces: 27-52364, 27-81084, FI5000204 For: GM 181 (3.0L) CID Eng.</p>	 <p>18-3874 HEAD GASKET Replaces: 27-811546, 27-879150139 For: (8.2L) 502 CID</p>	 <p>18-3876 HEAD GASKET Replaces: 27-75611, 27-75611001, 27-48330, 27-34278 For: GM 305 (5.0L)/350 (5.7L) CID Eng.</p>	
 <p>18-3877 HEAD GASKET Replaces: 27-13218, 27-13687, 27-19315, 27-49104, 27-61224, 27-97529, 27-8M0049045 For: GM 454 (7.4L) CID Eng., Mark IV (pre-1992)</p>	 <p>18-3878 HEAD GASKET Replaces: 27-13709, 27-13709T, 27-74264, 27-79986, 27-92166, 27-921661 For: Mercruiser 224 (3.7L) CID Eng. Model 470</p>	 <p>18-3879 HEAD GASKET Replaces: 27-11986, 27-816460, 27-879150140, 27-42744 For: GM 262 (4.3L) CID Eng.</p>	
 <p>18-3880 HEAD GASKET Replaces: 27-34273, 27-342731 For: GM 153 (2.5L)</p>	 <p>18-3881 HEAD GASKET Replaces: 27-47453, 27-72622, 27-39164, 27-34274 For: GM 250 (4.1L) CID (6 cyl) Eng.</p>	 <p>18-3883 HEAD GASKET Replaces: 27-75647, 27-75646, 27-64763, 27-56110 For: Ford 302 (5.0L) 351 (5.8L) CID Eng.</p>	
 <p>18-3887 HEAD GASKET Replaces: 27-850470, 27-879150141, 27-811547 For: (7.4L) 454 CID GEN V and VI (1992-up)</p>	 <p>18-0353 CARB MOUNTING GASKET Replaces: 27-58764</p>	 <p>18-0354 CARB MOUNTING GASKET Replaces: 27-60715</p>	 <p>18-0685 VALVE COVER GASKET Replaces: 27-73666 224 CID (3.7L)</p>
 <p>18-0356 CARB MOUNTING GASKET (For Rochester) Replaces: 27-64692, 27-32910</p>	 <p>18-0357 CARB MOUNTING GASKET Replaces: 27-65577, 27-56884</p>	<p>PKG. OF 2</p>  <p>18-0876 18-0876-9① FUEL PUMP GASKET For GM 4.3L, 5.0L & 5.7L Replaces: 27-34898, FI5005756</p>	<p>PKG. OF 2</p>  <p>18-0889 18-0889-9① FUEL PUMP GASKET For GM 4.3L, 5.0L & 5.7L Replaces: 27-34213, 27-56883, FI5000074</p>

SEE PAGES 201-202 FOR OUR COMPLETE LINE OF GASKET SEALANTS

① Priced per Package



18-0360
CARB MOUNTING GASKET
Replaces: 27-70142



18-0462
CARB MOUNTING GASKET
Replaces: 27-48399

Model	Year	S/N
250	1968-69	2314301-2639854
270	1969-72	2851074-3385720
325	1969-70	2278747-3042730
390	1969-70	2781129-3042731

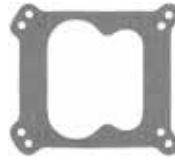

18-0463
CARB MOUNTING GASKET
(For Weber)
Replaces: 27-814210



18-0467
CARB MOUNTING GASKET
(For Weber)
Replaces: 27-41610, 27-49814

PKG. OF 2



18-0994
18-0994-9^①
CARB MOUNTING GASKET
Replaces: 27-701431, 27-8079821, 27-807982, 27-70143, 27-807982B, 27-70143B1

PKG. OF 2



18-2848
18-2848-9^①
CARB BASE GASKET
Replaces: 27-524572, 18-52457, 18-524571

PKG. OF 2



18-0874
18-0874-9^①
DISTRIBUTOR GASKET
For GM V6 & V8
Replaces: 27-344863, 27-344861, 27-34486, 27-52184, 27-34891, FI5000162, F3932344
For: 2.6L (1989), 3.5L (1989), 4.3L (1987-93), 5.0L (1987-88), 5.7L (1987-92), 7.4L (1988-93), 8.2L (1992-93)

PKG. OF 2



18-0948
18-0948-9^①
DISTRIBUTOR GASKET
Replaces: 27-87707
4 Cyl.

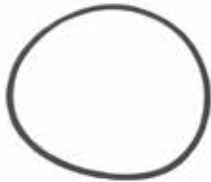

18-0422
DISTRIBUTOR CAP GASKET
Replaces: 391-5076
V8



18-0740-1
THROTTLE BODY GASKET
Replaces: 27-805396

PKG. OF 2



18-2552
18-2552-9^①
THERMOSTAT GASKET
Replaces: 27-331792, 27-331791

PKG. OF 2



18-0667
18-0667-9^①
CONNECTOR COVER GASKET
Replaces: 27-995061, 27-99506

PKG. OF 2



18-2553
18-2553-9^①
THERMOSTAT GASKET
Replaces: 27-47510, 27-47510Q
GM V-6, V-8

PKG. OF 2



18-2554
18-2554-9^①
THERMOSTAT GASKET
Replaces: 27-41812, 27-90556, 27-41812Q
V-6 & V-8

PKG. OF 2



18-2555
18-2555-9^①
THERMOSTAT GASKET
Replaces: 27-896561, 27-89656
4 Cyl.

PKG. OF 2



18-2831
18-2831-9^①
THERMOSTAT GASKET
Replaces: 27-475901, 27-47590
4 & 6 Cyl.

PKG. OF 2



18-2834
18-2834-9^①
THERMOSTAT GASKET
Replaces: 27-60208
Ford V-8

PKG. OF 2



18-2843
18-2843-9^①
THERMOSTAT GASKET
Replaces: 27-74830
470

PKG. OF 2



18-2844
18-2844-9^①
THERMOSTAT GASKET
Replaces: 27-48818, 27-488181, 27-48818Q1
V-8





















PKG. OF 2



18-2917
18-2917-9^①
THERMOSTAT GASKET
Replaces: 27-53045, 27-530451, 27-33179, F10077105, F11101276, F11101291, FI5000096





















SEE PAGES 201-202 FOR OUR COMPLETE LINE OF GASKET SEALANTS

^① Priced per Package

<p>PKG. OF 2</p>  <p>18-0398 18-0398-9① THERMOSTAT GASKET Replaces: 27-8M2021920, 27-33918</p>	 <p>18-0111 EXHAUST ELBOW GASKET Replaces: 27-89657</p>	 <p>18-0113-1 EXHAUST ELBOW GASKET Replaces: 27-97542, 27-856705</p>	<p>PKG. OF 2</p>  <p>18-0672 18-0672-9① EXHAUST ELBOW GASKET Replaces: 27-860231, 27-8637251</p>
 <p>18-0365 HEAT EXCHANGER END GASKET 2 3/4" dia. Replaces: 27-75450 224 CID</p>	 <p>18-0389 HEAT EXCHANGER END GASKET 3 15/16" dia. Replaces: 27-99960</p>	 <p>18-0881-1 EXHAUST ELBOW GASKET Replaces: 27-18272</p>	<p>PKG. OF 2</p>  <p>18-0885-1 18-0885-9① EXHAUST ELBOW GASKET Replaces: 27-48042</p>
 <p>18-0897 EXHAUST ELBOW GASKET Replaces: 27-41813</p>	<p>PKG. OF 2</p>  <p>18-0928-1 18-0928-9① MANIFOLD END CAP GASKET Replaces: 27-73814, 27-738141, 27-807218</p>	 <p>18-0954 EXHAUST ELBOW GASKET Replaces: 27-92720</p>	<p>PKG. OF 2</p>  <p>18-2819-1 18-2819-9① EXHAUST ELBOW GASKET Replaces: 27-39915</p>
<p>PKG. OF 2</p>  <p>18-2832-1 18-2832-1-9① MANIFOLD END CAP GASKET Replaces: 27-480431, 27-48043</p>	<p>PKG. OF 2</p>  <p>18-2833 18-2833-9① EXHAUST ELBOW GASKET Replaces: 27-997772, 27-997771, 27-99777, 27-52076</p>	<p>PKG. OF 2</p>  <p>18-2849-1 18-2849-9-1① EXHAUST ELBOW GASKET Replaces: 27-87105, 27-871051, 27-860232, 27-818832, 27-863726</p>	<p>PKG. OF 2</p>  <p>18-1210-1 END CAP GASKET Replaces: 27-39923</p>
 <p>18-0158 INTAKE MANIFOLD GASKET Replaces: 27-70905 For: 3.7L</p>	 <p>18-0183-1 EXHAUST MANIFOLD GASKET Replaces: 27-73866, 27-54566</p>	 <p>18-0418 EXHAUST MANIFOLD GASKET Replaces: 27-46820</p>	 <p>18-2830-1 EXHAUST MANIFOLD GASKET Inline 6 cyl. Replaces: 879036, 27-46401, 27-52584, 27-33121</p>





















SEE PAGES 201-202 FOR OUR COMPLETE LINE OF GASKET SEALANTS

① Priced per Package

 <p>18-0680 EXHAUST MANIFOLD GASKET Replaces: 27-815528</p>	 <p>18-2896-1 EXHAUST MANIFOLD GASKET Replaces: 27-52546, 27-32816</p>	<p>PKG. OF 2</p>  <p>18-2909 18-2909-9① EXHAUST MANIFOLD GASKET Replaces: 27-99757</p>	 <p>18-2949 EXHAUST MANIFOLD GASKET Replaces: 27-33395 GM 5.0L & 5.7L</p>	 <p>18-2912-1 EXHAUST MANIFOLD GASKET Replaces: 27-53354</p>																									
 <p>18-0956-1 EXHAUST MANIFOLD GASKET Replaces: 27-68715</p>	<p>PKG. OF 2</p>  <p>18-1204-1 18-1204-1-9① EXHAUST MANIFOLD GASKET Replaces: 27-96429</p>	 <p>18-61319 VALVE COVER GASKET Replaces: 27-827154 Fits: Mercruiser MCM 262 Mag & 4.3L/LX/LH/LHX Gen+ w/plastic valve cover(1996 & Up); All GM V6 (1996 & Up)</p>	 <p>18-0664 VALVE COVER GASKET Replaces: 27-17467, F11101287 For: GM 305/350, 5.0 & 5.7L</p>	 <p>18-2845 VALVE COVER GASKET Replaces: 27-11999, 27-34043, 27-52202, F11101236, FI5000161 V-8 GM 305/350 CID, 5.0 & 5.7L</p>																									
 <p>18-25001 VALVE COVER GASKET Replaces: 27-14765, F3860315, F11110294, F11110958 Fits: GM 454, 7.4L</p>	 <p>18-25002 VALVE COVER GASKET Replaces: 27-811588 Fits: GM 454, 502, (1992-UP) Recessed Grooved Valve Cover</p>	 <p>18-0311 VALVE COVER GASKET Replaces: 27-11988 For: 4.3 Litre 262 CID</p>	 <p>18-0346 VALVE COVER GASKET Replaces: 27-49936, 27-34042 For: GM 250 CID (4.1L), 160/165/200 (6 cyl.)</p>																										
 <p>18-0347 VALVE COVER GASKET Replaces: 27-52145, 27-806452, 27-34041 For: GM 153 & 181 CID (2.5L & 3.0L)</p>	<p>PKG.. OF 2</p>  <p>18-0464 18-0464-9① VALVE COVER GASKET Replaces: 27-49121, 27-91831 For: GM 454/502 CID (7.4L & 8.2L)</p> <table border="1"> <thead> <tr> <th>Model</th> <th>Year</th> <th>S/N</th> </tr> </thead> <tbody> <tr> <td>330</td> <td>1977-81</td> <td>4623115-6083144</td> </tr> <tr> <td>7.4 Bravo</td> <td>1988-91</td> <td>B771113-D603117</td> </tr> <tr> <td>454 Mag</td> <td>1986-92</td> <td>A631894-D805068</td> </tr> <tr> <td>370 TRS</td> <td>1978-87</td> <td>4179554-B714586</td> </tr> <tr> <td>400 TRS</td> <td>1980-86</td> <td>4179554-B457644</td> </tr> <tr> <td>400 TRS</td> <td>1983-86</td> <td>4179554-B485220</td> </tr> <tr> <td>460 TRS</td> <td>1983-86</td> <td>4179554-6181046</td> </tr> <tr> <td>502 Mag Bravo</td> <td>1990-92</td> <td>C878221-D824588</td> </tr> </tbody> </table>	Model	Year	S/N	330	1977-81	4623115-6083144	7.4 Bravo	1988-91	B771113-D603117	454 Mag	1986-92	A631894-D805068	370 TRS	1978-87	4179554-B714586	400 TRS	1980-86	4179554-B457644	400 TRS	1983-86	4179554-B485220	460 TRS	1983-86	4179554-6181046	502 Mag Bravo	1990-92	C878221-D824588	 <p>18-0352 VALVE COVER GASKET Replaces: 27-56173 For: Ford 302/351 CID (5.0L & 5.8L)</p>
Model	Year	S/N																											
330	1977-81	4623115-6083144																											
7.4 Bravo	1988-91	B771113-D603117																											
454 Mag	1986-92	A631894-D805068																											
370 TRS	1978-87	4179554-B714586																											
400 TRS	1980-86	4179554-B457644																											
400 TRS	1983-86	4179554-B485220																											
460 TRS	1983-86	4179554-6181046																											
502 Mag Bravo	1990-92	C878221-D824588																											
 <p>18-0468 TIMING COVER GASKET Replaces: 27-811572 GM 4.3L, 5.0L & 5.7L</p>	<p>PKG.. OF 2</p>  <p>18-0887 18-0887-9① TIMING COVER GASKET Replaces: 27-49953, 27-34216, FI5000201 4 & 6 Cyl.</p>	<p>PKG.. OF 2</p>  <p>18-0976 18-0976-9① TIMING CHAIN COVER GASKET Replaces: 27-14250, 27-34895, F11101297</p>	 <p>18-0980 TIMING COVER GASKET Replaces: 27-54529, 27-49109, 110990, 1100990 GM 7.4L</p>																										

SEE PAGES 201-202 FOR OUR COMPLETE LINE OF GASKET SEALANTS

① Priced per Package

<p>PKG.. OF 2</p>  <p>18-0328 18-0328-9① PUSH ROD/LIFTER COVER GASKET Replaces: 27-34208 153 & 181 CID, 120/140 (4 Cyl.)</p>	 <p>18-0329 PUSH ROD/LIFTER COVER GASKET Replaces: 27-34209 For: 140/150/160/165 (6 cyl.)</p>	 <p>18-2815 PUSH ROD COVER GASKET Replaces: 27-814703, FI5000119, FI5000199 For: 3.0L</p>	<p>PKG. OF 2</p>  <p>18-0185 18-0185-9① REMOTE OIL SEAL Replaces: 27-91892</p>
 <p>18-1240 OUTDRIVE SEAL For Bravo Replaces: 12708</p>	<p>PKG. OF 5</p>  <p>18-2516 18-2516-9① BRAVO OUTDRIVE SEAL Replaces: 16755, 16755A1, 16755Q1</p>	<p>PKG. OF 2</p>  <p>18-2556 18-2556-9① DRIVE SHAFT HOUSING TO BELL HOUSING GASKET Replaces: 27-35996, A1</p>	 <p>18-2743 OUTDRIVE HOUSING GASKET Replaces: 27-94996, 27-949962, 27-94996A1, 27-94996A2, 27-94996Q2, 27-94996A3, 27-94996A20, 27-64818A2</p>
<p>PKG. OF 5</p>  <p>18-2820 18-2820-9① OUTDRIVE GASKET Replaces: 27-64818, Q4, 27-64818A20, 27-64818A4, 27-64818A1, 27-45821</p>	<p>PKG. OF 5</p>  <p>18-2840 18-2840-9① BELL HOUSING GASKET Replaces: 27-35982</p>	<p>PKG. OF 2</p>  <p>18-2847 18-2847-9① OUTDRIVE GASKET Replaces: 27-54014, 27-54014A1, 27-54014Q1, 27-54014T1 For: E, H, TR, TRS</p>	 <p>18-0386 WATER PUMP BODY GASKET Replaces: 27-94914, 27-72780</p>
<p>PKG. OF 2</p>  <p>18-0894 18-0894-9① WATER POCKET COVER GASKET Replaces: 27-55810, 27-55810 -1</p>	<p>PKG. OF 2</p>  <p>18-0916 WATER PUMP GASKET Replaces: 27-8052151, 27-805215, 27-94915, 27-72779</p>	<p>PKG. OF 2</p>  <p>18-0903 18-0903-9① WATER PUMP GASKET Replaces: 27-49110, FI1101000 454 CID</p>	 <p>18-0147 WATER PUMP GASKET For Ford V-8 Replaces: 27-56880</p>
 <p>18-0327 WATER PUMP GASKET Replaces: 27-33956, FI5000200, FI5000219 4 & 6 Cyl.</p>	<p>PKG. OF 2</p>  <p>18-0891 18-0891-9① WATER PUMP MOUNTING GASKET Replaces: 27-34897, 27-34896, FI5000077, FI5000078 For: GM 4.3L, 5.0L & 5.8L</p>	<p>PKG. OF 2</p>  <p>18-0893 18-0893-9① WATER PUMP BACK-IN PLATE GASKET Replaces: 27-35380 GM 4.3L, 5.0L & 5.7L</p>	<p>PKG. OF 2</p>  <p>18-2564 18-2564-9① IMPELLER GASKET Alpha I - Generation 2 Replaces: 27-430331</p>

SEE PAGES 201-202 FOR OUR COMPLETE LINE OF GASKET SEALANTS

① Priced per Package

 <p>18-0950 IMPELLER HOUSING GASKET Replaces: 27-88046 224 CID</p>	<p>PKG. OF 2</p>  <p>18-2565 18-2565-9① IMPELLER GASKET Alpha I - Generation 2 Replaces: 27-430472</p>	<p>PKG. OF 2</p>  <p>18-2566 18-2566-9① IMPELLER GASKET Alpha I - Generation 2 Replaces: 27-817277</p>	<p>PKG. OF 2</p>  <p>18-2823 18-2823-9① LOWER WATER PUMP GASKET Replaces: 27-32769, 27-19553</p>
<p>PKG. OF 2</p>  <p>18-2824 18-2824-9① UPPER WATER PUMP GASKET Replaces: 27-32770, 27-19551</p>	<p>PKG. OF 2</p>  <p>18-2825 18-2825-9① WATER PUMP BASE GASKET Replaces: 27-32771</p>	<p>PKG. OF 2</p>  <p>18-2826 18-2826-9① WATER PUMP BASE GASKET Replaces: 27-856101, 27-856704, 27-85610</p>	<p>PKG. OF 2</p>  <p>18-2914 18-2914-9① WATER PUMP GASKET Replaces: 27-856081, 27-85608, 27-32433, 27-30603, 27-8M0090319</p>
<p>PKG. OF 2</p>  <p>18-2915 18-2915-9① WATER PUMP GASKET Replaces: 27-856091, 27-858524, 27-85609, 27-32434, 27-30604</p>	<p>PKG. OF 2</p>  <p>18-2919 18-2919-9① WATER PUMP GASKET Replaces: 27-426311, 27-42631</p>	<p>PKG. OF 2</p>  <p>18-0342 POWER TRIM HOSE CONNECTOR PLATE GASKET Replaces: 27-476441, 27-47644</p>	<p>PKG. OF 2</p>  <p>18-0388 POWER TRIM HOSE CONNECTOR GASKET Replaces: 27-988231, 27-98823</p>
<p>PKG. OF 2</p>  <p>18-0322 18-0322-9① REAR SEAL GASKET Replaces: 27-14241, 27-881715, F11101656 GM 5.0L & 5.7L</p>	<p>PKG. OF 2</p>  <p>18-0898 OIL PUMP MOUNTING GASKET Replaces: 27-56859 For: Ford Engines</p>	<p>PKG. OF 2</p>  <p>18-3289 DOUBLE LIP SEAL Replaces: 26-864319 For: Gen II Upper Housing</p>	<p>PKG. OF 2</p>  <p>18-2094 OIL SEAL Replaces: 26-36143, 26-88416 Fits: 120/140(1978-82), 165 (1978-81), 260 (1978-82), 470 (1978-82), 485 (1980-82), 898/228 (1978-82), Alpha I/Gen II (1991 & Up), Blackhawk (1994-95), Bravo I/II/III (1988-98), R/MR/Alpha One Sterndrive and Transom (1983-90)</p>
<p>PKG. OF 2</p>  <p>18-2944 18-2944-9① SEAL RING GASKET (Quad Ring) Replaces: 26-45577, 26-455771</p>	<p>PKG. OF 2</p>  <p>18-2945 18-2945-9① 18-29451-9① (PKG. OF 50) DRAIN SCREW GASKET Replaces: 12-20260, 12-19183, 12-191832, 12-191833, F50556, F8077, F8186 Used in most lower units and sea water pumps</p>	<p>PKG. OF 5</p>  <p>18-2948 18-2948-9① RUBBER WASHER Replaces: 12-492211, 12-49221, 12-23245</p>	<p>PKG. OF 5</p>  <p>18-2349 SHIFT SHAFT SLEEVE Replaces: 23-67370 For: Ratios 1.47, 1.62, 1.81 & 1.94. For: Gen II (1998 & up), (0L100040 & up) 1/4" Thick</p>

SEE PAGES 201-202 FOR OUR COMPLETE LINE OF GASKET SEALANTS

① Priced per Package

<p>PKG. OF 2</p>  <p>18-0905 18-0905-9^① OIL PAN DRAIN PLUG GASKET Replaces: 27-49955, 27-34502, 27-60721, 27-8M0077608</p>	<p>PKG. OF 2</p>  <p>18-4267 18-4267-9^① SHIFT SHAFT WASHER Replaces: 12-29395, 12-8M0042641</p>	<p>PKG. OF 3</p>  <p>18-0681 18-0681-9^① WASHER Replaces: 12-32834, 12-8M2001219, 12-93416, 12-934161</p>	<p>PKG. OF 5</p>  <p>18-0203 18-0203-9^① BELL HOUSING WASHER Replaces: 12-35935 All Mercuriser Stern drives 1963-1998</p>																		
<p>PKG. OF 5</p>  <p>18-2316 18-2316-9^① SHIFT SHAFT WASHER Replaces: 12-77674, 12-25410 Used over 18-2349 sleeve For: Ratios 1.47, 1.62, 1.81 & 1.94 For: Gen II (1998 & up), (0L100040 & up) 1/8" Thick</p>	 <p>18-0318 WASHER Replaces: 12-815472</p>	<p>PKG. OF 2</p>  <p>18-4270 18-4270-9^① WASHER Replaces: 12-36001</p>	<p>PKG. OF 5</p>  <p>18-2340 18-2340-9^① SHIFT SHAFT WASHER Replaces: 12-31266 For: #1R/MR (1/16" Thick)</p>																		
<p>PKG. OF 2</p>  <p>18-2343 18-2343-9^① PINION NUT WASHER Replaces: 12-92721 For: MR/Alpha/Gen II</p>	 <p style="text-align: center;">SCREWS</p> <table border="1"> <thead> <tr> <th>Part No.</th> <th>Description</th> <th>O.E. #</th> </tr> </thead> <tbody> <tr> <td>18-2361</td> <td>(PKG. OF 2)</td> <td>10-805763, 10-853163</td> </tr> <tr> <td>18-2361-9^①</td> <td>Lower Unit Mounting Screw</td> <td>10-30206</td> </tr> <tr> <td>18-3197</td> <td>Water Pick-Up Insert Screw</td> <td>10-76156, 10-67373</td> </tr> <tr> <td>18-3230</td> <td>Gear Housing to Drive Shaft Housing Screw</td> <td>10-816601</td> </tr> <tr> <td>18-3231</td> <td>Upper Drive Shaft Top Cover Screw</td> <td>10-98794</td> </tr> </tbody> </table>		Part No.	Description	O.E. #	18-2361	(PKG. OF 2)	10-805763, 10-853163	18-2361-9 ^①	Lower Unit Mounting Screw	10-30206	18-3197	Water Pick-Up Insert Screw	10-76156, 10-67373	18-3230	Gear Housing to Drive Shaft Housing Screw	10-816601	18-3231	Upper Drive Shaft Top Cover Screw	10-98794	<p>PKG. OF 5</p>  <p>18-3721 18-3721-9^① NUT Replaces: 11-13439-1, 11-859116 For: MR/Alpha</p>
Part No.	Description	O.E. #																			
18-2361	(PKG. OF 2)	10-805763, 10-853163																			
18-2361-9 ^①	Lower Unit Mounting Screw	10-30206																			
18-3197	Water Pick-Up Insert Screw	10-76156, 10-67373																			
18-3230	Gear Housing to Drive Shaft Housing Screw	10-816601																			
18-3231	Upper Drive Shaft Top Cover Screw	10-98794																			
 <p>18-3236 HOUSING ALIGNMENT BUSHING Replaces: 23-32632 For: #1R/MR/Alpha</p>	 <p>18-4272 WELCH PLUG O.D. 0.870" Replaces: 19-32652</p>	 <p>18-4273 WELCH PLUG O.D. 1.250" Replaces: 19-42682</p>	 <p>18-2140 ENGINE MOUNT BOLT KIT For: Mercuriser I</p>																		
 <p>18-2141 ENGINE MOUNT BOLT KIT Replaces: 10-97934A1 For: R/MR/Alpha I/ Gen II/Bravo</p>	 <p>18-3728 LOCK NUT Replaces: 11-99298, 11-863332</p>	 <p>18-3729 MOTOR MOUNT BOLT 1/2" - 20 x 5 3/8" Replaces: 10-97934, 10-36289</p>	 <p>18-2193 REAR ENGINE MOUNT Replaces: 33149, 99297A1, 99297A2 For: 120/140 HP S/N 6229717 & UP; All 224 CID Blocks; All 898, 200, 228, 230, 260, 300 & 320 HP; All 350-454 Magnums</p>																		

① Priced per Package

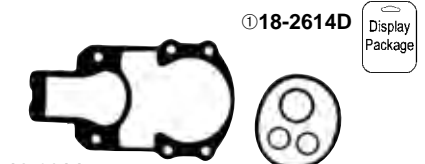

18-2614
OUTDRIVE GASKET SET

1967-1982
Replaces: 27-64818A1, 27-64818T4, 27-64818Q4, 27-64818A20, 27-64818A4, 27-64818, 27-45821

—CONTAINS—

Part #	Description	O.E. #	Qty.
18-2820	Drive Shaft Housing to Bell Housing Gasket	27-64818	1
18-2840	Bell Housing Gasket	27-35982	1
18-7153	O-Ring	25-25439	2
18-7170	O-Ring	25-33504	1

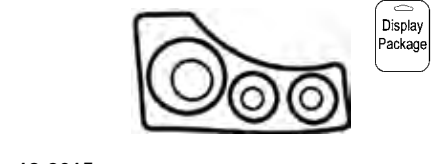

18-2615
OUTDRIVE GASKET SET

(Bravo Unit)
Replaces: 16755, 16755A1, 16755Q1, 16755T1
For: All Bravo

—CONTAINS—

Part #	Description	O.E. #	Qty.
18-2516	Seal	16755	1
18-7198	O-Ring	25-45710	1
18-7153	O-Ring	25-25439	2
18-7168	O-Ring	25-48171	2
18-7105	O-Ring	25-62705	1
18-7117	O-Ring	25-35027	1

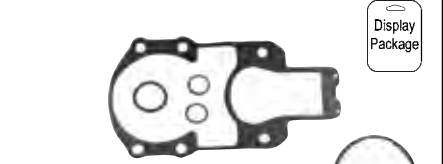

18-2617
OUTDRIVE GASKET SET

Old Style
Replaces: 27-35996, 27-35996A1
For: IA/IB/IC and EZ Shift (1964-1966)

—CONTAINS—

Part #	Description	O.E. #
18-2556	Drive Shaft Housing to Bell Housing Gasket	27-35996
18-2840	Bell Housing Gasket	27-35982
18-7153	O-Ring	25-25439
18-7170	O-Ring	25-33504



18-2619-1
OUTDRIVE GASKET SET

Replaces: 27-64818A3, 27-94996Q2, 27-94996T2, 27-94996, 27-94996A1, 27-94996A2, 27-94996A20, 27-64818A2, 27-64818A3
For: R, MR, Alpha I, Alpha Gen II (1983-Newer)

—CONTAINS—

Part #	Description	O.E. #
18-2743	Drive Shaft Housing to Bell Housing Gasket	27-94996-2
18-2840	Bell Housing Gasket	27-35982
18-7153	O-Ring	25-25439
18-7170	O-Ring	25-33504
18-7117	O-Ring	25-35027



18-2620
OUTDRIVE GASKET SET

Replaces: 27-54014A1, 27-54014Q1, 27-54014T1, 27-54014
For: E, H, TR, TRS

—CONTAINS—

Part #	Description	O.E. No.
18-7175	O-Ring	25-62817
18-2847	Drive Shaft Housing to Bell Housing Gasket	27-54014

① Items ending in "D" are Display Packaged - Regular number is Non-Display

Stem Drive Model	Beginning Serial #	Ending Serial #	Bell Housing Gasket	Bell Housing O-Ring	Bell Housing Rubber Gasket	U-Joint O-Ring (2 Required)	Gasket Set
I	1534570	1684187	—	18-7170	—	18-7153	—
IA	1684188	2062140	18-2556	18-7170	18-2840	18-7153	18-2617
IB	1684633	2062140	18-2556	18-7170	18-2840	18-7153	18-2617
IC	1685240	2065189	18-2556	18-7170	18-2840	18-7153	18-2617
II TR	3377316	4794899	18-2847	18-7175	—	—	18-2620
120	2062141	6225576	18-2820	18-7170	18-2840	18-7153	18-2614
120	6225577	UP	18-2743	18-7170	18-2840	18-7153	18-2619-1
120	6225577	UP	18-2743 ③	18-7170	18-2840	18-7153	18-2619-1
140	2062141	6225576	18-2820	18-7170	18-2840	18-7153	18-2614
140	6225577	UP	18-2743	18-7170	18-2840	18-7153	18-2619-1
140	6225577	UP	18-2743 ③	18-7170	18-2840	18-7153	18-2619-1
160	2065190	2763441	18-2820	18-7170	18-2840	18-7153	18-2614
165	2763442	UP	18-2820	18-7170	18-2840	18-7153	18-2614
170	6225577	UP	18-2743	18-7170	18-2840	18-7153	18-2619-1
170	6225577	UP	18-2743 ③	18-7170	18-2840	18-7153	18-2619-1
185	6225577	UP	18-2743	18-7170	18-2840	18-7153	18-2619-1
185	6225577	UP	18-2743 ③	18-7170	18-2840	18-7153	18-2619-1
190	6225577	UP	18-2743	18-7170	18-2840	18-7153	18-2619-1
190	6225577	UP	18-2743 ③	18-7170	18-2840	18-7153	18-2619-1
200	6225577	UP	18-2743	18-7170	18-2840	18-7153	18-2619-1
200	6225577	UP	18-2743 ③	18-7170	18-2840	18-7153	18-2619-1
215 E/H	2782203	2915034	18-2847	18-7175	—	18-7153 ④	18-2620
225	3856268	4200499	18-2820	18-7170	18-2840	18-7153	18-2614
228	4782330	6225576	18-2820	18-7170	18-2840	18-7153	18-2614
228	6225577	UP	18-2743	18-7170	18-2840	18-7153	18-2619-1
228	6225577	UP	18-2743 ③	18-7170	18-2840	18-7153	18-2619-1
230	6225577	UP	18-2743	18-7170	18-2840	18-7153	18-2619-1
230	6225577	UP	18-2743 ③	18-7170	18-2840	18-7153	18-2619-1
233	4200500	UP	18-2820	18-7170	18-2840	18-7153	18-2614
250	4791300	4898729	18-2820	18-7170	18-2840	18-7153	18-2614

① Hydraulic Shift Only ② Borg Warner Transmission Only ③ For housing with oil reservoir check valve

Stern Drive Model	Beginning Serial #	Ending Serial #	Bell Housing Gasket	Bell Housing O-Ring	Bell Housing Rubber Gasket	U-Joint O-Ring (2 Required)	Gasket Set
255 TRS	3377316	4203749	18-2847	18-7175	—	—	18-2620
260	4898730	6225576	18-2820	18-7170	18-2840	18-7153	18-2614
260	6225577	UP	18-2743	18-7170	18-2840	18-7153	18-2619-1
260	6225577	UP	18-2743 ③	18-7170	18-2840	18-7153	18-2619-1
280 TRS	4203750	4895399	18-2847	18-7175	—	—	18-2620
470	4208730	6225576	18-2820	18-7170	18-2840	18-7153	18-2614
470	6225577	UP	18-2743	18-7170	18-2840	18-7153	18-2619-1
470	6225577	UP	18-2743 ③	18-7170	18-2840	18-7153	18-2619-1
485	4893835	UP	18-2820	18-7170	18-2840	18-7153	18-2614
488	6225577	UP	18-2743	18-7170	18-2840	18-7153	18-2619-1
488	6225577	UP	18-2743 ③	18-7170	18-2840	18-7153	18-2619-1
888	3106717	UP	18-2820	18-7170	18-2840	18-7153	18-2614
898	4782330	6225576	18-2820	18-7170	18-2840	18-7153	18-2614
898	6225577	UP	18-2743	18-7170	18-2840	18-7153	18-2619-1
898	6225577	UP	18-2743 ③	18-7170	18-2840	18-7153	18-2619-1
R/MR/Alpha One	6225577	UP	18-2743	18-7170	18-2840	18-7153	18-2619-1
R/MR/Alpha One	6225577	up	18-2743 ③	18-7170	18-2840	18-7153	18-2619-1
Bravo (I/II)	B664190	UP	18-2516	—	—	18-7153	18-2615
TR-TRS	4794900	UP	18-2847	18-7175	18-2847	18-7153 □	18-2620

① Hydraulic Shift Only ② Borg Warner Transmission Only ③ For housing with oil reservoir check valve

**All Sierra products
meet or exceed the
original equipment part
it replaces.**



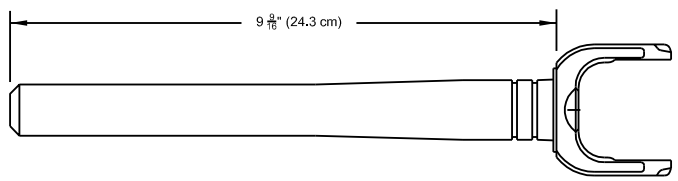
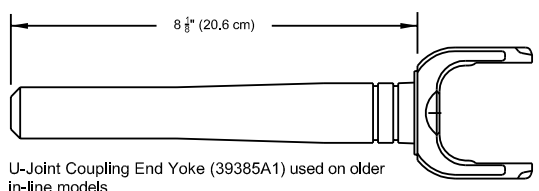
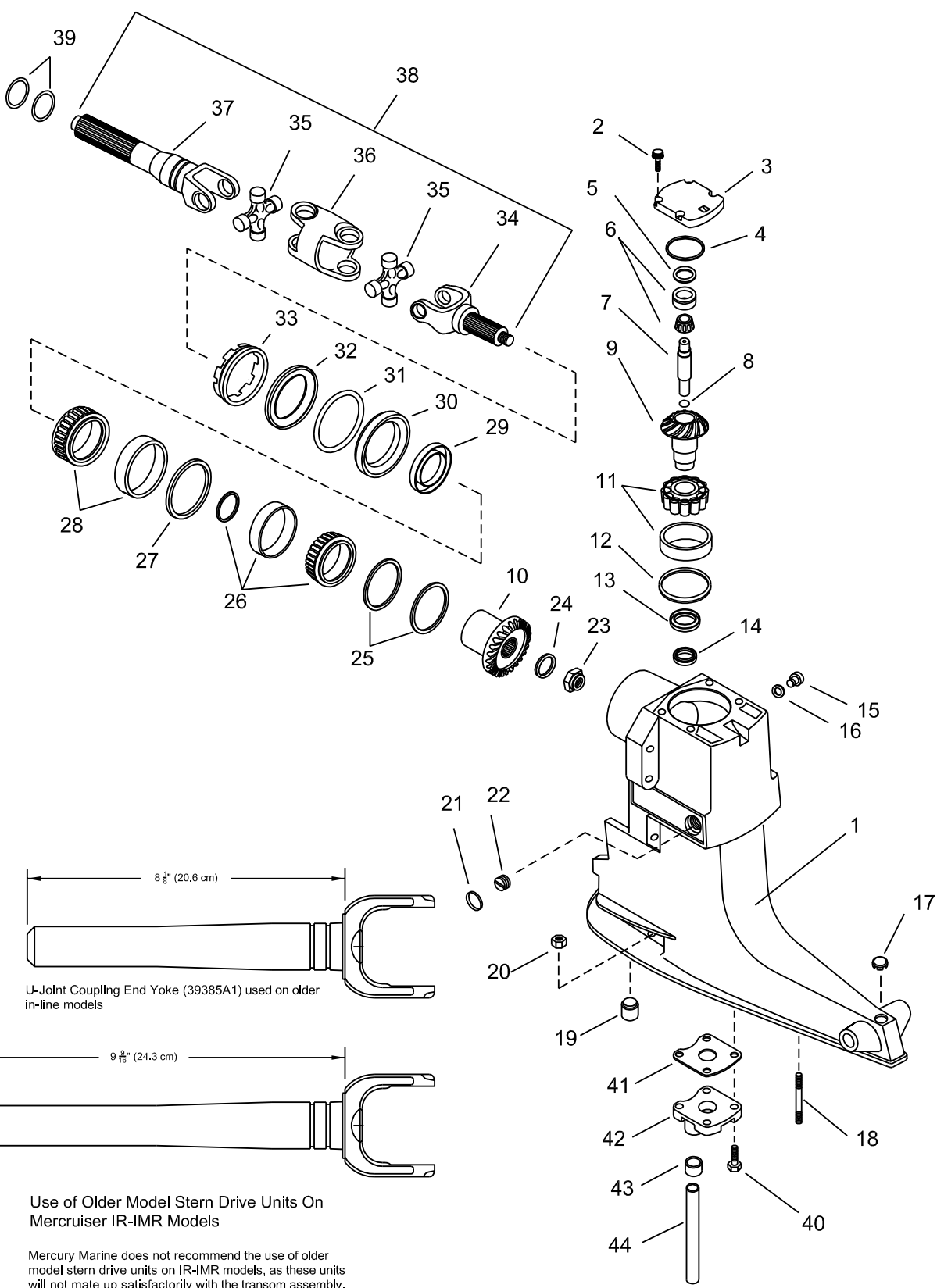

Use of Older Model Stern Drive Units On Mercruiser IR-IMR Models

Mercury Marine does not recommend the use of older model stern drive units on IR-IMR models, as these units will not mate up satisfactorily with the transom assembly. In addition, the older model in-line stern drive units are equipped with U-Joint coupling end yoke (39385A1). This yoke is shorter than yoke (59830A1) used on the IR-IMR stern drive units, and therefore, will not fully engage the engine coupler splines. **Use of an older In-Line model stern drive unit on a IR-IMR model will result in a spline failure to coupling and/or yoke.**

SEE PAGES 826-827 FOR COMPLETE REPLACEMENT HOUSINGS

Figure #	Description	Part #	OEM #	Qty.
1	Upper Gear Housing	N/A	1547-9412A18	1
2	Screw, Top Cover	18-3231	10-98794	4
3	Top Cover	18-2381	94998A2	1
4	O-Ring, Top Cover	18-7161	25-32546	1
5	Shim, Bearing Cup to Top Cover	18-2283	15-45691A1	1
6	Tapered Roller Bearing	18-1165	31-61100A1	1
7	Upper Drive Shaft	18-2179	45-55796	1
8	O-Ring, Upper Drive Shaft	18-7445	25-55801	1
9./10.	Upper Unit Gear Set			
	1.5:1	18-2201	43-18410A2, 46-18411A2	1
	Rebuild Kit	18-2256	43-803116T1	1
	1.65:1	18-2203	43-45814A5	1
	Rebuild Kit	18-2257	43-803112T1	1
	1.84:1	18-2204	43-75325A3	1
	Rebuild Kit	18-2258	43-803114T1	1
	1.98:1	18-2205	43-55778A3	1
	Rebuild Kit	18-2259	43-803101T1	1
11	Tapered Roller Bearing	18-1161	31-35990A1	1
12	Shim Kit, Bearing Cup to Drive Shaft Housing	18-2293	15-36178A1	1
13	Oil Seal, Upper Drive Shaft Housing	18-2049	26-32511	1
14	Oil Seal, Lower Drive Shaft Housing	18-2056	26-96503	1
15	Vent Screw	18-2244	10-79953A2	1
16	Gasket, Gear Housing Drain Screw	18-2945	12-19183, 12-20260	1
17	Plug, Trim Tab Hole	18-3232	19-47579	1
18	Stud, Drive Shaft Housing	N/A	16-56295	2
19	Bushing, Drive Shaft Housing	18-3236	23-32632	1
20	Nut, Gear Housing Stud	18-2362	11-13439-1	3
21	Welch Plug, Drive Shaft Housing			
	(7/8" OD)	18-4272	19-32652	1
	(1 1/4" OD)	18-4273	19-42682	1
22	Pipe Plug, Water Pocket	18-4265	22-428611	1
23	Nut, Drive Gear to U-Joint	18-3713	11-22339	1
24	Washer, Drive Gear to U-Joint Nut	18-3712	12-45810	1
25	Shim Kit Drive Gear	18-2292	15-35980A1	1
26	Bearing Kit	18-1160	31-35988A2, A12	1
27	Spacer (comes with kit)	18-1160	31-35988A2, A13	1
28	Roller Bearing (comes with kit)	18-1160	31-35988A2, A13	1
29	Oil Seal	18-2003	26-64893	1
30	Carrier Assembly Oil Seal	18-0577	66081A2	1
31	O-Ring	18-7169	25-70937	1
32	Ring, Roller Bearing Retainer	18-4296	35983	1
33	Retaining Nut Drive Shaft Housing	18-3752	816811-1	1
34	Yoke Assembly	18-2125	46020T	1
35	Heavy Duty U-Joint	18-2104	75832A2	1
36	Center Socket	18-2128	39383T	1
37	U-Joint Shaft Coupler	18-2146	59830A1	1
38	Drive Shaft	18-9218	59830A5	1
39	O-Ring	18-7153	25-25439	2
40	Screw, Water Pocket Cover to Drive Shaft Housing	18-3229	10-28668	4
41	Gasket, Water Pocket Cover	18-0894	27-55810	1
42	Water Pocket Cover (Sold as Assembly includes 40-44)	18-3219	42724A3	1
43	Bushing, Water Pump Housing	18-3110	26-38970	1
44	Water Tube	18-3220	32-54236	1

AR As required

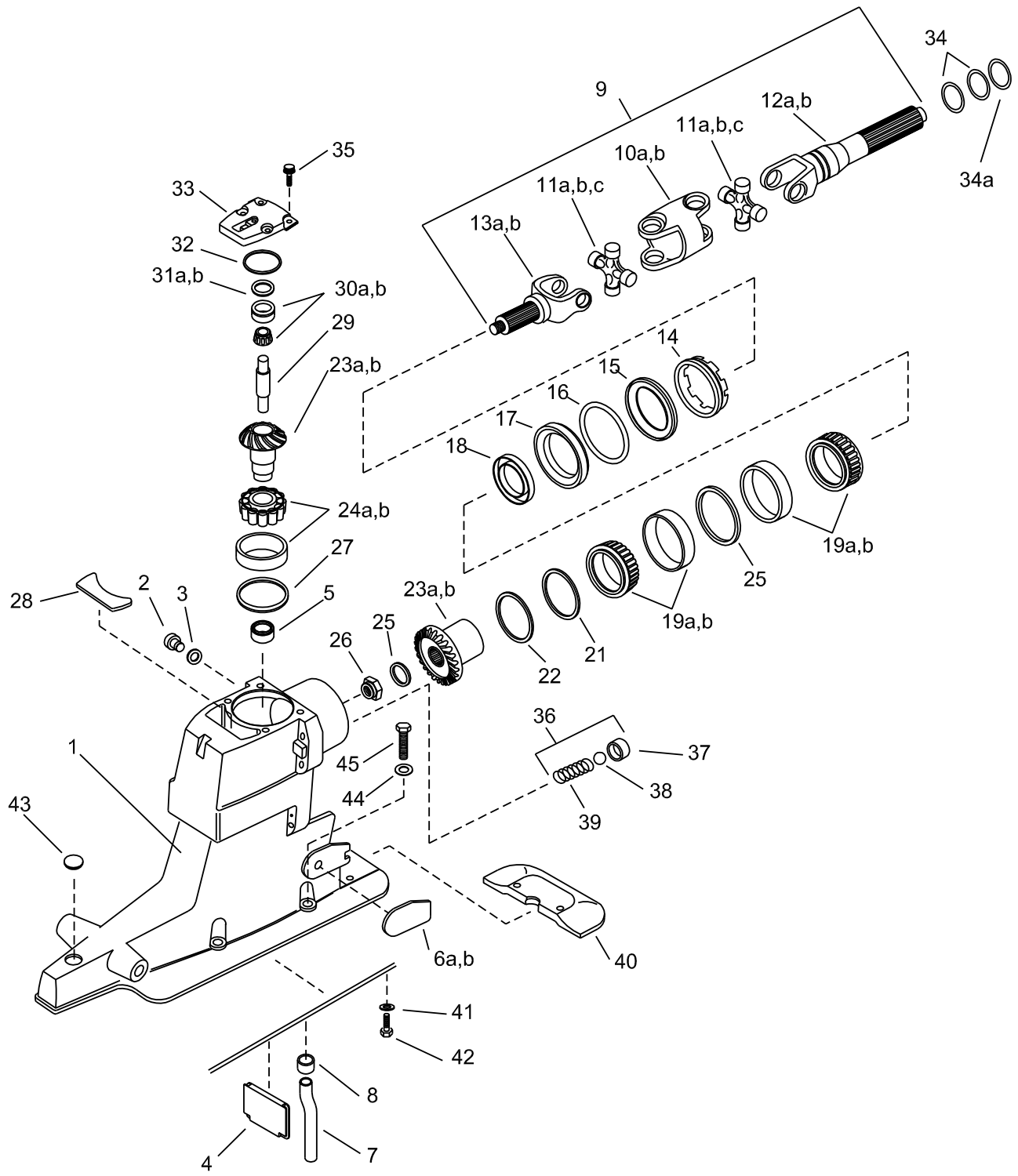

SEE PAGES 826-827 FOR COMPLETE REPLACEMENT HOUSINGS

Figure #	Description	Part #	OEM #	Qty.	Figure #	Description	Part #	OEM #	Qty.
1	Drive Shaft Housing (OL100009 & UP)	18-2411	1547-861063A 4	1		1.84:1/ 1.81:1 Gear Set (tooth count... 17/19)	18-2204	43-75325A3	1
2	Screw	18-2244	10-79953A2	1		Std. Rebuild Kit	18-2258	43-803114T 1	1
3	Washer	18-2945	12-19183, 12-20260	1		Complete Service Kit	18-2365	43-803120 T 1	1
4	Filler Wall	N/A	815932	1		1.98:1/ 1.94:1 Gear Set (tooth count... 20/24)	18-2205	43-55778A3	1
5	Oil Seal	18-2056	26-66302	AR		Std. Rebuild Kit	18-2259	43-803101T 1	1
6a	Wear Pad (Port)	NSS	814386	1		Complete Service Kit	18-2363	43-803118T 1	1
6b	Wear Pad (Stbd)	NSS	814387	1	23a	Upper Unit Gear Set (OL100009 & UP)			
7	Water Tube	18-3221	32-860220	1		1.47:1 Gear Set (tooth count... 20/22)	18-6351	43-853641A2	1
8	Seal	NSS	26-88397	1		Complete Service Kit	18-6351K	43-803103T 1	1
9	Yoke Assembly (OK999999 & Below)	18-9218	814819A2	1		1.62:1 & 2.0:1 Gear Set (tooth count... 24/24)	18-6350	43-853640A2	1
	Yoke Assembly (OL100009 & UP)	NSS	864281A2	1		Complete Service Kit	18-6350K	43-803104T 1	1
10a	Socket, Center (old design)	18-2128	343831, 39383T	1		1.81:1 Gear Set (tooth count... 17/19)	18-6353	43-853643A2	1
10b	Socket, Center GKN Series	NSS	865503T	1		Complete Service Kit	18-6353K	43-803105T 1	1
11	Cross and Bearing					1.94 & 2.4:1 Gear Set (tooth count... 20/24)	18-6352	43-853642A2	1
11a	D469859 - F679999 (old design)	18-2174	75832A2	2		Complete Service Kit	18-6352K	43-803106T 1	1
11b	F680000 - OK999999 (old design- permalube)	18-2097	8055361, 805536A1, 805536A2	2	24	Roller Bearing (All but 1.47:1 ratio)	18-1161	43-803106T 1	1
11c	OL100009 & UP (GKN Series)	18-6406	865493A01	2	24a	Roller Bearing (1.47:1 Ratio only)	18-1142	31-32573A 1	1
12a	Yoke, Coupling End (OK999999 & Below)	18-2146	59830A1	1	25	Washer	18-3712	12-45810	1
12b	Yoke, Coupling End (OL100009 & UP)	NSS	865491A01	1	26	Nut	18-3713	11-22339	1
13a	Yoke, Gear End (OK999999 & Below)	18-2125	46020T	1	27	Shim Kit	18-2293	15-36178A1	1
13b	Yoke, Gear End (OL100009 & UP)	NSS	865492T	1	28	Plug	NSS	861738	1
14	Retaining Nut	18-3752	816811-1	1	29	Drive Shaft, Upper (F680000 & Up)	18-2324	45-55796-1	1
15	Ring	18-4296	35983	1	30	Bearing Assembly			
16	O-Ring	18-7169	25-70937	1	30a	F680000 & UP (small bearing)	18-1179	31-32575A1	1
17	Carrier Assembly (Set)	18-0577	66081A2	1	30b	D494569 - F679999 (large bearing)	18-1165	31-61100A1	1
18	Oil Seal	18-2003	26-68493	1	31	Shim Kit			
19	Roller Bearing Kit (D469859 - K999999)	18-1160	31-35988A2, A12	1	31a	D494569 - F679999	18-2283	15-45691A1	1
19a	Roller Bearing Kit (OL100009 & UP)	18-1182	31-30894A 15	1	31b	F680000 & UP	18-2282	15-32563A1	1
20	Cup Spacer (Included with 18-1160)	18-1160	31-35988A2, A12	AR	32	O-Ring	18-7161	25-32546	1
20a	Cup Spacer (Included with 18-1182)	NSS	23-853649A 1	AR	33	Cover Assembly, Top (F680000 & Up)	18-2382	828692A1	1
21	Shim Kit	18-2292	15-35980A1	1	34	O-Ring	18-7153	25-25439	2
22	Shim Spacer	18-2296	15-71013	1	34a	O-Ring	18-7117	25-35027	1
23	Upper Unit Gear Set (OD469859-OK999999)				35	Screw	18-3231	10-98794	4
	1.5:1/ 1.47:1 Gear Set (tooth count... 20/22)	18-2201	43-18410A2, 43-18411A2	1	36	Check Valve Kit, Oil Passage	18-2715 KIT	24-17997A1	1
	Std.Rebuild Kit	18-2256	43-803116T 1	1	37	Oil Seal (Included in Kit)	NSS	—	1
	Complete Service Kit	18-2358	43-803102T 1	1	38	Ball (Included in Kit)	NSS	—	1
	1.65:1/ 1.62:1 Gear Set (tooth count... 24/24)	18-2203	43-45814A5	1	39	Spring	NSS	—	1
	Std. Rebuild Kit	18-2257	43-803112T 1	1	40	Anode Plate	18-6080	821629A1	1
	Complete Service Kit	18-2364	43-803119T 1	1	41	Lockwasher	N/A	13-78968	2
					42	Screw	18-3229	10-28668	2
					43	Plug	N/A	19-824928	1
					44	Washer	18-4858-9	12-45176	4
					45	Bolt	18-3230	10-816601	4

AR As Required

NSS Not Sold Separate

N/A Not Available

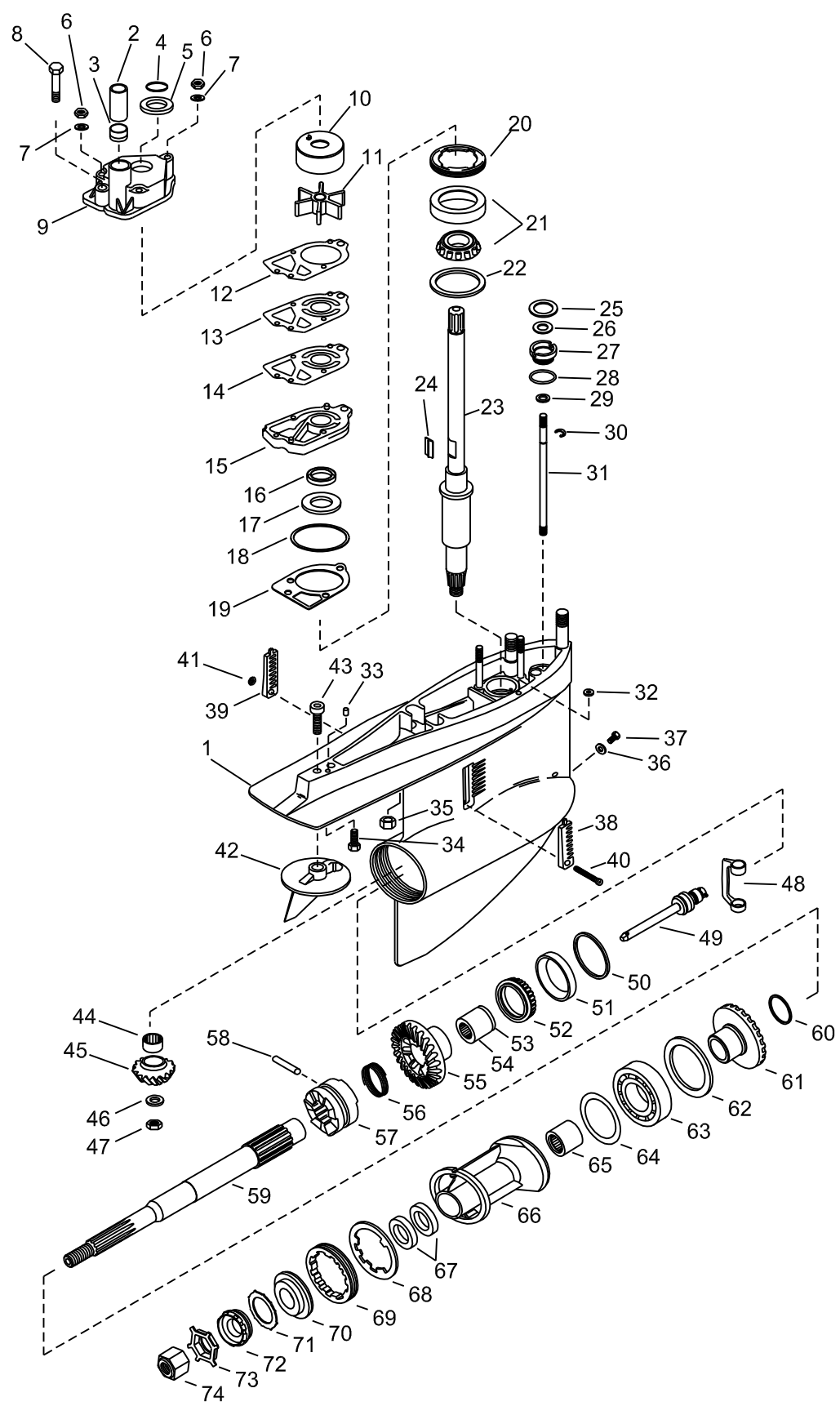

SEE PAGES 826-827 FOR COMPLETE REPLACEMENT HOUSINGS

Figure #	Description	Part #	OEM #	Qty.
1	Gear Housing	18-2401	1623-8951A37	1
2	Water Tube Guide	18-3109	23-29804	1
3	Bushing/Water Pump Housing	18-3110	26-38970	1
4	O-Ring, Upper Drive Shaft	18-7158	25-30613	1
5	Slinger	18-7426	25-30271	1
6	Stainless Steel Locknuts (5/16-24)	N/A	11-13436	1
	Stainless Steel Locknuts (1/4-28)	N/A	11-13438	2
7	Washer	18-4270	12-36001	3
8	Screw, Water Pump Body to Water Pump Base	N/A	10-96411	1
9	Upper Pump Housing	18-3116	46-96148A1	1
10	Insert Cup	18-3114	48752	1
11	Impeller	18-3017	47-89984	1
12	Gasket, Upper Water Pump to Wear Plate	18-2915	27-85609-1	1
13	Impeller Plate	18-3117	32435	1
14	Gasket, Wear Plate to Water Pump Base	18-2914	27-85608-1	1
15	Water Pump Base	18-3420	46-44292A3	1
16	Oil Seal (upper)	18-2013	26-16977	1
17	Oil Seal (lower)	18-2014	26-89238	1
18	O-Ring, Water Pump	18-7176	25-90011	1
19	Gasket, Water Pump Base to Gear Housing	18-2919	27-42631-1	1
20	Retainer, Drive Shaft Bearing	18-2346	824519	1
21	Tapered Roller Bearing Drive Shaft	18-1143	31-36387A1	1
22	Shim Kit, Lower Drive Shaft Bearing	18-2294	15-42637A1	1
23	Drive Shaft	18-2180	45-42634	1
24	Drive Key Water Pump Impeller	N/A	28-56654	1
25	Shift Shaft Washer	18-4267	12-29395	1
26	Washer Rubber Shift Shaft Bushing	18-2340	12-31266	1
27	Shift Bushing	18-2154	23-30617A2	1
28	O-Ring, Shift Shaft Bushing	18-7153	25-25439	1
29	Washer, Lower Shift Shaft	NSS	12-27880	1
30	Retaining Clip, Shift Shaft	NSS	53-29641	1
31	Stainless Steel Shift Shaft	18-2150	77481-1	1
32	Oil Passage Seal	18-2944	26-45577	1
33	Dowel Pin, Gear Housing to Drive Shaft Housing	18-3226	10-30720	2
34	Screw, Gear Housing to Drive Shaft Housing	18-2361	10-30206	1
35	Nut, Gear Housing to Drive Shaft Housing	18-2362	11-13439-1	2

Figure #	Description	Part #	OEM #	Qty.
36	Gasket, Gear Housing Drain Screw	18-2945	12-19183, 12-20260	1
37	Plug, Oil Fill/Drain	18-2244	10-79953A2	1
38	Insert, Water Pick (Stbd)	18-3199	93423-1	1
39	Insert, Water Pick (Port)	118-3198	93424-1	1
40	Screw, Insert to Gear Housing	18-3197	10-76156	1
41	Nut, Insert Screw	18-2344	11-45812	1
42	Trim Tab	18-6011	31640A1	1
43	Screw, Trim Tab Gear Housing	18-6245	10-32470	1
44	Pinion Bearing	18-1117	31-42647A1	1
45	Lower Alpha Gear Set (pinion gear)	18-2206	43-17064A2, 43-17064A3, 43-42934	1
46	Anti-Galling Washer Pinion Gear	18-2343	22-92721	1
47	Pinion Nut	18-3719	11-35921	1
48	Shift Crank	18-2130	76865	1
49	Shift Spool Assembly	18-2286	818349A1	1
50	Shim Kit, Forward Gear	18-2285	15-47397A1	1
51	Tapered Roller Bearing Set	18-1159	31-35928A1	1
52	Inner Bearing, Forward Gear	18-1157	31-30895	1
53	Retaining Clip, Inner Bearing	N/A	—	1
54		18-1157	31-30895	1
55	Lower Alpha Gear Set (Forward Gear/Pinion)	18-2206	43-17064A2, 43-17064A3, 43-42934	1
56	Spring, Retainer - Cross Pin	18-2348	24-30893	1
57	Sliding Clutch	18-2202	52-66063	1
58	Cross Pin, Clutch to Actuating Shaft	18-2357	24-30893	1
59	Propeller Shaft	18-2166	44-66060, 44-6606-3	1
60	Spacer, Reverse Gear	N/A	23-824108	1
61	Lower Alpha Gear Set (Reverse Gea-NSS)	18-2206	43-17064A2, 43-17064A3, 43-42934	1
62	Thrust Ring, Bearing Carrier	18-2342	68100-1	1
63	Ball Bearing	18-1155	30-88957A1	1
64	O-Ring, Bearing Carrier	18-7159	25-31534	1
65	Needle Roller Bearing	18-1158	31-30956	1
66	Bearing Carrier	18-2191	73020A-14	1
67	Oil Seals, Bearing Carrier	18-2002	26-76868	2
68	Tab Washer	18-2298	14-18323	1
69	Spanner Nut	18-3751	79448	1
70	Thrust Washer	18-4220	13171, 77987	1
71	Continuity Washer	N/A	13-423511	1
72	Brass Castle Washer	18-3714	12-31211A2	1
73	Tab Washer	18-3200	14-31210, 14-816629	1
74	Prop Nut	18-3700	11-52707	1

N/A Not Available

NSS Not Sold Separate



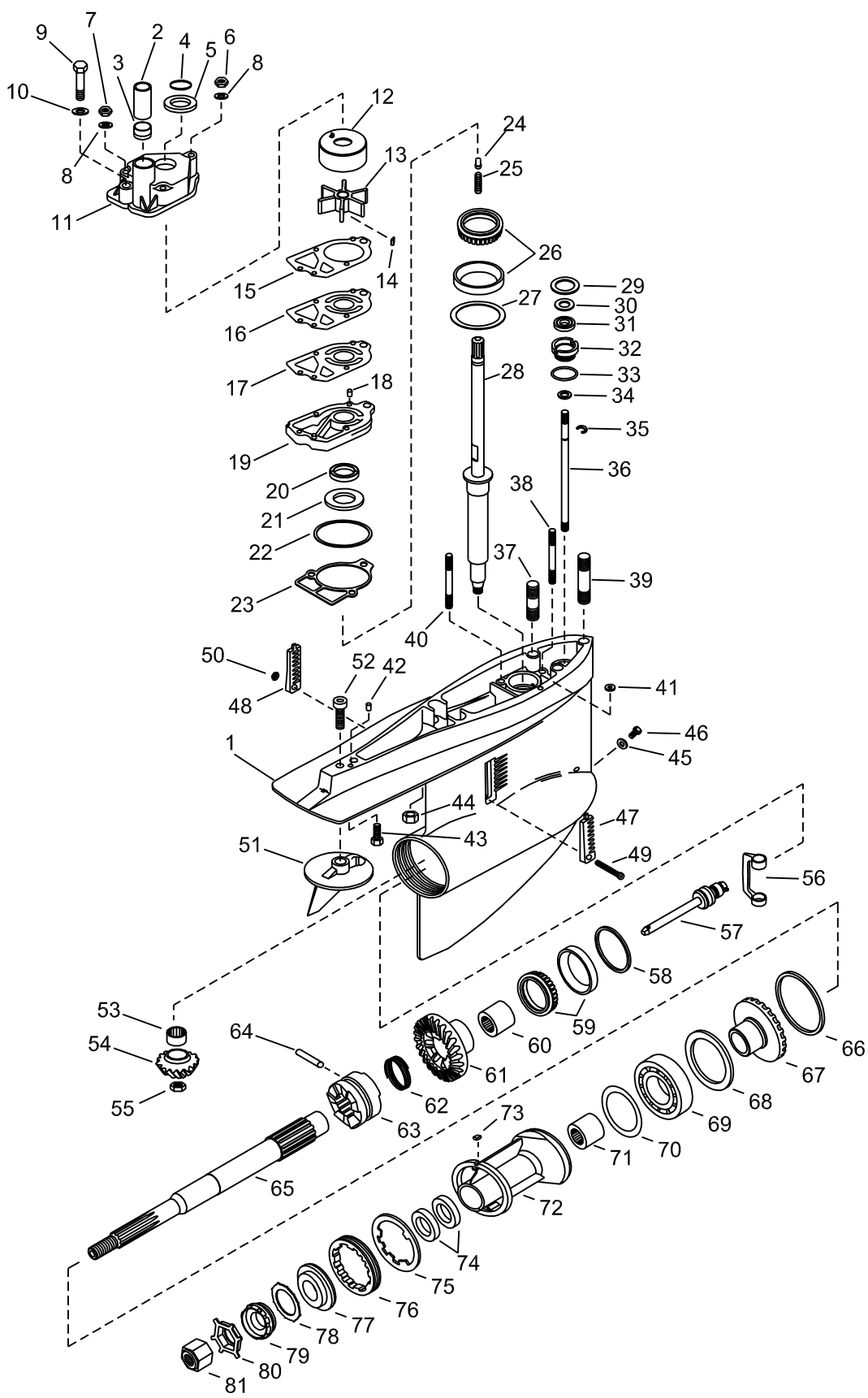

SEE PAGES 826-827 FOR COMPLETE REPLACEMENT HOUSINGS

Figure #	Description	Part #	OEM #	Qty.	Figure #	Description	Part #	OEM #	Qty.
1	Lower Gear Housing	N/A	1623-5356A4	1	41	Oil Passage Seal	18-2944	26-45577	1
2	Water Tube Guide	18-3109	23-29804	1	42	Dowel Pin, Gear Housing to Drive Shaft Housing	N/A	17-35973	2
3	Bush Water Pump Housing	18-3110	26-38970	1	43	Screw, Gear Housing to Drive Shaft Housing	18-2361	10-30206	1
4	O-Ring, Upper - Drive Shaft	18-7158	25-30613	1	44	Nut Gear Housing to Drive Shaft Housing	N/A	11-82671015	2
5	Slinger	18-7426	25-30271	1	45	Gasket, Gear Housing Drain Screw	18-2945	12-19183, 12-20260	1
6	Stainless Steel Locknuts (5/16-24)	18-3723	11-45592	1	46	Plug, Oil Fill/Drain	18-2244	10-79953A2	1
7	Stainless Steel Locknuts (1/4-28)	18-3722	11-20361, 11-35888	2	47	Insert, Water Pick (Stbd)	N/A	66885	1
8	Washer	18-4275	12-29245	3	48	Insert, Water Pick (Port)	N/A	66884	1
9	Screw	18-3226	10-30720	1	49	Screw Insert to Gear Housing	18-3197	10-76156	1
10	Washer, Water Pump Body	18-4270	12-36001	1	50	Nut, Insert Screw	18-2344	11-45812	1
11	Upper Pump Housing	18-3116	46-96148A1	1	51	Trim Tab	18-6011	31640A1	1
12	Insert Cup	18-3114	48752	1	52	Screw, Trim Tab to Gear Housing	18-6245	10-32470	1
13	Impeller	18-3017	47-89984	1	53	Needle Roller Bearing	18-1150	31-92366A1	1
14	Drive Key	N/A	28-56654	1	54	Lower Unit Gear Set (pinion gear)	18-2200	23-96084A4	1
15	Gasket, Upper Water Pump to Wear Plate (upper)	18-2915	27-85609-1	1	55	Pinion Nut	18-3719	11-35921	1
16	Impeller Plate	18-3117	32435	1	56	Shift Crank	18-2130	76865	1
17	Gasket, Upper Water Pump to Wear Plate (lower)	18-2914	27-85608-1	1	57	Shift Spool Assembly	19755A2	18-2286	1
18	Dowel Pin	18-3227	17-35973	2	58	Shim Kit, Forward Gear Bearing	18-2285	15-47397A1	1
19	Water Pump Base	18-3417	46-57234A1	1	59	Tapered Roller Bearing	18-1159	31-35928A1	1
20	Oil Seal (upper)	18-2026	26-16977	1	60	Needle Roller Bearing	18-1157	31-30895	1
21	Oil Seal (lower)	18-2014	26-89238	1	61	Lower Unit Gear Set (Forward)	18-2200	23-96084A4	1
22	O-Ring (2.175 ID) & (2.1091 ID)	18-7176, 18-7196	25-90011	1	62	Spring, Retainer, Cross Pin	18-2348	24-30893	1
23	Gasket, Water Pump Base to Gear Housing	18-2826	27-85610-1	1	63	Sliding Clutch	18-2202	52-66063	1
24	Pin, Driveshaft	N/A	17-30545	1	64	Cross Pin, Clutch to Clutch Actuating Shaft	18-2348	17-30632	1
25	Spring	N/A	24-34576	1	65	Propeller Shaft	18-2166	44-66060, 44-66060-3	1
26	Tapered Roller Bearing	N/A	31-53079A1	1	66	Shim Kit, Thrust Ring to Gear Housing	18-2284	15-31535A1	1
27	Shim Kit, Drive Shaft Bearing	18-2295	15-57007A	1	67	Lower Unit Gear Set (reverse)	18-2200	43-96084A4	1
28	Drive Shaft	N/A	45-41939A1	1	68	Thrust Ring, Bearing Carrier	18-3759	35915	1
29	Shift Shaft Washer	18-4267	12-29395	1	69	Ball Bearing	18-1155	30-88957A1	1
30	Washer, Rubber Shift Shaft Bushing	18-2340	12-31266	1	70	O-Ring	18-7159	25-31534	1
31	Oil Seal	26-89236	18-2009	1	71	Needle Roller Bearing	18-1158	31-30956	1
32	Shift Bushing	18-2154	23-30617A2	1	72	Bearing Carrier Assembly	18-2191	73020A14	1
33	O-Ring	18-7153	25-25439	1	73	Key, Locating - Bearing Carrier	N/A	28-30281	1
34	Washer, Lower Shift Shaft Bushing	N/A	12-27880	1	74	Oil Seals	18-2002	26-76868	2
35	Retaining Clip, Shift Shaft	18-4295	53-29641	1	75	Tab Washer	18-2299	14-79447	1
36	Stainless Steel Shift Shaft	18-2150	77481-1	1	76	Spanner Nut	18-3751	79448	1
37	Stud, Gear Housing to Drive Shaft Housing (1-31/32")	N/A	16-56298	2	77	Thrust Washer	18-4220	13171, 77987	1
38	Stud, Water Pump to Gear Housing (3 - 3/8")	N/A	16-562972	1	78	Continuity Washer	NSS	13-423511	1
39	Stud, Gear Housing to Drive Shaft Housing (3 - 3/16")	N/A	16-46911	1	79	Brass Castle Washer	18-3714	12-31211A2	1
40	Stud, Water Pump to Gear Housing (3 - 1/4")	N/A	16-69501	2	80	Tab Washer	18-3200	14-31210, 14-816629	1
					81	Prop Nut	18-3700	11-52707	1

AR As required NSS Not Sold Separate



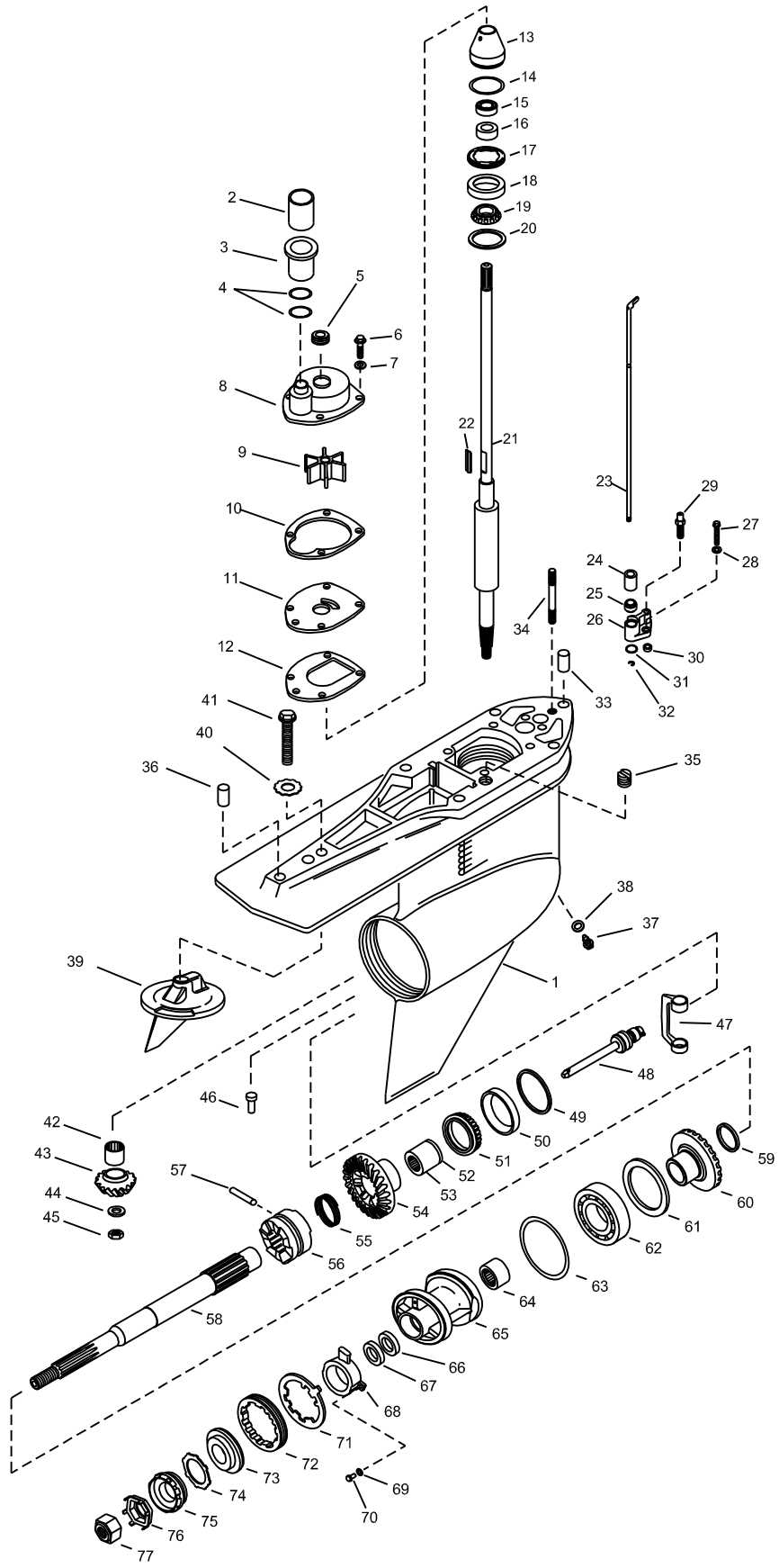

SEE PAGES 826-827 FOR COMPLETE REPLACEMENT HOUSINGS

Figure #	Description	Part #	OEM #	Qty.
1	Gear Housing	18-2415	1623-815822A36	1
2	Sleeve	—	23-816573	1
3	Coupling	18-3151	816597A1	1
4	O-Rings	18-7420	25-21836	2
5	Face Seal	18-2599	26-816575A2	1
6	Screw, 10-32 X 5/8	NSS	10-816928	4
7	Star Washer	NSS	13-69432	4
8	Water Pump Body	18-3147	817275A1	1
9	Impeller	18-3056	47-43026-2	1
10	Gasket	18-2563	27-817277	1
11	Face Plate	18-3122	817276	1
12	Gasket	18-2564	27-43033-1	1
13	Seal Carrier	18-2354	821759A2	1
14	O-Ring	18-7176	25-90011	1
15	Seal	18-2013	26-16977	1
16	Seal	18-2014	26-89238	1
17	Cover Nut	18-2346	824519	1
18 & 19	Bearing, Upper Driveshaft (1.50-1.65 Ratio)	18-1143	31-36387A1	1
20	Shim Kit	18-2294	15-42637A1	1
21	Drive Shaft (1:47 & 1:62)	18-2331	45-853648	1
	Drive Shaft (1:50 & 1:65)	18-2261	45-816919	1
	Drive Shaft (1:84 & 1:98) (Early Style use with 18-1143)	—	45-816472	1
22	Impeller Drive Key	18-3293	28-43037	1
23	Shift Shaft	18-2320	815919A1	1
24	Sleeve	18-2349	23-67370	1
25	Seal	18-2009	26-89236	1
26	Shift Rod Bushing Assembly	18-2353	23-815921A21	1
27	Screw, 10-32 X 5/8	NSS	10-806290	2
28	Star Washer	NSS	13-69432	2
29	Speedometer Pickup Fitting	—	NSS	1
30	O-Ring	18-7440-1	25-36318	1
31	O-Ring	18-7440-1	25-36318	1
32	Retaining Ring	18-4295	53-29641	1
33	Dowel Pin	—	17-43044	1
34	Stud, Mounting	—	16-57984	1
35	Seal	18-2944	26-45577	1
36	Dowel Pin	—	17-43044	1
37	Plug	18-2375	22-67892A1	1
38	Gasket	18-2945	12-19183	1

Figure #	Description	Part #	OEM #	Qty.
39	Trim Tab	18-6016	76214A5	1
40	Washer, Anode Mounting	—	13-806210	1
41	Bolt, Anode Mounting	—	10-806327	1
42	Pinion Bearing	18-1117	31-42647A1	1
43	Pinion Gear	18-2206	43-828072A2	1
44	Washer	18-2343	12-92721	1
45	Nut	18-3719	11-35921	1
46	Pin	—	17-37972-1	1
47	Shift Crank	18-2130	76865	1
48	Shift Spool Assembly	18-2286	818349A1	1
49	Shim Kit	18-2285	15-47397A1	1
50 & 51	Forward Gear, Outer Bearing	18-1159	31-35928A1	1
52	Retaining Clip, Inner Bearing	NSS	—	1
53	Forward Gear, Inner Bearing	18-1157	31-30895	1
54	Forward Gear	18-2206	43-828072A2	1
55	Cross Pin Spring	18-2348	24-30893	1
56	Sliding Clutch	18-2202	52-824112	1
57	Cross Pin	18-2357	17-30632	1
58	Propeller Shaft	18-2166	44-824110	1
59	Spacer	—	23-824108	1
60	Reverse Gear	18-2206	43-828072A2	1
61	Thrust Ring	18-2342	681001	1
62	Ball Bearing	18-1155	30-88957A1	1
63	O-Ring	18-7159	25-31534	1
64	Roller Bearing	18-1158	31-30956	1
65	Bearing Carrier	18-2376	818763A10	1
66	Seal	18-2002	26-14077	1
67	Seal	18-2076	26-12224	1
68	Carrier Anode	18-6093	806105A1	1
69	Lockwasher, Anode Mounting	—	13-69432	2
70	Bolt, Anode Mounting	—	10-806290	2
71	Tab Washer	18-2298	14-18323	1
72	Cover Nut	18-3751	79448	1
73	Thrust Hub	18-4220	13171	1
74	Continuity Washer	NSS	13-42351-1	1
75	Splined Washer	18-3714	12-31211A2	1
76	Tab Washer	18-3200	14-31210	1
77	Propeller Nut	18-3700	11-52707	1
	Seal Kit (Not Pictured)	18-2646-1	26-816575A3	1

NSS Not Sold Separate





18-2292 SHIM KIT
 Drive Gear
 Replaces: 15-35980A1
 Contains (1) each .002, .003, .005, .006, .010, .025
 For: Mercuriser Vazer



18-2293 SHIM KIT
 Upper Bearing
 Replaces: 15-36178A1, 15-36178A02, 15-39899A1, 15-23097A1
 Contains (1) each .002, .003, .015 (2) each .010
 For: Mercuriser Vazer

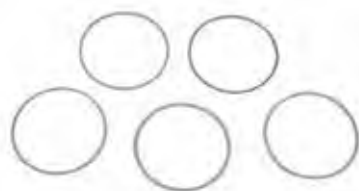

18-2294 SHIM KIT
 Lower Drive Shaft Bearing
 Replaces: 15-8M0063267, 15-42637A1
 Contains (1) each .002, .003, .005, .010, .020
 For: Mercuriser Vazer



18-2295 SHIM KIT
 Lower Drive Shaft Bearing
 Replaces: 15-57007A1, 15-33143A1
 Contains (1) each .002, .003, .005, .010, .020
 For: Mercuriser Vazer

SHIMS

Part No.	Size	O.E. #
18-0208	.208	23-1761515 ⑥
18-0210	.210	23-1761516 ⑥
18-0212	.212	23-1761517 ⑥
18-0214	.214	23-1761518 ⑥
18-0216	.216	23-1761519 ⑥
18-0218	.218	23-1761520 ⑥
18-0230	.230	23-1761526 ⑥
18-0222	.222	23-1761522 ⑥
18-0224	.224	23-1761523 ⑥
18-0226	.226	23-1761524 ⑥



Part No.	Size	O.E. #
*18-2282	Kit	15-32563A1 • For: Mercuriser Vazer
*18-2283	Kit	15-45691A1
*18-2284	Kit	15-31535A1
*18-2285	Kit	15-35931A1, 15-47397A1
*18-2296	.055	15-71013, 15-45811

- * 18-2282 (1) each .002, .003, .005, .010, .025
- * 18-2283 (1) each .002, .003, .005, .010
- * 18-2284 (1) each .002, .003, .005, .010, .020
- * 18-2285 (1) each .002, .003, .005, .010, .020

SHIM KIT APPLICATION

HP	Serial No.	Bearing to Top Cover Kit	Bearing Cup to Drive Shaft Housing	Drive Gear	Drive Gear Spacer	Drive Shaft Bearing to Gear Housing	Reverse Gear	Forward Gear Kit
120/140	2062141 thru 2791956	18-2282 ②	18-2293	18-2292	18-2296	18-2295	18-2284 ⑤	18-2285
120/140	2791957 thru 4893634	18-2283 ④	18-2293	18-2292	18-2296	18-2295	18-2284 ⑤	18-2285
120/140	4893635 thru 6225576	18-2283	18-2293	18-2292	18-2296	18-2295	—	18-2285
160	2065190 thru 2763441	18-2282 ②	18-2293	18-2292	18-2296	18-2295	18-2284 ⑤	18-2285
165	2763442 thru 4890459	18-2283 ④	18-2293	18-2292	18-2296	18-2295	18-2284 ⑤	18-2285
165	4890460 & UP	18-2283	18-2293	18-2292	18-2296	18-2295	—	18-2285
888	3106717 & UP	18-2283 ③	18-2293	18-2292	18-2296	18-2295	18-2284 ⑤	18-2285
898/228	4782330 thru 4898729	18-2283	18-2293	18-2292	18-2296	18-2295	18-2284 ⑤	18-2285
898/228	4898730 thru 6225576	18-2283	18-2293	18-2292	18-2296	18-2295	—	18-2285
225-S	3856268 thru 4200499	18-2283	18-2293	18-2292	18-2296	18-2295	18-2284 ⑤	18-2285
233	4200500 & UP	18-2283	18-2293	18-2292	18-2296	18-2295	18-2284 ⑤	18-2285
250	4791300 thru 4898729	18-2283	18-2293	18-2292	18-2296	18-2295	18-2284 ⑤	18-2285
260	4898730 thru 6225576	18-2283	18-2293	18-2292	18-2296	18-2295	—	18-2285
470	4208730 thru 4893934	18-2283	18-2293	18-2292	18-2296	18-2295	18-2284 ⑤	18-2285
470	4893835 thru 6225576	18-2283	18-2293	18-2292	18-2296	18-2295	—	18-2285
485	4893835 & UP	18-2283	18-2293	18-2292	18-2296	18-2295	—	18-2285
R/MR/Alpha One	6225577 & UP (R)	18-2283	18-2293	18-2292	18-2296	18-2295	—	18-2285
R/MR/Alpha One	6225577 & UP (MR)	18-2283	18-2293	18-2292	18-2296	18-2294	⑥	18-2285
Alpha Gen II	D494569 thru F679999	18-2283	18-2293	18-2292	18-2296	18-2294	⑥	18-2285
Alpha Gen II	F680000 & UP	18-2282		18-2293	18-2292	18-2296	18-2294 ⑥	—

② S/N #2187468 & Below use 18-2293 ③ S/N #4433200 & UP Only ④ S/N #4530702 & UP Only ⑤ Kit ⑥ For Counter Rotation Only

18-2400 COMPLETE LOWER GEAR CASE
 Replaces: 1623-815822A53, 1623-815822A5, 1623-815822A32, 1623-815822A3
 For: Ratios 1.47, 1.62, 1.81 & 1.94
 Fits: Gen II (1998 & up) 0L100040 & up



18-2411 DRIVE SHAFT HOUSING ASSEMBLY
 Replaces: 1547-861063A4
 For: Gen II Upper (1998-up), 0L100040-up, 1.47:1 Ratio/Gen II Upper (1998-up) 0L100040-up, 1.62/2.00:1 Ratio's/Gen II Upper (1998-up), 0L100040-up, 1.81:1 Ratio/Gen II Upper (1998-up), 0L100040-up, 1.94/2.40:1 Ratios
 Used with: 18-2416, 18-2419 Complete Upper Gear Cases





18-2415
GEAR HOUSING ASSEMBLY
Replaces: 1623-815822A36
For: Ratios 1.47, 1.62
 Gen II (1998 & up), (OL100040 & up)
 Used with: 18-2400 Complete Lower Gear Case



18-2416
COMPLETE UPPER GEAR CASE
Replaces: 1547-815930A16, 1547-815930A6, 1547-861063A12
For: Alpha Gen II (1991 & UP) for gear ratios 1.47:1, 1.50:1
 Used with 18-2411 Drive Shaft Housing Assembly



18-2419
COMPLETE UPPER GEAR CASE
Replaces: 1547-815930A13, 1547-815930A3, 1547-861063A6
For: Alpha Gen II (1991 & UP) for gear ratios 1.98:1, 2.40:1
 Used with 18-2411 Drive Shaft Housing Assembly



18-2450
COMPLETE UPPER GEAR CASE
Replaces: 1547-9412A20, 1547-3917A13, 1547-3917A21, 1547-3917A32, 1547-3917A37, 1547-5523A2, 1547-5523A9, 1547-5523A12, 1547-5523A68, 1547-8265A15, 1547-9412A30, 1547-9412A35
For: Alpha I
 1.5:1/1.47:1



18-2451
COMPLETE UPPER GEAR CASE
Replaces: 1547-9412A21, 1547-3917A4, 1547-3917A8, 1547-3917A16, 1547-3917A30, 1547-3917A38, 1547-5523A8, 1547-5523A11, 1547-8265A16
For: Alpha I
 1.65:1/1.62:1



18-2452
COMPLETE UPPER GEAR CASE
Replaces: 1547-9412A22, 1547-5523A67, 1547-8265A17, 1547-9412A36
For: Alpha I
 1.84:1/1.81:1



18-2453
COMPLETE UPPER GEAR CASE
Replaces: 1547-9412A23, 1547-5523A49, 1547-5523A67, 1547-8265A17
For: Alpha I
 1.98:1/1.94:1



18-2443
COMPLETE LOWER GEAR CASE
Replaces: 1623-8951A43, 1623-4110A4, 1623-4110A6, 1623-4110A13, 1623-5356A3, 1623-5356A18, 1623-5356A19, 1623-5356A20, 1623-8951A2, 1623-8951A14, 1623-8951A19, 1623-8951A23
For: R/MR/ALPHA 1



18-2401
LOWER GEAR HOUSING
Replaces: 1623-8951A27, 1623-8951A37, 1623-8951A5, 1623-8951A15
For: MR/ALPHA Style
 Bore size 3.2635-3.2650. Includes tapered roller bearing for non-tractor 14/28 or 17/28 gears. When installing new gears use 18-2206-1 gear kit which includes tapered roller bearing 18-1156 for tractor 13/21 gears.



18-2402
LOWER GEAR HOUSING
Replaces: 1623-5356A4
For: R Style



18-2368
LOWER GEARCASE KIT
 Replaces: 43-803069T1
 ALPHA/Gen II 1991-95



18-2369
LOWER GEARCASE KIT
 Replaces: 43-803069T1
 ALPHA/Gen II 1991-95



18-2358
UPPER UNIT GEAR REPAIR KIT
 Replaces: 43-803102T1
 For: 20-22 Teeth: 1.50:1 (1.47:1)
 Gen II applications serial number range up to OK999999 only



18-2363
UPPER UNIT GEAR REPAIR KIT
 Replaces: 43-803118T1
 For: 20-24 Teeth: 1.98:1 (1.94/2.40:1)
 Gen II applications serial number range up to OK999999 only



18-2364
UPPER UNIT GEAR REPAIR KIT
 Replaces: 43-803119T1
 For: 24-24 Teeth: 1.65:1 (1.62:1)
 Gen II applications serial number range up to OK999999 only



18-2365
UPPER UNIT GEAR REPAIR KIT
 Replaces: 43-803120T1
 For: 17-19 Teeth: 1.84:1 (1.81:1)
 Gen II applications serial number range up to OK999999 only



18-6350K
UPPER UNIT GEAR REPAIR KIT
 Replaces: 43-803104T1
 For: Gen II (1998 & Up)(S/N OL100040 & Up)
 1.62:1 and 2.00:1 Ratio



18-6351K
UPPER UNIT GEAR REPAIR KIT
 Replaces: 43-803103T1
 For: Gen II (1998 & Up)(S/N OL100040 & Up)
 1.47:1 Ratio



18-6352K
UPPER UNIT GEAR REPAIR KIT
 Replaces: 43-803106T1
 For: Gen II (1998 & Up)(S/N OL100040 & Up)
 1.94:1 and 2.40:1 Ratio



18-6353K
UPPER UNIT GEAR REPAIR KIT
 Replaces: 43-803105T1
 For: Gen II (1998 & Up)(S/N OL100040 & Up)
 1.81:1 Ratio



**18-2204
UPPER UNIT GEAR SET**
Replaces: 43-75325A3, 43-75325A2
(1.84:1 Ratio)
(Drive Gear = 17 teeth Driven Gear = 19 teeth)
For: V-6 and 470/485 (4 Cyl. etc.) and Gen II
(S/N K999999 & BELOW)



**18-2205
UPPER UNIT GEAR SET**
Replaces: 43-55778A3, 43-55766A2, 43-55766A3
(1.98:1 Ratio)
(Drive Gear = 20 teeth Driven Gear = 24 teeth)
For: 120/140 (S/N 2791957 & UP) and Gen II
(S/N K999999 & BELOW)



**18-6350
UPPER UNIT GEAR SET**
Replaces: 43-853640A2, 43-821823A1
For: Gen II Upper (1998-up), 0L100040-up,
1.62/2.00:1 Ratios (24-24 Teeth)



**18-2201
UPPER UNIT GEAR SET**
Replaces: 43-18410A2, 43-18411A2, 43-59832A2, A4
Includes: (1) 18-1142
Mercuriser #31-32573A1
(1.5:1 Ratio)
(Drive Gear = 22 teeth Driven Gear = 20 teeth)
For most V-8 Drives and Gen II (S/N K999999 & BELOW)

Stern Drive Model	Beg. S/N	End. S/N
225	3856268	4200499
260	4898730	6225576
898/228	4782330	6225576
Stern Drive Model	Beg. S/N	End. S/N
888	3106717	& UP
V8R/MR/AlphaOne	6225577	& UP



**18-2203
UPPER UNIT GEAR SET**
Replaces: 43-45814A5, 43-55765A2, 43-55765A3
(1.65:1 Ratio) (Drive Gear = 24 teeth
Driven Gear = 24 teeth)
For: 6 Cyl. Inline S/N K999999 & BELOW



**18-6351
UPPER UNIT GEAR SET**
Replaces: 43-853641A2
For: Alpha I (Gen II) (1998-up), 0L100040-up,
1.47:1 Ratio (20-22 Teeth)
Used with: 18-2416 Complete Upper Gear Case



**18-6352
UPPER UNIT GEAR SET**
Replaces: 43-853642A2
For: Alpha I (Gen II) (1998-up), 0L100040-up,
1.94:1, 2.40:1 Ratios (20-24 Teeth)
For: Mercuriser Vazer
Used with: 18-2411 Drive Shaft Housing Assembly,
18-2419 Complete Upper Gear Case



**18-6353
UPPER GEAR KIT**
Replaces: 43-853643A2
1.81 Ratio Upper Gear Set, 17-19 Teeth
For: Alpha I Gen II 1998-up/0L00040-up
For: Mercuriser Vazer

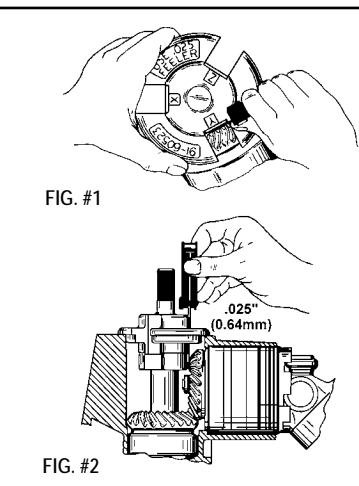

FIGURES #1 - #2
Provides two separate views of the upper gear housing driven gear being properly shimmed using the Sierra installation tools.

FIGURES #3 - #4
Provides the same views of the drive gear being shimmed in the same application.

NOTE:
This installation **cannot** be performed correctly without the Sierra 18-9856 shim tool. Improper installation **will** result in gear failure. The .025 referenced in FIG #2 & FIG #4 is achieved when .026 will not fit the clearance but .025 will.

A service manual should always be consulted for step-by-step instructions.

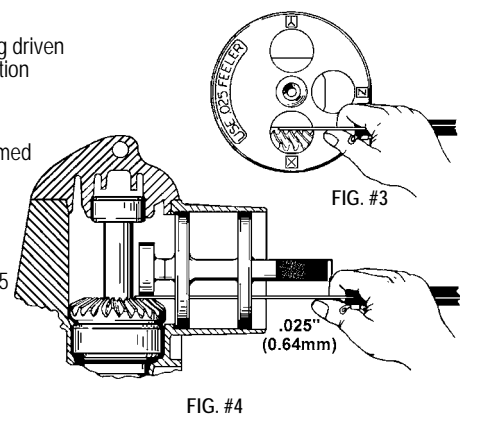

**18-2256
UPPER GEAR KIT**
Replaces: 43-803116T1
Most V-8 Drives (1.5:1 Ratio)

— CONTAINS —

Part #	Description	O.E. #	Qty.
18-2201	Upper Unit Gear Set	43-18410A2	1
18-2648	Seal Kit	26-32511A2	1
18-2619-1	Outdrive Gasket Set	27-94996A1	1
18-2820	Drive Shaft Housing to Bell Housing Gasket	27-64818	1
18-2743	Drive Shaft Housing to Bell Housing Gasket	27-94996-2	1
18-1160	Bearing	31-35988A2	1
18-1165	Bearing	31-61100A1	1
18-1142	Bearing	31-35990A1	1

— CONTAINS —

Part #	Description	O.E. #	Qty.
18-2203	Gear Set	43-45814A5	1
18-2648	Seal Kit	26-32511A2	1
18-2619-1	Outdrive Gasket Set	27-94996A1	1
18-2820	Drive Shaft Housing to Bell Housing Gasket	27-64818	1
18-1160	Bearing	31-35988A2	1
18-1161	Bearing	31-35990A1	1
18-1165	Bearing	31-61100A1	1
18-2743	Drive Shaft Housing to Bell Housing Gasket	27-94996-2	1

**18-2257
UPPER GEAR KIT**
Replaces: 43-803112T1
6 Cyl. Inline (1.65:1 Ratio)



— CONTAINS —

Part #	Description	O.E. #	Qty.
18-2204	Gear Set	43-75325A3	1
18-2648	Seal Kit	26-32511A2	1
18-2619-1	Outdrive Gasket Set	27-94996A1	1
18-2820	Drive Shaft Housing to Bell Housing Gasket	27-64818	1
18-1160	Bearing	31-35988A2	1
18-1161	Bearing	31-35990A1	1
18-2743	Drive Shaft Housing to Bell Housing Gasket	27-94996-2	1
18-1165	Bearing	31-61100A1	1

**18-2258
UPPER GEAR KIT**
Replaces: 43-803114T1
V-6 (470/485) (1.84:1 Ratio)



— CONTAINS —

Part #	Description	O.E. #	Qty.
18-2205	Gear Set	43-55778A3	1
18-2648	Seal Kit	26-32511A2	1
18-2619-1	Outdrive Gasket Set	27-94996A1	1
18-2820	Drive Shaft Housing to Bell Housing Gasket	27-64818	1
18-1160	Bearing	31-35988A2	1
18-1161	Bearing	31-35990A1	1
18-1165	Bearing	31-61100A1	1
18-2743	Drive Shaft Housing to Bell Housing Gasket	27-94996-2	1

**18-2259
UPPER GEAR KIT**
Replaces: 43-803101T1
120/140 (1.98:1 Ratio)



**18-2125
YOKE**

Replaces: 39384, 46020, 460201, 46020T, 4602002, 46020002
Fits all #1/ALPHA Units (S/N 1684188 - OK999999)



**18-2146
YOKE**

Replaces: 20175, 59830A1, 59830A7
Fits all #1, R, MR, Alpha I, Alpha I Gen II, Bravo & Blackhawk



**18-6400
YOKE**

Replaces: 12784, 12784T
For: Bravo (OM111207 & below) and Blackhawk



**18-6401
YOKE ASSEMBLY**

Replaces: 12784A10, 12784A4
For: Bravo I, II, III (OB664190 - up) (1998-05)



**18-9218
YOKE ASSEMBLY**

Replaces: 814819A2, 59830A5, 59829A1
For all #1, R/MR/ALPHA Gen II
OK999999 & Below (1971-97)



**18-2128
CENTER SOCKET**

Replaces: 39383, 39383T, 393831 (Rockwell)
Fits IA/IB/IC & EZ, MC-I, R, MR, Alpha One, Gen II (OL949778 & below), Bravo (OM111207 & below), MC II & TS



**18-6404
CENTER SOCKET**

Replaces: 865503T
Fits: Alpha I Gen II 0L949779 & UP, (GKN style)



**18-1711
U-JOINT**

Replaces: 862132, 862132T
For: Bravo One, Two, & Three (All Ratios), Bravo One X/Two X, Three X (All Ratios), Bravo One XR/XZ(All Ratios), Bravo One XR Sportmaster (All Ratios) & Integrated Transom



**18-2097
U-JOINT**

Permalube
Replaces: 8055361, 805536A1, 805536A2
For: Generation II F680000 & UP





**18-2104
U-JOINT**
Heavy Duty
Replaces: 75832, 75832A2, 75832T, 758321, 75832T1, 75832A1, 75832A3, 58749, 41431, 36312
Includes both straight and 90° grease fitting.
Fits all #1 and ALPHA I Units S/N 1684188-B418818. Also TR/TRS and II SSM.



**18-2174
U-JOINT**
Heavy Duty
Replaces: 36312, 41431, 58749, 75832, 75832T, 75832A1, 75832A2, 75832A3, 758321, 75832T1
Includes both straight and 90° grease fitting.
Fits ALPHA I Units S/N B418819 & above. Also fits ALPHA I SS & BRAVO



**18-6406
U-JOINT ASSEMBLY**
Replaces: 865496A01, 865493A01, 865510T, 865496A01, 865511T
GKN new style with external clips.
Fits: Alpha I Gen II 0L949779 & UP, Bravo 0M111208 & UP
For: Mercruiser Vazer



**18-8311
GIMBAL HOUSING REBUILD KIT**
Fits: Alpha One



**18-8312
GIMBAL HOUSING REBUILD KIT**
Fits: Gen II



**18-8313
GIMBAL HOUSING REBUILD KIT**
Fits: Bravo



**18-21001
GIMBAL BEARING**
Replaces: 30-60794A2, 30-60794A4, 30-879194A02
Non Greasable
Fits: MC-1, R, MR and Alpha(1974-97), Gen II(1991-97), Bravo I/II/III (1988-95)



**18-21006
GIMBAL BEARING**
Non Greasable
Replaces: 30-862540T1, 30-862540A3, 30-862540A4, 30-879194A01
Fits: Gen II (1998-10), Bravo I/II/III & X/XR/XZ (1996-10)



**18-21005
GIMBAL BEARING**
Replaces: 30-862540A3, 30-862540T1, 30-862540A04, 30-879194A01
Greasable
Fits: All Bravos, Alpha One Gen II (1998-up)



**18-21005K
SEAL & GIMBAL BEARING KIT**
Replaces: 30-862540A3, 30-862540T1, 30-862540A04, 30-879194A01
Greasable
Contains (1) each of 18-2094 & 18-21005
Fits: Gen II (1998-Up) and all Bravo



**18-2101
GIMBAL BEARING**
Replaces: 30-36418, 30-36056, 36147
Greasable
(Link-Belt)



**18-2100
HEAVY DUTY GIMBAL BEARING**
Replaces: 30-60794A4, 30-60794A2, 30-879194A02
Greasable
(Link Belt)
Fits: Mercruiser- 120HP / 140HP (2791957-6225576) (With Gimbal Trim Sender), 165HP (2763442 & Up), 225S (3856268-4200499), 228HP (4782330 & Up), 233HP (4200500 & Up), 250HP (4791300 & Up)



**18-2100K
SEAL & GIMBAL BEARING KIT**
Replaces: 30-60794A2, 30-60794A4, 30-879194A02
Greasable
Contains (1) each of 18-2094 & 18-2100
Fits: 1, R, MR and Alpha (1974-97)



**18-73131
SWIVEL GIMBAL RING SHAFT**
Replaces: 98230A1
Fits: Mercruiser Alpha/Gen II/Bravo I/II/III & Vazer



**18-1705
HINGE PIN**
Replaces: 77123, 77123A1, 65547
For gimbal housing
Fits: Alpha, Alpha Gen II S/N 0M815638 & Lower



**18-1706
HINGE PIN**
Replaces: 10-86801
For gimbal housing
Fits: Alpha Gen II S/N 0M85639 & UP
Bravo All Models with trim sender

GIMBAL BEARING APPLICATION

Model	Year Range	Serial No. Range	Gimbal Bearing	Model	Year Range	Serial No. Range	Gimbal Bearing
I	1963	1534570-1684187	30-32537T	250 / 260	1977-1982	1791300-6225576	18-21001
IA	1964	1684186-1777798	18-2101	R / MR / ALPHA I	1983-1990	6225577 & UP	18-21001
IB	1964	1684188-1777798	18-2101	ALPHA I SS	1986-1989	A545004 & UP	18-21001
IC	1964	1684188-1777798	18-2101	ALPHA I GEN II	1991-1997	D469859-K999999	18-21001
EZ-SHIFT	1964	1684188-1777798	18-2101	ALPHA I GEN II	1998-2010	L100040 & UP	18-21001
120 / 140	1967-1973	2062141-3780849	18-2101	BRAVO I	1988-1995	B664190-F729999	18-21001
120 / 140	1974-1982	3780850-6225576	18-21001	BRAVO II	1988-1995	B664190-F729999	18-21001
470 / 485	1976-1982	4208730-6225575	18-21001	BRAVO III	1988-1995	B664190-F729999	18-21001
160 / 165	1967-1973	2065190-3780849	18-2101	BRAVO I	1996-2010	F730000 & UP	18-21006
165	1974-1981	3780850 & UP	18-21001	BRAVO II	1996-2010	F730000 & UP	18-21006
888	1971-1973	3106717-3784374	18-2101	BRAVO III	1996-2010	F730000 & UP	18-21006
888	1974-1977	3784375 & UP	18-21001	X / XR / XZ	1996-2010	F730000 & UP	18-21006
225 / 233	1974	3856268 & UP	18-21001	BLACKHAWK	1994-1995	F186717 & UP	18-21001
898 / 228	1977-1982	4782330-6225576	18-21001	II	1964-1969	1602186-2671321	18-2101

 <p>18-2381 UPPER DRIVE UNIT CAP Replaces: 94998A1, 94998A2, 94998A3, 94998A4 S/N 6225577 & Later Alpha I, except Gen II</p>	 <p>18-2382 UPPER DRIVE UNIT CAP Replaces: 828692A1, 18312A3 For: Gen II S/N F680000 & UP</p>	 <p>18-3752 RETAINING NUT Replaces: 8168111, 8168112, 66071, 35992</p>	 <p>18-4296 SPACER RING Replaces: 35983 (Upper Housing)</p>
 <p>18-0577 CARRIER OIL SEAL ASSEMBLY Replaces: 66081A2, 35993A1, 66081A1, 66081A4</p>	 <p>18-3219 WATER TUBE & COVER ASSEMBLY Replaces: 32489, 32489A2, 42724A3 For: Merc I and Alpha I drives Models: I, 1A, 1B, 1C, 1CEZ, 120, 140, 160, 165, 888, 898, 228, 225-S, 233, 250, 260, 470, 485, R, MR, Alpha 18-3229 Bolt Replaces: 10-28668</p>	 <p>18-2322 SHIFT SHAFT Replaces: 62104, 621041 For: I and Alpha I</p>	 <p>18-2169 SHIFT ARM Replaces: 45589A1, 45589A3</p>
 <p>18-3749 UPPER SHIFT SHAFT Replaces: 816685 For: Alpha Gen II (1991-98)</p>	 <p>18-2599 FACE SEAL & TOOL Replaces: 26-816575A2 For: ALPHA I GENERATION II</p>	 <p>18-2622 BELL HOUSING BUSHING KIT Replaces: 23-79373A1, 23-805041A2, 27-45588, 27-79373</p>	 <p>18-3760 BELL HOUSING BUSHING KIT Replaces: 23-806036A1 For: GEN II Serial # F680000 & UP</p>
 <p>18-2179 DRIVE SHAFT Replaces: 45-55796</p>	 <p>18-2324 DRIVE SHAFT Replaces: 45-557961 For: Gen II (S/N F680000 & UP), Mercuriser Vazer</p>	 <p>18-3713 LOCK NUT Replaces: 11-22339, 11-97522, 11-36084, F1348, F1881 5/8" - 18</p>	 <p>18-3712 CARRIER NUT WASHER Replaces: 12-45810</p>
 <p>18-2161 SHIFT ARM Replaces: 45518A1, 45518A2, 45518A3</p>	 <p>18-2170 SHIFT ARM SCREW Replaces: 10-45590, 10-8M0084649</p>	 <p>18-2162 SHIFT CABLE SLIDE & SCREW Replaces: 33981, 33981T, 33981T1, 8507521, 8507522</p>	 <p>18-2162E SHIFT CABLE SLIDE & SCREW Replaces: 33981, 33981T1, 8507521, 8507522 For: Xtreme Cables Only</p>

PKG. OF 5



18-2163
18-2163-9①
SHIFT SLIDE SCREW
Replaces: Mercuriser 10-31700
GLM: 21090
Mallory: 9-72152

PKG. OF 5 **XTREME**



18-2163E-9①
SHIFT SLIDE SCREW
For: Extreme Cables Only



18-2715
CHECK VALVE KIT
Replaces: 24-17997A1
For: Alpha I Generation II and Bravo I, II, and III Drives

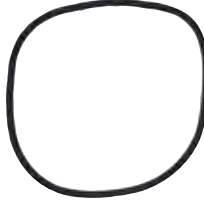

18-2724
TRANSOM SEAL
Replaces: 3713
For: Alpha Gen II, All Bravo

— CONTAINS —

Part #	Description	O.E. #	Qty.
18-2619-1	Outdrive Gasket Set	27-64818A3 27-94996A1,Q2	1
18-2100	Gimbal Bearing	30-60794A2, 30-60794A4	1
18-2161	Shift Arm	45518A2	1
18-2751	U-Joint Bellows	60932A4	1
18-2750	Exhaust Bellows	32734A3, 18654A1	1
18-2753-1	Shift Cable Bellows	74639	1
18-3601	Water Intake Hose	32-32461	1
18-3602	Water Intake Hose	32-41725-33	1
18-710-16-2	Hose Clamp	—	2
18-7314	Stainless Steel Hose Clamp	—	1
18-710-64-2	Stainless Steel Hose Clamp	—	1



18-2601-1
TRANSOM SEAL KIT
Replaces: 30-803097T1
R, MR, ALPHA 1 (1983-90) S/N 6225577 & UP
ALPHA 1 SS (1986-89) S/N OA 545004 & UP
*Greasable Gimbal Bearing

— CONTAINS —

Part #	Description	O.E. #	Qty.
18-2100	Gimbal Bearing	30-60794A4, 30-60794A2	1
18-2751	U-Joint Bellows	60932A4	1
18-2760	Exhaust Tube	78458A1	1
18-3601	Water Intake Hose	32-32461	1
18-3602	Water Intake Hose	32-41725-33	1
18-2743	Drive Shaft Housing to Bell Housing Gasket	27-94996-2	1
18-2840	Bell Housing Gasket	27-35982	1
18-7153	O-Ring	25-25439	1
18-7117	O-Ring	25-35027	1
18-710-16-2	Hose Clamp	—	2
18-7170	O-Ring	25-33504	1
18-710-24-2	Hose Clamp	—	1
18-2753-1	Shift Cable Bellows	74639	1
18-7321	Bellows Clamp	54-38863	1



18-8205
TRANSOM SEAL KIT
Replaces: 30-803098T1
For: 1, R, MR, Alpha 1 with exhaust tube
*Greasable Gimbal Bearing

— CONTAINS —

Part #	Description	O.E. #	Qty.
18-3602	Water Intake Hose	32-41725-33	1
18-710-16-2	Hose Clamp	—	2
18-710-24-2	Hose Clamp	—	1
18-2753-1	Shift Cable Bellows	74639	1
18-7321	Bellows Clamp	54-38863	1
18-2100	Gimbal Bearing	30-60794A4, 30-60794A2	1
18-2743	Drive Shaft Housing to Bell Housing Gasket	27-94996-2	1
18-2840	Bell Housing Gasket	27-35982	1
18-7153	O-Ring	25-25439	1
18-7170	O-Ring	25-33504	1
18-7117	O-Ring	25-35027	1
18-2750	Exhaust Bellows	18654A1, 32734A3	1
18-2747	Drive Bellows	816431A1	1



18-8206-1
TRANSOM SEAL KIT
Replaces: 30-803099T1
For: Alpha 1 Gen II
*Greasable Gimbal Bearing

— CONTAINS —

Part #	Description	O.E. #	Qty.
18-2753-1	Shift Cable Bellow	74639	1
18-2100	Gimbal Bearing	30-862540A3	1
18-2756	U-Joint Bellows	86840A3	1
18-2750	Exhaust Bellows	32734A3	1
18-2760	Exhaust Tube	78458A1	1
18-3603	Water Hose	32-43437	1
18-2615	Outdrive Mounting Kit	16755A1	1



18-8212-1
TRANSOM SEAL KIT
Replaces: 30-803100T1, 8M0095485
For: All Bravos 1982 & up
*Greasable Gimbal Bearing

 <p>18-8213 TRANSOM SEAL KIT Replaces: 30-803097T1 For: R, MR, Alpha 1 (1983-90) S/N 6225577-0D469858; Alpha 1 SS (1986-89) S/N 0A545004 & Up *Sealed Gimbal Bearing 18-21001</p>	 <p>18-8217 TRANSOM SEAL KIT Replaces: 30-803098T1 For: R, MR, Alpha 1 (1983-90) w/exhaust tube S/N 6225577-0D469858; Alpha 1 SS (1986-89) w/exhaust tube S/N 0A545004 & Up *Sealed Gimbal Bearing 18-21001</p>	 <p>18-8218 TRANSOM SEAL KIT Replaces: 30-803099T1 For: Alpha 1 Gen II (1991 & Up) S/N 0D469859 & Up *Sealed Gimbal Bearing 18-21006</p>	 <p>18-8219 TRANSOM SEAL KIT Replaces: 30-803100T1 For: Bravo I/II/III (1988 & Up) S/N 0B664190 & Up; Blackhawk (1994-95) S/N 0F186717 & Up *Sealed Gimbal Bearing 18-21006</p>
 <p>18-2747 U-JOINT BELLOWS Alpha 1, Gen II Replaces: 816431A1</p>	 <p>18-2750 EXHAUST BELLOWS All #1 Units, Gen II, TRS, & Bravo I, II, III Replaces: 32734, 32734A3, 18654A1 (Includes 18-710-48-2 Clamp)</p>	 <p>18-2751 U-JOINT BELLOWS All #1 units with ridge (S/N 3469428 & UP) Replaces: 60932A1, 60932A4 (Includes 18-710-72-2 Clamp)</p>	 <p>18-2752 U-JOINT BELLOWS All #1 units without ridge (S/N 3443920 & BELOW) Replaces: 36223, 36223A1, 36223A2 (Includes 18-710-72-2 Clamp)</p>
 <p>18-2753-2D SHIFT CABLE BELLOWS All #1, #2 units, Alpha, Bravo I, II, III Replaces: 31659, 74639, 74639A2 (Includes 18-7321 Clamp)</p>	 <p>18-2756 U-JOINT BELLOWS Replaces: 86840A3, 86840A05, 8M0062406 Fits: All Bravo and Blackhawk models</p>	 <p>18-1710 BELLOW FLANGE RING Replaces: 862209, 86814 Fits: All Bravo</p>	 <p>18-1728 BELLOW FLANGE RING Replaces: 816607 Fits: Alpha One (GenII) (1991 and Up)</p>
 <p>18-2746 EXHAUST BOOT Replaces: 32-14358, 32-14358T, 31-14358001 (4" Lower Tube)</p>	 <p>18-2748 EXHAUST BOOT Replaces: 32-44348, 32-44348T, 31-44348001 (4" Upper Tube)</p>	 <p>18-2759 EXHAUST TUBE Replaces: 53114, 53114A1</p>	 <p>18-2760 EXHAUST TUBE Replaces: 78458, 78458A1 (Includes 18-7314 Clamp) For: #1, Bravo I, II, III</p>
 <p>18-2761 EXHAUST TUBE 3" I.D. Replaces: 32-90949, 32-90949T</p>	 <p>18-2762 EXHAUST TUBE Replaces: 70981, 70981A3</p>	 <p>18-2770 EXHAUST TUBE Replaces: 32-807458T</p>	

① Items ending in "D" are Display Packaged - Regular number is Non-Display

BELLOWS APPLICATION

Model	Years	Serial #	Exhaust Bellows	Shift Cable Bellows	U-Joint
I/1A/1B/1C & EZ	1963-1966	1534570-2065186	18-2750	18-2753-2	18-2752
120/140/160/165	1967-1972	2062141-3443920	18-2750	18-2753-2	18-2752
120/140/160/165	1972-1982	3469428-6225576	18-2750	18-2753-2	18-2751
888	1971-1972	3106717-3472477	18-2750	18-2753-2	18-2752
888	1973-1977	3472478 & Up	18-2750	18-2753-2	18-2751
225/233	1974-1977	3856268 & Up	18-2750	18-2753-2	18-2751
898/228/250/260	1977-1982	4782330-6225576	18-2750	18-2753-2	18-2751
R/MR/Alpha One	1983-1990	6225577 & Up	18-2750	18-2753-2	18-2751
R/MR/Alpha One	1983-1990	6225577 & Up	18-2760 ②	18-2753-2	18-2751
Alpha One Gen II	1991 & Newer	0D469859 & Up	18-2750	18-2753-2	18-2747
Bravo I/II/III	1988 & Newer	0B664190 & Up	18-2750	18-2753-2	18-2756
Bravo I/II/III	1988 & Newer	0B664190 & Up	18-2760 ②	18-2753-2	18-2756
Blackhawk	1994-1995	0F18677 & Up	18-2750	18-2753-2	18-2756
Blackhawk	1994-1995	0F18677 & Up	18-2760 ②	18-2753-2	18-2756
II	1962-1969	1474909-2671321	—	18-2753-2	—
215H	1970	2782203-2909034	—	—	18-2752
215E	1970-1972	2909035-2915034	—	18-2753-2	18-2752
TR/TRS	1973-1993	3377316 & Up	—	—	18-2751

② Tube

PKG. OF 5



18-7321
18-7321-9②
BELLOWS CLAMP

Replaces: 54-38863, 54-866507, 54-8M0090424

18-2159 **INNER SHIFT CABLE**

Replaces: 19543A2, 19543A4, 19543A8, 19543A10, 41951A1, 66065A1, 66069A2, 73679A2, 865436A02
Use in 18-2157, 18-2158 and their Mercruiser equivalent as replacement wire and tube
Stranded Core 73"



18-2189
Replaces: 32992A1, 34086A1, 37611A1, 38399A2
Use with 18-2248
Inner Core Wire 59"

18-2160
SHIFT CABLE
SUPPORT TUBE

Replaces: 32-38377
Replaces tube on 18-2157, 18-2158 & 18-2159



18-2248
SHIFT CABLE
ASSEMBLY

Replaces: 73723A1, 73723A01, 49518A1, 35187A1, 35187A2, 35187A4
Mercruiser #1 Drives S/N 1562900-6225576 for forward installation into bell housing.
Has new style armored strand construction. (No support tube) 54" conduit with hardware package.



18-2157

Replaces: 19543A2, 41951A1, 19543A8, 19543A10, 19543A4, 66065A1, 66069A2, 73679A2, 865436A02
Mercruiser 1 drives S/N 6225577 & UP For AFT installation into bell housing. Has old style stranded core wire with soldered tip (Uses Support Tube).



18-2158
Mercruiser #1 Drives S/N 1562900-6225576 for forward installation into bell housing. Has old style stranded core wire with soldered tip. (Uses support tube **18-2160**) 63" conduit

SHIFT CABLE ASSEMBLY

18-2190
SHIFT CABLE

Replaces: 19543A2, 19543A4, 19543A8, 19543A10, 41951A1, 66065A1, 66069A2, 73679A2, 865436A02
Mercruiser 1 drives S/N 6225577 & UP
For AFT installation into bell housing. For use in applications using core wire with armored strand construction (No Support Tube). 63" Conduit with hardware package.



18-2190E
SHIFT CABLE

Replaces: 19543A4, 19543A10, 19543A8, 19543A2, 41951A1, 66065A1, 66069A2, 73679A2, 865436A02
S/N 6225577 & UP. For AFT installation into bell housing. For use in applications using core wire with armored strand construction (No Support Tube). 63" Conduit with hardware package. Lower Shift Cable- Alpha One (Gen II) (1991-97)
Requires **18-9806E** (Xtreme Shift Cable Tool) to complete installation



18-2145
SHIFT CABLE

Replaces: 815471A3, 815471A6, 85147A5, 865437A02, 43432A2, 19297A3

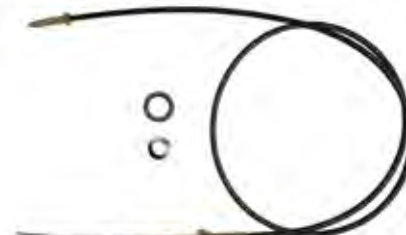



**18-2145E
SHIFT CABLE**

Replaces: 815471, A3, A6
Bravo One, Two, & Three (All Ratios), Bravo One X/Two X, Three X (All Ratios), Bravo One XR/XZ (All Ratios), Bravo One XR Sportmaster (All Ratios) & Integrated Transom



**18-9806E
SHIFT CABLE TOOL**

Installs and removes shift cables on MC-I, R-MR, Alpha I, Alpha I Gen II drive units. Use with 18-2190 and 18-2190E cables.

**18-2149
SHIFT CABLE GUIDE**

Replaces: 22879, 29880, 43433
For: Alpha & Bravo cables



PKG OF 25

**18-2303
18-2303-9①
ANCHOR SCREW SET**

Replaces: 10-20518
For: #1R, MR, Alpha, Alpha I, Gen II & Bravo



**18-3754
CABLE ANCHOR**

Replaces: 43436
For: #1R, MR, Alpha, Alpha I, Gen II & Bravo

**18-2600
LOWER SHIFT CABLE KIT**

— CONTAINS —

Part #	Description	O.E. #	Qty.
18-2753-2	Shift Cable Bellows	74639	1
18-2248	Shift Cable Assembly	73723A1	1
18-2162	Shift Slide & Screw	33981T	1
18-2149	Shift Cable End Kit	43433	1
18-2163	Shift Slide Screw	10-31700	1
18-2743	Drive Shaft Housing to Bell Housing Gasket	27-94996-2	1
18-2820	Drive Shaft Housing to Bell Housing Gasket	27-64818	1
18-2840	Bell Housing Gasket	27-35982	1
18-7117	O-Ring	25-35027	1
18-7153	O-Ring	25-25439	2
18-7170	O-Ring	25-33504	1

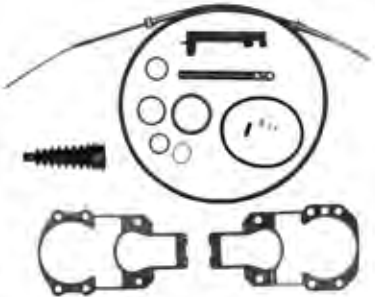

**18-2603
LOWER SHIFT
CABLE KIT**

Replaces: 19543T1, 19543T2, 865436A03
ALPHA I GENERATION II

— CONTAINS —

Part #	Description	O.E. #	Qty.
18-2619-1	Outdrive Gasket Set	27-94996A1	1
18-2753-2	Shift Cable Bellows	74639	1
18-2190	Shift Cable Assembly	19543A4	1
18-2743	Drive Shaft Housing to Bell Housing Gasket	27-94996-2	1



**18-2603E
LOWER SHIFT
CABLE KIT (XTREME)**

Replaces: 19543T1, 19543T2, 865436A03
For: Alpha I Gen II
Uses 18-2190E shift cable.
Requires 18-9806E (Xtreme Shift Cable Tool) to complete installation



**18-2604
LOWER SHIFT CABLE KIT**

Replaces: 815471T1
BRAVO

— CONTAINS —

Part #	Description	O.E. #	Qty.
18-2145	Bravo Shift Cable	815471A3	1
18-2149	Shift Cable End Kit	43433	1
18-2753-1	Shift Cable Bellows	74639	1
18-2615	Outdrive Gasket Set	—	1



**18-2604E
LOWER SHIFT CABLE KIT
(XTREME)**

Replaces: 815471T1
Uses 18-2145E shift cable.
For: Bravo

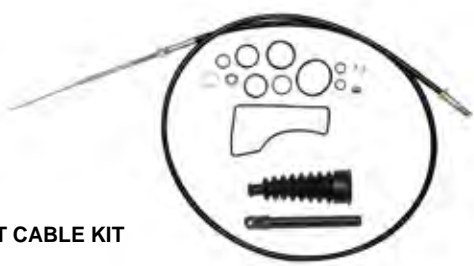

**GRADE 316
STAINLESS STEEL WORM GEAR
HOSE CLAMPS**



All components are manufactured from Marine Grade 316 stainless steel. These clamps are designed to fit many applications from 3/16" to 7" diameter hoses.

STAINLESS STEEL CLAMPS

Part #	O.E. #	Diameter Size	Std. #	Part #	O.E. #	Diameter Size	Std. #
18-710-06-2	-	7/16" to 3/4"	006	18-710-32-2	-	1 9/16" to 2 1/2"	032
18-710-10-2	-	9/16" to 1 1/16"	010	18-710-48-2 ①②	54-815504348	2 9/16" to 3 1/2"	048
18-710-12-2	-	9/16" to 1 1/4"	012	18-710-64-2 ①	-	2 1/2" to 4 1/2"	064
18-710-16-2	-	1 1/16" to 1 1/2"	016	18-710-72-2 ①③	-	3" to 5"	072
18-710-20-2	-	3/4" to 1 3/4"	020	18-710-104-2	-	5" to 7"	104
18-710-24-2	-	1 1/16" to 2"	024				

① For use with 3" Bellows ② O.E. #54-32533 ③ O.E. #s 54-31765, 54-815504372

**18-2175
ENGINE
COUPLER**

Replaces: 12632A4

Uses 18-2146 Yoke Shaft

Flex plate style for late model, small crankshaft bolt pattern, style engines



**18-2195
ENGINE COUPLER**

Replaces: 12632A3, 12632A7

Uses 18-2146 Yoke Shaft

Flex plate style for GM 4 Cyl engines with late style, small crankshaft bolt pattern



**18-2323
ENGINE COUPLER**

Replaces: 18643A5

(Same as 18-2175 without yoke)



**18-2321
ENGINE COUPLER**

Replaces: 12632A6

(Same as 18-2195 without yoke)

For: Late model GM 4 cylinder



**18-2412-1
ENGINE
COUPLER**

Replaces: 18309A2, 18311A2, 18311A17,
812964A2, 861523A9, 8M0098795

For: Bravo



**18-2413
ENGINE
COUPLER**

Replaces: 69354A1, 69354A2

For: 470, 485 (224 cu. in.)

S/N 4208730-6218036 (1976-1982)



**18-2414
ENGINE
COUPLER**

Replaces: 97432A2

For: 165, 170, 470, 3.7L S/N 6170297 & UP (1983-1989)
180, 190, 488, 3.7LX S/N 6170297 & UP (1983-1989)



**18-2171
ENGINE
COUPLER**

Replaces: 32492A2, 32492A3, 32492A5,
38965A1, 38965A2, 76850A2

For: All GM engines except MR/ALPHA/BRAVO
with "Triangular", 3-Bolt coupler



**18-2172
ENGINE COUPLER**

Replaces: 14505A2

Used when replacing V6 or V8 2 piece rear main seal
with 3-1/2" crankshaft bolt pattern to a newer 1 piece
rear main seal engine with 3" bolt pattern



**18-2173
ENGINE
COUPLER**

Replaces: 59826A1, 59826A3

For: Ford engines



① Priced per Package

ENGINE COUPLER APPLICATION

HP	Liter	Model	CID	# Cyl	Stroke	Years	Serial #	Part #
110		110	153	4		1963-1966	1537370 - 2044033	18-2171
120		120	153	4		1964-1982	1537370 - 6229717	18-2171
120		120	153	4	4	1964-1982	1666601 - 6229717	18-2171
120		120	153	4	4	1983-1986	6229718 - B531853	18-2171 ①
120		120	153	4	4	1983-1986	6229718 - B531853	18-2195 ②
	2.5L	2.5L	153	4	4	1987-1989	B531854 - C853255	18-2171 ③
	2.5L	2.5L	153	4	4	1987-1989	B531854 - C853256	18-2195 ④
140		140	181	4	4	1968-1982	2508261 - 6229717	18-2171
140		140	181	4	4	1983-1986	6229718 - B450800	18-2171 ①
140		140	181	4	4	1983-1986	6229718 - B450800	18-2195 ②
140		140 INLINE 6		6	4	1963	1538930 - 1725960	18-2171
	3.0L	3.0L	181	4	4	1987-1989	B450801 - C856558	18-2171 ③
	3.0L	3.0L	181	4	4	1987-1989	B450801 - C856558	18-2195 ④
	3.0L	3.0L	181	4	4	1990-1994	C856559 - F603999	18-2195
	3.0L	3.0L	181	4	4	1998-2010	L097000 & UP	18-2323
	3.0L	3.0L MPI	181	4	4	2008-2010	A072812 & UP	18-2323
	3.0L	3.0LX	181	4	4	1990-1993	C856559 - F000000	18-2195
	3.0L	3.0LX	181	4	4	1994-1998	F000001 - L096999	18-2321
150		150			4	1964-1966	1666495 - 2048046	18-2171
160		160			4	1967-1969	2048022 - 2770031	18-2171
165		165	224	4	4	1987	B434941 - B774251	18-2414
165		165 INLINE 6		6	4	1970-1981	2770032 - 5813433	18-2171
170		170	224	4	4	1985-1986	6916779 - B434940	18-2414
180		180	224	4	4	1987	B436391 - B775248	18-2414
190		190	224	4	4	1985-1987	6916779 - B775248	18-2414
	3.7L	3.7L	224	4	4	1988-1989	B774252 & UP	18-2414
	3.7L	3.7LX	224	4	4	1983-1989	B775249 & UP	18-2414
		470	224	4	4	1976-1982	4208730 - 6218036	18-2413
		470	224	4	4	1983-1984	6218037 - 6916779	18-2414
		485	224	4	4	1980-1982	5685394 - 6218036	18-2413
		488	224	4	4	1983-1984	6170297 - 6916779	18-2414
		140	194	6	4	1963	1538930 - 1664117	18-2171
		150	230	6	4	1964-1966	1664118 - 2048046	18-2171
		160	250	6	4	1967-1969	2048022 - 2770031	18-2171
		165	250	6	4	1970-1981	2770032 - 5813433	18-2171
175		175			4	1987	B527955 - B773242	18-2175
185		185 (4bbl)	229	6	4	1983-1984	6330183 - 6919655	18-2171
175		175	262	V-6	4	1987	B527955 - B773242	18-2175
185		185 (2bbl)	262	6	4	1985-1986	A331455 - B527954	18-2171 ①
185		185 (2bbl)	262	6	4	1985-1986	A331455 - B527954	18-2175 ②
205		205	262	6	4	1985-1986	A331455 - B527954	21-2171 ③
205		205	262	6	4	1985-1986	A331455 - B527954	18-2175 ④
205		205	262	6	4	1987	B527955 - B775129	18-2175
		262 MAG EFI GEN+	262	V-6	4	1996-1997	F803800 - K999999	18-2323
	4.3L	4.3L	262	V-6	4	1988-1993	B527955 - F000877	18-2175
	4.3L	4.3L	262	V-6	4	1993-2010	F000878 & UP	18-2323
	4.3L	4.3L EFI GEN +	262	V-6	4	1998-2001	L012009 - M299999	18-2323
	4.3L	4.3L MPI	262	V-6	4	2002-2010	M300000 & UP	18-2323
	4.3L	4.3LH GEN +	262	V-6	4	1998-2002	L010044 - M614999	18-2323
	4.3L	4.3LX	262	V-6	4	1988-1993	B775130 - F001219	18-2175
	4.3L	4.3LX (4bbl)	262	V-6	4	1993-1995	F001220 - F802999	18-2323
	4.3L	4.3LX GEN + (2bbl)	262	V-6	4	1996-1997	F803000 - K999999	18-2323
	4.3L	4.3LXH GEN +	262	V-6	4	1996-1997	F803000 - K999999	18-2323
	5.0L	225 (FORD)	302	V-8	4	1973-1974	3385721 - 4166999	18-2173 ⑤
	5.0L	888	302	V-8	4	1971-1977	3108723 - 4887829	18-2173

- ① Use with Borg Warner transmission
- ② Low speed / work application
- ③ Coupler mounts to flywheel
- ④ Use with Hurth transmission
- ⑤ Hydraulic shift only
- ⑥ I drive only
- ⑦ Round shape coupler
- ⑧ Standard Bravo applications
- ⑨ Coupler mounts to crankshaft
- ⑩ Triangular shape coupler
- ⑪ Use with Borg Warner 71/72 series in-line transmission
- ⑫ Use with Borg Warner 5000 or Hurth 630 transmission

ENGINE COUPLER APPLICATION

HP	Liter	Model	CID	# Cyl	Stroke	Years	Serial #	Part #
		190	283	V-8	4	1963-1964	1564539 - 1730903	18-2171
	5.0L	200	305	V-8	4	1985-1986	6899058 - B525981	18-2171 ①
	5.0L	200	305	V-8	4	1985-1986	6899058 - B525981	18-2175 ②
	5.0L	200	305	V-8	4	1985-1987	6899058 - B774444	18-2175
	5.0L	228	305	V-8	4	1977-1982	4765100 - 6218461	18-2171
	5.0L	228	305	V-8	4	1977-1984	6218462 - 6899268	18-2171
	5.0L	230	305	V-8	4	1985-1987	6899269 - B773739	18-2171 ③
	5.0L	230	305	V-8	4	1985-1987	6899269 - B773739	18-2175 ④
	5.0L	5.0L ALPHA	305	V-8	4	1988-1993	B774445 - F000000	18-2175
	5.0L	5.0L ALPHA	305	V-8	4	1994-1995	F000001 - F600999	18-2323
	5.0L	5.0L GEN+ ALPHA	305	V-8	4	1998-2010	L015751 & UP	18-2323
	5.0L	5.0L GEN + BRAVO	305	V-8	4	1998-2010	L015751 & UP	18-2412-1 ⑤
	5.0L	5.0L EFI ALPHA	305	V-8	4	1998-2001	L012052 - M299999	18-2323
	5.0L	5.0L EFI BRAVO	305	V-8	4	1998-2001	L015751 - M299999	18-2412-1 ⑥
	5.0L	5.0LX ALPHA	305	V-8	4	1988-1993	B773740-F000000	18-2175
	5.0L	5.0LX ALPHA	305	V-8	4	1994-2007	F000001 & UP	18-2323
	5.0L	5.0L MPI BRAVO	305	V-8	4	1998-2007	L015751 & UP	18-2412-1
	5.0L	5.0L MPI ALPHA	305	V-8	4	2002-2010	M300000 & UP	18-2323
	5.0L	5.0L MPI BRAVO	305	V-8	4	2002-2010	M300000 & UP	18-2412-1 ⑦
	5.0L	5.0LX ALPHA	305	V-8	4	1988-1993	B773740 - F000000	18-2175
	5.0L	5.0LX ALPHA	305	V-8	4	1994-1995	F000001 - F600999	18-2323
	5.0L	898	305	V-8	4	1977-1985	4762210 - 6899057	18-2171
		225 (GM)	327	V-8	4	1963-1969	1539620 - 2694014	18-2171
		250	327	V-8	4	1977	4768000 - 4908849	18-2171
	5.7L	260	350	V-8	4	1978-1982	4908850 - 6218461	18-2171
	5.7L	260	350	V-8	4	1982-1986	6218462 - B525981	18-2171 ⑧
	5.7L	260	350	V-8	4	1982-1987	6218462 - B773304	18-2175 ⑨
	5.7L	260	350	V-8	4	1987	B525982 - B773304	18-2175
	5.7L	300 TEMPEST ALPHA	350	V-8	4	1985-1986	6668677 - B430367	18-2171 ⑩
	5.7L	300 TEMPEST ALPHA	350	V-8	4	1986	A434310 - B430367	18-2175 ⑪
	5.7L	320 EFI	350	V-8	4	1987-1989	A543604 - C622418	18-2175
	5.7L	350 MAG ALPHA	350	V-8	4	1986-1993	A635178 - F000000	18-2175
	5.7L	350 MAG ALPHA	350	V-8	4	1993-1997	F000001 - K999999	18-2323
	5.7L	350 MAG ALPHA EFI GEN +	350	V-8	4	1996-1997	F800300 - K999999	18-2323
	5.7L	350 Mag MPI ALPHA	350	V-8	4	1998-2010	L010019 & UP	18-2323
	5.7L	350 MAG MPI BRAVO	350	V-8	4	1998-2010	L010019 & UP	18-2412-1 ⑫
	5.7L	350 MAG MPI HORIZON ALPHA	350	V-8	4	2002-2007	M300000 - A299999	18-2323
	5.7L	350 MAG MPI HORIZON BRAVO	350	V-8	4	2002-2007	M300000 - A299999	18-2412-1 ⑬
	5.7L	350 MAG MPI HORIZON ALPHA	350	V-8	4	1993-2007	F000001 & UP	18-2323
	5.7L	HORIZON BRAVO	350	V-8	4	1999-2007	M300000 & UP	18-2412-1
	5.7L	5.7L ALPHA	350	V-8	4	1988-1993	B773305-F000000	18-2175
	5.7L	5.7L ALPHA	350	V-8	4	1993-2010	F000001 & UP	18-2323
	5.7L	5.7L BRAVO	350	V-8	4	1988-2010	B773305 & UP	18-2412-1 ⑭
	5.7L	5.7L EFI ALPHA	350	V-8	4	1995-2001	F225560 - M299999	18-2323
	5.7L	5.7L EFI BRAVO	350	V-8	4	1998-2001	L010035 - M299999	18-2412-1 ⑮
	5.7L	5.7LX EFI ALPHA	350	V-8	4	1996-1997	F752400 - K999999	18-2323
	5.7L	5.7LX EFI ALPHA	350	V-8	4	1993-2007	F000001 & UP	18-2323
	5.7L	5.7L EFI BRAVO	350	V-8	4	1998-2007	L010035 & UP	18-2412-1 ⑯
	5.7L	233	351	V-8	4	1975-1977	4173000 - 4902304	18-2173
	6.2L	377 MAG	377	V-8	4	2008-2010	A300000 & UP	18-2412-1 ⑰
	6.2L	MX 6.2L MPI	377	V-8	4	2000-2007	L680003 - A299999	18-2412-1 ⑱
	6.2L	MX 6.2L MPI	377	V-8	4	2000-2007	L680003 - A299999	N/A ⑲
	6.2L	MX 6.2L MPI HORIZON	377	V-8	4	2002-2007	M300000 - A299999	18-2412-1 ⑳
	7.4L	454 MAG ALPHA	454	V-8	4	1986-1988	A631894 - B785148	18-2175 ㉑

- ① Use with Borg Warner transmission
- ② Low speed / work application
- ③ Coupler mounts to flywheel
- ④ Use with Hurth transmission

- ⑤ Hydraulic shift only
- ⑥ I drive only
- ⑦ Round shape coupler
- ⑧ Standard Bravo applications

- ⑨ Coupler mounts to crankshaft
- ⑩ Triangular shape coupler
- ⑪ Use with Borg Warner 71/72 series in-line transmission
- ⑫ Use with Borg Warner 5000 or Hurth 630 transmission



18-4442
ENGINE ALIGNMENT TOOL
 Replaces: 91-57797A3, 91-57797A2, 91-57797A1, 91-8M0067546, 91-48347, 91-37384
 For use with all #1 units, MR, all Alpha & Bravo units



18-9803
SPANNER NUT WRENCH
 Replaces: 91-36235, 91-17256

SIERRA HYDRO DEFENSE MARINE GREASE

18-9240-0
 (8 oz Tube)
 Replaces:
 Mercury 92-802859A1



18-9240-1
 (14oz Cartridge)
 Replaces:
 Mercury 92-802863A1

- Prohibits rust and corrosion.
- Prevents wear against the most extreme friction in marine applications.
- Will not break down in marine conditions.
- Contains PTFE for minimum wear and added friction protection.
- For use on prop shafts, trailer bearings, throttle and shift cables and linkage, swivel pins and more!



18-2200
LOWER UNIT GEAR SET
 Replaces: 43-61027, 43-96084A4
 888 S/N 3106717 & UP #1 Units S/N 3469428 & UP Except, MR/ALPHA Units (which have no pre-load pin in the top of the drive shaft).



18-2410
FORWARD GEAR SET
 Replaces: 43-96084A7, 43-96084A5
 For: "R" drive



18-2360
PINION & FORWARD GEAR SET
 Replaces: 43-828072A3, 43-878087A2
 13-21 Teeth



18-2206-1
LOWER UNIT GEAR SET
 Replaces: 43-878087A2 + 43-828073A1, 43-828072A2
 For: Alpha 1 Gen II (serial 0F680000 & Up)



18-2409
REVERSE GEAR
 Replaces: 43-92320, 43-92320T
 For: "R" drive (28 teeth)



18-2406
FORWARD GEAR SET
 Replaces: 43-878087A2, 43-878072A3
 For: MR/Alpha/Gen II lower S/N D469859 & UP



18-2408
REVERSE GEAR
 Replaces: 43-828073A1
 For: Alpha I/Gen II lower S/N D469859 & UP

18-2404
GEAR REPAIR KIT
 Replaces: 43-803079T1
 For: "R" drive



— CONTAINS —

Part #	Description	O.E. #	Qty.
18-2200	Lower Unit Gear Set	43-96084A4	1
18-2202	Sliding Clutch	52-66063	1
18-1157	Needle Roller Bearing	31-30895	1
18-1155	Ball Bearing	30-88957A1	1
18-1159	Tapered Roller Bearing	31-35928A1	1
18-2285	Shim	15-47397A1	1
18-3719	Pinion Nut	11-35921	1
18-2299	Tab Washer	14-79447	1

18-2405
GEAR REPAIR KIT
 Replaces: 43-803091T1
 For: MR/Alpha I



— CONTAINS —

Part #	Description	O.E. #	Qty.
18-2652	Lower Gear Housing Seal Kit	26-33144A2	1
18-3719	Pinion Nut	11-35921	1
18-2343	Washer	12-982721	1
18-2298	Tab Washer	14-18323	1
18-2299	Tab Washer	14-79447	1
18-2206-1	Gear Set	43-42934	1
18-2285	Shim	15-47397A1	1
18-1155	Ball Bearing	30-88957A1	1
18-1158	Needle Roller Bearing	31-30956	1
18-1117	Pinion Bearing	31-42647A1	1
18-1143	Alpha Bearing	31-36387A1	1
18-2294	Shim Kit	15-42637A-1	1
18-2202	Sliding Clutch	52-66063	1

18-2407
GEAR SET
 Replaces:
 43-878087A4, 43-823072A2, 43-42933A3,
 43-42933A2, 43-17064A3
 For: MR/Alpha/Gen II
 lower gear housings



— CONTAINS —

Part #	Description	O.E. #	Qty.
18-2206-1	Gear Set	43-42934	1
18-1155	Ball Bearing	30-88957A1	1
18-1117	Pinion Bearing	31-42647A1	1
18-1158	Needle Roller Bearing	31-30956	1
18-1143	Alpha Bearing	31-36387A1	1
18-2294	Shim Kit	15-42637A-1	1
18-2285	Shim	15-47397	1
18-3719	Pinion Nut	11-35921	1
18-2343	Washer	12-982721	1



18-2202
SLIDING CLUTCH
 Replaces: 52-66063, 52-853594T, 52-853594,
 52-824112
 888 S/N 3784375 & UP
 #1 Units S/N 3469428 & UP

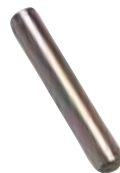

18-2357
CROSS PIN
 Replaces:
 17-30632, 17-8M0020941, 17-8M0100263,
 17-8M0084681

PKG. OF 2



18-2348
18-2348-9^①
CLUTCH CROSS
PIN SPRING
 Replaces: 24-30893
 1/MC-1/R/MR/Alpha
 Mercuriser/Gen II lower
 S/N D469859-F679999
 Mercuriser Vazer



18-2166
PROP SHAFT
 Replaces: 44-66060, 44-660603, 44-824110, 44-660602, 44-55857
 For: All #1 & MR/ALPHA Units S/N 2791957 & above.
 Also for 165 (6 cyl.) S/N 2763442 & above.

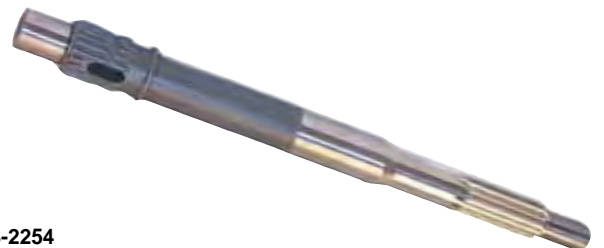

18-2254
PROP SHAFT
 Replaces: 44-850308
 For: Alpha One Gen II S/N 0L100040 & up/Vazer



18-2180
DRIVE SHAFT
 Replaces: 45-42634
 For all MR/ALPHA Units & older units which have been retro-fitted with MR/ALPHA lower units.



18-2331
DRIVE SHAFT
 Replaces: 45-853648, 45-853647
 For: Ratios 1.47, 1.62, 1.81 & 1.94.
 Fits: Gen II (1998 & up), (0L100040 & up)
 For use with: 18-2400 Complete Lower Gear Case



18-2261
DRIVE SHAFT
 Replaces: 45-816919
 All Alpha I Generation II Drives (with new style 18-3056 Impeller)
 Serial #D494569 & above.



18-2346
RETAINER NUT
 Replaces: 824519, 8245191, 11-42633, F694961, F694961-1
 For: MR Alpha & Gen II



18-3719
PINION NUT
 Replaces: 11-35921, 11-47411,
 11-826375, 11-F694188
 5/8" - 18 thread • 1 1/16" wrench



18-2359
DRIVE SHAFT NUT SET

— INCLUDES —

Sierra #	Description	Replaces:
18-3719	Pinion Nut	11-35921
18-2343	Pinion Nut Washer	12-92721



18-2286
 Replaces: 66067, 66067T,
 19755A2, 818349A1, 818349T1

18-2196
 Replaces: 37967, 61073, 19755A4,
 19755A08

SHIFT SPOOL ASSEMBLIES

SHIFT SPOOL ASSEMBLY APPLICATION

Model	Serial #	Part #
1A (EZ-Shift)	1776349 & UP	18-2196
1B (EZ-Shift)	1775193 & UP	18-2196
1C (EZ-Shift)	1777799 & UP	18-2196
120/140	2062141-3780849	18-2196
120/140	3780850 & UP	18-2286
160	2065190-2763441	18-2196
165	2763442-3780849	18-2196
165	3780850 & UP	18-2286
888	3106717-3784374	18-2196
888	3784375 & UP	18-2286
898/228	4782330 & UP	18-2286
225-S	3856268-4200499	18-2286
233	4200500 & UP	18-2286
470/485	4208730 & UP	18-2286
R/MR/Alpha One	6225377 & UP	18-2286
Alpha One (Gen II)	D494569 & UP	18-2286



18-3759
THRUST BEARING RING
 Replaces: 35915



18-2342
THRUST RING
 Replaces: 68100, 681001
 For: MR/ ALPHA



18-2191
CARRIER BEARING
 Replaces: 56211A1, 73020A1, 73020A14
 For: #1R/MR/Alpha I
 For: Housings with casting #73020C



18-2376
CARRIER BEARING
 Replaces: 73020A20, 818763A4, 818763A10
 For: Alpha Gen II & MR Units
 For: Housings with casting #73020C1, Mercruiser Vazer



18-2150
SHIFT SHAFT
 Replaces: 37973, 65028, 66066, 77481, 774811
 Stainless Steel



18-2353
SHIFT ROD BUSHING ASSEMBLY
 Replaces: 23-815921A21, 23-815921A17,
 23-815921A10, 23-815921A8,
 23-815921A6, 815921A2



18-2154
SHIFT SHAFT HOUSING BUSHING
 Replaces: 23-30617A1, 23-30617A2
 Mercruiser & Alpha 1 (S/N 1684188 & UP)



18-3198
WATER PICK-UP
 (Port)
 Replaces: 93424, 934241, 934243
 For: MR Alpha



18-3199
WATER PICK-UP
 (Starboard)
 Replaces: 93423, 934231, 934233
 For: MR Alpha



18-2320
SHIFT SHAFT
 Replaces: 815919A1
 For: Gen II



18-2130
SHIFT CRANK
 Replaces: 66062, 76865,
 8M2009865
 For: All #1 Units R/MR/Alpha,
 Mercruiser Vazer

PKG. OF 2



18-4295
18-4295-9①
E-CLIP
 Replaces: 53-29641
 For: Gen II



18-2299
TAB WASHER
 Replaces: 14-79447,
 14-52833



18-2298
TAB WASHER
 Replaces: 14-18323,
 14-17460



18-3751
SPANNER NUT
 Replaces: 79448
 For: Mercruiser Vazer



18-2354
CARRIER SEAL
 Replaces: 821759A4, 821759A3,
 821759A2, 821759A1, 815922A5,
 815922A1, 807929A2, 807929A1

PKG. OF 2



18-2707
18-2707-9①
COLLAR KEEPER
 Replaces: 97351
 For: Bravo



18-1117
PINION BEARING
 Replaces: 31-42647A1



18-1120
PINION BEARING
 Replaces: 31-35246
 For: Lower drive shaft III, TR & Bravo I, II, III (1986-95)



18-1356
PINION BEARING
 Replaces: 31-54928

Model	Year	Model	Year
215 E/H	1970-72	II, TR	1973-76
225TRS, 280 TRS	1973-76	TR, TRS	1977-93



18-1142
UPPER PINION BEARING
 Replaces: 31-32573A1

① Priced per Package



18-1193
TAPERED
ROLLER BEARING
 Replaces: 31-33138A1
 Fits: Gen II (1998-Up), Mercruiser Vazer



18-1143
TAPERED
ROLLER BEARING
 Replaces: 31-36387A1



18-1156
FORWARD
GEAR BEARING
 Replaces: 31-30894A1
 For: Mercruiser Vazer



18-1161
TAPERED
ROLLER BEARING
 Replaces: 31-35990A1
 For: Mercruiser Vazer



18-1162
TAPERED
ROLLER BEARING
 Replaces: 31-38356A1, 31-F84901, FA84901, F84903



18-1165
TAPERED
ROLLER BEARING
 Replaces: 31-61100A1



18-1173
TAPERED
ROLLER BEARING
 Replaces: 31-828437A2



18-1179
TAPERED
ROLLER BEARING
 Replaces: 31-32575A1, T1
 For: Gen II F680000 & UP, Mercruiser Vazer



18-1126
TAPERED ROLLER
BEARING
 Replaces: 31-8M0103474



18-1127
TAPERED
ROLLER BEARING
 Replaces: 31-54038A1
 For: Bravo II - Lower (S/N B664190 & UP)



18-1163
TAPERED ROLLER
BEARING
 Replaces: 31-48941A1



18-1197
TAPERED FORWARD GEAR
BEARING
 Replaces: 31-828439A2
 For: Alpha One Gen II (1996-97)
 (s/n 0F680000-0K999999)



18-1182
ROLLER BEARING KIT
 Replaces: 31-30894A5
 For: Alpha I (Gen II) (1998 & up)
 (OL100040 & up), Mercruiser Vazer



18-1129
UPPER DRIVE
SHAFT BEARING
 Replaces: 31-86748A1, 31-8M0103473, 31-F506818, F508814
 For: Bravo I, II, III - Lower (S/N B664190 & UP)



18-1150
NEEDLE ROLLER BEARING
 Replaces: 31-92366A1, 31-92366



18-1180
NEEDLE BEARING
 Replaces: 31-54042T
 For: Bravo I, II, III (1988-98), TRS (1977-93)-carrier



18-1157
FORWARD GEAR
INNER BEARING
 Replaces: 31-30895, 31-30895T
 For: Mercruiser Vazer



**18-1158
CARRIER BEARING**
Replaces: 31-30956, 31-30956T,
31-F523058
For: Mercuriser Vazer



**18-1153
BALL BEARING**
Replaces: 30-63326, 30-63326T,
30-49313, 30-54215, 30-20464



**18-1155
BALL BEARING**
Replaces: 30-88957A1, 30-88957T,
30-35914, 30-17927, 30-88957



**18-1160
DRIVE BEARING KIT**
Replaces: 31-35988A2, 31-35988A12

MERCURISER STERNDRIVE UPPER GEAR HOUSING BEARINGS

Sterndrive Model	Drive Ratio	Years	Serial #	Drive Gear (Yoke)	Driven Gear	Upper Cap
IA,IB,IC & EZ Shift	All	1964-66	1684188 - 2065186	18-1160	18-1161	18-1179
120/140	1.98	1967	2062141- 2187468	18-1160	18-1161	18-1161
120/140	1.98	1967-71	2187469 - 3134193	18-1160	18-1161	18-1179
120/140	1.98	1971-82	3134194 - 6225576	18-1160	18-1161	18-1165
470/485	1.84	1976-82	4208730 - 6225576	18-1160	18-1161	18-1165
160	1.68	1967	2065190 - 2182197	18-1160	18-1161	18-1161
160	1.68	1967-71	2182198 - 3134193	18-1160	18-1161	18-1179
165	1.65	1971-81	3213658 - UP	18-1160	18-1161	18-1165
888	1.5	1971-73	3106717 - 3134193	18-1160	18-1161	—
888	1.5	1973-77	3134194 - UP	18-1160	18-1161	18-1165
225-S	1.5	1974	3856268 - 4200499	18-1160	18-1161	18-1165
898/228	1.65	1977-82	4782330 - 6225576	18-1160	18-1161	18-1165
233	1.32	1975-77	4200500 - UP	—	—	18-1165
250	1.32	1977	4791300 - 4898729	—	—	18-1165
255-TRS	All	1973-74	3377316 - 4203749	18-1162 ③	18-1162	—
260	1.5	1978-82	4898730 - 6225576	18-1160	18-1161	18-1165
280-TRS	All	1975-76	4203750 - 4895399	18-1162 ③	18-1162	—
R/MR/Alpha One	1.98/1.84/1.65/1.50	1984-90	6225577 - UP	18-1160	18-1161 ① ④	18-1165
R/MR/Alpha One	1.5	1984-90	6225577 - UP	18-1160	18-1142	18-1165
R/MR/Alpha One	1.32	1984-90	6225577 - UP	—	—	18-1165
R/MR/Alpha One	1.5 Heavy Duty	1984-90	6225577 - UP	—	18-1142	18-1165
Alpha One SS	1.32	1986-89	A545004 - UP	—	—	18-1165
Alpha One SS	1.5	1986-89	A545004 - UP	—	18-1142	18-1165
Alpha One Gen II	2.40/1.98/1.84/1.65	1991-95	D469859 - F679999	18-1160	18-1161 ④	18-1165
Alpha One Gen II	1.5	1991-95	D469859 - F679999	18-1160	18-1142	18-1165
Alpha One Gen II	2.40/1.94/1.81/1.62	1996-97	F680000 - K999999	18-1160	18-1161 ④	18-1179
Alpha One Gen II	1.47	1996-97	F680000 - K999999	18-1160	18-1142	18-1179
Alpha One Gen II	2.40/2.00/1.94/1.81/1.62	1998 & Up	L100040 - UP	—	18-1161	18-1179
Alpha One Gen II	1.47	1998 & Up	L100040 - UP	—	18-1142	18-1179
II-TR	—	1973-76	3377316 - 4794899	18-1162 ②	18-1162	—
SSM II	—	1982-97	ALL	18-1162 ③	18-1162	—
TR/TRS	—	1977-93	4794900 - UP	18-1162 ③	18-1162	—
Bravo I, II, III	All	—	B664190 & UP	—	—	18-1129

- ① Timken Cone # 89449 / Cup 89410
- ② Straight Shoulder Gear Only
- ③ Bearing for U-Joint Yoke
- ④ Use 18-1142 for 1.5:1 Upper Gear Ratio

MERCURISER STERNDRIVE LOWER GEAR HOUSING BEARINGS

Sterndrive Model	Years	Beg. Serial # - End Serial #	Prop Bearing Carrier	Lower Drive Shaft (Pinion)	Upper Drive Shaft	Inside Forward Gear (Needle)	Outside Forward Gear	Reverse Gear
60	1965-66	1830753 - 2063740	—	—	—	—	18-1162	—
80/90	1966-72	2063741 - 3225967	18-1158	—	—	18-1157	18-1156	—
I	1963	1534570 - 1536617	18-1158	—	18-1153	18-1157	18-1156	—

- ① 18-1161 Top Bearing / 18-1163 Bottom Bearing
- ② Torrington#B1616
- ③ Prop Shaft Drive Gear
- ④ #15520 Stamped on Cup
- ⑤ Use 18-1173 for 2.40:1 ratio only (new style lower gears) our 18-2206-1



MERCURISER STERNDRIVE LOWER GEAR HOUSING BEARINGS (Cont.)

Sterndrive Model	Years	Beg. Serial # - End Serial #	Prop Bearing Carrier	Lower Drive Shaft (Pinion)	Upper Drive Shaft	Inside Forward Gear (Needle)	Outside Forward Gear	Reverse Gear
I	1963	1536618 - 1684187	18-1158	—	—	18-1157	18-1156	—
IA,IB,IC & EZ Shift	1964-66	1684188 - 2065189	18-1158	—	—	18-1157	18-1159	18-1155
120/140	1967-69	2062141 - 2791956	18-1158	—	—	18-1157	18-1159	18-1155
120/140	1970-77	2791957 - 4893634	18-1158	—	—	18-1157	18-1159	18-1155
120/140	1978-82	4893635 - 6225576	18-1158	18-1150	—	18-1157	18-1159	18-1155
470	1976-77	4208730 - 4893934	18-1158	—	—	18-1157	18-1159	18-1155
470/485	1978-82	4893835 - 6225576	18-1158	18-1150	—	18-1157	18-1159	18-1155
160	1967-69	2065190 - 2763441	18-1158	—	—	18-1157	18-1159	18-1155
165	1970-77	2763442 - 4890459	18-1158	—	—	18-1157	18-1159	18-1155
165	1978-81	4890460 - UP	18-1158	18-1150	—	18-1157	18-1159	18-1155
888	1971-77	3106717 - UP	18-1158	—	—	18-1157	18-1159	18-1155
225/233	1974-77	3856268 - UP	18-1158	—	—	18-1157	18-1159	18-1155
898/228	1977	4782330 - 4898729	18-1158	—	—	18-1157	18-1159	18-1155
898/228	1978-82	4898730 - 6225576	18-1158	18-1150	—	18-1157	18-1159	18-1155
250	1977	4791300 - 4898729	18-1158	—	—	18-1157	18-1159	18-1155
255-TRS	1973-74	3377316 - 4203749	18-1158	—	—	—	18-1159	N/A
260	1978-82	4898730 - 6225576	18-1158	18-1150	—	18-1157	18-1159	18-1155
280-TRS	1975-76	4203750 - 4895399	18-1158	—	—	—	18-1159	N/A
R	1983	6225577 - UP	18-1158	18-1150	—	18-1157	18-1159	18-1155
MR / Alpha One	1984-90	6225577 - UP	18-1158	18-1117	18-1143	—	18-1159 ⑤	18-1155
MR / Alpha One	1984-90	6225577 - UP	18-1158	18-1117	18-1143	18-1157 ②	18-1159 ⑤	18-1155
MR / Alpha One (CR)	1984-90	6225577 - UP	18-1158	18-1117	18-1143	—	—	—
Alpha One SS	1986-89	A545004 - UP	18-1158	18-1117	18-1143	18-1157	18-1159	18-1155
Alpha One Gen II	1991-95	D469859 - F679999	18-1158	18-1117	18-1143	18-1157	18-1159 ⑤	18-1155
Alpha One Gen II (CR)	1991-95	D469859 - F679999	18-1158	18-1117	18-1143	—	—	—
Alpha One Gen II	1996-97	F680000 - K999999	18-1158	18-1117	18-1143	18-1157	18-1156	18-1155
Alpha One Gen II (CR)	1996-97	F680000 - K999999	18-1158	18-1117	18-1143	—	—	—
Alpha One Gen II	1998-newer	L100040 - UP	18-1158	18-1117	18-1143	18-1157	18-1156 ③	18-1155
Alpha One Gen II (CR)	1998-newer	L100040 - UP	18-1158	18-1117	18-1143	—	—	—
II	1962-67	1474909 - 2275488	—	—	—	N/A	18-1156 ③	N/A
II	1968-69	2398798 - 2671321	—	—	—	—	18-1162	18-1156 ③
II-TR	1973-76	3377316 - 4794899	—	—	—	18-1161 ①	—	N/A
TR	1973-93	4794900 - UP	—	—	—	18-1161 ①	—	N/A
TRS	1973-93	4794900 - UP	18-1158	—	—	—	18-1159	N/A

① 18-1161 Top Bearing /
18-1163 Bottom Bearing

② Torrington#B1616
③ Prop Shaft Drive Gear

④ #15520 Stamped on Cup
⑤ Use 18-1173 for 2.40:1 ratio only (new style lower gears) our 18-2206-1

 <p>18-2349 SHIFT SHAFT SLEEVE Replaces: 23-67370</p>	 <p>18-2244 18-22441-9① (PKG. OF 50 WITHOUT GASKET) DRAIN PLUG Replaces: 10-79953A2, 10-79953, 10-79953Q04, 10-28634, 10-28634A1, 10-20259, 816610A1, 816610A2, F40109, 10-F50109 For: #1/R/MR/Alpha/Alpha I Gen II Both Upper And Lower Units</p>	 <p>② 18-2375D 18-2375 18-23751-9① (PKG. OF 50 WITHOUT GASKET) DRAIN PLUG MAGNET Replaces: 10-14834, 10-14834A1, 22-67892, 22-67892A1, 22-67892A05, 22-67892A06, 22-8M0058389 (Magnet) For: Alpha MR/Gen II lower units Not to be used on #1/R lower units</p>	 <p>18-2460 PLUG KIT Replaces: 22-88847A1, 11-88462 Fits: Mercuriser Stern Drives</p>
--	--	--	--

 <p>18-72005 NUT AND WASHER KIT Fits: Mercuriser R/MR/Alpha/Gen II Drives</p>	 <p>① 18-4220D 18-4220 THRUST WASHER Replaces: 13171, 77987 V-6, Outboards & Mercuriser Sterndrives</p>	 <p>18-3784 THRUST WASHER Replaces: 805100 Fits: Bravo III (Front)</p>
--	---	---



18-3701
PROP NUT KIT
 Replaces: 11-52707A1, 11-52707A2, 11-52707Q1

②18-3701D 

CONTAINS			
Part #	O.E. #	Description	Qty
18-3200	14-31210, 14-816629, 14-816629Q, 14-F697140	Tab Washer	2
18-3700	11-52707	Prop Nut	1



18-3755
PROP NUT KIT
 Fits: Bravo III (Front)



18-3756
PROP NUT KIT
 Fits: Bravo III (Rear)

PKG. OF 10



18-3200
18-3200-9①
TAB WASHER
 Replaces: 14-31210, 14-816629, 14-816629Q, 14-F697140



18-3787
TAB WASHER
 Replaces: 805101T
 Fits: Bravo III (Rear)

PKG. OF 10



18-3788-9①
TAB WASHER
 Replaces: 14-34817
 Fits: Bravo II



18-72510
STUD KIT
 Fits: Mercruiser Coupler to Flywheel



18-3783
PROP NUT
 Replaces: 11-859131, 11-805092, 11-805092T
 Fits: Bravo III (Front)



18-3785
PROP NUT
 Replaces: 11-82671127, 11-54034, 11-39907, 11-39823
 Fits: Bravo II



18-3786
PROP NUT
 Replaces: 11-862907, 11-805093
 Fits: Bravo III (Rear)



18-3700
PROP NUT
 Replaces: 11-52707, 11-827614, F7040
 3/4" - 20 thread • 1 1/16" wrench



18-3714
BRASS CASTLE WASHER
 Replaces: 12-31211A2, 12-31211, 12-31211A3, 12-31211Q03
 Fits: Alpha/Bravo I (without Flo-Torq II Hub)
 NOTE: Fits above product with rubber hub propellers (non-Flo-Torq II)



18-4444
PROP WRENCH
 Replaces: 91-95830A1, 91-95830, 91-38277A1



18-4446
PROP WRENCH KIT
 —CONTAINS—

Part #	O.E. #	Description
18-3200	14-31210, 14-816629	Tab Washer
18-3700	11-52707	Prop Nut
18-4444	91-95830A1	Prop Wrench



18-4459
PROP WRENCH
 Replaces: 91-821887A1, 91-859046Q4, 91-859046T4



18-2103
POWER TRIM HOSE
 Replaces: 32-47373, 32-66073, 32-68676, 32-73004, 32-79431, 32-86036, 32-86036A1, 32-86036Q

1/8" 14" 1/8" 

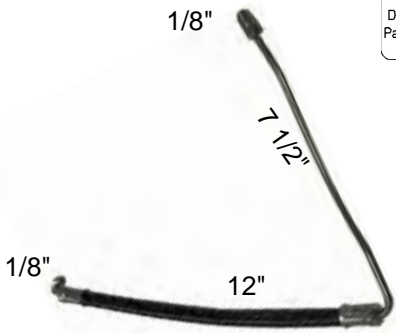

18-2105
POWER TRIM HOSE
Replaces: 32-45973



18-2106
POWER TRIM HOSE
Replaces: 32-45974



18-2107
POWER TRIM HOSE
Replaces: 32-55816



18-2108
POWER TRIM HOSE
Replaces: 32-59841, 32-59841A1, 32-73123



18-2109
POWER TRIM HOSE
Replaces: 32-59842, 32-73005

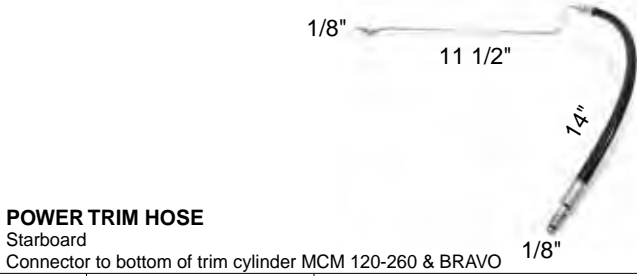

POWER TRIM HOSE
Starboard
Connector to bottom of trim cylinder MCM 120-260 & BRAVO

Part #	O.E. #	Description
18-2114	32-99902-1, 32-864960	Trim Cyl. Casting #14034-1
18-2136*	32-99902, 32-864589	Trim Cyl. Casting #98704, 98704-1

* Approximately 11 1/4" long

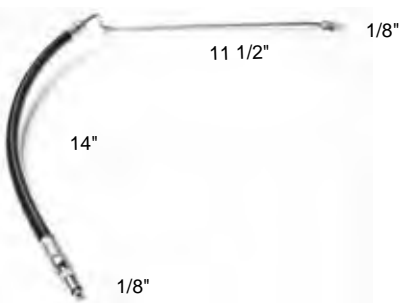

POWER TRIM HOSE
Port • Connector to bottom of trim cylinder MCM 120-260 & BRAVO

Part #	O.E. #	Description
18-2115	32-99903-1, 32-864959	Trim Cyl. Casting #14035-1
18-2137*	32-99903, 32-864588	Trim Cyl. Casting #98703, 98703-1

* Approximately 11 1/4" long

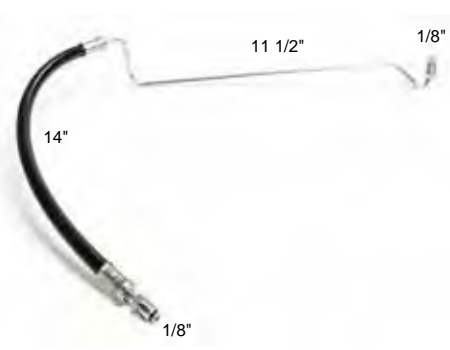

18-2112
POWER TRIM HOSE
Replaces: 32-87234

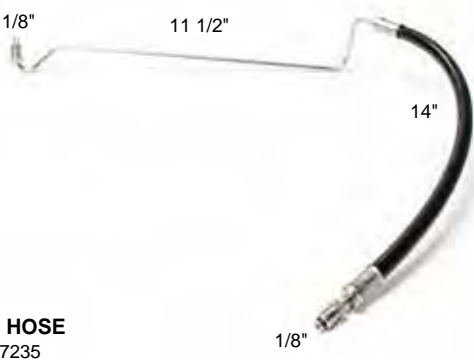

18-2113
POWER TRIM HOSE
Replaces: 32-87235



18-2435
POWER TRIM HOSE
Replaces: 32-861127, 32-95858
Fits: R/MR/Alpha/Alpha Gen II/Bravo I, II, III/Bravo X, XR, XZ
Serial number 0W09999 and below without quick connect fittings.
OEM hose color is black.

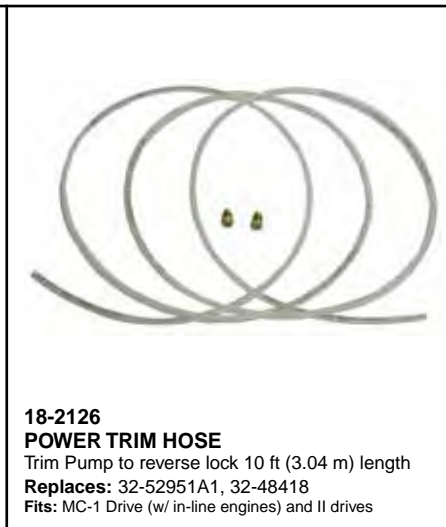
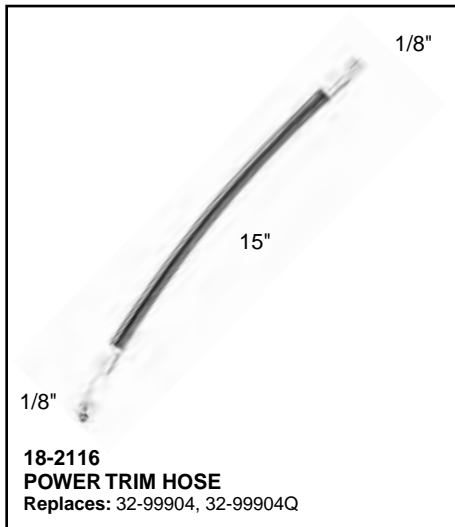

POWER TRIM HOSE APPLICATION

Stern Drive Model	Years	Serial #	Trim Cylinder to Connector (Port Down)	Trim Cylinder to Connector (Port Up)	Trim Cylinder to Connector (Stbd Down)	Trim Cylinder to Connector (Stbd Up)	Pump to Hydraulic Connector	Pump to Hydraulic Connector	Connector to Reverse Lock Valve	Hydraulic Pump & Reverse Lock Valve
120, 140	1967-69	2062141 - 2791956	—	18-2106	—	18-2105	—	N/A	—	18-2126
120, 140	1970-73	2791957 - 3780849	18-2103	18-2103	18-2103	18-2103	18-2107	N/A	—	18-2126
120, 140	1974-82	4893635 - 6225576	18-2103	18-2103	18-2103	18-2103	18-2107	N/A	18-2109	18-2126
470/485	1976-82	4208730 - 6225576	18-2103	18-2103	18-2103	18-2103	18-2107	N/A	18-2109	18-2126
160	1967-69	2065190 - 2763441	—	18-2106	—	18-2105	—	N/A	—	18-2126
165	1970-73	2763442 - 3780849	18-2103	18-2103	18-2103	18-2103	18-2107	N/A	—	18-2126
165	1974-81	3780850 & UP	18-2103	18-2103	18-2103	18-2103	18-2107	N/A	18-2109	18-2126
888	1974 & UP	3106717 & UP	18-2103	18-2103	18-2103	18-2103	18-2108	N/A	18-2109	—
225/233	1974-77	3856268 & UP	18-2103	18-2103	18-2103	18-2103	18-2108	N/A	18-2109	—
228/898/250/260	1977-82	4782330 - 6225576	18-2103	18-2103	18-2103	18-2103	18-2108	N/A	18-2109	—
R/MR/Alpha/SS	1983-90	6225577 & UP	18-2137 ③	18-2116	18-2136 ③	18-2116	18-2436	18-2435	N/A	N/A
R/MR/Alpha/SS	1983-90	6225577 & UP	18-2115 ④	18-2116	18-2114 ④	18-2116	18-2436	18-2435	N/A	N/A
Alpha One GEN II	1991-97	D469859 & UP	18-2115	18-2116	18-2114	18-2116	18-2436	18-2435	N/A	N/A
Alpha One GEN II ⑥	1998 & UP	0L100040 & UP	18-2115	18-2116	18-2114	18-2435	18-2436	18-2435	N/A	N/A
Bravo I,II & III ⑥	1988 & UP	B664190 & UP	18-2137	18-2116	18-2136	18-2116	18-2436	18-2435	N/A	N/A
Blackhawk	1994-95	F186717 & UP	18-2137	18-2116	18-2136	18-2116	18-2436	18-2435	N/A	N/A
II (1.78)	1968-69	2398798 - 2671321	18-2103	18-2103	18-2103	18-2103	—	N/A	—	18-2126
III	1968-72	2373127 - 3002613	18-2103	18-2103	18-2103	18-2103	—	N/A	—	—
215E/H	1970-72	2909035 - 2915034	18-2103	18-2103	18-2103	18-2103	—	N/A	—	—
TR/TRS	1973-93	3377316 & Up	18-2103 ②	18-2103	18-2103 ②	18-2103	—	N/A	—	—
TR/TRS	1973-93	3377316 & Up	18-2103 ②	18-2103	18-2103 ②	18-2103	—	N/A	—	—
TR/TRS	1973-93	3377316 & Up	— ①	18-2103	— ①	18-2103	—	N/A	—	—

① 90° hose end
② External trim lines

③ Internal cylinder lines
④ Oildyne pump

⑤ 18-2436 OEM hose color is gray, 18-2435 OEM hose color is black
⑥ Serial number 0W099999 and below without quick connect fittings.

- ★ High quality EPDM rubber cups
- ★ Metal hose connector complete with rubber washer
- ★ Use with a standard garden hose
- ★ Corrosion resistant dicromate finish
- ★ Installs in seconds
- ★ No tools required



Flushes cooling system of salts and sediments and allows engine to idle for tuning and engine adjustment in your own driveway. Simply slip attachment over the engine's side water intakes. Coated spring steel arms clamp suction cup securely over the engine's side water intakes.

STAINLESS STEEL LOCKNUTS



Part #	O.E. #	Thread Size	Std. Pkg.
*18-3720 ③	11-34932	3/8" - 24	1
*18-3721 ③	11-34933, 11-95702, 11-82671015, 11-46355, 11-33962, 11-29241, 11-24648, 11-22178, 11-21298	7/16" - 20	6
*18-3722 ③	11-35888, 11-20361, 11-8267089	1/4" - 28	5
*18-3723 ③	11-45592	5/16" - 24	1

*To order locknuts in a package of 5, add -9 to end of part number



18-9099
TRAILERING CLIPS
Replaces: 817019A1, 817019Q2, 817019A2, 879078, 86459A2, 86459A1, 86459, 41155A2, 41155A1, 32657A4, 32657A3
 I.D. 3/4" x 11 1/8" length
 For all ALPHA I, ALPHA Generation II, Bravo I, II, III, and Blackhawk



18-2372
TRIM CYLINDER END CAP
Replaces: 88035
 1.850 Cap Diameter
For: R/MR/Alpha



18-2373
TRIM CYLINDER END CAP
Replaces: 14698, 14698T, 14698T10 806191T, 8M0110717
 1.890 Cap Diameter
For: R/MR/Alpha/ Gen II/Bravo
 (Seals included)

PKG. OF 2



18-2465-9^④
PIVOT PIN END CAP
Replaces: 19-14842, 19-148421
For: R/MR/Alpha One (1983-90)
 Serial No. 6225577 and up
 I/II/III (1988-02) Serial No. 6225577

PKG. OF 2



18-2466-9^④
PIVOT PIN END CAP
Replaces: 19-815951
For: Alpha One Gen II (1991-02)
 Serial No. OD469859 and up



18-2461
TRIM CYLINDER ANCHOR PIN KIT
Replaces: 17-44166T1
For: Bravo I/II/III (1988-02)
 Serial No. 6225577 and up



18-2462
TRIM CYLINDER ANCHOR PIN KIT
Replaces: 17-14873A1, 17-85056
For: R/MR/Alpha One (1983-90)
 Serial No. 6225577 and up (Front)

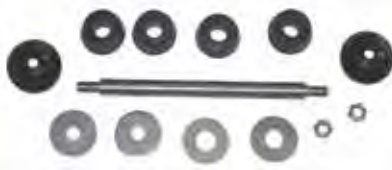

18-2463
TRIM CYLINDER ANCHOR PIN KIT
Replaces: 17-14872A1, 17-99207
For: R/MR/Alpha One (1983-90)
 Serial No. 6225577 and up (Rear)



18-2464
FRONT AND REAR ANCHOR PIN KIT
Replaces: 17-815953T1, 56-864641A24, 56-18541A75
For: All Alpha One Gen II



18-7633
TRIM SENDER/LIMIT KIT
Replaces: 805320A03, 805320A1, 96863A15, 88678A5, 88678A4, 63115A12, 17693A2
Fits: MC-I, R, MR, Alpha, Alpha Gen II, Bravo drives



18-2142
POWER TRIM CYLINDER
Replaces: 45706A1, 45706A3, 45706A6, 45706A8, 45706A12, 45706A14
Fits: All Stern Drive Models with internal lines: 120, 140, 160, 165, 888, 898, 228, 225-S, 233, 250, 260, 470 & 485



18-2148
POWER TRIM CYLINDER HOUSING
Replaces: 45523, 45706A4, 77442A1, 77443
Fits: All Stern Drive Models: 120, 140, 160, 165, 888, 898, 228, 225-S, 233, 250, 260, 470 & 485

^③ This product is priced per piece. To order priced per package, please add -9 to the part number.

^④ Priced per package



18-2420
POWER TRIM CYLINDER
Replaces: 14034A3, 14034A5, 14034F1, 14034T, 14034T10
For: R/MR/ALPHA (Starboard)



18-2421
POWER TRIM CYLINDER
Replaces: 14035A3, 14035A5, 14035F1, 14035T, 14035T10
For: R/MR/ALPHA (Port)



18-2422
POWER TRIM CYLINDER
Replaces: 815935A7, 815935A3
For: GEN II (Port) (S/N F680000 - UP)



18-2423
POWER TRIM CYLINDER
Replaces: 815954A7, 815954A3
For: GEN II (Starboard) (S/N F680000 - UP)



18-2424
POWER TRIM CYLINDER
Replaces: 98703A11, 98703A12, 98703A17, 98703A26
For: BRAVO (Port)



18-2425
POWER TRIM CYLINDER
Replaces: 98704A11, 98704A12, 98704A17, 98704A26, 8M0708280
For: BRAVO (Starboard)



18-2426
POWER TRIM CYLINDER
Replaces: 98703A3
For: R/MR/ALPHA (Port)



18-2427
POWER TRIM CYLINDER
Replaces: 98704A3
For: R/MR/ALPHA (Starboard)



18-2649
POWER TRIM SEAL KIT
Replaces: 25-87400A2



18-2291
TRIM CYLINDER REPAIR KIT
Replaces: 25-60342A2, 25-60342A1
Fits: All Stern Drive Models: 120, 140, 160, 165, 888, 898, 228, 225-S, 233, 250, 260, 470 & 485



18-2428
TRIM CYLINDER REPAIR KIT
Replaces: 87399A2, 87399A1
For: R/MR/ALPHA I, BRAVO



18-2429
TRIM CYLINDER REPAIR KIT
Replaces: 87399A3
For: ALPHA I GEN II

POWER TRIM CYLINDER APPLICATION

Model	Year	Serial No.	Trim Cylinder Port	Trim Cylinder Starboard	Housing Port	Housing Starboard	Trim Cylinder Seal Kit
120 / 140 4 cyl	1967-1969	2062141-2791956	18-2142	18-2142	N/A	N/A	N/A
120 / 140	1970-1977	2791957-4893634	18-2142	18-2142	N/A	N/A	18-2291
120 / 140	1978-1982	4893635-6225576	18-2142 ①	18-2142 ②	N/A	N/A	18-2291
120 / 140	1978-1982	4893635-6225576	N/A ③	N/A ④	N.L.A	N.L.A	18-2291
160 6 cyl	1967-1969	2062141-2791956	18-2142	18-2142	N/A	N/A	N/A
160	1967-1969	2065190-2763441	18-2142	18-2142	N/A	N/A	N/A
165	1970-1977	2763442-4890459	18-2142	18-2142	N/A	N/A	18-2291
165	1978-1981	4890460-4890459	18-2142 ⑤	18-2142 ⑥	N/A	N/A	18-2291
225 / 233	1974-1977	3856268 & UP	18-2142	18-2142	N/A	N/A	18-2291
250	1977	4791300-4898729	18-2142	18-2142	N/A	N/A	18-2291
260	1978-1982	4898730-6225576	18-2142 ⑦	18-2142 ⑧	N/A	N/A	18-2291
470 / 485	1976-1977	4208730-4893934	18-2142	18-2142	N/A	N/A	18-2291
470 / 485	1978-1982	4893835-6225575	18-2142 ⑨	18-2142 ⑩	N/A	N/A	18-2291
898 / 228	1977	4782330-4898729	18-2142	18-2142	N/A	N/A	18-2291
898 / 228	1978-1982	4898730-6225576	18-2142 ⑪	18-2142 ⑫	N/A	N/A	18-2291
ALL # 1 DRIVES ⑬	1970-1982	2791957-6225576	18-2142	18-2142	18-2148	18-2148	18-2291
R / MR / ALPHA I	1983-1990	6225577-D469858	18-2426 ⑬	18-2427 ⑭	N/A ⑮	N/A ⑯	18-2649
R / MR / ALPHA I	1983-1990	6225577-D469858	18-2426 ⑰	18-2427 ⑱	N/A ⑲	N/A ⑳	18-2649
R	1983-1990	6225577 & UP	18-2426 ㉑	18-2427 ㉒	N/A	N/A	18-2649
MR	1983-1990	6225577 & UP	18-2426 ㉓	18-2427 ㉔	N/A	N/A	18-2649
ALPHA I	1983-1990	6225577 & UP	18-2426 ㉕	18-2427 ㉖	N/A	N/A	18-2649
ALPHA I SS	1986-1989	A545004 & UP	18-2426 ㉗	18-2427 ㉘	N/A ㉙	N/A ㉚	18-2649
ALPHA I SS	1986-1989	A545004 & UP	18-2421 ㉛	18-2420 ㉜	N/A	N/A	18-2649
ALPHA I SS	1986-1989	A545004 & UP	18-2422	18-2423	N/A	N/A	18-2649
R	1983-1990	6225577 & UP	18-2421 ㉝	18-2420 ㉞	N/A	N/A	18-2649
MR	1983-1990	6225577 & UP	18-2421 ㉟	18-2420 ㊱	N/A	N/A	18-2649
ALPHA I	1983-1990	6225577 & UP	18-2421 ㊲	18-2420 ㊳	N/A	N/A	18-2649
ALPHA I GEN II	1991-2001	D469859 & UP	18-2422	18-2433	N/A	N/A	18-2649
BRAVO I	1988-2010	B664190 & UP	18-2424	18-2425	N/A	N/A	18-2649
BRAVO II	1988 & UP	B664190 & UP	18-2424	18-2425	N/A	N/A	18-2649
BRAVO III	1988 & UP	B664190 & UP	18-2424	18-2425	N/A	N/A	18-2649
BRAVO SEACORE	2007-2010	W900000 & UP	N/A	N/A	N/A	N/A	18-2649
BLACKHAWK	1994-1995	F186717 & UP	18-2424	18-2425	N/A	N/A	18-2649

- ① 11 3/8" LONG TUBES - INTERNAL CYLINDER LINES
- ② 13 3/4" LONG TUBES - INTERNAL CYLINDER LINES
- ③ CASTING #14034 1
- ④ CASTING 14035 1
- ⑤ CASTING #98703
- ⑥ CASTING #98703 1
- ⑦ CASTING #98704
- ⑧ CASTING #98704 1
- ⑨ INTERNAL TRIM LINES
- ⑩ USE WITH 15 9/16" LONG TRIM CYLINDER TUBE
- ⑪ USE WITH 16 3/16" LONG TRIM CYLINDER TUBE
- ⑫ EXTERNAL TRIM LINES
- ⑬ TRIM CYLINDER WITH INTERNAL TRIM LINES
- ⑭ TRIM CYLINDERS USING EXTERNAL TRIM LINES
- ⑮ USE WITH 16 3/16" LONG TRIM CYLINDER TUBE
- ⑯ EXCLUDES TR, TRS, 215E, H, & EARLY II & III DRIVES

PKG. OF 5



18-4252
18-4252-9⑦
CONTINUITY SPRING

Replaces: 24-46312
Grounds the trim cylinder to the pivot pin shaft.



18-2151
7 1/2" (Front)
Replaces: 17-45738

18-2152
10 1/2" (Rear)
Replaces: 17-45735

PIVOT PINS

Used on 120, 120-260, 140, 165, 225S, 233, 250, 470, 888, 898/228
Use **18-2701** Bushing



18-2393
TRIM CYLINDER PIVOT PIN

Replaces: 17-14872
For: Trim cylinder rear R/MR/Alpha
Use: 18-2702-1 Bushing

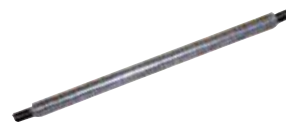

18-2394
TRIM CYLINDER PIVOT PIN

Replaces: 17-14873
3/8" - 24 thread
For: Trim cylinder front R/MR/Alpha
Use: **18-2702-1** Bushing



18-2395
TRIM CYLINDER PIVOT PIN

Replaces: 17-815953, 17-815953A1
For: Trim cylinder front & rear Gen II



18-2396
TRIM CYLINDER PIVOT PIN

9 1/4" overall length • 7 1/2" shaft length
Replaces: 17-44166
For: Rear Bravo

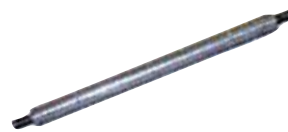

18-2397
TRIM CYLINDER PIVOT PIN

Replaces: 17-44167A1, 17-44167
For: Front Bravo

- ④ Standard package of 8 priced per piece
- ⑤ Standard package of 8 priced per package
- ⑥ Priced per Package of 4
- ⑦ Priced per Package

PKG. OF 8



POWER TRIM BUSHING
18-2701 18-2701-04
18-2701-9^④
Replaces: 23-89574, 23-61290, 23-45736
Fits: 120/260 Drive Units (S/N 6225276 & Down)

PKG. OF 8



POWER TRIM BUSHING
18-2702-1^⑤ **18-2702-04**^⑥
18-2702-1-9^④
Replaces: 23-99291, 23-99291T
Fits: 120/260 Drive Units (S/N 6225277 & UP)

PKG. OF 8



18-4288
18-4288-9^⑦
POWER TRIM BUSHING
Replaces: 23-807073, 23-44165
For: Bravo

PKG. OF 5



18-2345
18-2345-9^⑦
TRIM CYLINDER ANCHOR PIN E-RING
Replaces: 53-815949
For: Gen II

PKG. OF 2



18-4289
18-4289-9^⑦
RETAINING RING
Replaces: 53-805272
For: Bravo

PKG. OF 4



18-2336
18-2336-9^⑦
TRIM BUSHING
Replaces: 23-47392, 23-61291, 23-90203
For: TR & TRS(1977-93), Alpha One SS (1986-1989) , SSM(1982-1995)

PKG. OF 8



18-2341-1
18-2341-1-9^⑦
POWER TRIM BUSHING
Replaces: 23-815950, 23-8159501, 23-815950Q01
For: Gen II

PKG. OF 5



18-3232
18-3232-9^⑦
PLUG
Replaces: 19-47579, 19-475791
For: MR Alpha

Zinc is for saltwater only applications.
 Magnesium is for fresh water only applications.
 Aluminum is for brackish water or salt water environments.



18-6154A
18-6154M
18-6154Z
ANODE KIT
 Bravo III (2004 and Newer)



18-6158M
18-6158Z
18-6158A
ANODE KIT
Replaces: 888755Q01 (18-6158M), 888756Q01 (18-6158A), 97-888756Q03 (18-6158A, M), 888756A1 (18-6158A, M)
 Mercuriser Alpha I Gen II (1991 & UP)

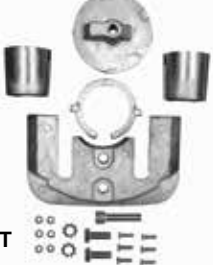

18-6159A
18-6159M
18-6159Z
ANODE KIT
Replaces: 888758Q01 (18-6159A), 888757Q01 (18-6159M), 97-888758Q03 (18-6160A), 888758A1 (18-6160A), 97-888759Q03 (18-6160M), 888759A1 (18-6160AM)
 Mercuriser Bravo I - All Years



18-6160A
18-6160M
18-6160Z
ANODE KIT
Replaces: 888761Q01 (18-6160A), 888761A1 (18-6160A), 97-888761Q03 (18-6160A), 888760Q01 (18-6160M), 97-888760Q03 (18-6160M), 888760A1 (18-6160M)
 Bravo II (1989 & Up), Bravo III (1989-03)



① **18-6117A**
 ② **18-6117M**
 ③ **18-6117Z**
ANODE
Replaces: 97-806188A1, 97-806188Q01
For: Bravo One bearing carrier



② **18-6241**
 ③ **18-6011**
 ① **18-6011A**
ANODE
Replaces: 31640, 31640A1, 97-31640Q4, 31640T6, 97-31640B4, 31640A4, 31640A2, 316404, 316403, 72436A1
For use on: R/MR/Alpha One, Sterndrive & Transom Assembly (1983-90) & prior drives, Alpha One, Gen II (1991 & up)



③ **18-6012**
ANODE
Replaces: 34127A1, 34127T2, 34127A2, 34127T1, 34127
For use on: R/MR/Alpha One (Sterndrive & Transom Assembly 1983-90) & prior drives



③ **18-6013**
ANODE
Replaces: 34762A1, 97-34672C, 32170, 32170A1
For use on: Alpha One SS (Sterndrive & Transom Assembly 1983-89) & prior drives



③ **18-6014**
 ① **18-6014A**
ANODE
Replaces: 46399A1, 822777A1, 822777Q1, 822777A4, 822777A3, 822777T2, 822777, 46399A2
For use on: Alpha One SS (1982-89)

PKG. OF 2



⑥③ **18-6015-9**
 ③⑤ **18-60151-9**
 ⑥① **18-6015A-9**
 ⑥② **18-6242-9**
ANODE
Replaces: 55989A3, 55989Q9, 55989T9, 55989A9, 55989A4, 55989
 Bravo I, II, III (1988-95)



③ **18-6016**
 ③④ **18-60161**
 ③⑤ **18-60161-9**
 ① **18-6016A**
 ② **18-6244**
ANODE
Replaces: 76214, 762142, 762142A1, 76214A5, 97-76214Q5, 76214A2, 97-762145
 200, 225, 250HP, V-155-V-200, & All Bravos, Alpha One, Gen II (1991 & up)
 (Threaded through)



③ **18-6066**
 ① **18-6066A**
 ② **18-6243**
ANODE
Replaces: 43994A2, 821631Q1, 821631C, 821631B1, 821631A1
For use on: R/MR/Alpha One (Sterndrive & Transom Assembly 1983-90)

① Aluminum ② Magnesium ③ Zinc
 ④ Standard package of 10 priced per piece ⑤ Standard package of 10 priced per package
 ⑥ Standard package of 2 priced per package

— CONTAINS —

Part #	Description	O.E. #	Qty.
18-2944	Seal Gasket	26-45577	1
18-2945	Gear Housing Drain Screw Gasket	12-19183	1
18-7163	O-Ring	25-33465	1
18-7159	O-Ring	25-31534	1
18-2002	Oil Seal	26-70019, 26-73838	2
18-0563	Seal	26-36556	1

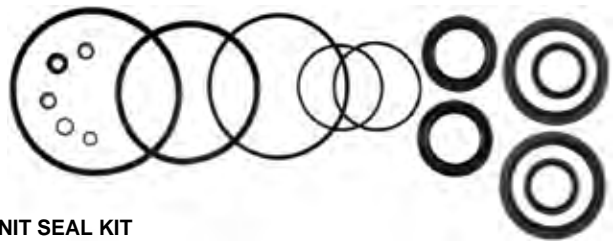

18-2645
LOWER UNIT SEAL KIT
Replaces: 26-76868A1, 26-76868A2, 26-76868A04
For: Bravo I, II & III MODELS

— CONTAINS —

Part #	Description	O.E. #	Qty.
18-2945	Gear Hsg. Drain Screw Gasket	12-19183	2
18-0894	Water Pocket Cover Gasket	27-55810	1
18-2003	Oil Seal	26-823894	1
18-2049	Oil Seal	26-32511	1
18-2056	Oil Seal	26-965031	1
18-2944	Seal Ring Gasket	26-45577	1
18-3110	Bushing	26-38970	1
18-7153	O-Ring	25-25439	2
18-7161	O-Ring	25-32546	1
18-7169	O-Ring	25-70937	1
18-7445	O-Ring	25-55801	1



18-2648
UPPER UNIT SEAL KIT
Replaces: 26-32511A1
S/N 1684188 & UP
For: #1 Units (Including ALPHA) (Also fits 888 Stern drive)
S/N 3106717 & UP

— CONTAINS —

Part #	Description	O.E. #	Qty.
18-2919	Water Pump to Gear Hsg. Gasket	27-42631-1	1
18-3110	Grommet	26-38970	1
18-2002	Oil Seal	26-70019, 26-73838	1
18-2013	Oil Seal	26-16977	2
18-2014	Oil Seal	26-89238	1
18-2826	Water Pump Base to Gear Hsg. Gasket	27-85610-1	1
18-2914	Lower Water Pump to Wear Plate Gasket	27-85608-1	1
18-2915	Upper Water Pump to Wear Plate Gasket	27-85609-1	1
18-2944	Seal Ring Gasket	26-45577	1
18-2948	Gear Housing Plastic Flush Screw Gasket	12-49221-1	1
18-7158	O-Ring	25-30613	1
18-7159	O-Ring	25-31534	1
18-7162	O-Ring	25-33145	1
18-7176	O-Ring	25-90011	1
—	O-Ring	25-38099	1
18-2154	Bushing, Shift Shaft	23-30617A2	1
18-2076	Line Cutter Oil Seal	26-12224	1
18-7426	O-Ring	25-30271	1
18-2945	Gear Housing Drain Screw Gasket	12-20260, 12-19183	2

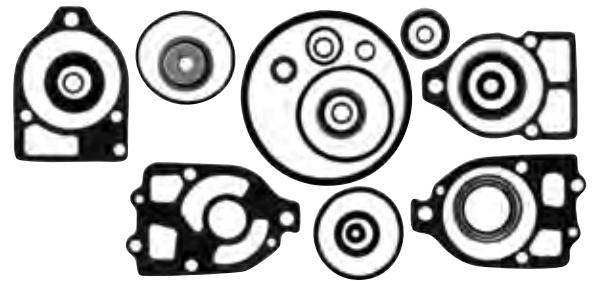

18-2652
LOWER UNIT SEAL KIT
Replaces: 26-33144A2, 26-33144A1, 26-89238A1
S/N 1684188 & UP
For: #1 Units (Including ALPHA)

— CONTAINS —

Part #	Description	O.E. #	Qty.
18-2652	Lower Gear Housing Seal Kit	26-33144A2	1
18-1155	Ball Bearing	30-88957A1	1
18-1117	Pinion Bearing	31-42647A1	1
18-1143	Tapered Roller Bearing	31-36387A1	1
18-3719	Pinion Nut	11-35921	1
18-2299	Tab Washer	14-79447	1
18-2298	Tab Washer	14-18323	1
18-1158	Needle Roller Bearing	31-30956	1
18-1159	Tapered Roller Bearing	31-35928A1	1
18-2285	Shim Kit	15-47397A1	1
18-1157	Needle Roller Bearing	31-30895	1
18-2343	Washer	12-982721	1
18-2294	Shim Kit	2470	1



18-8208
SEAL & BEARING KIT
Replaces: 31-803090T1
For: MR/Alpha Drive

— CONTAINS —

Part #	Description	O.E. #	Qty.
18-2340	Shift Shft Rubber Washer	12-31266	1
18-2076	Oil Seal	26-12224	1
18-7159	O-Ring	25-31534	1
18-2002	Oil Seal	26-76868	1
18-3109	Water Tube	23-29804	1
18-2154	Shift Bushing	23-30617A2	1
18-3116	Housing	46-96148A1	1
18-3017	Impeller	47-89984	1
18-2914	Water Pump Gasket	27-85608-1	1
18-7158	O-Ring	25-30613	1
18-7176	O-Ring	25-90011	1
18-2944	Seal Ring Gasket	26-45577	1
18-7173	O-Ring	25-30224	1
18-2826	Water Pump Base to Gear Housing Gasket	27-85610-1	1
18-2915	Water Pump Gasket	27-85609-1	1
18-3117	Plate	32435	1
18-7162	O-Ring	25-33145	1
18-2919	Water Pump Gasket	27-42631-1	1
18-2801	Water Pump Gasket	27-32438	1
18-7426	O-Ring	35-30271	1
18-2945	Drain Gasket	26-20260, 12-19183	2
18-3110	Grommet	26-38970	1
18-2013	Seal	26-16977	1
18-2014	Seal	26-89238	1



18-8370
COMPLETE LOWER GEAR CASE REBUILD KIT
Includes Water Pump and Complete Seal Kit
For: Mercuriser R/MR/ALPHA 1

Model	Year	Beginning Serial #	Ending Serial #	Driveshaft Hsg Seal Kit	J-Joint Seal	U-Joint Carrier Seal	Gear Hsg Seal & Brg Kit	Gear Hsg Seal Kit	Brg Carrier O-Ring	Brg Carrier Seal
60 / 80 / 90	1965-1972	1830753	3225967	N/A	N.L.A.	N/A	N/A	N/A	18-7160	18-2011
IA / IB / IC / EZ SHIFT	1964-1966	1684188	2065186	18-2648	18-2003	18-0577	N/A	18-2652	18-7159	18-2002
120 / 140	1967-1982	2062141	6225576	18-2648	18-2003	18-0577	N/A	18-2652	18-7159	18-2002
470 / 485	1976-1982	4208730	6225575	18-2648	18-2003	18-0577	N/A	18-2652	18-7159	18-2002
160 / 165	1967-1981	2065190	& UP	18-2648	18-2003	18-0577	N/A	18-2652	18-7159	18-2002
888	1971-1977	3106717	& UP	18-2648	18-2003	18-0577	N/A	18-2652	18-7159	18-2002
225 / 233	1974-1977	3856268	& UP	18-2648	18-2003	18-0577	N/A	18-2652	18-7159	18-2002
888 / 228 / 250 / 260	1977-1982	4782330	6225576	18-2648	18-2003	18-0577	N/A	18-2652	18-7159	18-2002
R	1983	6225577	& UP	18-2648	18-2003	18-0577	N/A	18-2652	18-7159	18-2002
MR ALPHA ONE	1984-1990	6225577	D469858	18-2648	18-2003	18-0577	18-8208	18-2652	18-7159	18-2002 ③
MR ALPHA ONE	1984-1990	6225577	D469858	18-2648	18-2003	18-0577	18-8208	18-2652	18-7159	18-2077 ①
MR ALPHA ONE	1984-1990	6225577	D469858	18-2648	18-2003	18-0577	18-8208	18-2652	18-7159	18-2076 ②
MR ALPHA ONE (CR)	1984-1990	6225577	D469858	18-2648	18-2003	18-0577	N.L.A.	18-2652	18-7159	18-2077 ①
MR ALPHA ONE (CR)	1984-1990	6225577	D469858	18-2648	18-2003	18-0577	N.L.A.	18-2652	18-7159	18-2076 ②
ALPHA ONE SS	1986-1989	A545004	& UP	18-2648	18-2003	18-0577	N/A	18-2652	18-7159	18-2002 ③
ALPHA ONE SS	1986-1989	A545004	& UP	18-2648	18-2003	18-0577	N/A	18-2652	18-7159	18-2077 ①
ALPHA ONE SS	1986-1989	A545004	& UP	18-2648	18-2003	18-0577	N/A	18-2652	18-7159	18-2076 ②
APLHA ONE GEN II	1991-1995	D469859	F679999	18-2644	18-2003	18-0577	N/A	18-2646-1	18-7159	18-2077 ①
APLHA ONE GEN II	1991-1995	D469859	F679999	18-2644	18-2003	18-0577	N/A	18-2646-1	18-7159	18-2076 ②
APLHA ONE GEN II (CR)	1991-1995	D469859	F679999	18-2644	18-2003	18-0577	N.L.A.	18-2646-1	18-7159	18-2077 ①
APLHA ONE GEN II (CR)	1991-1995	D469859	F679999	18-2644	18-2003	18-0577	N.L.A.	18-2646-1	18-7159	18-2076 ②
APLHA ONE GEN II	1996-1997	F680000	K999999	18-2644	18-2003	18-0577	N/A	18-2646-1	18-7159	18-2077 ①
APLHA ONE GEN II	1996-1997	F680000	K999999	18-2644	18-2003	18-0577	N/A	18-2646-1	18-7159	18-2076 ②
APLHA ONE GEN II (CR)	1996-2010	F680000	& UP	18-2644	18-2003	18-0577	N.L.A.	18-2646-1	18-7159	18-2077 ①
APLHA ONE GEN II (CR)	1996-2010	F680000	& UP	18-2644	18-2003	18-0577	N.L.A.	18-2646-1	18-7159	18-2076 ②
APLHA ONE GEN II	1998-2010	L100040	& UP	18-2644	18-2003	18-0577	N/A	18-2646-1	18-7159	18-2077 ①
APLHA ONE GEN II	1998-2010	L100040	& UP	18-2644	18-2003	18-0577	N/A	18-2646-1	18-7159	18-2076 ②
BRAVO I	1988-2010	B664190	& UP	18-2643	N/A	N/A	N/A	18-2645	18-7159	18-2002
BRAVO I X	2000-2010	M100001	& UP	18-2643	N/A	N/A	N/A	18-2645	18-7159	18-2002
BRAVO I XR/XZ	2000-2010	M100001	& UP	18-2643	N/A	N/A	N/A	N/A	18-7159	N/A
BRAVO II	1988-2010	B664190	& UP	18-2643	N/A	N/A	N/A	18-2645	N/A	N/A ②
BRAVO II	1988-2010	B664190	& UP	18-2643	N/A	N/A	N/A	18-2645	N/A	N/A ①
BRAVO II X	2000-2010	M100001	& UP	18-2643	N/A	N/A	N/A	18-2645	N/A	N/A ②
BRAVO II X	2000-2010	M100001	& UP	18-2643	N/A	N/A	N/A	18-2645	N/A	N/A ①
BRAVO III	1988-2010	B664190	& UP	18-2643	N/A	N/A	N/A	18-2645	N/A	N/A
BRAVO III X	2000-2010	M100001	& UP	18-2643	N/A	N/A	N/A	18-2645	N/A	N/A
BLACKHAWK	1994-1995	F186717	& UP	18-2643	N/A	N/A	N/A	N/A	N/A	N/A
I	1963	1534570	1684187	18-2648	N/A	18-0577	18-2652	N/A	18-7157	18-2002
II	1962-1969	1474909	2671321	N/A	N/A	N/A	N/A	N/A	18-7159	N.L.A.
III	1968-1972	2373127	3002613	N/A	N/A	N/A	N/A	N/A	N/A	N/A
215E/H	1970-1972	2909035	2915034	N/A	N/A	N/A	N/A	N/A	N/A	N/A
TR	1973-1993	3377316	& UP	N/A	N/A	N/A	N/A	N/A	N/A	N/A
TRS	1973-1993	3377316	& UP	N/A	N/A	N/A	N/A	N/A	18-7159	N/A

① Inner ② Outer ③ w/o Fishline Cutter Seal

②18-4456D



**18-4456
EXHAUST
PROTECTOR VALVE**
Replaces: 34765A1, 34765A2
INCLUDES STAINLESS STEEL CLAMP
3"

②18-4457D



**18-4457
EXHAUST
PROTECTOR VALVE**
Replaces: 12644A1, 12644Q01
INCLUDES STAINLESS STEEL CLAMP
4"

②18-4458D



**18-4458
EXHAUST
PROTECTOR VALVE**
(Fits both 5" & 6" Exhaust)
INCLUDES STAINLESS STEEL CLAMP

② Items ending in "D" are Display Packaged - Regular number is Non-Display

OIL SEALS

Part #	O.E. #	Shaft Size (in.)	Dimensions (in.)	
			O.D.	Width
18-0172	26-97530	0.845	1.500	0.315
18-0515	26-30530	0.540	1.004	0.303
18-0516	26-30913	0.500	0.839	0.187
18-0517	26-32911	1.100	1.260	0.127
18-0519	26-14240	3.792	4.536	0.482
18-0522	26-43036	1.045	1.474	0.187
18-0523	26-43993	1.640	2.132	0.282
18-0525	26-45587	0.390	0.628	0.124
18-0526	26-48443	0.750	1.379	0.256
18-0527	26-56397	0.750	1.127	0.343
18-0529	26-62818	1.640	2.256	0.319
18-0531	26-72785	0.790	1.880	0.248
18-0537	26-85107	1.020	1.507	0.251
18-0578	26-67388	1.800	3.100	0.500
18-2002	26-76868, 26-70019	1.188	1.692	0.25
18-2004	26-20070	0.625	1	0.25
18-2003	26-32080, 26-68493, 26-823894	2.25	3	0.437
18-2004	26-20070	0.625	1	0.25
18-2006	26-897154	0.625	1.125	0.312
18-2007	26-94038, 26-30727, 26-31489	1	1.5	0.312
18-2008	26-56788	0.875	1.25	0.375
18-2009	26-892361, 26-25776, 26-31249, 26-46021	0.375	0.75	0.25
18-2010	26-897153	0.437	0.875	0.25
18-2011	26-23300, 26-90562, 26-29595	0.75	1.25	0.312



Part #	O.E. #	Shaft Size (in.)	Dimensions (in.)	
			O.D.	Width
18-2013	802276, 26-16977, 26-20465, 26-31507, 26-79884	0.875	1.25	0.188
18-2014	26-33144, 26-77634, 26-89238, 26-F694305	0.875	1.5	0.312
18-2015	20250, 26-23517	0.75	1.25	0.25
18-2016	26-20079, 26-25837, 26-29476, 26-41953	1.187	1.875	0.25
18-2017	26-32121, 26-35025	0.75	1	0.125
18-2019	26-27163	0.688	1.124	0.25
18-2026 ①	802276, 26-16977, 26-20465, 26-31507, 26-79884	0.875	1.25	0.188
18-2048	26-24590	0.4	0.566	0.094
18-2049	26-32511	1.25	2.005	0.388
18-2050	26-55682	1	1.253	0.125
18-2051	26-69188	0.875	1.253	0.278
18-2052	26-69189	0.875	1.314	0.322
18-2053	26-70081	1.185	1.754	0.36
18-2054	26-76384, 26-8164641	0.375	0.75	0.243
18-2055	26-21642, 26-26782, 26-79831	0.75	1.127	0.149
18-2056	26-37259, 26-89237, 26-96503, 26-965031	0.875	1.375	0.250
18-2076 ①	26-F697118, 26-12224	1.188	1.690	0.360
18-2077	26-F697555, 26-14077	1.188	1.689	0.247

① Line Cutter Seal

DRIVESHAFT HOUSING

Stern Drive Model	Beg. S/N	End S/N	Oil Seal	Desc.	Qty.
R/MR/Alpha I	6225577	UP	18-2003	BC	1
Alpha I SS		ALL	18-2003	BC	1
Alpha I SS		ALL	18-2056	LDS	1
Alpha I SS		ALL	18-2049	GC	1
IA,IB,IC	1684188	2065189	18-2003	BC	1
I,IA,IB,IC	1534570	2065189	18-2049	GC	1
IA,IB,IC	1749276	2065189	18-2056	LDS	1
II	1474909	2671321	18-2003	BC	1
120/140	2062141	6225576	18-2003	BC	1
120/140	2062141	6225576	18-2056	LDS	1
120/140	2062141	6225576	18-2049	GC	1
160/165	2065190	UP	18-2003	BC	1
160/165	2065190	UP	18-2049	GC	1
160/165	2065190	UP	18-2056	LDS	1
225-S	3856268	4200499	18-2056	LDS	1
225-S	3856268	4200499	18-2049	GC	1
225-S	3856268	4200499	18-2003	BC	1
233	4200500	UP	18-2049	GC	1
233	4200500	UP	18-2003	BC	1
233	4200500	UP	18-2056	LDS	1

Stern Drive Model	Beg. S/N	End S/N	Oil Seal	Desc.	Qty.
250	4791300	4898729	18-2049	GC	1
250	4791300	4898729	18-2003	BC	1
250	4791300	4898729	18-2056	LDS	1
260	4898730	6225576	18-2049	GC	1
260	4898730	6225576	18-2056	LDS	1
260	4898730	6225576	18-2003	BC	1
470	4208730	6225576	18-2056	LDS	1
470	4208730	6225576	18-2003	BC	1
470	4208730	6225576	18-2049	GC	1
485	4893835	UP	18-2003	BC	1
485	4893835	UP	18-2049	GC	1
485	4893835	UP	18-2056	LDS	1
888	3106717	UP	18-2056	LDS	1
888	3106717	UP	18-2049	GC	1
888	3106717	UP	18-2003	BC	1
898/228	4782330	6225576	18-2049	GC	1
898/228	4782330	6225576	18-2003	BC	1
898/228	4782330	6225576	18-2056	LDS	1

BC Bearing Carrier Seal
GC Gear Chamber Seal
LDS Lower Driveshaft Seal

GEAR HOUSING

Stern Drive Model	Beg. S/N	End S/N	Oil Seal	Desc.	Qty.
MR/Alpha I	6225577	UP	18-2002	PS	2
R/MR/Alpha I	6225577	UP	18-2009	SSB	1
R/MR/Alpha I	6225577	UP	18-2014	WPB,L	1
MR/Alpha I	6225577	UP	18-2013	WPB,U	1
R	6225577	UP	18-2013	WPB,U	1
Alpha I SS	ALL		18-2014	WPB,L	1
Alpha I SS	ALL		18-2009	SSB	1

Stern Drive Model	Beg. S/N	End S/N	Oil Seal	Desc.	Qty.
Alpha I SS	ALL		18-2013	WPB,U	1
Alpha I SS	ALL		18-2002	PS	2
BRAVO I	B664190	UP	18-2002	PS	2
I	1534570	1536617	18-2009	WPB	1
I	1534570	1684187	18-2009	SSB	1
I	1534570	1684187	18-2002	PS	2
I	1534570	1684187	18-2013	WP	1

GEAR HOUSING (Cont.)

Stern Drive Model	Beg. S/N	End S/N	Oil Seal	Desc.	Qty.
I	1536618	1684187	18-2014	WPB	1
I	1563354	1684187	18-2013	WPB	1
IA,IB,IC	1684188	2065189	18-2014	WPB	1
IA,IB,IC	1684188	2065189	18-2002	PS	2
IA,IB,IC	1684188	2065189	18-2013	WPB	1
IA,IB,IC	1684188	2065189	18-2013	WP	1
IA,IB,IC	1684188	2065189	18-2009	SSB	1
TRS	4794900	UP	18-2002	PS	2
60	1830753	2063740	18-2009	SSB	1
60	1830753	2063740	18-2011	WPB,L	1
60	1830753	2063740	18-2055	WPB,U	1
60	1830753	2063740	18-2015	PS,O	1
60	1830753	2063740	18-2011	PS,I	1
80	2063741	2898029	18-2002	PS	2
80	2063741	2898029	18-2009	SSB	1
80	2063741	2898029	18-2055	WPB,U	1
80	2063741	2898029	18-2011	WPB,L	1
90	2898020	3225967	18-2009	SSB	1
90	2898020	3225967	18-2002	PS	2
90	2898020	3225967	18-2011	WPB,L	1
90	2898020	3225967	18-2055	WPB,U	1
120/140	2062141	6225576	18-2013	WPB,U	1
120/140	2062141	4893634	18-2013	WP	1
120/140	2062141	6225576	18-2014	WPB,L	1
120/140	2062141	6225576	18-2009	SSB	1
120/140	2062141	6225576	18-2002	PS	2
160/165	2065190	UP	18-2009	SSB	1
160/165	2065190	UP	18-2014	WPB,L	1
160/165	2065190	UP	18-2002	PS	2
160/165	2065190	4890459	18-2013	WP	1
160/165	2065190	UP	18-2013	WPB,U	1
225-S	3856268	4200499	18-2013	WPB,U	1
225-S	3856268	4200499	18-2014	WPB,L	1
225-S	3856268	4200499	18-2002	PS	2
225-S	3856268	4200499	18-2009	SSB	1

Stern Drive Model	Beg. S/N	End S/N	Oil Seal	Desc.	Qty.
233	4200500	UP	18-2009	SSB	1
233	4200500	UP	18-2013	WPB,U	1
233	4200500	UP	18-2002	PS	2
233	4200500	UP	18-2014	WPB,L	1
250	4791300	4898729	18-2013	WPB,U	1
250	4791300	4898729	18-2014	WPB,L	1
250	4791300	4898729	18-2002	PS	2
250	4791300	4898729	18-2009	SSB	1
255-TRS	3377316	4203749	18-2002	PS	2
260	4898730	6225576	18-2009	SSB	1
260	4898730	6225576	18-2002	PS	2
260	4898730	6225576	18-2013	WPB,U	1
260	4898730	6225576	18-2014	WPB,L	1
280-TRS	4203750	4895399	18-2002	PS	2
470	4208730	6225576	18-2009	SSB	1
470	4208730	6225576	18-2014	WPB,L	1
470	4208730	6225576	18-2002	PS	2
470	4208730	6225576	18-2013	WPB,U	1
485	4893835	UP	18-2002	PS	2
485	4893835	UP	18-2009	SSB	1
485	4893835	UP	18-2013	WPB,U	1
485	4893835	UP	18-2014	WPB,L	1
888	3106717	UP	18-2014	WPB,L	1
888	3106717	UP	18-2009	SSB	1
888	3106717	UP	18-2013	WP	1
888	3106717	UP	18-2013	WPB,U	1
888	3106717	UP	18-2002	PS	2
898/228	4782330	6225576	18-2014	WPB,L	1
898/228	4782330	6225576	18-2013	WPB,U	1
898/228	4782330	6225576	18-2009	SSB	1
898/228	4782330	6225576	18-2002	PS	2

PS Prop Shaft Seal WPB Water Pump Base Seal
 PS,I Prop Shaft, Inner Seal WPB,L Water Pump Base, Lower Seal
 PS,O Prop Shaft, Outer Seal WPB,U Water Pump Base, Upper Seal
 SSB Shift Shaft Bushing Seal WP Water Pump Body Seal

O-RINGS

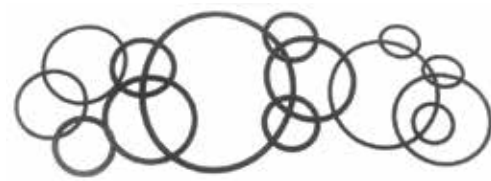

Part #	O.E. #	DIMENSIONS (in.)	
		O.D.	Width
18-0175 ③ ⑤	25-26543	0.22	0.103
18-0858 ③ ⑤	25-54029	2.8	0.103
18-0860 ③ ⑤	25-62700	3.237	0.103
18-7103 ②	25-29845	0.924	0.103
18-7105 ④ ⑤	25-62705, 25-F7848342	0.75	0.065
18-7107 ② ⑤	25-67202	4.75	0.135
18-7114 ② ⑤	25-23145, 25-843315, 25-F702736	1	0.135
18-7115 ①	25-26722	1.735	0.135
18-7116 ①	25-62704, 25-85148, 25-22174, 25-20633, 802206, 25-F24342	0.36	0.1
18-7117 ②	25-35027	1.046	0.139
18-7120 ①	25-38933	0.215	0.065
18-7121 ①	25-35029, 25-882613, 802231	3.1	0.135
18-7127 ①	25-32507, F83404	3.315	0.35
18-7134 ②	25-20195, 25-201951	0.5	0.1

Part #	O.E. #	DIMENSIONS (in.)	
		O.D.	Width
18-7135 ①	25-20365, 25-35276	0.75	0.135
18-7143 ② ⑤	27-58025, 25-65936, 391-5081	1.31	0.1
18-7145 ② ⑤	25-64068	0.25	0.1
18-7146 ② ⑤	25-47632	1.12	0.1
18-7151 ② ⑤	25-20081, 25-39572	3	0.135
18-7152 ② ⑤	25-20863	2.625	0.135
18-7153 ② ⑤	25-25439, 25-20679, 25-F53795-1, F53795	0.862	0.103
18-7155 ② ⑤	25-26855	1.62	0.135
18-7156 ② ⑤	25-29439	1.185	0.1
18-7157 ② ⑤	25-29976	3.5	0.21
18-7158 ② ⑤	25-30613, 25-846357	0.74	0.1
18-7159 ② ⑤	25-31534, 25-48451	3.855	0.21
18-7160 ② ⑤	25-31986	2.635	0.21
18-7161 ② ⑤	25-32546	3.25	0.07
18-7162 ② ⑤	25-32424, 25-33145	2.025	0.135
18-7163 ② ⑤	25-33465, 25-853220, 25-807149	2.415	0.1
18-7164 ② ⑤	25-33466, 25-67675, 25-846356, 27-898101789	1.375	0.1
18-7165 ② ⑤	25-32509, 25-806609, 25-F461342	0.5	0.065
18-7166 ② ⑤	25-45254	0.615	0.065

CONTINUED ON NEXT PAGE

O-RINGS (CONT.)

Part #	O.E. #	DIMENSIONS (in.)		Part #	O.E. #	DIMENSIONS (in.)	
		O.D.	Width			O.D.	Width
18-7167 ② ⑤	25-861844	3.809	0.139	18-7411 ② ⑤	25-35480, 25-47386, 25-8M2000816	1.25	0.1
18-7168 ② ⑤	25-20587, 25-21720, 25-26834, 25-48171, 25-801334436	0.37	0.065	18-7413 ② ⑤	22-22175, 25-62702, 25-F50342-1, F50342, F17510	0.301	0.07
18-7169 ② ⑤	25-35984, 25-70937	3.5	0.135	18-7414 ② ⑤	25-823683, 25-62384	1.989	0.07
18-7170 ② ⑤	25-33504	1.365	0.135	18-7415 ② ⑤	25-64966	3.739	0.07
18-7171 ② ⑤	25-30529	1.92	0.1	18-7419 ④ ⑤	25-69202	2.675	0.103
18-7172 ② ⑤	25-31305	3.25	0.135	18-7420 ③ ⑤	25-21836	0.796	0.139
18-7173 ② ⑤	25-27018, 25-30224Q	1.875	0.135	18-7421 ① ⑤	25-16524	0.15	0.065
18-7174 ② ⑤	25-45711, 25-F455342	0.62	0.1	18-7426 ③ ⑤	25-30271	0.74	0.31
18-7175 ② ⑤	25-62817	3.75	0.27	18-7440-1 ③	25-36318	0.799	0.103
18-7176 ② ⑤	25-896523, 25-F74305, F74305-1, F74305, F694555	2.16	0.1	18-7445 ③ ⑤	25-55801	0.801	0.07
18-7177 ② ⑤	25-53421, 25-59712	2.625	0.065	18-7449 ①	25-97387	4.487	0.103
18-7180 ③ ⑤	12-31060, 25-26802, 25-8M2000926	0.445	0.09	18-7459 ①	20311, 25-20826	2.234	0.139
18-7188 ②	25-805726	0.361	0.0635	18-7464 ①	25-39695, 25-846361	4.234	0.139
18-7195 ②	25-8M0027717	2.75	0.07	18-7467 ③ ⑤	25-54030, 25-F523555, F532555	2.987	0.103
18-7198 ② ⑤	25-45710	1.43	0.1	18-7474 ①	25-94288	1.239	0.07
18-7410 ② ⑤	25-36390	0.676	0.07	18-7961 ①	25-47254, 25-861844, 785-97386	3.65	0.135

① PKG. OF 1 ② PKG. OF 5 ③ PKG. OF 2 ④ PKG. OF 3

DRIVESHAFT HOUSING

Stern Drive Model	Beg. S/N	End S/N	Oil Seal	Desc.	Qty.	Stern Drive Model	Beg. S/N	End S/N	Oil Seal	Desc.	Qty.
R/MR/Alpha I	6225577	UP	18-7153	UJ	2	215E □	2909035	2915034	18-7174	FC	1
R/MR/Alpha I	6225577	UP	18-7169	BC	1	215E	2909035	2915034	18-7146	CC	1
R/MR/Alpha I	6225577	UP	18-7161	TC	1	225-S	3856268	4200499	18-7153	UJ	2
Alpha I SS	ALL		18-7161	TC	1	225-S	3856268	4200499	18-7169	BC	1
Alpha I SS	ALL		18-7169	BC	1	225-S	3856268	4200499	18-7161	TC	1
Alpha I SS	ALL		18-7153	UJ	2	233	4200500	UP	18-7161	TC	1
BRAVO (I/II)	B664190	UP	18-7198	DSH	1	233	4200500	UP	18-7153	UJ	2
BRAVO (I/II)	B664190	UP	18-7153	UJ	2	233	4200500	UP	18-7169	BC	1
I	1534570	1684187	18-7127	DG	1	250	4791300	4898729	18-7153	UJ	2
I,IA,IB,IC	1534570	1777798	18-7165	USSL	1	250	4791300	4898729	18-7169	BC	1
I,IA,IB,IC	1535212	2065189	18-7170	BH	2	250	4791300	4898729	18-7161	TC	1
IA,IB,IC	1684188	2065189	18-7153	UJ	2	255-TRS	3377316	4203749	18-7175	DSH	1
IA,IB,IC	1684188	2065189	18-7169	BC	1	260	4898730	6225576	18-7169	DG	1
II	2398798	2671321	18-7153	UJ	2	260	4898730	6225576	18-7161	TC	1
II SSM	ALL		18-7175	DSH	1	260	4898730	6225576	18-7170	BH	1
II SSM	ALL		18-7153	UJ	2	260	4898730	6225576	18-7153	UJ	2
II TR	3377316	4794899	18-7175	DSH	1	280-TRS	4203750	4895399	18-7175	DSH	1
III/III SSM	ALL		18-7115	FC	1	470	4208730	6225576	18-7169	BC	1
IV SSM □	ALL		18-7115	FC	1	470	4208730	6225576	18-7161	TC	1
I/IA/IB/IC	1534570	2065189	18-7161	TC	1	470	4208730	6225576	18-7153	UJ	2
TR/TRS ③	4794900	UP	18-7153	UJ	2	470	4893835	6225576	18-7170	BH	1
TR/TRS	4794900	UP	18-7175	DSH	1	485	4893835	UP	18-7161	TC	1
120/140	2062141	6225576	18-7161	TC	1	485	4893835	UP	18-7170	BH	1
120/140	2062141	6225576	18-7170	BH	1	485	4893835	UP	18-7153	UJ	2
120/140	2062141	6225576	18-7169	DG	1	485	4893835	UP	18-7169	DG	1
120/140	2062141	6225576	18-7153	UJ	2	888	3106717	UP	18-7161	TC	1
160/165	2065190	UP	18-7170	BH	1	888	3106717	UP	18-7169	BC	1
160/165	2065190	UP	18-7169	DG	1	888	3106717	UP	18-7153	UJ	2
160/165	2065190	UP	18-7153	UJ	2	898/228	4782330	6225576	18-7169	BC	1
160/165	2065190	UP	18-7161	TC	1	898/228	4782330	6225576	18-7161	TC	1
215H	2782203	2909034	18-7153	UJ	2	898/228	4782330	6225576	18-7153	UJ	2
215H	2782203	2909034	18-7146	PC	1	898/228	4898730	6225576	18-7170	BH	1

- | | |
|--|--|
| <ul style="list-style-type: none"> ① 1 ST Design ② 5/8" ID ③ With Borg Warner Transmission BC Bearing Carrier Seal BH Bell Housing Seal CC Crankshaft Cover Seal DG Drive Gear Seal | <ul style="list-style-type: none"> DSH Driveshaft Housing Seal FC Front Cover Seal PC Plug Cover Seal TC Top Cover Seal USSL Upper Shift Shaft Lever Seal UJ U-Joint Yoke Seal |
|--|--|

GEAR HOUSING

Stern Drive Model	Beg. S/N	End S/N	Oil Seal	Desc.	Qty.	Stern Drive Model	Beg. S/N	End S/N	Oil Seal	Desc.	Qty.
R/MR/Alpha I	6225577	UP	18-7162	WPB	1	160/165	2065190	UP	18-7158	UDS	1
MR/Alpha I	6225577	UP	18-7176	WPB	1 ②	160/165	2065190	UP	18-7159	PBH	1
R/MR/Alpha I	6225577	UP	18-7158	UDS	1	165	4890460	UP	18-7114	GH	1 ③
R/MR/Alpha I	6225577	UP	18-7159	PBH	1	225-S	3856268	4200499	18-7153	SSB	1
R/MR/Alpha I	6225577	UP	18-7153	SSB	1	225-S	3856268	4200499	18-7162	WPB	1
Alpha I SS	ALL		18-7159	PBH	1	225-S	3856268	4200499	18-7158	UDS	1
Alpha I SS	ALL		18-7158	UDS	1	225-S	3856268	4200499	18-7159	PBH	1
Alpha I SS	ALL		18-7153	SSB	1	233	4200500	UP	18-7162	WPB	1
Alpha I SS	ALL		18-7176	WPB	1 ②	233	4200500	UP	18-7158	UDS	1
BRAVO I	B664190	UP	18-7159	PBH	1	233	4200500	UP	18-7159	PBH	1
BRAVO I/II	B664190	UP	18-7163	GH	1	233	4200500	UP	18-7153	SSB	1
I	1534570	1684187	18-7157	PBH	1	250	4791300	4898729	18-7159	PBH	1
I	1534570	1536617	18-7153	WPB	1	250	4791300	4898729	18-7158	UDS	1
I	1534570	1684187	18-7153	SSB	1	250	4791300	4898729	18-7162	WPB	1
I,IA,IB,IC	1534570	2065189	18-7158	UDS	1	250	4791300	4898729	18-7153	SSB	1
I,IA,IB,IC	1536618	2065189	18-7162	WPB	1	255-TRS	3377316	4203749	18-7159	PBH	1
IA,IB,IC	1684188	2065189	18-7159	PBH	1	260	4898730	6225576	18-7162	WPB	1
IA,IB,IC	1684188	1777798	18-7153	WPB	1	260	4898730	6225576	18-7159	PBH	1
IA,IB,IC	1684188	2065189	18-7153	SSB	1	260	4898730	6225576	18-7153	SSB	1
II	1474909	2671321	18-7159	PBH	1	260	4898730	6225576	18-7158	UDS	1
III	ALL		18-7151	BRL	1	260	4898730	6225576	18-7114	GH	1 ③
III	ALL		18-7174	BRS	1	280-TRS	4203750	4895399	18-7159	PBH	1
TRS	4794900	UP	18-7159	PBH	1	470	4208730	6225576	18-7159	PBH	1
60	1830753	2063740	18-7153	SSB	1	470	4208730	6225576	18-7162	WPB	1
60	1830753	2063740	18-7160	PBH	1	470	4208730	6225576	18-7158	UDS	1
60	1830753	2063740	18-7155	WOAL	1	470	4208730	6225576	18-7153	SSB	1
60	1830753	2063740	18-7114	WOAS	1	470	4893835	6225576	18-7114	GH	1 ①
80	2063741	2898029	18-7157	PBH	1	485	4893835	UP	18-7158	UDS	1
80	2063741	2898029	18-7155	WOAL	1	485	4893835	UP	18-7162	WPB	1
80	2063741	2898029	18-7114	WOAS	1	485	4893835	UP	18-7153	SSB	1
80	2063741	2898029	18-7153	SSB	1	485	4893835	UP	18-7114	GH	1 ①
90	2898020	3225967	18-7114	WOAS	1	485	4893835	UP	18-7159	PBH	1
90	2898020	3225967	18-7157	PBH	1	888	3106717	UP	18-7162	WPB	1
90	2898020	3225967	18-7153	SSB	1	888	3106717	UP	18-7158	UDS	1
90	2898020	3225967	18-7155	WOAL	1	888	3106717	UP	18-7153	SSB	1
120/140	2062141	6225576	18-7153	SSB	1	888	3106717	UP	18-7159	PBH	1
120/140	2062141	6225576	18-7158	UDS	1	898/228	4782330	6225576	18-7158	UDS	1
120/140	2062141	6225576	18-7159	PBH	1	898/228	4782330	6225576	18-7153	SSB	1
120/140	2062141	6225576	18-7162	WPB	1	898/228	4782330	6225576	18-7159	PBH	1
120/140	4893635	6225576	18-7114	GH	1 ③	898/228	4782330	6225576	18-7162	WPB	1
160/165	2065190	UP	18-7162	WPB	1	898/228	4898730	6225576	18-7114	GH	1 ①
160/165	2065190	UP	18-7153	SSB	1						

- ① 2.019 ID
- ② 2.17 ID
- ③ V-8 Engines Only
- BRL Bearing Retainer Large Seal
- BRS Bearing Retainer Small Seal
- GH Gear Housing Seal
- PGH Prop Bearing Housing Seal
- SSB Shift Shaft Bushing
- UDS Upper Driveshaft Seal
- WOAL Water & Oil Adapter Large Seal
- WOAS Water & Oil Adapter Small Seal
- WPB Water Pump Base Seal

GIMBAL HOUSING

Stern Drive Model	Beg. S/N	End S/N	Oil Seal	Desc.	Qty.	Stern Drive Model	Beg. S/N	End S/N	Oil Seal	Desc.	Qty.
R/MR/Alpha I	6225577	UP	18-7170	BH	1	II	1602186	2671321	18-7162	GHAS	1
BRAVO (I/II)	B664190	UP	18-7168	V	2 ①	II	1732380	2671321	18-7172	GHAL	1
I	1534570	1641940	18-7165	GHB	2	III/III SSM/IV		ALL	18-7159	BH	1
II	1474909	1475005	18-7151	SL	1	60	1830753	2063740	18-7172	BH	1

- ① With Oil Reservoir
- BH Bell Housing Seal
- EE Exhaust Elbow Seal
- GH Gimbal Housing Seal
- GHAL Gimbal Housing Adapter Large Seal
- GHAS Gimbal Housing Adapter Small Seal
- GHB Gimbal Housing Bolt Seal
- SL Steering Lever Seal
- V Valve Seal

⑤ This product is priced per piece. To order priced per package, please add -9 to the part number.

GIMBAL HOUSING (CONT.)

Stern Drive Model	Beg. S/N	End S/N	Oil Seal	Desc.	Qty.
80	2063741	2898029	18-7172	BH	1
90	2898020	3225967	18-7172	BH	1
120/140	2062141	6225576	18-7152	EE	1
160/165	2065190	UP	18-7152	EE	1
225-S	3856268	4200499	18-7170	BH	1
225-S	3856268	4200499	18-7152	EE	1
225-S	3856268	4200499	18-7114	GH	1
233	4200500	UP	18-7152	EE	1
233	4200500	UP	18-7114	GH	1
233	4200500	UP	18-7170	BH	1
250	4791300	4898729	18-7152	EE	1
250	4791300	4898729	18-7114	GH	1
250	4791300	4898729	18-7170	BH	1
260	4898730	6225576	18-7152	EE	1
470	4208730	6225576	18-7152	EE	1

Stern Drive Model	Beg. S/N	End S/N	Oil Seal	Desc.	Qty.
470	4208730	4893934	18-7170	BH	1
485	4893835	UP	18-7152	EE	1
888	3106717	UP	18-7170	BH	1
888	3106717	UP	18-7114	GH	1
888	3106717	UP	18-7152	EE	1
898/228	4782330	4898729	18-7170	BH	1
898/228	4782330	4898729	18-7114	GH	1
898/228	4782330	6225576	18-7152	EE	1

- ① With Oil Reservoir
- BH Bell Housing Seal
- EE Exhaust Elbow Seal
- GH Gimbal Housing Seal
- GHAL Gimbal Housing Adapter Large Seal
- GHAS Gimbal Housing Adapter Small Seal
- GHB Gimbal Housing Bolt Seal
- SL Steering Lever Seal
- V Valve Seal

HYDRAULIC PUMP ASSY

Stern Drive Model	Beg. S/N	End S/N	Oil Seal	Desc.	Qty.
R/MR/Alpha I	6225577	UP	18-7168	CV	4
BRAVO (I/II)	B664190	UP	18-7134	ORC	1
BRAVO (I/II)	B664190	UP	18-7158	ORS	1
II	2398798	2671321	18-7168	CV	4
II TR	3377316	4794899	18-7168	CV	4
III/III SSM/IV		ALL	18-7168	CV	4
TR/TRS	4794900	UP	18-7168	CV	4
90	2898020	3225967	18-7168	CV	4
120/140	2062141	6225576	18-7168	CV	4
160/165	2065190	UP	18-7168	CV	4

Stern Drive Model	Beg. S/N	End S/N	Oil Seal	Desc.	Qty.
215H/E	2782203	2915034	18-7168	CV	4
225-S	3856268	4200499	18-7168	CV	4
233	4200500	UP	18-7168	CV	4
255-TRS	3377316	4203749	18-7168	CV	4
260	4898730	6225576	18-7168	CV	4
280-TRS	4203750	4895399	18-7168	CV	4
470	4208730	6225576	18-7168	CV	4
485	4893835	UP	18-7168	CV	4
888	3106717	UP	18-7168	CV	4
898/228	4898730	6225576	18-7168	CV	4

CV - Control Valve ORC - Oil Reservoir Connector ORS - Oil Reservoir Switch

REVERSE LOCK VALVE

Stern Drive Model	Beg. S/N	End S/N	Oil Seal	Desc.	Qty.
R/MR/Alpha I	6225577	UP	18-7174	VC	1
R/MR/Alpha I	6225577	UP	18-7198	V	1
II	2398798	2671321	18-7198	V	1
II	2398798	2671321	18-7174	VC	1
120/140	2062141	6225576	18-7198	V	1
120/140	2062141	6225576	18-7174	VC	1
160/165	2065190	UP	18-7198	V	1
160/165	2065190	UP	18-7174	VC	1
250	4791300	4898729	18-7198	V	1

Stern Drive Model	Beg. S/N	End S/N	Oil Seal	Desc.	Qty.
250	4791300	4898729	18-7174	VC	1
260	4898730	6225576	18-7198	V	1
260	4898730	6225576	18-7174	VC	1
470	4208730	6225576	18-7198	V	1
470	4208730	6225576	18-7174	VC	1
485	4893835	UP	18-7174	VC	1
485	4893835	UP	18-7198	V	1
898/228	4782330	6225576	18-7174	VC	1
898/228	4782330	6225576	18-7198	V	1

V - Valve Seal VC - Valve Cover Seal



①18-5001D Display Package



**18-5001
TUNE-UP KIT**
Replaces: 172525

—CONTAINS—

Part #	O.E. #	Description
18-5157	580290	Contact Set
18-5200	580256	Condenser

Display Package



**18-5250
TUNE-UP KIT**
Replaces: 172527

—CONTAINS—

Part #	O.E. #	Description
18-5311	380538	Contact Set
18-5345	380537	Condenser
18-5418	384735	Rotor

Delco 4 & 6 cyl.

Display Package



**18-5251
TUNE-UP KIT**
Replaces: 173619

—CONTAINS—

Part #	O.E. #	Description
18-5314	382135	Contact Set
18-5338	382136	Condenser
18-5404-1	982211	Rotor

18-5376 cap



**18-5256
TUNE-UP KIT**
Replaces: 172531

—CONTAINS—

Part #	O.E. #	Description
18-5314	382135	Contact Set
18-5338	382136	Condenser
18-5411	982342	Rotor

Mallory 8 cyl. Flat Cap

①18-5258D Display Package



**18-5258
TUNE-UP KIT**
Replaces: 173690, 987925

—CONTAINS—

Part #	O.E. #	Description
18-5303	980893	Contact Set
18-5347	980894	Condenser
18-5407	980892	Rotor

Prestolite 8 cyl.

Display Package



**18-5260
TUNE-UP KIT**
Replaces: 173829, 987926

—CONTAINS—

Part #	O.E. #	Description
18-5303	980893	Contact Set
18-5347	980894	Condenser
18-5403	982880	Rotor



**18-5266
TUNE-UP KIT**
Fits: Flame Thrower Distributors 18-5481, 18-5482, 18-5483, 18-5477, 18-5478 and 18-5479

Display Package



**18-5268
TUNE-UP KIT**

—CONTAINS—

Part #	O.E. #	Description
18-5311	380538	Contact Set
18-5345	380537	Condenser
18-5418	384735	Rotor
18-5385	380541	Distributor Cap

Delco In-Line 4 - Single Point

Display Package



**18-5269
TUNE-UP KIT**

—CONTAINS—

Part #	O.E. #	Description
18-5311	380538	Contact Set
18-5345	380537	Condenser
18-5418	384735	Rotor
18-5386	980152	Distributor Cap

Delco In-Line 6 - Single Point

Display Package



**18-5252
TUNE-UP KIT**

—CONTAINS—

Part #	O.E. #	Description
18-5310	-	Contact Set
18-5344	-	Condenser
-	-	Rotor

Delco 8 cyl.

Display Package



**18-5270
TUNE-UP KIT**

—CONTAINS—

Part #	O.E. #	Description
18-5310	380543	Contact Set
18-5344	382125	Condenser
-	381711	Rotor
18-5384	383587	Distributor Cap

Delco V-8 - Single Point

Display Package



**18-5271
TUNE-UP KIT**

—CONTAINS—

Part #	O.E. #	Description
18-5314	382135	Contact Set
18-5338	382136	Condenser
18-5404-1	982211	Rotor
18-5376	982209	Distributor Cap

Mallory V-8 - Single Point - Top Terminal

Display Package



**18-5272
TUNE-UP KIT**

—CONTAINS—

Part #	O.E. #	Description
18-5314	382135	Contact Set
18-5338	382136	Condenser
18-5411	982342	Rotor
18-5375	382133	Distributor Cap

Mallory Flat V-8 - Single Point - Side Terminal - Flat Cap

Display Package



**18-5275
TUNE-UP KIT**

—CONTAINS—

Part #	O.E. #	Description
18-5303	980893, 987136,	Contact Set
-	987894	-
18-5347	980894, 987895	Condenser
18-5403	982880	Rotor
18-5352	984401	Distributor Cap

Prestolite V-8 - Single Point - Screw Cap

APPLICATION BEGINS ON PAGE 870

① Items ending in "D" are Display Packaged - Regular number is Non-Display



**18-5276
TUNE-UP KIT**
—CONTAINS—

Part #	O.E. #	Description
18-5303	980893, 987136, 987894	Contact Set
18-5347	980894, 987895	Condenser
18-5403	982880	Rotor
18-5353	984398	Distributor Cap

Prestolite V-6 - Single Point - Screw Cap



**18-5277
TUNE-UP KIT**
—CONTAINS—

Par t#	O.E. #	Description
18-5303	980893, 987136, 987894	Contact Set
18-5347	980894, 987895	Condenser
18-5407	980892	Rotor
18-5369	982336	Distributor Cap

Prestolite V-8 - Single Point - Clip Cap



**18-5278
TUNE-UP KIT**
For: Delco EST V-6



**18-5279
TUNE-UP KIT**
For: Prestolite Electronic V-8
—CONTAINS—

Part #	Description	O.E.#	Qty.
18-5352	Distributor Cap	392-9766	1
18-5403	Rotor	392-9089	1



**18-5280
TUNE-UP KIT**
For: Delco EST In-Line 4
—CONTAINS—

Part #	Description	O.E.#	Qty.
18-5361	Distributor Cap	986643	1
18-5406	Rotor, Delco	986651	1



**18-5281
TUNE-UP KIT**
For: Delco EST • V-8



**18-5283
TUNE-UP KIT**
For: Mallory Single Point In-Line 4
—CONTAINS—

Part #	Description
18-5397	Distributor Cap
18-5404-1	Rotor
18-5314	Contact Set
18-5338	Condenser



**18-5157
CONTACT SET**
Replaces: 580290



**18-5303
CONTACT SET**
Replaces: 980893, 987136, 987894



**18-5310
CONTACT SET**
Replaces: 380543



**18-5311
CONTACT SET**
Replaces: 380538



**18-5314
CONTACT SET**
Replaces: 382135



**18-5200
CONDENSER**
Replaces: 580256



**18-5338
CONDENSER**
Replaces: 382136



**18-5344
CONDENSER**
Replaces: 382125



**18-5345
CONDENSER**
Replaces: 380537



**18-5347
CONDENSER**
Replaces: 980894, 987895



**18-5403
ROTOR**
Replaces: 982880



**18-5404-1
ROTOR**
Replaces: 982211



**18-5405
ROTOR**
Replaces: 3854549
V-8
Fits new GM style "Module in Cap"























**18-5406
ROTOR**
Replaces: 986651
Use with 18-5361
Distributor Cap



**18-5407
ROTOR**
Replaces: 980892



**18-5408
ROTOR**
Replaces: 3854311
V-6
Fits new GM style "Module in Cap"

 <p>18-5411 ROTOR Replaces: 982342</p>	 <p>18-5413 ROTOR Replaces: 987986</p>	 <p>18-5418 ROTOR Replaces: 384735</p>	 <p>18-5419 ROTOR Replaces: 380542</p>	 <p>18-5301 TUNE-UP KIT Fits: Male cap V-8 flamethrower distributors</p>
 <p>18-5302 TUNE-UP KIT Fits: Male cap v-8 flamethrower distributors</p>	 <p>18-5473 DISTRIBUTOR CAP Black Distributor Cap with Male Terminals for Flamethrower Distributors</p>	 <p>18-5474 DISTRIBUTOR CAP Red Distributor Cap with Male Terminals for Flamethrower Distributors</p>	 <p>18-5248 DISTRIBUTOR CAP Replaces: 3854217 Fits: OMC 5.0L(1994-96), 5.8L(1994-96)</p>	 <p>18-5352 DISTRIBUTOR CAP Replaces: 984401 Prestolite</p>
 <p>18-5353 DISTRIBUTOR CAP Replaces: 984398 Prestolite</p>	 <p>18-5354 DISTRIBUTOR CAP Replaces: 3854548 V-8 Fits new GM style "module in cap"</p>	 <p>18-5361 DISTRIBUTOR CAP Replaces: 986643</p>	 <p>18-5362 DISTRIBUTOR CAP Replaces: 3854331 V-6 Fits new GM style "Module in Cap"</p>	 <p>18-5369 DISTRIBUTOR CAP Replaces: 982336 w/Gasket 18-5399</p>
 <p>18-5375 DISTRIBUTOR CAP Replaces: 382133</p>	 <p>18-5376 DISTRIBUTOR CAP Replaces: 982209 Mallory</p>	 <p>18-5384 DISTRIBUTOR CAP Replaces: 383587</p>	 <p>18-5385 DISTRIBUTOR CAP Replaces: 380541</p>	 <p>18-5386 DISTRIBUTOR CAP Replaces: 980152</p>
 <p>18-5397 DISTRIBUTOR CAP Replaces: 985218 Mallory 9-29418 Fits: Ford 2.3L w/Mallory Distributor (87-90)</p>	 <p>18-5107-1 IGNITION MODULE Replaces: 3854003 4/6/8 cyl</p>	 <p>18-5108 SENSOR PICK-UP COIL Replaces: 3854001, 986642 4, V-6 and V-8 cyl</p>	 <p>18-5493 IGNITION PICKUP COIL ASSEMBLY Replacement pick-up coil for Accel Electronic Distributors</p>	 <p>18-5464 IGNITION MODULE Fits: Sierra 18-5481, 18-5482 and 18-5483 Billet HI-PERFORMANCE ELECTRONIC DISTRIBUTORS (except HE/EST)</p>



**18-26810
GM HEI 4 TERMINAL
PIGTAIL**
Fits: GM HEI Distributors w/4 terminals



**18-26811
GM HEI 2 TERMINAL
PIGTAIL**
Fits: GM HEI Distributors w/2 terminals



**18-26812
HEI COIL GRAY
CONNECTOR**



**18-26813
HEI COIL BLACK
CONNECTOR**



**18-29322
CAP & ROTOR KIT**
Fits: Ford HEI Distributors

FEATURES



- ★ Oil filled for better cooling and long life
- ★ Low resistance and improved turn ratios produces the higher voltage needed to run larger spark plug gaps for added power and better fuel economy
- ★ More windings maximize energy and reliability over the full RPM range
- ★ Fits existing brackets for easy installation



**18-5466
HI-PERFORMANCE
IGNITION COIL**
1.5 ohm (oil filled), black - 8 cylinder: Flame-Thrower 40,000 volt coil.
★ Designed for use with the original Ignitor Electronic Conversion Kits
★ Can be used with other inductive ignition systems



**18-5469
HI-PERFORMANCE
IGNITION COIL**
3.0 ohm (oil filled), black - 4 & 6 cylinder: Flame-Thrower 40,000 volt coil.
★ Designed for use with the original Ignitor Electronic Conversion Kits
★ Can be used with other inductive ignition systems



**18-5472
HI-PERFORMANCE
IGNITION COIL**
0.6 ohm (oil filled), black - 4, 6, & 8 cylinder: Flame-Thrower 45,000 volt coil.
★ Super low 0.6 ohm resistance coil designed for use with the Ignitor II Hi Performance Electronic Conversion Kits
★ Compatible with capacitive discharge systems

Part #	Description	Recommended Coil	Resistance Ohms	Part #	Description	Recommended Coil	Resistance Ohms
18-5293-1	Electronic Conversion Kit	18-5469	3.0	18-5288	Hi Performance Electronic Conversion Kit	18-5472	0.6
18-5294	Electronic Conversion Kit	18-5469	3.0	18-5289	Hi Performance Electronic Conversion Kit	18-5472	0.6
18-5295	Electronic Conversion Kit	18-5469	3.0	18-5290	Hi Performance Electronic Conversion Kit	18-5472	0.6
18-5296-2	Electronic Conversion Kit	18-5466	1.5	18-5481	Flame-Thrower Distributor	18-5472	0.6
18-5298	Electronic Conversion Kit	18-5466	1.5	18-5482	Flame-Thrower Distributor	18-5472	0.6
18-5299	Electronic Conversion Kit	18-5466	1.5	18-5483	Flame-Thrower Distributor	18-5472	0.6
18-5286	Hi Performance Electronic Conversion Kit	18-5472	0.6				



**18-5433
IGNITION COIL**
Replaces: 915735
Uses External Resistor
For: 3.0L (1991 & up), 5.7 EFI (1996 & up) and 7.4L EFI (1995 & up)



**18-5437
IGNITION COIL**
Replaces: 383444, 378231
Metal Encased - 12 Volt
Uses External Resistor (For All Applications)
For: 1990 & prior stern drives with breaker point ignition



**18-5443
IGNITION COIL**
Replaces: 3854002
4 cyl./V-8
For: 3.0L (1991 & up), 5.7 EFI (1996 & up) & 7.4 EFI (1995 & up)



**18-5888
SHIFT ASSIST MODULE & HARNESS**
Replaces: 987738
For: V-8 Sterndrives
Fits: 5.0, 5.7 GM (1986-90) 7.5 460 Ford (1987-91)



**18-5889
SHIFT ASSIST MODULE & HARNESS**
Replaces: 987739
For: V-8 Sterndrives
Fits: 5.0, 5.8 Ford (1986-90)



**18-5890
SHIFT ASSIST MODULE & HARNESS**
Replaces: 987740, 985902
Fits: 2.3, 3.0, 4.3 (1986-90) & 2.5 (1986)



FEATURES

- ★ Senses current levels in the coil and adjusts the dwell to maintain peak energy throughout the entire RPM range.
- ★ Develops, on average, 4 times more available energy between 3000 and 5000 RPM's and twice as much plug voltage as point-type systems.
- ★ Ignition energy is sustained and coil life is increased when peak current level is reached just prior to spark.
- ★ More stable timing.
- ★ Use with 18-5472 "Flame Thrower II" Coil for optimum performance



18-5285
HI-PERFORMANCE
ELECTRONIC CONVERSION KIT
 Fits: 4 Cylinder Delco Distributors



18-5286
HI-PERFORMANCE
ELECTRONIC CONVERSION KIT
 Fits: 6 Cylinder Delco Distributors



18-5287-1
HI-PERFORMANCE
ELECTRONIC CONVERSION KIT
 Fits: Fits: 6 Cylinder Prestolite Distributors



18-5288
HI-PERFORMANCE
ELECTRONIC CONVERSION KIT
 Fits: Most Prestolite V-8 Distributors with snap down cap



18-5289
HI-PERFORMANCE
ELECTRONIC CONVERSION KIT
 Fits: Most Prestolite V-8 Distributors with screw down cap



18-5290
HI-PERFORMANCE
ELECTRONIC CONVERSION KIT
 Fits: Most Mallory YL or YD 8 cylinder Distributors with clockwise and counter clockwise rotation



FEATURES

- ★ Replaces points & condensers for true solid state ignition.
- ★ Uses standard coil, cap and rotor.
- ★ Easy to install, one-piece, 2-wire hook-up.
- ★ Accurate to within 1/4° timing accuracy 0 to 6000 RPM range.

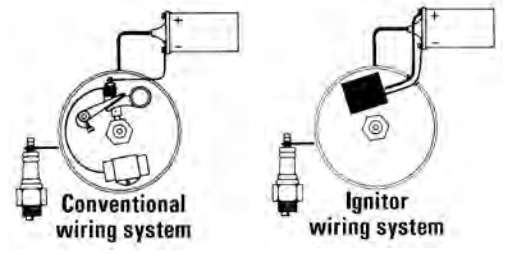

Not compatible with shift assist modules



18-5293-1
ELECTRONIC CONVERSION KIT
 For: All Chevrolet V-6 Prestolite with screw down caps



18-5294
ELECTRONIC CONVERSION KIT
 Fits: 6 Cyl. Delco distributors



18-5295
ELECTRONIC CONVERSION KIT
 Fits: Most 4 Cyl. Prestolite distributors (except IBM 7026)
 For: Onan, Universal, Waukesha, Wisconsin

Not compatible with shift assist modules

APPLICATION BEGINS ON PAGE 870

①18-5296-2D 



**18-5296-2
ELECTRONIC
CONVERSION KIT**
Fits: Most Mallory YL & YD 8 cyl.
Distributors with clockwise and counter
clockwise rotation

①18-5297D 



**18-5297
ELECTRONIC
CONVERSION KIT**
For 4 Cyl. Delco Distributors

①18-5298 



**18-5298
ELECTRONIC
CONVERSION KIT**
(with snap down cap)
For: Most Prestolite V-8 Distributors

①18-5299D 





**18-5299
ELECTRONIC
CONVERSION KIT**
(with screw down cap)
For: Most Prestolite V-8 Distributors
Use with 18-5403 style rotor

Not compatible with shift assist modules

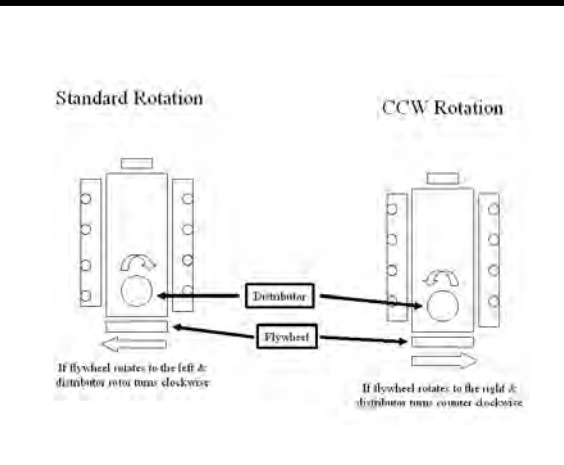

FEATURES

- ★ *Distributors feature the Ignitor II ignition module with adaptive dwell control adjusts the spark timing over the entire RPM range to maximize performance*
- ★ *Upper roller bearing and oil impregnated bronze sintered bottom bushing are installed and aligned bored for accuracy for maximum durability*
- ★ *Machined heat treated gear with tight tolerances insures durability and consistent timing to maximize horsepower and performance. Complete with high dielectric strength cap and rotor for years of performance*

**18-5477
ELECTRONIC DISTRIBUTOR**
Fits: Ford 302 V-8 engines
Replacement Cap/Rotor Kit 18-5266



**18-5480
COMPLETE
IGNITION CONVERSION KIT**
Fits: GM SB & BB with Standard Deck Height
—CONTAINS—

Part #	Description
18-5472	Coil
18-8803-2	Wire Set
18-5483	Distributor



**18-5481
HI-PERFORMANCE
ELECTRONIC
DISTRIBUTOR**
Fits: Ford V-8 351 Windsor
Replacement cap/rotor kit: 18-5266



**18-5482
HI-PERFORMANCE
ELECTRONIC
DISTRIBUTOR**
Fits: Ford V-8 351 Cleveland, 351M, 400,
429 and 460 engines
Replacement cap/rotor kit: 18-5266



**18-5483
HI-PERFORMANCE
ELECTRONIC
DISTRIBUTOR**
Fits: Chevrolet Marine Small and Big Block
engines (Standard Deck Height)
Replacement cap/rotor kit: 18-5266

APPLICATION BEGINS ON PAGE 870

① Items ending in "D" are Display Packaged - Regular number is Non-Display



18-5478
ELECTRONIC DISTRIBUTOR
 Chrysler LA series V-8 engines
 Replacement Cap/Rotor Kit 18-5266



18-5479
ELECTRONIC DISTRIBUTOR
 GM V-8 engines-reverse rotation
 Replacement Cap/Rotor Kit 18-5266



18-5476
DISTRIBUTOR
 Fits: GM V-6 engines with Delco EST ignition HEI
 Tune-Up Kit 18-5278



18-5486-2
ELECTRONIC DISTRIBUTOR
 Replaces: Mallory YLM673AV
 Conventional Rotation
 For: Chevrolet L4, 153 & 181 CID
 —CONTAINS—

Part #	Description
18-5397	Distributor Cap
18-5488	Module
18-5404-1	Rotor



18-5487-2
ELECTRONIC DISTRIBUTOR
 Replaces: 9-26309, Mallory YLM676AV
 Conventional Rotation
 For: GM L6, 194, 230, 250, 292 CID
 —CONTAINS—

Part #	Description
18-5488	Module
18-5404-1	Rotor



18-5489-2
ELECTRONIC DISTRIBUTOR
 Replaces: Mallory YLM554CV
 Conventional Rotation
 For: Ford V8 351W CID
 —CONTAINS—

Part #	Description
18-5376	Distributor Cap
18-5488	Module
18-5404-1	Rotor



18-5494-2
ELECTRONIC DISTRIBUTOR
 Replaces: Mallory YLM624AV
 Conventional Rotation
 For: Chevrolet all V8 includes 482, 502, 540 CID
 (Except 348,409 & Tall Deck Big Block)
 —CONTAINS—

Part #	Description
18-5376	Distributor Cap
18-5488	Module
18-5404-1	Rotor



18-5495-2
ELECTRONIC DISTRIBUTOR
 Replaces: Mallory YLM512CV
 Conventional Rotation
 For: Ford V8 302 CID
 —CONTAINS—

Part #	Description
18-5376	Distributor Cap
18-5488	Module
18-5404-1	Rotor



18-5496-2
ELECTRONIC DISTRIBUTOR
 Replaces: Mallory YLM567CV
 Conventional Rotation
 For: Ford V8 351C — 460 CID
 —CONTAINS—

Part #	Description
18-5376	Distributor Cap
18-5488	Module
18-5404-1	Rotor

18-5484-1
ELECTRONIC DISTRIBUTOR
 Replaces: 3857400, 3850399
 Late HEI
Conventional Rotation
 V8 262-454 & 502 except 348/409 and tall block engines
 • Designed as a plug-in replacement for GM-style fuel injection system distributors



—CONTAINS—
 Description Part #
 Distributor Cap 18-5354
 Rotor 18-5405
 Tune-Up Kit 18-5281

18-5498-2
ELECTRONIC DISTRIBUTOR
 Replaces: 9-26307; Mallory YLM624BV
 For GM V8, 482, 502, 540 CID (Except 348, 409 & Tall Deck Big Block) (Reverse Rotation)



18-5339-1
DISTRIBUTOR
 Replaces: 9-26103; Mallory YL566AV
 For GM V8 327



18-5475
DISTRIBUTOR
 Fits: 4 Cyl. GM Engines with Delco EST Ignition HEI
 Tune-Up Kit 18-5280



18-5309-1
DISTRIBUTOR
 Contact Controlled
 Replaces: 980902; Mallory YL512CV
 For most Ford 302 CID V-8 Eng.
 Tune-Up Kit 18-5251



18-5316-1
DISTRIBUTOR
 Replaces: Mallory YL624BV
 Fits Most GM V8 (Reverse Rotation)



18-5312-1
DISTRIBUTOR
 Contact Controlled
 Replaces: 981080; Mallory YL554CV
 For most Ford 351 CID V-8 Eng.
 Tune-Up Kit 18-5251



18-5313-1
DISTRIBUTOR
 Contact Controlled
 Replaces: 985560; Mallory YL624MW
 For most GM V-8 Engs. (small & large blocks)
 Tune-Up Kit 18-5251



18-5315-1
DISTRIBUTOR
 Contact Controlled
 Replaces: Mallory YL673AV
 For most GM 4 Cyl. Engines (120 & 140 HP)
 Tune-Up Kit 18-5251



18-26110-1
DISTRIBUTOR
 Replaces: 9-26110; Mallory YL579AV
 For Chrysler V8, 273, 318 (1967 & Up), 340 and 360 "LA" Engines



18-26104-1
DISTRIBUTOR
 Replaces: 9-26104; Mallory YL567EV
 For Ford V8 351C



18-26112-1
DISTRIBUTOR
 Replaces: 9-26112; Mallory YL676AV
 Fits GM L6, 194, 230, 250, 292 CID (Conventional Rotation)



OMC IGNITION APPLICATION CHART

Model	Year Start	Year Stop	Cylinder	Distributor	Contact Set	Condenser	Dist. Cap	Rotor	Tune-Up Kit w/o Cap	Tune-Up Kit w/ Cap	Plug Wire Set
2.3L	1987	1990	4	Mallory	18-5314	18-5338	18-5397	18-5404-1	-	18-5283	18-8807-1
2.3L	1990	1990	4	Prestolite	18-5303	18-5347	-	18-5403	18-5260	-	18-8807-1
2.5L	1981	1986	4	Delco	18-5311	18-5345	18-5385	18-5418	18-5250	18-5268	18-8800-1
3.0L	1982	1990	4	Delco	18-5311	18-5345	18-5385	18-5418	18-5250	18-5268	18-8800-1
3.0L	1990	1998	4	Delco EST	N/A	N/A	18-5361	18-5406	-	18-5280	18-8833-1
3.8L	1981	1985	6	Prestolite	18-5303	18-5347	18-5353	18-5403	18-5262	18-5276	18-8801-1
4.3L	1985	1990	6	Prestolite ②	18-5303	18-5347	18-5353	18-5403	18-5262	18-5276	18-8801-1
4.3L	1991	1993	6	Prestolite	N/A	N/A	18-5353	18-5403	-	-	18-8801-1
4.3L	1994	1998	6	Delco EST	N/A	N/A	18-53626	18-5408	-	18-5278	18-8835-1
5.0L (GM)	1979	1982	8	Prestolite ①	18-5303	18-5347	18-5369	18-5407	18-5258	18-5277	18-8802-1
5.0L (GM)	1981	1988	8	Mallory	18-5314	18-5338	18-5376	18-5404-1	18-5251	18-5271	18-8802-1
5.0L (GM)	1983	1988	8	Prestolite ②	18-5303	18-5347	18-5352	18-5403	18-5262	18-5275	18-8802-1
5.0L (Ford)	1989	1990	8	Prestolite ②	18-5303	18-5347	18-5352	18-5403	18-5262	18-5275	18-8806-1
5.0L (Ford)	1991	1996	8	Prestolite	N/A	N/A	18-5352	18-5403	-	18-5279	18-8806-1
5.0L (Ford)	1993	1996	8	Ford HEI	N/A	N/A	18-5248	18-5413	-	18-29322	18-8820-1
5.0L (GM)	1998	1998	8	Prestolite	N/A	N/A	18-5352	18-5403	-	18-5279	18-8801-1
5.0L (GM)	1998	1998	8	Delco EST	N/A	N/A	18-5354	18-5405	-	18-5281	18-8822-1
5.7L	1982	1990	8	Mallory	18-5314	18-5338	18-5376	18-5404-1	18-5251	18-5271	18-8802-1
5.7L	1982	1990	8	Prestolite ②	18-5303	18-5347	18-5352	18-5403	18-5262	18-5275	18-8802-1
5.7L	1991	1998	8	Prestolite ②	N/A	N/A	18-5352	18-5403	-	18-5279	18-8802-1
5.7L	1996	1998	8	Delco EST	N/A	N/A	18-5354	18-5405	-	18-5281	18-8822-1
5.8L	1989	1990	8	Prestolite ②	18-5303	18-5347	18-5352	18-5403	18-5262	18-5275	18-8842-1
5.8L	1991	1996	8	Prestolite ②	N/A	N/A	18-5352	18-5403	-	18-5279	18-8842-1
5.8L	1993	1996	8	Ford HEI	N/A	N/A	18-5248	18-5413	-	18-29322	18-8820-1
7.4L	1988	1988	8	Mallory	18-5314	18-5338	18-5376	18-5404-1	18-5251	18-5271	18-8802-1
7.4L	1988	1988	8	Prestolite ②	18-5303	18-5347	18-5352	18-5403	18-5262	18-5275	18-8802-1
7.4L	1990	1991	8	Distributorless	-	-	-	-	-	-	18-8843-1
7.4L	1995	1998	8	Delco EST	N/A	N/A	18-5354	18-5405	-	18-5281	18-8832-1
7.5L	1987	1987	8	Prestolite ①	18-5303	18-5347	18-5369	18-5407	18-5258	18-5277	18-8803-2
7.5L	1987	1989	8	Prestolite ①	18-5303	18-5347	18-5352	18-5407	18-5258	18-5277	18-8803-2
8.2L	1984	1985	8	Mallory	18-5314	18-5338	18-5376	18-5404-1	18-5251	18-5271	18-8802-1
8.2L	1984	1985	8	Prestolite ②	18-5303	18-5347	18-5352	18-5403	18-5262	18-5275	18-8802-1
8.2L	1998	1998	8	Delco EST	N/A	N/A	18-5354	18-5405	-	18-5281	18-8832-1
80	1962	1968	4	ALL	18-5157	18-5200	-	-	18-5001	-	18-8800-1
90	1962	1968	4	ALL	18-5157	18-5200	-	-	18-5001	-	18-8800-1
100	1972	1973	4	Delco	18-5311	18-5345	18-5385	18-5418	18-5250	18-5268	18-8800-1
110	1964	1964	4	Delco	18-5311	18-5345	18-5385	18-5418	18-5250	18-5268	18-8800-1
120	1965	1981	4	Delco	18-5311	18-5345	18-5385	18-5418	18-5250	18-5268	18-8800-1
140	1973	1981	4	Delco	18-5311	18-5345	18-5385	18-5418	18-5250	18-5268	18-8800-1
150	1964	1966	6	Delco	18-5310	18-5345	-	18-5419	-	-	-
155	1967	1972	6	Delco	18-5310	18-5344	-	18-5419	-	-	-
165	1972	1976	6	Delco	18-5311	18-5345	18-5386	18-5418	18-5250	18-5269	-
170	1974	1974	8	Prestolite ①	18-5303	18-5347	18-5369	18-5407	18-5258	18-5277	18-8802-1
175	1975	1977	8	Prestolite ①	18-5303	18-5347	18-5369	18-5407	18-5258	18-5277	18-8802-1
185	1967	1968	8	Mallory	18-5314	18-5338	18-5375	18-5411	18-5256	18-5272	18-8802-1
185	1978	1980	8	Mallory	18-5314	18-5338	18-5376	18-5404-1	18-5251	18-5271	18-8802-1
185	1978	1980	8	Prestolite ①	18-5303	18-5347	18-5369	18-5407	18-5258	18-5277	18-8802-1
190	1974	1977	8	Prestolite ①	18-5303	18-5347	18-5369	18-5407	18-5258	18-5277	18-8802-1
200	1966	1966	8	Delco	18-5310	18-5345	18-5384	18-5300	-	18-5270	-
200	1967	1968	8	Delco	18-5310	18-5344	18-5384	18-5300	18-5252	18-5270	-

① Clip down distributor cap ② Screw down distributor cap

APPLICATION CONTINUED ON NEXT PAGE

OMC IGNITION APPLICATION CHART

Model	Year Start	Year Stop	Cylinder	Distributor	Contact Set	Condenser	Dist. Cap	Rotor	Tune-Up Kit w/o Cap	Tune-Up Kit w/ Cap	Plug Wire Set
200	1979	1988	8	Mallory	18-5314	18-5338	18-5376	18-5404-1	18-5251	18-5271	18-8802-1
200	1979	1981	8	Prestolite ①	18-5303	18-5347	18-5369	18-5407	18-5258	18-5277	18-8802-1
210	1968	1970	8	Mallory	18-5314	18-5338	18-5375	18-5411	18-5256	18-5272	18-8802-1
215	1971	1971	8	Mallory	18-5314	18-5338	18-5375	18-5411	18-5256	18-5272	18-8802-1
225	1972	1976	8	Mallory	18-5314	18-5338	18-5375	18-5411	18-5256	18-5272	18-8802-1
225	1978	1978	8	Mallory	18-5314	18-5338	18-5376	18-5404-1	-	18-5271	18-8802-1
230	1979	1981	8	Mallory	18-5314	18-5338	18-5376	18-5404-1	18-5251	18-5271	18-8802-1
230	1979	1981	8	Prestolite ①	18-5303	18-5347	18-5369	18-5407	18-5258	18-5277	18-8802-1
230	1975	1976	8	Mallory	18-5314	18-5338	18-5375	18-5411	18-5256	18-5272	18-8802-1
235	1971	1971	8	Mallory	18-5314	18-5338	18-5375	18-5411	18-5256	18-5272	18-8802-1
235	1975	1977	8	Prestolite ①	18-5303	18-5347	18-5369	18-5407	18-5258	18-5277	18-8802-1
240	1978	1978	8	Prestolite ①	18-5303	18-5347	18-5369	18-5407	18-5258	18-5277	18-8802-1
245	1975	1975	8	Mallory	18-5314	18-5338	18-5375	18-5411	18-5256	18-5272	18-8802-1
250	1970	1974	8	Mallory	18-5314	18-5338	18-5375	18-5411	18-5256	18-5272	18-8802-1
250	1979	1979	8	Prestolite ①	18-5303	18-5347	18-5369	18-5407	18-5258	18-5277	18-8802-1
260	1975	1976	8	Mallory	18-5314	18-5338	18-5375	18-5411	18-5256	18-5272	18-8802-1
260	1979	1981	8	Mallory	18-5314	18-5338	18-5376	18-5404-1	18-5251	18-5271	18-8802-1
260	1979	1981	8	Prestolite ①	18-5303	18-5347	18-5369	18-5407	18-5258	18-5277	18-8802-1
290 JET	1974	1975	8	Mallory	18-5314	18-5338	18-5375	18-5411	18-5256	18-5272	18-8802-1
305	1977	1979	8	Mallory	18-5314	18-5338	18-5375	18-5411	18-5256	18-5272	18-8802-1
305	1980	1981	8	Mallory	18-5314	18-5338	18-5376	18-5404-1	18-5251	18-5271	18-8802-1
305	1981	1981	8	Prestolite ①	18-5303	18-5347	18-5369	18-5407	18-5258	18-5277	18-8802-1
350	1977	1979	8	Mallory	18-5314	18-5338	18-5375	18-5411	18-5256	18-5272	18-8802-1
350	1980	1981	8	Mallory	18-5314	18-5338	18-5376	18-5404-1	18-5251	18-5271	18-8802-1
350	1981	1981	8	Prestolite ①	18-5303	18-5347	18-5369	18-5407	18-5258	18-5277	18-8802-1
454	1977	1979	8	Mallory	18-5314	18-5338	18-5375	18-5411	18-5256	18-5272	18-8803-2
454	1980	1981	8	Mallory	18-5314	18-5338	18-5376	18-5404-1	18-5251	18-5271	18-8803-2
454	1981	1981	8	Prestolite ①	18-5303	18-5347	18-5369	18-5407	18-5258	18-5277	18-8803-2

① Clip down distributor cap ② Screw down distributor cap

 <p>MP28890 IGNITION LANAYARD Replaces: 176288 Fits: 1996 - Up</p>	 <p>MP28880 LANAYARD Replaces: 432230 Fits: 1995-Older</p>	 <p>18-5225 SPARK PLUG WIRE KIT Kit Includes 25 ft. Roll of 7 MM Hypalon Ignition Wire With a Metallic Core and a Large Assortment of Three Different End Fittings.</p>	 <p>18-5222 IGNITION WIRE Silicone Core 100' Spool 8mm</p>
 <p>18-5226 IGNITION WIRE Metallic Core 100' Spool 7mm Hypalon</p>	 <p>PKG. OF 10 18-5224 18-5224-9② SPARK PLUG WIRE TERMINAL Replaces: Mercury 20121 OMC 510364</p>	 <p>PKG. OF 10 18-5750 18-5750-9② UNIVERSAL SPARK PLUG BOOT Supplied complete w/Terminal Connector Replaces: OMC 581027, 580339</p>	 <p>18-5752 UNIVERSAL SPARK PLUG BOOT 8mm</p>

③ Priced per Package

PREMIUM MARINE IGNITION WIRES

Sierra's MAGFORCE Ignition Wires are "Electronics Friendly" protecting all of your electronic devices and electronic engine controls from RFI and EMI while delivering the maximum amount of voltage. Exact fit design ensures easy installation and years of trouble - free service.

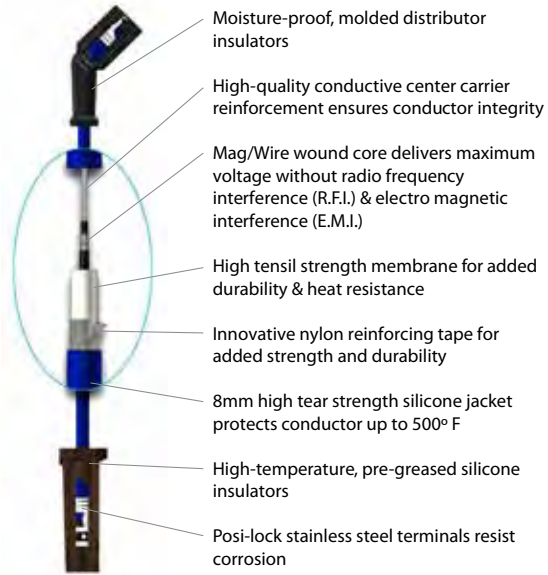

APPLICATION CONTINUED ON NEXT PAGE



OMC MARINE IGNITION WIRES APPLICATION

Model	Cyl.	Distributor	Year Start	Year End	Plug Wire Set
2.3L	4	Mallory	1987	1990	18-8807-1
2.3L	4	Prestolite	1990	1990	18-8807-1
2.5L	4	Delco	1981	1986	18-8800-1
3.0L	4	Delco	1982	1990	18-8800-1
3.0L	4	Delco EST	1990	1998	18-8833-1
3.8L	6	Prestolite	1981	1985	18-8801-1
4.3L	6	Prestolite ②	1985	1990	18-8801-1
4.3L	6	Prestolite	1991	1993	18-8801-1
4.3L	6	Delco EST	1994	1998	18-8835-1
5.0L (GM)	8	Prestolite ①	1979	1982	18-8802-1
5.0L (GM)	8	Mallory	1981	1988	18-8802-1
5.0L (GM)	8	Prestolite ②	1983	1988	18-8802-1
5.0L (Ford)	8	Prestolite ②	1989	1990	18-8806-1
5.0L (Ford)	8	Prestolite	1991	1996	18-8806-1
5.0L (Ford)	8	Ford HEI	1993	1996	18-8820-1
5.0L (GM)	8	Prestolite	1998	1998	18-8801-1
5.0L (GM)	8	Delco EST	1998	1998	18-8822-1
5.7L	8	Mallory	1982	1990	18-8802-1
5.7L	8	Prestolite ②	1982	1990	18-8802-1
5.7L	8	Prestolite ②	1991	1998	18-8802-1
5.7L	8	Delco EST	1996	1998	18-8822-1
5.8L	8	Prestolite ②	1989	1990	18-8842-1
5.8L	8	Prestolite ②	1991	1996	18-8842-1
5.8L	8	Ford HEI	1993	1996	18-8820-1
7.4L	8	Mallory	1988	1988	18-8802-1
7.4L	8	Prestolite ②	1988	1988	18-8802-1
7.4L	8	Distributorless	1990	1991	18-8843-1
7.4L	8	Delco EST	1995	1998	18-8832-1
7.5L	8	Prestolite ②	1987	1987	18-8803-2
7.5L	8	Prestolite ②	1987	1989	18-8803-2
8.2L	8	Mallory	1984	1985	18-8802-1
8.2L	8	Prestolite ②	1984	1985	18-8802-1
8.2L	8	Delco EST	1998	1998	18-8832-1

OMC MARINE IGNITION WIRES APPLICATION

Model	Cyl.	Distributor	Year Start	Year End	Plug Wire Set
80	4	ALL	1962	1968	18-8800-1
90	4	ALL	1962	1968	18-8800-1
100	4	Delco	1972	1973	18-8800-1
110	4	Delco	1964	1964	18-8800-1
120	4	Delco	1965	1981	18-8800-1
140	4	Delco	1973	1981	18-8800-1
170	8	Prestolite ①	1974	1974	18-8802-1
175	8	Prestolite ①	1975	1977	18-8802-1
185	8	Mallory	1967	1968	18-8802-1
185	8	Mallory	1978	1980	18-8802-1
185	8	Prestolite ①	1978	1980	18-8802-1
190	8	Prestolite ①	1974	1977	18-8802-1
200	8	Mallory	1979	1988	18-8802-1
200	8	Prestolite ①	1979	1981	18-8802-1
210	8	Mallory	1968	1970	18-8802-1
215	8	Mallory	1971	1971	18-8802-1
225	8	Mallory	1972	1976	18-8802-1
225	8	Mallory	1978	1978	18-8802-1
230	8	Mallory	1979	1981	18-8802-1
230	8	Prestolite ①	1979	1981	18-8802-1
230	8	Mallory	1975	1976	18-8802-1
235	8	Mallory	1971	1971	18-8802-1
235	8	Prestolite ①	1975	1977	18-8802-1
240	8	Prestolite ①	1978	1978	18-8802-1
245	8	Mallory	1975	1975	18-8802-1
250	8	Mallory	1970	1974	18-8802-1
250	8	Prestolite ①	1979	1979	18-8802-1
260	8	Mallory	1975	1976	18-8802-1
260	8	Mallory	1979	1981	18-8802-1
260	8	Prestolite ①	1979	1981	18-8802-1
290 JET	8	Mallory	1974	1975	18-8802-1
305	8	Mallory	1977	1979	18-8802-1

① Clip down cap ② Snap down cap

OMC MARINE IGNITION WIRES APPLICATION					
Model	Cyl.	Distributor	Year Start	Year End	Plug Wire Set
305	8	Mallory	1980	1981	18-8802-1
305	8	Prestolite ①	1981	1981	18-8802-1
350	8	Mallory	1977	1979	18-8802-1
350	8	Mallory	1980	1981	18-8802-1

OMC MARINE IGNITION WIRES APPLICATION					
Model	Cyl.	Distributor	Year Start	Year End	Plug Wire Set
350	8	Prestolite ①	1981	1981	18-8802-1
454	8	Mallory	1977	1979	18-8803-2
454	8	Mallory	1980	1981	18-8803-2
454	8	Prestolite ①	1981	1981	18-8803-2

① Clip down cap ② Snap down cap



**18-5923
STARTER, PMGR, FORD**
PMGR Replacement for 18-5903; 302CID, 351CID Ford Engines
Clockwise/Standard Rotation



**18-5927
STARTER, PMGR, FORD**
PMGR Replacement for 18-5917, 2.3L Ford Starter.



**18-6270
PERMANENT MAGNET I/O STARTER**
Replaces: 988013, 984536
• Permanent Magnet
• Heavy Duty
• 12 Volt
• 2 Bolt Mount
• 1 Threaded Hole
• CW Rotation
• SAE J1171
For: 460 Ford, OMC King Cobra



**18-5919
STARTER**
Permanent magnet I/O starter
For: Late model GM - 12 3/4" flywheel
Replaces: 988217
SAEJ1171
1.7 KW



**18-5920
STARTER**
Permanent Magnet
For: 5.0 & 5.8 litre Ford engines.
Clockwise/Standard Rotation
Replaces: 987811, 3854190
Replacement Solenoid: 18-6291

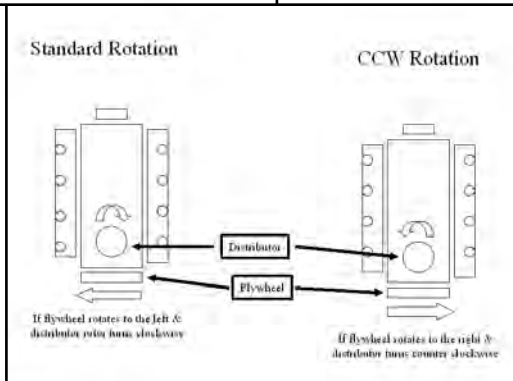

**18-6276
STARTER**
Replaces: 984536, 988013
• 12 Volt
• CW Rotation
• Threaded Top Hole in Housing
• 460 Ford, OMC King Cobra

**18-5911
STARTER
(Heavy-Duty) (No Core)**
For GM engines, bottom mount straight across bolt pattern.
Standard rotation clockwise. 100-245 HP — 1970-1978 (GM)
Replaces: 981078, 982121, 983444, 983790, 985966
Replacement Solenoid: 18-5837
SAEJ1171



**18-5907
STARTER
(Heavy-Duty) (No Core)**
Top mount front entry starter for standard rotation
GM and Ford engines.
Replaces: 981289, 982202
Replacement Solenoid: 18-5837
SAEJ1171





**18-5908
STARTER**
(Heavy-Duty) (No Core)
Top mount front entry starter for reverse rotation
GM and Ford engines. Counter-clockwise.
Replaces: 981288, 982195, 984982, 986007
Replacement Solenoid: 18-5837
SAEJ1171



**18-5910
STARTER**
(Heavy-Duty) (No Core)
Small block GM V-6 & V-8 Engine with 14 1/4" flywheel and bottom mount,
offset bolt pattern. For standard rotation engines. Clockwise. 1986-1992 - V-6,
V-8 (GM) and 1990-1993 OMC King Cobra
Replaces: 984456, 986505
Replacement Solenoid: 18-5837
SAEJ1171



**18-5917
STARTER**
Replaces: 984628
3 bolt mount - Late style 4" diameter case.
Standard rotation engines
For: Late model Ford V-8.
Replacement Solenoid: 18-5801



**18-5903
STARTER**
(No Core) (Clockwise)
Bottom mount, two bolt pattern for standard
rotation. Ford engines. Clockwise.
Non-threaded top mounting hole. For threaded
top, order 18-6276.
Replaces: 980803, 981821
Replacement Solenoid: 18-5801



**18-5913
STARTER**
(Clockwise)
Delco permanent magnet gear reduction 2 bolt
starter 12V - 11 Tooth - Offset bolt pattern. Fits:
Chevy Engines with 14" flywheels. 1.7 KW
Replaces: 3854751 SAEJ1171



OMC STERNDRIVE/OMC COBRA STARTERS

ENGINE	YEAR	STARTER #
3.0L	1982-92	18-5911
5.0L	1982-86	18-5911 ④
5.0L	1986-88	18-5910 ⑤
2.5L	1982-86	18-5911
3.8L	1981-86	18-5911
4.3L	1985-86	18-5911
4.3L	1986-92	18-5910
5.7L	1982-86	18-5911
5.7L	1986-92	18-5910
100	1972-73	18-5911
110	1964	18-5911
120	1965-81	18-5911
140	1973-81	18-5911
140 JET	1973	18-5911
150	1964-66	18-5911
155	1967-72	18-5911

ENGINE	YEAR	STARTER #
165	1972-76	18-5911
170	1974	18-5903
175	1975-77	18-5903
185	1967-68, 1978-80	18-5911
190	1974-77	18-5903
200	1966-68, 1979-81	18-5911
210	1968-72	18-5911 ①
215	1971	18-5911
225	1972-76, 1978	18-5911 ①
230	1975-76	18-5908 ①
230	1975-76	18-5907 ②
230	1979-81	18-5911
235	1971	18-5911
235	1975-77	18-5903
240	1978	18-5903
245	1972-75	18-5911

ENGINE	YEAR	STARTER #
245 JET	1972-74	18-5911
250	1979	18-5903
260	1975-76	18-5908 ①
260	1975-76	18-5907 ②
260	1979-81	18-5911
262 CID	1989	18-5910
290	1975	18-5908 ③
305 CID	1977-80,82	18-5908 ①
305 CID	1977-80,82	18-5907 ②
350 CID	1977-80,82	18-5908 ①
350 CID	1977-80,82	18-5907 ②
350 CID	1988-91	18-5910
370 CID	1988	18-5908
454 CID	1977-80,82	18-5908 ①
454 CID	1977-80,82	18-5907 ②
454 CID	1990-92	18-5910
502 CID	1992	18-5910

① Standard rotation engines.
② Opposite (Reverse) rotation engines.

③ Engines with model number suffix "R2" or "R3"
④ '86 Model engines with model number suffix "WB"

⑤ '86 Model engines with model number suffix "XS"



**18-5717
STARTER BRUSH SET**
Replaces: Delco 1984462



**18-8412
STARTER STUD EXTENDER**
Extends the solenoid stud on PMGR starters for applications that require more accessory wire connections.
Threads: Female M8x1.25, Male 3/8"x16 UNC



**18-5811
STARTER SOLENOID**
Replaces: 3850216
For: PG 260 series starters, GM V6 & V8 (1983-Up)

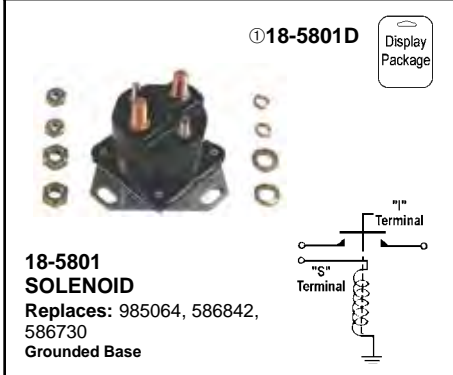

**18-5801
SOLENOID**
Replaces: 985064, 586842, 586730
Grounded Base



**18-5803
SOLENOID**
Replaces: 979774

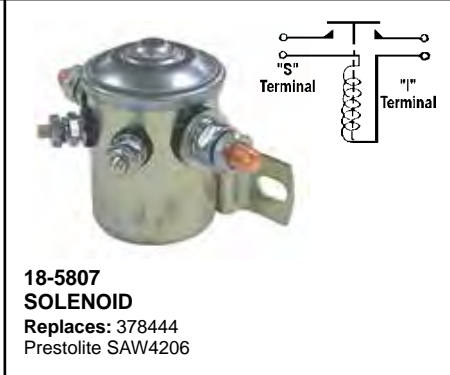

**18-5807
SOLENOID**
Replaces: 378444
Prestolite SAW4206



**18-6291
SOLENOID**
Replaces: 3854194 and Volvo Penta 3854194-2
Fits: Ford Gear Reduction Starters on Late Model 5.0L, 5.8L, OMC and Volvo Penta



**18-5814
SOLENOID**
Replaces: 172869, 581528
12 Volt, Isolated Base

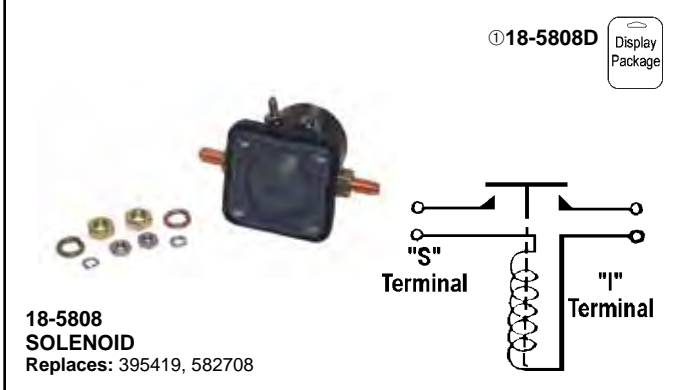

**18-5808
SOLENOID**
Replaces: 395419, 582708

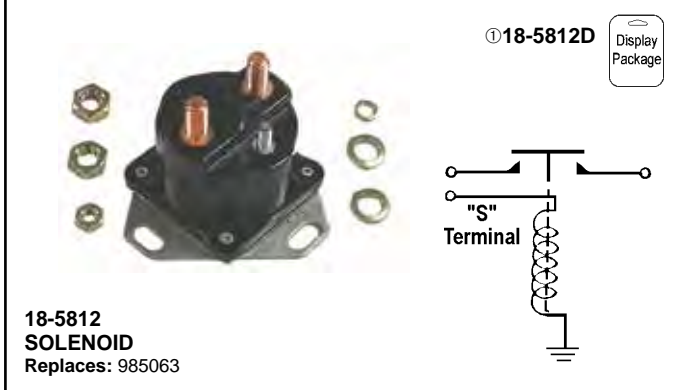

**18-5812
SOLENOID**
Replaces: 985063



**18-5837
SOLENOID**
Replaces: 985799, 986620
Delco 1114531



**18-5838
SOLENOID**
Replaces:
Delco 1114356, 1114458

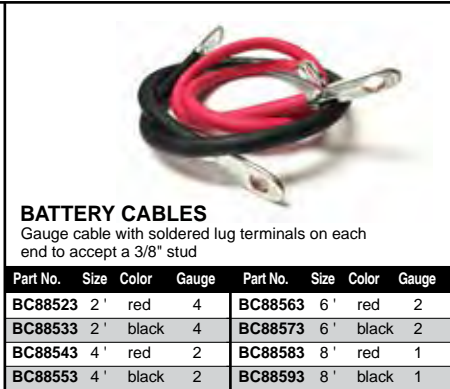

BATTERY CABLES
Gauge cable with soldered lug terminals on each end to accept a 3/8" stud

Part No.	Size	Color	Gauge	Part No.	Size	Color	Gauge
BC88523	2'	red	4	BC88563	6'	red	2
BC88533	2'	black	4	BC88573	6'	black	2
BC88543	4'	red	2	BC88583	8'	red	1
BC88553	4'	black	2	BC88593	8'	black	1

① Items ending in "D" are Display Packaged - Regular number is Non-Display

STRINGER SOLENOID APPLICATION

HP	Year	Starter Brush	Starter Mounted Solenoid	Starter Solenoid	Tilt Solenoid	Trim Solenoid
80	1969	—	N/A	18-5808	N/A	18-5808
88	1964	—	N/A	18-5807	N/A	18-5807
90	1965-71	—	N/A	18-5808	N/A	18-5808
100	1972-73	18-5717	18-5838	18-5803	N/A	18-5803
110	1964	18-5717	18-5838	18-5807	N/A	18-5807
120	1965-71	18-5717	18-5838	18-5808	N/A	18-5808
120	1972-77	18-5717	18-5838	18-5803	18-5803	18-5803
120	1978-81	18-5717	18-5838	—	—	—
140	1973-77	18-5717	18-5838	18-5803	18-5803	18-5803
140	1978-81	18-5717	18-5838	—	—	—
145 ①	1973	—	18-5838	18-5803	N/A	N/A
150	1964	18-5717	18-5838	18-5807	N/A	18-5807
150	1965-66	18-5717	18-5838	18-5808	N/A	18-5808
155	1967-72	18-5717	18-5838	18-5808	N/A	18-5808
165	1972-76	18-5717	18-5838	18-5803	18-5803	18-5803
170	1974	—	N/A	18-5801	N/A	18-5803
175	1975-78	—	N/A	18-5801	N/A	18-5803
185	1967-68	18-5717	18-5838	18-5808	N/A	18-5808
185	1978-80	18-5717	18-5838	—	—	—
190	1974-78	—	N/A	18-5801	N/A	18-5803
200	1966-78	18-5717	18-5838	18-5808	N/A	18-5808
200	1979-81	—	18-5838	—	—	—
210	1968-70	18-5717	18-5838	18-5808	N/A	18-5808
210 ②	1970-72	18-5717	18-5838	18-5808	N/A	N/A
215	1971	18-5717	18-5838	18-5808	N/A	18-5808
225	1972	18-5717	18-5838	18-5808	N/A	18-5808
225	1973	18-5717	18-5838	18-5803	N/A	18-5808
225	1974-76	18-5717	18-5838	18-5803	N/A	18-5803
225	1978	18-5717	18-5838	—	—	—
225 ②	1973-74	18-5717	18-5838	18-5808	N/A	N/A
230 ②	1975-76	18-5717	18-5838	18-5803	N/A	N/A
230	1979-81	18-5717	18-5838	—	—	—
235	1971	18-5717	18-5838	18-5808	N/A	18-5808
235	1975-78	—	N/A	18-5801	N/A	18-5803
245	1972	18-5717	18-5838	18-5808	N/A	18-5808
245	1973	18-5717	18-5838	18-5803	N/A	18-5808
245	1974-75	18-5717	18-5838	18-5803	N/A	18-5803
245 ①	1972-75	18-5717	18-5838	18-5808	N/A	N/A
250 ②	1970-74	—	18-5838	18-5808	N/A	N/A
260 ②	1975-76	18-5717	18-5838	18-5803	N/A	N/A
260	1979-81	18-5717	18-5838	—	—	—
290 ①	1974-75	18-5717	18-5838	18-5808	N/A	N/A
305 ②	1977-82	18-5717	18-5838	—	N/A	N/A
350 ②	1977-82	18-5717	18-5838	—	N/A	N/A
454 ②	1977-82	18-5717	18-5838	—	N/A	N/A
2.5	1982	18-5717	18-5838	—	—	—
2.5	1983-86	18-5717	18-5837	—	—	—
3	1982	18-5717	18-5838	—	—	—
3	1983-86	18-5717	18-5837	—	—	—
3.8	1981-82	18-5717	18-5838	—	N/A	—
3.8	1983-86	18-5717	18-5837	—	N/A	—
4.3	1985-86	18-5717	18-5837	—	N/A	—
5	1982	18-5717	18-5838	—	—	—
5	1983-86	18-5717	18-5837	—	—	—
5.7	1982	18-5717	18-5838	—	—	—
5.7	1983-86	18-5717	18-5837	—	—	—

① Jet Drive

② Inboard

OMC COBRA SOLENOID APPLICATION

HP	Year	Starter Brush	Starter Mounted Solenoid	Starter Solenoid	Trim Solenoid
262	1989	N/A	18-5837	18-5812	N/A
350	1988	N/A	18-5837	18-5812	18-5812
350	1989	N/A	18-5837	18-5812	N/A
350	1990-91	N/A	18-5837	18-5801	N/A
351	1992	—	—	18-5801	N/A
370	1988	N/A	—	18-5812	18-5812
370	1989	N/A	—	18-5812	N/A
454	1990	—	—	18-5801	N/A
454	1991-92	N/A	18-5837	18-5801	N/A
460	1989-90	N/A	—	18-5801	N/A
502	1992	N/A	18-5837	18-5801	N/A
2.3	1987-88	N/A	—	18-5801	18-5812
2.3	1989-90	N/A	—	18-5801	N/A
2.5	1986	18-5717	18-5837	18-5812	18-5812
3	1986-88	18-5717	18-5837	18-5812	18-5812
3	1989-90	18-5717	18-5837	18-5812	N/A
3	1991-92	18-5717	18-5837	18-5801	N/A
4.3	1986-88	18-5717	18-5837	18-5812	18-5812
4.3 ①	1989-90	18-5717	18-5837	18-5812	N/A
4.3 ②	1990-92	18-5717	18-5837	18-5801	N/A
5	1986-88	18-5717	18-5837	18-5812	18-5812
5	1989-92	18-5717	—	18-5801	N/A
5.7	1986-88	18-5717	18-5837	18-5812	18-5812
5.7	1989	18-5717	18-5837	18-5812	N/A
5.7	1990-92	18-5717	18-5837	18-5801	N/A
5.8	1989-92	N/A	—	18-5801	N/A
7.5	1987	18-5717	—	18-5801	18-5812

① 1990 Models with 2 barrel carbs

② 1990 Models with 4 barrel carbs.

18-5711 VOLTAGE REGULATOR

Replaces: 383440
Prestolite: VSH-6201 AFY
12 Volt



Years	Model	Alternator or Generator
1964-66	110, 150 HP	ALK-6222, A, AYS
1967-81	80, 90, 120, 140, 155, 165, 175, 185, 190, 200, 210, 225, 230, 235, 250, 260 HP & 305, 350, 454 CID	ALK-6222, A, AY, Y, AYS ANK-65201S, Y ALK-6210, A

18-6261 ALTERNATOR

Replaces: 987774, 3857561, 3854182, 3854809, 3856600, 3860171
Fits: 3.0L, 4.3L, 5.7L, 7.4L (1995-98), 5.0L, 5.8L, 8.2L (1993-98)
For: Delco



18-6260 ALTERNATOR

OMC Cobra 12 Volt, 51 Amp, Internal Regulator, Negative Ground, Single Groove Pulley
For: Prestolite/Motorola



18-6841 ALTERNATOR

Replaces: 983424, 836, 247
For: 37-63A Marine Applications



18-5957 ALTERNATOR

Replaces: 982364
(3-Wire) (68 AMP)
Replaces Mando, Motorola and original equipment Delco. Uses same electrical connections and mounting method. Equipped with fan and drive pulley.
SAEJ1171





18-2192
ELECTRIC SHIFT CABLE
 Replaces: 379628

ELECTRIC SHIFT CABLE APPLICATION

Year	HP
1964	110 ②, 150
1965	120 ①, 150
1966	120 ①, 150, 200
1967	120 ①, 155, 185, 200
1968	120, 155, 185, 200, 210
1969-70	120, 155, 210
1971	120, 155, 215, 235
1972-73	100, 120, 155, 165, 225, 245
1974	120, 140, 165, 170, 190, 225, 245
1975	120, 140, 165, 175, 190, 225, 235, 245
1976	120, 140, 165, 175, 190, 225, 235
1977	120, 140, 175, 190, 235

① Heavy Duty ② SU12M, SUE 12M

③ 18-5705D Display Package



18-5705
POWER TRIM/FUEL PUMP RELAY
 Replaces: 582472, 584416, 586224
 5 Terminal
 Single Pull - Double Throw - 12 Volt
 Open Contact: 40 Amps Resistive
 30 Amps Conductive
 Closed Contact: 20 Amps Resistive
 15 Amps Conductive



18-6257
TILT/TRIM MOTOR
 Replaces: 983195, 982957
 1982-85 Models with hydraulic engine lifts for pump assembly



18-6754
TILT MOTOR
 Replaces: 382138
 Prestolite ETK 4102, ETK 4001, ETK 4101
 (All Models 1963-77)



18-6755
TILT MOTOR
 Replaces: 982706, 982058
 Prestolite EVD 4001, EVD 4002
 (All Models Except 2.5L, 3.0L - 1978-85)



18-6764
TILT/TRIM MOTOR
 Replaces: 982073, 983318, 982069
 For: OMC Stringer and Cobra "Select Trim" 3-Wire Connection
 1979-85 Stern Drive (2.5L & 3.0L)



18-6779
TRIM MOTOR
 Replaces: 986280, 3853945
 For: 1990 & 1994 King Cobra Trim System



18-6814
TRIM MOTOR
 Replaces: 984356
 OMC Cobra



18-6823
WIRING HARNESS
 Replaces: Universal
 Converts 3-wire Tilt and Trim motors to 2-Wire design



18-6950
18-6950-9①
POWER TILT FUSE
 (50 amp)
 Replaces: 982019



18-9802
TIMING LIGHT
 Self-powered accurate up to 10,000 RPM's



18-7601
AIR CHARGE TEMPERATURE SENSOR
 Replaces: 3854158
 8 cyl
 5.0L, 5.8 L, EFI (1994-96)



18-7684
MAP SENSOR
 Replaces: 3850396
 For: 4.3L TBI(1996-98), 5.0L TBI(1998), 5.7L TBI(1996-98), 7.4L(1995-98), 8.2L(1998)



18-7677
KNOCK SENSOR
 Replaces: 3850357



18-7679
KNOCK SENSOR
 Replaces: 3854905



18-7703
KNOCK SENSOR
 Replaces: 3854512



18-7689
FUEL INJECTOR
 Replaces: 3855182

③ Items ending in "D" are Display Packaged - Regular number is Non-Display

ALL SIERRA CARBURETORS INCLUDE BASE GASKET

- Precision remanufactured to meet or exceed OEM specifications
- Re-calibrated and re-engineered to maximize fuel efficiency and performance
- All carburetors are flow tested throughout the entire throttle range
- Fuel mixture and idle settings are pre-set to ensure that only minor idle and choke adjustments are necessary during installation
- All bases are resurfaced and throttle shaft bushings replaced



**18-7635
CARBURETOR
(REMANUFACTURED)**
300 CFM Holley 2V
Use replacement gasket **18-0360**



**18-7636
CARBURETOR
(REMANUFACTURED)**
500 CFM Holley 2V
Use replacement gasket **18-0994**



**18-7637
CARBURETOR
(REMANUFACTURED)**
600 CFM Holley 4V
(Includes gasket)



**18-7638
CARBURETOR
(REMANUFACTURED)**
600 CFM Holley 4V-side inlet



**18-7640
CARBURETOR
(REMANUFACTURED)**
Universal Q-jet with electric choke
Use replacement gasket **18-0462**



**18-7605-1
CARBURETOR**
4 Barrel Rochester
Replaces: 382821, 383766, 384194
Remanufactured
Use replacement gasket **18-2948**
Use Carb Replacement Kit **18-7095**



**18-7608-1
CARBURETOR**
2 Barrel Rochester
Replaces: 381668, 980528, 982219, 982217
Remanufactured
Use replacement gasket **18-0356**
Use Carb Replacement Kit **18-7070**



**18-7609-1
CARBURETOR**
2 Barrel Rochester
Replaces: 382733, 980530, 982217, 984180, 381494, 772831
Remanufactured
Use replacement gasket **18-0356**
Use Carb Replacement Kit **18-7070**



**18-7615-1
CARBURETOR**
4 Barrel Rochester
Replaces: 981705, 982223, 983855, 981359, 981564, 985822, 981803, 981428
Remanufactured
Use replacement gasket **18-2948**
Use Carb Replacement Kit **18-7095**



**18-7615N
Q-JET CARBURETOR**
Replaces: 1347-816373A4, 1347-804624R1, 1347-804624R02
(Includes gasket)
Use Carb Replacement Kit **18-7095**



OMC STERN DRIVE CARBURETOR APPLICATION

Model	Year	OMC Carburetor #	MFG Carburetor #	Carb Code & Model	Part #
80	1968-69	382733, 772831	7028085, 17059053, 17086064, 17087311	R2, 2GC	18-7609-1
90	1970-71	382733, 772831	7028085, 17059053, 17086064, 17087311	R2, 2GC	18-7609-1
120 (400 Series)	1972-86	381668, 980528, 982219	7044186, 17059056	R2, 2GC	18-7608-1
140 (400 Series)	1973-85	979821, 980530, 982217, 984180	17086107	R2, 2GC	18-7608-1
155	1967-72	772831	7026180	R2, 2GC	18-7609-1
165	1972-76	979821, 980530	17086107	R2, 2GC	18-7609-1
185	1989	984180	17086064	R2, 2GC	18-7609-1
200	1966-68	381494	7025187	R2, 2GC	18-7609-1
210	1968-72	382821, 383766	7028282, 7028280	R4, 4MV	18-7605-1
215, 225, 230	1971-76	382821	7028280	R4, 4MV	18-7605-1
230 (800 Series)	1979-89	981705, 982223	17057290, 17059285, 17059286, 17086117	R4, 4MV	18-7615-1
245	1972-75	384194	7040284	R4, 4MV	18-7605-1
250	1970-74	384194	7040284	R4, 4MV	18-7605-1
260 (800 Series)	1975-76	384194	7040284	R4, 4MV	18-7605-1
260 (800 Series)	1979-89	982223	17057290, 17059285, 17059286, 17086117	R4, 4MV	18-7615-1
2.5L, 3.0L	1982-86	982219, 982217	17059056, 17059053	R2, 2GC	18-7608-1
3.0L	1987-90	984180	17086064	R2, 2GC	18-7608-1
3.8L (4V)	1979-85	983855	17082515, 17085010	R4, 4MV	18-7615-1
4.3L (4V)	1979-89	983855	17082515, 17085010	R4, 4MV	18-7615-1
5.0L (GM)(4V)	1979-89	982223	17057290, 17059285, 17059286, 17086117	R4, 4MV	18-7615-1
5.7L (4V)	1979-89	982223	17057290, 17059285, 17059286, 17086117	R4, 4MV	18-7615-1
305, 350 Ci, I/B	1977-83	981359, 982215, 981564, 982223	17057290, 17059285, 17059286, 17086117	R4, 4MV	18-7615-1
350 (4V)	1988-89	985822	17057290, 17059285, 17059286, 17086117	R4, 4MV	18-7615-1
454 Ci, I/B	1977-78	981803, 981428	17057290, 17059285, 17059286, 17086117	R4, 4MV	18-7615-1



**18-7017
CARB KIT**
Replaces: 985052
235 (5.8L Ford) 1989 7.5L/460 C.I. 1987-89
(Contains Non-adjustable needles and seats)



**18-7018
CARB KIT**
Replaces: 982352
350 C.I. Inboard 1977-78



**18-7070
CARB KIT**
Replaces: 383615, 982384



**18-7071
CARB KIT**
Replaces: 380186



**18-7072
CARB KIT**
Replaces: 979659, 384743



**18-7080
CARB KIT**
Replaces: 979719



**18-7081
CARB KIT**
Replaces: 982537, 982538
(Contains adjustable needles and seats)



**18-7086
CARB KIT**
Replaces: 984487

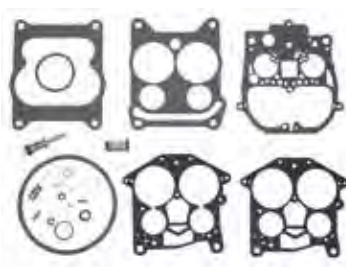

**18-7095
CARB KIT**
Replaces: 983864, 383918



**18-7096
CARB KIT**
Replaces: 982539, 85R-4541
(Contains adjustable needles and seats)



**18-7235
CARB KIT**
Replaces: 986783



**18-7236
CARB KIT**
Replaces: 986782



**18-7237
CARB KIT**
Replaces: 986784, 986799



**18-7238
CARB KIT**
Replaces: 986796



**18-7239
CARB KIT**
Replaces: 986800



**18-7241
CARB KIT**
Replaces: 986804



**18-7242
CARB KIT**
Replaces: 987313



**18-7243
CARB KIT**
Replaces: 987315



**18-7244
CARB KIT**
Replaces: 987317



**18-7245
CARB KIT**
Replaces: 987319



**18-7246
CARB KIT**
Replaces: 987438, 987440, 987485



**18-7727
CARB KIT**



**18-7729
CARB KIT**



**18-7730
CARB KIT**

18-7200
FLOAT
 (Alcohol Resistant)
 Replaces: 381389
 Plastic



18-7201
FLOAT
 (Alcohol Resistant)
 Replaces: 383087, 983871
 Brass



18-7206
NITROPHYL FLOAT
 Nitrophyl



CARBURETOR KIT/FLOAT APPLICATION

Model	Years	Mfg. Code	Carb. Model	Carb Kit	Float
80	1968-69	R2	2GC	18-7070	18-7200
90	1970-71	R2	2GC	18-7070	18-7200
100	1972-73	C1	RBS	18-7080	—
110	1964	R1	BC	18-7071	—
120	1965-71 (Dual Carb)	C1	RBS	18-7080	—
120	1972-85	R2	2GC	18-7070	18-7200
140	1973-85	R2	2GC	18-7070	18-7200
150	1964-65	R1	BC	18-7071	—
150	1965-66	C1	RBC	18-7080	—
155	1967-72	R2	2GC	18-7070	—
165	1972-76	R2	2GC	18-7070	18-7200
170	1974	H2	2300	18-7081	18-7206
175	1975-77	H2	2300	18-7081	18-7206
185	1978-81	R2	2GE	18-7086	18-7200
185	1989	H2	2300	18-7081	18-7206
190	1974-77	H2	2300	18-7081	18-7206
200	1966-68	R2	2GC,V	18-7070	—
200	1979-85	R2	2GE	18-7086	18-7200
200	1989	H2	2300	18-7081	18-7206
210	1968-72	R4	4MV	18-7072	18-7201
215	1971	R4	4MV	18-7072	18-7201
225	1972-76	R4	4MV	18-7072	18-7201
230	1975-76	R4	4MV	18-7072	18-7201
230	1979-89	R4	4MV	18-7095	18-7201
235	1975-77	H4	4160	18-7096	18-7206
235	1989	H4	4160	18-7017	—
240	1978	H4	4160	18-7017	—
245	1972-75	R4	4MV	18-7072	18-7201
250	1970-74	R4	4MV	18-7072	18-7201
250	1979	H4	4160	18-7017	—
260	1975-76	R4	4MV	18-7072	18-7201
260	1979-89	R4	4MV	18-7095	18-7201
290 JET	1974-75	R4	4MV	18-7072	18-7201
2.3L	1987-89	R2	2GE	18-7086	18-7200
2.5L	1982-85	R2	2GC	18-7070	18-7200
2.5L	1986-90	R2	2GE	18-7086	18-7200
2.5L	1986	R2	2GC	18-7070	18-7200
3.0L ②	1982-90	R2	2GC	18-7070	18-7200
3.0L/3.0L H.O.	1991-92	H-2	2300	18-7246	N/A
3.8L	1979-85	R2	2GE	18-7086	18-7200
4.3L	1986-89	R2	2GE	18-7086	18-7200
4.3L	1979-89	R4	4MV	18-7095	18-7201
4.3,4.3 H.O. ②	1990-92	H2	2300	18-7238	N/A
4.3,4.3 H.O. ③	1990-92	H4	4160	18-7237	N/A
4.3/262 ②	1989	R2	2GE	18-7086	18-7200
5.0L (GM)	1979-85	R2	2GE	18-7086	18-7200
5.0L (GM)	1979-89	R4	4MV	18-7095	18-7201

② For 2V Carburetors
 ③ For 4V Carburetors
 ④ For Engine Model 574APEPWS

⑥ For 1990 PWC Suffix Only
 ⑨ For Engine Model 574APERGD

① For Engine Model 744DPEAMH, 744DPPAMH
 ② For Engine Model 744CPEAMH, 824BPEAM

CARBURETOR KIT/FLOAT APPLICATION

Model	Years	Mfg. Code	Carb. Model	Carb Kit	Float
5.0L (FORD)	1989	H2	2300	18-7081	18-7206
5.0,5.0 H.O. ③	1989-90	H4	4160	18-7237	N/A
5.0,5.0 H.O. ②	1989-90	H2	2300	18-7236	N/A
5.0,5.0 H.O. ③	1991	H4	4160	18-7245	N/A
5.0,5.0 H.O. ②	1991	H4	4175	18-7244	N/A
5.0,5.0 H.O. ①	1992	H4	4150	18-7242	N/A
5.7L	1979-89	R4	4MV	18-7095	18-7201
5.7	1990-92	H4	4175	18-7239	N/A
5.7 LE ⑨	1991-92	H4	4175	18-7243	N/A
5.7 LE ④	1990	H4	4175	18-7239	N/A
5.8L	1989	H4	4160	18-7017	—
7.5L	1987-88	H4	4160	18-7017	—
305 C.I./B	1977-79	R2	2GE	18-7086	18-7200
305 C.I./B	1977-78	R4	4MV	18-7018	18-7201
305 C.I./B	1979-83	R4	4MV	18-7095	18-7201
350 C.I./B	1977-78	R4	4MV	18-7018	18-7201
350 C.I./B	1979-83	R4	4MV	18-7095	18-7201
350 ④ ③	1988-89	R4	4MV	18-7095	18-7201
350 ②	1988	R2	2GE	18-7086	18-7200
351 CID/5.8L H.O.	—	H4	4010, R50483A, R84046A (F1JL-9510-EA)	18-7727	—
351 CID/5.8L	—	H4	4160, R9393A, R9394A, R50399A, R50399-1A	18-7729	—
351 CID/5.8L	—	H4	4160C, R80434A	18-7730	—
454 C.I./B	1977-78	R4	4MV	18-7072	18-7201
454,454 H.O. ①	1991-92	H4	4150	18-7242	N/A
454,454 H.O. ②	1990-92	H4	4150	18-7241	N/A
460 C.I.	1987-88	H4	4160	18-7017	—
460	1989-90	H4	4160	18-7235	N/A

- ② For 2V Carburetors
- ③ For 4V Carburetors
- ④ For Engine Model 574APEPWS

- ⑥ For 1990 PWC Suffix Only
- ⑨ For Engine Model 574APERGD

- ① For Engine Model 744DPEAMH, 744DPPAMH
- ② For Engine Model 744CPEAMH, 824BPEAM

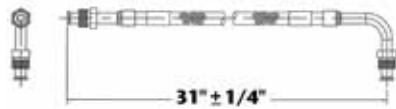

**18-8114
FUEL LINE HOSE**

For fuel pump to carburetor connection. Replaces copper or steel tubing 3/8" X 31" PTFE composite hose with 5/8"-18 male inverted flare straight one end, 5/8"-18 90° one end. SAE J1527 type A1

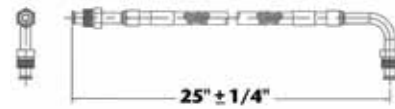

**18-8115
FUEL LINE HOSE**

For fuel pump to carburetor connection. Replaces copper or steel tubing 3/8" X 25" PTFE composite hose with 5/8"-18 male inverted flare straight one end, 5/8"-18 90° one end. SAE J1527 type A1



ALL SIERRA FUEL PUMPS INCLUDE MOUNTING GASKET



**18-7256
FUEL PUMP**
Flange I.D. # 6790

For: GM (4 & 6 cyl.) 153, 230, 250, 292



**18-7258
FUEL PUMP**
Replaces: 380986
Flange I.D. # 40001, M643

For: GM (V-6) 225, PB-V215



**18-7265
FUEL PUMP**
Flange I.D. # 41412, M73018

For: GM (V-8) 305, 350, 400



**18-7267
FUEL PUMP**
Replaces: 982063
Flange I.D. # 40778, M73016
(Includes gasket)

For: Ford (V-8) 302



**18-7268
FUEL PUMP**
Replaces: 981650
Flange I.D. # 41415

For: GM (V-8) 305, 307, 350, 400
Dual diaphragm sight glass required.



**18-7278
FUEL PUMP**
Replaces: 985602, 985603, 982240
Flange I.D. # M60032
Uses filter 18-7860

For: GM (4 & 6 cyl.) 153, 181, 250, 224, 225



**18-7289
FUEL PUMP**
Replaces: 982997
Flange I.D. # 60201
(Includes gasket)

For: GM (V-6) 262/4.36

FUEL PUMP APPLICATION

Model	Years	Pump #	Model	Years	Pump #
2.5	1982-85	18-7278	185	1978-80	18-7268
5	1982-88	18-7268	190	1974-77	—
5.7	1982-92	18-7268	200	1979-81	18-7268
100	1972-73	18-7278	225	1978	18-7268
110	1964	18-7278	230	1979-81	18-7268
120	1965-80	18-7278	235	1975-77	—
140	1973-81	18-7278	240	1978	—
140 Jet Drive	1973	18-7278	245 Jet Drive	1973	18-7278
150	1964	—	250	1979	—
150 Model HU-13EM	1965	—	260	1979-81	18-7268
150 Except HU-13EM	1965	—	305 CID IB	1979-82	18-7268
165	1972-76	18-7278	350 CID IB	1979-82	18-7268
170	1974	—	350	1988-91	18-7268
175	1975-77	—			



18-7326
ELECTRIC FUEL PUMP
 Replaces: 3858261, 3857986, 3850809, 3854620



18-7330
ELECTRIC FUEL PUMP
 Replaces: 3857650, 3855958, 3854280, 987620, 988037



18-7331
ELECTRIC FUEL PUMP
 Replaces: 3850810



18-7229
FLAME ARRESTOR
 Replaces: 986865, 981566

ELECTRIC FUEL PUMP APPLICATION

Year	Engine	Application	OE #	#s Superseded from	Part #
1992-94	262/4.3L	Low Pressure	3858261	3850809, 3850810, 3857985	18-7326
1997-98	350/5.7L, 454/7.4L, & 502/8.2L	Engines w/MPI - High Pressure	3857650		18-7330
1996	454/7.4L & 502/8.2L	Engines w/MPI - High Pressure	3857650		18-7330
1993-94	4.3L thru 5.8L	Low pressure electric fuel pump	3858261	3850809	18-7326
1992-1994	454/7.4L & 502/8.2L	GM Mark V Eng. - Low Pressure	3858714	3850810, 3857985	18-7331

- UNIVERSAL DESIGN -

FUEL WATER SEPARATOR BRACKETS



Bracket Type	Part #
1/4" Stainless Steel	18-7777
3/8" Stainless Steel	18-7776

Bracket Type	Part #
1/4" Aluminum	18-7853-1
3/8" Aluminum	18-7775

FUEL WATER SEPARATOR KITS



21 MICRON FILTER KITS FOR CARBURETED ENGINES

Kit Type	Part #	Micron Rating	Contents
1/4" Aluminum (Short Filter)	18-7848-1 •	21	1 - 18-7844 filter & 1 18-7853-1 bracket, 2 - 18-4256 1/4" pipe plugs
1/4" Aluminum Bonus Pack (Contains spare filter)	18-7848-2 •	21	2 - 18-7844 filter & 1 18-7853-1 bracket, 2 - 18-4256 1/4" pipe plugs
1/4" Aluminum (Tall Filter)	18-7852-1 •	21	1 - 18-7845 filter & 1 18-7853-1 bracket, 2 - 18-4256 1/4" pipe plugs
1/4" Aluminum Bonus Pack (Contains spare filter)	18-7852-2 •	21	2 - 18-7845 filter & 1 18-7853-1 bracket, 2 - 18-4256 1/4" pipe plugs
3/8" Aluminum (Tall Filter)	18-7775-1 •	21	1 - 18-7845 filter & 1 18-7775 bracket, 2 - 18-4264 3/8" pipe plugs
1/4" Stainless Steel (Tall Filter)	18-7777-1 •	21	1 - 18-7845 filter & 1 18-7777 bracket, 2 - 18-4256 1/4" pipe plugs
3/8" Stainless Steel (Tall Filter)	18-7776-1 •	21	1 - 18-7845 filter & 1 18-7776 bracket, 2 - 18-4264 3/8" pipe plugs

10 MICRON FILTER KITS FOR FUEL INJECTED ENGINES



Kit Type	Part #	Micron Rating	Contents
1/4" Aluminum (Short Filter)	18-7983-1 •	10	1 - 18-7944 filter & 1 18-7853-1 bracket 2 - 18-4256 1/4" pipe plugs
1/4" Aluminum Bonus Pack Contains spare filter	18-7983-2 •	10	2 - 18-7944 filter & 1 18-7853-1 bracket 2 - 18-4256 1/4" pipe plugs
1/4" Aluminum (Tall Filter)	18-7982-1 •	10	1 - 18-7945 filter & 1 18-7853-1 bracket 2 - 18-4256 1/4" pipe plugs
1/4" Aluminum Bonus Pack Contains spare filter	18-7982-2 •	10	2 - 18-7945 filter & 1 18-7853-1 bracket 2 - 18-4256 1/4" pipe plugs
1/4" Aluminum (High Capacity Filter)	18-7966-1 •	10	1 - 18-7866 filter & 1 18-7853-1 bracket 2 - 18-4256 1/4" pipe plugs
3/8" Aluminum (Tall Filter)	18-7986-1 •	10	1 - 18-7945 filter & 1 18-7775 bracket 2 - 18-4264 3/8" pipe plugs
1/4" Stainless Steel (Tall Filter)	18-7984-1 •	10	1 - 18-7945 filter & 1 18-7777 bracket 2 - 18-4256 1/4" pipe plugs
3/8" Stainless Steel (Tall Filter)	18-7985-1 •	10	1 - 18-7945 filter & 1 18-7776 bracket 2 - 18-4264 3/8" pipe plugs



10 MICRON FILTER KITS WITH DRAIN BOWLS

Sierra AquaVue™ and metal bowl separator filters allow water to be drained from the filter to extend service life. Use the AquaVue™ bowl for outboard, above deck installations. USCG regulations require the use of the flame resistant metal bowl below deck.

Kit Type	Part #	Micron Rating	Contents
1/4" Aluminum w/ metal drain bowl	18-7951 •	10	1 - 18-7919 filter & 1 18-7853-1 bracket 1 - 18-7924 metal bowl 2 - 18-4256 1/4" pipe plugs
1/4" Stainless Steel w/ metal drain bowl	18-7938 •	10	1 - 18-7919 filter & 1 18-7777 bracket 1 - 18-7924 metal bowl 2 - 18-4256 1/4" pipe plugs

• Display Packaged

COMPACT BRACKET AND SEPARATOR KIT - FOR SMALL OUTBOARDS AND FRESH WATER APPLICATIONS

18-7774
COMPACT ALUMINUM BRACKET



18-7965-1
10 MICRON COMPACT SEPARATOR KIT
Contains:
1 - 18-7774 bracket
1 - 18-7865 filter



REPLACEMENT FILTERS



UNIVERSAL DESIGN

10 MICRON REPLACEMENT FILTERS			21 MICRON REPLACEMENT FILTERS		
Part #	Description		Part #	Description	
18-7944	Short - 3.875"		18-7844	Short - 3.875"	
18-7945	Long - 4.35"		18-7845	Long - 4.35"	
18-7866	High Capacity - 6"				
18-7865	Compact 10 Micron				

REPLACEMENT FILTERS FOR OMC

10 MICRON REPLACEMENT FILTERS			21 MICRON REPLACEMENT FILTERS		
Part #	Description	Replaces	Part #	Description	Replaces
18-7946	OMC thread	OMC 502905	18-7846	OMC thread	OMC 502905
18-7989	Cobra EFI	OMC 502906	18-7789	Cobra EFI	OMC 502906



10 MICRON REPLACEMENT FILTERS AND KITS WITH DRAIN BOWLS

REPLACEMENT FILTERS			FILTER & BOWL KITS		
Part #	Description	Replaces	Part #	Description	
18-7919	Spin on replacement	Racor S3213	18-7929 •	Filter & Metal Bowl Contains: 18-7919 filter, 18-7924 bowl	
18-7920	Spin on replacement	OMC 771839 Racor S3214	18-7941-1 •	Filter & AquaVue™ Bowl OMC style Contains: 18-7920 filter, 18-7922-1 bowl	
18-7947	Spin on replacement Fits - 120RRAC01	Racor S3240	18-7943 •	Filter & Metal Bowl OMC style Contains: 18-7920 filter, 18-7924 bowl	
18-7948	Spin on replacement Fits - 320RRAC01	Racor S3227	REPLACEMENT ELEMENTS		
18-7949	Spin on replacement Fits - 660RRAC02	Racor S3232	Part #	Description	Replaces
REPLACEMENT BOWLS			18-7930	1977-83 Fuel system with add on filter kit	OMC 173326
Part #	Description				
18-7924	Metal Collection Bowl				



18-7792
FUEL FILTER
Replaces: 910641, 3855104
Fits: OMC 3.0L (1996-98), 3.8L/170 (1981)



18-7854
FUEL FILTER
Replaces: 984491, 311684
Rochester 17078904



18-7855
FUEL FILTER
Replaces: 983870, 910139
Rochester 17068453

• Display Packaged



**18-7717
FILTER ELEMENT**
For: Rochester 2 bbl & 4 bbl Carburetors



**18-7859
FUEL FILTER**
Replaces: 908034
For: Most GM Inline 4 & 6 cycle;
Ford and GM V-8's up to 400 HP



**18-7860
FUEL FILTER**
Replaces: 381690, 312456
with AC Fuel Pumps
For: Inline 4 & 6 cycle engines



**18-7861
REPLACEMENT
CANISTER AND FILTER**
Replaces: 981911



**18-7862
FUEL FILTER ELEMENT
For Fuel Filter
(Includes Gasket)**
Replaces: 982230



**18-7964-1
TRANSMISSION FILTER KIT**



**18-8072
FUEL ELBOW**
 $\frac{3}{8}$ " Hose Barb with
 $\frac{3}{8}$ " NPT Thread
Replaces: 174177
90°



**HOSE BARB
NPT Thread**
18-8074 $\frac{3}{8}$ " with $\frac{1}{4}$ "
18-8055 $\frac{5}{16}$ " with $\frac{1}{4}$ "
Replaces: 173312 Replaces: 173311

PKG. OF 10

SNAPPER CLAMPS

Part No.	O.E. No.	Range	Size
18-8020 ①	322652	.538 - .608	8
18-8021 ①	911616	.597 - .665	10
18-8034 ①	329654	.670 - .780	12
18-8200 ①	322653	.360 - .406	2
18-8201 ①	124249	.410 - .468	4
18-8202 ①	322654	.475 - .536	6
18-8203 ①	329653	.750 - .875	14
18-8204 ①	324825	.875 - .975	19



**18-5894
OIL PRESSURE LIGHT SWITCH**
Replaces: 0379948

ALL SIERRA WATER PUMPS ARE BI-DIRECTIONAL



**18-3593
CIRCULATING WATER PUMP**
Replaces: 0984360, 0986779, 380640, 3854017, 3858340
Uses gasket **18-0327 (Included)**
For: GM Inline (4 & 6 Cylinder)



**18-3577-2
CIRCULATING WATER PUMP**
Replaces: GM 6269358, OMC 987447,
983296, 986074, 3854118
For: GM Big Block



**18-3578
CIRCULATING WATER PUMP**
Replaces: 984876



**18-3584
CIRCULATING WATER PUMP**
Replaces: 982517, 3853796, 982515
Uses gasket **18-0147 (Included)**
For: Ford V8 small block



**18-3599-2
CIRCULATING WATER PUMP**
Replaces: 382218, 980477, 985429, 3853850
For: GM V-6 & small block V-8 engines
Uses gasket **18-0981 (included)**

① This product is priced per piece. To order priced per package, please add -9 to the part number.

WATER CIRCULATING PUMP APPLICATION

Model	Year	Part #	Model	Year	Part #	Model	Year	Part #
2.3	1987-90	-	165	1972-76	18-3593	245	1972-75	18-3599-2
2.5	1982-86	18-3593	175	1977	18-3584	245		
3	1982-92	18-3593	185	1967-80	18-3599-2	Jet Drive	1972-75	18-3599-2
3.8	1981-86	18-3599-2	190	1977	18-3584	250		
4.3	1985-92	18-3599-2	200	1979-81	18-3599-2	Inboard	1970-74	18-3599-2
5	1982-88	18-3599-2	210	1968-70	18-3599-2	250	1979	18-3593
5	1989-92	18-3593	210			260		
5.7	1982-92	18-3599-2	Inboard	1970-72	18-3599-2	Inboard	1975-76	18-3599-2
5.8	1989-92	18-3593	215	1971	18-3599-2	260	1979-81	18-3599-2
100	1972	18-3593	225	1972-78	18-3599-2	262	1989	18-3599-2
100	1973	18-3599-2	225			290		
120	1965-69	18-3593	Inboard	1973-74	18-3599-2	Jet Drive	1974-75	18-3599-2
120	1972	18-3593	230			305 CID IB	1977-82	18-3599-2
120	1973-74	18-3599-2	Inboard	1975-76	18-3599-2	350 CID IB	1977-82	18-3599-2
120	1975-81	18-3593	230	1979-81	18-3599-2	350	1988-92	18-3599-2
140			235	1971	18-3599-2	351	1992	18-3584
Jet Drive	1973	18-3593	235	1977	18-3584	454 CID IB	1977-80	18-3577-2
140	1973-81	18-3593	240	1978	18-3584	454 CID IB	1982	18-3599-2



**18-3058
IMPELLER**
Replaces: 983895



**18-3086
IMPELLER**
Replaces: 379475, 777130



**18-30585
IMPELLER**
Replaces: 3854072
Fits: King Cobra (1992-1995)

IMPELLER APPLICATION

Model	Years	Impeller	Model	Years	Impeller
2.3	1987-1990	18-3058 ①	170	1974	18-3086
2.5	1986	18-3058	175	1975-1977	18-3086
3	1986-1992	18-3058 ①	185	1967-1968	18-3086
4.3	1986-1992	18-3058	185	1978-1984	18-3086
5	1986-1992	18-3058	190	1974-1977	18-3086
5.7	1986-1992	18-3058 ②	200	1966-1968	18-3086
5.8	1989-1992	18-3058	200	1979-1984	18-3086
50FAPLJVB, 50FAPJVN	1993	18-3058	210	1968-1972	18-3086
50FAPRJVB	1993	18-3058	215	1971	18-3086
50FACPMDA, 50FACPMMDM	1994	18-3060	225	1972-1976	18-3086
50FAGPMDA, 50FAGPMMDM	1994	18-3060	225	1978	18-3086
50FAGPMMDM	1994	18-3060	230	1975-1976	18-3086
58FACPMDA, 58FACPMMDM	1994	18-3060	230	1979-1981	18-3086
58FAGPMDA, 58FAGPMMDM	1994	18-3060	232AMFTC	1987	18-3086
58FAPLJVB, 58FAPLJVN	1993	18-3058	232AMRGDE, 232AMRGDP	1988	18-3058
58FAPRJVB, 58APRJVN	1993	18-3058	232APFTC	1987	18-3058
7.5	1987	18-3058	232APRGDE, 232APRGDP	1988	18-3058
80	1968-1969	—	232APSRC	1987	18-3058
88	1964	—	232BMRMED, 232BMRMEF	1989	18-3058
90	1965-1968	—	232BPRMED, 232BPRMEF	1989	18-3058
90	1970-1971	—	235	1971	18-3088
100	1972-1973	18-3086	235	1975-1977	18-3088
110	1964	— ③	240	1978	18-3088
110	1964	18-3086 ④	245	1972-1975	18-3086
120	1965-1967	— ③	250	1970-1974	18-3086
120	1965-1967	18-3086 ④	250	1979	18-3086
120	1968-1984	18-3086	252AMKWB, 252APKWB	1986	18-3058
140	1973-1984	18-3086	260	1975-1976	18-3086
150	1964-1966	18-3086	260	1979-1984	18-3086
155	1967-1972	18-3086	262	1989	18-3058
165	1972-1976	18-3086	262AMLMED, 262APRMED	1989	18-3058

① Except models originally equipped with short impeller or retrofitted with short impeller kit

② Except 1992 5.7LE models ③ Standars pump ④ Heavy duty pump

Model	Years	Impeller	Model	Years	Impeller
302AMARJ, 302AMARY	1987	18-3058	434AMKWB	1986	18-3058
302AMFTC	1987	18-3058	434AMPLPWS	1990	18-3058
302AMKWB	1986	18-3058	434AMWXS	1986	18-3058
302AMRGDP	1988	18-3058	434AMLGDP	1988	18-3058
302AMRMED	1989	18-3058	434APARY, 434APFTC	1987	18-3058
302APARY, 302APFTC	1987	18-3058	434APKWB	1986	18-3058
302APKWB	1986	18-3058	434APLAMH	1992	18-3058
302APRGDP	1988	18-3058	434APLJVB, 434APLJVN	1993	18-3058
302APRMED	1989	18-3058	434APLRGD	1991	18-3058
302APSRC, 302ARSRY	1987	18-3058	434APRAMH	1992	18-3058
302BMRAMH, 302BMRAMK	1992	18-3058	434APRGDP	1988	18-3058
302BMRJVB	1993	18-3058	434APRJVB, 434APRJVN	1993	18-3058
302BMRRGD	1991	18-3058	434APRPWS	1990	18-3058
302CCPMDA, 302CGPMDA	1994	18-3060	434APRRGD	1991	18-3058
302CMHUB	1995	18-3060	434APSRC, 434APSRV	1987	18-3058
302CMNCA, 302CMNCS	1996	18-3060	434APWXS	1986	18-3058
302CMRAMH, 302CMRRAMK	1992	18-3058	454	1977	18-3086
302CMRJVB	1993	18-3058	454	1990-1991	18-3058
302CMRRGD	1991	18-3058	460	1988-1990	18-3058
302CPHUB	1995	18-3060	460AMLMED	1989	18-3058
302CPNCA "A" SUFFIX MODELS	1996	18-3060	460APRMED	1989	18-3058
302CPNCS "A" SUFFIX MODELS	1996	18-3060	502ACPMDA	1994	18-3060
302CPRAMH, 302CPRAMK	1992	18-3058	502AGPMDA	1994	18-3060
302CPRJVB	1993	18-3058	502AMLGDP	1988	18-3058
302CPRRGD	1991	18-3058	502AMLMED	1989	18-3058
302DCMMDA, 302DGMMDA	1994	18-3060	502AMPLPWS, 502ANLPWS	1990	18-3058
305	1977-1978	18-3086	502APLAMH, 502APLAMK	1992	18-3058
350	1977-1978	18-3086	502APLJVB	1993	18-3058
350	1988-1991	18-3058	502APLRGD	1991	18-3058
350AMLMED, 350APRMED	1989	18-3058	502APRAMH, 502APRAMK	1992	18-3058
370	1988	18-3058	502APRGDP	1988	18-3058
432ACMMDA, 432ACPMDA	1994	18-3060	502APRJVB	1993	18-3058
432AGMMDA, 432AGPMDA	1994	18-3060	502APRMED	1989	18-3058
432AMARY, 432AMFTC	1987	18-3058	502APRPWS	1990	18-3058
432AMKWB	1986	18-3058	502APRRGD	1991	18-3058
432AMLGDP	1988	18-3058	502BPRAMH, 502BPRAMK	1992	18-3058
432AMLMED	1989	18-3058	502BPRJVB	1993	18-3058
432AMPLPWS	1990	18-3058	502BPRMED	1989	18-3058
432AMWXS	1986	18-3058	502BPRPWS	1990	18-3058
432APARY, 432APFTC	1987	18-3058	502BPRRGD	1991	18-3058
432APKWB	1986	18-3058	504AMARY, 504AMFTC	1987	18-3058
432APLAMH	1992	18-3058	504AMKWB	1986	18-3058
432APLJVB, 432APLJVN	1993	18-3058	504AMLGDP	1988	18-3058
432APLRGD	1991	18-3058	504AMWXS	1986	18-3058
432APRAMH	1992	18-3058	504APARY, 504APFTC	1987	18-3058
432APRGDE, 432APRGDP	1988	18-3058	504APKWB	1986	18-3058
432APRJVB, 432APRJVN	1993	18-3058	504APRGDP	1988	18-3058
432APRMED	1989	18-3058	504APWXS	1986	18-3058
432APRPWS	1990	18-3058	572ACPMDA, 572AGPMDA	1994	18-3060
432APRRGD	1991	18-3058	574AMFTC	1987	18-3058
432APSRC, 432APSRV	1987	18-3058	574AMKWB	1986	18-3058
432APWXS	1986	18-3058	574AMLGDP	1988	18-3058
434AMARY, 434AMFTC	1987	18-3058	574AMLMED	1989	18-3058

① Except models originally equipped with short impeller or retrofitted with short impeller kit

② Except 1992 5.7LE models ③ Standars pump ④ Heavy duty pump

Model	Years	Impeller	Model	Years	Impeller
574AML PWS	1990	18-3058	584AML MED	1989	18-3058
574AMWXS	1986	18-3058	584AML PWS	1990	18-3058
574APARY	1987	18-3058	584APL AMH, 584APL AMK	1992	18-3058
574APEPWS	1990	18-3058	584APL JVB	1993	18-3058
574APERGD	1991	18-3058	584APL RGD	1991	18-3058
574APFTC	1987	18-3058	584APR AMH, 584APR AMK	1992	18-3058
574APKWB	1986	18-3058	584APR JVB	1993	18-3058
574APL AMH	1992	18-3058	584APR MED	1989	18-3058
574APL RGD	1991	18-3058	584APR PWS	1990	18-3058
574APR AMH	1992	18-3058	584APR RGD	1991	18-3058
574APR GDP	1988	18-3058	744APEPWS	1990	18-3058
574APR MED	1989	18-3058	744APERGD, 744APERGF	1991	18-3058
574APR PWS	1990	18-3058	744BPERGD	1991	18-3058
574APR RGD	1991	18-3058	754APEPWS	1990	18-3058
574APSRC	1987	18-3058	754APFTC, 754APSRC	1987	18-3058
574APWXS	1986	18-3058	754BPFTC, 754BPSRC	1987	18-3058
574BML GDP	1988	18-3058			
574BPEPWS	1990	18-3058			
574BPERGD	1991	18-3058			
574BPR GDP	1988	18-3058			
584ACPMDA, 584AGPMDA	1994	18-3060			

- ① Except models originally equipped with short impeller or retrofitted with short impeller kit
- ② Except 1992 5.7LE models
- ③ Standars pump
- ④ Heavy duty pump



**18-3108
IMPELLER KEY**
Replaces: 308928
Fits: Sterndrive models (1968-85)
For: Stringer Drive Impeller 18-3086



**18-3111
WATER PUMP
SHAFT SEAL**
Replaces: 907774
I/O 1972-86
EXCEPT COBRA



**18-4833
WATER PASSAGE
HOUSING
(LOWER UNIT)**
Replaces: 915720
Fits: OMC Cobra (1986-93) without cone clutch



**18-4837
WATER PASSAGE COVER**
Replaces: 911734
Fits: OMC Cobra (1986-93) without cone clutch



**18-3119
WATER PUMP HOUSING**
Replaces: 983298



**18-3206
WATER PUMP HOUSING**
Replaces: 984744
For: OMC Cobra



**18-3145
PUMP LINER**
Replaces: 911844



**18-3121
IMPELLER PLATE**
Replaces: 911703
COBRA



**18-3141
IMPELLER PLATE**
Replaces: 313176
110-260 HP I/O 1968-86
EXCEPT COBRA



**18-3502
WATER PUMP VENT HOSE**
Replaces: 912614
Fits: OMC Cobra (1986-93) without cone clutch

① 18-3212-1D

Display Package



**18-3212-1
IMPELLER
REPAIR KIT**
Replaces: 984461

— CONTAINS —

Part #	Description	O.E.M. #	Qty.
18-2541	O-Ring	911704	1
18-2916	Water Pump Housing Gasket	911702	1
18-3058	Impeller	983895	1
18-3121	Impeller Plate	911703	1
18-3145	Pump Liner	911844	1



**18-3286
IMPELLER
REPAIR KIT**
1964-86
EXCEPT COBRA

— CONTAINS —

Part #	Description	O.E.M. #	Qty.
18-7135	O-Ring	310584	1
18-3141	Plate	313176	1
18-7129	O-Ring	314491	1
18-3111	Rubber Seal	907774	1
18-3086	Impeller	379475	1
18-7158	O-Ring	310585, 310967	1



**18-3386
WATER PUMP KIT**
Replaces: 983218
1964-86
EXCEPT COBRA

— CONTAINS —

Part #	Description	O.E.M. #	Qty.
18-7135	O-Ring	310584	1
18-3141	Plate	313176	1
18-7129	O-Ring	314491	1
18-3086	Impeller	379475	1
18-3111	Rubber Seal	907774	1
18-3119	Impeller Housing	983298	1
18-7158	O-Ring	310585, 310967	1



**18-3348
COMPLETE WATER PUMP KIT**
Replaces: 984461
For: All OMC Cobra Drives-2.3 (1987-90),
2.5 (1986), 3.0(1986-93), 4.3(1986-93), 4.6(1989),
5.0(1986-93), 5.7(1986-93),
5.8 (1989-93), 7.5(1987-89)
Uses impeller **18-3058**



**18-3469
WATER PUMP REPAIR KIT**
Replaces: 3854661
For: King Cobra Drives (1992-1995)



**18-3349
WATER PUMP HOUSING KIT**
For: All OMC Cobra Drives-2.3 (1987-90),
2.5 (1986), 3.0(1986-93), 4.3(1986-93),
4.6(1989), 5.0(1986-93), 5.7(1986-93),
5.8 (1989-93), 7.5(1987-89)



**18-5897
SENDER**
Replaces: 980613
3/8" — 18 NPT
For: Mercruiser Vazer



**18-5898
SENDER**
Replaces: 171960
1/2" — 14 NPT



**18-5899
OIL PRESSURE
SENDER**
Replaces: 982650



**18-3554
THERMOSTAT**
Replaces: 383307
160°



**18-3558
THERMOSTAT**
Replaces: 982554,
3853799
160°

① 18-3653D

Display Package



**18-3653
THERMOSTAT KIT**

— CONTAINS —

Part #	O.E. #	Desc.
18-3554	383307	Thermostat
18-2858	314809	Manifold Gasket
18-2917	3701777 (GM)	Thermostat Gasket
18-0398	3852111	Thermostat Gasket

APPLICATION FOR THERMOSTATS/KITS ON NEXT PAGE

① Items ending in "D" are Display Packaged - Regular number is Non-Display



① 18-3670D



**18-3670
THERMOSTAT KIT**

Fits: 2.5L & 3.0L (1982-88)

— CONTAINS —

Part #	O.E.#	Desc.
18-3558	982554	Thermostat
18-2858	314809	Thermostat Housing Cover Gasket
18-0929	313416	Thermostat Gasket



① 18-3676D



**18-3676
THERMOSTAT KIT**

140°

For: 7.4L (1994-98), 8.2L (1998)

— CONTAINS —

Part #	O.E.#	Desc.
18-7170	3852071	O-Ring
18-0398	3852111	Thermostat Gasket
—	3853983	Thermostat



① 18-3677D



**18-3677
THERMOSTAT KIT**
160°

— CONTAINS —

Part #	O.E.#	Desc.
18-7170	3852071	O-Ring
18-0398	3852111	Thermostat Gasket
—	3856961	Thermostat

HP	Year	HP	Year
4.3L	1994-97	5.8L	1994-97
4.3 HO	1991-97	5.8 (EFI)	1993-97
5.0 L	1994-97		

THERMOSTAT AND THERMOSTAT KIT APPLICATION

Model	Years	Thermostat	Thermostat Kit	Model	Years	Thermostat	Thermostat Kit
90	1970	18-3554	18-3653	250	1970-73	18-3554	18-3653
100	1972-73	18-3554	18-3653	250	1979	18-3554	18-3653
120	1969-80	18-3554	18-3653 ①	260	1979-81	18-3554	18-3653
120	1980-81	18-3558	18-3670 ②	262	1989	18-3554	—
140	1973-80	18-3554	18-3653 ①	305	1977-82	18-3554	18-3653
140	1980-81	18-3558	18-3670 ②	350	1977-82	18-3554	18-3653
155	1969-72	18-3554	18-3653	350	1989	18-3554	—
165	1972-76	18-3554	18-3653	351	1992	18-3554	—
170	1974	18-3554	18-3653	454	1977-82	18-3554	18-3653
175	1975-77	18-3554	18-3653	460	1989	18-3554	—
185	1978-80	18-3554	18-3653	2.5L	1982-88	18-3558	18-3670
190	1974-77	18-3554	18-3653	3.0L	1982-88	18-3558	18-3670
200	1979-81	18-3554	18-3653	3.8L	1981-85	18-3554	18-3653
210	1969-72	18-3554	18-3653	4.3L	1985-86	18-3554	18-3653
215	1971	18-3554	18-3653	4.3L	1989-92	18-3554	—
225	1971	18-3554	18-3653	5.0L	1982-88	18-3554	18-3653
230	1979-81	18-3554	18-3653	5.0L	1989-92	18-3554	—
235	1971	18-3554	18-3653	5.7L	1982-88	18-3554	18-3653
235	1975-77	18-3554	18-3653	5.7L	1989	18-3554	—
240	1978	18-3554	18-3653	5.8L	1989-92	18-3554	—
245	1972-75	18-3554	18-3653	7.5L	1988	18-3554	18-3653

① 1980 Models with "C" suffix only

② 1980 Models with "C1" suffix only

SINGLE DIAMETER HOSE



**18-70021
MOLDED HOSE**
3/4" ID



**18-70704
MOLDED HOSE**
1 1/4" ID



**18-70924
MOLDED HOSE**
1 3/4" ID



**18-71218
MOLDED HOSE**
1" ID

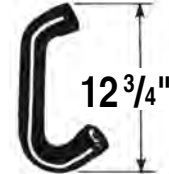

**18-71337
MOLDED HOSE**
1 3/4" ID

STRAIGHT HOSE



**18-75100
MOLDED HOSE**
Straight 48"
1" ID



**18-75125
MOLDED HOSE**
Straight 48"
1 1/4" ID

① Items ending in "D" are Display Packaged - Regular number is Non-Display

V-BELTS

- 1** High strength synthetic cords resist shockload failure. Their low stretch properties assure uniform performance over the life of the belt.
- 2** The compression section is a special rubber compound that assures smooth and even transfer of load forces to the cords.
- 3** Cogs are molded to precise engineering tolerances to improve flexibility and maintain cord support. Cog geometry provides a large area for air circulation to keep the belt cool and prevent damaging heat build up in the cushion section.
- 4** Rubber edges maintain positive, no-slip contact with pulley grooves for reliable energy transfer.



BELT SIZE LISTING BY NUMBER

Part #	Effective Length (Inches)	Top Width (Inches)	Part #	Effective Length (Inches)	Top Width (Inches)	Part #	Effective Length (Inches)	Top Width (Inches)
18-15290	29	29/64	18-15405	40 1/2	29/64	18-15460	46	29/64
18-15300	30	29/64	18-15410	41	29/64	18-15470	47	29/64
18-15325	32 1/2	29/64	18-15415	41 1/2	29/64	18-15480	48	29/64
18-15345	34 1/2	29/64	18-15430	43	29/64	18-15495	49 1/2	29/64
18-15370	37	29/64	18-15435	43 1/2	29/64	18-15500	50	29/64
18-15380	38	29/64	18-15440	44	29/64	18-15520	52	29/64
18-15390	39	29/64	18-15450	45	29/64	18-15550	55	29/64
18-15400	40	29/64	18-15455	45 1/2	29/64			

V-BELT INTERCHANGE

OMC #	Part #	Part #	OMC #
310953	18-15460	18-15380	910414
311046	18-15440	18-15400	311606
311606	18-15400	18-15415	910343
908929	18-15455	18-15435	912509
909818	18-15500	18-15440	311046
909971	18-15460	18-15450	914787
910343	18-15415	18-15455	908929
910414	18-15380	18-15460	310953
912418	18-15500	18-15460	909971
912509	18-15435	18-15500	909818
912714	18-15520	18-15500	912418
914787	18-15450	18-15520	912714

HOSE INTERCHANGE

Sierra #	Part #	Sierra #	Part #
18-71337	312781	18-75100	913488
18-75100	910305	18-75125	912793
18-75100	912424		

V-BELT APPLICATION

Model	Year	Water Alternator	Pump	Power Steering	Model	Year	Water Alternator	Pump	Power Steering
100	1972-73	18-15400	18-15400	—	262 KING COBRA	1989	—	*18-15380	18-15455
110	ALL	18-15440	18-15440	—	305	1977-84	18-15440	18-15440/ *18-15455 or *18-15500	—
120	1965-81	18-15400	18-15400	—					
140	1982-87	18-15400	18-15400	—					
165	1972-76	18-15400	18-15400	—	350	1977-84	18-15440	18-15440/ *18-15455 or *18-15500	—
170	1974	18-15400	18-15400	—					
175	1975-77	18-15400	18-15400	—					
185 W/O PS	1978-84	18-15440	18-15440	—	350 KING COBRA	1988-90	18-15455	18-15455	—
185 W/ PS	1978-84	18-15460	18-15460	18-15460	350 KING COBRA	1988-90	18-15470	*18-15380	18-15455
190	1974-77	18-15400	18-15400	—	454	1977-82	18-15455	18-15455/ *18-15500	—
200 W/O PS	1979-81	18-15440	18-15440	—					
200 W/ PS	1979-81	18-15460	18-15460	18-15460	454 KING COBRA	—	—	18-15470	18-15380
210	1970-71	18-15440	18-15440	—	460 KING COBRA	1988	18-15460	18-15460	18-15520
215	1971	18-15440	18-15440	—	888	—	18-15435	18-15435	—
225	1972-84	18-15440	18-15440	—	2.3L	1987-90	18-15435	18-15435	18-15435
230,260	1975	18-15440	18-15440/ *18-15455	—	2.5L W/O PS	1982-87	18-15415	18-15415	—
					2.5L W/ PS	1982-87	18-15400	18-15400	18-15460
230,260	1979-81	18-15440	18-15440	—	3.8L W/O PS	1982-90	18-15400	18-15400	—
230,260	1979-81	18-15460	18-15460	18-15460	3.8L W/ PS	1982-90	—	*18-15380	18-15455
235	1971	18-15440	18-15440	—	5.0L W/O PS	1982-90	18-15455	18-15455	—
235	1975-77	18-15400	18-15400	—	5.0L W/ PS	1982-90	—	*18-15380	18-15455
240	1978-84	18-15400	18-15400	—	5.0L	1988	18-15400	18-15400	18-15450
250	1979	18-15400	18-15400	—	7.5L	1987	18-15460	18-15460	18-15520
262 KING COBRA	1989	18-15400	18-15400	—					

* W/ SEA WATER PUMP

Fits GM 181 CID 3.0L, 4 Cylinder Fits Most 141 Models

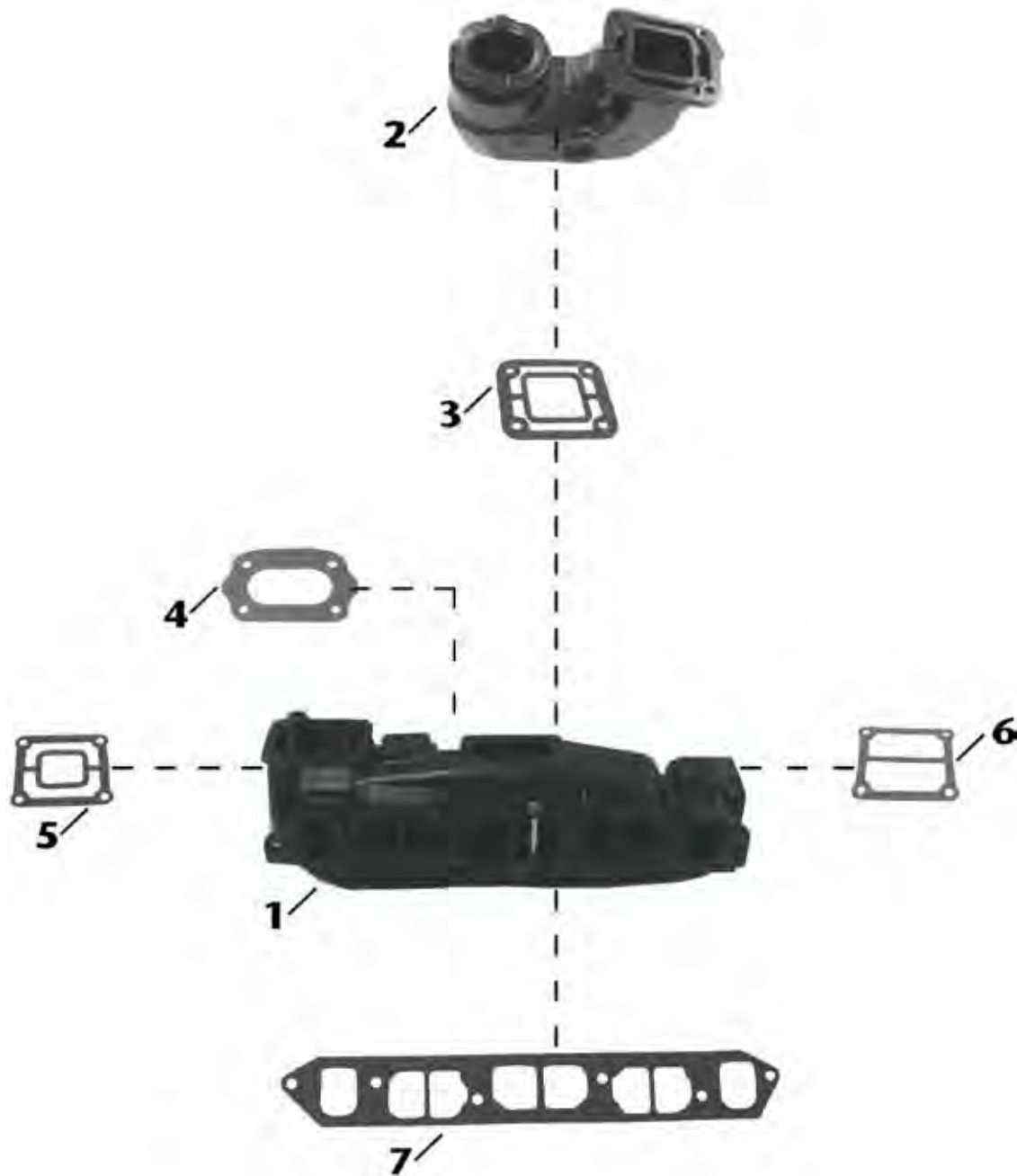

Item No	Description	OE No.	Application
1	18-1901 MANIFOLD	982490, 980083, 984054	GM 181 cu.in. 3.0L , 4 Cylinder. Fits most 140 models.
2	18-1922 MANIFOLD ELBOW	987784	Use with Manifold: 18-1901; Elbow Gasket: 18-2875-1
3	18-2875-1 ELBOW GASKET	3850495	Use with Elbow: 18-1922
4	18-0937 CARBURETOR GASKET	315055	Use with Manifold: 18-1901
5	18-2861-1 END PLATE GASKET	311121	Use with Manifold: 18-1901
6	18-0114-1 END PLATE GASKET	907761	Use with Manifold: 18-1901
7	18-1204-1 MANIFOLD GASKET	912164	Use with Manifold: 18-1901

Fits GM Small Block V8 305-350 cu. in. 1979-1989

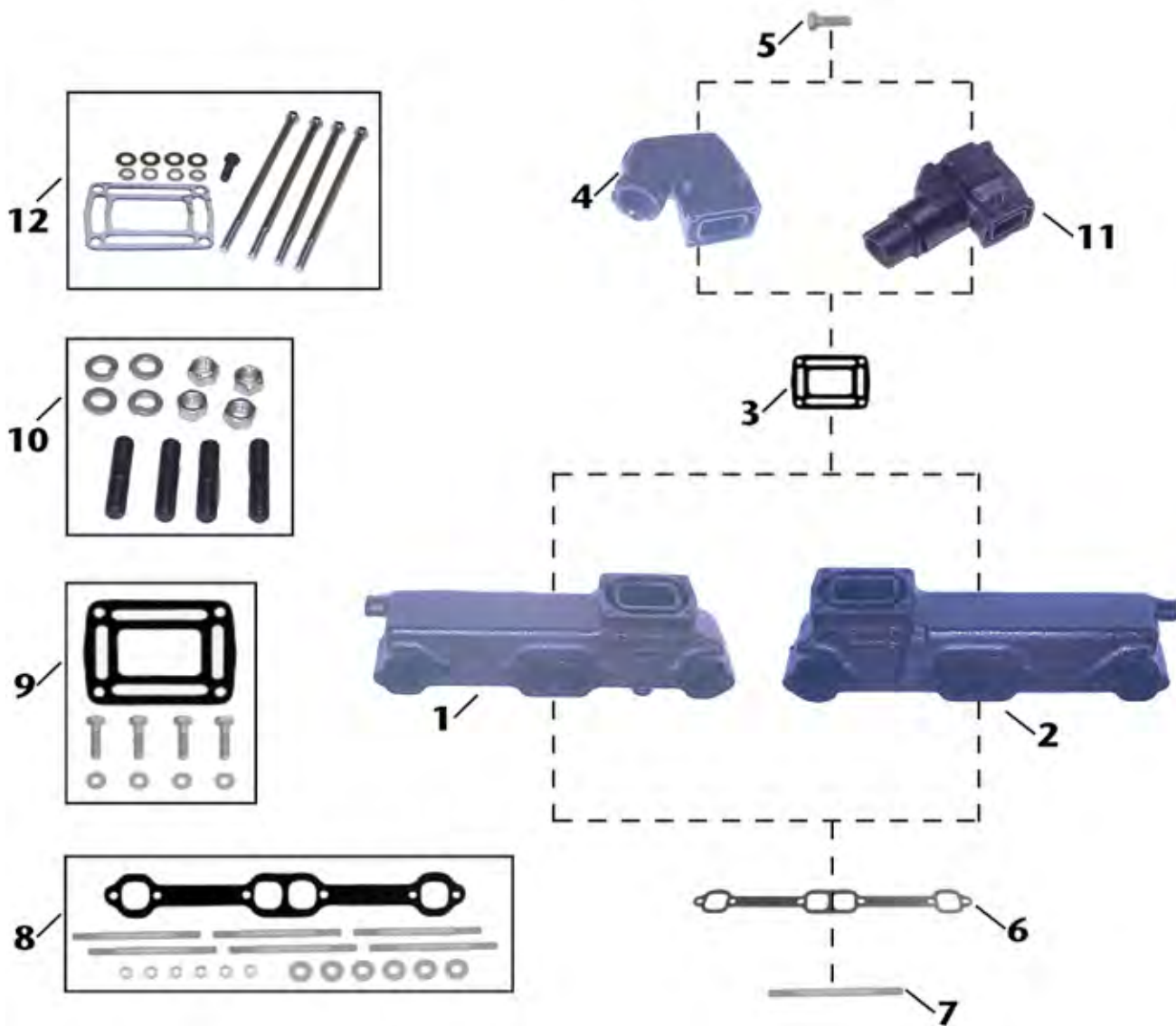

Item No	Description	OE No.	Application	
1	18-1902	MANIFOLD (STARBOARD)	912441	GM Small Block (V8) 305-350 cu.in. (1979-1989)(Starboard) Use with Manifold Gasket: 18-2949. Mounting Kit: 18-8502
2	18-1903	MANIFOLD (PORT)	912442	GM Small Block (V8) 305-350 cu.in. (1979-1989)(Port). Use with Manifold Gasket: 18-2949. Mounting Kit: 18-8502
3	—	ELBOW GASKET	909786	Use with Elbow: 18-1921; Mounting Kit: 18-8534.
4	18-1921	MANIFOLD ELBOW	909863	Use with Manifold: 18-1902, 18-1903. Mounting Kit: 18-8534.
5	NSS	MOUNTING BOLT	N/A	Included in 18-8534 mounting kit.
6	18-2949	MANIFOLD GASKET	96306	Use with Manifold: 18-1902, 18-1903. Included in 18-8502 mounting kit.
7	NSS	MOUNTING STUD	N/A	Included in 18-8502 mounting kit.
8	18-8502	MOUNTING KIT	N/A	Use with Manifold: 18-1902, 18-1903. Includes 18-2949 manifold gasket.
9	18-8534	MOUNTING KIT	N/A	Use with Elbow: 18-1921.
10	18-8553	HARDWARE KIT	N/A	Hardware only for Elbow 18-1921.
11	18-1909-1	MANIFOLD ELBOW	N/A	Use with Elbow Gasket: 18-0943-2
12	18-8507	MOUNTING KIT	N/A	Use with Manifold Elbow: 18-1909-1

Fits GM Small Block V8 305-350 cu. in.



Item No	Description	OE No.	Application
1	18-1986-1 MANIFOLD	3857723	GM Small Block (V8) 305-350 cu.in. Use with Manifold Gasket: 18-2949; Mounting Kit: 18-8502.
2	— ELBOW GASKET	909786	Use with Elbow: 18-1909-1. Included in 18-8507 mounting kit.
3	18-1909-1 MANIFOLD ELBOW	913784, 3855270, 3850459, 3857944	Use with Manifold: 18-1986-1; Mounting Kit: 18-8507.
4	NSS MOUNTING BOLT	N/A	Included in 18-8507 mounting kit.
5	18-8216 HOSE FITTING	N/A	3/4" - 14NPT X 1" Hose (Corrosion Resistant Brass Fitting)
6	18-4461 HOSE FITTING	N/A	3/4" - 14NPT X 1" Hose (Corrosion Resistant Brass Fitting)
7	18-8215 HOSE FITTING	N/A	3/4" - 14NPT X 3/4" Hose (Corrosion Resistant Brass Fitting)
8	18-2949 MANIFOLD GASKET	96306	Use with Manifold: 18-1986-1. Included in 18-8502
9	NSS MOUNTING STUD	N/A	Included in 18-8502 mounting kit.
10	18-8502 MOUNTING KIT	N/A	Use with Manifold 18-1986-1. Includes 18-2949 manifold gasket.
11	18-8507 MOUNTING KIT	N/A	Use with Elbow: 18-1909-1. Includes 18-0943-2 elbow gasket.

SIERRA MANIFOLDS ARE PAINTED, PACKAGED AND LEAK TESTED



**18-1901
MANIFOLD**
Replaces: 984054
Fits 181 CID model 140
and 3.0L (1973 - 1989)
Use with: Exhaust Manifold Gasket **18-1204-1** &
Elbow Gasket **18-2875-1**
***For Exploded View - See PAGE 894**



**18-1898
MANIFOLD**
Port & Starboard
Replaces: Barr CHVA-1-84, Marine Power 0991-110
Fits 454 cu.in. GM big block V8 engines
Use with:
Exhaust Manifold Gasket: 18-0418
***For Exploded View - See Pages 636-637**



**18-1997-1
EXHAUST MANIFOLD**
Port & Starboard
Replaces Barr CHV-1-83 Universal Center Riser Manifold
FITS: GM 283, 305, 307 and 350 CID engines
Use with:
Exhaust Manifold Gasket Set: 18-0604
***For Exploded View - See Pages 638-639**



**18-1998-1
EXHAUST MANIFOLD**
Port & Starboard
Replaces: Barr FM-1-83
Universal Center Riser Manifold
FITS: Ford 302 and 351 CID engines
Use with:
Exhaust Manifold Gasket Set: 18-0603
***For Exploded View - See Pages 640-641**



**18-1986-1
MANIFOLD**
Port & Starboard
Replaces: 3852374, 3857723
For: GM Small Block V8 305-350 ci
Use with:
Exhaust Manifold Gasket: 18-2949
Mounting Kit: 18-8502



**18-1902
MANIFOLD**
Replaces: 912441
V-8 - STARBOARD SIDE
Fits most GM V-8 small blocks with end riser
Use with:
Mounting Kit: 18-8502



**18-1903
MANIFOLD**
Replaces: 912442 V-8 - PORT SIDE
Fits most GM V-8 small blocks with end riser
Use with:
Mounting Kit: 18-8502



**18-1904
MANIFOLD**
Port & Starboard
Replaces: 980959, 980572 V-8 - EITHER SIDE
Fits most Ford V-8 302 & 351W with end riser
Use with:
Exhaust Manifold Gasket: 18-0183-1 or 18-2896-1
(See Application Chart)



**18-1848
MANIFOLD**
Replaces: 3852338, 3857656, 914899
Fits: 4.3L V-6



**18-1991
30° EXHAUST ELBOW ADAPTER**
Replaces: Barr 200089P
For use with 3" I.D.
Exhaust Hose
Use with:
Manifold Riser: 18-1999



**18-1992-1
80° EXHAUST ELBOW**
Replaces: Barr 200087P
For 3" I.D. Exhaust Hose (As used in 18-1987
Exhaust Manifold Conversion Kit)



**18-1921
ELBOW MANIFOLD**
Replaces: 909863
V-8
Fits most GM V-8 small blocks
Use with:
Manifold: 18-1902, 18-1903
Elbow Gasket: 18-0943-2
Mounting Kit: 18-8534



**18-1922
ELBOW MANIFOLD**
Replaces: 987784, 916096, 0740120,
3850799, 910380
4 CYL.
Fits most 140 HP 3.0L (181 CID)
Use with:
Manifold: 18-1901
Elbow Gasket: 18-2875-1



**18-1909-1
RISER**
Replaces:
OMC 913784, 3855270, 3850456,
3857944
VOLVO 3855270-9, 3857944-7,
3863061, 3856444
OMC Riser, 4" outlet 7°: Fits many GM
& Ford center rise manifolds.
Use with:
Manifold: 18-1986-1
Riser Gasket: 18-0943-2
Mounting Kit: 18-8507



**18-1939
RISER**
Replaces: Barr 20-0100, Marine Power 0992-593 Barr, Indmar
and Marine Power Ford Small Block V8 302-351cu.in., GM Small
Block V8 305-350cu.in., GM Big Block V8 454cu.in.
Use with:
Manifold: 18-1997-1, 18-1998-1
Riser Gasket: 18-2854-1 open or 18-0476-1 blocked
Mounting Kit: 18-4364 open or 18-8535 blocked
4" hose



**18-1907
RISER**
Replaces: Barr 20-0102, Indmar 53-2009,
53-2018, Barr and Indmar Ford Small Block
V8 302-351cu.in.
Use with:
Manifold: 18-1997-1, 18-1998-1
Riser Gasket: 18-2854-1 open or
18-0476-1 blocked
Mounting Kit: 18-4364 open or 18-8535
blocked
3" hose



**18-1999
EXHAUST
MANIFOLD
RISER**
Replaces: Barr 20-0082
Use with:
Manifold: 18-1997-1 or 18-1998-1
Riser Gasket: 18-2854-1 open
3 1/2" hose
Comes with 18-4364 open
If blocked mounting kit is required use 18-8535
Replaces: Barr 20-0082-P



**18-4009
MANIFOLD END PLATE**
Replaces: 910384



PIPE PLUGS

Part #	Thread Size
18-4256	1/4"
18-4257	1/4"
18-4258	3/4"
18-4263	1/8" - 27 NPT
18-4264	3/8" - 18 NPT

56507 Pipe Sealant with Teflon® is recommended for use on plug threads.



**18-4461
HOSE BARB**
3/4" - 14 NPT X 1" Hose
Corrosion Resistant Brass Fitting



**18-8216
HOSE BARB**
3/4" - 14 NPT X 1" hose barb
Fits: OMC- In-Line 6 Cylinders

① **18-4218D**



**18-4218
BRASS DRAIN COCK**
Replaces: 379957
1/4"
18-3223-9 Bulk Pack of 12

① Items ending in "D" are Display Packaged - Regular number is Non-Display



18-4363
MOUNTING PACKAGE
 Replaces: Barr FM-1-83-P
 Use with:
 Manifold: 18-1998-1



18-4364 (Open)
MOUNTING PACKAGE
 Replaces: Barr 20-0082-P
 Use with:
 Riser: 18-1999, 18-1939, 18-1907



18-8502
MOUNTING KIT
 OMC GM Small Block V8 305-350cu.in.
 (1979-89) OMC/Volvo GM Small Block
 305-350cu.in.
 Used with:
 Manifolds: 18-1931-1, 18-1902 & 18-1903



18-8507
MOUNTING KIT
 Replaces: Barr CM-20-6674JP
 OMC/Volvo GM
 Small Block V8 305-350cu.in.
 Used with:
 Riser: 18-1909-1



18-8534
MOUNTING KIT
 OMC GM Small Block V8 305-350cu.in.
 (1979-1989) and multiple application Ford
 and GM Risers
 Used with:
 Riser: 18-1921



18-8535 (Blocked)
MOUNTING KIT
 Barr, Indmar and Marine Power Ford Small
 Block V8 302-351cu.in., GM Small Block V8
 305-350cu.in., GM Big Block V8 454cu.in.
 Used with:
 Risers: 18-1939, 18-1999, and 18-1907



18-8536
MOUNTING KIT
 Barr, Indmar and Marine Power GM
 Small Block V8 305-350cu.in.
 Used with:
 Manifold: 18-1997-1



18-8538
MOUNTING KIT
 Barr and Indmar Ford Small
 Block V8 302-351cu.in.
 Used with:
 Manifold: 18-1998-1, 18-1904



18-8553
MOUNTING KIT
 Used with:
 Exhaust Elbow: 18-1921



18-2779
EXHAUST HOSE
 Replaces: 3852696



18-2781
EXHAUST HOSE
 Replaces: 3852742



18-0114-1
MANIFOLD END GASKET
 Replaces: 907761











18-0183-1
EXHAUST MANIFOLD GASKET
 Replaces: 908717, 916262,
 3852455, 3853742
 Use with:
 Manifold: 18-1958, 18-1962, 18-1904,
 18-1998-1, 18-1996, 18-1979



18-0476-1 (Blocked)
RISER GASKET
 Replaces: Barr 01-0105
 Indmar & Marine Power
 Ford Small Block V8 302-351cu.in.
 Used with:
 Risers: 18-1939, 18-1999 and 18-1907



PKG. OF 2
18-0943-2
18-0943-2-9Ⓢ
EXHAUST ELBOW GASKET
 Replaces: 909786, 3850496
 Used with:
 Riser: 18-1909-1

<p>PKG. OF 2</p>  <p>18-2850-1 18-2850-9① EXHAUST ELBOW GASKET Replaces: 908935</p>	<p>PKG. OF 2</p>  <p>18-2854-1 18-2854-9① EXHAUST RISER GASKET Replaces: Barr 01-0107 Use with: Mounting Kit: 18-8535 Risers: 18-1999, 18-1939, 18-1907</p>	<p>PKG. OF 2</p>  <p>18-2861-1 18-2861-9① EXHAUST ELBOW GASKET Replaces: 311121</p>
<p>PKG. OF 2</p>  <p>18-2875-1 18-2875-1-9① EXHAUST ELBOW GASKET Replaces: 3850495, 908013 Used with: Elbow: 18-1922</p>	 <p>18-2896-1 MANIFOLD GASKET Replaces: 311068 For GM 4 cyl. 153 cu.in. Early models 110/120 where the carb. linkage mounts to the rear of the engine Use with: Manifold: 18-1904</p>	
<p>PKG. OF 2</p>  <p>18-2902-1 18-2902-1-9① MANIFOLD GASKET Replaces: 909314 Use with: Manifold: 18-1997-1, 18-1986-1, 18-1902, 18-1903</p>	<p>PKG. OF 2</p>  <p>18-2949 18-2949-9① MANIFOLD GASKET Replaces: Barr CHV-47-000 Use with: Manifold: 18-1997-1</p>	
 <p>18-0603 EXHAUST MANIFOLD GASKET SET For: Ford 302/351 CID Eng. Use with: Manifold: 18-1998-1</p>	 <p>18-0604 EXHAUST MANIFOLD GASKET SET For: GM 305/350 CID Eng. Use with: Manifold: 18-1997-1</p>	

① Priced per Package

MANIFOLD/MANIFOLD GASKET APPLICATION

Year	Horsepower	Exhaust Manifold	Exhaust Elbow	Manifold Mount Kit	Elbow Mount Kit	Manifold Gasket	Elbow Gasket
1997-98	5.0/5.7L	18-1986-1	18-1909-1	18-8502	18-8507	18-2902-1	18-0943-2
1994-97	5.8L (Ford)	—	—	—	—	18-0183-1	18-0943-2
1994-97	7.4L (GM)	—	—	—	—	18-0418	18-0943-2
1991-93	3.0 Liter	—	18-1922	—	—	—	18-2875-1
1992-93	4.3/4.3 HO	—	18-1909-1	—	18-8507	—	18-0943-2
1993	5.0/5.0 HO/5.8 Liter	—	18-1909-1	—	18-8507	18-0183-1	18-0943-2
1993	5.0 & 5.8 EFI	—	18-1909-1	—	18-8507	18-0183-1 ②	18-0943-2
1993	5.0 & 5.8 EFI	—	18-1909-1	—	18-8507	—	18-0943-2
1993	5.8L (Ford)	—	18-1909-1	—	18-8507	18-0183-1	18-0943-2
1993	7.4L (GM), 8.2L (GM)	—	18-1909-1	—	18-8507	18-0418	18-0943-2
1993	351 King, 454/454 HO/502	—	—	—	—	—	18-0943-2
1992	5.0/5.0 HO/5.8 Liter	—	18-1909-1	—	18-8507	18-0183-1	18-0943-2
1992	5.8L (Ford)	—	—	—	—	18-0183-1	18-0943-2
1992	7.4L (GM), 8.2L (GM)	—	—	—	—	18-0418	18-0943-2
1992	351 King Cobra	—	—	—	—	18-0183-1	18-0943-2
1992	454/454 HO/502	—	—	—	—	—	18-0943-2
1991	4.3/4.3 HO	—	—	—	—	—	18-0943-2
1991	5.8L (Ford), 5.0/5.0 HO/5.8 Liter	—	18-1909-1	—	18-8507	18-0183-1	18-0943-2

② 5.0L only

APPLICATION CONTINUED ON NEXT PAGE

MANIFOLD/MANIFOLD GASKET APPLICATION

Year	Horsepower	Exhaust Manifold	Exhaust Elbow	Manifold Mount Kit	Elbow Mount Kit	Manifold Gasket	Elbow Gasket
1991	454/454 HO	—	18-1909-1	—	18-8507	—	18-0943-2
1991	7.4L (GM)	—	18-1909-1	—	18-8507	18-0418	18-0943-2
1990-91	8.2L (GM)	—	18-1909-1	—	18-8507	—	—
1982-83,1985-90	3.0 Liter	18-1901	18-1922	—	—	—	18-2875-1
1990	4.3 Liter	—	18-1909-1	—	18-8507	—	—
1990	5.0/5.0 HO/5.8 Liter	—	18-1921	—	—	18-0183-1	18-0943-2
1990	5.0/5.7L	18-1986-1	18-1909-1	18-8502	18-8507	18-2902-1	18-0943-2
1990	7.4L (GM)	—	—	—	—	18-0418	18-0943-2
1990	7.5L (Ford)	—	—	—	—	18-0992	18-0943-2
1990	454 King Cobra	—	—	—	—	—	18-0943-2
1987-90	460 King Cobra	—	—	—	—	—	18-0943-2
1989	5.0/5.0 HO/5.8 Liter	—	18-1921	—	18-8534	18-0183-1	18-0943-2
1989	5.7/350 King Cobra	—	—	—	—	18-2902-1	18-0943-2
1988	5.0/5.7/350 King Cobra	18-1902 #	18-1921	18-8502	18-8534	18-2902-1	18-0943-2
1988	5.0/5.7/350 King Cobra	18-1903 *	18-1921	18-8502	18-8534	18-2902-1	18-0943-2
1988	370 King Cobra	—	—	—	—	—	18-0943-2
1982-87	5.0/5.7 Liter	18-1902 #	18-1921 ①	18-8502	18-8534	18-2902-1	18-0943-2
1982-87	5.0/5.7 Liter	18-1903 *	18-1921	18-8502	18-8534	18-2902-1	18-0943-2
1982-86	2.5 Liter	18-1901	18-1922	—	—	18-2896-1	18-2875-1
1984	3.0 Liter	18-1901	18-1921	—	18-8534	—	18-2875-1
1978-81	400 Series, 120 HP	—	—	—	—	18-2896-1	18-2861-1
1978-81	400 Series, 140 HP	—	18-1922	—	—	—	18-2875-1
1981	800 Series, 200,230,260 HP	18-1902 #	18-1921	18-8502	18-8534	18-2902-1	18-0943-2
1981	800 Series, 200,230,260 HP	18-1903 *	18-1921	18-8502	18-8534	18-2902-1	18-0943-2
1980	800 Series, 185-260 HP	18-1902 #	18-1921	18-8502	18-8534	18-2902-1	18-0943-2
1980	800 Series, 185-260 HP	18-1903 *	18-1921	18-8502	18-8534	18-2902-1	18-0943-2
1979	800 Series,185-230 HP	18-1902 #	18-1921	18-8502	18-8534	18-2902-1	18-0943-2
1979	800 Series,185-230 HP	18-1903 *	18-1921	18-8502	18-8534	18-2902-1	18-0943-2
1979	800 Series, 260 HP	18-1902 #	18-1921	18-8502	18-8534	18-2902-1	18-0943-2
1979	800 Series, 260 HP	18-1903 *	18-1921	18-8502	18-8534	18-2902-1	18-0943-2
1978	800 Series, 185-225 HP	18-1902 #	18-1921	18-8502	18-8534	18-2902-1	18-0943-2
1978	800 Series, 185-225 HP	18-1903 *	18-1921	18-8502	18-8534	18-2902-1	18-0943-2
1978	800 Series, 240 HP	—	18-1921	—	18-8534	—	—
1977	120 HP	—	—	—	—	18-2896-1	18-0943-2
1977	140 HP	—	18-1922	—	—	—	18-2861-1
1977	175 THRU 235 HP	—	18-1921	—	18-8534	18-0183-1	18-2875-1
1976	120 HP	18-1904	—	—	—	18-0183-1	18-0943-2
1974-76	140 HP	18-1904	18-1922	—	—	—	18-2861-1
1976	165 HP	18-1904	18-1922	—	—	18-2830-1	18-2875-1
1976	175 THRU 235 HP	18-1904	—	—	—	18-0183-1	18-2875-1
1974-75	120 HP	18-1904	—	—	—	18-2896-1	18-2850-1
1974-75	165 HP	18-1904	18-1922	—	—	—	18-2875-1
1975	175 THRU 235 HP	18-1904	—	—	—	18-0183-1	18-2875-1
1974	170 & 190 HP	18-1904	—	—	—	18-0183-1	18-2875-1
1974	175 THRU 235 HP	18-1904	—	—	—	18-0183-1	18-2850-1
1973	100,120,140 HP	—	—	—	—	18-2896-1	18-2861-1
1973	165 HP	—	18-1922	—	—	18-2896-1	18-2861-1
1972-73	225 & 245 HP	—	—	—	—	—	18-2883
1972	100,120 HP	—	—	—	—	18-2896-1	18-2861-1
1972	155 HP	—	—	—	—	N/A	18-2883
1972	165 HP S MODEL, C MODEL	—	—	—	—	—	18-2875-1
1971	215 & 235 HP	—	—	—	—	—	18-2859
1965-71	120 HP	—	—	—	—	—	18-2861-1
1967-71	155 HP	—	—	—	—	N/A	18-2859
1968-70	210 HP	—	—	—	—	—	18-2859
1967-68	185 HP	—	—	—	—	—	18-2859
1966-68	200 HP	—	—	—	—	N/A	18-2859
1964-66	150 HP	—	—	—	—	N/A	18-2859
1964	110 HP	—	—	—	—	N/A	18-2859

Starboard

* Port

① High rise applications only for 1985

② 5.0L only

OIL FILTERS



Display Package

Part #	Fits:	O.E.M #
18-7824-2	GM Engines (Short Filter)	173232, 502902
18-7875	Ford Engines (Long Filter)	173231, 502900
18-7876-1	GM Engines (Long Filter)	173233, 502901
18-7878-1	M-100, M200 (Short Filter)	502904
18-7879-1	GM V-6 Engines	173834, 502903

SEE PAGES 182-184 & 1147-1170 FOR ADDITIONAL INFORMATION

CYLINDER HEAD ASSEMBLIES



18-4485
CYLINDER HEAD ASSEMBLY

Fits: 5.7L V-8 GM (1987-95) with press in rocker arm studs with 12 intake manifold mounting bolts- (4 inside intake manifold bolts at 23 degrees), center mount valve covers



18-4486
CYLINDER HEAD ASSEMBLY

Fits: 5.7L V-8 GM Vortec (1996-Up) with press in rocker arm studs with 8 intake manifold mounting bolts, composite valve cover



18-4486HP
CYLINDER HEAD ASSEMBLY

Fits: Vortec GM small block 5.7L high performance
Completely assembled with revised runner and combustion chambers. Add 30hp to stock motor with no additional modifications.



18-4489
CYLINDER HEAD ASSEMBLY

Fits: 2.5L/3.0L GM (1968-95)



18-4491
CYLINDER HEAD ASSEMBLY

Replaces 4.3L Vortec V-6 (1996-Up) with screw in rocker arm studs (non-adjustable valve train), 8 intake manifold mounting bolts, center mount valve cover. NOTE: not for use with engines using factory roller rocker arms.



18-4501
CYLINDER HEAD

Fits: 5.0L Vortec



18-4501HP
CYLINDER HEAD

Fits: Vortec GM small block 5.0L
Completely assembled with revised runner and combustion chambers. Add 30hp to stock motor with no additional modifications.





18-1400
HYDRAULIC LIFTER
 Replaces: 3856127
 GM 4.3L/V-6 Late/5.0L/5.7L



18-1401
HYDRAULIC LIFTER
 Replaces: 3853847, 985316
 Ford 5.0L & 5.8L



18-1402
HYDRAULIC LIFTER
 Replaces: 3854033, 502036
 GM 2.5L/120
 For: OMC & Volvo 3.0L/181 CID

**ALL PISTONS
 ARE SUPPLIED COMPLETE WITH PISTON RINGS AND WRIST PIN.**



RINGS

Std.	REPLACES OMC/VOLVO
18-3937	*14089025
18-3937	328506
18-3937	3853960
18-3937	914555
18-3937	3853268
18-3937	985083, 986336
18-3944	370409
0.02	
18-3939	3854252
18-3939	914556
0.03	
18-3938	*14089026

RINGS (Cont.)

Std.	REPLACES OMC/VOLVO
18-3938	328516
18-3938	914557
PISTONS	
18-4161	3853340, 914816
18-4173	*14077948
18-4173	3911020
0.02	
18-4160	3853477, 915236
0.03	
18-4164	*14077949, 3911023
* OMC References GM Number	

PISTON / RING APPLICATION

Model	PISTONS			RINGS			Qty. per Eng.
	Std.	.020	.030	Std.	.020	.030	
OMC							
GM							
2.5L/153 CID	18-4180	18-4183	-	18-3942	-	-	4
3.0L/181 CID	18-4161	18-4160	18-4191	18-3937	18-3939	18-3938	4
I-6/250 CID	-	-	-	18-3942	-	-	6
4.3L/V-6	18-4173	18-4188	18-4164	18-3937	18-3939	18-3938	6
5.0L/305 CID	-	-	18-4178	18-3944	-	-	8
5.7L/350 CID	18-4173	18-4188	18-4164	18-3937	18-3939	18-3938	8
7.4L/454 CID	18-4171	18-4189	18-4172	18-3940	-	-	8
FORD							
5.0L/302 CID	-	-	-	18-3937	18-3939	18-3938	8



ROD BEARINGS

Part #	Size
18-1308	Std.
18-1309	.010
18-1327	Std.
18-1329	Std.
18-1333	.010
18-1334	Std.
18-1337	.010
18-1341	.020
Rod bearings sold individually, 1 per rod	



MAIN BEARINGS

Part #	Per Eng.	Size
18-1300	②	Std.
18-1311	②	Std.
18-1316	②	.010
18-1317	②	Std.

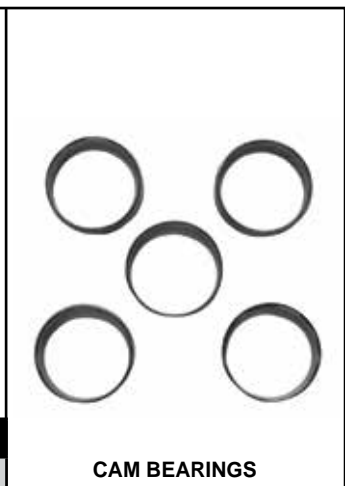

CAM BEARINGS

Part #	Per Eng.
18-1339	1 ②
② Complete engine set	

BEARING APPLICATION

Model	ROD BEARING			MAIN BEARING			CAM BEARING
	Std.	.010	.020	Std.	.010	.020	
OMC							
GM							
2.5L/153 CID	18-1329	18-1330	-	18-1317	18-1316	-	18-1339
3.0L/181 CID	18-1308	18-1309	18-1341	18-1317	18-1316	-	18-1339
I-6/230 CID	18-1329	18-1330	-	-	-	-	-
I-6/250 CID	18-1308	18-1309	18-1341	-	-	-	-
4.3L/V-6	18-1327	18-1337	-	18-1311	-	-	-
5.0L/305 CID	18-1308	18-1309	18-1341	18-1300	-	-	-
5.7L/350 CID	18-1308	18-1309	18-1341	18-1300	-	-	-
7.4L/454 CID	18-1334	18-1333	18-1332	-	-	-	-
FORD							
5.0L/302 CID	—	-	-	-	-	-	-



One Piece Rear Main Seals

18-1234
Replaces: 3853528

18-0519
Replaces: 3852657, 912957



Two Piece Rear Main Seals

18-0528
Replaces: 913745

18-1211
Replaces: 473424



Timing Cover Seals

18-1213
Replaces: 3853341, 912989, 914817

18-1230
Replaces: 3853827, 984884

18-1233
Replaces: 3860095

OMC SEAL APPLICATION

Engine Model	2 Piece Rear Main Crankshaft Seal Conv. Rotation (LH)	Timing Cover Seal
GM		
2.5L/153 CID	18-1211 ②	18-1213
3.0L/181 CID	18-1211 ②	18-1213
I-6/230CID	18-1211 ②	18-1213
I-6/250CID	18-1211 ②	18-1213
4.3L/V-6	18-1211 ②	18-1213
5.0L/305 CID	18-1211 ①	18-1213
5.7L/350 CID	18-1211 ①	18-1213
7.4L/454 CID	③	18-1233
FORD		
5.0L/302 CID	18-0528	
5.8L/351 CID	—	18-1230

① Large Journal Crankshaft GM Engines ② For One Piece Seal (LH) Models Use 18-0519 ③ For One Piece Seal (LH) Models Use 18-1234

MISCELLANEOUS GASKETS/GASKET SETS



18-0465
INTAKE MANIFOLD GASKET SET
 Replaces: 352670
 For: GM 454 CID Engines, 325, 330, 340, 350 HP
 and 454 Magnums, 7.4L

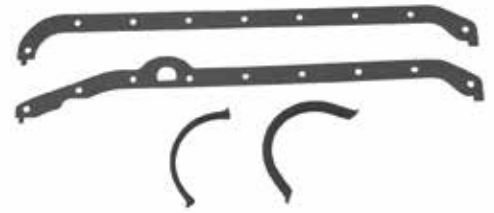

18-0153
OIL PAN GASKET SET
 Replaces:
 393159, 458625, 357159
 For: OMC 5.7L



18-1239
OIL PAN GASKET
 Replaces: 914820
 For: OMC 3.0L



18-0348
OIL PAN GASKET SET
 Replaces: 3931593, 508871



18-1237
OIL PAN GASKET
 Replaces: 3856138
 For: GM 5.7L



18-0466
OIL PAN GASKET SET
 Replaces: 393061, 3923440, 3921473



18-1238
INTAKE GASKET SET
 Replaces: 3850379, 912979
 For: OMC 4.3L 1993-96



18-1231
INTAKE GASKET
 Replaces: 3854095



18-0405
OIL PAN GASKET
 Replaces:
 3852655, 912955
 For: OMC 4.3L



18-0407
OIL PAN GASKET SET
 Replaces: 508872



18-0410
INTAKE MANIFOLD GASKET SET
 Replaces:
 988162, 3854406, 986103,
 3853912, 986104, 3853913
 For: OMC 5.0L & 5.8L (1989-96)



18-0411
OIL PAN GASKET SET
 Replaces:
 458625, 357159, 508876



18-1232
OIL PAN GASKET
 Replaces: 3853510



18-0868
INTAKE MANIFOLD GASKET SET
 Replaces:
 985630, 3854269
 For: OMC 5.7L 1994, 1996-97



Display Package

**18-2613
OUTDRIVE GASKET SET**
Replaces: 508105

— CONTAINS —

Part #	Description	O.E. #	Qty.
18-2918	Outdrive Gasket	911836	1
18-2996	Outdrive Seal	911823	1
18-7153	O-Ring	911851	2

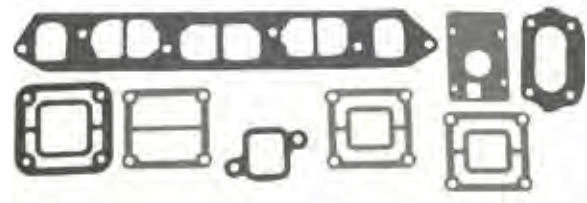

**18-4369
EXHAUST MANIFOLD
GASKET SET**
For: 2.5L (1985-86) and
3.0L (1985-88)



**18-2699
OUTDRIVE GASKET**
For: SX Drives
Use 18-3721 Mounting Nuts

— CONTAINS —

Part #	Description	O.E. #	Qty.
18-7153	O-Ring	911851	2
18-2996	Outdrive Seal	911823	1



**18-4370
EXHAUST MANIFOLD
GASKET SET**
For: 100, 120 HP and 2.5L (1965-85)

— CONTAINS —

Part #	Description	O.E. #	Qty.
18-0114-1	Manifold End Cap Gasket	907761	1
18-2896-1	Exhaust Manifold Mounting Gasket	311068	1
18-0104	Exhaust Elbow Gasket	907764	1
18-0164	Thermostat Housing Gasket	311069	1
18-0937	Carb. Mtg. Gasket	315055	1
18-2861-1	Manifold End Cap Gasket	311121	3
18-2875-1	Elbow To Manifold Gasket	908013	1
18-2858	Thermostat Cover Housing Gasket	314809	1



**18-4408
INTAKE MANIFOLD GASKET SET**
Replaces: 912978
For: GM 4.3L

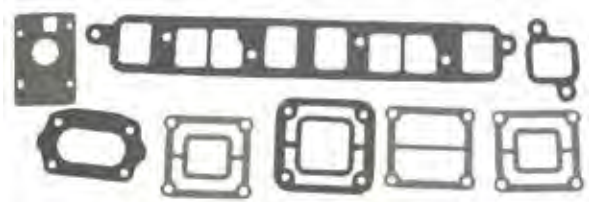



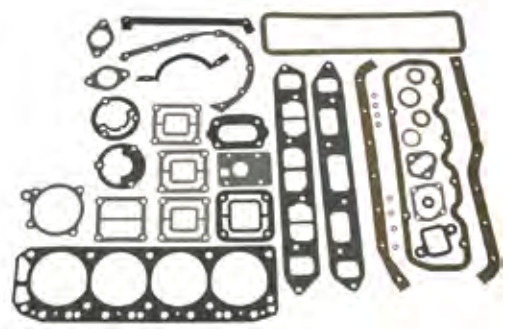

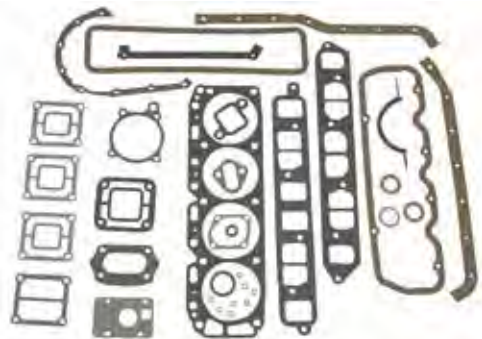

**18-4371
EXHAUST MANIFOLD GASKET SET**
For: 140 HP and 3.0L (1973-84)



**18-4373
OVERHAUL GASKET SET**
For: 110, 120 HP and 2.5L (1965-86)





















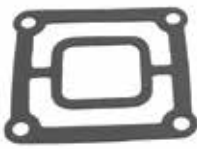

**18-4374
OVERHAUL GASKET SET**
For: 140 HP and 3.0L (1973-88)





 <p>18-2946 HEAD GASKET Replaces: 3853336, 908611 For: GM 181 (3.0L) CID Eng.</p>	 <p>18-3874 HEAD GASKET Replaces: 3853511 For: (8.2L) 502 CID</p>	 <p>18-3876 HEAD GASKET Replaces: 3853380, 914971 For: GM 305 (5.0L)/350 (5.7L) CID Eng.</p>	 <p>18-3877 HEAD GASKET Replaces: 914849 For: GM 454 (7.4L) CID Eng.</p>
 <p>18-3878 HEAD GASKET Replaces: 912766 For: 460 Ford</p>	 <p>18-3879 HEAD GASKET Replaces: 3854299, 912227, 914930 For: GM 262 (4.3L) CID Eng.</p>	 <p>18-3880 HEAD GASKET Replaces: 311210 For: GM 153 (2.5L)</p>	 <p>18-3881 HEAD GASKET Replaces: 908237 For: GM 250 (4.1L) CID (6 cyl) Eng.</p>
 <p>18-3883 HEAD GASKET Replaces: 3853732 For: Ford 302 (5.0L) 351 (5.8L) CID Eng.</p>	 <p>18-3887 HEAD GASKET Replaces: 915325 For: (7.4L) 454 CID GEN V</p>	 <p>18-0434 CARB MOUNTING GASKET Replaces: 909758</p>	<p>PKG. of 2</p>  <p>18-5399 18-5399-9① DISTRIBUTOR CAP GASKET Replaces: 910169</p>
<p>PKG. OF 2</p>  <p>18-0874 18-0874-9① DISTRIBUTOR GASKET For GM V6 & V8 Replaces: 3852109, 312780 For: 2.6L (1989), 3.5L (1989), 4.3L (1987-93), 5.0L (1987-88), 5.7L (1987-92), 7.4L (1988-93), 8.2L (1992-93)</p>	<p>PKG. OF 2</p>  <p>18-0937 18-0937-9① CARB MOUNTING GASKET Replaces: 315055</p>	<p>PKG. OF 2</p>  <p>18-0435 CARB MOUNTING GASKET Replaces: 908765</p>	<p>PKG. OF 2</p>  <p>18-0876 18-0876-9① FUEL PUMP GASKET For GM 4.3L, 5.0L & 5.7L Replaces: 3852113, 312800</p>
<p>PKG. OF 2</p>  <p>18-0164 18-0164-9① THERMOSTAT GASKET 4 & 6 Cyl. Replaces: 311069 GM 3789161</p>	<p>PKG. OF 2</p>  <p>18-0929 18-0929-9① THERMOSTAT GASKET Replaces: 313416</p>	<p>PKG. OF 2</p>  <p>18-2858 18-2858-9① THERMOSTAT GASKET Replaces: 314809</p>	<p>PKG. OF 2</p>  <p>18-2917 18-2917-9① THERMOSTAT GASKET Replaces: 312797, 3701777 (GM)</p>

SEE PAGES 201-202 FOR OUR COMPLETE LINE OF GASKET SEALANTS

① Priced per Package

<p>PKG. OF 2</p>  <p>18-2947 18-2947-9① THERMOSTAT GASKET Replaces: 310913</p>	<p>PKG. OF 2</p>  <p>18-0398 18-0398-9① THERMOSTAT GASKET Replaces: 312797, 3852111</p>	<p>PKG. OF 2</p>  <p>18-0114-1 MANIFOLD END GASKET Replaces: 907761 For GM 4 Cyl.</p>	<p>PKG. OF 2</p>  <p>18-0104 18-0104-9① EXHAUST ELBOW GASKET Replaces: 907764</p>
<p>PKG. OF 2</p>  <p>18-0430 EXHAUST ELBOW GASKET Replaces: 912477</p>	<p>PKG. OF 2</p>  <p>18-0673 18-0673-9① EXHAUST ELBOW GASKET Replaces: 910113</p>	<p>PKG. OF 2</p>  <p>18-0943-2 18-0943-2-9① EXHAUST ELBOW GASKET Replaces: 913783, 909786, 3850496</p>	<p>PKG. OF 2</p>  <p>18-2850-1 18-2850-9① MANIFOLD END CAP GASKET Replaces: 908935</p>
<p>PKG. OF 2</p>  <p>18-2859 18-2859-9① MANIFOLD END CAP GASKET Replaces: 311131</p>	<p>PKG. OF 2</p>  <p>18-2860 18-2860-9① MANIFOLD END CAP GASKET Replaces: 311130</p>	<p>PKG. OF 2</p>  <p>18-2861-1 18-2861-9① MANIFOLD END CAP GASKET Replaces: 311121</p>	<p>PKG. OF 2</p>  <p>18-2875-1 18-2875-1-9① EXHAUST ELBOW GASKET Replaces: 908013, 3850495</p>
<p>PKG. OF 2</p>  <p>18-2883-1 18-2883-1-9① MANIFOLD END CAP GASKET Replaces: 907775</p>	<p>PKG. OF 2</p>  <p>18-2541 RUBBER SEAL Replaces: 911704</p>	<p>PKG. OF 2</p>  <p>18-0401 EXHAUST MANIFOLD GASKET Replaces: 913393 For Ford 140 CID (2.3L)</p>	<p>PKG. OF 2</p>  <p>18-0431 INTAKE MANIFOLD GASKET Replaces: 912471 For Ford 140 CID (2.3L)</p>
<p>PKG. OF 2</p>  <p>18-0956-1 EXHAUST MANIFOLD GASKET Replaces: 912405 460 CID</p>	<p>PKG. OF 2</p>  <p>18-2912-1 EXHAUST MANIFOLD GASKET Replaces: 908079</p>	<p>PKG. OF 2</p>  <p>18-2830-1 EXHAUST MANIFOLD GASKET Inline 6 cyl. Replaces: 907932</p>	<p>PKG. OF 2</p>  <p>18-2896-1 EXHAUST MANIFOLD GASKET Replaces: 311068</p>

① Priced per Package

<p>PKG. OF 2</p>  <p>18-2909 18-2909-9① EXHAUST MANIFOLD GASKET Replaces: 915025 GM V-6</p>	 <p>18-0183-1 EXHAUST MANIFOLD GASKET Replaces: 3853742, 3852455, 908717, 916262 For: OMC 5.0L & 5.8L (1993-96)</p>	 <p>18-0680 EXHAUST MANIFOLD GASKET Replaces: 3853256</p>	 <p>18-0418 EXHAUST MANIFOLD GASKET Replaces: 909613</p>
<p>PKG. OF 2</p>  <p>18-1204-1 18-1204-1-9① EXHAUST MANIFOLD GASKET Replaces: 912164</p>	 <p>18-0892 DEFLECTOR HOSE Replaces: 322411</p>	 <p>18-0664 VALVE COVER GASKET Replaces: 913270, 3852687 For: GM 305/350, 5.0 & 5.7L</p>	 <p>18-2845 VALVE COVER GASKET Replaces: 912965 For GM 305/350 CID (5.0L and 5.7L)</p>
 <p>18-0311 VALVE COVER GASKET Replaces: 3854942 For: 4.3 Litre 262 CID</p>	 <p>18-0346 VALVE COVER GASKET Replaces: 3930912 For: GM 250 CID (4.1L), 160/165/200 (6 cyl.)</p>	 <p>18-0347 VALVE COVER GASKET Replaces: 3852693, 912981, 913277 For: GM 153 & 181 CID (2.5L & 3.0L)</p>	<p>PKG. OF 2</p>  <p>18-0464 18-0464-9① VALVE COVER GASKET Replaces: 912768 For: GM 454/502 CID (7.4L & 8.2L)</p>
 <p>18-0352 VALVE COVER GASKET Replaces: 913758 For: Ford 302/351 CID (5.0L & 5.8L)</p>	 <p>18-0548 ADAPTER TO INTERMEDIATE HOUSING GASKET Replaces: 909515</p>	<p>PKG. OF 2</p>  <p>18-0947 18-0947-9① PIVOT CAP COVER GASKET Replaces: 909529</p>	<p>PKG. OF 2</p>  <p>18-0440 18-0440-9① WATER PASSAGE GASKET Replaces: 915719</p>
 <p>18-0911 WATER PUMP GASKET Replaces: 911698</p>	<p>PKG. OF 2</p>  <p>18-0903 18-0903-9① WATER PUMP GASKET Replaces: 3853361 454 CID</p>	 <p>18-0147 WATER PUMP GASKET For Ford V-8 Replaces: 3852824</p>	 <p>18-0327 WATER PUMP GASKET Replaces: 3853342 4 & 6 Cyl.</p>

<p>PKG. OF 2</p>  <p>18-2916 18-2916-9① WATER PUMP HOUSING GASKET Replaces: 911702</p>	 <p>18-0939 18-0939-9① UPPER GEARCASE DIPSTICK GASKET Replaces: 315189</p>	 <p>18-0468 TIMING COVER GASKET Replaces: 3853512, 912954, 3852654, 915326 For: OMC 2.6L, 3.5L (1989), 4.3L (1987-93), 5.0L (1987-88), 5.7L (1987-92, 1994, 1996)</p>	<p>PKG. OF 2</p>  <p>18-0891 18-0891-9① WATER PUMP MOUNTING GASKET Replaces: 3852477, 909835 For: GM 4.3L, 5.0L & 5.8L</p>
<p>PKG. OF 2</p>  <p>18-0893 18-0893-9① WATER PUMP BACK-IN PLATE GASKET Replaces: 3850595 GM 4.3L, 5.0L & 5.7L</p>	<p>PKG. OF 2</p>  <p>18-0322 18-0322-9① REAR SEAL GASKET Replaces: 3852656 GM 5.0L & 5.7L</p>	 <p>18-0329 PUSH ROD/LIFTER COVER GASKET</p>	<p>PKG. OF 2</p>  <p>18-0887 18-0887-9① TIMING COVER GASKET Replaces: 3852691, 912988, 913275 4 & 6 Cyl.</p>
 <p>18-0980 TIMING COVER GASKET Replaces: 3935449 GM 7.4L</p>	<p>PKG. OF 2</p>  <p>18-0880 18-0880-9① SHIFT COVER GASKET Replaces: 911878</p>	<p>PKG. OF 2</p>  <p>18-0166 18-0166-9① GROMMET Replaces: 911705</p>	 <p>18-2815 PUSH ROD COVER GASKET Replaces: 3852692, 913276 For: 3.0L</p>
 <p>18-0190 WIPER GASKET Replaces: 912157</p>	<p>PKG. OF 2</p>  <p>18-2851 18-2851-9① SWIVEL BEARING GASKET Replaces: 313368</p>	<p>PKG. OF 2</p>  <p>18-2863 18-2863-9① TILT CLUTCH COVER GASKET Replaces: 308799</p>	<p>PKG. OF 2</p>  <p>18-2911 18-2911-9① SWIVEL BEARING HOUSING GASKET Replaces: 910236</p>

① Priced per Package

<p>PKG. OF 5</p>  <p>18-2918 18-2918-9① OUTDRIVE GASKET Replaces: 911836, 915840</p>	<p>PKG. OF 5</p>  <p>18-2996 18-2996-9① OUTDRIVE SEAL Replaces: 911823, 3852560</p>	<p>PKG. OF 2</p>  <p>18-0923 18-0923-9① RUBBER SEAL Replaces: 313244</p>	<p>PKG. OF 2</p>  <p>18-0188 18-0188-9① WASHER Replaces: 909748</p>
 <p>18-1704 SCREW Replaces: 331980 For: Waterpumps, power packs (1985-96)</p>	 <p>18-1236 DRAIN SCREW Replaces: 309243 For Cobra Drives & V-6 40-50HP (1989-97)</p>  <p>18-2387 18-23871-9① (PKG. OF 50) LOWER UNIT DRAIN SCREW Replaces: 307551 Fits: OMC V-6, V-4(1979 & Up), 60-75hp 3 cylinder, 20-35hp (1985-97)</p>	 <p>18-2378 18-23781-9① (PKG. OF 50 without washer) MAGNETIC DRAIN SCREW Replaces: 318544 Fits: Cobra 2.3, 3.0, 3.8 & 5.8L (1986-92), V-6, V-4(1979 & Up), 60-75hp 3 cyl, 40/50hp (1989-98)</p>	<p>PKG. OF 5</p>  <p>18-4253-9① 18-42531-9① (PKG. OF 50) DRAIN SCREW O-RING Replaces: 336982 Used w/ 18-1236 Drain Screw</p>
<p>PKG. OF 2</p>  <p>18-2945 18-2945-9① DRAIN SCREW GASKET Replaces: 307552</p>	 <p>18-8369 OIL INDICATOR WITH WASHER Replaces: 914488 Uses o-ring 18-7116 Fits: OMC Cobra (1986-93) without cone clutch</p>	<p>PKG. OF 5</p>  <p>18-4248 18-4248-9① 18-42481-9① (PKG. OF 50) DRAIN/FILL PLUG WASHER (Plastic) Replaces: 311598</p>	<p>PKG. OF 5</p>  <p>18-4250 18-4250-9① WASHER Replaces: 911820</p>
 <p>18-0549 PLUG OFF CAP Replaces: 909829 I.D. 1" For V-8 Model Stern Drives and Inboards (1977 to present)</p>	 <p>18-0550 PLUG OFF CAP Replaces: 909830 I.D. 1 1/4" For V-8 Model Stern Drives and Inboards 1977 to present</p>	 <p>18-0518 VALVE STEM SEAL Replaces: 3854956, 914323, 3853132 For: most inline 4 and 6 cyl. GM (Early) and 305-350 CID GM</p>	<p>PKG. OF 8</p>  <p>18-4024 18-4024-9① VALVE STEM SEAL Replaces: 3853226, 914445 For: Chevy 4.3L/5.0L/5.7L</p>

① Priced per Package

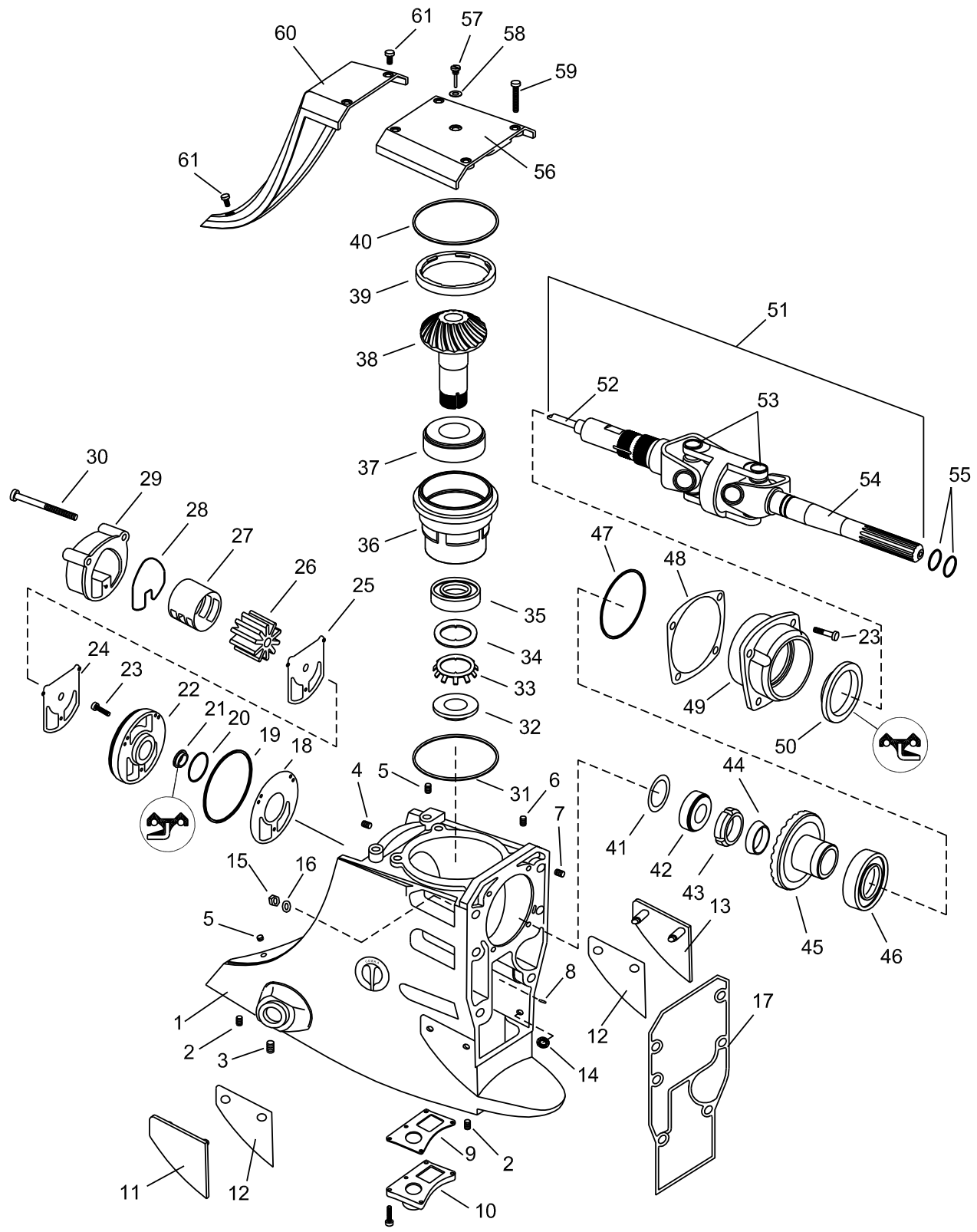

Figure #	Description	Part #	O.E.M. #	Qty.	Figure #	Description	Part #	O.E.M. #	Qty.
1	Upper Gear Housing, Basic w/ Inserts	~	984518	1	32	Pinion Nut	18-3769	911753	1
					33	Nut Retainer	18-3610	911752	1
2	Gearcase Insert	NSS	910935	5	34	Pinion Washer	NSS	911697	1
3	Gearcase Insert	NSS	911779, 3852541	5	35	Pinion Bearing, Lower	18-1170	983892	1
					36	Bearing Carrier, Pinion	18-4828	911750	1
4	Gearcase Insert	NSS	910901	5	37	Pinion Bearing, Upper	18-1161	983891	1
5	Gearcase Insert	NSS	911858, 3852567	3	38	Gear Set, 21:16 (includes 38 & 45)	18-1600	983825	AR
					38	Gear Set, 21:18 (includes 38 & 45)	18-1601	983826	AR
6	Gearcase Insert	NSS	910901	4	38	Gear Set, 21:19 (includes 38 & 45)	18-1602	984012	AR
7	Gearcase Insert	NSS	910901	4					
8	Shift Rod Guide	NSS	912137	1	39	Retainer Ring, Pinion Housing	18-3768	911751	1
9	Gasket, Water Passage Cover	18-0884	911733	1	40	O-Ring, Gear Housing Cover	18-7107	313175	1
10	Water Passage Cover	18-4837	911734	1					
11	Thrust Plate, Starboard	NSS	911838, 3852562	1	41	Shim, Gear Position, 0.003"	18-02062	911662	AR
					41	Shim, Gear Position, 0.005"	18-02063	911663	AR
12	Shim, Thrust Plate, 0.015"	18-1713	911839, 3852563	AR	41	Shim, Gear Position, 0.007"	NSS	911664	AR
					41	Shim, Gear Position, 0.010"	18-02065	911665	AR
13	Thrust Plate, Port	NSS	911837, 3852561	1	41	Shim, Gear Position, 0.012"	18-02066	911666	AR
					41	Shim, Gear Position, 0.015"	18-02067	911667	AR
14	Retainer Ring, Thrust Plate	NSS	910953	4	42	Bearing, U-Joint Shaft	18-1171	983878	1
15	Nut	18-3730	912920, 3852648	6	43	Nut, Gear to U-Joint	18-3770	911937	1
					44	Centering Cone	18-4835	912029	1
16	Washer	NSS	911833	6	45	Gear Set, 21:16 (includes 38 & 45)	18-1600	983825	AR
17	Gasket, Outdrive Mounting	18-2918	911836, 915840	1					
18	Gasket, Adapter to Gear Housing	18-0911	911698	1	45	Gear Set, 21:18 (includes 38 & 45)	18-1601	983826	AR
19	O-Ring, Adapter, Large	18-7407	911700	1					
20	O-Ring, Adapter, Small	18-7403	909316	1	45	Gear Set, 21:19 (includes 38 & 45)	18-1602	984012	AR
21	Water Pump Shaft Seal	18-2068	911701, 915702, 916058, 3853655	1					
22	Adapter, Water Pump to Gear Housing	18-4836	911699	1	46	Bearing, Bearing Carrier	18-1172	983877	1
					47	O-Ring, Bearing Carrier	18-7169	911686	1
23	Screw	18-1598	908668, 341013	6	48	Shim, Bearing Carrier, 0.003", Green	18-0227	911678	AR
					48	Shim, Bearing Carrier, 0.004", Tan	18-0229	911679	AR
24	Gasket, Plate to Adapter	18-2916	911702	1	48	Shim, Bearing Carrier, 0.005", Blue	18-02060	911680	AR
					48	Shim, Bearing Carrier, 0.010", Brown	18-02061	911681	AR
25	Plate, Water Pump	18-3121	911703	1	49	Gear Bearing Carrier	18-4838	911683	1
26	Impeller	18-3058	983895, 777128	1	50	Seal, Bearing Carrier	18-2067	911685	1
27	Liner, Water Pump Cover	18-3145	911844	1	51	U-Joint & Water Pump Shaft Assy	18-2338	983880	1
28	Seal, Water Pump Housing	18-2541	911704	1					
29	Impeller Housing	18-3206	984744	1	52	Stub & Water Pump Shaft	18-6399	984264	1
30	Screw	NSS	912238	3	53	U-Joint Assy	18-2104	912214	2
31	Shim, Bearing Carrier 0.001	18-0209	911669, 911670, 611671, 911672, 911673, 911674, 911675, 911676, 911677	AR	54	Yoke Shaft	18-2146	912212	1
					55	O-Ring, U-Joint Shaft	18-7153	911851, 3852565	2
					56	Gear Housing Cover	18-4838	911845, 986363	1
					57	Oil Indicator	18-8369	914488	1
					58	O-Ring, Oil Indicator	18-7116	303067	1
					59	Screw, Gear Housing Cover	18-1599	123018	4
					60	Cover, Water Pump Access	18-4750	983967	1
31	Shim, Bearing Carrier 0.003	18-0211	911669, 911670, 611671, 911672, 911673, 911674, 911675, 911676, 911677	AR	61	Screw, Water Pump Access Cover	18-4749-9	911859, 3852568	3
						Water Pump Repair Kit w/housing	18-3348	984461, 984744	1

AR As required

NSS Not Sold Seperate



GEAR HOUSINGS

Part No.	OE No.	Description	Application
18-4804	984770, 986381	Upper Gear Housing Complete, 21: 16 Ratio	5.7L(1986-93), 5.8L(1986-89,1991-93)
18-4805	984771, 986382	Upper Gear Housing Complete, 21: 18 Ratio	
18-4806	984765, 986380	Upper Gear Housing Complete, 21: 19 Ratio	4.3L, 3.0L high altitude OMC Cobra (1986-93)



SCREWS

Part No.	OE No.	Application
18-1279	317624	20, 25, 35 HP (1976-86) 120, 140, 275, 300 HP (1985-86) Cobra Drives
18-1598	341013	Fits: OMC Cobra (1986-93) without cone clutch
18-1599	123018	Fits: OMC Cobra (1986-93) without cone clutch
18-3135	306643	Cobra Drives
18-4749-9 ^①	3852568	For Cover Assembly: (3 Pack) Fits: 2.3L (1987-90), 2.5L (1986), 2.6L (1989), 3.0L (1986-93), 4.3L (1986-93), 5.0L (1986-94), 5.7L (1986-92), 5.8L (1989-93), 7.4L (1988)

^① PKG of 3, priced per package



**18-4801
COMPLETE LOWER UNIT ASSEMBLY**
Replaces: 5000356
Fits: 85-140hp Crossflow (1978-94) w/o Upper Driveshaft
Primered only



SHIMS

Part No.	O.E. No.	Size	Part No.	O.E. No.	Size
18-0207 ^①	911668	0.010	18-02065 ^①	911665	0.010
18-0209 ^①	911669, 911670, 911671, 911672, 911673, 911674, 911675, 911676, 911677	0.001	18-02066 ^①	911666	0.012
18-0211 ^①	911669, 911670, 911671, 911672, 911673, 911674, 911675, 911676, 911678		18-02067 ^①	911667	0.015
18-0227 ^{① ②}	911678	0.003	18-2229	323362	0.003
18-0229 ^{① ③}	911679	0.004	18-2230	323361	0.004
18-1713 ^①	3852563	0.015	18-2231	314745	0.005
18-1718 ^⑥	-	Kit			
18-02060 ^{① ④}	911680	0.005			
18-02061 ^{① ⑤}	911681	0.010			
18-02062 ^①	911662	0.003			
18-02063 ^①	911663	0.005			

^① Fits: OMC Cobra (1986-93) without cone clutch
^② Green
^③ Tan
^④ Blue
^⑤ Brown
^⑥ Kit includes 1 each of 18-2229, 18-2230 & 18-2231

NOTE: For shim sizes larger than .010" use shim 18-0207 and appropriate combination of .001" shim (18-0209), and .003" shim (18-0211) to reach desired shim thickness.



**18-9876
SHIM GAUGE TOOL**
Replaces: 349957

MARINE GRADE 316 STAINLESS STEEL WORM GEAR HOSE CLAMPS

All components are manufactured from Marine Grade 316 stainless steel.
 These clamps are designed to fit many applications from 5/16" to 7" diameter hoses.



STAINLESS STEEL CLAMPS

Part #	Diameter Size	Std. #	Part #	Diameter Size	Std. #
18-710-06-2	5/16" to 7/8"	006	118-710-32-2	1 9/16" to 2 1/2"	032
118-710-10-2	9/16" to 1 1/16"	010	118-710-48-2	2 9/16" to 3 1/2"	048
18-710-12-2	9/16" to 1 1/4"	012	18-710-64-2	2 1/2" to 4 1/2"	064
18-710-16-2	1 1/16" to 1 1/2"	016	18-710-72-2	3" to 5"	072
118-710-20-2	3/4" to 1 3/4"	020	118-710-104-2	5" to 7"	104
118-710-24-2	1 1/16" to 2"	024			

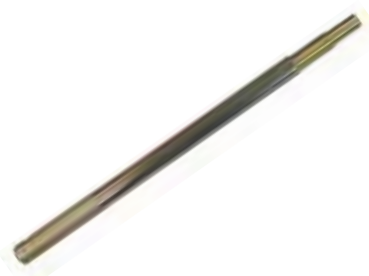

**18-4442
ENGINE ALIGNMENT TOOL**
Used to verify engine alignment on Cobra models.



**18-2100
LINK BELT HEAVY DUTY GIMBAL BEARING**
Replaces: 983937
Uses seal 18-8349
Fits all OMC Cobra and King Cobra Drives



**18-3763
SHIFT SHAFT**
Replaces: 322941
For: V-4/V-6, Cobra, Stringer



18-2337
STUB SHAFT
Replaces: 3850814
Fits: All Cobra 1994-Up except King Cobra



18-6399
SHAFT & STUB ASSEMBLY
Replaces: 984264
For: Cobra Drives- 232, 302(1986-90), 252(1986), 262, 350, 460(1989), 432, 434, 502(1986-92), 504(1986-88), 574(1986-92), 584(1989-93), 754(1987-88)



18-2104
U-JOINT
Heavy Duty
Replaces: 912214, 915716
Fits OMC Cobra Drives (1986-89) Includes straight grease fitting and 90° fitting



18-2174
U-JOINT
Heavy Duty
Replaces: 915717, 3850812
Fits OMC Cobra and King Cobra Drives (1990 & ABOVE)
Includes straight grease fitting and 90° fitting.



18-2338
U-JOINT
Replaces: 983880
For: 1986-93 OMC Cobra



18-2339
U-JOINT ASSEMBLY
Replaces: 3852384
Fits: All Cobra 1994-Up except King Cobra



18-2146
UNIVERSAL YOKE ASSEMBLY
Replaces: 912212, 3850815
For: All Cobra (1986-Up)



18-3770
U-JOINT NUT
Replaces: 911937
For: 232, 252, 262, 302, 350, 432, 434, 460, 502, 504, 574, 584, 744, 754, (1987-93)

Model	Year	U-Joint #	U-Joint Assy. OE #	Long Yoke #	Long Yoke OE #	Short Yoke #	Short Yoke OE #
2.3L	1986 ①	18-2338	983880	18-2146	812212	18-6399	984264
3.0L	1986 ①	18-2338	983880	18-2146	812212	18-6399	984264
4.3L	1986 ①	18-2338	983880	18-2146	812212	18-6399	984264
5.7L	1986 ①	18-2338	983880	18-2146	812212	18-6399	984264
2.3L	1987-1988 ①	18-2338	983880	18-2146	912212	18-6399	984264
3.0L	1987-1988 ①	18-2338	983880	18-2146	912212	18-6399	984264
4.3L	1987-1988 ①	18-2338	983880	18-2146	912212	18-6399	984264
5.0L	1987-1988 ①	18-2338	983880	18-2146	912212	18-6399	984264
5.7L	1987-1988 ①	18-2338	983880	18-2146	912212	18-6399	984264
7.5L	1987-1988 ①	18-2338	983880	18-2146	912212	18-6399	984264
2.3L	1989 ①	18-2338	983880	18-2146	912212	18-6399	984264
3.0L	1989 ①	18-2338	983880	18-2146	912212	18-6399	984264
4.3L	1989 ①	18-2338	983880	18-2146	912212	18-6399	984264
5.0L	1989 ①	18-2338	983880	18-2146	912212	18-6399	984264
5.7L	1989 ①	18-2338	983880	18-2146	912212	18-6399	984264
5.8L	1989 ①	18-2338	983880	18-2146	912212	18-6399	984264
7.5L	1989 ①	18-2338	983880	18-2146	912212	18-6399	984264
2.3L	1990 ②	18-2338	983880	18-2146	912212	18-6399	984264
3.0L	1990 ②	18-2338	983880	18-2146	912212	18-6399	984264
4.3L	1990 ②	18-2338	983880	18-2146	912212	18-6399	984264
5.0L	1990 ②	18-2338	983880	18-2146	912212	18-6399	984264
5.7L	1990 ②	18-2338	983880	18-2146	912212	18-6399	984264
5.8L	1990 ②	18-2338	983880	18-2146	912212	18-6399	984264

APPLICATION CONTINUED ON NEXT PAGE

① Used where raw w/p is located on outrdrive ② Used where raw w/p is located on engine ③ Excludes Model 58FBDPMDA, used where raw w/p is located on engine
④ Used where raw w/p is located on engine, incl. Model 58FBDPMDA

Model	Year	U-Joint #	U-Joint Assy. OE #	Long Yoke #	Long Yoke OE #	Short Yoke #	Short Yoke OE #
5.7L	1990 ①	18-2338	983880	18-2146	912212	18-6399	984264
7.4L	1990 ①	18-2338	983880	18-2146	912212	18-6399	984264
7.5L	1990 ①	18-2338	983880	18-2146	912212	18-6399	984264
3.0L	1991 ①	18-2338	983880	18-2146	912212	18-6399	984264
4.3L	1991 ①	18-2338	983880	18-2146	912212	18-6399	984264
5.7L	1991 ①	18-2338	983880	18-2146	912212	18-6399	984264
5.8L	1991 ①	18-2338	983880	18-2146	912212	18-6399	984264
7.4L	1991 ②	N/A	986191	18-2146	912212	N/A	914646
3.0L	1992-1993 ①	18-2338	983880	18-2146	912212	18-6399	984264
3.2L	1992-1993 ①	18-2338	983880	18-2146	912212	18-6399	984264
4.3L	1992-1993 ①	18-2338	983880	18-2146	912212	18-6399	984264
5.0L	1992-1993 ①	18-2338	983880	18-2146	912212	18-6399	984264
5.7L	1992-1993 ①	18-2338	983880	18-2146	912212	18-6399	984264
5.8L	1992-1993 ①	18-2338	983880	18-2146	912212	18-6399	984264
3.0L	1992-1993 ②	N/A	986191	18-2146	912212	N/A	914646
3.2L	1992-1993 ②	N/A	986191	18-2146	912212	N/A	914646
4.3L	1992-1993 ②	N/A	986191	18-2146	912212	N/A	914646
5.0L	1992-1993 ②	N/A	986191	18-2146	912212	N/A	914646
5.7L	1992-1993 ②	N/A	986191	18-2146	912212	N/A	914646
5.8L	1992-1993 ②	N/A	986191	18-2146	912212	N/A	914646
7.4L	1992-1993 ②	N/A	986191	18-2146	912212	N/A	914646
8.2L	1992-1993 ②	N/A	986191	18-2146	912212	N/A	914646
3.0L	1994 ③	18-2339	3852384	18-2146	3850815	18-2337	3850814
4.3L	1994 ③	18-2339	3852384	18-2146	3850815	18-2337	3850814
5.0L	1994 ③	18-2339	3852384	18-2146	3850815	18-2337	3850814
5.7L	1994 ③	18-2339	3852384	18-2146	3850815	18-2337	3850814
5.8L	1994 ③	18-2339	3852384	18-2146	3850815	18-2337	3850814
5.8L	1994 ④	N/A	3853937	18-2146	3850815	N/A	3853563
7.4L	1994 ④	N/A	3853937	18-2146	3850815	N/A	3853563
3.0L	1995 ②	18-2339	3852384	18-2146	3850815	18-2337	3850814
4.3L	1995 ②	18-2339	3852384	18-2146	3850815	18-2337	3850814
5.0L	1995 ②	18-2339	3852384	18-2146	3850815	18-2337	3850814
5.8L	1995 ②	18-2339	3852384	18-2146	3850815	18-2337	3850814
7.4L	1995 ②	N/A	3853937	18-2146	3850815	N/A	3853563
3.0L	1996 ②	18-2339	3852384	18-2146	3850815	18-2337	3850814
4.3L	1996 ②	18-2339	3852384	18-2146	3850815	18-2337	3850814
5.0L	1996 ②	18-2339	3852384	18-2146	3850815	18-2337	3850814
5.7L	1996 ②	18-2339	3852384	18-2146	3850815	18-2337	3850814
5.8L	1996 ②	18-2339	3852384	18-2146	3850815	18-2337	3850814
7.4L	1996 ②	18-2339	3852384	18-2146	3850815	18-2337	3850814
3.0L	1997 ②	18-2339	3852384	18-2146	3850815	18-2337	3850814
4.3L	1997 ②	18-2339	3852384	18-2146	3850815	18-2337	3850814
5.7L	1997 ②	18-2339	3852384	18-2146	3850815	18-2337	3850814
7.4L	1997 ②	18-2339	3852384	18-2146	3850815	18-2337	3850814
3.0L	1998 ②	18-2339	3852384	18-2146	3850815	18-2337	1850814
4.3L	1998 ②	18-2339	3852384	18-2146	3850815	18-2337	1850814
5.0L	1998 ②	18-2339	3852384	18-2146	3850815	18-2337	1850814
5.7L	1998 ②	18-2339	3852384	18-2146	3850815	18-2337	1850814
7.4L	1998 ②	18-2339	3852384	18-2146	3850815	18-2337	1850814
8.2L	1998 ②	18-2339	3852384	18-2146	3850815	18-2337	1850814
43APHUB	1995	18-2339	3852384	18-2146	3850815	18-2337	3850814
43FAPNCA	1996	18-2339	3852384	18-2146	3820815	18-2337	3850814
43FBPBYC	1998	18-2339	3852384	18-2146	3820815	18-2337	3850814
43FBPLKD	1997	18-2339	3852384	18-2146	3820815	18-2337	3850814
43FBPNCS	1996	18-2339	3852384	18-2146	3820815	18-2337	3850814
50FBPBYC	1998	18-2339	3852384	18-2146	3820815	18-2337	3850814
50FACPMDA	1994	18-2339	3852384	18-2146	3820815	18-2337	3850814

APPLICATION CONTINUED ON NEXT PAGE

① Used where raw w/p is located on outdrive ② Used where raw w/p is located on engine ③ Excludes Model 58FBPMDA, used where raw w/p is located on engine
 ④ Used where raw w/p is located on engine, incl. Model 58FBPMDA

Model	Year	U-Joint #	U-Joint Assy. OE #	Long Yoke #	Long Yoke OE #	Short Yoke #	Short Yoke OE #
50FACPMMDM	1994	18-2339	3852384	18-2146	3820815	18-2337	3850814
50FAGPMDA	1994	18-2339	3852384	18-2146	3820815	18-2337	3850814
50FAGPMMDM	1994	18-2339	3852384	18-2146	3820815	18-2337	3850814
50FAPHUB	1995	18-2339	3852384	18-2146	3850815	18-2337	3850814
50FAPHUE	1995	18-2339	3852384	18-2146	3850815	18-2337	3850814
50FAPNCA	1996	18-2339	3852384	18-2146	3820815	18-2337	3850814
50FAPNCS	1996	18-2339	3852384	18-2146	3820815	18-2337	3850814
50FBPBYC	1998	18-2339	3852384	18-2146	3820815	18-2337	3850814
57FAPLKD	1997	18-2339	3852384	18-2146	3850815	18-2337	3850814
57FAPNCA	1996	18-2339	3852384	18-2146	3850815	18-2337	3850814
57FAPNCS	1996	18-2339	3852384	18-2146	3850815	18-2337	3850814
57FCPBYC	1998	18-2339	3852384	18-2146	3820815	18-2337	3850814
57FCPBYD	1998	18-2339	3852384	18-2146	3820815	18-2337	3850814
57FCLKD	1997	18-2339	3852384	18-2146	3850815	18-2337	3850814
57FDPLKD	1997	18-2339	3852384	18-2146	3850815	18-2337	3850814
58FACPMDA	1994	18-2339	3852384	18-2146	3820815	18-2337	3850814
58FACPMMDM	1994	18-2339	3852384	18-2146	3820815	18-2337	3850814
58FAGPMDA	1994	18-2339	3852384	18-2146	3820815	18-2337	3850814
58FAGPMMDM	1994	18-2339	3852384	18-2146	3820815	18-2337	3850814
58FAPHUB	1995	18-2339	3852384	18-2146	3820815	18-2337	3850814
58FAPHUE	1995	18-2339	3852384	18-2146	3820815	18-2337	3850814
58FBDMDA	1994	18-2339	3852384	18-2146	3820815	18-2337	3850814
58FBPHUB	1995	18-2339	3852384	18-2146	3820815	18-2337	3850814
58FBPHUE	1995	18-2339	3852384	18-2146	3820815	18-2337	3850814
58FBPNCA	1996	18-2339	3852384	18-2146	3820815	18-2337	3850814
58FBPMDA	1994	18-2339	3852384	18-2146	3820815	18-2337	3850814
58FCPNCA	1996	18-2339	3852384	18-2146	3820815	18-2337	3850814
58FCPNCS	1996	18-2339	3852384	18-2146	3820815	18-2337	3850814
74FEPHUB	1995	18-2339	3852384	18-2146	3820815	18-2337	3850814
74FFPNCA	1996	18-2339	3852384	18-2146	3850815	18-2337	3850814
74FGPLKD	1997	18-2339	3852384	18-2146	3820815	18-2337	3850814
74FGPNCS	1996	18-2339	3852384	18-2146	3850815	18-2337	3850814
74FHPYC	1998	18-2339	3852384	18-2146	3820815	18-2337	3850814
74FHPBYC	1998	18-2339	3852384	18-2146	3820815	18-2337	3850814
74FJPBYC	1998	18-2339	3852384	18-2146	3820815	18-2337	3850814
74FJPYC	1998	18-2339	3852384	18-2146	3820815	18-2337	3850814
74FJPBYD	1998	18-2339	3852384	18-2146	3820815	18-2337	3850814
74FJPYD	1998	18-2339	3852384	18-2146	3820815	18-2337	3850814
82FCPBYC	1998	18-2339	3852384	18-2146	3820815	18-2337	3850814
302CCPMDA	1994	18-2339	3852384	18-2146	3820815	18-2337	3850814
302CGPMDA	1994	18-2339	3852384	18-2146	3820815	18-2337	3850814
302CMBYC	1998	18-2339	3852384	18-2146	3820815	18-2337	3850814
302CMBYM	1998	18-2339	3852384	18-2146	3820815	18-2337	3850814
302CMHUB	1995	18-2339	3852384	18-2146	3820815	18-2337	3850814
302CMLKD	1997	18-2339	3852384	18-2146	3850815	18-2337	3850814
302CMNCA	1996	18-2339	3852384	18-2146	3820815	18-2337	3850814
302CMNCS	1996	18-2339	3852384	18-2146	3820815	18-2337	3850814
302CPBYC	1998	18-2339	3852384	18-2146	3820815	18-2337	3850814
302CPBYM	1998	18-2339	3852384	18-2146	3820815	18-2337	3850814
302CPHUB	1995	18-2339	3852384	18-2146	3820815	18-2337	3850814
302CPLKD	1997	18-2339	3852384	18-2146	3850815	18-2337	3850814
302CPNCA	1996	18-2339	3852384	18-2146	3820815	18-2337	3850814
302CPNCS	1996	18-2339	3852384	18-2146	3820815	18-2337	3850814
302DCMMDA	1994	18-2339	3852384	18-2146	3820815	18-2337	3850814
302DGMMDA	1994	18-2339	3852384	18-2146	3820815	18-2337	3850814
432ACMMDA	1994	18-2339	3852384	18-2146	3820815	18-2337	3850814
432ACPMDA	1994	18-2339	3852384	18-2146	3820815	18-2337	3850814
432AGMMDA	1994	18-2339	3852384	18-2146	3820815	18-2337	3850814

APPLICATION CONTINUED ON NEXT PAGE

① Used where raw w/p is located on outdrive ② Used where raw w/p is located on engine ③ Excludes Model 58FBPMDA, used where raw w/p is located on engine
 ④ Used where raw w/p is located on engine, incl. Model 58FBPMDA

Model	Year	U-Joint #	U-Joint Assy. OE #	Long Yoke #	Long Yoke OE #	Short Yoke #	Short Yoke OE #
432AGPMDA	1994	18-2339	3852384	18-2146	3820815	18-2337	3850814
432APNCA	1996	18-2339	3852384	18-2146	3820815	18-2337	3850814
432BPLKD	1997	18-2339	3852384	18-2146	3820815	18-2337	3850814
432BPNC	1996	18-2339	3852384	18-2146	3820815	18-2337	3850814
502APHUB	1995	18-2339	3852384	18-2146	3820815	18-2337	3850814
502APHUE	1995	18-2339	3852384	18-2146	3820815	18-2337	3850814
432ACMMDA	1994	18-2339	3852384	18-2146	3820815	18-2337	3850814
432ACPMDA	1994	18-2339	3852384	18-2146	3820815	18-2337	3850814
432AGMMDA	1994	18-2339	3852384	18-2146	3820815	18-2337	3850814
432AGPMDA	1994	18-2339	3852384	18-2146	3820815	18-2337	3850814
432BPBYC	1998	18-2339	3852384	18-2146	3820815	18-2337	3850814
432BPLKD	1997	18-2339	3852384	18-2146	3820815	18-2337	3850814
434APNCA	1996	18-2339	3852384	18-2146	3820815	18-2337	3850814
434BPBYC	1998	18-2339	3852384	18-2146	3820815	18-2337	3850814
434BPLKD	1997	18-2339	3852384	18-2146	3820815	18-2337	3850814
434BPNC	1996	18-2339	3852384	18-2146	3820815	18-2337	3850814
502ACPMDA	1994	18-2339	3852384	18-2146	3820815	18-2337	3850814
502AGPMDA	1994	18-2339	3852384	18-2146	3820815	18-2337	3850814
502APHUB	1995	18-2339	3852384	18-2146	3850815	18-2337	3850814
502APHUE	1995	18-2339	3852384	18-2146	3850815	18-2337	3850814
502APNCA	1996	18-2339	3852384	18-2146	3820815	18-2337	3850814
502APNC	1996	18-2339	3852384	18-2146	3820815	18-2337	3850814
502BPBYC	1998	18-2339	3852384	18-2146	3820815	18-2337	3850814
572ACPMDA	1994	18-2339	3852384	18-2146	3820815	18-2337	3850814
572AGPMDA	1994	18-2339	3852384	18-2146	3820815	18-2337	3850814
572BPBYC	1998	18-2339	3852384	18-2146	3820815	18-2337	3850814
572BPLKD	1997	18-2339	3852384	18-2146	3820815	18-2337	3850814
572BPLKR	1997	18-2339	3852384	18-2146	3820815	18-2337	3850814
572BPNC	1996	18-2339	3852384	18-2146	3820815	18-2337	3850814
574BPLKD	1997	18-2339	3852384	18-2146	3820815	18-2337	3850814
584ACPMDA	1994	18-2339	3852384	18-2146	3820815	18-2337	3850814
584AGPMDA	1994	18-2339	3852384	18-2146	3820815	18-2337	3850814
584APHUB	1995	18-2339	3852384	18-2146	3820815	18-2337	3850814
584APHUE	1995	18-2339	3852384	18-2146	3820815	18-2337	3850814
584APNCA	1996	18-2339	3852384	18-2146	3820815	18-2337	3850814
584APNC	1996	18-2339	3852384	18-2146	3820815	18-2337	3850814
744DCPMDM	1994	18-2339	3852384	18-2146	3820815	18-2337	3850814
744DCPMDA	1994	18-2339	3852384	18-2146	3820815	18-2337	3850814
744DDPMDA	1994	18-2339	3852384	18-2146	3820815	18-2337	3850814
744DDPMDM	1994	18-2339	3852384	18-2146	3820815	18-2337	3850814
744DGPMDA	1994	18-2339	3852384	18-2146	3820815	18-2337	3850814
744DGPMDM	1994	18-2339	3852384	18-2146	3820815	18-2337	3850814
744DJPMDA	1994	18-2339	3852384	18-2146	3820815	18-2337	3850814
744DJPMDM	1994	18-2339	3852384	18-2146	3820815	18-2337	3850814
744DPHUB	1995	18-2339	3852384	18-2146	3820815	18-2337	3850814
744EPNCA	1996	18-2339	3852384	18-2146	3850815	18-2337	3850814
744FPLKD	1997	18-2339	3852384	18-2146	3850815	18-2337	3850814
744FPNC	1996	18-2339	3852384	18-2146	3850815	18-2337	3850814

① Used where raw w/p is located on outdrive ② Used where raw w/p is located on engine
 ③ Excludes Model 58FBPMDA, used where raw w/p is located on engine ④ Used where raw w/p is located on engine, incl. Model 58FBPMDA



**18-2772-1
TRANSOM
SEAL KIT**
For: SX Cobra Drives with cone clutch

— CONTAINS —

Part #	Description	O.E. #	Qty.
18-2100	Gimbal Bearing	3853807	1
18-2765	Bellows	3854127	1
18-1074	Bellows	3850426-2	1
18-2996	Seal	3852560, 911823	1
18-710-64-2	Hose Clamp	853012-3	1



**18-2771
BELLOWS KIT**
Replaces: 3854270
For: OMC Cobra without cone clutch

— CONTAINS —

Part #	Description	O.E. #
18-2613	Outdrive Gasket Set	—
18-2765	U-Joint Bellows	983973, 987467
18-2764	Exhaust Bellows	914036
18-2763	Shift Cable Bellows	911826
18-2100	Gimbal Bearing	983937
18-710-64-2	Hose Clamp	—



18-2128
CENTER SOCKET
Replaces:
912213, 3850813
Fits all OMC Cobra



18-2745
EXHAUST BOOT
Replaces: 912374
Fits 5.7L & 7.5L (1986 & later)



18-1074
EXHAUST BELLOW
I.D. 2 5/8" x O.D. 3" x L 7.5"
Replaces: 3850426
All cone clutch models (1994-up)
not using exhaust boot



18-2763
SHIFT CABLE BELLOWS
Replaces: 911826
ALL COBRA



18-2764
EXHAUST BELLOWS
Replaces: 914036
All clutch dog Cobra models
(1986-93)



18-2765
U-JOINT BELLOWS
I.D. 3 1/2" x O.D. 4" x L 6"
Replaces: 983973,
987467, 3854127
All clutch dog Cobra models (1986-93)



18-21754
ENGINE COUPLER
Replaces: 986232, 984537
Fits: 7.5L / 460 King Cobra 1987-90



18-21751
ENGINE COUPLER
Replaces: 3853962,
983902, 986338
Fits: 2.5L (1986), 3.0L (1986-90), (4.3L,
5.0L, 5.7L) (1986) KW & KWB suffix only,
7.4L (1990-98), 8.2L (1992-93, 1998)



18-21752-1
ENGINE COUPLER
Replaces: 3858437, 984290,
986120, 3853917
Fits: 4.3L (1986-98), 5.0L (1986-88, 1998)
5.7 (1986-92, 1994, 1996-98)



18-21753
ENGINE COUPLER
Replaces: 3853862
Fits: 5.0L & 5.8L (1989-96)



18-21755
ENGINE COUPLER
Replaces: 984629
2.3L Cobra



18-2533
TRANSOM SEAL
Replaces: 911797



18-2767
TRANSOM SEAL
16 hole
Replaces: 313080
(1967-77) 120 HP and UP



18-2768
TRANSOM SEAL
22 hole
Replaces: 909527
(1978-86) — ALL



18-2245-1
SHIFT CABLE ASSEMBLY
Replaces: 987661
Wire: 68" • Jacket: 58 1/2"
For: 1988-1993 OMC Cobra (except King)
without cone clutch



18-2246
SHIFT CABLE ASSEMBLY
Replaces: 987678
Wire: 59"
For: King Cobra

 <p>18-3769 PINION NUT Replaces: 911753 For: 115 (1994-97), 232 (1987-90), 252 (1986), 262, 350, 460 (1989), 302, 574 (1986-92), 432 (1986-93), 502 (1988-93), 504, 754 (1986-88), 584 (1989-93), 744 (1988), 90 Jet (1994-95)</p>	 <p>18-3719 PINION NUT Replaces: 314730 (⁵/₈ - 18)</p>	 <p>18-2176 BALL GEAR (Intermediate Housing) Replaces: 908063 1973-86</p>	 <p>18-2177 BALL GEAR (Upper Gear Case) Replaces: 908069 1973-86</p>	
<p>PKG. OF 5</p>  <p>18-3725 18-3725-9① BALL GEAR NUT Replaces: 908064</p>	<p>PKG. OF 2</p>  <p>18-3731 18-3731-9① LOCKNUT Replaces: 907866 ³/₄ - 16</p>	<p>PKG. OF 5</p>  <p>18-4251 18-4251-9① PLUG Replaces: 908062 O.D. 1.748</p>	 <p>18-4835 CENTERING CONE Replaces: 912029 Fits: OMC Cobra (1986-93) without cone clutch</p>	 <p>18-1750 COMPLETE BEARING HOUSING For: Cobra Drives & V6</p>
 <p>18-1154 BALL BEARING Replaces: 377139</p>	 <p>18-1161 TAPERED ROLLER BEARING Replaces: 983891</p>	 <p>18-1170 LOWER PINION BEARING Replaces: 983892</p>	 <p>18-1171 U-JOINT SHAFT BEARING Replaces: 983878</p>	 <p>18-1172 CARRIER BEARING Replaces: 983877 For: 1986-95 Cobra</p>
 <p>18-1158 CARRIER BEARING Replaces: 387247</p>	 <p>18-1350 CARRIER BEARING Replaces: 379504</p>	 <p>18-1351 CARRIER BEARING Replaces: 382407 COBRA</p>	 <p>18-1117 PINION BEARING Replaces: 387817</p>	 <p>18-1357 PINION BEARING Replaces: 384195 COBRA</p>
 <p>18-1358 REVERSE GEAR BEARING Replaces: 389039 COBRA</p>	 <p>18-1365 THRUST BEARING Replaces: 387656 COBRA DRIVE SHAFT</p>	 <p>18-1366 THRUST BEARING Replaces: 382408 COBRA REVERSE GEAR</p>	 <p>18-1370 THRUST FORWARD BEARING Replaces: 389042</p>	 <p>18-1371 THRUST FORWARD BEARING Replaces: 385043 COBRA</p>

① Priced per Package

OMC 400 & 800 SERIES GEARCASE BEARINGS

HP	Year	Pinion Bearing	Drive Shaft Bearing	Carrier Aft Bearing	Carrier Fore Bearing	Forward Thrust Bearing	Reverse Thrust Bearing	Housing Bearing
120	1978-81	18-1357	18-1365	18-1350	18-1351	18-1371	18-1366	—
2.5L	1982-86	18-1357	18-1365	18-1350	18-1351	18-1371	18-1366	18-1351
140	1978-81	18-1357	18-1365	18-1350	18-1351	18-1371	18-1366	—
3.0L	1982-86	18-1357	18-1365	18-1350	18-1351	18-1371	18-1366	18-1351
185/3.8L	1978-85	18-1117	18-1365	18-1158	18-1351	18-1370	18-1366	18-1358
4.3L	1985-86	18-1117	18-1365	18-1158	18-1351	18-1370	18-1366	18-1358
200/5.0L	1979-86	18-1117	18-1365	18-1158	18-1351	18-1370	18-1366	18-1358
225	1978	18-1117	18-1365	18-1158	18-1351	18-1370	18-1366	18-1358
230/530L	1979-86	18-1117	18-1365	18-1158	18-1351	18-1370	18-1366	18-1358
240	1978	18-1117	18-1365	18-1158	18-1351	18-1370	18-1366	18-1358
250	1979	18-1117	18-1365	18-1158	18-1351	18-1370	18-1366	18-1358
260/5.7L	1979-86	18-1117	18-1365	18-1158	18-1351	18-1370	18-1366	18-1358

OMC COBRA GEAR HOUSING BEARINGS

Model	Liter	Year	Pinion Bearing	Drive Shaft Bearing	Carrier Aft Bearing	Carrier Fore Bearing	Forward Thrust Bearing	Reverse Thrust Bearing	Housing Bearing
2.3L	2.3L	1987	18-1357	18-1365	18-1350	18-1351	18-1371	18-1366	18-1351
2.3L	2.3L	1988-1990	18-1357	18-1365	18-1350	18-1351	18-1371	18-1366	N/A
2.5L	2.5L	1986	18-1357	18-1365	18-1350	18-1351	18-1371	18-1366	18-1351
3.0L	3.0L	1986-1987	18-1357	18-1365	18-1350	18-1351	18-1371	18-1366	18-1351
3.0L	3.0L	1988-1989	18-1357	18-1365	18-1350	18-1351	18-1371	18-1366	N/A
3.0L	3.0L	1990-1991	18-1117	18-1365	18-1158	18-1351	18-1370	18-1366	N/A
3.0L	3.0L	1992-1993	18-1117	18-1365	N/A	18-1351	18-1370	18-1366	N/A
3.0L HO	3.0L	1992-1993	18-1117	18-1365	N/A	18-1351	18-1370	18-1366	N/A
4.3L	4.3L	1986-1987	18-1117	18-1365	18-1158	18-1351	18-1370	18-1366	18-1358
4.3L	4.3L	1988-1991	18-1117	18-1365	18-1158	18-1351	18-1370	18-1366	N/A
4.3L	4.3L	1992-1993	18-1117	18-1365	N/A	18-1351	18-1370	18-1366	N/A
4.3L HO	4.3L	1992-1993	18-1117	18-1365	N/A	18-1351	18-1370	18-1366	N/A
5.0L	5.0L	1986-1987	18-1117	18-1365	18-1158	18-1351	18-1370	18-1366	18-1358
5.0L	5.0L	1988-1991	18-1117	18-1365	18-1158	18-1351	18-1370	18-1366	N/A
5.0L	5.0L	1992-1993	18-1117	18-1365	N/A	18-1351	18-1370	18-1365	N/A
5.0L HO	5.0L	1992-1993	18-1117	18-1365	N/A	18-1351	18-1370	18-1365	N/A
5.7L	5.7L	1986-1987	18-1117	18-1365	18-1158	18-1351	18-1370	18-1366	18-1358
5.7L	5.7L	1988-1991	18-1117	18-1365	N/A	18-1351	18-1370	18-1365	N/A
5.7L	5.7L	1992-1993	18-1117	18-1365	N/A	18-1351	18-1370	18-1366	N/A
5.8L	5.8L	1989-1991	18-1117	18-1365	N/A	18-1351	18-1370	18-1366	N/A
5.8L	5.8L	1992-1993	18-1117	18-1365	N/A	18-1351	18-1370	18-1366	N/A



18-0195
THRUST WASHER
 Replaces: 314731
 COBRA



18-0198
FORWARD GEAR THRUST WASHER
 Replaces: 324766

PKG. OF 2



18-2243
18-2243-9^①
DETENT BALL
 Replaces: 316506
 For: V-4 & V-6 gearcase
 OMC Sterndrive 400 Series (1978-79);
 800 Series (1978)



18-1501
DETENT BALL
 Replaces: 160084
 For: Cobra drives (1980& Earlier)



18-1701
LOWER DRIVE SHAFT
 Replaces: 911693
 For: Cobra Drives 262, 302, 350,
 432, 434, 502, 504, 574, 584



18-2183
DRIVE SHAFT
 Replaces: 909121

① Priced per Package



18-2184
DRIVE SHAFT
 Replaces: 908087



18-2185
DRIVE SHAFT
 Replaces: 909753



18-2186
DRIVE SHAFT
 Replaces: 982424
 800 Drives



18-2187
PROP SHAFT
 Replaces: 395209
 Cobra & Late Model 800 Drives



18-2251
PROP SHAFT
 Replaces: 435022, 433017, 436740



18-2252
PROP SHAFT
 Replaces: 387818, 436888



18-2216
SLIDING CLUTCH
 Replaces: 337772, 337774,
 334516, 336562, 910995



18-2220
SLIDING CLUTCH
 Replaces: 323664, 320630



18-2383
SLIDING CLUTCH
 Replaces: 914716, 915272
 For: 3.0L (GM), 4.3L (GM), 5.0L (Ford), 5.7L (Ford),
 5.8L (Ford) (1990-91)



18-2218
FORWARD GEAR SET
 Replaces: 434063, 987966,
 985050, 436746



18-2219
REVERSE GEAR
 Replaces: 333077,
 317838, 340490



18-1600
UPPER GEAR KIT
 with bearing
 Replaces: 983825
 For: 5.7, 5.8L V-8 Cobra drives (21:16 ratio)



18-1601
UPPER GEAR KIT
 with bearing
 Replaces: 983826
 For: 5.0L V-8 engines-Cobra drives (21:18 ratio)



18-1602
UPPER GEAR KIT
 Replaces: 984012
 For: 4.3L V-6 engines-Cobra drives (21:19 ratio)

SHAFT/GEAR/SLIDING CLUTCH APPLICATION

Model	Year	Bearing Carrier Shaft	Short/Long Water Pump Shaft	Drive Shaft	Prop Shaft	Forward Gear	Reverse Gear	Sliding Clutch
100 thru 165	1973	—	18-2185	—	—	—	—	—
120 thru 190	1974-75	—	18-2185	—	—	—	—	—
120 thru 235 ⑥	1976-77	—	18-2184	—	—	—	—	—
120 thru 190 ⑤	1976	—	18-2185	—	—	—	—	—
120/140 ⑤	1977	—	18-2185	—	—	—	—	—
120/140	1978-81	18-2183	18-2185	—	18-2252	—	—	18-2220
120 thru 235 ⑥	1977	—	18-2184	—	—	—	—	—
175/190/235 ⑤	1977	18-2183	18-2185	—	—	—	—	—
185	1978	18-2183	18-2185	18-2186	—	—	—	—
185	1980-81	18-2183	18-2185	18-2186	—	—	—	—
200	1979	18-2183	18-2185	18-2186	—	—	—	—
200	1980-81	18-2183	18-2185	18-2186	—	—	—	—
225/245	1973-75	—	18-2184	—	—	—	—	—
225	1978	18-2183	18-2185	18-2186	—	—	—	—
225	1979	—	—	18-2186	—	—	—	—
225	1980	—	—	18-2186	—	—	—	—
225	1981	—	—	18-2186	—	—	—	—
230	1979	18-2183	18-2185	18-2186	—	—	—	—
230	1980-81	18-2183	18-2185	18-2186	—	—	—	—
235	1975	18-2183	18-2185	—	—	—	—	—
235 ⑤	1976-77	18-2183	18-2185	—	—	—	—	—
240	1978	18-2183	18-2185	18-2186	—	—	—	—
240	1979	—	—	18-2186	—	—	—	—
240	1980-81	—	—	18-2186	—	—	—	—
250	1979	18-2183	18-2185	18-2186	—	—	—	—
260	1979	18-2183	18-2185	18-2186	—	—	—	—
260	1980-81	18-2183	18-2185	—	—	—	—	—
262	1989	—	—	—	18-2187	—	—	—
2.3/3.0	1987-89	—	—	—	18-2252	—	18-2219	—
2.3	1990	—	—	—	18-2252	—	—	—
2.5	1986	18-2183	18-2185	—	18-2252	—	18-2219	—
2.5	1982-87	18-2183	18-2185	—	18-2252	18-2218	18-2219	—
350 ③	1988-89	—	—	—	18-2187	18-2218	—	—
3 ①	1982-86	18-2183	18-2185	—	18-2252	18-2218	18-2219	18-2216
3.0/4.3 ③	1990-91	—	—	—	18-2187	—	—	18-2383
3.0/4.3	1992-93	—	—	—	18-2251	—	—	18-2383
3.0 H.O.	1990-91	—	—	—	18-2187	—	—	18-2383
3.0 H.O.	1992-93	—	—	—	18-2251	—	—	18-2383
3.8	1982-86	18-2183	18-2185	18-2186	18-2187	—	—	18-2216
460 ③	1988-89	—	—	—	18-2187	—	—	18-2216
4.3 ①	1985-86	18-2183	18-2185	18-2186	18-2187	—	—	18-2216
4.3 ②	1986-87	—	—	—	18-2187	—	—	—
4.3 ③	1988-91	—	—	—	18-2187	—	—	18-2383 ⑨
4.3 H.O.	1990-91	—	—	—	18-2187	—	—	18-2383
4.3 H.O.	1992-93	—	—	—	18-2251	—	—	18-2383
5.0/5.7	1982-83	18-2183	18-2185	18-2186	—	—	—	18-2216
5.0/5.7 ①	1984-86	18-2183	18-2185	18-2186	18-2187	—	—	18-2216
5 ②	1986-87	—	—	—	18-2187	—	—	—
5	1988	—	—	—	18-2187	—	—	—
5 ③	1988-91	—	—	—	18-2187	—	—	18-2383 ⑨
5.0/5.7	1992	—	—	—	18-2251	—	—	18-2383
5.0 H.O.	1990-91	—	—	—	18-2187	—	—	18-2383
5.0 H.O.	1992-93	—	—	—	18-2251	—	—	18-2383
5.7	1987-88	—	—	—	18-2187	—	—	—
5.7 ③	1988-89	—	—	—	18-2187	—	—	—
5.7 ⑧ ③	1990-92	—	—	—	18-2187	—	—	18-2383
5.8 ③	1989-90	—	—	—	18-2187	—	—	18-2383 ⑨
5.8	1991	—	—	—	18-2187	—	—	18-2383
5.8	1992-93	—	—	—	18-2251	—	—	18-2383
7.5	1987	—	—	—	18-2187	—	—	18-2216

① Except Cobra
② Cobra

③ Right hand rotation drive
⑤ Low profile

⑥ High profile
⑧ Except L.E. models

⑨ 1990-93 models only



**18-1702
CARRIER BEARING**
Replaces: 438039, 5000074
For: 1 3/16" diameter prop shaft-Cobra drives (1986-90) Fits all stringer mounts except 2.5L & 3.0L (1978-85)



**18-1703
CARRIER BEARING**
Replaces: 434400, 435096, 438040, 5000363, 5004257
For: 1 1/4" diameter prop shaft Cobra drives (1991-93)



18-4828
PINION BEARING CARRIER
 Replaces: 911750
 Fits: OMC Cobra (1986-93) without cone clutch



18-1099
BEARING HOUSING & SEAL ASSEMBLY
 Replaces: 982422
 For: OMC Stringer Drive-120, 140, 170, 200, 230, 260, (1981), 252, 302, 382, 502, 504 & 574 (1982-85), 432 (1985)



18-1343
BEARING CARRIER RETAINING TAB
 Replaces: 333957
 For: Cobra drives & V-6



18-0655
SHIFT ROD
 Replaces: 914736
 3.0L (1990-1993), 4.3L, 5.0L, 5.7L, 5.8L (1986-1993)



18-0647
SHIFT ROD ASSEMBLY
 Replaces: 986658
 3.0L (1990-1993), 4.3L, 5.0L, 5.7L, 5.8L (1986-1993)



18-0652
ROD END, SHIFT
 Replaces: 914723
 3.0L (1990-1993), 4.3L, 5.0L, 5.7L, 5.8L (1986-1993)



18-0653
SCREW, SHIFT ROD END
 Replaces: 308825
 3.0L (1990-1993), 4.3L, 5.0L, 5.7L, 5.8L (1986-1993)



18-0654
NUT, SHIFT ROD END
 Replaces: 914743
 3.0L (1990-1993), 4.3L, 5.0L, 5.7L, 5.8L (1986-1993)



18-3766
SHIFT CRADLE
 Replaces: 334163
 For: V-4/V-6, Cobra, Stringer



18-3610
RETAINER NUT
 Replaces: 911752
 Fits: OMC Cobra (1986-93) without cone clutch



18-3768
COVER NUT
 Replaces: 911751
 For: Cobra Drives 115 (1994-97), 232 (1987-90), 252 (1986) 262 (1989), 302 (1987)



18-1500
INTAKE WATER SCREEN
 Replaces: 337778
 For: 100, 120, 125, 140, 150, 175, 200, 225 (1993) (OMC Cobra & V6)



18-4750
COVER ASSEMBLY
 Replaces: 983967
 Fits: 2.3L (1987-90), 2.5L (1986), 2.6L (1989), 3.0L (1986-93), 4.3L (1986-93), 5.0L (1986-94), 5.7L (1986-92), 5.8L (1989-93), 7.4L (1988)



18-1714
CLUTCH DOG PIN
 Replaces: 313448
 For: 50-85, 100, 135, 140, 150, 175, 200, 235 (1969-82) (OMC Stringer drive)



**18-2399
CLUTCH DOG**
Replaces: 324369
For: V-4 & V-6



**18-4222
THRUST WASHER**
Replaces: 318841



**18-4223
THRUST WASHER**
Replaces: 333592



**18-4228
PROP SPACER**
Replaces: 315810



**18-4194
PROP SPACER**
Replaces: 3852350
For: 1994 King Cobra Lower Units



**18-4231
PROP SPACER**
Replaces: 320570

PKG. OF 5



**18-3705
18-3705-9①
PROP NUT**
Replaces: 314503



**18-3708-1
PROP NUT & KEEPER**
Replaces: 398042



**18-3730
LOCK NUT**
Replaces: 3852648
For: Cobra & King Cobra 1987-94

② **18-3733D** 



**18-3733
PROP NUT KIT**
For: SX Cobra

② **18-3715D** 



**18-3715
PROP NUT KIT**
— CONTAINS —

Part #	O.E. #	Description
18-3708-1	398042	Prop Nut/Keeper
18-3741	309955	Cotter Pin
18-4231	320570	Prop Spacer

② **18-3716D** 



**18-3716
PROP NUT KIT**
Replaces: 175267

— CONTAINS —

Part #	O.E. #	Description
18-3705	314503	Prop Nut
18-3742	314502	Cotter Pin
18-4238	315810	Prop Spacer



**18-4444
PROP WRENCH**
FOR ALL COBRA



**18-2156
TILT SHAFT**
Replaces: 980183
I/O 1964-86
EXCEPT COBRA

PKG. OF 10





COTTER PINS

18-3741		18-3742
18-3741-9①		18-3742-9①
	Replaces:	
309955		314502

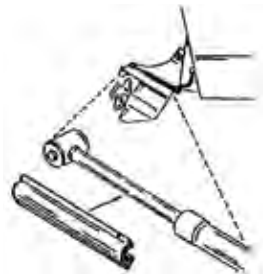

**18-9098
TRAILERING CLIPS**
Replaces: 174448
Set of 2
For all Cobra Stern Drives





APPLICATION BEGINS ON NEXT PAGE

① Priced per Package

② Items ending in "D" are Display Packaged - Regular number is Non-Display

NUT/SPACER/WASHER/COTTER PIN/PROP NUT KIT APPLICATION

Model	Year	Nut	Spacer	Washer	Cotter Pin	Prop Nut Kit	Model	Year	Nut	Spacer	Washer	Cotter Pin	Prop Nut Kit
120	1978-81	18-3705	18-4228	18-4222	18-3742	18-3716	460	1989-90	18-3708-1	18-4231	18-4223	18-3741	18-3715
140	1978-81	18-3705	18-4228	18-4222	18-3742	18-3716	502	1992	18-3708-1	18-4231	18-4223	18-3741	18-3715
185	1978-80	18-3708-1	18-4231	18-4223	18-3741	18-3715	2.3	1987-90	18-3705	18-4228	18-4222	18-3742	18-3716
200	1979-81	18-3708-1	18-4231	18-4223	18-3741	18-3715	2.5	1982-86	18-3705	18-4228	18-4222	18-3742	18-3716
225	1978	18-3708-1	18-4231	18-4223	18-3741	18-3715	3	1982-89	18-3705	18-4228	18-4222	18-3742	18-3716
230	1979	18-3708-1	18-4231	18-4223	18-3741	18-3715	3	1990-92	18-3708-1	18-4231	18-4223	18-3741	18-3715
240	1978	18-3708-1	18-4231	18-4223	18-3741	18-3715	3.8	1981-85	18-3708-1	18-4231	18-4223	18-3741	18-3715
260	1979-81	18-3708-1	18-4231	18-4223	18-3741	18-3715	4.3	1985-92	18-3708-1	18-4231	18-4223	18-3741	18-3715
262	1987-89	18-3708-1	18-4231	18-4223	18-3741	18-3715	5	1982-92	18-3708-1	18-4231	18-4223	18-3741	18-3715
350	1988-91	18-3708-1	18-4231	18-4223	18-3741	18-3715	5.7	1979-92	18-3708-1	18-4231	18-4223	18-3741	18-3715
351	1992	18-3708-1	18-4231	18-4223	18-3741	18-3715	5.8	1989-92	18-3708-1	18-4231	18-4223	18-3741	18-3715
454	1990-92	18-3708-1	18-4231	18-4223	18-3741	18-3715	7.5	1987	18-3708-1	18-4231	18-4223	18-3741	18-3715

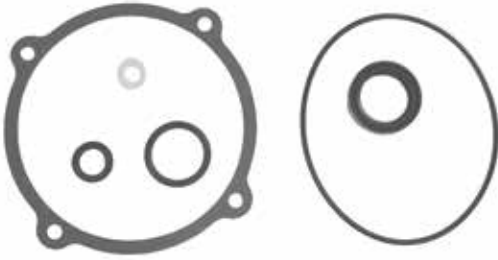

18-2698
CLUTCH HOUSING SEAL KIT
Fits: All models 1977 & below

— CONTAINS —

Part #	Desc.	O.E. #	Qty.
18-7114	O-RING	302540	1
18-7400	O-RING	908194	1
18-7952	OIL SEAL	911019	1
18-2863	GASKET, COVER	308799	1
18-4248	GASKET, OIL DRAIN	311598	1
18-0939	GASKET, DIPSTICK	315189	1

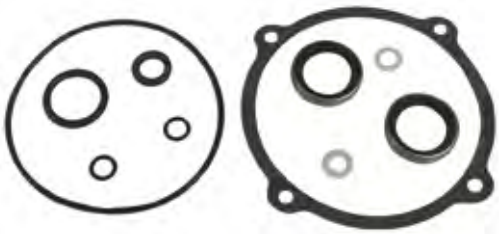

18-8360
CLUTCH HOUSING SEAL KIT
Fits: All models 1978 & above

— CONTAINS —

Part #	Desc.	O.E. #	Qty.
18-2060	OIL SEAL	321467	2
18-7114	O-RING	302540	1
18-7168	O-RING	202893	2
18-7400	O-RING	908194	1
18-2863	GASKET, COVER	308799	1
18-4248	GASKET, OIL DRAIN	311598	2
18-0939	GASKET, DIPSTICK	315189	1

HP	Year	Clutch Pack Seal Kit	HP	Year	Clutch Pack Seal Kit	HP	Year	Clutch Pack Seal Kit	HP	Year	Clutch Pack Seal Kit
80	1968-1969	18-2698	140	1980-1981	18-8360 ^③	190	1974-1977	18-2698	230	1980-1981	18-8360 ^②
90	All	18-2698	3.0L	1982-1985	18-8360	200	1966-1968	18-2698	235	All	18-2698
100	1972-1973	18-2698	155	1967-1972	18-2698	200	1979-1980	18-2698 ^①	240	1978	18-2698
120	1965-1978	18-2698	165	1972-1976	18-2698	200	1980-1981	18-8360 ^②	245	1972-1975	18-2698
120	1979-1980	18-2698 ^①	3.8L	1981-1983	18-8360	5.0L	1982-1985	18-8360	250	1979	18-2698
120	1980-1985	18-8360 ^③	170	1974	18-2698	210	1968-1970	18-2698	260	1979-1980	18-2698 ^①
2.5L	1982-1985	18-8360	175	1975-1977	18-2698	215	1971	18-2698	260	1980-1981	18-8360 ^②
140	1973-1978	18-2698	185	1967-1968	18-2698	225	All	18-2698	5.7L	1982-1985	18-8360
140	1979-1980	18-2698 ^①	185	1978	18-2698	230	1979-1980	18-2698 ^①			

① 1980 Models with the "C" suffix ② 1980 Models with "K" or "U" suffix ③ 1980 Models with "C1" suffix

Zinc is for saltwater only applications.
Magnesium is for fresh water only applications.
Aluminum is for brackish water, or if boat is used in both fresh and salt environments.



⑤ 18-6019
ANODE
Replaces: 982277, 982438
For intermediate housing on Stringer Drive models



⑤ 18-6020
ANODE
Replaces: 976669
For Stringer Drive models with central grounding point on boat hull



⑤ 18-6024
④ 18-6024A
ANODE
Replaces: 393023, 436745
(1982-87) For use on gearcases

④ Aluminum ⑤ Zinc

 <p>⑤ 18-6025 ANODE Replaces: 433458, 398331</p>	 <p>③ 18-6027 ANODE Replaces: 392123 For exhaust housing, V4 & V6 (1983-90)</p>	 <p>③ 18-6028 ① 18-6028A ② 18-6102 ANODE Replaces: 984513, 3853818, 3855412 For use on Gearcases: 2.3L (1987-90), 2.6L/3.5L/4.6L (1989), 3.0L /4.3L/5.0L/5.8L (1987-93), 5.7L (1987-92), 7.4L (1987-88)</p>
 <p>③ 18-6029 ANODE Replaces: 397768</p>	 <p>③ 18-6095 ① 18-6095A ANODE Replaces: 431708 For use on gearcases (1988-90)</p>	 <p>③ 18-6101 ANODE Replaces: 983494 For: Cobra Lower Unit (1987) 2.5, 3.0, 4.3, 5.0, 5.7</p>
 <p>③ 18-6103 ① 18-6103A ANODE Replaces: 984547 For use on Transom Mounts: 2.3L/3.0L (1987-89), 2.6L (1989)</p>	 <p>③ 18-6155Z ANODE KIT For: Cobra Drives except King Cobra</p>	<p>PKG. OF 5</p>  <p>18-3722 18-3722-9④ STAINLESS STEEL LOCKNUT Replaces: 121731 (1/4"—28)</p>
 <p>18-2454 DRAIN PLUG Replaces: 3854539 3/8" - 16 thread Uses O-ring 18-7145 For: Cobra SX drives</p>	 <p>18-2138 PIVOT PIN BEARING Replaces: 911787 COBRA (2 per Drive)</p>	 <p>18-7634 TRIM SENDER Replaces: 984748 Fits: OMC Cobra</p>

① Aluminum ② Magnesium ③ Zinc ④ Priced per Package



18-2663
LOWER UNIT
SEAL KIT
 Replaces: 981797
 100-245 Stringer Unit (1968-77)

— CONTAINS —

Part #	Desc.	O.E. #	Qty.
18-0168	Grommet	908594	1
18-2012	Oil Seal	310599	4
18-2020	Oil Seal	310649	1
18-2058	Oil Seal	313353	2
18-2851	Swivel Bearing To Lower Gear Case Gsk.	313368	1
18-4248	Washer	311598	2
18-7120	O-Ring	307853, 322598	4
18-7129	O-Ring	314491	1
18-7135	O-Ring	310584	1
18-7167	O-Ring	310414	1



18-2664
LOWER UNIT
SEAL KIT
 Replaces: 982947
 4 cyl (400) Stringer Unit (1978-86)

— CONTAINS —

Part #	Desc.	O.E. #	Qty.
18-0110	Shift Housing Gasket	324670	1
18-3133	Housing Screw	908158	2
18-0188	Washer	909748	1
18-2020	Oil Seal	310649	1
18-2058	Oil Seal	313353	2
18-2060	Oil Seal	321467	2
18-3722	Locknut	121731	4
18-4248	Washer	311598	2
18-7101	O-Ring	305739	1
18-7102	O-Ring	307450	1
18-7120	O-Ring	307853, 322598	1
18-7127	O-Ring	313446	1
18-7130	O-Ring	314728	1
18-7178	O-Ring	320140	1
18-7404	O-Ring	909747	1
18-7475	Quad Ring	332583	4
18-7168	O-Ring	202893	1
18-7409	O-Ring	911871	2
18-2001	Oil Seal	330137	2
18-7479	O-Ring	—	1
18-3153	S.S. Bolt	908158	2



18-2665
LOWER UNIT
SEAL KIT
 Replaces: 982946
 V6,V8 (800) Stringer Unit (1978-86)

— CONTAINS —

Part #	Desc.	O.E. #	Qty.
18-0110	Shift Housing Gasket	324670	1
18-3133	Housing Screw	908158	2
18-0188	Washer	909748	1
18-2002	Oil Seal	320862	2
18-2020	Oil Seal	310649	1
18-2058	Oil Seal	313353	2
18-2060	Oil Seal	321467	2
18-2911	Swivel Bearing Housing Gasket	910236	1
18-3722	Locknut	121731	6
18-4248	Washer	311598	2
18-7101	O-Ring	305739	1
18-7102	O-Ring	307450	1
18-7120	O-Ring	307853, 322598	1
18-7130	O-Ring	314728	1
18-7142	O-Ring	322119	1
18-7178	O-Ring	320140	1
18-7403	O-Ring	909316	2
18-7404	O-Ring	909747	1
18-7475	Quad Ring	332583	4
18-7168	O-Ring	202893	1
18-7479	O-Ring	—	1
18-3153	S.S. Bolt	908158	2



18-2666
UPPER UNIT SEAL KIT
 Replaces: 981799
 100-245 Stringer Unit (1968-72)

— CONTAINS —

Part #	Desc.	O.E. #	Qty.
18-0939	Upper Gearcase Gasket	315189	1
18-2073	Oil Seal	981268	4
18-3111	Rubber Seal	907774	1
18-4248	Washer	311598	2
18-7103	O-Ring	308624	4
18-7107	O-Ring	313175	1
18-7121	O-Ring	308621	1
18-7134	O-Ring	303059	1
18-7146	O-Ring	554545	1
18-7173	O-Ring	910582	1
18-7198	O-Ring	308626	2
18-7158	O-Ring	310585, 310967	1
18-7172	O-Ring	553126	1

— CONTAINS —

Part #	Desc.	O.E. #	Qty.
18-0939	Upper Gearcase Gasket	315189	1
18-2072	Oil Seal	0765461	2
18-2073	Oil Seal	981268	2
18-3111	Rubber Seal	907774	1
18-3725	Locknut	908064	1
18-4248	Washer	311598	2
18-4251	Plug	908062	1
18-7107	O-Ring	313175	1
18-7114	O-Ring	302540	1
18-7121	O-Ring	308621	1
18-7129	O-Ring	314491	1
18-7477	Quad Ring	909048	1
18-7168	O-Ring	202893	1
18-7172	O-Ring	553126	1
18-7173	O-Ring	910582, 310327	1



18-2667
UPPER UNIT SEAL KIT
 Replaces: 982949
 All Stringer Unit (1973-86)

— CONTAINS —

Part #	Desc.	O.E. #	Qty.
18-0917	Tilt Motor Gasket	311508	1
18-0923	Seal Gasket	313244	2
18-0939	Upper Gearcase Gasket	315189	1
18-0949	Trunion Cap Gasket	316499	2
18-2004	Oil Seal	—	1
18-2016	Oil Seal	0764337	2
18-2066	Oil Seal	911019	1
18-2071	Oil Seal	981195	2
18-3725	Locknut	908064	1
18-4248	Washer	311598	1
18-4251	Plug	908062	1
18-7114	O-Ring	302540	1
18-7162	O-Ring	302337	1
18-7400	O-Ring	908194	1
18-7401	O-Ring	908383	1
18-7198	O-Ring	308626	2
18-2863	Tilt Clutch Cover Gasket	308799	1



18-2669
INTERMEDIATE HOUSING SEAL KIT
 Replaces: 981801
 100-245 Stringer Unit (1973-77)

— CONTAINS —

Part #	Desc.	O.E. #	Qty.
18-0880	Shift Cover Gasket	911878	1
18-0166	Grommet	911705	2
18-0190	Wiper	912157	1
18-4248	Washer	311598	2
18-7127	O-Ring	313446	1
18-7130	O-Ring	314728	1
18-7137	O-Ring	318372	1
18-7138	O-Ring	318717	3
18-7145	O-Ring	333572	2
18-7475	Quad Ring	332584	5
18-2001	Oil Seal	330137	2



18-2671
LOWER UNIT SEAL KIT
 Replaces: 985612
 All 4 cyl. Cobra (1986-89)

— CONTAINS —

Part #	Desc.	O.E. #	Qty.
18-0880	Shift Cover Gasket	911878	1
18-0166	Grommet	911705	2
18-0190	Wiper	912157	1
18-2002	Oil Seal	320862	2
18-4248	Washer	311598	2
18-7130	O-Ring	314728	1
18-7137	O-Ring	318372	1
18-7138	O-Ring	318717	3
18-7142	O-Ring	322119	1
18-7145	O-Ring	333572	2
18-7475	Quad Ring	332584	5
18-0440	Water Passage Gasket	915719	1



18-2672
LOWER UNIT SEAL KIT
 Replaces: 984458, 985613, 439967
 All V6/V8 Cobra (1986-1991)

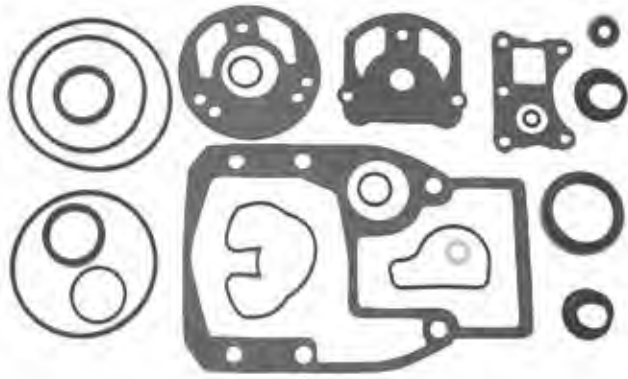

18-2673
UPPER UNIT SEAL KIT
 Replaces: 984459, 986364, 987603
 All Cobra (1986-89)

— CONTAINS —

Part #	Desc.	O.E. #	Qty.
18-0911	Water Pump Base Gasket	911698	1
18-0884	Water Cover Gasket	911733	1
18-0166	Grommet	911705	2
18-2067	Oil Seal	911685	1
18-2068	Oil Seal	3853655	1
18-2541	Rubber Seal	911704	1
18-2916	Water Pump Housing Gasket	911702	1
18-2918	Outdrive Gasket	915840	1
18-2996	Seal	911823	1
18-7107	O-Ring	313175	1
18-7116	O-Ring	303067	1
18-7138	O-Ring	318717	2
18-7153	O-Ring	—	2
18-7169	O-Ring	911686	1
18-7403	O-Ring	909316	1
18-7407	O-Ring	911700	1



18-2674
TRANSOM MOUNT SEAL KIT
 Replaces: 985518, 986423
 All Cobra (1986-89)

— CONTAINS —

Part #	Desc.	O.E. #	Qty.
18-2070	Oil Seal	911795	1
18-2138	Bearing	911787	3
18-2139	Bearing	911794	1
18-2533	Foam Seal	911797	1
18-2918	Outdrive Gasket	915840, 911836	1
18-2996	Seal	911823	1
18-4250	Washer	911820	2
18-7141	O-Ring	321117	12
18-7143	O-Ring	322501	1
18-7162	O-Ring	302337	1
18-7165	O-Ring	304174	1
18-7406	O-Ring	911311	3
18-7408	O-Ring	911718	2
18-7409	O-Ring	911871	1
18-7168	O-Ring	202893	1
18-8349	Seal	3852548	1



18-2783
LOWER UNIT SEAL KIT
 Replaces: 986629
 King Cobra Lower Unit - 1990



18-2791
GEARCASE SEAL KIT
 Replaces: 987251, 3850597
 Fits: 3.0L, 4.3L, 5.0L (1994), 3.2L (1992-93),
 5.7L (1992-94), 7.4L (1992-95), 8.2L (1992-93)

APPLICATION ON NEXT PAGE



SEAL KIT APPLICATION

Model	Year	Lower Gearcase Seal Kit	Upper Gearcase Seal Kit	Intermediate Housing Seal Kit	Transom Mount Seal Kit	Model	Year	Lower Gearcase Seal Kit	Upper Gearcase Seal Kit	Intermediate Housing Seal Kit	Transom Mount Seal Kit
2.3	1987-90	18-2671	18-2673	N/A	18-2674	165	1972	18-2663	18-2666	18-2668	N/A
2.5 ①	1982-86	18-2664	18-2667	N/A	N/A	165	1973-76	18-2663	18-2667	18-2669	N/A
2.5 ②	1986	18-2671	18-2673	N/A	18-2674	170	1974	18-2663	18-2667	18-2669	N/A
3 ①	1982-86	18-2664	18-2667	N/A	N/A	175	1975-77	18-2663	18-2667	18-2669	N/A
3 ②	1986-91	18-2671	18-2667	N/A	N/A	185	1968	18-2663	18-2666	18-2668	N/A
4.3 ①	1985-86	18-2665	18-2667	N/A	N/A	185	1978-80	18-2665	18-2667	N/A	N/A
4.3 ②	1986-91	18-2672	18-2673	N/A	18-2674	190	1974-77	18-2663	18-2667	18-2669	N/A
3.8	1981-86	18-2665	18-2667	N/A	N/A	200	1968	18-2663	18-2666	18-2668	N/A
5 ①	1982-86	18-2665	18-2667	N/A	N/A	200	1979-81	18-2665	18-2667	N/A	N/A
5 ②	1986-91	18-2672	18-2673	N/A	18-2674	210	1968-70	18-2663	18-2666	18-2668	N/A
5.7 ①	1982-86	18-2665	18-2667	N/A	N/A	215	1971	18-2663	18-2666	18-2668	N/A
5.7 ②	1986-89	18-2672	18-2673	N/A	18-2674	225	1972	18-2663	18-2666	18-2668	N/A
5.7 ③	1990-91	18-2672	18-2673	N/A	18-2674	225	1973-76	18-2663	18-2667	18-2669	N/A
5.8	1989-90	18-2672	18-2673	N/A	18-2674	225	1978	18-2665	18-2667	N/A	N/A
7.5	1987	—	18-2673	N/A	18-2674	230	1979-81	18-2665	18-2667	N/A	N/A
80	1969	18-2663	18-2666	18-2668	N/A	235	1971	18-2663	18-2666	18-2668	N/A
90	1970	18-2663	18-2666	18-2668	N/A	235	1975-77	18-2663	18-2667	18-2669	N/A
100	1972	18-2663	18-2666	18-2668	N/A	240	1978	18-2665	18-2667	N/A	N/A
100	1973	18-2663	18-2667	18-2669	N/A	245	1972	18-2663	18-2666	18-2668	N/A
120	1968-72	18-2663	18-2666	18-2668	N/A	245	1973-75	18-2663	18-2667	18-2669	N/A
120	1973-77	18-2663	18-2667	18-2669	N/A	250	1979	18-2665	18-2667	N/A	N/A
120	1978-81	18-2664	18-2667	N/A	N/A	260	1979-81	18-2665	18-2667	N/A	N/A
140	1973-77	18-2663	18-2667	18-2669	N/A	262	1989	18-2672	18-2673	N/A	18-2674
140	1978-81	18-2664	18-2667	N/A	N/A	350	1988-89	18-2672	18-2673	N/A	18-2674
155	1968-72	18-2663	18-2666	18-2668	N/A	460	1988-89	—	18-2673	N/A	18-2674

① Except Cobra ② Cobra ③ Except L.E. N/A Not Applicable

OIL SEALS



Part #	O.E. #	Shaft Size	Dimensions (in)		Part #	O.E. #	Shaft Size	Dimensions (in)	
			O.D.	Width				O.D.	Width
18-0542	321831, 315288	0.750	1.253	0.186	18-2061	329922	0.822	1.375	0.195
18-0543	321895, 313507	1.540	1.926	0.243	18-2062	329923	0.875	1.375	0.207
					18-2063	330327	0.625	1.124	0.188
18-0559	332585	0.285	0.357	0.940	18-2064	332205	0.730	1.130	0.194
					18-2065	332261	0.625	1.375	0.195
18-2000	309989	1.375	2.000	0.313	18-2066	911019	1.000	1.375	0.435
18-2001	330137	1.125	1.624	0.250	18-2067	911685	2.000	2.509	0.315
18-2002	320862	1.188	1.692	0.250	18-2068	3853655	0.500	0.905	0.250
18-2005	313284	0.625	1.128	0.250	18-2068	915702	0.500	0.905	0.250
18-2012	310599	1.000	1.499	0.250	18-2068	916058	0.500	0.905	0.250
18-2016	0764337	1.187	1.875	0.250	18-2068	3853655	0.500	0.905	0.200
18-2018	0767970	1.000	1.375	0.250	18-2071	908065, 908852	1.500	2.125	0.250
18-2020	310649	2.500	3.000	0.250	18-2072	0765461, 908894, 908070	1.750	2.502	0.250
18-2022	303345	0.554	1.000	0.375	18-2073	907967, 981268	1.625	2.502	0.250
18-2023	313282	0.554	1.062	0.312	18-8349	3852548	1.375	2.186	0.500
18-2024	314167	0.425	0.937	0.312					
18-2025	318972	0.500	0.875	0.250					
18-2027	305306, 321459	0.625	1.125	0.250					
18-2030	321786	0.625	1.125	0.188					
18-2031	321787	0.625	1.125	0.312					
18-2033	321928	0.625	1.375	0.250					
18-2034	324639	0.437	0.937	0.188					
18-2058	313353	1.938	2.438	0.250					
18-2059	318223	0.750	1.126	0.200					
18-2060	321467	1.000	1.375	0.250					



UPPER GEARCASE (Cobra)				
ENGINE	YEAR	OIL SEAL	DESC.	QTY
262 - 460	1988-89	18-2067	BC	1
262 - 460	1988-90	18-2068	WPS	1
2.3 - 7.5	1986-90	18-2068	WPS	1
2.3 - 7.5	① 1986-90	18-2067	BC	1

① 5.7 '90 574 AMPWS, ARPWS
BC Bearing Carrier Seal
WPS Water Pump Seal

LOWER GEARCASE (Stringer)				
ENGINE	YEAR	OIL SEAL	DESC.	QTY
80/90	1968-71	18-2066	BR,L	2
80/90	1968-71	18-2066	PS	2
88/90	1964-68	18-2012	BR	1
80 - 260	1968-81	18-2020	BR,U	1
80 - 260	1968-81	18-2058	BR,M	2
110 - 200	① 1964-67	18-2012	BR	2
110 - 245	① 1964-77	18-2012	PS	2
110/120	② 1964-67	18-2012	BR	1
120 - 245	1968-77	18-2012	BR,L	2
120 - 260	1978-81	18-2060	BR,L	2
120/140	1978-81	18-2001	PS	2
155	③ 1967	18-2058	BR,M	2
155	③ 1967	18-2020	BR,U	1
185 - 260	1978-81	18-2002	PS	2
210 - 260	④ 1972-75	18-2066	IH	1
230/260	④ 1976	18-2060	IH	1
305/350/454	④ 1977-78	18-2060	IH	1
2.5/3.0	1982-86	18-2001	PS	2
2.5 - 5.7	1981-86	18-2020	BR,U	1
2.5 - 5.7	1981-86	18-2058	BR,M	2
2.5 - 5.7	1981-86	18-2060	BR,L	2
3.8 - 5.7	1981-86	18-2002	PS	2

① 110, 120 HP '64-67 Hvy. Duty Dr.
 ② Standard Drive
 ③ HU, HUE 16 C Models
 ④ Inboard
BR Driveshaft Bearing Retainer Seal
BR,U Driveshaft Bearing Retainer Upper Seal
BR,M Driveshaft Bearing Retainer Middle Seal
BR,L Driveshaft Bearing Retainer Lower Seal
IH Impeller Housing Seal
PS Prop Shaft Seal

UPPER GEARCASE (Stringer)				
ENGINE	YEAR	OIL SEAL	DESC.	QTY
80 - 245	1968-72	18-2073	BGS	1
80 - 260	1969-81	18-2073	IH	2
88 - 200	1964-66	18-2000	BGS	1
90	③ 1967	18-2000	BGS	1
90	④ 1967	18-2073	BGS	1
100 - 245	1972-73	18-2073	BGS	1
100 - 260	1973-81	18-2072	BGS	2
120	① 1967	18-2073	BGS	1
120	② 1967	18-2000	BGS	1
120	① 1967	18-2073	IH	2
120 - 210	1968	18-2073	IH	2
155	1967	18-2073	IH	2
155	⑤ 1967	18-2000	BGS	1
155	1967	18-2073	BGS	1
185	1967	18-2000	BGS	1
200	⑥ 1967	18-2000	BGS	1
200	⑦ 1967	18-2073	IH	2
200	⑦ 1967	18-2073	BGS	1
2.5 - 5.7	1981-86	18-2072	BGS	2
2.5 - 5.7	1981-86	18-2073	IH	2

① CU, CUE 16C Models ⑥ TU, TUE 15S Models
 ② CU15S Models ⑦ TU, TUE 16C Models
 ③ DU, DUE 14D Models **BGS** Ball Gear Shaft Seal
 ④ DU, DUE 15S Models **IH** Impeller Housing Seal
 ⑤ HU, HUE 15S Models

LOWER GEARCASE (Cobra)				
ENGINE	YEAR	OIL SEAL	DESC.	QTY
262 - 460	1988-89	18-2002	PS	2
2.3	1990	18-2001	PS	2
2.3 - 3.0	1986-89	18-2001	PS	2
3	1990	18-2002	PS	2
4.3 - 7.5	1986-90	18-2002	PS	2

PS Prop Shaft Seal

INTERMEDIATE HOUSING (Stringer)				
ENGINE	YEAR	OIL SEAL	DESC.	QTY
80 - 235	1964-71	18-2000	BG,O	1
80 - 245	1964-72	18-2001	BG,I	1
80 - 260	② 1964-80	18-2066	CL	1
100 - 245	1972	18-2000	BG,O	2
100 - 260	1973-79	18-2016	BG,I	1
100 - 260	1973-81	18-2071	BG,O	2
120 - 260	1980-81	18-2016	BG,I	2
120 - 260	① 1980-81	18-2060	CL	2
2.5 - 5.7	1981-86	18-2060	CL	2
2.5 - 5.7	1981-86	18-2016	BG,I	2
2.5 - 5.7	1981-86	18-2071	BG,O	2

CL Clutch
 ① 120, 140 '80C Models/185—260 '80 K&U Models
 ② C Models in '80
BG,I Driveshaft Ball Gear Inner Seal
BG,O Driveshaft Ball Gear Outer Seal



O-RINGS

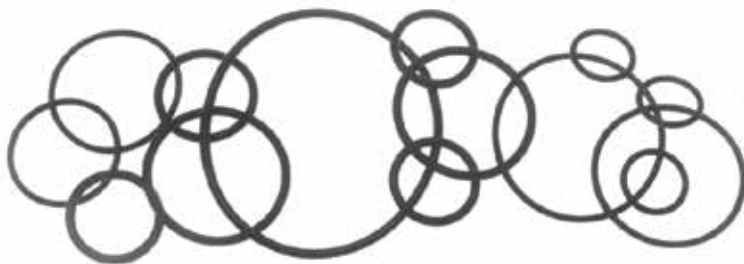

Part #	O.E. #	Dimensions (in)		Part #	O.E. #	Dimensions (in)	
		I.D.	Width			I.D.	Width
18-7100	② ⑤ 301877	.245	.155	18-7150	③ ⑤ 331380	.225	.115
18-7101	② ⑤ 305739	.250	.065	18-7150	③ ⑤ 334913	.225	.115
18-7102	② ⑤ 307450	.430	.065	18-7152	② ⑤ 307082	2.625	.135
18-7103	② ⑤ 308624	.920	.100	18-7153	① 3852565,		
18-7104	② ⑤ 308627	2.210	.135		911851	.0860	.100
18-7105	② ⑤ 311338	.750	.065	18-7155	② ⑤ 305270	1.620	.135
18-7107	② ⑤ 313175	4.750	.135	18-7156	② ⑤ 309731	1.185	.100
18-7108	② ⑤ 313893	2.550	.100	18-7158	② ⑤ 310585	.740	.100
18-7108	② ⑤ 338518	2.550	.100	18-7162	② ⑤ 302337	2.025	.135
18-7109	② ⑤ 317178	.214	.048	18-7164	② ⑤ 302537	1.375	.100
18-7111	① 301824	.197	.113	18-7165	② ⑤ 304174	.500	.065
18-7112	① 302493	1.170	.135	18-7167	② ⑤ 310414	3.625	.135
18-7114	② ⑤ 302540	1.000	.135	18-7168	② ⑤ 202893	.370	.065
18-7115	① 302588	1.735	.135	18-7169	② ⑤ 911686	3.500	.135
18-7116	① 303067	.360	.100	18-7170	① 307239	1.365	.135
18-7117	① 303360	1.060	.135	18-7172	② ⑤ 553126	3.250	.135
18-7118	② ⑤ 305242	.300	.135	18-7173	② ⑤ 310327	1.875	.135
18-7120	① 307853	.215	.065	18-7174	② ⑤ 326649	.620	.100
18-7120	① 332598	.215	.065	18-7178	② ⑤ 320140	.920	.135
18-7121	① 308621	3.100	.135	18-7180	② ⑤ 303347	.445	.090
18-7123	① 308876	2.235	.100	18-7198	② ⑤ 308626	1.430	.100
18-7126	① 313340	1.690	.100	18-7400	② ⑤ 908194	4.000	.100
18-7127	① 313446	3.315	.135	18-7401	② ⑤ 908383	2.485	.100
18-7128	① 313754	1.835	.100	18-7403	② ⑤ 909316	1.500	.100
18-7129	② ⑤ 314491	.970	.065	18-7404	② ⑤ 909747	.300	.100
18-7130	① 314728	2.125	.100	18-7406	② ⑤ 911311	0.250	.065
18-7133	② ⑤ 305123	3.780	.135	18-7407	② ⑤ 911700	4.125	.135
18-7134	② ⑤ 303059	.500	.100	18-7407	② ⑤ 3852531	4.125	.135
18-7135	① 310584	.750	.135	18-7408	② ⑤ 911718	1.060	.100
18-7137	② ⑤ 318372	0.320	.155	18-7409	② ⑤ 911871	1.175	.100
18-7138	② ⑤ 318717	1.500	.210	18-7413	② ⑤ 303191	.301	.070
18-7139	② ⑤ 319085	1.080	.210	18-7416	② ⑤ 329380	.612	.103
18-7140	② ⑤ 320303	2.750	.135	18-7417	② ⑤ 329381	.362	.103
18-7141	② ⑤ 321117	.180	.065	18-7418	② ⑤ 326741	4.484	.139
18-7142	② ⑤ 322119	3.940	.135	18-7440-1	④ 301967	.799	.103
18-7143	② ⑤ 322501, 331188	1.310	.100	18-7457	① 319662	1.799	.103
18-7144	② ⑤ 326849	4.250	.135	18-7461	① 308458	1.612	.103
18-7145	② ⑤ 333572	.250	.100	18-7475	② ⑤ 332584	.250	.065
18-7146	② ⑤ 554545	1.120	.100	18-7477	② ⑤ 909048	.480	.100
18-7150	③ ⑤ 303598	.225	.115	18-7510	① 321163	2.750	.070

① Pkg. of 1 ② Pkg. of 5 ③ Pkg. of 10 ④ Indicates Quad Rings rather than O-Rings

TRANSOM MOUNT (Cobra)

TRANSOM MOUNT (Cobra) (Cont.)

ENGINE	YEAR	O-RING	DESC.	QTY.	ENGINE	YEAR	O-RING	DESC.	QTY.
262 - 460	1988-89	18-7165	SCS	1	2.3 - 7.5	① 1986-90	18-7165	SCS	1
262 - 460	1988-89	18-7408	NP	2	2.3 - 7.5	① 1986-90	18-7409	SC	1
262 - 460	1988-89	18-7409	SC	1	2.3 - 7.5	1986-90	18-7143	MB	1
262 - 460	1988-89	18-7406	PL	1					
262 - 460	1988-89	18-7168	BC	1					
262 - 460	1988-90	18-7162	UG	1					
262 - 460	1988-90	18-7143	MB	1					
2.3 - 7.5	① 1986-90	18-7168	BC	1					
2.3 - 7.5	1986-90	18-7162	UG	1					
2.3 - 7.5	① 1986-90	18-7406	PL	1					
2.3 - 7.5	① 1986-90	18-7408	NP	2					

- ① 5.7 '90 574 AMPWS, ARPWS
- BC Bell Crank Seal
- MB Manifold Block Seal
- UG Upper Gimbal Seal
- SCS Shift Cable Seal
- PL Plug Seal
- NP Nipple Seal
- SC Sleeve and Connector Seal

⑤ This product is priced per piece. To order priced per package, please add -9 to the part number.

UPPER GEARCASE (Cobra)				
ENGINE	YEAR	O-RING	DESC.	QTY
262 - 460	1988-89	18-7403	A,S	1
262 - 460	1988-89	18-7107	GHC	1
262 - 460	1988-89	18-7407	A,L	1
262 - 460	1988-90	18-7169	BC	1
350 - 460	1990	18-7116	OPF	1
350 - 460	1990	18-7407	BC	1
350 - 460	1990	18-7406	WDP	1
370	1988	18-7407	AB	1
460	1990	18-7407	BC	1
2.3 - 5.8	1990	18-7116	OPF	1
2.3 - 7.5	① 1986-90	18-7107	GHC	1
2.3 - 7.5	① 1986-90	18-7407	A,L	1
2.3 - 7.5	1986-90	18-7169	BC	1
2.3 - 7.5	① 1986-90	18-7403	A,S	1
5.7	② 1990	18-7406	WDP	1
5.7	② 1990	18-7407	BC	1

- ① 5.7 '90 574 AMPWS, ARPWS
- ② 574 PEPWS
- GHC** Gear Hsg. Cover Seal
- OPF** Oil Fill Plug Seal
- BC** Bearing Carrier Seal
- A,S** Adaptor, Small Seal
- A,L** Adaptor, Large Seal
- WDP** Water Drain Plug Seal
- AB** Anchor Block Seal

LOWER GEARCASE (Cobra)				
ENGINE	YEAR	O-RING	DESC.	QTY
262/350	1988-89	18-7475	PBHS	4
262/350	1988-89	18-7142	PBH	1
262 - 460	1988-89	18-7130	DS B	1
262 - 460	1988-89	18-7475	BSS	1
262 - 460	1988-89	18-7138	DS BH	3
262 - 460	1988-89	18-7137	SR	1
350 - 460	1990	18-7145	PL	1
370	1988	18-7130	SL	2
370/460	1988-89	18-7145	D&F S	2
2.3	1987	18-7145	D&F S	2
2.3	1990	18-7127	PBH	1
2.3 - 3.0	1986-89	18-7127	PBH	1
2.3/3.0	1988-90	18-7145	D&F S	2
2.5 - 5.7	1986	18-7145	D&F S	2
2.3 - 5.8	① 1986-90	18-7475	PBHS	4
2.3 - 7.5	① 1986-90	18-7475	BSS	1
2.3 - 7.5	① 1986-90	18-7138	DS BH	3
2.3 - 7.5	① 1986-90	18-7137	SR	1
2.3 - 7.5	① 1986-90	18-7130	DS B	1
3.0 - 5.8	① 1990	18-7142	PBH	1
4.3 - 5.8	1989-89	18-7142	PBH	1
5.7	② 1990	18-7145	PLUG	1

- ① 5.7 '90 574 AMPWS, ARPWS
- ② 574 PEPWS
- BSS** Bearing Setscrew Seal
- DS BH** Driveshaft Bearing Hsg. Seal
- DS B** Driveshaft Bearing Seal
- D&F S** Drain & Fill Screw Seal
- PBH** Prop Bearing Hsg. Seal
- PBHS** Prop Bearing Hsg. Screw Seal
- PL** Plug Seal
- SR** Shift Rod Seal
- SL** Sleeve Seal

POWER TILT AND TRIM (Cobra)				
ENGINE	YEAR	O-RING	DESC.	QTY
262 - 460	1988-90	18-7141	OL	12
262 - 460	1988-90	18-7102	PL	1
350 - 460	1988	18-7174	VSH	1
350 - 460	1988	18-7168	VS	4
350 - 460	1988	18-7174	VA,L	2
350 - 460	1988	18-7165	VA,S	2
2.3 - 7.5	1986-88	18-7174	VSH	1
2.3 - 7.5	1986-88	18-7168	VS	4
2.3 - 7.5	1986-88	18-7174	VA,L	2
2.3 - 7.5	1986-88	18-7165	VA,S	2
2.3-7.5	1986-90	18-7102	PL	1
2.3-7.5	1986-90	18-7141	OL	12

- PL** Plug Seal
- VS** Valve Seat Assy. Seal
- VA,L** Valve Assy., Large Seal
- VA,S** Valve Assy., Small Seal
- VSH** Valve Seat Hsg. Seal
- OL** Oil Line Seal

OIL AND COOLING SYSTEM (Cobra)				
ENGINE	YEAR	O-RING	DESC.	QTY
262/454	1989-90	18-7135	AR	1
262 - 460	1988-90	18-7116	ODF	1
350/460	1988-90	18-7135	AR	1
370	1988	18-7162	THERM	1
2.3 - 5.8	1988-90	18-7116	ODF	1
4.3	① 1990	18-7135	AR	1
7.5	1987	18-7135	AR	1

- ① V-4 Only
- ODF** Oil Drain Fitting Seal
- AR** Adapter Retainer Seal
- THERM** Thermostat Seal

POWERHEAD (Stringer)				
ENGINE	YEAR	O-RING	DESC.	QTY
80/90	1969-71	18-7108	WP	1
88	1964	18-7133	CCH	3
88/90	1964-68	18-7120	CCHS	4
90	1965-68	18-7133	CCH	4
120/140	1977-80	18-7114	CP	1
120 - 235	1976	18-7114	CP	1

- WP** Water Pump Seal
- CCH** Crankcase Head Seal
- CCHS** Crankcase Head Screw Seal
- CP** Coupling Seal

INTERMEDIATE HOUSING (Stringer)				
ENGINE	YEAR	O-RING	DESC.	QTY
80	1968	18-7162	SL	1
80 - 90	1964-68	18-7174	WT	1
80 - 210	1964-70	18-7123	BGR	1
80 - 245	① 1964-72	18-7174	PS	1
80 - 260	1964-81	18-7198	COV	2
80 - 260	1964-81	18-7114	WR	1
80 - 260	1969-81	18-7162	SL	1
88	1964	18-7104	TH	1
88	1964	18-7174	TC	1

INTERMEDIATE HOUSING (Stringer) (Cont.)				
ENGINE	YEAR	O-RING	DESC.	QTY
90 - 235	1970-71	18-7158	DS	1
90 - 235	② 1971	18-7123	BGR	1
100 - 260	1973-81	18-7401	BGR	1
100 - 260	1973-81	18-7400	TUC	1
120	③ 1967	18-7162	SL	1
120 - 210	1968	18-7162	SL	1
120/140	1981	18-7168	FS	3
155	④ 1967	18-7162	SL	1
2.5 - 5.7	1981-86	18-7400	TUC	1
2.5 - 5.7	1981-86	18-7198	COV	2
2.5 - 5.7	1981-86	18-7114	WR	1
2.5 - 5.7	1981-86	18-7401	BGR	1
2.5 - 5.7	1981-86	18-7162	SL	1
2.5 - 5.7	1982	18-7168	FS	3

- ① Rope or Pull-Pull Steering Models
- ② All 90/120, 155, 210 EX Models/235 XUFM20S prior to S/N 202880 and 235 XUFM20S prior to S/N 204600
- ③ CU, CUE 16C
- ④ 120, 155, 215, 20D Models/235 XUFR20S S/N 202880 & up and 235 XUFM20S S/N 204600 & up 235 20D all Models
- COV** Pivot Cap Cover Seal
- BGR** Ball Gear Retainer Seal
- DS** Driveshaft to Hsg. Seal
- TC** Driveshaft Tube Cover Seal
- TH** Driveshaft Tube to Hsg.
- FS** Fill Screw Seal
- PS** Pulley Shaft
- SL** Sleeve to Hsg. Seal
- TUC** Tilt Unit Cover Seal
- WT** Water Tube Seal
- WR** Worm Gear Retainer Seal

UPPER GEARCASE (Stringer)

ENGINE	YEAR	O-RING	DESC.	QTY
80 - 90	1968-71	18-7158	BG	1
80 - 90	1964-68	18-7174	IH	1
80 - 245	① 1964-72	18-7103	WG	1
80 - 245	① 1964-74	18-7134	G	1
80 - 260	1964-81	18-7172	IH	1
80 - 260	1964-81	18-7121	BGR	1
80 - 260	1968-80	18-7173	WW	1
80 - 260	② 1968-81	18-7107	WW	1
90	③ 1967	18-7107	WW	1
90 - 200	1964-67	18-7128	CAP	1
90 - 200	1965-67	18-7173	WW	2
90 - 245	④ 1967-72	18-7146	BG	1
100 - 245	1973-75	18-7114	WS	1
100 - 260	1973-81	18-7129	DS IH	1
110 - 120	⑤ 1964-67	18-7158	IH	1
110 - 120	⑥ 1964-67	18-7174	IH	1
120 - 200	⑦ 1967	18-7107	WW	1
120 - 235	1968-71	18-7158	IH	1
120 - 260	1975-81	18-7477	G	1
150 - 210	1964-67	18-7158	IH	1
2.5/3.0	1982	18-7168	OP	1
2.5 - 5.7	1981-86	18-7477	G	1
2.5 - 5.7	1981-86	18-7172	IH	1
2.5 - 5.7	1981-86	18-7107	WW	1
2.5 - 5.7	1981-86	18-7121	BGR	1
2.5 - 5.7	1981-86	18-7129	DS IH	1

UPPER GEARCASE (Stringer) (Cont.)

- ① Rope or Pull-Pull Steering Models
- ② 155 HP 1968 HU, HUE 16C
- ③ DU, DUE 15S
- ④ 90 HP '67 DU, DUE 15S/120 and 200 '67 16C Models
- ⑤ Heavy Duty Drive
- ⑥ Standard Gearcase
- ⑦ 16C Models
- BG** Ball Gear Seal
- BGR** Ball Gear Retainer Seal
- DS IH** Driveshaft Impeller Hsg. Seal
- IH** Impeller Hsg. Seal
- CAP** Gear Hsg. Cap Seal
- OP** Oil Plug Seal
- WR** Steering Worm Wheel Retainer Seal
- WS** Steering Worm Wheel Spacer Seal
- WG** Steering Worm Wheel Gear Seal
- WW** Steering Worm Wheel Seal
- G** Gear Seal

LOWER GEARCASE (Stringer)

ENGINE	YEAR	O-RING	DESC.	QTY
80 - 90	1964-69	18-7120	PBH S	4
80 - 90	1964-71	18-7152	PBH	1
80 - 90	1964-71	18-7115	BR	1
80 - 90	1964-71	18-7174	DS	1
88/90	1964-68	18-7173	DSB	2
90 - 245	1970-77	18-7120	PBH S	4
100 - 245	1968-72	18-7135	BR	1
100 - 245	1969-77	18-7167	PBH	1
110/120	② 1964-67	18-7167	PBH	1
110/120	① 1964-67	18-7174	DS	1
110/120	② 1964-67	18-7135	BR	1
110/120	① 1964-67	18-7152	PBH	1
110/120	① 1964-67	18-7173	DSB	2
110/120	① 1964-67	18-7115	BR	1
120	① 1964-67	18-7120	PBH S	4
120/140	1978-81	18-7127	PBH	1
120/140	1978	18-7156	SA,L	2
120 - 235	1977	18-7129	DS	1
120 - 240	1978	18-7178	SA,S	1
120 - 260	1978-81	18-7130	BR	1
120 - 260	1978-81	18-7102	PIN	1
120 - 260	1978-81	18-7109	PBH S	4
120 - 260	1978-81	18-7404	PIN	1
120 - 260	1979-81	18-7120	BSS	1
120 - 260	1981	18-7168	D&F S	1
150 - 200	1964-67	18-7135	BR	1
150 - 210	1964-68	18-7167	PBH	1
185 - 240	1978	18-7403	SA,L	2
185 - 260	1978-81	18-7142	PBH	1
2.5 - 5.7	1981-82	18-7168	D&F S	1
2.5 - 5.7	1981-83	18-7109	PBH S	4
2.5 - 5.7	1981-86	18-7130	BR	1
2.5 - 5.7	1981-86	18-7102	PIN	1
2.5 - 5.7	1981-86	18-7404	PIN	1
2.5 - 5.7	1981-86	18-7120	BSS	1
2.5 - 5.7	1981-86	18-7142	PBH	1
2.5/3.0	1982-86	18-7127	PBH	1
3.8	1981	18-7101	OSV	1

- ① Standard Drive
- ② Heavy Duty Drive
- OSV** Oil Stem Valve Seal
- PIN** Pinion Shaft Seal
- BR** Driveshaft Bearing Retainer Seal
- DS** Driveshaft Seal
- PBH** Prop Bearing Hsg. Seal
- DSB** Driveshaft Bushing Seal
- PBH S** Prop Bearing Hsg. Screw Seal
- D&F S** Drain & Fill Screw Seal
- SA,L** Shift Assy., Large Seal
- SA,S** Shift Assy., Small Seal
- BSS** Bearing Set Screw Seal

TUNE-UP APPLICATION FOR GAS ENGINE MODELS

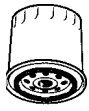

Model No.	Oil Filter	Fuel Filter	Impeller	Drive Belt
MB 10 A	18-7878-1	—	18-3080	—
BB 30	18-7878-1	—	18-3080	—
BB 100	18-7878-1	—	18-3080	—
MB 18	18-7878-1	—	18-3080	—
AQ 60 F	18-7878-1	—	18-3080	—
MB 18 F	18-7878-1	—	18-3080	—
AQ 90	18-7878-1	—	18-3080	—
AQ 95	18-7878-1	—	18-3080	—
AQ 100	18-7878-1	—	18-3080	—
AQ 95A	18-7878-1	—	18-3080	—
AQ 110	18-7878-1	—	18-3080	—
AQ 120	18-7878-1	—	18-3080	—
BB 115 A	18-7878-1	—	18-3080	—
BB 115 B	18-7878-1	—	18-3080	—
BB 115 C	18-7878-1	—	18-3080	—
MB 20 A	18-7878-1	—	18-3080	—
MB 20 B	18-7878-1	—	18-3080	—
MB 20 C	18-7878-1	—	18-3080	—
AQ 115 A	18-7878-1	—	18-3080	—
AQ 115 B	18-7878-1	—	18-3080	—
AQ 130 A	18-7878-1	—	18-3080	—
AQ 130 B	18-7878-1	—	18-3080	—
AQ 130 C	18-7878-1	—	18-3080	—
AQ 130 D	18-7878-1	—	18-3080	—
BB 165 A	18-7878-1	—	18-3075	18-4044
BB 170 A	18-7878-1	—	18-3075	18-4044
BB 170 B	18-7878-1	—	18-3075	18-4044
BB 170 C	18-7878-1	—	18-3075	18-4044
AQ 165 A	18-7878-1	—	18-3075	18-4044
AQ 170 A	18-7878-1	—	18-3075	18-4044
AQ 170 B	18-7878-1	—	18-3075	18-4044
AQ 170 C	18-7878-1	—	18-3075	18-4044
AQ 120 B	18-7878-1	18-7862 18-7858	18-3075	18-4044
AQ 125 A	18-7878-1	18-7862 18-7858	18-3075	18-4044
AQ 125 B	18-7878-1	18-7862 18-7858	18-3075	18-15435
AQ 131 A	18-7878-1	18-7862 18-7858	18-3075	18-15435
AQ 131 B	18-7878-1	18-7862 18-7858	18-3075	18-15435
AQ 131 C	18-7878-1	18-7862 18-7858	18-3075	18-15435
AQ 131 D	18-7878-1	18-7862 18-7858	18-3075	18-15435
230A	18-7878-1	18-7862 18-7858	18-3075	18-15435
230B	18-7878-1	18-7862 18-7858	18-3075	18-4044

Model No.	Oil Filter	Fuel Filter	Impeller	Drive Belt
BB 140 A	18-7878-1	18-7862 18-7858	18-3075	18-4044
AQ 140 A	18-7878-1	18-7862 18-7858	18-3075	18-4044
BB 145 A	18-7878-1	18-7862 18-7858	18-3075	18-4044
AQ 145 A	18-7878-1	18-7862 18-7858	18-3075	18-4044
AQ 145 B	18-7878-1	18-7862 18-7858	18-3075	18-15435
AQ 151 A	18-7878-1	18-7862 18-7858	18-3075	18-15435
AQ 151 B	18-7878-1	18-7862 18-7858	18-3075	18-15435
AQ 151 C	18-7878-1	18-7862 18-7858	18-3075	18-15435
250 A	18-7878-1	18-7862 18-7858	18-3075	18-4044
250 B	18-7878-1	18-7862 18-7858	18-3075	18-4044
AQ 171 A	18-7878-1	18-7862 18-7858	18-3075	18-15435
AQ 171 C	18-7878-1	18-7862 18-7858	18-3075	18-15435
251 A	18-7878-1	18-7862 18-7858	18-3075	18-4044
3.0 GL	18-7824-2	—	18-3060	—
3.0 GS	18-7824-2	—	18-3060	—
AQ 175 A	18-7879-1	18-7862 18-7858	18-3081	18-4046
430 A	18-7879-1	18-7862 18-7858	18-3081	18-4046
430 B	18-7879-1	18-7862 18-7858	18-3081	18-4046
AQ 190A	18-7875	—	18-3061	—
AQ 200 B	18-7824-2	18-7862 18-7858	18-3060	18-4046 Ⓢ
AQ 200 C	18-7824-2	18-7862 18-7858	18-3060	18-4046 Ⓢ
AQ 200 D	18-7824-2	18-7862 18-7858	18-3081	18-4046
AQ 200 F	18-7824-2	18-7862 18-7858	18-3081	18-4046
AQ 205 A	18-7879-1	18-7845 18-7858 18-7845	—	18-4046
431 A	18-7879-1	18-7858	—	18-4046
431 B	18-7879-1	18-7845 18-7858	18-3081	18-4046
432 A	18-7879-1	18-7845 18-7858	18-3081	—
434 A	18-7879-1	18-7845 18-7858	18-3081	—
4.3 GL	18-7879-1	—	18-3060	—

Ⓢ Alternator

TUNE-UP APPLICATION FOR GAS ENGINE MODELS



Model No.	Oil Filter	Fuel Filter	Impeller	Drive Belt
4.3 GS	18-7879-1	—	18-3060	—
4.3 GI	18-7879-1	—	18-3081	—
AQ 211 A	18-7824-2	18-7858	18-3081	18-4046
500 A	18-7824-2	18-7845 18-7858	18-3081	18-4046
500 B	18-7824-2	18-7845 18-7858	18-3081	18-4046
AQ 225 B	18-7824-2	18-7862	18-3060	18-4046 ⓐ
AQ 225 C	18-7824-2	18-7862 18-7858	18-3060	18-4046 ⓐ
AQ 225 D	18-7824-2	18-7862 18-7858	—	18-4046
AQ 225 E	18-7824-2	18-7862 18-7858	—	18-4046
AQ 225 F	18-7824-2	18-7862 18-7858	—	18-4046
BB 225 A	18-7824-2	18-7862 18-7858	18-3081	—
BB 225 B	18-7824-2	18-7862 18-7858	18-3081	18-4046
BB 225 C	18-7824-2	18-7845 18-7858	18-3081	18-4046
AQ 231 A	18-7824-2	18-7845 18-7858	18-3081	18-4046
AQ 231 B	18-7824-2	18-7845 18-7858	18-3081	18-4046
BB 231 A	18-7824-2	18-7845 18-7858	—	18-4046
501 A	18-7824-2	18-7845 18-7858	18-3081	18-4046
501 B	18-7824-2	18-7845 18-7858	18-3081	18-4046
5.0 FL	18-7875	—	18-3060	18-3081
5.0 FI	18-7875	—	18-3060	18-3081
5.7 GL	18-7824-2	—	18-3060	—
5.7 GI	18-7824-2	—	18-3060	—
5.8 FL	18-7875	—	18-3060	18-3081
5.8 FI	18-7875	—	18-3060	18-3081
5.8 FSI	18-7875	—	18-3060	18-3081
AQ 240 A	18-7875	—	18-3061	—
AQ 255 A	18-7824-2	18-7862 18-7858	—	18-4046
AQ 255 B	18-7824-2	18-7862 18-7858	18-3081	18-4046

Model No.	Oil Filter	Fuel Filter	Impeller	Drive Belt
AQ 260 A	18-7824-2	18-7862 18-7858	18-3081	18-4046
AQ 260 B	18-7824-2	18-7862 18-7858	—	18-4046
BB 260 A	18-7824-2	18-7862 18-7858	18-3081	18-4046
BB 260 B	18-7824-2	18-7862 18-7858	18-3081	18-4046
BB 260 C	18-7824-2	18-7862 18-7858	18-3081	18-4046
BB 261 A	18-7824-2	18-7845 18-7858	18-3081	18-4046
AQ 271 A	18-7824-2	18-7845 18-7858	18-3081	18-4046
AQ 271 B	18-7824-2	18-7845 18-7858	18-3081	18-4046
AQ 271 C	18-7824-2	18-7845 18-7858	18-3081	18-4046
AQ 271 D	18-7824-2	18-7845 18-7858	18-3081	18-4046
570 A	18-7824-2	18-7845 18-7858	18-3081	18-4046
572 A	18-7824-2	18-7845 18-7858	18-3081	18-4046
570 A/MS 4A	18-7824-2	18-7845 18-7858	18-3081	18-4046
AQ 280 A	18-7824-2	18-7862 18-7858	18-3081	18-4046
AQ 290 A	18-7824-2	18-7862 18-7858	18-3081	18-4046
AQ 311 A	18-7824-2	18-7845 18-7858	18-3081	18-4046
AQ 311 B	18-7824-2	18-7845 18-7858	18-3081	—
571 A	18-7824-2	18-7858	18-3081	18-4046
740 A	—	18-7845	—	—
740 B	18-7824-2	18-7845	—	—
7.4 GL	18-7824-2	—	18-3081 18-3060	—
7.4 GI	18-7824-2	—	18-3081	—
7.4 GSI	18-7824-2	—	18-3081	—
8.2 GL	18-7824-2	—	18-3081 18-3060	—

ⓐ Alternator

VOLVO PENTA APPLICATION GUIDE

TUNE-UP APPLICATION FOR DIESEL ENGINE MODELS

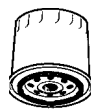

Model No.	Oil Filter	Fuel Filter	Impeller	Drive Belt
2001, B	18-7884	18-7858	18-3076	—
2002, B	18-7884	18-7858	18-3076	—
2003, B	18-7884	18-7858	18-3076	—
2003 T,TB	18-7884	18-7858	18-3081	—
MD 2010 A,B	—	18-7858	18-3079	—
MD 2020 A,B	—	18-7858	18-3079	—
MD 2030 A,B	—	18-7858	18-3080	—
MD 2040 A,B	—	18-7858	18-3080	—
MD 1	—	—	18-3079 ②	—
MD 1 B	18-7884	—	18-3079	—
MD 2	18-7884	—	18-3079 ③	—
MD 2 B	18-7884	—	18-3079	—
AQD 2 B	18-7884	—	18-3079	—
MD 3 B	18-7884	—	18-3080	—
MD 5 A	18-7884	—	18-3076	—
MD 5 B	18-7884	—	18-3076	—
MD 5 C	18-7884	—	18-3076	—
MD 6 A	18-7884	—	18-3079	—
MD 6 B	18-7884	—	18-3076	—
MD 7 A	18-7884	—	18-3076	—
MD 7 B	18-7884	—	18-3076	—
MD 11 C	18-7884	—	18-3076	—
MD 11 D	18-7884	—	18-3076	—
MD 17 C	18-7884	—	18-3080	—
MD 17 D	18-7884	—	18-3080	—
MD 22 A	—	—	18-3081	—
MD 22 L-A	—	—	18-3081	—
TMD 22 A	—	—	18-3081	—
AQD 21 A	—	18-7858	18-3081 ④ 18-3075 ⑤	18-15460
MD 21 A	—	18-7858	18-3081 ④ 18-3075 ⑤	18-15460
AQD 21 B	—	18-7858	18-3081 ④ 18-3075 ⑤	18-15460
MD 21 B	—	18-7858	18-3081 ④ 18-3075 ⑤	18-15460
AQD 32 A	—	18-7858	18-3077	—
MD 32 A	—	18-7858	18-3077	—
MD 30 A	18-7878-1	—	18-3077	—
TMD 30 A	18-7878-1	—	18-3077	—
TAMD 30 A	18-7878-1	—	18-3077	—
AQAD 30 A	18-7878-1	—	18-3077	—
MD 31 A	18-7878-1	—	18-3077	—
TMD 31 A	18-7878-1	—	18-3077	—
AQAD 31 A	18-7878-1	—	18-3077	—
AD 31 A	18-7878-1	—	18-3077	—
TMD 31 B	18-7878-1	—	18-3077	—
TAMD 31 B	18-7878-1	—	18-3077	—
AD 31 B	18-7878-1	—	18-3077	—

Model No.	Oil Filter	Fuel Filter	Impeller	Drive Belt
TMD 31 D	18-7878-1	—	18-3077	—
TAMD 31 D	18-7878-1	—	18-3077	—
AD 31 D	18-7878-1	—	18-3077	—
AD 31 XD	18-7878-1	—	18-3077	—
TMD 31 L-A	18-7878-1	—	18-3077	—
TAMD 31 P,L,M-A	18-7878-1	—	18-3077	—
AD 31 P,L-A	18-7878-1	—	18-3077	—
MD 40 A	—	—	18-3077	—
TMD 40 A	—	—	18-3077	—
AQD 40 A	—	—	18-3077	—
TAMD 40 A	—	—	18-3078	—
AQAD 40 A	—	—	18-3078	—
TMD 40 B	—	—	18-3077	—
TAMD 40 B	—	—	18-3078	—
AQAD 40 B	—	—	18-3078	—
TMD 40 C	—	—	18-3077	—
TMD 41 A	—	—	18-3077	—
AQD 41 A	—	—	18-3077	—
D 41 A	—	—	18-3077	—
TAMD 41 A	—	—	18-3077	—
AQAD 41 A	—	—	18-3077	—
AD 41 A	—	—	18-3077	—
TMD 41 B	—	—	18-3077	—
D 41 B	—	—	18-3077	—
TAMD 41 B	—	—	18-3077	—
AD 41 B	—	—	18-3077	—
KAMD 42 A	—	—	18-3077	—
KAD 42 A	—	—	18-3077	—
TMD 41 D	—	—	18-3077	—
D 41 D	—	—	18-3077	—
TAMD 41 D	—	—	18-3077	—
AD 41 D	—	—	18-3077	—
TMD 41 L-A	—	—	18-3077	—
D 41 L-A	—	—	18-3077	—
TAMD 41 P,L,M,H-A	—	—	18-3077	—
KAMD 42 B	—	—	18-3077	—
KAD 42 B	—	—	18-3077	—
KAMD 42 P-A	—	—	18-3077	—
KAD 42 P-A	—	—	18-3077	—

- ② S/N 14016 & up
- ③ S/N 4211- & up
- ④ S/N 103386 & below
- ⑤ S/N 103387 & up



**18-5246
TUNE-UP KIT**
For: Delco HVS V-6 Distributors



**18-5247
TUNE-UP KIT**
Replaces: 898253T29
For: Delco HVS V-8 Distributors



**18-5256
TUNE-UP KIT**
— CONTAINS —

Part #	O.E. #	Description
18-5314	835304	Contact Set
18-5338	835308-8	Condenser
18-5411	841243	Rotor



**18-5260
TUNE-UP KIT**
— CONTAINS —

Part #	O.E. #	Description
18-5303	835705, 855846-2	Contact Set
18-5345	835704	Condenser
18-5403	855845	Rotor

Prestolite



**18-5264
TUNE-UP KIT**
— CONTAINS —

Part #	O.E. #	Description
18-5303	835705, 855846-2	Contact Set
18-5345	835704	Condenser
18-5425	834975	Rotor

V-8 with Prestolite clip-down cap



**18-5265
TUNE-UP KIT**
— CONTAINS —

Part #	O.E. #	Description
18-5305	243799, 1306169,	Contact Set
	243460	
18-5348	834560	Condenser
18-5428	243903	Rotor



**18-5266
TUNE-UP KIT**
Fits: Flame Thrower Distributors 18-5481, 18-5482, 18-5483, 18-5477, 18-5478, 18-5479



**18-5284
TUNE-UP KIT**
— CONTAINS —

Part #	O.E. #	Description
18-5305	243799, 1306169,	Contact Set
	243460	
18-5349	841262	Condenser
18-5428	243903	Rotor

Bosch 4 cyl.



**18-5303
CONTACT SET**
Replaces: 835705, 855846-2



**18-5305
CONTACT SET**
Replaces: 241664, 243460, 243799, 1306169



**18-5306
CONTACT SET**
Replaces: 240149



**18-5310
CONTACT SET**
Replaces: 818701-5



**18-5314
CONTACT SET**
Replaces: 835304



**18-5319
CONTACT SET**
Replaces: 243801



**18-5338
CONDENSER**
Replaces: 835308



**18-5342
CONDENSER**
Replaces: 243653



**18-5345
CONDENSER**
Replaces: 835704



**18-5349
CONDENSER**
Replaces: 841262
For: Bosch Distributors



**18-5348
CONDENSER**
Replaces: 834560



**18-5245
ROTOR**
Replaces: 3858977
For: Delco HVS Distributors



**18-5402
ROTOR**
Replaces: 3862014
For: Delco EST V-8 Distributors



**18-5403
ROTOR**
Replaces: 855845, 841907, 3853801



**18-5404-1
ROTOR**



18-5405
ROTOR
Replaces: 33854549,
3862014
V-8 Fits new GM style
"Module in Cap"



18-5406
ROTOR
Replaces: 3854261
For: 3.0L Delco EST
"Module in Cap"



18-5408
ROTOR
Replaces: 3854311
For: 4.3L V6 Delco EST
"Module in Cap"



18-5411
ROTOR
Replaces: 841243



18-5413
ROTOR
Replaces: 3854218
For: 5.0L FI, FL, 5.8L FL, FI, FSI



18-5419
ROTOR
Replaces: 818525



18-5425
ROTOR
Replaces: 834975



18-5428
ROTOR
Replaces: 243903



18-29322
CAP & ROTOR KIT
Replaces: 3854217,
3854215
Fits: Ford HEI Distributors



18-5248
DISTRIBUTOR CAP
Replaces: 3854217
For: 5.0FIPMDA, 5.0FIPMDM,
5.8FIPMDA, 5.8FIPMDM,
5.0FIPHUBCE, 5.0FIPHUCCE,
5.0FIPHUCE, 5.0FIPHURCE,
5.0FIPHUSCE, 5.0FLPHUB,
5.0FLPHUC, 5.0FLPHUE,
5.0FLPHUR, 5.0FLPHUS,
5.8FIHU, 5.8FIP



18-5301
TUNE-UP KIT
Replaces:
Fits: male cap v-8 flamethrower
distributors



18-5302
TUNE-UP KIT
Replaces:
Fits: male cap v-8 flamethrower
distributors



18-5352
DISTRIBUTOR CAP
Replaces: 841070,
3853815



18-5353
DISTRIBUTOR CAP
Replaces: 841926



18-5354
DISTRIBUTOR CAP
Replaces: 3854548
For: V-8 GM Delco EST
"Module in Cap"



18-5356
DISTRIBUTOR CAP
Replaces: 243797
Bosch



18-5357
DISTRIBUTOR CAP
Replaces: 243632,
870690, 1243632



18-5358
DISTRIBUTOR CAP
Replaces: 841263
Bosch



18-5361
DISTRIBUTOR CAP
Replaces: 3854260
For: 3.0L Delco EST
"Module in Cap"



18-5362
DISTRIBUTOR CAP
Replaces: 3854331
For: 4.3L V6 Delco EST
"Module in Cap"



18-5369
DISTRIBUTOR CAP
Replaces: 835702
with 18-5399 Gasket



18-5375
DISTRIBUTOR CAP
Replaces: 841244



18-5393
DISTRIBUTOR CAP
Replaces: 241669



18-5394
DISTRIBUTOR CAP
Replaces: 243658



18-5473
DISTRIBUTOR CAP
Black Distributor Cap with Male
Terminals for Flamethrower
Distributors

 <p>18-5474 DISTRIBUTOR CAP Red Distributor Cap with Male Terminals for Flamethrower Distributors</p>	 <p>18-5243 DISTRIBUTOR CAP Replaces: 3859019 For: Delco HVS V-6 Distributors</p>	 <p>18-5244 DISTRIBUTOR CAP Replaces: 3858975 For: Delco HVS V-8 Distributors</p>	 <p>18-7492 COIL Replaces: 3854161 For: 1996 applications</p>	 <p>18-7493 COIL Replaces: 3859078 For: 8.1L 2001-2007</p>
 <p>18-5745 IGNITION COIL Replaces: 3287677 Fits: AQ171A, AQ171C 251A (1988-92)</p>	 <p>18-7648 IGNITION COIL Replaces: 3861267 Fits: 8.1Gi-A, 8.1Gi-B, 8.1Gi-BF, 8.1Gi-C, 8.1Gi-CF, 8.1Gi-D, 8.1Gi-DF, 8.1GSI-A, 8.1GXi-A, 8.1GXi-AF, 8.1GXi-B, 8.1GXi-BF, 8.1GXi-C</p>	 <p>18-5433 IGNITION COIL Replaces: 835998 Uses External Resistor</p>	 <p>18-5436 IGNITION COIL 3.0 ohm Replaces: 35254 Has Internal Resistor</p>	 <p>18-5437 IGNITION COIL Replaces: 3852217 Metal Encased - 12 Volt Uses External Resistor (For All Applications) For: 1990 & prior stern drives with breaker point ignition</p>
 <p>18-5467 IGNITION COIL Replaces: 21436799 Fits: Engines equipped with Delco HVS distributor w/ extended bracket</p>	 <p>18-5443 IGNITION COIL Replaces: 3854002 3.0L/4.3L/5.7L/7.4L</p>	 <p>18-5107-1 IGNITION MODULE Replaces: 3854003</p>	 <p>18-5464 IGNITION MODULE Fits: Sierra 18-5481, 18-5482 and 18-5483 Billet HI-PERFORMANCE ELECTRONIC DISTRIBUTORS (except HEI/EST)</p>	 <p>18-5108 PICK-UP COIL SENSOR Replaces 3854001 For: GM EST</p>
 <p>18-7757 THROTTLE POSITION SENSOR Replaces: 3855296 Fits: 1995-2001</p>	 <p>18-7642 PICK-UP ASSEMBLY Replaces: 3863130 Fits: 3.0, 4.3, 5.0, 5.7L models (2002-07)</p>	 <p>18-7643 CAMSHAFT SENSOR 3-pin Replaces: 3859082 Fits: 8.1Gi-A, 8.1Gi-B, 8.1Gi-BF, 8.1Gi-C, 8.1Gi-CF, 8.1Gi-D, 8.1Gi-DF, 8.1GSI-A, 8.1GXi-A, 8.1GXi-AF, 8.1GXi-B, 8.1GXi-BF, 8.1GXi-C, 8.1GXi-E, 8.1GXi-EF, 8.1GXi-D, 8.1GXi-DF, 8.1OSi-A, 8.1OSi-AF, 8.1GiI-E, 8.1GXii-D (2001-07)</p>	 <p>18-7706 CRANKSHAFT POSITION SENSOR Replaces: 3858979 Fits: 4.3, 5.0, 5.7L models</p>	 <p>18-7708 CRANKSHAFT POSITION SENSOR Replaces: 3808516 Fits: Most 8.1L</p>

FEATURES

- ★ Oil filled for better cooling and long life
- ★ Low resistance and improved turn ratios produces the higher voltage needed to run larger spark plug gaps for added power and better fuel economy
- ★ More windings maximize energy and reliability over the full RPM range
- ★ Fits existing brackets for easy installation

 <p>18-5466 HI-PERFORMANCE IGNITION COIL 1.5 ohm (oil filled), black - 8 cylinder: Flame-Thrower 40,000 volt coil. ★ Designed for use with the original Ignitor Electronic Conversion Kits ★ Can be used with other inductive ignition systems</p>	 <p>18-5469 HI-PERFORMANCE IGNITION COIL 3.0 ohm (oil filled), black - 4 & 6 cylinder: Flame-Thrower 40,000 volt coil. ★ Designed for use with the original Ignitor Electronic Conversion Kits ★ Can be used with other inductive ignition systems</p>	 <p>18-5472 HI-PERFORMANCE IGNITION COIL 0.6 ohm (oil filled), black - 4, 6, & 8 cylinder: Flame-Thrower 45,000 volt coil. ★ Super low 0.6 ohm resistance coil designed for use with the Ignitor II Hi Performance Electronic Conversion Kits ★ Compatible with capacitive discharge systems</p>
---	--	---

Part #	Description	Recommended Coil	Resistance Ohms	Part #	Description	Recommended Coil	Resistance Ohms
18-5294	Electronic Conversion Kit	18-5469	3.0	18-5286	Hi Performance Electronic Conversion Kit	18-5472	0.6
18-5295	Electronic Conversion Kit	18-5469	3.0	18-5289	Hi Performance Electronic Conversion Kit	18-5472	0.6
18-5299	Electronic Conversion Kit	18-5466	1.5	18-5483	Flame-Thrower Distributor	18-5472	0.6



FEATURES

- ★ *Distributors feature the Ignitor II ignition module with adaptive dwell control adjusts the spark timing over the entire RPM range to maximize performance*
- ★ *Upper roller bearing and oil impregnated bronze sintered bottom bushing are installed and aligned bored for accuracy for maximum durability*
- ★ *Machined heat treated gear with tight tolerances insures durability and consistent timing to maximize horsepower and performance. Complete with high dielectric strength cap and rotor for years of performance*

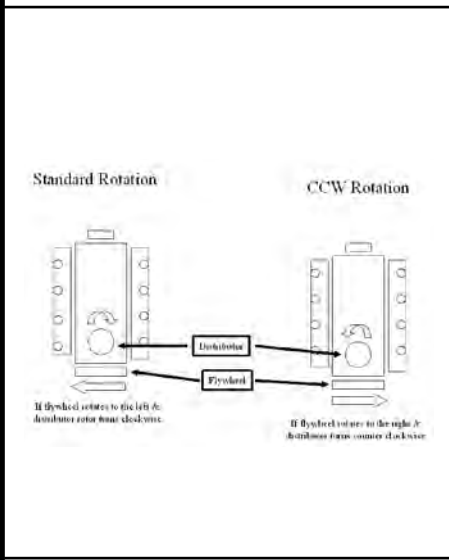

18-5483
HI-PERFORMANCE ELECTRONIC DISTRIBUTOR
 Fits: Chevrolet Marine Small and Big Block engines (Standard Deck Height)
 Replacement cap/rotor kit 18-5266

18-5498-2
DISTRIBUTOR
 Replaces: 9-26307; Mallory YLM624BV
 For GM V8, 482, 502, 540 CID (Except 348, 409 & Tall Deck Big Block)

18-5475
DISTRIBUTOR
 Fits: 4 Cyl GM w/ Delco EST Ignition
 Tune-Up Kit 18-5280

18-5476
DISTRIBUTOR
 Fits: GM V6 Engines with Delco EST Ignition HEI
 Tune-Up Kit 18-5278

18-5484-1
ELECTRONIC DISTRIBUTOR (Late HEI)
 Replaces: 3857449
 For Conventional Rotation V8/LH 262-454 & 502 (Except 348/409 and Tall Block Engines)
 • Designed as plug-in replacement for GM-style fuel ignition system distributor
 Tune-Up Kit 18-5281

—CONTAINS—

Description	Part #
Distributor Cap	18-5354
Rotor	18-5405

18-5494-2
ELECTRONIC DISTRIBUTOR
 Replaces: Mallory YLM624AV
 Conventional Rotation
 For Chevrolet all V8 includes 482, 502, 540 CID (Except 348, 409 & Tall Deck Big Block)

—CONTAINS—

Part #	Description
18-5376	Distributor Cap
18-5488	Module
18-5404-1	Rotor

18-5480
COMPLETE IGNITION CONVERSION KIT
 Fits: GM SB & BB with Standard Deck Height

—CONTAINS—

Part #	Description
18-5472	Coil
18-8803-2	Wire Set
18-5483	Distributor

18-5477
ELECTRONIC DISTRIBUTOR
 Fits: Ford 302 V-8 engines
 Replacement Cap/Rotor Kit 18-5266



**18-5478
ELECTRONIC DISTRIBUTOR**
Fits: Chrysler LA series V-8 engines
Replacement Cap/Rotor Kit 18-5266



**18-5479
ELECTRONIC DISTRIBUTOR**
Fits: GM V-8 engines-reverse rotation
Replacement Cap/Rotor Kit 18-5266

Ignitor® II

ELECTRONIC IGNITION

FEATURES

- ★ Senses current levels in the coil and adjusts the dwell to maintain peak energy throughout the entire RPM range.
- ★ Develops, on average, 4 times more available energy between 3000 and 5000 RPM's and twice as much plug voltage as point-type systems.
- ★ Ignition energy is sustained and coil life is increased when peak current level is reached just prior to spark.
- ★ More stable timing.
- ★ Use with 18-5472 "Flame Thrower II" Coil for optimum performance



**18-5240
HI-PERFORMANCE ELECTRONIC CONVERSION KIT**
Fits: Prestolite IDU-7801 Distributors



**18-5286
HI-PERFORMANCE ELECTRONIC CONVERSION KIT**
Fits: 6 Cylinder Delco Distributors



**18-5288
HI-PERFORMANCE ELECTRONIC CONVERSION KIT**
Fits: Most Prestolite V-8 Distributors with snap down cap





**18-5289
HI-PERFORMANCE ELECTRONIC CONVERSION KIT**
Fits: Most Prestolite V-8 Distributors with screw down cap

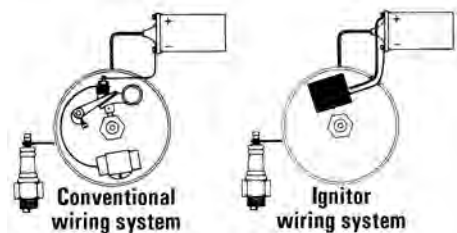

FEATURES

- ★ Replaces points & condensers for true solid state ignition.
- ★ Uses standard coil, cap and rotor.
- ★ Easy to install, one-piece, 2-wire hook-up.
- ★ Accurate to within 1/4° timing accuracy 0 to 6000 RPM range.





Conventional wiring system

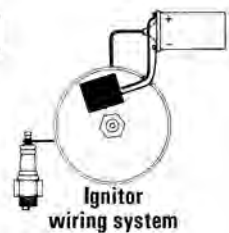

Ignitor wiring system



**18-5239
ELECTRONIC CONVERSION KIT**
Fits: Prestolite IDU-7801 Distributors



**18-5292
ELECTRONIC CONVERSION KIT**
Fits: 4 Cylinder Volvo AQ Models with Bosch Ignition(Dist # 0231178017)



**18-5294
ELECTRONIC CONVERSION KIT**
Fits: (6 Cyl.) Delco distributors



**18-5295
ELECTRONIC CONVERSION KIT**
Fits: Most 4 Cyl. Prestolite distributors (except IBM7026) For: Onan, Universal, Waukesha, Wisconsin



**18-5299D
ELECTRONIC CONVERSION KIT**
Fits: 8 (Cyl.) AQ200A, B, AQ225A, B and All 8 Cyl. w/Prestolite Dist # IBM-7013A Use with 18-5403 style rotor

① 18-5299D
Display Package

① Items ending in "D" are Display Packaged - Regular number is Non-Display

PREMIUM MARINE IGNITION WIRES

Sierra's MAGFORCE Ignition Wires are "Electronics Friendly" protecting all of your electronic devices and electronic engine controls from RFI and EMI while delivering the maximum amount of voltage. Exact fit design ensures easy installation and years of trouble - free service.

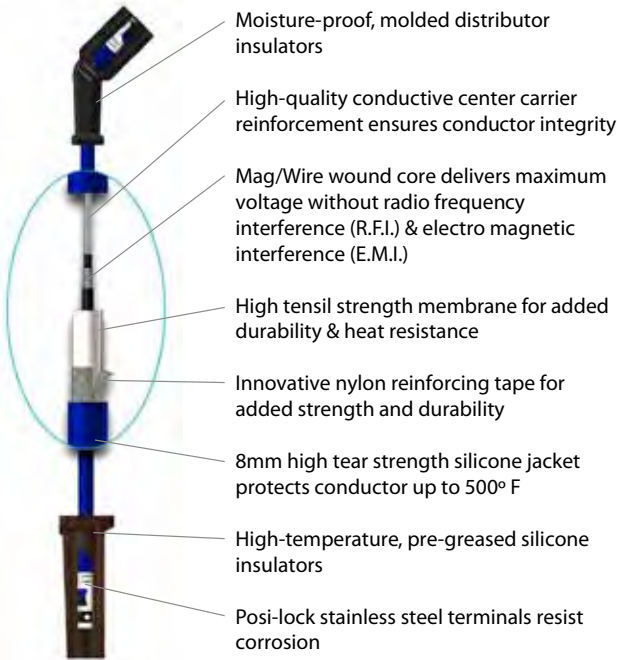

VOLVO MARINE IGNITION WIRES APPLICATION

Model	Cyl.	Distributor	Year Start	Year End	Plug Wire Set
AQ115A, B	4	Volvo	1969	1975	18-28050
AQ120B	4	Volvo	1977	1980	18-8813-1
AQ125A, B	4	Volvo	1981	1985	18-8813-1
AQ130A, B, C, D	4	Volvo	1968	1977	18-28050
AQ131A, B, C, D	4	Volvo	1985	1989	18-8813-1
AQ140A	4	Volvo	1975	1979	18-8813-1
AQ145A, B	4	Volvo	1979	1985	18-8813-1
AQ151A, B, C	4	Volvo	1985	1989	18-8813-1
AQ175A	6	Volvo	1981	1985	18-8801-1
AQ190A	8	Volvo	1976	1977	18-8802-1
AQ200B	8	Mallory (Tall Cap)	1974	1976	18-8802-1
AQ200B	8	Mallory (Flat Cap)	1974	1976	18-8823-1
AQ200C	8	Mallory (Tall Cap)	1976	1977	18-8802-1
AQ200C	8	Mallory (Flat Cap)	1976	1977	18-8823-1
AQ205A	6	Volvo	1988	1989	18-8801-1
AQ211A	8	Volvo	1986	1989	18-8802-1
AQ225B	8	Mallory (Tall Cap)	1974	1976	18-8802-1
AQ225B	8	Mallory (Flat Cap)	1974	1976	18-8823-1

VOLVO MARINE IGNITION WIRES APPLICATION

Model	Cyl.	Distributor	Year Start	Year End	Plug Wire Set
AQ231A, B	8	Volvo	1986	1989	18-8802-1
AQ240A	8	Volvo	1976	1977	18-8802-1
AQ255A	8	Mallory (Flat Cap)	1977	1978	18-8823-1
AQ255B	8	Mallory (Tall Cap)	1978	1978	18-8802-1
AQ255B	8	Mallory (Flat Cap)	1978	1978	18-8823-1
AQ260A	8	Mallory (Tall Cap)	1979	1985	18-8802-1
AQ260A	8	Mallory (Flat Cap)	1979	1985	18-8823-1
AQ260B	8	Mallory (Tall Cap)	1985	1986	18-8802-1
AQ271A, B, C, D	8	Volvo	1986	1989	18-8802-1
AQ280A	8	Mallory (Tall Cap)	1978	1979	18-8802-1
AQ280A	8	Mallory (Flat Cap)	1978	1979	18-8823-1
AQ290A	8	Mallory (Tall Cap)	1979	1985	18-8802-1
AQ290A	8	Mallory (Flat Cap)	1979	1985	18-8823-1
AQ311A, B	8	Volvo	1986	1989	18-8802-1
BB140A	4	Volvo	1975	1979	18-8813-1
BB145A	4	Volvo	1979	1985	18-8813-1
BB225A, AV, B, C	8	Volvo	1973	1977	18-8802-1
BB231A	8	Volvo	1987	1987	18-8802-1

APPLICATION CONTINUED ON NEXT PAGE

VOLVO MARINE IGNITION WIRES APPLICATION					
Model	Cyl.	Distributor	Year Start	Year End	Plug Wire Set
BB260A, AV, B, C	8	Volvo	1978	1985	18-8802-1
BB261A	8	Volvo	1988	1989	18-8802-1
230A, B	4	Volvo	1989	1992	18-8813-1
250A, B	4	Volvo	1989	1992	18-8813-1
432A	6	Delco EST	1992	1993	18-8835-1
434A	6	Delco EST	1992	1993	18-8835-1
3.0GLM	4	Delco EST	1993	1994	18-8833-1
3.0GLM	4	Delco EST	2002	2004	18-8833-1
3.0GLP	4	Delco EST	2002	2010	18-8833-1
3.0GSM	4	Delco EST	1994	2002	18-8833-1
3.0GSP	4	Delco EST	1993	2002	18-8833-1
3.0GXl	4	Delco EST	2008	2009	18-8833-1
4.3GI	6	Delco EST	1994	2000	18-8835-1
4.3GL	6	Delco EST	1993	2010	18-8835-1
4.3GS	6	Delco EST	1993	1999	18-8835-1
4.3GXl	6	Delco HVS	2001	2015	18-8829-1
4.3GXl	6	Delco EST	2001	2002	18-8835-1
4.3GXIE	6	Delco HVS	2009	2015	18-8829-1
4.3SI	6	Delco HVS	2001	2009	18-8829-1
4.3SI-BF	6	Delco HVS	2001	2002	18-8829-1
5.0FI	8	Ford	1994	1996	18-8820-1
5.0FL	8	Prestolite	1994	1996	18-8802-1
5.0GI	8	Delco EST	1997	2000	18-8836-1
5.0GL	8	Prestolite	1997	2001	18-8802-1
5.0GL	8	Delco EST	2001	2006	18-8836-1
5.0GXl	8	Delco HVS	2001	2015	18-8828-1
5.0GXl-A	8	Delco EST	2001	2002	18-8836-1
5.0GXIC	8	Delco HVS	2007	2009	18-8828-1
5.0GXIE	8	Delco HVS	2007	2015	18-8828-1
5.0OSI	8	Delco HVS	2001	2009	18-8828-1
5.0OSIE	8	Delco HVS	2008	2009	18-8828-1
5.7GI	8	Delco EST	1993	1997	18-8836-1
5.7Gi	8	Delco HVS	2001	2015	18-8828-1
5.7GI	8	Delco EST	2004	2005	18-8836-1
5.7GIC	8	Delco HVS	2008	2009	18-8828-1
5.7GICE	8	Delco HVS	2008	2009	18-8828-1
5.7GiE	8	Delco HVS	2007	2015	18-8828-1
5.7GIL	8	Delco HVS	2002	2009	18-8828-1
5.7GIL-A	8	Delco EST	2001	2001	18-8836-1
5.7GL	8	Prestolite	1993	1997	18-8802-1
5.7GL	8	Delco EST	1993	1997	18-8836-1
5.7GL	8	Delco EST	2001	2004	18-8836-1
5.7GL-A	8	Mallory	2001	2001	18-8802-1
5.7GSI	8	Delco EST	1996	2001	18-8836-1
5.7GSP	8	Prestolite	1996	2000	18-8802-1

VOLVO MARINE IGNITION WIRES APPLICATION					
Model	Cyl.	Distributor	Year Start	Year End	Plug Wire Set
5.7GXl	8	Delco HVS	2001	2015	18-8828-1
5.7GXl-A, B	8	Delco EST	2000	2002	18-8836-1
5.7GXIC	8	Delco HVS	2007	2008	18-8828-1
5.7GXICE	8	Delco HVS	2007	2010	18-8828-1
5.7GXIE	8	Delco HVS	2007	2015	18-8828-1
5.7GXIL	8	Delco HVS	2001	2008	18-8828-1
5.7GXIL-A, B	8	Delco EST	2000	2002	18-8836-1
5.7OSI	8	Delco HVS	2001	2009	18-8828-1
5.7OSIE	8	Delco HVS	2008	2009	18-8828-1
5.7OSXI	8	Delco HVS	2001	2009	18-8828-1
5.7OSXIE	8	Delco HVS	2008	2009	18-8828-1
5.8FI	8	Ford	1994	1996	18-8820-1
5.8FL	8	Prestolite	1994	1996	18-8803-1
5.8FSI	8	Prestolite	1994	1996	18-8803-1
7.4GI	8	Delco EST	1994	2000	18-8836-1
7.4GL	8	Prestolite	1993	1997	18-8802-1
7.4GLI	8	Prestolite	1993	1996	18-8802-1
7.4GLP	8	Prestolite	1993	1997	18-8802-1
7.4GLP	8	Prestolite	1994	1997	18-28051
7.4GLP	8	Delco EST	1995	1996	18-8836-1
7.4GSI	8	Delco EST	1994	2000	18-8836-1
8.1Gi-A	8	Distributorless	1999	2015	18-8838-1
8.1GiC	8	Distributorless	2007	2015	18-8838-1
8.1GiCE	8	Distributorless	2007	2015	18-8838-1
8.1GiE	8	Distributorless	2007	2015	18-8838-1
8.1GiL	8	Distributorless	2000	2008	18-8838-1
8.1GSI	8	Distributorless	2000	2001	18-8838-1
8.1GXi	8	Distributorless	2001	2015	18-8838-1
8.1GXIE	8	Distributorless	2007	2015	18-8838-1
8.1GXil	8	Distributorless	2001	2008	18-8838-1
8.1PSCE	8	Distributorless	2008	2015	18-8838-1
8.1OSI	8	Distributorless	2003	2009	18-8838-1
8.1OSIE	8	Distributorless	2008	2009	18-8838-1
8.2GLI	8	Prestolite	1993	1994	18-8803-1
8.2GLP	8	Prestolite	1993	1994	18-8803-1
8.2GSI	8	Delco EST	1995	2000	18-8836-1
DPX375	8	Distributorless	2000	2002	18-8838-1
DPX385	8	Delco EST	1996	2000	18-8836-1
DPX415	8	Delco EST	1996	2000	18-8836-1
DPX420	8	Distributorless	2000	2002	18-8838-1
V6-200	6	Delco HVS	2012	2015	18-8828-1
V6-225	6	Delco HVS	2012	2015	18-8828-1
V8-270	8	Delco HVS	2012	2015	18-8829-1
V8-300	8	Delco HVS	2012	2015	18-8829-1
V8-320	8	Delco HVS	2012	2015	18-8829-1



BATTERY CABLES
Gauge cable with soldered lug terminals on each end to accept a 3/8" stud.

Part No.	Size	Color	Gauge
BC88523	2'	red	4
BC88533	2'	black	4
BC88543	4'	red	2
BC88553	4'	black	2
BC88563	6'	red	2
BC88573	6'	black	2
BC88583	8'	red	1
BC88593	8'	black	1



18-5225 SPARK PLUG WIRE KIT
Replaces: Mercury 84-99215A26, 84-813706A26
Kit includes 25 ft. roll of 7mm Hypalon Ignition Wire With a Metallic Core and a large assortment of three different end fittings.

 <p>18-5226 IGNITION WIRE Metallic Core 100' Spool 7mm Hypalon</p>	 <p>18-26810 GM HEI 4 TERMINAL PIGTAIL Fits: GM HEI Distributors w/4 terminals</p>	 <p>18-26811 GM HEI 2 TERMINAL PIGTAIL Fits: GM HEI Distributors w/2 terminals</p>	 <p>18-26812 HEI COIL GRAY CONNECTOR</p>	 <p>18-26813 HEI COIL BLACK CONNECTOR</p>
 <p>18-5493 IGNITION PICKUP COIL ASSEMBLY Replacement pick-up coil for Accel Electronic Distributors</p>	<p>PKG. OF 10</p>  <p>18-5224 18-5224-9① SPARK PLUG WIRE TERMINAL Replaces: Mercury 20121 OMC 510364</p>	<p>PKG. OF 10</p>  <p>18-5750 18-5750-9① UNIVERSAL SPARK PLUG BOOTS Supplied complete w/Terminal Connector Replaces: OMC 581027, 580339</p>	 <p>18-5752 UNIVERSAL SPARK PLUG BOOT 8mm</p>	 <p>18-5657 PROTECTING SLEEVE Replaces: 855798 Fits: Most Volvo gas & diesel engines</p>

① Priced per Package

VOLVO PENTA IGNITION APPLICATION

Model	Distributor	Spark Plug Wire Set	Distributor Cap	Rotor	Pick-Up Coil	ICM	Ignition Coil	Condenser	Contact Points	Tune-Up Kit
AQ100	BOSCH	-	18-5357	18-5428	N/A	N/A	18-5436	18-5342	18-5306	-
AQ110	BOSCH	-	18-5357	18-5428	N/A	N/A	18-5436	18-5342	18-5306	-
AQ115A	0231153010	18-28050	18-5357	18-5428	N/A	N/A	18-5436	-	18-5305	-
AQ115A	0231153012	18-28050	18-5356	18-5428	N/A	N/A	18-5436	-	18-5305	-
AQ115B	0231153010	18-28050	18-5357	18-5428	N/A	N/A	18-5436	-	18-5305	-
AQ115B	0231153012	18-28050	18-5356	18-5428	N/A	N/A	18-5436	-	18-5305	-
AQ120	BOSCH	-	18-5357	18-5428	N/A	N/A	18-5436	18-5342	18-5306	-
AQ120B	0231178017	18-8813-1	18-5358	18-5428	N/A	N/A	18-5436	18-5349	18-5305	18-5284
AQ120B	0231178016	18-8813-1	18-5356	18-5428	N/A	N/A	18-5436	18-5349	18-5305	18-5284
AQ120B	0231178018	18-8813-1	18-5356	18-5428	N/A	N/A	18-5436	18-5349	18-5305	18-5284
AQ125A	ALL	18-8813-1	18-5358	18-5428	N/A	N/A	18-5436	18-5349	18-5305	18-5284
AQ125B	ALL	18-8813-1	18-5358	18-5428	N/A	N/A	18-5436	18-5349	18-5305	18-5284
AQ130A	0231153010	18-28050	18-5357	18-5428	N/A	N/A	18-5436	-	18-5305	-
AQ130A	0231153012	18-28050	18-5356	18-5428	N/A	N/A	18-5436	-	18-5305	-
AQ130B	0231153010	18-28050	18-5357	18-5428	N/A	N/A	18-5436	-	18-5305	-
AQ130B	0231153012	18-28050	18-5356	18-5428	N/A	N/A	18-5436	-	18-5305	-
AQ130C	0231153010	18-28050	18-5357	18-5428	N/A	N/A	18-5436	-	18-5305	-
AQ130C	0231153012	18-28050	18-5356	18-5428	N/A	N/A	18-5436	-	18-5305	-
AQ130D	0231153010	18-28050	18-5357	18-5428	N/A	N/A	18-5436	-	18-5305	-
AQ130D	0231153012	18-28050	18-5356	18-5428	N/A	N/A	18-5436	-	18-5305	-
AQ131A	ALL	18-8813-1	18-5358	18-5428	N/A	N/A	18-5436	-	18-5305	-
AQ131B	ALL	18-8813-1	18-5358	18-5428	N/A	N/A	18-5436	-	18-5305	-
AQ131C	ALL	18-8813-1	18-5358	18-5428	N/A	N/A	18-5436	-	18-5305	-
AQ131D	ALL	18-8813-1	18-5358	18-5428	N/A	N/A	18-5436	-	18-5305	-
AQ140A	0231178017	18-8813-1	18-5358	18-5428	N/A	N/A	18-5436	18-5349	18-5305	18-5284
AQ140A	0231178016	18-8813-1	18-5356	18-5428	N/A	N/A	18-5436	18-5349	18-5305	18-5284
AQ140A	0231178018	18-8813-1	18-5356	18-5428	N/A	N/A	18-5436	18-5349	18-5305	18-5284
AQ145A	ALL	18-8813-1	18-5358	18-5428	N/A	N/A	18-5436	18-5349	18-5305	18-5284
AQ145B	ALL	18-8813-1	18-5358	18-5428	N/A	N/A	18-5436	18-5349	18-5305	18-5284
AQ151A	ALL	18-8813-1	18-5358	18-5428	N/A	N/A	18-5436	18-5349	18-5305	18-5284
AQ151B	ALL	18-8813-1	18-5358	18-5428	N/A	N/A	18-5436	18-5349	18-5305	18-5284
AQ151C	ALL	18-8813-1	18-5358	18-5428	N/A	N/A	18-5436	18-5349	18-5305	18-5284

APPLICATION CONTINUED ON NEXT PAGE

VOLVO PENTA IGNITION APPLICATION (Cont.)

Model	Distributor	Spark Plug Wire Set	Distributor Cap	Rotor	Pick-Up Coil	ICM	Ignition Coil	Condenser	Contact Points	Tune-Up Kit
AQ165A	0231116054		18-5393	18-5428	N/A	N/A		-	-	-
AQ165A	0231116060		18-5393	18-5428	N/A	N/A		-	-	-
AQ165A	0231121008		18-5393	18-5428	N/A	N/A		-	18-5305	-
AQ165A	0231311002		18-5394	18-5428	N/A	N/A		-	18-5319	-
AQ170A	0231116054		-	18-5428	N/A	N/A		-	-	-
AQ170A	0231116060		-	18-5428	N/A	N/A		-	-	-
AQ170A	0231121008		-	18-5428	N/A	N/A		-	18-5305	-
AQ170A	0231311002		-	-	N/A	N/A		-	18-5319	-
AQ170B	0231116054		-	18-5428	N/A	N/A		-	-	-
AQ170B	0231116060		-	18-5428	N/A	N/A		-	-	-
AQ170B	0231121008		-	18-5428	N/A	N/A		-	18-5305	-
AQ170B	0231311002		-	-	N/A	N/A		-	18-5319	-
AQ170C	0231116054		18-5393	18-5428	N/A	N/A		-	-	-
AQ170C	0231121008		-	18-5428	N/A	N/A		-	18-5305	-
AQ171A	ALL		-	-	N/A	N/A		N/A	N/A	-
AQ171C	ALL		-	-	N/A	N/A		N/A	N/A	-
AQ175A	ALL	18-8801-1	18-5369	18-5425	N/A	N/A	18-5433	18-5345	18-5303	18-5264
AQ190A	ALL	18-8802-1	18-5369	18-5425	N/A	N/A		18-5345	18-5303	18-5264
AQ200B	MALLORY FLAT CAP	18-8823-1	18-5375	18-5411	N/A	N/A		18-5338	18-5314	18-5256
AQ200B	MALLORY TALL CAP	18-8802-1	18-5352	18-5403	N/A	N/A		18-5345	18-5303	18-5260
AQ200C	MALLORY FLAT CAP	18-8823-1	18-5375	18-5411	N/A	N/A	18-5433	18-5338	18-5314	18-5256
AQ200C	MALLORY TALL CAP	18-8802-1	18-5352	18-5403	N/A	N/A	18-5433	18-5345	18-5303	18-5260
AQ200D	S/N 20459 & BELOW		18-5369	18-5425	N/A	N/A	18-5433	18-5345	18-5303	18-5264
AQ200D	S/N 20460 & UP		18-5352	18-5403	N/A	N/A	18-5433	18-5345	18-5303	18-5260
AQ200F	ALL		18-5352	18-5403	N/A	N/A	18-5433	18-5345	18-5303	18-5260
AQ205A	ALL	18-8801-1	18-5353	18-5403	N/A	N/A		-	-	-
AQ211A	ALL	18-8802-1	18-5352	18-5403	N/A	N/A	18-5433	18-5345	18-5303	18-5260
AQ225B	MALLORY FLAT CAP	18-8823-1	18-5375	18-5411	N/A	N/A		18-5338	18-5314	18-5256
AQ225B	MALLORY TALL CAP	18-8802-1	18-5352	18-5403	N/A	N/A		18-5345	18-5303	18-5260
AQ225C	ALL		18-5375	18-5411	N/A	N/A	18-5433	18-5338	18-5314	18-5256
AQ225D	S/N 20459 & BELOW		18-5369	18-5425	N/A	N/A	18-5433	18-5345	18-5303	18-5264
AQ225D	S/N 20460 & UP		18-5352	18-5403	N/A	N/A	18-5433	18-5345	18-5303	18-5260
AQ225E	ALL		18-5352	18-5403	N/A	N/A	18-5433	18-5345	18-5303	18-5260
AQ225F	ALL		18-5352	18-5403	N/A	N/A	18-5433	18-5345	18-5303	18-5260
AQ231A	ALL	18-8802-1	18-5352	18-5403	N/A	N/A	18-5433	18-5345	18-5303	18-5260
AQ231B	ALL	18-8802-1	18-5352	18-5403	N/A	N/A	18-5433	18-5345	18-5303	18-5260
AQ240A	ALL	18-8802-1	18-5369	18-5403	N/A	N/A		18-5345	18-5303	18-5260
AQ255A	MALLORY FLAT CAP	18-8823-1	18-5375	18-5411	N/A	N/A	18-5433	18-5338	18-5314	18-5256
AQ255B	MALLORY FLAT CAP	18-8823-1	18-5375	18-5411	N/A	N/A	18-5433	18-5338	18-5314	18-5256
AQ255B	MALLORY TALL CAP	18-8802-1	18-5352	18-5403	N/A	N/A	18-5433	18-5345	18-5303	18-5260
AQ260A	MALLORY FLAT CAP	18-8823-1	18-5375	18-5411	N/A	N/A	18-5433	18-5338	18-5314	18-5256
AQ260A	MALLORY TALL CAP	18-8802-1	18-5352	18-5403	N/A	N/A	18-5433	18-5345	18-5303	18-5260
AQ260B	MALLORY TALL CAP	18-8802-1	18-5352	18-5403	N/A	N/A	18-5433	18-5345	18-5303	18-5260
AQ271A	ALL	18-8802-1	18-5352	18-5403	N/A	N/A	18-5433	-	-	-
AQ271B	ALL	18-8802-1	18-5352	18-5403	N/A	N/A		-	-	-
AQ271C	ALL	18-8802-1	18-5352	18-5403	N/A	N/A		-	-	-
AQ271D	ALL	18-8802-1	18-5352	18-5403	N/A	N/A		-	-	-

APPLICATION CONTINUED ON NEXT PAGE

VOLVO PENTA IGNITION APPLICATION (Cont.)

Model	Distributor	Spark Plug Wire Set	Distributor Cap	Rotor	Pick-Up Coil	ICM	Ignition Coil	Condenser	Contact Points	Tune-Up Kit
AQ280A	MALLORY FLAT CAP	18-8823-1	18-5375	18-5411	N/A	N/A	-	18-5338	18-5314	18-5256
AQ280A	MALLORY TALL CAP	18-8802-1	18-5352	18-5403	N/A	N/A	-	18-5345	18-5303	18-5260
AQ290A	MALLORY FLAT CAP	18-8823-1	18-5375	18-5411	N/A	N/A	18-5433	18-5338	18-5314	18-5256
AQ290A	MALLORY TALL CAP	18-8802-1	18-5352	18-5403	N/A	N/A	18-5433	18-5345	18-5303	18-5260
AQ311A	ALL	18-8802-1	18-5352	18-5403	N/A	N/A	-	-	-	-
AQ311B	ALL	18-8802-1	18-5352	18-5403	N/A	N/A	-	-	-	-
AQ60F	BOSCH	-	18-5357	18-5428	N/A	N/A	18-5436	18-5342	18-5306	-
AQ90	BOSCH	-	18-5357	18-5428	N/A	N/A	18-5436	18-5342	18-5306	-
AQ95	BOSCH	-	18-5357	18-5428	N/A	N/A	18-5436	18-5342	18-5306	-
AQ95A	BOSCH	-	18-5357	18-5428	N/A	N/A	18-5436	18-5342	18-5306	-
BB100	BOSCH	-	18-5357	18-5428	N/A	N/A	18-5436	18-5342	18-5306	-
BB115A	0231153010	18-28050	18-5357	18-5428	N/A	N/A	18-5436	-	18-5305	-
BB115A	0231153012	18-28050	18-5356	18-5428	N/A	N/A	18-5436	-	18-5305	-
BB115B	0231153010	18-28050	18-5357	18-5428	N/A	N/A	18-5436	-	18-5305	-
BB115B	0231153012	18-28050	18-5356	18-5428	N/A	N/A	18-5436	-	18-5305	-
BB115C	0231153010	18-28050	18-5357	18-5428	N/A	N/A	18-5436	-	18-5305	-
BB115C	0231153012	18-28050	18-5356	18-5428	N/A	N/A	18-5436	-	18-5305	-
BB140A	0231178017	18-8813-1	18-5358	18-5428	N/A	N/A	18-5436	18-5349	18-5305	18-5284
BB140A	0231178016	18-8813-1	18-5356	18-5428	N/A	N/A	18-5436	18-5349	18-5305	18-5284
BB140A	0231178018	18-8813-1	18-5356	18-5428	N/A	N/A	18-5436	18-5349	18-5305	18-5284
BB145A	ALL	18-8813-1	18-5358	18-5428	N/A	N/A	18-5436	18-5349	18-5305	18-5284
BB165A	0231116054		18-5393	18-5428	N/A	N/A		-	-	-
BB165A	0231116060		18-5393	18-5428	N/A	N/A		-	-	-
BB165A	0231121008		18-5393	18-5428	N/A	N/A		-	18-5305	-
BB165A	0231311002		18-5394	18-5428	N/A	N/A		-	18-5319	-
BB170A	0231116054		18-5393	18-5428	N/A	N/A		-	-	-
BB170A	0231116060		18-5393	18-5428	N/A	N/A		-	-	-
BB170A	0231121008		18-5393	18-5428	N/A	N/A		-	18-5305	-
BB170A	0231311002		18-5394	18-5428	N/A	N/A		-	18-5319	-
BB170B	0231116054		18-5393	18-5428	N/A	N/A		-	-	-
BB170B	0231116060		18-5393	18-5428	N/A	N/A		-	-	-
BB170B	0231121008		18-5393	18-5428	N/A	N/A		-	18-5305	-
BB170B	0231311002		18-5394	18-5428	N/A	N/A		-	18-5319	-
BB170C	0231116054		18-5393	18-5428	N/A	N/A		-	-	-
BB170C	0231116060		18-5393	18-5428	N/A	N/A		-	-	-
BB170C	0231121008		18-5393	18-5428	N/A	N/A		-	18-5305	-
BB170C	0231311002		18-5394	18-5428	N/A	N/A		-	18-5319	-
BB225A	ALL	18-8802-1	18-5352	18-5403	N/A	N/A	18-5433	18-5345	18-5303	18-5260
BB225AV	ALL	18-8802-1	18-5352	18-5403	N/A	N/A	18-5433	18-5345	18-5303	18-5260
BB225B	ALL	18-8802-1	18-5352	18-5403	N/A	N/A	18-5433	18-5345	18-5303	18-5260
BB225C	ALL	18-8802-1	18-5352	18-5403	N/A	N/A	18-5433	18-5345	18-5303	18-5260
BB231A	ALL	18-8802-1	18-5352	18-5403	N/A	N/A	18-5433	18-5345	18-5303	18-5260
BB260A	ALL	18-8802-1	18-5352	18-5403	N/A	N/A	18-5433	18-5345	18-5303	18-5260
BB260AV	ALL	18-8802-1	18-5352	18-5403	N/A	N/A	18-5433	18-5345	18-5303	18-5260
BB260B	ALL	18-8802-1	18-5352	18-5403	N/A	N/A	18-5433	18-5345	18-5303	18-5260
BB260C	ALL	18-8802-1	18-5352	18-5403	N/A	N/A	18-5433	18-5345	18-5303	18-5260
BB261A	ALL	18-8802-1	18-5352	18-5403	N/A	N/A	18-5433	18-5345	18-5303	18-5260
BB30	BOSCH	-	18-5357	18-5428	N/A	N/A	18-5436	18-5342	18-5306	-
MB10A	ALL		-	18-5428	N/A	N/A	18-5436	-	18-5305	-
MB18	BOSCH	-	18-5357	18-5428	N/A	N/A	18-5436	18-5342	18-5306	-
MB18F	BOSCH	-	18-5357	18-5428	N/A	N/A	18-5436	18-5342	18-5306	-
MB20A	ALL		18-5356	18-5428	N/A	N/A	18-5436	-	18-5305	-

APPLICATION CONTINUED ON NEXT PAGE

VOLVO PENTA IGNITION APPLICATION (Cont.)

Model	Distributor	Spark Plug Wire Set	Distributor Cap	Rotor	Pick-Up Coil	ICM	Ignition Coil	Condenser	Contact Points	Tune-Up Kit
MB20B	0231110043	-	18-5357	18-5428	N/A	N/A	18-5436	18-5342	18-5306	-
MB20B	0231178005		18-5356	18-5428	N/A	N/A	18-5436	-	18-5305	-
MB20C	0231110043	-	18-5357	18-5428	N/A	N/A	18-5436	18-5342	18-5306	-
MB20C	0231178005		18-5356	18-5428	N/A	N/A	18-5436	-	18-5305	-
230A	ALL	18-8813-1	18-5358	18-5428	N/A	N/A	18-5436	18-5349	18-5305	18-5265
230B	ALL	18-8813-1	18-5358	18-5428	N/A	N/A	18-5436	18-5349	18-5305	18-5265
250A	ALL	18-8813-1	18-5358	18-5428	N/A	N/A	18-5436	18-5349	18-5305	18-5265
250B	ALL	18-8813-1	18-5358	18-5428	N/A	N/A	18-5436	18-5349	18-5305	18-5265
251A	ALL		-	-	N/A	N/A	-	N/A	N/A	N/A
430A	ALL		18-5353	18-5403	-	N/A	-	N/A	N/A	N/A
430B	ALL		18-5353	18-5403	-	N/A	-	N/A	N/A	N/A
431A	ALL		18-5353	18-5403	-	N/A	-	N/A	N/A	N/A
431B	ALL		18-5353	18-5403	-	N/A	-	N/A	N/A	N/A
432A	DELCO EST	18-8835-1	18-5362	18-5408	18-5108	18-5107-1	-	N/A	N/A	18-5278
434A	DELCO EST	18-8835-1	18-5362	18-5408	18-5108	18-5107-1	-	N/A	N/A	18-5278
500A	ALL		18-5352	18-5403	-	N/A	-	N/A	N/A	N/A
500B	ALL		18-5352	18-5403	-	N/A	-	N/A	N/A	N/A
501A	ALL		18-5352	18-5403	-	N/A	-	N/A	N/A	N/A
501A/MS4	ALL		18-5352	18-5403	-	N/A	-	N/A	N/A	N/A
501B	ALL		18-5352	18-5403	-	N/A	-	N/A	N/A	N/A
570A	ALL		18-5352	18-5403	-	N/A	-	N/A	N/A	N/A
571A	ALL		18-5352	18-5403	-	N/A	-	N/A	N/A	N/A
572A	ALL		18-5352	18-5403	-	N/A	-	N/A	N/A	N/A
740A	ALL		18-5352	18-5403	-	N/A	-	N/A	N/A	N/A
740A/MS5	ALL		18-5352	18-5403	-	N/A	-	N/A	N/A	N/A
740B	ALL		18-5352	18-5403	-	N/A	-	N/A	N/A	N/A
3.0GL	DELCO EST	18-8841-1	18-5361	18-5406	18-5108	18-5107-1	18-5443	N/A	N/A	18-5280
3.0GS	DELCO EST	18-8841-1	18-5361	18-5406	18-5108	18-5107-1	18-5443	N/A	N/A	18-5280
3.0GX	DELCO EST	18-8841-1	18-5361	18-5406	18-5108	18-5117	18-5465	N/A	N/A	18-5280
4.3Gi	DELCO HVS	18-8829-1	18-5243	18-5245	18-7642	18-5117	18-5467	N/A	N/A	18-5246
4.3Gi	DELCO EST	18-8835-1	18-5362	18-5408	18-5108	18-5107-1	18-7648	N/A	N/A	18-5278
4.3GL	DELCO EST	18-8835-1	18-5362	18-5408	18-5108	18-5107-1	18-7648	N/A	N/A	18-5278
4.3GS	DELCO EST	18-8835-1	18-5362	18-5408	18-5108	18-5107-1	18-7648	N/A	N/A	18-5278
4.3GX	DELCO EST	18-8835-1	18-5362	18-5408	18-5108	18-5107-1	18-7648	N/A	N/A	18-5278
4.3GX	DELCO HVS	18-8829-1	18-5243	18-5245	18-7642	18-5117	18-5467	N/A	N/A	18-5246
4.3Si	DELCO HVS	18-8829-1	18-5243	18-5245	18-7642	18-5117	18-5467	N/A	N/A	18-5246
5.0Fi	FORD	18-8820-1	18-5248	18-5413	-	N/A	18-7492	N/A	N/A	N/A
5.0FL	PRESTOLITE	18-8802-1	18-5352	18-5403	-	N/A	18-5437	N/A	N/A	N/A
5.0GIC	DELCO HVS	18-8828-1	18-5244	18-5245	18-7642	18-5117	18-5467	N/A	N/A	18-5247
5.0GI	DELCO EST	18-8836-1	18-5354	18-5405	18-5108	18-5107-1	18-7648	N/A	N/A	18-5281
5.0GL	PRESTOLITE	18-8802-1	18-5352	18-5403	-	N/A	18-5437	N/A	N/A	N/A
5.0GL	DELCO EST	18-8836-1	18-5354	18-5405	18-5108	18-5107-1	18-5443	N/A	N/A	18-5281
5.0GX	DELCO EST	18-8836-1	18-5354	18-5405	18-5108	18-5107-1	18-7648	N/A	N/A	18-5281
5.0GX	DELCO HVS	18-8828-1	18-5244	18-5245	18-7642	18-5117	18-5467	N/A	N/A	18-5247
5.0GXIE	DELCO HVS	18-8828-1	18-5244	18-5245	18-7642	18-5117	18-5467	N/A	N/A	18-5247
5.0OSIE	DELCO HVS	18-8828-1	18-5244	18-5245	18-7642	18-5117	18-5467	N/A	N/A	18-5247
5.0OSi	DELCO HVS	18-8828-1	18-5244	18-5245	18-7642	18-5117	18-5467	N/A	N/A	18-5247
5.7GI	DELCO EST	18-8836-1	18-5354	18-5405	18-5108	18-5107-1	18-7648	N/A	N/A	18-5281
5.7GIC	DELCO HVS	18-8828-1	18-5244	18-5245	18-7642	18-5117	18-5467	N/A	N/A	18-5247
5.7GiCE	DELCO HVS	18-8828-1	18-5244	18-5245	18-7642	18-5117	18-5467	N/A	N/A	18-5247
5.7GiE	DELCO HVS	18-8828-1	18-5244	18-5245	18-7642	18-5117	18-5467	N/A	N/A	18-5247
5.7Gi	DELCO HVS	18-8828-1	18-5244	18-5245	18-7642	18-5117	18-5467	N/A	N/A	18-5247
5.7Gi	DELCO EST	18-8836-1	18-5354	18-5405	18-5108	18-5107-1	18-5443	N/A	N/A	18-5281
5.7GL	MALLORY	18-8802-1	18-5352	18-5403	-	-	-	N/A	N/A	N/A

APPLICATION CONTINUED ON NEXT PAGE

VOLVO PENTA IGNITION APPLICATION (Cont.)

Model	Distributor	Spark Plug Wire Set	Distributor Cap	Rotor	Pick-Up Coil	ICM	Ignition Coil	Condenser	Contact Points	Tune-Up Kit
5.7GL	DELCO EST	18-8836-1	18-5354	18-5405	18-5108	18-5107-1	18-5443	N/A	N/A	18-5281
5.7GL	PRESTOLITE	18-8802-1	18-5352	18-5403	-	N/A	18-5437	N/A	N/A	N/A
5.7GSi	DELCO EST	18-8836-1	18-5354	18-5405	18-5108	18-5107-1	18-5443	N/A	N/A	18-5281
5.7GSii	DELCO EST	18-8836-1	18-5354	18-5405	18-5108	18-5107-1	18-5443	N/A	N/A	18-5281
5.7GSP	PRESTOLITE	18-8802-1	18-5352	18-5403	-	N/A	18-5437	N/A	N/A	N/A
5.7GXi	DELCO EST	18-8836-1	18-5354	18-5405	18-5108	18-5107-1	18-7648	N/A	N/A	18-5281
5.7GXiCE	DELCO HVS	18-8828-1	18-5244	18-5245	18-7642	18-5117	18-5467	N/A	N/A	18-5247
5.7GXiC	DELCO HVS	18-8828-1	18-5244	18-5245	18-7642	18-5117	18-5467	N/A	N/A	18-5247
5.7GXiE	DELCO HVS	18-8828-1	18-5244	18-5245	18-7642	18-5117	18-5467	N/A	N/A	18-5247
5.7GXi	DELCO HVS	18-8828-1	18-5244	18-5245	18-7642	18-5117	18-5467	N/A	N/A	18-5247
5.7GXii	DELCO HVS	18-8828-1	18-5244	18-5245	18-7642	18-5117	18-5467	N/A	N/A	18-5247
5.7GXii	DELCO EST	18-8836-1	18-5354	18-5405	18-5108	18-5107-1	18-5443	N/A	N/A	18-5281
5.7OSi	DELCO HVS	18-8828-1	18-5244	18-5245	18-7642	18-5117	18-5467	N/A	N/A	18-5247
5.7OSXi	DELCO HVS	18-8828-1	18-5244	18-5245	18-7642	18-5117	18-5467	N/A	N/A	18-5247
5.8Fi	FORD	18-8820-1	18-5248	18-5413	-	N/A	18-7492	N/A	N/A	N/A
5.8FL	PRESTOLITE	18-8803-1	18-5352	18-5403	-	N/A	18-5437	N/A	N/A	N/A
5.8FSi	PRESTOLITE	18-8803-1	18-5352	18-5403	-	N/A	18-5437	N/A	N/A	N/A
7.4Gi	DELCO EST	18-8836-1	18-5354	18-5405	18-5108	18-5107-1	18-5443	N/A	N/A	18-5281
7.4GL	PRESTOLITE	18-8802-1	18-5352	18-5403	-	N/A	18-5437	N/A	N/A	N/A
7.4GL	DELCO EST	18-8836-1	18-5354	18-5405	18-5108	18-5107-1	18-5443	N/A	N/A	18-5281
7.4GSi	DELCO EST	18-8836-1	18-5354	18-5405	18-5108	18-5107-1	18-5443	N/A	N/A	18-5281
8.1Gi	DELCO	18-8838-1	N/A	N/A	N/A	N/A	18-7493	N/A	N/A	N/A
8.1Gi-A	DELCO	18-8838-1	N/A	N/A	N/A	N/A	18-7648	N/A	N/A	N/A
8.1Gi-B	DELCO	18-8838-1	N/A	N/A	N/A	N/A	18-7648	N/A	N/A	N/A
8.1Gi-BF	DELCO	18-8838-1	N/A	N/A	N/A	N/A	18-7648	N/A	N/A	N/A
8.1Gi-C	DELCO	18-8838-1	N/A	N/A	N/A	N/A	18-7493	N/A	N/A	N/A
8.1GiC-400	DELCO	18-8838-1	N/A	N/A	N/A	N/A	18-7493	N/A	N/A	N/A
8.1GiCE	DELCO	18-8838-1	N/A	N/A	N/A	N/A	18-7493	N/A	N/A	N/A
8.1GiE	DELCO	18-8838-1	N/A	N/A	N/A	N/A	18-7493	N/A	N/A	N/A
8.1Gii-A	DELCO	18-8838-1	N/A	N/A	N/A	N/A	18-7648	N/A	N/A	N/A
8.1Gii-B	DELCO	18-8838-1	N/A	N/A	N/A	N/A	18-7648	N/A	N/A	N/A
8.1Gii	DELCO	18-8838-1	N/A	N/A	N/A	N/A	18-7493	N/A	N/A	N/A
8.1GSi-A	DELCO	18-8838-1	N/A	N/A	N/A	N/A	18-7648	N/A	N/A	N/A
8.1GXi	DELCO	18-8838-1	N/A	N/A	N/A	N/A	18-7493	N/A	N/A	N/A
8.1GXii	DELCO	18-8838-1	N/A	N/A	N/A	N/A	18-7493	N/A	N/A	N/A
8.1GXi-A	DELCO	18-8838-1	N/A	N/A	N/A	N/A	18-7648	N/A	N/A	N/A
8.1GXi-AF	DELCO	18-8838-1	N/A	N/A	N/A	N/A	18-7648	N/A	N/A	N/A
8.1GXii-A	DELCO	18-8838-1	N/A	N/A	N/A	N/A	18-7648	N/A	N/A	N/A
8.1IPS	DELCO	18-8838-1	N/A	N/A	N/A	N/A	18-7493	N/A	N/A	N/A
8.1OSi	DELCO	18-8838-1	N/A	N/A	N/A	N/A	18-7493	N/A	N/A	N/A
8.2GL	PRESTOLITE	18-8803-1	18-5352	18-5403	-	N/A	18-5437	N/A	N/A	N/A
8.2GSi	DELCO EST	18-8836-1	18-5354	18-5405	18-5108	18-5107-1	18-5443	N/A	N/A	18-5281
DPX375	DELCO	18-8838-1	N/A	N/A	N/A	N/A	18-7648	N/A	N/A	N/A
DPX375-CF	DELCO	18-8838-1	N/A	N/A	N/A	N/A	18-7493	N/A	N/A	N/A
DPX385	DELCO EST	18-8836-1	18-5354	18-5405	18-5108	18-5107-1	18-5443	N/A	N/A	18-5281
DPX415	DELCO EST	18-8836-1	18-5354	18-5405	18-5108	18-5107-1	18-5443	N/A	N/A	18-5281
DPX420	DELCO	18-8838-1	N/A	N/A	N/A	N/A	18-7648	N/A	N/A	N/A
DPX420-CF	DELCO	18-8838-1	N/A	N/A	N/A	N/A	18-7493	N/A	N/A	N/A
V6-200	DELCO HVS	18-8829-1	18-5243	18-5245	18-7642	18-5117	18-5467	N/A	N/A	18-5246
V6-225	DELCO HVS	18-8829-1	18-5243	18-5245	18-7642	18-5117	18-5467	N/A	N/A	18-5246
V8-225	DELCO HVS	18-8828-1	18-5244	18-5245	18-7642	18-5117	18-5467	N/A	N/A	18-5247
V8-270	DELCO HVS	18-8828-1	18-5244	18-5245	18-7642	18-5117	18-5467	N/A	N/A	18-5247
V8-300	DELCO HVS	18-8828-1	18-5244	18-5245	18-7642	18-5117	18-5467	N/A	N/A	18-5247
V8-320	DELCO HVS	18-8828-1	18-5244	18-5245	18-7642	18-5117	18-5467	N/A	N/A	18-5247

APPLICATION CONTINUED ON NEXT PAGE

VOLVO PENTA IGNITION APPLICATION (Cont.)

Model	Distributor	Spark Plug Wire Set	Distributor Cap	Rotor	Pick-Up Coil	ICM	Ignition Coil	Condenser	Contact Points	Tune-Up Kit
V8-350	N/A	18-8838-1	N/A	N/A	N/A	N/A	-	N/A	N/A	N/A
V8-380	N/A	18-8838-1	N/A	N/A	N/A	N/A	-	N/A	N/A	N/A
V8-430	N/A	18-8838-1	N/A	N/A	N/A	N/A	-	N/A	N/A	N/A

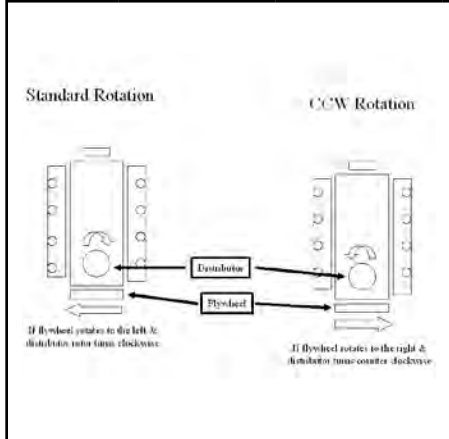



**18-6839
STARTER**
Replaces: 1357199, -7, 3523301, -4,
5003564, -1
Fits: 240,740,760,780,940 series 2.3L



**18-6872
STARTER**
(12 Volt)
Replaces: 233991, 240501, 837924,
842775, 843511, 847306-8, 881681
Fits: 12V; TAMD, MD, AQD Models



**18-6956
STARTER**
Replaces: 3803227, -2, 834625-6,
841378-3, 841380, 841762, 63, 65, 66,



**18-6958
STARTER**
(24 Volt)
Replaces: 847308-4, 870998, 881682
Fits: 24V; MD, TMD, TAMD Models



**18-59710
ALTERNATOR**
Replaces: 820652, 822454,
827303, 847651, 849561, 849602
Fits: 24V; AQ Series gas and diesel
24V systems



**18-5882
ALTERNATOR**
Replaces: 3884950
75A, 12V, Serpentine
3.0L, 4.3L, 5.0L, 5.7L, 8.1L (2007 - Current)



**18-5957
ALTERNATOR**
Replaces: 3860769
(3-Wire) (68 AMP)
Replaces Mando, Motorola and Original Equipment Delco.
Uses same electrical connections and mounting method.
Equipped with fan and drive pulley.
SAEJ1171



**18-59700
ALTERNATOR**
Replaces: 3803227, -2, 834625-6,
841378-3, 841380, 841762, 63, 65, 66



**18-5979
ALTERNATOR**
Replaces: 3860082, Mando AC165622,
Lester 12391
65 amp, 3.0GSM-A/B/C, 3.0GSP-A/B/C, 3.0GLM-A/B,
3.0GLP-A/B, 4.3GX-I-A/B/BF/C.C.F.D.DF, 4.3OSI-B/BF/C/
CF/D/DF, 5.0GX-I-A



**18-5959
ALTERNATOR**
Replaces: 826495, 834609,
834963, 841762, 841765, 841766.
Valeo A13N1M, 2M, 147M, 148M
14V/50 AMP: AQ120-AQ145, AQ200D-AD290-TMD40-
MD21-8070-MD5C, MD18-7D-MD30-TMD30-TAM30,
MD18-MD2B-MD2BHY-MD3B-MD21A, MD32A-
AQD32A/270D (Mot V8S), MD5-MD7-MD11-MD17-B21-
B22 Mot. TMD40), Series 2002-2003-R,V,S.



**18-6261
ALTERNATOR**
Replaces: 3856600-6, 3857561
Mando for Late Model Volvo
Penta, 12 Volt, 65 Amp,
Internal Regulator, Single
Groove Pulley



**18-6265
ALTERNATOR**
Replaces: 3857813
Mando for Late Model Volvo Penta, 12 Volt,
65 Amp, Internal Regulator, Single Groove
Pulley



**18-5939
ALTERNATOR**
Replaces: 872235, 3803260, 873770
Valeo: A13N234, 2541451
14V/60 AMP: AQ115, AQ120B, AQ125, AQ130, AQ140, AQ145, AQ165, AQ170, AQ200, AQ225, AQ256, AQ260, AQ280, AQ290, BB115, BB145, MB20; Diesel Engine Application: AQD2B, AQD21A, AQD21B, AQD27, AQD29, AQD32A, MD11C, MD11D, MD17C, MD17D, MD2B, MD2010A, MD2010B, MD2030A, MD2030B, MD2040A, MD2040B, MD21A, MD21B, MD27, MD29, MD3B, MD32A, MD6A, MD6B, MD7, TAM71A, TAM71B, TAM72A, TAM72WI-A.



**18-5943
ALTERNATOR**
Replaces: 872926, 3803227
Valeo: A13N259, 541663
14V/50 AMP: 431, 500, 501, 570, 740DP, 740/MSS, AQ131, AQ145B, AQ175, AQ200, AQ205, AQ211, AQ225, AQ260, AQ271, AQ290, AQ311, BB165, BB170, BB225, BB231, BB260, BB261; Diesel Engine Application: 2001, 2002, 2003, 2003T, AD31A, AQAD30A, AQAD31A, AQAD40A, AQAD41, AQAD41A, AQD40A, AQD41, AQD41A, KAD42A, KAMD42A, MD30A, MS31A, MD40A, MD7B, TAMD40A, TAMD41A, TAMD41B, TAMD41D, TAMD70E, TMD30A, TMD31A, TMD40A, TMD41A.



**18-6845
ALTERNATOR**
Replaces: 3862613, 3862665, 3884950
Fits: 3.0GLM, 3.0GLP Engines



**18-6846
ALTERNATOR**
Replaces: Volvo Penta 1502272, 3803270-2, 5001677, 845940, 72021, 872022, 872757, 873635, 873757, 873757-9, 873771,



**18-6847
ALTERNATOR**
Replaces: 3862613, 2655301,
Fits: 2000-07 3.0GLP, GSP, GSM, 4.3GXl, 5.0GXl, Si, 5.7Gi, GXi, Osi, Sxi



**18-5976
ALTERNATOR**
Replaces: Motorola 9AR3743G, 510-821, 510-802, 510-835, 510-836, 510-856, 510-861, 510-862
Valeo 2937430
28V/45 AMP: TAMD120, TMD100, TMD120



**18-6975
ALTERNATOR (Universal)**
Fits: High amp 160A alternator, universal mounting pattern based on Delco CS1300 design, v-belt and 6 groove serpentine pulley included



**18-6848
ALTERNATOR**
Replaces: Volvo 3862612, 2656299, Valeo A0002655299
Fits: 2000 and on Volvo Penta Models w/ 4.3, 5.0, and 5.7 GM engines



**18-6953
ALTERNATOR**
Replaces: Volvo
Fits: Diesel D3 Models



**18-6955
ALTERNATOR**
Replaces: Caterpillar 3001117, 10-258, Prestolite 110-258, 110-258A, Volvo 849748-9
Fits: Volvo Diesel 6 cylinder models

ALTERNATOR/STARTER APPLICATION

GASOLINE ENGINES

Model	Engine	Year	Starter	Alternator	Model	Engine	Year	Starter	Alternator
AQ115			18-5918	N/A	AQ131D	4 cyl	1985-1989	18-5906	18-5959
AQ120B			18-5918 ①	N/A	AQ140A			18-5918 ③	18-5959
AQ120B			18-5906	N/A	AQ140A			18-5906 ②	18-5959
AQ125A			18-5918 ①	18-5959	AQ145			18-5918	18-5959
AQ125A	4 cyl	1981-1985	18-5906 ②	18-5959	AQ145A	4 cyl	1979-1985	18-5918 ③	18-5959
AQ125B	4 cyl	1981-1985	18-5906 ②	18-5959	AQ145A	4 cyl	1979-1985	18-5906 ⑤	18-5959
AQ130			18-5918	N/A	AQ145B	4 cyl	1979-1985	18-5906 ⑤	18-5959
AQ131A	4 cyl	1985-1989	18-5906	18-5959	AQ151A	4 cyl	1985-1989	18-5906	18-5959
AQ131B	4 cyl	1985-1989	18-5906	18-5959	AQ151B	4 cyl	1985-1989	18-5906	18-5959
AQ131C	4 cyl	1985-1989	18-5906	18-5959	AQ151C	4 cyl	1985-1989	18-5906	18-5959

① Below SN 7679/013489 ② AQ125A beginning with S/N 7679/013489 ③ Below SN 7705/001557 ④ AQ145A & BB145A beginning with SN 7705/001557
 ⑤ 18-5959 14V/50AMP ⑥ Mounting screw threads into bracket ⑦ 18-5939 14V 50 AMP

Model	Engine	Year	Starter	Alternator	Model	Engine	Year	Starter	Alternator
AQ165			18-5918	N/A	BB115			18-5918	N/A
AQ170			18-5918	N/A	BB140A			18-5918 ③	18-5959
AQ171A	4 cyl	1986-1994	18-5906	18-5959 ⑥	BB140A			18-5906	N/A
AQ171C	4 cyl	1986-1994	18-5906	18-5959 ⑥	BB145			18-5918	N/A
AQ175A			18-5911 ⑤	N/A	BB145A	4 cyl	1979-1985	18-5918 ③	18-5959
AQ190A			18-5903	N/A	BB145A			18-5906 ⑤	N/A
AQ200B			18-5911	18-5959	BB165			18-5918	N/A
AQ200C			18-5911	18-5959	BB170			18-5918	N/A
AQ200D			18-5911	18-5959	BB225A			18-5911	18-5959
AQ200F			18-5911	18-5959	BB225B			18-5911	18-5959
AQ205A			18-5911	N/A	BB225C			18-5911	18-5959
AQ211A			18-5911	N/A	BB260A			18-5911	18-5959
AQ225A			18-5911	18-5959	BB260B			18-5911	18-5959
AQ225B			18-5911	18-5959	BB260C			18-5911	18-5959
AQ225C			18-5911	18-5959	230			18-5906	18-5943
AQ225D			18-5911	18-5959	250			18-5906	18-5943 ⑦ 18-5939 ⑧
AQ225E			18-5911	18-5959	251A			18-5906	N/A
AQ225F			18-5911	18-5959	430			18-5911	18-5943 ⑦
AQ231A			18-5911	N/A	431			18-5911	18-5943 ⑦
AQ231B			18-5911	N/A	432			18-5911	18-5943 ⑦
AQ240A			18-5903	N/A	434			N/A	N/A ⑦ 18-5939 ⑧
AQ255A			18-5911	N/A	500-570			18-5911	18-5943 ⑦ 18-5939 ⑧
AQ255B			18-5911	N/A	571A			18-5911	N/A N/A
AQ260A			18-5911	18-5959	572			18-5911	18-5943 18-5939 ⑧
AQ260B			18-5911	18-5959	740B			18-5911	18-5943 18-5939 ⑧
AQ271A			18-5911	N/A	3.0L			18-5919	N/A
AQ271B			18-5911	N/A	4.3L			18-5913	N/A
AQ271C			18-5911	N/A	5.0L (GM)	V-8	1994-2007	18-5913	N/A
AQ271D			18-5911	N/A	5.7L (GM)	V-8	1994-2007	18-5913	N/A
AQ280			18-5911	N/A	7.4L (GM)	V-8	1994-2007	18-5913	N/A
AQ290A			18-5911	18-5959	8.2L (GM)	V-8	1994-2007	18-5913	N/A
AQ311A			18-5911	N/A	5.0L (FORD)	V-8	1994	18-5920	N/A
AQ311B			18-5911	N/A	5.8L (FORD)	V-8	1994	18-5920	N/A

① Below SN 7679/013489 ② AQ125A beginning with S/N 7679/013489 ③ Below SN 7705/001557 ④ AQ145A & BB145A beginning with SN 7705/001557
 ⑤ 18-5959 14V/50AMP ⑥ Mounting screw threads into bracket ⑦ 18-5939 14V 50 AMP



18-6291
SOLENOID
 Replaces: 3854194-2, OMC 3854194
 Fits: Ford Gear Reduction
 Starters on Late Model 5.0L, 5.8L,
 OMC and Volvo Penta



18-5806
SOLENOID
 Replaces: 834520
 BOSCH 0331-302-050, 0331-302-081,
 0331-302-085, 0331-302-581, 0331-302-585
 For starters with aluminum nose.
 Slot in end of solenoid shaft is 13/32" long.



18-5811
STARTER SOLENOID
 Replaces: 3850216, 3859054
 For: PG 260 series starters, GM V6 & V8 (1983-Up)



18-5837
SOLENOID
 Replaces: 3853869, 3853998
 For: 3.0 ; GL, GS, 4.3L GL, GS, 5.7L GL, GI,
 7.4L GL, 8.2L GL



18-9802
TIMING LIGHT
 Self-powered accurate up to 10,000 RPM's



18-69550
CIRCUIT BREAKER
 Replaces: 3854164
 Fits: Volvo Multiple Gasoline Engine Applications



18-6271
RELAY
 Replaces: 870670, 6643474,
 876038, 241812
 12 Volt, 30 Amp



18-6268
RELAY
 Replaces: 841177, 872272
 12 Volt, 30 Amp



18-6266
RELAY
 Replaces: 876040, 872300
 12 Volt, 30 Amp/20 Amp continuous

① **18-5705D** Display Package



18-5705
POWER TRIM RELAY
 Replaces: 876039
 5 Terminal
 For: AQ 175, 200, 225D,
 260, 290A



18-5700
TRIM RELAY
 Replaces:
 3858081, 3858809
 For: (1998 SX-M-MAC, MDA, MLT), 3.0GLP-D,
 4.3GL-E, 4.3GL-EF, 4.3GXl-F, 4.3GXl-FF, 4.3OSl-F,
 4.3OSl-FF, 5.0GL-F, 5.0GL-FF, 5.0GXl-F, 5.0GXl-FF,
 5.0Sl-F, 5.0Sl-FF, 5.7Gl-F/FF, 5.7GXl-G/GF, 5.7OSl-E/
 EF, 5.7OXl-E/EF, 5.7Gl-F, 5.7GXl-G, 8.1Gl-G/GF,
 8.1GXl-F/FF, 8.1OSl-C/CF, 8.1Gl-G, 8.1GXl-F, DPH-A,
 DPH-B, DPR-A, DPH-B, EF drives, SX-M TSKs 1998-
 05, SX-M, DP-SM, (WT drives, PJX-C, PJX-S SX-M,
 -MACLT, -MDA, -MDB, -MHP, -MTD, DP-E, DP-S, -S1,
 -S2, DP-SM, -SM)XDP-B



18-5704
POWER TRIM RELAY
 Replaces: 876037
 20 Amps Resistive
 15 Amps Inductive
 Single Pull 5 Terminal
 For: AQ270, 280

PKG. OF 5



18-6951
18-6951-9②
POWER TILT FUSE
(30 Amp)
 Replaces: 851120



18-6770
TILT/TRIM PUMP
 Replaces: 854346
 Oil-dyne
 For: Early Version SX Drive with 2.5" bolt centers and
 fine threads
 Motor **18-6817**



18-6806
TRIM PUMP ASSEMBLY
 Replaces: 3587079, 3857489, 3860879
 For: SX - Late Model with Coarse Thread
 Motor **18-6804**



18-6822
TRIM PUMP
 Replaces: Volvo Penta 852928, 820545,
 OMC 172543, 382715
 Motor **18-6838**



18-6804
TRIM MOTOR
 Replaces: 3861575
 For: SX Drives - Later Version / 2.3" Bolt Centers w/
 Coarse Thread



18-6817
TRIM MOTOR
 Replaces: 854525-3, 3858071
 Fits: Late model Volvo Penta
 For: SX - Early Version / Fine thread & 2.5" bolt centers



18-6838
TRIM MOTOR
 Replaces: 3586765, 852928, 872449,
 873051
 Fits: DP, DPX Drives
 Replacement pump **18-6822**



18-6881
TRIM MOTOR WITH PUMP
 Replaces: Volvo 852928, 872449, 873051,
 Fits: DP, DPX Drives
 Motor **18-6838**
 Pump **18-6822**



18-6823
WIRING HARNESS
 Replaces: Universal
 Converts 3-wire Tilt and Trim motors to 2-Wire design

① Items ending in "D" are Display Packaged - Regular number is Non-Display
 ② Priced per package



**18-6274
TILT/TRIM MOTOR**
Replaces: 852928, 3857265
Replaces : Prestolite HYK4001
Includes Hydraulic Valve Body



**18-6758
TILT/TRIM MOTOR**
Replaces: 850834
Electrolux KP5024/120



**18-6779
TRIM MOTOR**
Replaces: 986280, 3853945
For: P,JX, SX, DPS, DP, DPX, 3.0L GS,
GL, 4.3L GL, GS, GI, 5.0L FL, FI, 5.7L
GL, GI, 5.8L FL, FI, FSI



**18-6790
TILT MOTOR**
Replaces: 839430,
Electrolux KS3448/290
Fits: Older model Volvo



**18-6791
TILT MOTOR**
Replaces: 850046, 853520
Fits: Older model Volvo



**18-6792
TILT MOTOR**
Replaces: 897720, 854329
Fits: Older model Volvo



**18-7641
CARBURETOR
(Remanufactured)**
Replaces: 841047-4, 841313-0, 3856393
AQ225B,C,D,E,F; 225A,B; AQ260A,B; 290A; BB225A,AV,
BB225B,C; 260A,AV,B,C; 501A, 501A/MS4A; 570/MS4A
Use Replacement Carb Kit **18-7095**



**18-79998
CARBURETOR
(Remanufactured)**
Replaces: R80316
Fits: 3.0L GL, GS



**18-80008
CARBURETOR
(Remanufactured)**
Replaces: R7044289
Fits: 7.4L w/ 4bbl Rochester



**18-7000
CARB KIT**
Replaces: 841836-0, 841292
SOLEX DOWN DRAFT
(856471 + 856472 = 18-7000)



**18-7001
CARB KIT**
Replaces: 841293-4
SOLEX SIDE DRAFT



**18-7008
CARB KIT**



**18-7040
CARB KIT**
Contains adjustable needle & seats



**18-7072
CARB KIT**
Replaces: 855889



**18-7085
CARB KIT**
Replaces: 875407



**18-7086
CARB KIT**
Replaces: 841994



**18-7095
CARB KIT**
Replaces: 834985-4



**18-7237
CARB KIT**



**18-7238
CARB KIT**
Replaces: 3854020
For: 4.3L GL, GS, 5.0L GL, 5.7L GL



**18-7241
CARB KIT**
Replaces: 3855017
For: 7.4L GL, 8.2L GL



**18-7242
CARB KIT**
Replaces: 3854105



**18-7244
CARB KIT**
Replaces: 3854106



**18-7245
CARB KIT**
Replaces: 3854107



**18-7246
CARB KIT**
Replaces: 3854116
For: 3.0L GLM, GLP, GSM, GSP, GS, GL



**18-7099
CARB GASKET SET**
Replaces: 824803, 856470



**18-7200
FLOAT**
Replaces: 841634-9
(ALCOHOL RESISTANT)
Plastic



**18-7201
FLOAT**
(ALCOHOL RESISTANT)
Brass



**18-7202
FLOAT**
(ALCOHOL RESISTANT)
Brass



**18-36905
FLOAT**
Replaces: 3854018
Fits: 3.0L GLM, GLP w/2 bbl Holley Carb

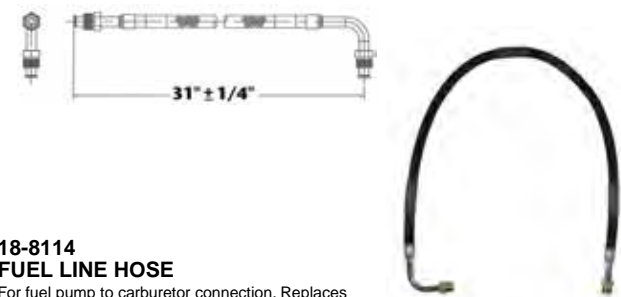

**18-8114
FUEL LINE HOSE**
For fuel pump to carburetor connection. Replaces copper or steel tubing 3/8" X 31" PTFE composite hose with 5/8"-18 male inverted flare straight one end, 5/8"-18 90° one end. SAE J1527 type A1

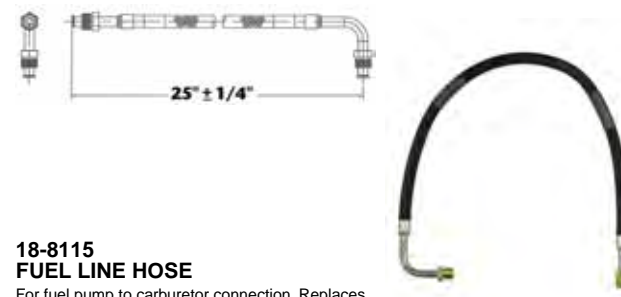

**18-8115
FUEL LINE HOSE**
For fuel pump to carburetor connection. Replaces copper or steel tubing 3/8" X 25" PTFE composite hose with 5/8"-18 male inverted flare straight one end, 5/8"-18 90° one end. SAE J1527 type A1

CARBURETOR KIT/FLOAT/CARBURETOR GASKET KIT APPLICATION

Model	Cyl.	Mfg Code	Carb Model	Carburetor #	Carb Kit ①	Carb Float	Carb Gasket Kit
AQ115A,B,125A,B,130C,D, AQ131A,B,C,D,145A,B AQ151A,B,C,171A,C BB115B,C,145A	4	—	—	SOLEX 44 PA1	18-7000	—	18-7099
AQ120B,140A,BB140A	4	—	—	SOLEX 44 PHN-3	18-7001	—	—
AQ80	4	—	—	ZENITH 34VN	18-7008	—	—
AQ95,95A,100,105A,110, 115 W/109", (1780cc) Dual Carb. Installation	4	ZS-1	150CD	150CD-SE (C1865F,R, C304D,F,R)	18-7085	—	—
AQ120, AQ130A,B,BB115A,w. 121" (1986cc) Dual Carb. Installation	4	ZS-1	175CD	175CD-2S, (C3098F,R, C3200 F,R,C,3231 F,R)	18-7085	—	—
3.0L GL,GS	4	H-2	2300	R-80316A,R-80316-1A	18-7246	—	—
AQ170A,B,C,BB170A,B,C	6	—	—	SOLEX 44 PA1	18-7000	—	18-7099
AQ165A,BB165A (3 Carb. Installation)	6	ZS-1	175CD	175CD-2S, (C3201F,M, R,C 3232F,M,R)	18-7085	—	—
AQ175A	6	R-2	2GE	17059059	18-7086	18-7200	—
4.3L GL,GS	6	H-2	2300	R-80312A,R-80312-1A	18-7238	—	—
4.3L GL,GS	6	H-4	4160	R-80403A,R-80403-1A	18-7237	—	—
AQ200D,F and 500A	8	R-2	2GE	17057133, 17059059	18-7086	18-7200	—
AQ225B,C,D,E,F,255A,B, AQ260A,B,290A,BB225A,AV, BB225B,C,260A,AV,B,C	8	R-4	4ME	17059283,296, 298	18-7095	18-7201	—
501A,501A/MS4A,570/MS4A 305" (5.0L),307" (5.0L),350" (5.7),	8	R-4	4MC, 4MV	7044288,7044289, 1705,628717,057,290	18-7072	18-7201	—
5.0L, 5.8L (Fi, FL,SX) (Ford)	8	H-2	2300	R-80382A,R-80382-1A	18-7244	—	—
5.0L, 5.8L (Fi, FL) (Ford)	8	H-4	4150	R-80383A,R-80383-1A	18-7245	—	—
740A/MS5A	8	H-4	4011	R84026AA	18-7040	—	—
454" (7.4L)	8	R-4	4MC, 4MV	7044288,7044289, 1705,628717,057,290	18-7072	18-7201	—
7.4L GL	8	H-4	4150	R-80378A,R-80378-1A	18-7242	—	—
8.2L GL	8	H-4	4150	R-80378A,R-80378-1A	18-7242	—	—

① Does not include metering rods



18-7326
ELECTRIC FUEL PUMP
Replaces: 3850809,
3858261, 3854620, 3857986



18-7330
ELECTRIC FUEL PUMP
Replaces: 3857650, 3855958



18-7331
ELECTRIC FUEL PUMP
Replaces: 3850810,
3857985, 3858714

ELECTRIC FUEL PUMP APPLICATION

Year	Engine	Application	OE #	#'s Superseded from	Part #
1994-99	262/4.3L (HU-WT)	High Pressure pump	3857650		18-7330
1994-99	262/4.3L GL/GS (All)	Carbureted - Low Pressure	3858261	3850809	18-7326
1994-99	262/4.3L GI (HU-WT)	W.Elec. Pump - Low Pressure	3858261	3850809	18-7326
1994-99	454/7.4L & 502/8.2L (HU-WT)	Low pressure system	3858714	3850810, 3857985	18-7331
1993-99	350/5.7L, 454/7.4L, & 502/8.2L	Engines w/MPI - High Pressure	3857650		18-7330
1996-99	454/7.4L & 502/8.2L (HU-WT)	Engines w/MPI - High Pressure	3857650		18-7330
1994-99	5.0L thru 5.8L	Low pressure electric fuel pump	3858261	3850809	18-7326
1994-99	454/7.4L & 502/8.2L (HU-WT)	GM Mark V Eng. - Low Pressure	3858714	3850810, 3857985	18-7331
1992-93	454/7.4L	GM Mark V Eng. - Low Pressure	3858714	3850810, 3857985	18-7331



18-7268
FUEL PUMP
Replaces: 3855276
For: 5.7L Liter Engines
Dual Diaphragm requires sight glass



18-7281
FUEL PUMP
Replaces: 826493
For: GM (V-8) 305, 350
(Includes gasket)



18-7286
FUEL PUMP
Replaces: 841161
For: XP stamped steel pump
AQ120B (spec# 867465), AQ125A/B, AQ131A/B/C/D,
AQ140A (spec# 867464), BB140A, AQ145A, BB145A,
AQ151A/B/C, AQ171A/C, AQ230A/B, AQ250A/B, AQ251A



18-35442
FUEL PUMP
Replaces: 859428
Fits: Volvo Late 2000 Series Engines



18-7229
FLAME ARRESTOR
Replaces: 3854026
For: 3.0L GS, GL, 4.3L GL, GS, GSI, 5.0L
FL, FI, 5.7L GL, GI, 5.8L FL, FI, FSI

- UNIVERSAL DESIGN -

FUEL WATER SEPARATOR BRACKETS



Bracket Type	Part #	Bracket Type	Part #
1/4" Stainless Steel	18-7777	1/4" Aluminum	18-7853-1
3/8" Stainless Steel	18-7776	3/8" Aluminum	18-7775

FUEL WATER SEPARATOR KITS



21 MICRON FILTER KITS FOR CARBURETED ENGINES

Kit Type	Part #	Micron Rating	Contents
1/4" Aluminum (Short Filter)	18-7848-1 •	21	1 - 18-7844 filter & 1 18-7853-1 bracket 2 - 18-4256 1/4" pipe plugs
1/4" Aluminum Bonus Pack Contains spare filter	18-7848-2 •	21	2 - 18-7844 filter & 1 18-7853-1 bracket 2 - 18-4256 1/4" pipe plugs
1/4" Aluminum (Tall Filter)	18-7852-1 •	21	1 - 18-7845 filter & 1 18-7853-1 bracket 2 - 18-4256 1/4" pipe plugs
1/4" Aluminum Bonus Pack Contains spare filter	18-7852-2 •	21	2 - 18-7845 filter & 1 18-7853-1 bracket 2 - 18-4256 1/4" pipe plugs
3/8" Aluminum (Tall Filter)	18-7775-1 •	21	1 - 18-7845 filter & 1 18-7775 bracket 2 - 18-4264 3/8" pipe plugs
1/4" Stainless Steel (Tall Filter)	18-7777-1 •	21	1 - 18-7845 filter & 1 18-7777 bracket 2 - 18-4256 1/4" pipe plugs
3/8" Stainless Steel (Tall Filter)	18-7776-1 •	21	1 - 18-7845 filter & 1 18-7776 bracket 2 - 18-4264 3/8" pipe plugs

10 MICRON FILTER KITS FOR FUEL INJECTED ENGINES



Kit Type	Part #	Micron Rating	Contents
1/4" Aluminum (Short Filter)	18-7983-1 •	10	1 - 18-7944 filter & 1 18-7853-1 bracket 2 - 18-4256 1/4" pipe plugs
1/4" Aluminum Bonus Pack Contains spare filter	18-7983-2 •	10	2 - 18-7944 filter & 1 18-7853-1 bracket 2 - 18-4256 1/4" pipe plugs
1/4" Aluminum (Tall Filter)	18-7982-1 •	10	1 - 18-7945 filter & 1 18-7853-1 bracket 2 - 18-4256 1/4" pipe plugs
1/4" Aluminum Bonus Pack Contains spare filter	18-7982-2 •	10	2 - 18-7945 filter & 1 18-7853-1 bracket 2 - 18-4256 1/4" pipe plugs
1/4" Aluminum (High Capacity Filter)	18-7966-1 •	10	1 - 18-7866 filter & 1 18-7853-1 bracket 2 - 18-4256 1/4" pipe plugs
3/8" Aluminum (Tall Filter)	18-7986-1 •	10	1 - 18-7945 filter & 1 18-7775 bracket 2 - 18-4264 3/8" pipe plugs
1/4" Stainless Steel (Tall Filter)	18-7984-1 •	10	1 - 18-7945 filter & 1 18-7777 bracket 2 - 18-4256 1/4" pipe plugs
3/8" Stainless Steel (Tall Filter)	18-7985-1 •	10	1 - 18-7945 filter & 1 18-7776 bracket 2 - 18-4264 3/8" pipe plugs

• Display Packaged



10 MICRON FILTER KITS WITH DRAIN BOWLS

Sierra AquaVue™ and metal bowl separator filters allow water to be drained from the filter to extend service life. Use the AquaVue™ bowl for outboard, above deck installations. USCG regulations require the use of the flame resistant metal bowl below deck.

Kit Type	Part #	Micron Rating	Contents
1/4" Aluminum w/ metal drain bowl	18-7951 •	10	1 - 18-7919 filter & 1 18-7853-1 bracket 1 - 18-7924 metal bowl 2 - 18-4256 1/4" pipe plugs
1/4" Stainless Steel w/ metal drain bowl	18-7938 •	10	1 - 18-7919 filter & 1 18-7777 bracket 1 - 18-7924 metal bowl 2 - 18-4256 1/4" pipe plugs

VOLVO STYLE BRACKETS AND SEPARATOR KITS

18-7778
VOLVO ALUMINUM
REPLACEMENT BRACKET
Replaces: 3850861



COMPACT BRACKET AND SEPARATOR KIT - FOR SMALL OUTBOARDS AND FRESH WATER APPLICATIONS

18-7774
COMPACT ALUMINUM BRACKET



18-7965-1
10 MICRON COMPACT
SEPARATOR KIT
Contains:
1 - 18-7774 bracket
1 - 18-7865 filter



REPLACEMENT FILTERS



UNIVERSAL DESIGN

10 MICRON REPLACEMENT FILTERS		21 MICRON REPLACEMENT FILTERS	
Part #	Description	Part #	Description
18-7944	Short - 3.875"	18-7844	Short - 3.875"
18-7945	Long - 4.35"	18-7845	Long - 4.35"
18-7866	High Capacity - 6"		
18-7865	Compact 10 Micron		

REPLACEMENT FILTERS FOR VOLVO

10 MICRON REPLACEMENT FILTERS			21 MICRON REPLACEMENT FILTERS		
Part #	Description	Replaces	Part #	Description	Replaces
18-7946	OMC thread		18-7846	OMC thread	
18-7989	Volvo SX/EFI Cobra EFI	Volvo 3851218-2, 3852413, 3862228	18-7789	Volvo SX/EFI Cobra EFI	Volvo 3851218-2, 3852413



10 MICRON REPLACEMENT FILTERS AND KITS WITH DRAIN BOWLS

REPLACEMENT FILTERS			REPLACEMENT BOWLS	
Part #	Description	Replaces	Part #	Description
18-7919	Spin on replacement	Racor S3213	18-7924	Metal Collection Bowl
18-7920	Spin on replacement	Racor S3214		
18-7947	Spin on replacement Fits - 120RRAC01	Racor S3240	FILTER & BOWL KITS	
18-7948	Spin on replacement Fits - 320RRAC01	Racor S3227	Part #	Description
18-7949	Spin on replacement Fits - 660RRAC02	Racor S3232	18-7929 •	Filter & Metal Bowl Contains: 18-7919 filter, 18-7924 bowl

**18-8125
DIESEL FUEL FILTER**

Replaces: 3583443
 D4-180i-B, D4-180i-C, D4-210A-A, D4-210A-B, D4-210i-A, D4-210i-B, D4-225A-B, D4-225A-C, D4-225i-B, D4-225i-C, D4-260A-A, D4-260A-B, D4-260A-C, D4-260D-B, D4-260D-C, D4-260i-A, D4-260i-B, D4-260i-C, D4-300A-A, D4-300A-C, D4-300D-A, D4-300D-C, D4-300i-A, D4-300i-C, D6-280A-A, D6-280A-B, D6-280i-A, D6-280i-B, D6-310A-A, D6-310A-B, D6-310D-A, D6-310D-B, D6-310i-A, D6-310i-B, D6-330A-B, D6-330A-C, D6-330D-B, D6-330D-C, D6-330i-B, D6-330i-C, D6-350A-A, D6-350A-B, D6-350A-C, D6-370A-B, D6-370A-C, D6-370D-A, D6-370D-B, D6-370D-C, D6-370i-A, D6-370i-B, D6-370i-C, D6-435D-A, D6-435D-C, D6-435i-A, D6-435i-C



**18-8126
DIESEL FUEL FILTER**

Replaces: 861477
 D1-13 A, D1-13 B, D1-20 A, D1-20 B, D1-30 A, D1-30 B, D2-40 A, D2-40 B, D2-55 A, D2-55 B, D2-55 C, D2-55 D, D2-55 E, D2-55 F, D2-75 A, D2-75 B, D2-75 C, D2-75 F, MD2010A, MD2010B, MD2020A, MD2020B, MD2030A, MD2030B, MD2040A, MD2040B



**18-7858
FUEL FILTER**

Replaces: 858201
For CAV Type Unit
 AQ120B, 125A, B, 131A, 140A, 145A, B, 151, BB, 140, 145A



**18-7862
FUEL FILTER ELEMENT
(Includes Gasket)**

Replaces: 841162



**18-8149
HIGH CAPACITY FUEL WATER SEPARATING FILTER**

Replaces: Volvo 3847644
 Fits most gasoline applications with electric fuel pump. (some height restrictions may occur when using with 18-7778, Volvo 3850861)



**18-7942
FUEL FILTER**

Replaces: 466987, 3825133
 For: MD100A, TMD100A, MD100B, MD120A, TMD120A, TAMD120A, MD120B, TMD120B, TAMD120B, MD70B, TM-D70B, TAMD70B, THAMD70B, AQAD70B, MD70C, TMD70C, TAMD70C, AQD70C, TAMD60A, TAMD60B, TAMD60C, D5/ D7 MARINE GENSET, D5A-T, D5A-TA, D7A-T, D7A-TA, D7C-TA, D63 MARINE, D71/73 MARINE, KAD32P, TAMD42WJ, KAD43P/44P/300, KAMD43P/44P/300, TAMD103A, TAMD61A, TAMD62A, TAMD71A, TAMD72A, TAMD72P, TAMD72WJ, TAMD74, TAMD75 MARINE, TMD102A, TAMD102A, TAMD102D, TM-D122A, TAMD122A, TAMD122P, TMD31L, TAMD31P/L/M/S, AD31P/L, TMD41L, TAMD41P/L/M/H



**18-7709
FUEL FILTER**

Replaces: 3840335
 Fits: KAD42P-A, KAMD42P-1, KAD44P-B, KAD44P-C, KAMD44P-A, KAMD44P-B, KAMD44P-C, TAMD42WJ-A, KAD43P-A, KAMD43P-A, KAT44P-C, KAD300-A, KAMD300-A, MD6A, MD6B, MD7A, MD7B, D41L-A, TAMD41H-B, TMD41L-A, AD41L-A, AD41P-A, TAMD41H-A, TAMD41P-A, MD22A, MD22A-A, MD22L-A, TMD22A, TMD22-A, D3-110i-A, D3-130A-A, D3-130i-A, D3-160A-A, D3-160i-A, D3-110i-B, D3-110i-C, D3-130A-B, D3-130i-B, D3-130A-C, D3-130i-C, D3-160A-B, D3-160i-B, D30160A-B, D3-160A-C, D3-160i-C, D3-190A-B, D3-190i-B, D3-190A-C, D3-190i-C, KKAD42A, KAMD42A, AD41D, D41D, TAMD41D, TMD41D, MD22L-B, MD22P-B, TMD22-B, TMD22P-C, TAMD22P-B



**18-7859
FUEL FILTER**

Replaces: 835576
 For: AQ175, 200, 226, 266, 290 BB200, 225, 260



**18-8124
DIESEL FUEL FILTER**

Replaces: 829913
 Fits: 2001, 2001B, 2002, 2002B, 2003, 2003B/T/TB, AQD2B, MD11C/D, MD17C/D, MD1B, MD2B, MD3B, MD5A/B/C, MD7/B



**18-7792
FUEL FILTER**

Replaces: 3855104
 For: Volvo 3.0L (1994-99), OMC 3.0L (1995-98)





**18-7964-1
TRANSMISSION
FILTER KIT**
For: Mercruiser V-8 Inboard
with Hurth Transmission



**18-7717
FILTER ELEMENT**
For: Rochester 2 bbl &
4 bbl Carburetors



**18-79007
AIR FILTER**
Replaces: 3825038
Fits: TAMD63L-1, TAMD63P-A



**18-7689
FUEL INJECTOR**
Replaces: 3855182
Fits: 5.7GLPMDA, 5.7GIPMDA, 5.7GIPMDACE, 5.7GLIM-
DA, 5.7GIIMDA, 4.3GLPHUB, 4.3GSPHUB, 4.3GSPHUS,
4.3GIPHUSCE, 5.7GIPHUS, 4.3GLPNCA, 4.3GLPNCB,
4.3GLPNCS, 4.3GSJNCC, 4.3GSJNCS, 4.3GSPNCA,
4.3GSPNCB, 4.3GSPNCM, 4.3GSPNCS, 4.3GIPNCA,
4.3GIPNCBCE, 4.3, 5.7GLPNCS, 5.7GIPNCA,
5.7GIPNCSCE, 5.7GIPNCMCE, 5.7GIPNCBCE,
5.7GIINCCCE, 5.7GIINCSCCE, 4.3GLPLKD, 4.3GLPLKE,
4.3GSPCLKD, 4.3GSPLKE, 4.3GIPLKDC, 4.3GIPLKECE,
4.3GSJLKD, 5.7GLPLKA, 5.7GLPLKD, 5.7GLPLKE,
5.7GLPLKR, 5.7GSPCLKD, 5.7GSPLKE, 5.7GLIPLKDC,
5.7GIPLKDC, 5.7GIPLKECE, 5.7GSIPLKD, 5.7GSIPLK,
4.3GLPBYC, 4.3GSPBYC, 4.3GIPBYCCE, 4.3GSJBYA,
4.3GIJBYA (1994-07)



**18-7685
TBI INJECTOR**
Replaces: 3858941
Fits: 4.3GXi-A, 4.3GLPWTC, 4.3GLPWTR,
4.3GSPWTC, 4.3GSPWTR, 4.3GIPWTC,
4.3GIPWTR, 4.3GIJWTR, 4.3GSJWTR ,
4.3GLPEFS, 4.3GIPEFS



**18-7702
AIR CHARGE
TEMPERATURE SENDER**
Replaces: 3854527
Fits: 5.0L Gxi-A(2001-02), 5.7L GiL-A
(2001), 5.7L Gi-A(2000-01), 5.7L GSiL-A
(2000-01), 5.7L Gxi-A(00-01), 5.7L XiL-A
(00-01), 5.7L Gxi-B(01-02), Many 7.4L
(1994-00), Many 8.1L (2005-Current)



**18-7601
AIR CHARGE
TEMPERATURE
SENSOR**
Replaces: 3854158
For: 5.0 Fi/5.8 Fi (1994-96) &
5.0 FL/5.8 FL/5.8 FSi (1995-96)



**18-7513
TEMPERATURE SENSOR**
Replaces: 3862500



**18-7647
TEMPERATURE SENDER**
Replaces: 872066
Fits: 4.3GL-A, 4.3GL-B, 4.3GL-C, 4.3GL-D,
5.7GL-A, 5.7GL-B, 5.7GL-C, 5.7GL-D, 5.7GL-E,
5.0GL-A, 5.0GL-B, 5.0GL-C, 5.0GL-D, 5.0GL-E,
3.0GLP-A, 3.0GLP-B, 3.0GLM-A, 3.0GLM-B,
3.0GSP-A, 3.0GSP-B, 3.0GSP-C, 3.0GSM-A,
3.0GSM-B, 3.0GSM-C, 3.0GLM-C, 3.0GLP-C,
3.0GLP-D, 4.3GL-E, 4.3GL-EF, 5.0GL-F, 5.0GL-
FF, 3.0GLP-E, 4.3GL-G, 4.3GL-GF, 4.3GL-J,
4.3GL-JF, 5.0GL-H, 5.0GL-HF, 3.0GLP-J,
3.0GLP-N, 5.0GL-J, 5.0GL-JF (1998-2007)



**18-5897
TEMPERATURE
SENDER**
Replaces: 3853787
For: 5.0L FL, FI, 5.8L FL, FI, FSi



**18-5894
OIL PRESSURE LIGHT
SWITCH**
Replaces: 3852215



**18-7700
THROTTLE
POSITION SENSOR**
Replaces: 3857487
Fits: 4.3, 5.0, 5.7, 8.1, 8.2L models



**18-5899
OIL PRESSURE SENDER**
Replaces: 3857532
For: 230, 250, 3.0L GLM, GLP, GSM,
GSP, 4.3L GL, GXI, OSI, 5.0L GL, GXI,
OSI, 5.7L GL, GI, GXI, GIL, GXIL, OSI,
OSXi, 8.1L GI, GXI, OSI, GIL



**18-7704
IAC MOTOR**
Replaces: 3855194



**18-7705
IAC MOTOR**
Replaces: 3843751



**18-7684
MAP SENSOR**
Replaces: 3850396
Fits: 4.3, 5.0, 5.7, 7.4L models
(1994-2007)



**18-7677
KNOCK SENSOR**
Replaces: 3850357
Fits: 4.3, 5.0, 5.7L models (2002-07)



**18-7703
KNOCK SENSOR**
Replaces: 3854512
Fits: 7.4, 8.2L (1999-2001)



**18-7679
KNOCK SENSOR**
Replaces: 3854905
Fits: 4.3L (1994-2002), 5.0L Gxi-A
(2001-02), 5.7L GiL-A(2001), 5.7Gi-A,
5.7GXi-A, 5.7GXi-B, 5.7GiL-A, 5.7GSiL-A,
5.7GXiL-A, 5.7GXiL-B(2000-03), 5.7GLPNCS,
5.7GIPNCA, 5.7GIPNCSCE,
5.7GIPNCA, 5.7GIPNCSCE,
5.7GIINCCCE, 5.7GIINCSCCE(1995-96)



**18-33800
PCV VALVE**
Replaces: 3856884
Fits: 4.3L EFI



**18-7888
DRAIN PLUG
& GASKET**
Replaces: 826648, 862293
For CAV Filter

PKG OF 10



SNAPPER CLAMPS

Part #	Range	Size
18-8200 ①	.360 - .406	2
18-8201 ①	.410 - .468	4
18-8202 ①	.475 - .536	6
18-8020 ①	.538 - .608	8
18-8021 ①	.597 - .665	10
18-8034 ①	.670 - .780	12
18-8203 ①	.750 - .875	14
18-8204 ①	.875 - .975	19



**18-3506
CIRCULATING PUMP**
Replaces: 21124846



**18-3593
CIRCULATING
WATER PUMP**
Replaces: 3854017, 3858340
Fits: 3.0L 4 cyl. engines, GM 4 cyl. & in-line 6 cyl.
Uses gasket **18-0327** (included)
(Bi-Directional)



**18-3577-2
CIRCULATING WATER PUMP**
Replaces: 3855991, 856609
For: GM Big Block V8
Uses gasket **18-0903** (included)
(Bi-Directional)



**18-3584
CIRCULATING WATER PUMP**
Replaces: 3853796
For Ford 5.0 and 5.8
Uses gasket **18-0147** (included)
(Bi-Directional)



**18-3586-1
WATER PUMP**
Replaces: 841640
(Crank Shaft Mounted)
Fits: 431A, 500A/B, 501A, 570A, 571A, AQ180, AQ200, AQ200B/C/D/F, AQ250A, AQ211A, AQ225, AQ231A/B, AQ260, AQ255B, AQ260A, AQ271A/B/C/D/, AQ280A, AQ290A



**18-3599-2
CIRCULATING WATER PUMP**
Replaces: 3853850, 835390, 856364
For GM V-6 & small block V-8 engines
Uses gasket **18-0981** (included)



**18-0368
WATER CIRCULATING
PUMP GASKET SET**
Fits: B21, B23, AQ120B, AQ125A, AQ140A, BB140A, AQ145A, BB145A



**18-2779
EXHAUST HOSE**
Replaces: 3852696
I.D. 4" x
For: 4.3L GL, GS, GI, GXI, OSI, 5.0L FI, GL, FL, GXI, OSI, 5.7L GL, GI, GIL, OSI, GXI, OSXI, 5.8L FL, FI, FSI, 7.4L GL, GI, 8.1L GI, GXI, OSI, 8.2L GL



**18-2780-1
HOSE**
Replaces: 3852741, 3863450
I.D. 4" x
For: 3.0L GL, GS, GI, GLM, GLP, GSM, GSP, GS, 4.3L GL, GS, GI, GXI, OSI, 5.0L FL, FI, GL, GXI, OSI, 5.7L GL, GI, GXI, OSI, OSXI, GIL, GXIL, 5.8L FL, FI, FSI, 7.4L GL, GI, GSI, 8.2L GSI



**18-2781
EXHAUST HOSE**
Replaces: 3852742
I.D. 4" x
For: 5.0L FL, GL, GXI, OSI, 5.7L GL, GI, GXI, GIL, GXIL, OSI, OSXI, 5.8L FL, FSI, 7.4L GL, GI, GSI, 8.1L, 8.2L GL, GSI



**18-3106
WATER PUMP COUPLER**
Replaces: 806256, 831009
AQ90, 95, 100, 110, 120A, 115, 130, MB3B, 17C, D



**18-3175
WATER PUMP COUPLER**
Replaces: 858467
Fits: D31, D32, D41, D42, D43, D44, D300, AD31A, AD31B, AD31D, AD31L-A, AD31P-A, AD31XD, AQAD31A, MD31A, TAMD31A, TAMD31B, TAMD31D, TAMD31L-A, TAMD31M-A, TAMD31P-A, TMD31A, TMD31B, TMD31D, TMDL-A, KAD32P-A, AD41A, AD41B, AD41D, AD41L-A, AD41P-A, AQAD41A, D41A, D41B, D41D, D41L-A, TAMD41A, TAMD41B, TAMD41D, TAMD41H-A, TAMD41L-A, TAMD41M-A, TAMD41P-A, TMD41A, TMD41B, TMD41D, TMD41L-A, KAD42A, KAD42B, KAD42P-A, TAMD42B, TAMD42WJ-A, KAD43P-A, KAMD43P-A, KAD44P-A, KAD44P-B, KAD44P-C, KAMD44P-A, KAMD44P-B, KAMD44P-C, KAD300A, KAMD300A

① This product is priced per piece. To order priced per package, please add -9 to the part number.



18-3274
IMPELLER KEY
 Replaces: 808007
 MD21B, AQD21B, 230A/SP-A/
 MT, 230A, 230B, 250A, 250B,
 AQ125B, AQ145B, AQ131A,
 AQ151, AQ151A, AQ151B,
 AQ151C, AQ171, AQ171A,
 AQ171C, 251A



18-3275
IMPELLER KIT
 Volvo 877066
 Fits: TAMD74A, A-A, A-B (2000-2005); TAMD74C-A, C-B (2000-2005); TAMD74L-A, B (1999-2005); TAMD74P-A, P-B (1998-2005); TAMD75P-A (1998-2005); TAMD71B (1989-2000); TAMD73P-A (1997-1998); TAMD73WJ-A (1997-1999).



18-3504
IMPELLER KIT
 Volvo 3588475
 Fits: D4-180I-B, D4-180I-C, D4-180I-D, D4-210A-A, D4-210A-B, D4-210I-A, D4-210I-B, D4-225A-B, D4-225A-C, D4-225A-D, D4-225I-B, D4-225I-C, D4-225I-D, D4-260A-A, D4-260A-B, D4-260A-C, D4-260A-D, D4-260D-B, D4-260D-C, D4-260D-D, D4-260I-A, D4-260I-B, D4-260I-C, D4-260I-D, D4-300A-A, D4-300A-C, D4-300A-D, D4-300D-A, D4-300D-C, D4-300D-D, D4-300I-A, D4-300I-C, D4-300I-D



18-3276-1
IMPELLER KIT
 Replaces: 3862567, 21213660
 Fits: Volvo (1999 and Later)



18-3277
IMPELLER KIT
 Replaces: 3862281, Yanmar
 192470-42530, 192470-42532
 Fits: Volvo (1998 and Earlier),
 Johnson Pump 09-812B-1



18-3047
IMPELLER KIT
 Replaces: 835874
 Sherwood 10615K,
 Jabsco 18948-0001
 12 FINS



18-3060
IMPELLER
 Replaces: 835512, 3854286
 Sherwood 9959,
 Jabsco 18838-0001
 Oberdorfer 132-0317
 OMC 3854286
 Neoprene, 12 FINS



18-3046
IMPELLER
 Replaces: 3854286



18-3061
IMPELLER
 Replaces: 835874,
 Sherwood 0615K,
 Jabsco 18948-0001
 Neoprene
 12 FINS
 For: GM engines with V-Belt

① 18-3046D



18-30778
IMPELLER
 Replaces: 21213664
 Fits: Gas GM engines 2005 & Up



18-3075
IMPELLER KIT
 Replaces: 875575, Jabsco 2877-0001,
 4568-0001, Johnson 09-801B,
 Oberdorfer B6620
 12 FINS
 Neoprene

① 18-3075D



18-3076
IMPELLER KIT
 Replaces: 875583, 833995
 Jabsco 22405-0001
 Johnson Pump 09-45589,
 09-808B
 6 FINS, Neoprene



18-3077 (Neoprene)
18-3038 (Nitrile)
WATER PUMP KIT
 Replaces: 877061-2, 3841697
 For: AQ 30, 31, 40, 41 AQD 19, 27, 29, 32, KAD/KAMD
 42A, B, P, MD, 19, 27, 29, 32, TAMD 60A, B, C



18-3078 (Neoprene)
18-3037 (Nitrile)
WATER PUMP KIT
 Replaces: 875736, 875660, 2430184
 Jabsco 836-0003,
 Johnson Pump 09-1029B-9
 For: AQ, AD 40 A, B, TAMD 40 A, B, TAMD 61-62 A, 71-72A



18-3287
IMPELLER KIT
 Replaces: 876120
 Fits: 431A, BB231A, 570A, 571A, 572A, 740A, 740B,
 AQ200D, AQ205A, AQ225D, AQ255B, AQ260A, AQ260B,
 AQ271A, AQ271B, AQ271C, AQ271D, AQ280A, AQ290A,
 AQ311A, AQ311B, BB225A, BB225AV, BB225B, BB260A,
 BB260AV, BB261A

① Items ending in "D" are Display Packaged - Regular number is Non-Display



18-3079
IMPELLER KIT
 Replaces: 875807-0, 3586498
 Johnson Pump 09-806B Sherwood 9979K
 6 FINS
 Neoprene
 Jabsco 4528-0001
 Side Width 3/4" Dia. 1 9/16"



18-3080
(Neoprene)
WATER PUMP KIT
 Volvo 875808, 3593659
 Jabsco 673-0001
 Johnson Pump 09-1026B-1
 For: AQ 60, 80, 90, 95, 100, 105, 110, 115, 120A, 130, B 16, BB 25, 30, 70, 100, MB 18, 20, MD 3B, 17C, D, ND2010B, 2020B, 2030B, 2040BC

18-3036
(Nitrile)
 Volvo 875808-8
 Jabsco 673-0003
 Johnson Pump 09-1026B-9



① **18-3081D**



18-3081
IMPELLER KIT
 Replaces: 875811-2, 3858256, 3862281
 OMC 3858256
 Johnson Pump 09-1027B
 Neoprene
 12 SPLINES 12 FINS
 Jabsco 1210-0001



18-3089
WATER PUMP KIT
 Replaces: 09-45825
 Johnson Pump
 For 18-3587-1 Pump



18-3205
WATER PUMP REPAIR KIT
 Replaces: 875574
 AQ120B, 125A, B, 131A, 140A, 145A, B, 151A, B



18-3208
WATER PUMP REPAIR KIT
 Replaces: 875584
 MD5A, B, C, MD6B, MD7A, B, MD11C, D



18-3209
WATER PUMP REPAIR KIT
 Replaces: 875383
 AQ165A, 170A, B, C, MD21A
 (S/N MD103387 & UP), MD21B



18-3261
WATER PUMP REPAIR KIT
 Replaces: 875769
 Fits: D40, AD40B, AQAD40A, AQAD40B, TAMD40A, TAMD40B



18-3262
WATER PUMP REPAIR KIT
 Replaces: 875759
 For sea water pumps: Fits: D30, D31, D32, D40, D41, D42, D43, D44, AD30A, AQAD30A, TAMD30A, TMD30A, AD31A, AD31B, AD31D, AD31XD, AQAD31A, MD31A, TAMD31A, TAMD31B, TAMD31D, TMD31A, TMD31B, TMD31D, KAD32P-A, AQD40A, MD40A, TMD40A, TMD40B, TMD40C, AD41A, AD41B, AD41D, AQAD41A, D41A, D41B, D41D, TAMD41A, TAMD41B, TAMD41D, TMD41A, TMD41B, TMD41D, KAD42A, KAD42B, KAD42P-A, KAMD42A, KAMD42B, KAMD42P-A, TAMD42B, TAMD42WJ-A, KAD43P-A, KAMD43P-A, KAD44P-A, KAMD44P-A





18-3263
WATER PUMP REPAIR KIT
 Replaces: 875698
 For sea water pumps: Fits: B18, B20, D3, D17, AQ60F, AQ90, AQ95A, AQ110, AQ120, BB30, BB100, MB18, AQ105A, AQ115A, AQ115B, AQ130A, AQ130B, AQ130C, AQ130D, BB115, BB115B, BB115C, MB20A, MB20B, MB20C, MD3B, MD17C, MD17D,

SINGLE DIAMETER HOSE

 <p>18-70021 MOLDED HOSE 3/4" ID</p> <p style="text-align: right; font-size: 1.2em;">4 3/4"</p>	 <p>18-70704 MOLDED HOSE 1 1/4" ID</p> <p style="text-align: right; font-size: 1.2em;">5"</p>	
 <p>18-70924 MOLDED HOSE 1 3/4" ID</p> <p style="text-align: right; font-size: 1.2em;">5"</p>	 <p>18-71218 MOLDED HOSE 1" ID</p> <p style="text-align: right; font-size: 1.2em;">12 1/2"</p>	 <p>18-71337 MOLDED HOSE 1 3/4" ID</p> <p style="text-align: right; font-size: 1.2em;">12 3/4"</p>

STRAIGHT HOSE

 <p>18-75100 MOLDED HOSE Straight 48" 1" ID</p>	 <p>18-75125 MOLDED HOSE Straight 48" 1 1/4" ID</p>
---	--

V-BELTS



- 1** High strength synthetic cords resist shockload failure. Their low stretch properties assure uniform performance over the life of the belt.
- 2** The compression section is a special rubber compound that assures smooth and even transfer of load forces to the cords.
- 3** Cogs are molded to precise engineering tolerances to improve flexibility and maintain cord support. Cog geometry provides a large area for air circulation to keep the belt cool and prevent damaging heat build up in the cushion section.
- 4** Rubber edges maintain positive, no-slip contact with pulley grooves for reliable energy transfer.

BELT SIZE LISTING BY NUMBER

Part #	Effective Length (Inches)	Top Width (Inches)	Part #	Effective Length (Inches)	Top Width (Inches)	Part #	Effective Length (Inches)	Top Width (Inches)
18-15290	29	29/64	18-15405	40 1/2	29/64	18-15460	46	29/64
18-15300	30	29/64	18-15410	41	29/64	18-15470	47	29/64
18-15325	32 1/2	29/64	18-15415	41 1/2	29/64	18-15480	48	29/64
18-15345	34 1/2	29/64	18-15430	43	29/64	18-15495	49 1/2	29/64
18-15370	37	29/64	18-15435	43 1/2	29/64	18-15500	50	29/64
18-15380	38	29/64	18-15440	44	29/64	18-15520	52	29/64
18-15390	39	29/64	18-15450	45	29/64	18-15550	55	29/64
18-15400	40	29/64	18-15455	45 1/2	29/64	18-17570	57	17/32

V-BELT INTERCHANGE

Part #	Volvo #	Part #	Volvo #	Volvo #	Part #	Volvo #	Part #
18-15325	958303	18-15460	829207	829207	18-15460	985357	18-15415
18-15390	958310	18-15460	950818	841821	18-15430	958498	18-4046
18-15405	958311	18-15495	958320	950813	18-15410	966694-2	18-4044
18-15410	950813	18-15500	952141	950818	18-15460	966857	18-4046
18-15415	985357	18-4046	958498	952141	18-15500		
18-4044	966694-2	18-4046	966857	958303	18-15325		
18-15430	841821			958310	18-15390		
18-15435	958314			958311	18-15405		
18-15435	966382			958314	18-15435		
18-15450	3858462			958320	18-15495		
18-15455	3852464			966382	18-15435		

HOSE INTERCHANGE

Part #	Volvo #	Part #	Volvo #	Volvo #	Part #	Volvo #	Part #
18-70704	838513	18-75125	826423	826423	18-75125	845792	18-75125
18-70704	856306	18-75125	845792	838513	18-70704	856306	18-70704

**Fits GM Small Block V8 305-350 cu. in.
Models AQ & BB 200, 205, 211, 231, 225,
260, 271, 290, 311, 500, 501, 570, 571 & 572**

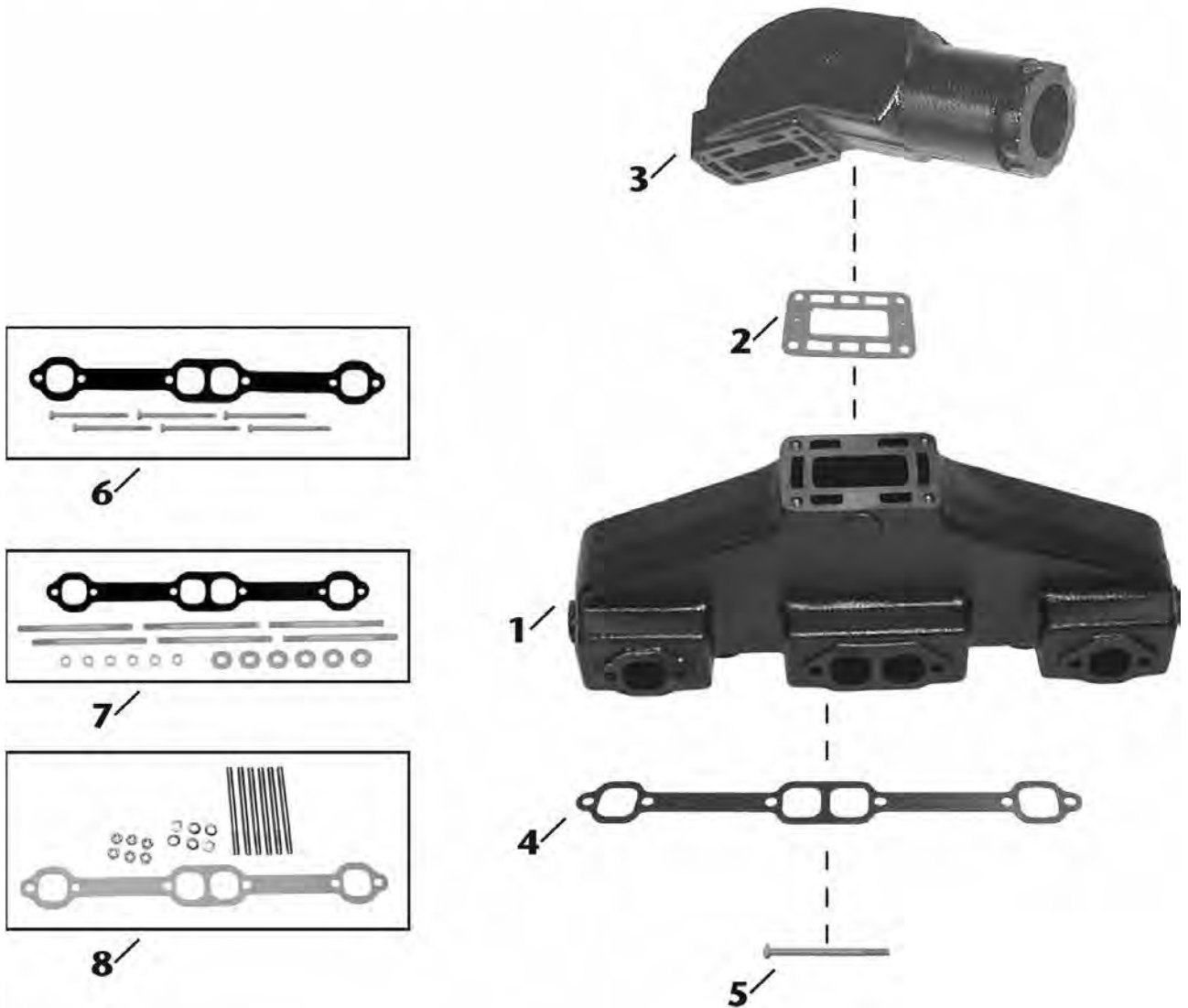

Item No	Description	OE No.	Application
1	18-1931-1 MANIFOLD	835804-6	GM Small Block (V8) 305-350 cu.in. Model AQ & BB 200, 205, 231, 225, 260, 271, 290, 311, 500, 501, 570, 571, & 572. Use with Manifold Gasket: 18-2949; Mounting Kit: 18-8511.
2	18-2971-1 ELBOW GASKET	856039-3	Use with Manifold: 18-1931-1; Elbow: 18-1935-1
3	18-1935-1 ELBOW	855384-4	Use with Manifold: 18-1931-1; Elbow Gasket: 18-2971-1.
4	18-2949 MANIFOLD GASKET	N/A	Use with Manifold: 18-1931-1; Included in 18-8511 mounting kit.
5	NSS MOUNTING BOLT	N/A	Included in 18-8511 mounting kit.
6	18-8511 MOUNTING KIT	N/A	Use with Manifold: 18-1931-1.
7	18-8502 MOUNTING KIT	N/A	Use with Manifold: 18-1931-1. Includes mounting studs and hardware.
8	18-8502 MOUNTING KIT	N/A	Use with Manifold: 18-1931-1. Includes mounting studs and hardware.

Fits GM V6 (1993 & Before) AQ 175, 205, 430A/B, 431, 434

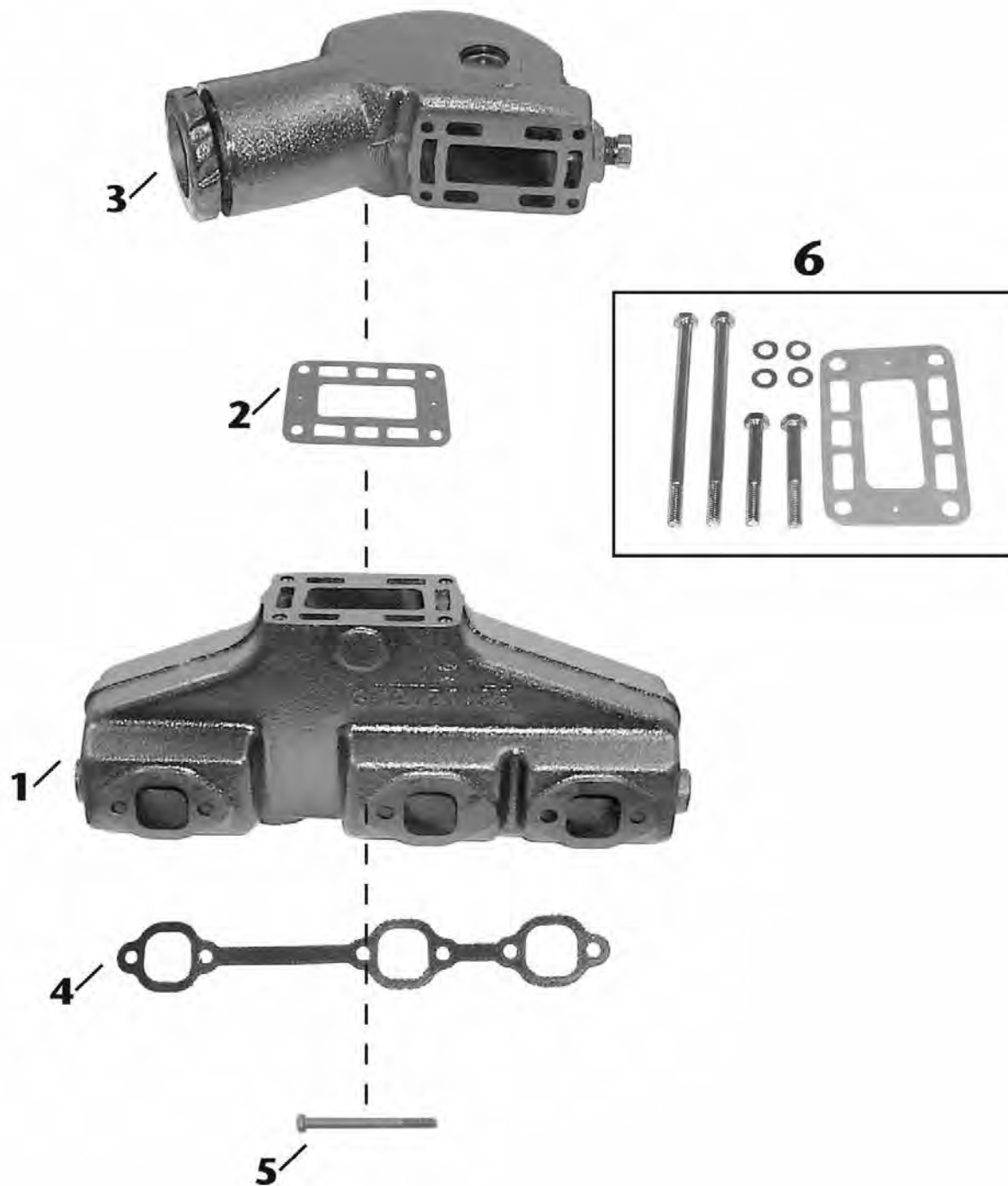

Item No	Description	OE No.	Application
1	18-1932 MANIFOLD	856894-1	GM (V6) (1993 & Before) Model AQ 175, 205, 430 A/B, 432, 434. Use with 18-2909 Manifold Gasket.
2	18-2971-1 ELBOW GASKET	856039-3	Use with Manifold: 18-1932; Elbow: 18-1936.
3	18-1936 ELBOW	857037-6	Use with Manifold: 18-1932; Elbow Gasket: 18-2971-1
4	18-2909 MANIFOLD GASKET	N/A	Use with Manifold: 18-1932.
5	NSS MOUNTING BOLT	N/A	Use to secure 18-2909 to 18-1932.
6	18-19360 HARDWARE KIT	N/A	Use with 18-1936 Elbow

SIERRA MANIFOLDS ARE PAINTED, PACKAGED & LEAK TESTED



**18-1848
MANIFOLD**
Replaces: 3857656, 3847499
Fits: Volvo 4.3L V-6



**18-1898
MANIFOLD**
Port & Starboard
Replaces: Barr CHVA-1-84, Marine Power 0991-110
Fits 454 cu.in. GM big block V8 engines
Use with:
Exhaust Manifold Gasket: 18-0418
***For Exploded View - See Pages 636-637**



**18-1930-2
MANIFOLD**
Replaces: 855387, 834438-4
FITS: Volvo AQ120B, 125A, 140A, 145A, BB140A, 145A
Supplied with Mounting Package
Use with:
Exhaust Manifold Gasket: 18-2991-1
Mounting Kit: 18-8539



**18-1931-1
MANIFOLD**
Port & Starboard
Replaces: 835804, 856883
FITS: Volvo AQ200D, 200F, 225D, 225E, 225F, 255B, 260A, 271A, 280A, 290A, 311A, AQ500, 570: BB225, 225AV, 225B, 260A, 260AV, 260B, 260C
Supplied with Mounting Package
Use with:
Mounting Kit: 18-8511



**18-1986-1
MANIFOLD**
Port & Starboard
Replaces: 3852374-2, 3857723, 3847501
Barr OMC-1-914035
For: 5.0L & 5.7L GM (New Style)
Use with:
Exhaust Manifold Gasket: 18-2949
Mounting Kit: 18-8502



**18-1932
MANIFOLD**
Port & Starboard
Replaces: 856894
For: 4.3L Fits: AQ175, AQ430, AQ431A, AQ431B, AQ432, AQ434
Use with:
Exhaust Manifold Gasket: 18-2909



**18-1997-1
MANIFOLD**
Port & Starboard
Replaces: Barr CHV-1-83
Universal Center Riser Manifold
FITS: GM 283, 305, 307 and 350 CID engines
Use with:
Exhaust Manifold Gasket Set: 18-0604
***For Exploded View - See Pages 638-639**



**18-1936
RISER**
Replaces: 857037
For: 4.3L Fits: AQ175, AQ430, AQ431A, AQ431B, AQ432, AQ434
Use with:
Riser Gasket: 18-2971-1
Mounting Kit: 18-19360



**18-1999
ELBOW**

Replaces: Barr 20-0082
 Comes with 18-4364 Exhaust Elbow Kit (open)
 If blocked mounting kit is required use 18-8535
 Replaces: Barr 20-0082-P
 Use with:
 Manifold: 18-1997-1
 Riser Gasket: 18-2854-1 open or 18-0476-1 blocked



**18-1935-1
RISER**

Replaces: 855384-4, 856891
 Use with:
 Manifold: 18-1931-1
 Exhaust Riser Gasket: 18-2971-1
 Mounting Kit: 18-8510



**18-1909-1
RISER**

Replaces: OMC 913784,
 3855270, 3850456,
 Volvo 3855270-9, 3863061
 OMC Riser, 4" outlet 7°
 Fits many GM & Ford center rise manifolds.
 Use with:
 Manifold: 18-1986-1 & 18-1848
 Riser Gasket: 18-0943-2 open
 Mounting Kit: 18-8507 open



**18-1939
RISER**

For use with 3 1/2" I.D. exhaust hose
 Replaces: Barr 20-0100, Marine Power 0992-593 Barr, Indmar,
 and Marine Power Ford Small Block V8 302-351cu.in., GM
 Small Block V8 305-350cu.in., GM Big Block V8 454cu.in.
 Use with:
 Manifold: 18-1997-1, 18-1998-1
 Riser Gasket: 18-2854-1 open or 18-0476-1 blocked
 Mounting Kit: 18-4364 open or 18-8535 blocked



**18-1907
RISER**

For use with 3" I.D. exhaust hose
 Replaces: Barr 20-0102, Indmar 53-2009, 53-2018 Barr
 and Indmar Ford Small Block V8 302-351cu.in.
 Use with:
 Manifold: 18-1997-1, 18-1998-1
 Riser Gasket: 18-2854-1 open or 18-0476-1 blocked
 Mounting Kit: 18-4364 open or 18-8535 blocked



**18-1876
RISER**

Replaces: 980617
 Use with:
 Manifold: 18-1904
 Riser Gasket: 18-2850
 Fits: 170 (1974), 175 (1975-76), 190 (1974-76), 235 (1975-76)



**18-1991
ELBOW ADAPTER**

Replaces: Barr 200089P
 For use with 3" I.D. Exhaust Hose
 Use with:
 Manifold Riser: 18-1999
 30°



**18-1992-1
ELBOW ADAPTER**

Replaces: Barr 200087P
 For 3" I.D. Exhaust Hose
 (As used in 18-1987 Exhaust Manifold
 Conversion Kit)
 80°

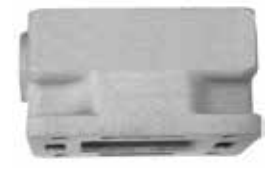

**18-1949
MANIFOLD SPACER**

Barr CM 20-0097
 Barr, Indmar and Marine Power Ford Small
 Block V8 302-351cu.in., GM Small Block
 V8 305-350cu.in., GM Big Block V8 454cu.
 in.
 Used with:
 Manifolds: 18-1998-1, 18-1997-1,
 18-1898



**18-4364 (Open)
EXHAUST ELBOW KIT**

Replaces: Barr 20-0082-P
 Use with:
 Riser: 18-1999, 18-1907, 18-1939



**18-0943-2
18-0943-2-9①
EXHAUST ELBOW GASKET**

Replaces: 3850496
 Used with:
 Riser: 18-1909-1



**18-2909
18-2909-9①
EXHAUST
MANIFOLD GASKET**

Replaces: 856116, 3853412
 For: Volvo 4.3GL, GS, GI, GXI, OSI



18-8502
EXHAUST MANIFOLD MOUNTING KIT
 OMC GM Small Block V8 305-350cu.in.
 (1979-89) OMC/Volvo GM Small Block
 305-350cu.in.
 Used with:
 Manifold: 18-1931-1, 18-1902, 18-1903
 & 18-1986-1



18-8507
EXHAUST ELBOW MOUNTING KIT
 Replaces: Barr 20 6674JP
 OMC/Volvo GM Small Block V8
 305-350cu.in.
 Used with:
 Riser: 18-1909-1



18-8510
EXHAUST ELBOW MOUNTING KIT
 Volvo GM Small Block V8 305-350cu.in.
 (Models: AQ and BB200, 205, 211, 231, 225,
 260, 271, 290, 311, 500, 501, 570, 571, 572)
 Used with:
 Riser: 18-1935-1



18-8511
EXHAUST MANIFOLD MOUNTING KIT
 Volvo GM Small Block V8 305-350cu.in.
 (Models: AQ and BB200, 205, 211, 231,
 225, 260, 271, 290, 311, 500, 501, 570,
 571, 572)
 Used with:
 Manifold 18-1931-1



18-8535 (Blocked)
EXHAUST ELBOW MOUNTING KIT
 Barr, Indmar and Marine Power Ford Small
 Block V8 302-351cu.in., GM Small Block V8
 305-350cu.in., GM Big Block V8 454cu.in.
 Used with:
 Riser: 18-1939, 18-1999, and 18-1907



18-8536
EXHAUST ELBOW MOUNTING KIT
 Barr, Indmar and Marine Power
 GM Small Block V8 305-350cu.in.
 Used with:
 Manifold: 18-1997-1



18-8538
EXHAUST MANIFOLD MOUNTING KIT
 Barr and Indmar Ford Small Block
 V8 302-351cu.in.
 Used with:
 Manifold: 18-1998-1



18-8539
EXHAUST MANIFOLD MOUNTING KIT
 Volvo 4 Cylinder B20 2.3 and 2.5L (Models:
 AQ 120, 125, 131, 140, 145, and 151.
 BB140, 145, 230, and 250) Volvo 4 Cylinder
 B20 2.3 and 2.5L (Models: AQ 120, 125,
 131, 140, 145, and 151. BB140, 145, 230,
 and 250)
 Used with:
 Manifold: 18-1930-2



18-19360
HARDWARE KIT
 Used with:
 Riser: 18-1936



18-0146
HEAT EXCHANGER GASKET SET
 Fits: B21, B23, AQ120B, AQ125A, AQ140A,
 BB140A, AQ125B, AQ145A, AQ145B, BB145A



18-0337
HEAT EXCHANGER GASKET SET
 Fits: AD40B, AQAD40A, AQAD40B, TAMD40A,
 TAMD40B, TMD40B, TMD40C

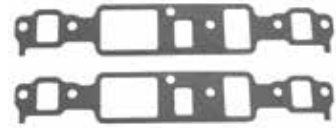

18-4408
**INTAKE MANIFOLD
 GASKET SET**
 Replaces: 3850379
 Fits: 4.3L GL, GS, GI



18-0476-1 (Blocked)
RISER BLOCKOFF GASKET
 Replaces: Barr 01-0105
 Indmar & Marine Power Ford
 Small Block V8 302-351cu.in.
 Used with:
 Riser: 18-1939, 18-1999 &
 18-1907

PKG. OF 2



18-2854-1 (Open)
18-2854-9^①
EXHAUST ELBOW GASKET
 Replaces: Barr 01-0107
 Used with:
 Manifold: 18-1999, 18-1939,
 18-1907

PKG. OF 2



18-2875-1
18-2875-1-9^①
EXHAUST ELBOW GASKET
 Replaces: 3850495
 For: 3.0L GS, GL, GLM, GLP, GSM, GSP

① Priced per Package



18-0418
EXHAUST MANIFOLD GASKET
Replaces: 3852472
For: Volvo 7.4L GL, GI, GSI, 8.2L GL, GI, GSI



18-0680
EXHAUST MANIFOLD GASKET
Replaces: 3853256



PKG. OF 2
18-2902-1
18-2902-1-9^①
MANIFOLD GASKET
Replaces: 3852468
For: 5.0L GL, GXI, OSI, 5.7L GL, GI, GXI, GIL, GXIL, OSI, GXIL, OSXI



PKG. OF 2
18-2949
18-2949-9^①
EXHAUST MANIFOLD GASKET
Replaces: Barr CHV-47-000
Used with: Manifold: 18-1986-1, 18-1997-1 and 18-1931-1
AQ200, 225, 260, 271, 290, 311



18-2971-1
EXHAUST MANIFOLD GASKET
Replaces: 835908-5, 856039-3
Used with: Riser: 18-1935-1



PKG. OF 4
18-2991-1
18-2991-1-9^①
EXHAUST MANIFOLD GASKET
Replaces: 855967, 855383
Used with: Manifold: 18-1930-2
AQ200, 225, 260, 271, 290, 311



18-4461
HOSE BARB
3/4" - 14 NPT x 1" Hose
Corrosion Resistant Brass Fitting



PIPE PLUGS

Part #	Thread Size
18-4256	1/4"
18-4257	1/4"
18-4258	3/4"
18-4263	1/8" - 27 NPT
18-4264	3/8" - 18 NPT

56507 Pipe Sealant with Teflon® is recommended for use on plug threads.

DRAIN TAPS

Part #	Replaces:
18-4216	807036
18-4218	82745
18-4218D ^②	
18-4219	829592
18-4697	
18-3223-9 ^③	

Bulk pack of 12 (18-4218)
Use with most OEM manifolds













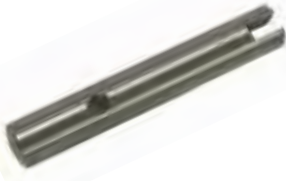







DRAIN TAP APPLICATION

Model	Thread Size	Location	Tap
MD1A,B,2A,B,3B,5A,B,MD6A	10 x 1	Cyl Block	18-4216
AQ90,95,100,110,115,120,125A,B,130,131A,140A,145A,B,151A,B,171A,MB18,MB20,BB30,100,AQD40,AQAD40,TMD40	1/4" NPT	Cyl Block	18-4218
MD5C,11C,D,17C,D	1/8" NPT	Cyl Block	18-4219
D40, 2001, 2002, 2003 V6, B23, B25, D30, D31, D40, D41	1/4" NPT	Oil Cooler	18-4697

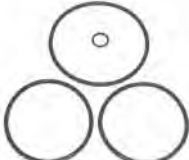
^① Priced per Package
^② Items ending in "D" are Display Packaged - Regular number is Non-Display
^③ This product is priced per piece. To order priced per package, please add -9 to the part number

Model	Exhaust Manifold	Exhaust Elbow	Manifold Mounting Kits	Exhaust Elbow Kits	Manifold Gasket	Elbow Gasket
230	18-1930-2	-	18-8539	-	18-2991-1	-
250	18-1930-2	-	18-8539	-	18-2991-1	-
AQ120B	18-1930-2	-	18-8539	-	18-2991-1	-
AQ125A	18-1930-2	-	18-8539	-	18-2991-1	-
AQ131A,B,C,D	18-1930-2	-	18-8539	-	18-2991-1	-
AQ140A	18-1930-2	-	18-8539	-	18-2991-1	-
AQ145A,B	18-1930-2	-	18-8539	-	18-2991-1	-
AQ151A,B,C	18-1930-2	-	18-8539	-	18-2991-1	-
AQ200C,D/280	18-1931-1	18-1935-1	18-8511 ^⑤ /18-8502 ^⑥	18-8510	18-2949	18-2971-1
AQ200D,F	18-1931-1	18-1935-1	18-8511 ^⑤ /18-8502 ^⑥	18-8510	18-2949	18-2971-1
AQ225C,D/280	18-1931-1	18-1935-1	18-8511 ^⑤ /18-8502 ^⑥	18-8510	18-2949	18-2971-1
AQ225D,E,F	18-1931-1	18-1935-1	18-8511 ^⑤ /18-8502 ^⑥	18-8510	18-2949	18-2971-1
AQ255A,B/280	18-1931-1	18-1935-1	18-8511 ^⑤ /18-8502 ^⑥	18-8510	18-2949	18-2971-1
AQ260A,B	18-1931-1	18-1935-1	18-8511 ^⑤ /18-8502 ^⑥	18-8510	18-2949	18-2971-1
AQ290A	18-1931-1	18-1935-1	18-8511 ^⑤ /18-8502 ^⑥	18-8510	18-2949	18-2971-1
AQ430	18-1932	18-1936	-	-	18-2909	18-2971-1
AQ431	18-1932	18-1936	-	-	18-2909	18-2971-1
AQ432	18-1932	18-1936	-	-	18-2909	18-2971-1
AQ434	18-1932	18-1936	-	-	18-2909	18-2971-1
BB140A	18-1930-2	-	18-8539	-	18-2991-1	-
BB145A	18-1930-2	-	18-8539	-	18-2991-1	-
BB225A,B,C	18-1931-1	18-1935-1	18-8511 ^⑤ /18-8502 ^⑥	18-8510	18-2949	18-2971-1
BB260A,B,C	18-1931-1	18-1935-1	18-8511 ^⑤ /18-8502 ^⑥	18-8510	18-2949	18-2971-1
500B	-	18-1936	-	-	18-2909	18-2971-1
501B	-	18-1936	-	-	18-2909	18-2971-1
570	18-1931-1	18-1935-1	-	-	18-2909	18-2971-1
572	-	18-1936	-	-	18-2909	18-2971-1
740B	-	18-1936	-	-	18-2909	18-2971-1
LK 4.3L	-	18-1936	-	-	18-2909	18-2971-1
LK 5.7L	18-1986-1	18-1909-1	18-8502	18-4364 ^⑦ /18-8535 ^⑧	18-2949	18-2854-1 ^⑦ /18-0476-1 ^⑧
HU 5.7 Gi	18-1986-1	18-1909-1	18-8502	18-4364 ^⑦ /18-8535 ^⑧	18-2949	18-2854-1 ^⑦ /18-0476-1 ^⑧
MD 5.7GL / 5.7Gi	18-1986-1	18-1909-1	18-8502	18-4364 ^⑦ /18-8535 ^⑧	18-2949	18-2854-1 ^⑦ /18-0476-1 ^⑧
NC5.7 GL / 5.7Gi	18-1986-1	18-1909-1	18-8502	18-4364 ^⑦ /18-8535 ^⑧	18-2949	18-2854-1 ^⑦ /18-0476-1 ^⑧

^⑤ Volvo Configuration Match (Bolts Used in Hardware Kit) ^⑦ Open Gasket
^⑥ OMC Configuration Match (Studs Used in Hardware Kit) ^⑧ Closed Gasket

<p>PKG. OF 5</p>  <p>18-4236 18-4236-9① WASHER Replaces: 941907</p>	 <p>18-4150 WATER PUMP SHAFT Replaces: 812994 For Pump Without Ball Bearing AQ90, 95, 100, 105, 110, 115, 120, 130, MD3B, 17C</p>	 <p>18-2774 MOLDED HOSE Replaces: 875847 AQ290, AQ290DP Includes (2) 18-7306 Clamps</p>	 <p>18-2775 MOLDED HOSE Replaces: 875822 AQDRIVE UNITS 200, 250, 270, 270T, 275, 280, 280T, 280PT, DP UNIT: 280 Includes (2) 18-7306 Clamps</p>
 <p>18-2776 MOLDED HOSE Replaces: 832831 AQ270T, 280T Includes (2) 18-7306 Clamps</p>	 <p>18-0163 COOLING PIPE GASKET SET For: B30, AQ165A, AQ170A, AQ170B, AQ170C, BB165A, BB170A, BB170B, BB170C</p>	 <p>18-0376 COOLING PIPE GASKET SET Fits: D6, D7, MD6A, MD6B, MD7A, MD7B</p>	 <p>18-0377 COOLING PIPE GASKET SET Fits: B21, B23, AQ120B, AQ125A, AQ140A, BB140A, AQ125B, AQ145A, AQ145B, BB145A</p>
 <p>18-0590 COOLING PIPE GASKET SET Fits: B20, AQ125A, AQ115B, AQ130A, AQ130B, AQ130C, AQ130D, BB115A, BB115B, BB115C</p>	 <p>18-0648 COOLING PIPE GASKET SET Fits: D11, D17, MD11C, MD11D, MD17C, MD17D</p>	 <p>18-3889 COOLING PIPE GASKET SET Fits: B23, B25, 230A, 230B, AQ131A, AQ131B, AQ131C, AQ131D, 250A, 250B, 251A, AQ151A, AQ151B, AQ151C, AQ171A, AQ171C</p>	 <p>18-0606 COOLING PIPE GASKET SET Fits: B18, B20, AQ60F, AQ90, AQ95, AQ95A, AQ110, AQ120, BB30, BB100, MB18, AQ105A, MB20A, MB20B, MB20C</p>
 <p>18-0907 OIL DRAIN PLUG GASKET SET For oil plugs: Fits: 200, 250, 270, 270T, 275, 275A</p>	 <p>18-3890 OIL COOLER GASKET SET Fits: B20, B21, B23, B25, B30, AQ115A, AQ115B, AQ130A, AQ130B, AQ130C, AQ130D, BB115A, BB115B, BB115C, MB20A, MB20B, MB20C, AQ120B, AQ125A, AQ140A, BB140A, 230A, 230B, AQ145A, AQ145B, BB145A, 250A, 250B, 251A, AQ151A, AQ151B, AQ151C, AQ171A, AQ171C, AQ165A, AQ170A, AQ170B, AQ170C, BB165A, BB170A, BB170B, BB170C</p>	 <p>18-2777 WATER HOSE CONNECTION Replaces: 854031 *AQ120B, *AQ125A, B, AQ130A, B, D, *AQ130C, *AQ131A, AQ140A, AQ145A, *AQ165A, *AQ170A, B, C, *AQ175A, AQ200D, AQ225D, *AQ225E, AQ260A, AQ260B, AQ290A, *AQAD31A, AQD40A, AQD21A, AQAD40A * Models with Power Trim</p>	 <p>18-2778 WATER HOSE CONNECTION Replaces: 832846 AQ140A, AQ145A, AQ165A, AQ170A, *AQ175D, AQ200D, AQ225D, AQ260A, AQ290A, *AQ280L, AQAD30A, AQAD40A, B *Models with Power Trim</p>
 <p>18-3557 THERMOSTAT Replaces: 21148403 143°</p>	 <p>18-3558 THERMOSTAT Replaces: 3853799 160°</p>	 <p>18-3654 THERMOSTAT KIT (60°C) Replaces: 875779 140°</p>	 <p>18-3539 THERMOSTAT KIT Closed Cooling System (Includes sealing ring) Replaces: 3831426 160°</p>

① Priced per Package

 <p>18-3538 THERMOSTAT KIT (Includes sealing ring) Replaces: 3831424</p>	<p>①18-3676D </p>  <p>18-3676 THERMOSTAT KIT Replaces: 3853983 140° — Contains —</p> <table border="1"> <thead> <tr> <th>Part #</th> <th>OE#</th> <th>Description</th> </tr> </thead> <tbody> <tr> <td>18-7170</td> <td>3852071</td> <td>O-Ring</td> </tr> <tr> <td>18-0398</td> <td>835417</td> <td>Gasket</td> </tr> <tr> <td>—</td> <td>3853983</td> <td>Thermostat</td> </tr> </tbody> </table>	Part #	OE#	Description	18-7170	3852071	O-Ring	18-0398	835417	Gasket	—	3853983	Thermostat	<p>①18-3670D </p>  <p>18-3670 THERMOSTAT KIT 160° — CONTAINS —</p> <table border="1"> <thead> <tr> <th>Part #</th> <th>O.E.#</th> <th>Desc.</th> </tr> </thead> <tbody> <tr> <td>18-3558</td> <td>3853799</td> <td>Thermostat</td> </tr> <tr> <td>18-2858</td> <td>3852127</td> <td>Thermostat Housing</td> </tr> <tr> <td>—</td> <td>—</td> <td>Cover Gasket</td> </tr> <tr> <td>18-0929</td> <td>3852120</td> <td>Thermostat Gasket</td> </tr> </tbody> </table>	Part #	O.E.#	Desc.	18-3558	3853799	Thermostat	18-2858	3852127	Thermostat Housing	—	—	Cover Gasket	18-0929	3852120	Thermostat Gasket	<p>①18-3677D </p>  <p>18-3677 THERMOSTAT KIT Replaces: 3856961 160° — Contains —</p> <table border="1"> <thead> <tr> <th>Part #</th> <th>OE#</th> <th>Description</th> </tr> </thead> <tbody> <tr> <td>18-7170</td> <td>3852071</td> <td>O-Ring</td> </tr> <tr> <td>18-0398</td> <td>835417</td> <td>Gasket</td> </tr> <tr> <td>—</td> <td>3856961</td> <td>Thermostat</td> </tr> </tbody> </table>	Part #	OE#	Description	18-7170	3852071	O-Ring	18-0398	835417	Gasket	—	3856961	Thermostat
Part #	OE#	Description																																								
18-7170	3852071	O-Ring																																								
18-0398	835417	Gasket																																								
—	3853983	Thermostat																																								
Part #	O.E.#	Desc.																																								
18-3558	3853799	Thermostat																																								
18-2858	3852127	Thermostat Housing																																								
—	—	Cover Gasket																																								
18-0929	3852120	Thermostat Gasket																																								
Part #	OE#	Description																																								
18-7170	3852071	O-Ring																																								
18-0398	835417	Gasket																																								
—	3856961	Thermostat																																								
 <p>18-3656 THERMOSTAT KIT 140° Replaces: 876097, 875781</p>	<p> </p> <p>18-3658 THERMOSTAT KIT 165° Replaces: 875784, 877349</p>	 <p>18-3659 THERMOSTAT KIT 160° Replaces: 875785</p>	 <p>18-3660 THERMOSTAT KIT 170° Replaces: 875787, 3831425</p>																																							
 <p>18-3662 THERMOSTAT KIT 145° Replaces: 875794, 876305</p>	 <p>18-3663 THERMOSTAT KIT 130° Replaces: 875791</p>	 <p>18-3664 THERMOSTAT KIT 165° Replaces: 875795</p>	 <p>18-3665 THERMOSTAT KIT 140° Replaces: 875796</p>																																							
<p>①18-3666D </p>  <p>18-3666 THERMOSTAT KIT (82°C) Replaces: 875580 180°</p>	 <p>18-3615 THERMOSTAT - RAW WATER Replaces: 3587597 150°</p>	 <p>18-3617 THERMOSTAT KIT</p>	 <p>18-3620 THERMOSTAT KIT 180°</p>																																							
 <p>18-3621 THERMOSTAT KIT 160°</p>	 <p>18-3626 THERMOSTAT KIT 145°</p>	 <p>18-3618 THERMOSTAT KIT - RAW WATER COOLED 150°</p>	 <p>18-3619 THERMOSTAT KIT - FRESH WATER COOLED 150°</p>																																							

THERMOSTAT APPLICATION ON NEXT PAGE

① Items ending in "D" are Display Packaged - Regular number is Non-Display

RAW WATER (OPEN) COOLING SYSTEM - RAW (RIVER, LAKE, SEA) WATER RUNS THROUGH CYLINDER BLOCK

Model	Version	Identifier	Model Year	Thermostat	Seal	Gasket	Thermostat & Seal Kit	Complete Kit Thermostat Seal Gasket
AQ90			1962-1964	NSS	18-2933		18-3656	
AQ95			1964-1968	NSS	18-2933		18-3656	
AQ100			1961-1963	NSS	18-2933		18-3656	
AQ130	A, B, C, D		1968-1977	NSS	18-2933		18-3656	
AQ115	A, B		1969-1975	NSS	18-2933		18-3656	
AQ140	A		1975-1979	NSS	18-2933	18-7181	18-3666	18-3620
AQ120	B		1977-1980	NSS	18-2933	18-7181	18-3666	18-3620
AQ145	A, B		1979-1985	NSS	18-2933	18-7181	18-3666	18-3620
AQ125	A, B		1981-1985	NSS	18-2933	18-7181	18-3666	18-3620
AQ131	A, B, C, D		1985-1989	NSS	18-2933	18-7181	18-3666	18-3620
230	A, B		1989-1993	NSS	18-2933	18-7181	18-3666	18-3620
AQ151	A, B, C		1985-1989	NSS	18-2933	18-7181	18-3666	18-3620
AQ171	A, C		1986-1989	NSS	18-2933	18-7181	18-3666	18-3620
250	A, B		1986-1993	NSS	18-2933	18-7181	18-3666	18-3620
251	A		1989-1992	NSS	18-2933	18-7181	18-3666	18-3620
3.0 GL, GS		MD,HU,NC	1993-1996	18-3558	18-0929	18-2858		18-3670
3.0 GL, GL, GSP, GLP, GLM		LK,BY,WT,EF	1996-2000	18-3558	NSS	18-0164		18-3621
3.0 GLP, GLM, GSP, GSM	A, B, C, D, E, J		2000-Current	18-3558	NSS	18-0164		18-3621
3.0 GXi, 3.0GXIC	J		2009-Current	18-3557	NSS	18-0164		18-3626
AQ175			1981-1985	18-3551	18-2933	18-0398		18-3662
AQ205	A		1988-1989	18-3551	18-2933	18-0398		18-3662
431	A, B		1989-1991	18-3551	18-2933	18-0398		18-3662
430	A, B		1990-1991	18-3551	18-2933	18-0398		18-3662
432	A		1992-1993	18-3551	18-2933	18-0398		18-3662
434	A		1992-1993	18-3551	18-2933	18-0398		18-3662
4.3 (All Models)		MD,HU,NC,LK, BY,WT,EF	1993-2000	NSS	18-7170	18-2917		18-3677
4.3 (All Models)	A, B		2001-2002	NSS	18-7170	18-2917		18-3677
4.3 (All Models)	C, D, E, F, G, J		2002-Current	NSS	NSS	18-2917	18-3615	18-3618
AQ190	A		1976-1977	18-3551		18-0398		18-3662
AQ200	B,C		1974-1976	18-3551		18-0398		18-3662
AQ225	B, C		1974-1976	18-3551		18-0398		18-3662
AQ200	D, F		1977-1986	18-3551		18-0398		18-3662
AQ225			1977-1986	18-3551	18-2933	18-0398		18-3662
AQ211	A		1986-1989	18-3551	18-2933	18-0398		18-3662
AQ231			1986-1989	18-3551	18-2933	18-0398		18-3662
500			1989-1993	18-3551	18-2933	18-0398		18-3662
501			1989-1993	18-3551	18-2933	18-0398		18-3662
5.0 FiP, FLP		MD,HU,NC	1993-1996	NSS	18-7170	18-2917		18-3677
5.0 GiP, GLP		BY,WT,EF	1997-2000	NSS	18-7170	18-2917		18-3677
5.0 GL, GXi, OSi	A, B		2001-2003	NSS	18-7170	18-2917		18-3677
5.0 (All Models)	C, D, E, F, G, H, J, K		2002-Current	NSS	NSS	18-2917	18-3615	18-3618
AQ271	A, B		1986	18-3551	18-2933	18-0398		18-3662
AQ260	A, B		1979-1985	18-3551	18-2933	18-0398		18-3662
AQ311	A		1986-1987	18-3551	18-2933	18-0398		18-3662
AQ271	C		1986-1989	18-3551	18-2933	18-0398		18-3662
AQ255	A, B		1977-1978			18-0398		
571	A		1989-1992	18-3551	18-2933	18-0398		18-3662
5.7 (All Models)		MD, HU, NC, LK, BY, WT, EF	1993-2000	NSS	18-7170	18-2917		18-3677
5.7 (All Models Except OSi)	A, B, C		2001-2003	NSS	18-7170	18-2917		18-3677
5.7 OSi, OSXi	B, C		2001-2003	NSS	NSS	18-2917	18-3615	18-3618
5.7 (All Models)	D, E, F, G, H, J, K		2002-Current	NSS	NSS	18-2917	18-3615	18-3618
5.8 (All Models)		HU, NC	1993-1996	NSS	18-7170	18-2917		18-3677
740	A, B		1991-1993	18-3551	18-2933	18-0398		18-3662
7.4 (All Models)		MD, HU, NC, LK, BY, WT, EF	1993-2000	NSS	18-7170	18-2917		18-3676
8.1 (All Models)			2000-Current	NSS	18-7170	NSS		18-3617
8.2 (All Models)		MD, HU, NC, LK, BY, WT, EF	1993-2000	NSS	18-7170	18-2917		18-3676

FRESH WATER (CLOSED) COOLING SYSTEM - ENGINE IS EQUIPPED WITH RESEVOIR TO HOLD ANTI-FREEZE

4.3, 5.0, 5.7 (All Models)			1993 - Current	NSS	18-2933	18-2917	18-3539	18-3619
5.8 (All Models)			1993 - 1996	NSS	18-2933	18-2917	18-3539	18-3619
7.4 (All Models)			1991 - 2000	NSS	18-2933	18-2917	18-3539	18-3619
8.1 (All Models)			2000-Current	NSS	18-2933	18-2917	18-3539	18-3619
8.2 (All Models)			1993 - 2000	NSS	18-2933	18-2917	18-3539	18-3619



**18-1476
CAMSHAFT KIT**

Fits:AQ165A, AQ170A, AQ170B, AQ170C, BB165A, BB170A, BB170B, BB170C



**18-1477
CAMSHAFT KIT**

Fits:B18, B20, AQ60F, AQ90, AQ95, AQ110, AQ120, BB30, BB100, MB18, AQ105, AQ115A, AQ115B, AQ130A, AQ130B, AQ130C, AQ130D, BB115A, BB115B, BB115C, MB20A, MB20B, MB20C



**18-1478
CAMSHAFT**

Replaces: 1218674
Fits:B18, B20, AQ60F, AQ90, AQ95, AQ95A, AQ110, AQ120, BB30, BB100, MB18, AQ105A, AQ115A, AQ115B, AQ130A, AQ130B, AQ130C, AQ130D, BB115A, BB115B, BB115C, MB20A, MB20B, MB20C



**18-1479
CAMSHAFT**

Replaces: 461511
Fits:B30, AQ165A, AQ170A, AQ170B, AQ170C, BB165A, BB170A, BB170B, BB170C



VALVES

Part #	Type	O.E. #	Application
18-4464	Exhaust	829620	D1, D2, D3, 3AA, D17, AQD2B, MD1B, MD2B, MD3B, MD11C, MD11D, MD17C, MD17D
18-4469	Exhaust	1542389	D40, AD40B, AQAD40A, AQAD40B, AQD40A, MD40A, TAMD40A, TAMD40B, TMD40A, TMD40B, TMD40C
18-4470	Exhaust	419735	B20, B30, AQ105A, AQ115A, AQ115B, AQ130A, AQ130B, AQ130C, AQ130D, BB115A, BB115B, BB115C, MB20A, MB20B, MB20C
18-4471	Exhaust	838638	D31, D32, D41, D42, D43, AD31L-A, AD31P-A, TAMD31L-A, TAMD31M-A, TAMD31P-A, TMD31L-A, KAD32PA, AD41L-A, AD41P-A, D41L-A, TAMD41H-A, TAMDS41L-A, TAMD41P-A, TMD41A, TMD41L-A, KAD42A, KAD42P-A, KAMD42A, KAMD42B, KAMD42P-A, TAMD42B, TAMD42WJ-A, KAD43P-A, KAMD43P-A
18-4463	Intake	833188	D1, D2, D3, 3AA, D17, AQD2B, MD1B, MD2B, MD3B, MD11C, MD11D, MD17C, MD17D
18-4466	Intake	838637	D31, D32, D41, D42, D43, AD31L-A, AD31P-A, TAMD31L-A, TAMD31M-A, TAMD31P-A, TMD31L-A, KAD32PA, AD41L-A, AD41P-A, D41L-A, TAMD41H-A, TAMDS41L-A, TAMD41P-A, TMD41A, TMD41L-A, KAD42A, KAD42P-A, KAMD42A, KAMD42B, KAMD42P-A, TAMD42B, TAMD42WJ-A, KAD43P-A, KAMD43P-A
18-4467	Intake	1542472	D40, AD40B, AQAD40A, AQAD40B, AQD40A, MD40A, TAMD40A, TAMD40B, TMD40A, TMD40B, TMD40C
18-4468	Intake	419734	B20, B30, AQ105A, AQ115A, AQ115B, AQ130A, AQ130B, AQ130C, AQ130D, BB115A, BB115B, BB115C, MB20A, MB20B, MB20C



**18-4465
VALVE GUIDE**

Replaces: 3582609
for exhaust, 230, 250, AQ115, BB115, MB20, AQ130, AQ165, BB165, AQ170, BB170, AQD21A, MD21A, AQ120B, AQ125A, AQ140A, BB140A, AQ125B, AQ131A, AQ131B, AQ131C, AQ131D, AQ145A, BB145A, AQ145B, AQ151A, AQ151B, AQ151C, MB10



**18-4472
VALVE LIFTER**

Replaces: 1218630
Fits:B18, B20, B30, AQ120, AQ90, AQ95, AQ110, AQ120, BB30, BB100, MB18, AQ105A, AQ115A, AQ115B, AQ130A, AQ130B, AQ130C, AQ130D, BB115A, BB115B, BB115C, MB20A, MB20B, MB20C, AQ165A, AQ170A, AQ170C, BB165A, BB170A, BB170B, BB170C



**18-4473
VALVE GUIDE**

Replaces: 419653, 3582561
Fits:AQ115, BB115, MB20, AQ130, AQ165, AQ170, BB170, AQD21A, MD21A, KAMD42A, KAD42A, KAMD42P, KAD42P, MD11, MD17, MD1B, MD2B, MD3B, MD30, TMD30, TAMD30, AQAD30, MD31A, TMD31B, TAMD40, AQAD40, TAMD42B, KAMD42B, KAD42B, TMD31D, TAMD31D, AD31D, AD31XD, TMD41B, TAMD41B, D41B, TMD41D, TAMD41D, D41D, AD41D



**18-4474
VALVE GUIDE**

Replaces: 419652, 3582606
For intake: Fits:230, 250, AQ115, BB115, MB20, AQ130, AQ165, BB165, AQ170, BB170, AQD21A, MD21A, AQ120B, AQ125A, AQ140A, BB140A, AQ125B, AQ131A, AQ131B, AQ131C, AQ131D, AQ145A, BB145A, AQ145B, AQ151A, AQ151B, AQ151C, MB10



**18-4029
TIMING BELT**

Replaces: 463377
AQ120B, 125A,B, 131A,B,C,D 140, 145, 151A,B,C, 230, 250, BB140A, 145A,B 4 Cyl.



**18-4044
DRIVE BELT**

Replaces: 834548, 966694-2
Generator: AQ120B, 125A, 140A, 145A, 165, 170A, B, C



**18-4046
DRIVE BELT**

Replaces: 958498, 966857
Generator: AQ175A, 200A, B, C, D, 225A,B, 260A, B, 280A, 290A
Water Pump AQ210
V-6, V-8



**18-8964
POWER STEERING PUMP PULLEY**

Replaces: 3853804
Fits: Many Volvo sterndrive applications



EXPANSION PLUGS

Part #	Pkg.	O.E. #	Size
18-4200 ① ②	5	477024	35MM (1.375")
18-4201 ① ②	5	192212	45MM (1.770")
18-4245 ②	5	463902	42MM (1.655")
18-4246 ②	5	463903-5	35MM (1.375")

① Stainless Steel
② This product is priced per piece. To order priced per package, please add -9 to the part number.



**18-2367
CYLINDER HEAD NUT**
Replaces: 943414
For cylinder head: Fits: D1, D2, D3, D11, D17, MD1B, AQD2B, MD2B, MD11C, MD11D, MD3B, MD17C, MD17D



**18-2793
SEAL RING KIT**
Replaces: 875550
For cylinder liner: Fits: D11, D17, MD11C, MD11D, MD17C, MD17D: NOTE: Model MD11 requires two
18-2793 and Model MD17 requires three 18-2793



**18-1727
RUBBER CUSHION**
Replaces: 803762
For propeller shaft coupler:
Fits: B18, B20, B30, MB10, 2001, 2002, 2003, 2010, 2020, 2030, 2040, D1, D2, D3, D5, D6, D7, D11, D17, D21, D22, D29, D32, BB30, BB100, BB115, BB165, BB170, MB10A, MB18, MB20, MD1, MD2, MD3, MD5, MD6, MD7, MD11, MD17, MD21, MD22, MD29, MD32



**18-4005
ENGINE MOUNT**
Replaces: 833950
Fits: D5, D6, D7, D11, D17, MB10, MB10A, MD5A, MD5B, MD5C, MD6A, MD6B, MD7A, MD7B, MD11C, MD11D, MD17C, MD17D



**18-57702
CRANKCASE FILTER**
Replaces: 876069
Fits: Volvo MD30A, TMD30A, TAMD30A, MD31A, TMD31A, TAMD31A, MD40A, TMD40A, TMD40B, TAMD40A, TAMD40B, TMD41A, TAMD41A



**18-7907
AIR FILTER**
Replaces: 858488
Fits: D31, D41, D42, AD31A, AD31B, AD31D, AD31L-A, AD31P-A, AD31XD, AQAD31A, MD31A, TAMD31A, TAMD31B, TAMD31D, TAMD31L-A, TAMD31M-A, TAMD31P-A, TMD31A, TMD31B, TMD31D, TMD31L-A, AD41A, AD41B, AD41D, AD41L-A, AD41P-A, AQAD41A, D41A, D41B, D41D, D41L-A, TAMD41A, TAMD41B, TAMD41D, TAMD41H-A, TAMD41L-A, TAMD41M-A, TAMD41P-A, TMD41A, TMD41B, TMD41D, TMD41L-A, TAMD42B, TAMD42WJ-A



**18-7908
AIR FILTER**
Replaces: 3582358
Fits: D31, D41, AD31A, AD31B, AD31D, AD31L-A, AD31P-A, AD31XD, AQAD31A, TAMD31A, TAMD31B, TAMD31D, TAMD31L-A, TAMD31M-A, TAMD31P-A, TMD31A, TMD31B, TMD31D, TMD31L-A, AD41D, AD41L-A, AD41P-A, AQAD41A, AQD41A, D41A, D41B, D41D, D41L-A, TAMD41A, TAMD41B, TAMD41D, TAMD41H-A, TAMD41L-A, TAMD41M-A, TAMD41P-A, TMD41A, TMD41B, TMD41D, TMD41L-A, TAMD41D



**18-7890
AIR FILTER**
Replaces: 463505, 876185
MD30, MD40, KAD42A, KAMD42A
Diesel



**18-0035
DIESEL OIL FILTER, FULL FLOW**
Replaces: 3582732
Fits: D4-180i-B, D4-180i-C, D4-210A-A, D4-210A-B, D4-210i-A, D4-210i-B, D4-225A-B, D4-225A-C, D4-225i-B, D4-225i-C, D4-260A-A, D4-260A-B, D4-260A-C, D4-260D-B, D4-260D-C, D4-260i-A, D4-260i-B, D4-260i-C, D4-300A-A, D4-300A-C, D4-300D-A, D4-300D-C, D4-300i-A, D4-300i-C, D6-280A-A, D6-280A-B, D6-280i-A, D6-280i-B, D6-310A-A, D6-310A-B, D6-310D-A, D6-310D-B, D6-310i-A, D6-310i-B, D6-330A-B, D6-330A-C, D6-330D-B, D6-330D-C, D6-330i-B, D6-330i-C, D6-350A-A, D6-350A-B, D6-370A-B, D6-370A-C, D6-370D-A, D6-370D-B, D6-370D-C, D6-370i-A, D6-370i-B, D6-370i-C, D6-435D-A, D6-435D-C, D6-435i-A, D6-435i-C



**18-0036
DIESEL OIL FILTER, BYPASS**
Replaces: 3582733
Fits: D4-180i-B, D4-180i-C, D4-210A-A, D4-210A-B, D4-210i-A, D4-210i-B, D4-225A-B, D4-225A-C, D4-225i-B, D4-225i-C, D4-260A-A, D4-260A-B, D4-260A-C, D4-260D-B, D4-260D-C, D4-260i-A, D4-260i-B, D4-260i-C, D4-300A-A, D4-300A-C, D4-300D-A, D4-300D-C, D4-300i-A, D4-300i-C, D6-280A-A, D6-280A-B, D6-280i-A, D6-280i-B, D6-310A-A, D6-310A-B, D6-310D-A, D6-310D-B, D6-310i-A, D6-310i-B, D6-330A-B, D6-330A-C, D6-330D-B, D6-330D-C, D6-330i-B, D6-330i-C, D6-350A-A, D6-350A-B, D6-370A-B, D6-370A-C, D6-370D-A, D6-370D-B, D6-370D-C, D6-370i-A, D6-370i-B, D6-370i-C, D6-435D-A, D6-435D-C, D6-435i-A, D6-435i-C



OIL FILTERS
SEE PAGES 182-184 & 1147-1170 FOR ADDITIONAL INFORMATION

Part #	O.E. #	Application
18-8003	8692305	—
18-7824-2	835440	Short GM Filter
18-7876-1	3850559	Long GM Filter
18-7878-1	430143, 1266286, 3517857	Short Ford Filter
18-7879-1	841750	V-6 GM

DIESEL OIL FILTER

18-0032	847741	—
18-0033	21707133	—
18-0034	477556	—
18-7880	466634	TAMD100, TMD102, TMD121, TMD122, TAMD122 & TAMD162
18-7884	834337	—
18-7974	3827069	—



**18-7974
OIL FILTER**
Replaces: 3827069
Thread Specs: 18mm x 1.5
Fits: Diesel Models AQD21A-B, AQD32A, MD21A/B, MD32A, TAMD61A, TAMD62A, TAMD63L-A, TAMD63P-A, TAMD71A/B, TAMD72A, TAMD73P-A, TAMD73WJ-A, TAMD74A-A, TAMD74A-B, TAMD74C-A, TAMD74C-B, TAMD74P-B, TAMD75P-A

CYLINDER HEAD ASSEMBLIES

*All cylinder heads are new castings and complete assemblies with new - stainless steel valves, hardened steel exhaust seats, valve springs, valve locks, and retainers.
All GM cylinder heads utilize high performance screw-in rocker arm studs in place of factory press in rocker arm studs.*



**18-4485
CYLINDER HEAD ASSEMBLY**
Fits: 5.7L V-8 GM (1987-95) with press in rocker arm studs with 12 intake manifold mounting bolts- (4 inside intake manifold bolts at 23 degrees), center mount valve covers



**18-4486
CYLINDER HEAD ASSEMBLY**
Fits: 5.7L V-8 GM Vortec (1996-Up) with press in rocker arm studs with 8 intake manifold mounting bolts, composite valve cover



**18-4486HP
CYLINDER HEAD ASSEMBLY**
Fits: Vortec GM small block 5.7L high performance
Completely assembled with revised runner and combustion chambers. Add 30hp to stock motor with no additional modifications.



**18-4489
CYLINDER HEAD ASSEMBLY**
Fits: 2.5L/3.0L GM (1968-95) (non MerCruiser LX models) (1968-95)



**18-4491
CYLINDER HEAD ASSEMBLY**
Replaces 4.3L Vortec V-6 (1996-Up) with screw in rocker arm studs (non-adjustable valve train), 8 intake manifold mounting bolts, center mount valve cover. NOTE: not for use with engines using factory roller rocker arms.



**18-4501
CYLINDER HEAD**
Fits: 5.0L Vortec



**18-4501HP
CYLINDER HEAD**
Fits: Vortec GM small block 5.0L
Completely assembled with revised runner and combustion chambers. Add 30hp to stock motor with no additional modifications.





18-1400
HYDRAULIC LIFTER
 Replaces: 3856127
 GM 4.3L/V-6 Late/5.0L/5.7L



18-1401
HYDRAULIC LIFTER
 Replaces: 3853847, 985316
 Ford 302/351
 Ford 5.0L & 5.8L



18-1402
HYDRAULIC LIFTER
 Replaces: 3854033, 502036
 GM 2.5L/120
 For: Volvo 3.0L/181 CID GM 3.0L, 4.3L, 5.0L & 5.7L

**ALL PISTONS
 ARE SUPPLIED COMPLETE WITH PISTON RINGS AND WRIST PIN.**



PISTONS	
STD	OMC / VOLVO #
18-4161	3853340, 914816
18-4173	*14077948
18-4173	3911020
0.02	
18-4160	3853477, 915236
0.03	
18-4164	*14077949, 3911023
* OMC References GM Number	

PISTON RINGS	
STD	OMC / VOLVO #
18-3937	*14089025
18-3937	328506
18-3937	3853960
18-3937	914555
18-3937	3853268
18-3937	985083, 986336
18-3940	328536
18-3944	370409

PISTON RINGS	
0.02	
18-3939	3854252
18-3939	914556
0.03	
18-3938	*14089026
18-3938	328516
18-3938	914557

PISTON / RING APPLICATION

VOLVO		PISTONS			RINGS			Qty.
Model	Serial Number	Std.	.020	.030	Std.	.020	Per .030	Eng.
GM								
2.5L/153 CID		18-4180	18-4183	-	18-3942	-	-	4
3.0L/181 CID		18-4161	18-4160	18-4191	18-3937	18-3939	18-3938	4
4.3L/V-6		18-4173	18-4188	18-4164	18-3937	18-3939	18-3938	6
5.0L/305 CID		-	-	18-4178	18-3944	-	-	8
5.7L/350 CID		18-4173	18-4188	18-4164	18-3937	18-3939	18-3938	8
7.4L/454 CID		18-4171	18-4189	18-4172	18-3940	-	-	8
FORD								
5.0L/302 CID		-	-	-	18-3937	18-3939	18-3938	8



ROD BEARINGS

Part #	Size
18-1308	Std.
18-1309	.010
18-1327	Std.
18-1332	.020
18-1333	.010
18-1334	Std.
18-1337	.010
18-1341	.020

Rod bearings sold individually,
1 per rod.



MAIN BEARINGS

Part #	Per Eng.	Size
18-1300	②	Std.
18-1311	②	Std.
18-1316	②	.010
18-1317	②	Std.

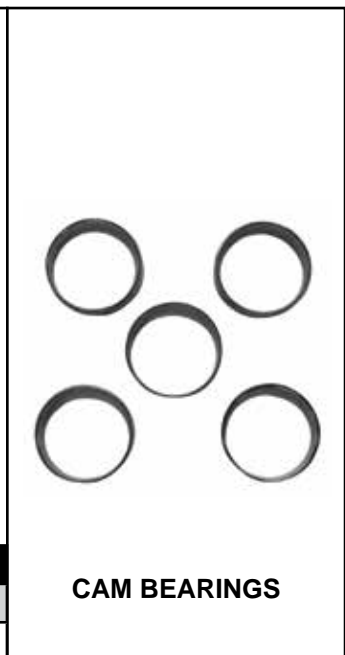

CAM BEARINGS

Part #	Per Eng.
18-1339	1 ②

BEARING APPLICATION

Model	ROD BEARING			MAIN BEARING			CAM BEARING
	Std.	.010	.020	Std.	.010	.020	

VOLVO							
GM							
3.0L/181 CID	18-1308	18-1309	18-1341	18-1317	18-1316	-	18-1339
4.3L/V-6	18-1327	18-1337	-	18-1311	-	-	-
5.0L/305 CID	18-1308	18-1309	18-1341	18-1300	-	-	-
5.7L/350 CID	18-1308	18-1309	18-1341	18-1300	-	-	-
7.4L/454 CID	18-1334	18-1333	18-1332	-	-	-	-

FORD							
5.0L/302 CID	—	-	-	-	-	-	-

18-0518
VALVE STEM SEAL
Replaces: 3854956, 914323, 3853132
For: most inline 4 and 6 cyl. GM (Early) and 305-350 CID GM

PKG. OF 8

18-4024
18-4024-9①
VALVE STEM SEAL
Replaces: 3853226, 914445
For: Chevy 4.3L/5.0L/5.7L

18-4031
VALVE STEM SEAL
Replaces: 1306630
AQ120B, 125A, B, 131A, 140A, 145A, B, 151A, B, MD1B, 2B, 3B, 5A, 2001, 2002, 2003, MD5B, C, 11C, D, 17C, D, 30, 31, 40, 41

ONE PIECE REAR MAIN SEALS
18-1234
Replaces: 3853528
For: 7.4L, GL, GI, GSI: 8.2L, GL
18-0519
Replaces: 3852657, 912957
4.3L/3.0L/5.0L 5.7L

TWO PIECE REAR MAIN SEALS
18-0528 **18-1211**
Replaces: 3852805

TIMING COVER SEALS
18-1213 **18-1230**
Replaces: 3853341 Replaces: 3853827







① Priced per Package ② Complete Engine Set

VOLVO SEAL APPLICATION

Engine Model	2 Piece Rear Main Crankshaft Seal Conv. Rotation (LH)	Timing Cover Seal
GM		
3.0L/181 CID	18-1211 ②	18-1213
4.3L/V-6	18-1211 ②	18-1213
5.0L/305 CID	18-1211 ①	18-1213
5.7L/350 CID	18-1211 ①	18-1213
7.4L/454 CID	③	18-1233
FORD		
5.0L/302 CID	18-0528	18-1230
5.8L/351 CID	—	18-1230

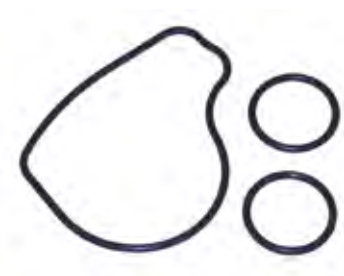
① Large Journal Crankshaft GM Engine ② For one piece seal (LH) models use 18-0519 ③ For one piece seal (LH) models use 18-1234

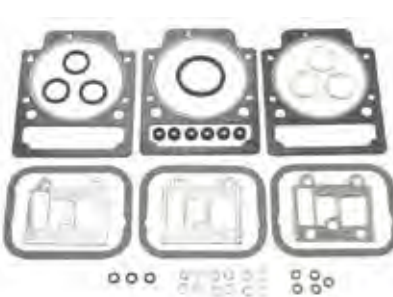
FOR MODULAR GASKET SETS SEE PAGES 653-660

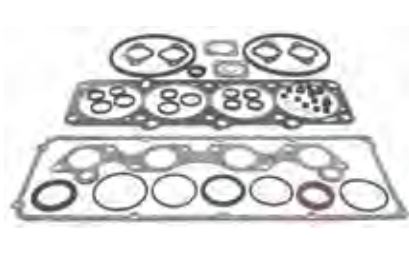
														
<p>18-0252 CONVERSION GASKET SET Replaces: 876314 Fits: D6, D7, MD6A, MD6B, MD7A, MD7B</p>	<p>18-0489 CONVERSION GASKET SET Replaces: 876384 Fits: D11, MD11C, MD11D</p>	<p>18-2814 SHORT BLOCK GASKET SET Replaces: 876306 (6 CYL.)</p>												
														
<p>18-2699 OUTDRIVE GASKET For: SX and DP-SM Drives thru 2006 — CONTAINS —</p> <table border="1" style="width: 100%; border-collapse: collapse;"> <thead> <tr> <th>Part #</th> <th>Description</th> <th>O.E. #</th> <th>Qty.</th> </tr> </thead> <tbody> <tr> <td>18-7153</td> <td>O-Ring</td> <td>911851</td> <td>2</td> </tr> <tr> <td>18-2996</td> <td>Outdrive Seal</td> <td>911823</td> <td>1</td> </tr> </tbody> </table>	Part #	Description	O.E. #	Qty.	18-7153	O-Ring	911851	2	18-2996	Outdrive Seal	911823	1	<p>18-2596 HEAD GASKET SET Replaces: 875422 Fits: D1, D2, D1A, MD1A, D2A, MD2, MD2A: NOTE: Model MD2A requires two 18-2596</p>	<p>18-3870 HEAD GASKET SET Replaces: 876303 Fits: B25, 251A, AQ171A, AQ171C</p>
Part #	Description	O.E. #	Qty.											
18-7153	O-Ring	911851	2											
18-2996	Outdrive Seal	911823	1											
														
<p>18-4341 HEAD GASKET SET Replaces: 876380 Fits: D17, MD17C, MD17D</p>	<p>18-4342 HEAD SET Replaces: 876376 Fits: D11, MD11C, MD11D</p>	<p>18-2813 HEAD GASKET SET Replaces: 876302 (4 CYL.)</p>												

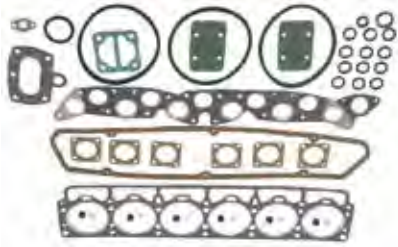

18-2817
HEAD GASKET SET
 Replaces: 876359
 (6 CYL.)



18-2818
OIL PAN GASKET SET
 Replaces: 876433
 (4 CYL.)

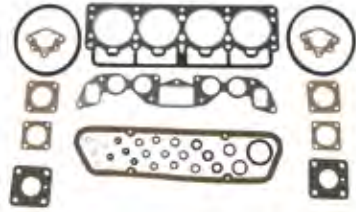

18-2980
HEAD GASKET SET
 Replaces: 875401 (Old), 876356
 (4 CYL.)



18-2982
HEAD GASKET SET
 Replaces: 875569 (Old), 876358
 (4 CYL.)



18-2983
SHORT BLOCK GASKET SET
 Replaces: 875400 (Old), 876342
 (4 CYL.)



18-2998
HEAD GASKET SET
 Replaces: 876300
 (4 CYL.)



18-0410
INTAKE MANIFOLD GASKET SET
 Replaces: 3853912, 3853913, 3854406
 For: Volvo 5.0L FL, FI, 5.8L FL, FI, FSI



18-0868
INTAKE MANIFOLD GASKET SET
 Replaces: 3854269

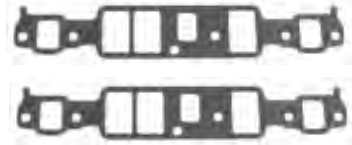

18-1238
INTAKE GASKET SET
 Replaces: 3850379, 912979
 For: Volvo 4.3GL/GS 1994-96, 4.3Gi 1995-97



18-0498
HEAD GASKET
 Replaces: 3580309
 Fits: MD2030A, MD2030B



18-2946
HEAD GASKET
 Replaces: 3853336, 908611
 Fits: GM 181 (3.0L) CID Eng.



18-2965
HEAD GASKET
 Replaces: 419310, 419763-8
 (4 CYL.)



18-2966
HEAD GASKET
 Replaces: 462623
 (4 CYL.)



18-2968
HEAD GASKET
 Replaces: 1378645
 (4 CYL.)



18-2970
HEAD GASKET
 Replaces: 1378646
 (4 CYL.)



18-3834
HEAD GASKET
Replaces: 833453



18-3842
HEAD GASKET
Replaces: 833274
Fits:D1,D2, MD1A, MD2A

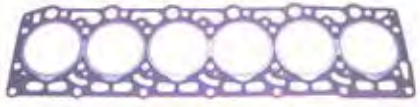

18-3843
HEAD GASKET
Replaces: 859155
Fits:D40, AD40B, AQAD40A, AQAD40B, AQD40A, MD40A, TAMD40A, TAMD40B, TMD40B, TMD40C



18-3867
HEAD GASKET
Replaces: 859647
Fits:MD22A, MD22L-A, MD22L-B, MD22P-B, TAMD22P-B, TMD22A, TMD22B



18-3868
HEAD GASKET
Replaces: 3583786
Fits:D41, D42, D43, D44, AD41A, AD41B, AD41D, AD41L-A, AD41P-A, AQAD41A, D41A, D41B, D41D, D41L-A, TAMD41A, TAMD41B, TAMD41D, TAMD41H-A, TAMD41L-A, TAMD41M-A, TAMD41P-A, TMD41A, TMD41B, TMD41D, TMD41LA, KAD42A, KAD42B, KAD42P-A, KAMD42A, KAMD42B, KAMD42P-A, TAMD42B, TAMD42WJ-A, KAD43P-A, KAMD43P-A, KAD44P-A, KAD44P-B, KAD44P-C, KAMD44P-A, KAMD44P-B, KAMD44P-C



18-3873
HEAD GASKET
Replaces: 3853587
Fits:7.4L GL, GI, GSI, 8.2L GL



18-3869
HEAD GASKET
Replaces: 3584202
Fits:MD2040A, MD2040B



18-3876
HEAD GASKET
Replaces: 841207-4, 856474-2
Fits: GM 305 (5.0L)/350 (5.7L) CID Eng.



18-3879
HEAD GASKET
Replaces: 3854299, 912227, 914930
Fits: GM 262 (4.3L) CID Eng.



18-3883
HEAD GASKET
Replaces: 3853732
Fits: Ford 302 (5.0L) 351 (5.8L) CID Eng.





















18-3887
HEAD GASKET
Replaces: 3853511
For: Volvo 7.4L

HEAD GASKET SET/GASKET SET/HEAD GASKET APPLICATION											
Model	Head Gasket Set	Gasket Set	Head Gasket	Model	Head Gasket Set	Gasket Set	Head Gasket	Model	Head Gasket Set	Gasket Set	Head Gasket
AQ60	—	18-2983	—	AQ140A	18-2998	18-2818	18-2968	BB115C	—	—	18-2966
AQ90	—	18-2983	—	AQ145A	—	18-2818	18-2970	BB140A	18-2998	18-2818	18-2968
AQ95	—	18-2983	—	AQ145B	18-2813	—	18-2970	BB145A	18-2999	18-2818	—
AQ100	—	18-2983	—	AQ151A,B,C	18-2813	—	18-2970	BB165	—	18-2814	—
AQ105	—	18-2983	—	AQ165	—	18-2814	—	BB170C	18-2817	18-2814	18-2811
AQ110	—	18-2983	—	AQ170A	—	18-2814	—	BB30	—	18-2983	—
AQ115	—	18-2983	—	AQ170B	—	18-2814	—	MB18	—	18-2983	—
AQ115A	18-2980	—	18-2965	AQ170C	18-2817	18-2814	18-2811	MB20	—	18-2983	—
AQ115B,C	—	18-2982	18-2966	AQD2B	18-2985	—	18-3833	MB20A	18-2981	—	—
AQ120A	—	18-2983	—	B20 (0.8MM)	—	—	18-2965	MB20B	18-2980	—	18-2965
AQ120B	18-2998	18-2818	18-2968	B20 (1.2MM)	—	—	18-2966	MB20C	18-2982	—	18-2966
AQ125A	18-2998	18-2818	18-2968	B21	—	—	18-2968	MD11C,D	—	—	18-3834
AQ125B	18-2813	—	18-2970	B23	—	—	18-2970	MD17C,D	—	—	18-3834
AQ130	—	18-2983	—	B30 (0.8MM)	—	—	—	MD1B	—	—	—
AQ130A	18-2980	—	18-2965	B30 (1.2MM)	—	—	18-2811	MD2B	18-2985	—	—
AQ130B	—	—	—	BB30	—	18-2983	—	MD3B	—	—	—
AQ130C	18-2980	—	18-2965	BB100	—	18-2983	—	230A,B	18-2813	—	—
AQ130D	18-2982	—	18-2966	BB115A,B	—	—	—	250A,B	18-2813	—	—
AQ131A,B,C,D	18-2813	—	18-2970								

<p>PKG. OF 2</p>  <p>18-0876 18-0876-9① FUEL PUMP GASKET For GM 4.3L, 5.0L & 5.7L Replaces: 3852113</p>	<p>PKG. OF 2</p>  <p>18-0889 18-0889-9① FUEL PUMP GASKET For GM 4.3L, 5.0L & 5.7L Replaces: 3852095</p>	<p>PKG. OF 2</p>  <p>18-2989 18-2989-9① CARB MOUNTING GASKET Replaces: 824677 AQ115, 125A, B, 130C, D, 131A, 145A, B, 151A, B, 170, 171A</p>	<p>PKG. OF 2</p>  <p>18-0398 18-0398-9① THERMOSTAT GASKET Replaces: 835417</p>
<p>PKG. OF 2</p>  <p>18-2933 18-2933-9① THERMOSTAT GASKET Replaces: 416033, 1317466 Used with most Volvo thermostats (Except AQ175, V-8, MD1A)</p>	<p>PKG. OF 2</p>  <p>18-2858 18-2858-9① THERMOSTAT HOUSING COVER GASKET Replaces: 3852127 For: 3.0L GS, GL, GLM, GLP, GSM, GSP</p>	<p>PKG. OF 2</p>  <p>18-0164 18-0164-9① THERMOSTAT HOUSING GASKET Replaces: 3852096 For: 3.0L GS, GL</p>	<p>PKG. OF 2</p>  <p>18-0929 18-0929-9① THERMOSTAT GASKET Replaces: 3852120 For: 3.0L GS, GL</p>
 <p>18-0183-1 EXHAUST MANIFOLD GASKET Replaces: 3853742, 3852455</p>	 <p>18-2971-1 EXHAUST MANIFOLD GASKET Replaces: 856039, 835908 AQ200, 225, 260, 271, 290, 311</p>	 <p>18-2925 EXHAUST MANIFOLD GASKET Replaces: 461092 (Old), 1378913 AQ165, 170B, BB165, 170 6 Cyl.</p>	 <p>18-2922 EXHAUST MANIFOLD GASKET Replaces: 418870 (Old), 1378911 AQ90, 95, 100, 105, 110, 115, 120, 120A, 130, BB30, 100, 115, MB18, 20 4Cyl.</p>
 <p>18-2815 PUSH ROD COVER GASKET Replaces: 3852692 For: 3.0L</p>	 <p>18-1231 INTAKE GASKET Replaces: 3854095 For: Volvo 7.4L GL, GI, GSI, 8.2L GL</p>	<p>PKG. OF 2</p>  <p>18-2995 18-2995-9① HEAT EXCHANGE GASKET Replaces: 856037 AQ120B, 125A, B, 140A, 145A,B</p>	 <p>18-2928 EXHAUST MANIFOLD GASKET Replaces: 824633, 856044 AQ105, 115, 130, BB115, MB20 4 Cyl.</p>
 <p>18-2930 EXHAUST MANIFOLD GASKET Replaces: 1266796 (Old), 1378879 AQ125A, B, 145A, B, 131A, 151A, B, 120B, 140A</p>	<p>PKG. OF 2</p>  <p>18-2949 18-2949-9① EXHAUST MANIFOLD GASKET Replaces: 835966, 856034 AQ200, 225, 260, 271, 290, 311 V-8</p>	<p>PKG. OF 4</p>  <p>18-2991-1 18-2991-1-9① EXHAUST MANIFOLD GASKET Replaces: 855967, 855383 AQ120B, 125A, B, 131, 140, 145, 151, B21, B23</p>	<p>PKG. OF 2</p>  <p>18-2974 DISTRIBUTOR GASKET Replaces: 418265 AQ90, 95, 100, 105, 110, 115, 120, 130, 165, 170, MB18, 20, BB30, 100</p>

SEE PAGES 201-202 FOR OUR COMPLETE LINE OF GASKET SEALANTS

① Priced per Package

 <p>18-0311 VALVE COVER GASKET Replaces: 3854942 For: 4.3 Litre 262 CID</p>	 <p>18-0347 VALVE COVER GASKET Replaces: 3852693 For: GM 153 & 181 CID (2.5L & 3.0L)</p>	 <p>18-0352 VALVE COVER GASKET Replaces: 3852818 For: Ford 302/351 CID (5.0L & 5.8L)</p>	 <p>18-0664 VALVE COVER GASKET Replaces: 3852687 For: GM 305/350, 5.0 & 5.7L</p>
 <p>18-2923 VALVE COVER GASKET Replaces: 419678 AQ105, 115, 120, 130, BB115, MB20 4 Cyl.</p>	 <p>18-2924 VALVE COVER GASKET Replaces: 430039 AQ165, 170, BB165, 170 6 Cyl.</p>	 <p>18-2927 VALVE COVER GASKET Replaces: 463999 (Old), 1378909 AQ120B, 125A, 140A, 145A, BB140, 145A 4Cyl.</p>	 <p>18-2972 VALVE COVER GASKET Replaces: 1378870 AQ125B, 145B, 131A, 151A, B</p>
 <p>18-2926 OIL PAN GASKET Replaces: 463587 (Old), 1378864 AQ90, 95, 100, 105, 110, 115, 120, 120B, 125A, B, 130, 131A, 140A, 145A, B, 151A, B, 171A</p>	 <p>18-0307 OIL PAN GASKET Replaces: 861250 Fits:D30, D31, D32, AD300A, AQAD30A, MD30A, TAMD30A, TMD30A, AD31A, AD31B, AD31D, AD31L-A, AD31P-A, AD31XD, AQAD31A, MD31A, TAMD31A, TAMD31B, TAMD31D, TAMD31L-A, TAMD31M-A, TAMD31P-A, TMD31A, TMD31B, TMD31D, TMD31L-A, KAD32P-A</p>		 <p>18-0310 OIL PAN GASKET Replaces: 861251 Fits:D40, D41, D42, D43, D44, D300, AD40A, AQAD40A, AQAD40B, AQD40A, MD40A, TAMD40A, TAMD40B, TMD40A, TMD40B, TMD40C, AD41A, AD41B, AD41D, AD41L-A, AD41P-A, AQAD41A, D41A, D41B, D41D, D41L-A, TAMD41A, TAMD41B, TAMD41D, TAMD41H-A, TAMD41L-A, TAMD41M-A, TAMD41P-A, TMD41A, TMD41B, TMD41D, TMD41L-A, KAD42A, KAD42B, KAD42P-A, KAMD42A, KAMD42B, KAMD42P-A, TAMD42B, TAMD42WJ-A, KAD43P-A, KAMD43P-A, KAD44P-A, KAD44P-B, KAD44P-C, KAMD44P-C, KAMD44P-B, KAMD44P-C, KAD300, KAMD300A</p>
 <p>18-1237 OIL PAN GASKET Replaces: 3856138 For: GM 5.7L</p>	 <p>18-1239 OIL PAN GASKET Replaces: 3853343 For: Volvo 3.0L</p>	 <p>18-0405 OIL PAN GASKET Replaces: 3852655 For: Volvo 4.3L</p>	 <p>18-1232 OIL PAN GASKET Replaces: 3853510 For: Volvo 7.4L GL, GI, GSI, 8.2L GL</p>
 <p>18-2518 CIRCULATION PUMP GASKET Replaces:430017 For: Volvo AQ165A, 170A, B, C</p>	<p>PKG. OF 2</p>  <p>18-0903 18-0903-9① WATER PUMP GASKET Replaces: 3853361 454 CID</p>	 <p>18-0327 WATER PUMP GASKET Replaces: 3853342 4 & 6 Cyl.</p>	<p>PKG. OF 2</p>  <p>18-0891 18-0891-9① WATER PUMP MOUNTING GASKET Replaces: 3852477 For: GM 4.3L, 5.0L & 5.8L</p>

<p>PKG. OF 2</p>  <p>18-0893 18-0893-9① WATER PUMP BACK-IN PLATE GASKET Replaces: 3850595 GM 4.3L, 5.0L & 5.7L</p>	<p>18-0147 WATER PUMP GASKET For Ford V-8 Replaces: 3852824</p> 	<p>PKG. OF 2</p>  <p>18-2979-9① WATER PUMP GASKET Replaces: 1378906 AQ120B, 125A, 140A, 145A</p>	 <p>18-0468 TIMING COVER GASKET Replaces: 3852654, 3853512 GM 4.3L, 5.0L & 5.7L</p>
<p>PKG. OF 2</p>  <p>18-0887 18-0887-9① TIMING COVER GASKET Replaces: 3852691 4 & 6 Cyl.</p>	<p>18-2531 CLAMP RING Replaces: 834476 Fits: AQ120B, 125A, B, 140A, 145A, B</p> 	<p>18-25250 SEALING RING Replaces: 3863085 Fits: Volvo SX-A/DPS-A (2007 & Up)</p> 	<p>18-25251 SEALING RING Replaces: 853868 Fits: Volvo SX Thru 2006</p> 
<p>PKG. OF 2</p>  <p>18-2519 18-2519-9① SEAL RING Replaces: 831622 For cooling water pipe 120B, 125A, B, 131A, 140A, 145A, B, 151A, B, 171A</p>	<p>PKG. OF 5</p>  <p>18-2525 18-2525-9① SEAL RING Replaces: 430018 Circulation pump to cylinder head AQ165A, 170A, B, C</p>	<p>PKG. OF 5</p>  <p>18-2526 18-2526-9① SEAL RING Replaces: 430172 Circulation pump to cylinder head AQ165A, 170A, B, C</p>	<p>PKG. OF 5</p>  <p>18-2527 18-2527-9① SEAL RING Replaces: 831617 For cooling water pipe AQ165A, 170A, B, C, MD21A (S/N MD-103387 & UP), MD21B</p>
<p>PKG. OF 5</p>  <p>18-2528 18-2528-9① SUPPORT RING Replaces: 831891 AQ120B, 125A, B, 140A, 145A, B</p>	<p>PKG. OF 5</p>  <p>18-2529 18-2529-9① SEAL RING Replaces: 831892 AQ120B, 125A, B, 140A, 145A, B</p>	 <p>18-4259 WASHER Replaces: 804261</p>	 <p>18-2530 18-2530-9① SEAL RING Replaces: 1336255, 3547991 Circulation pump to cylinder head AQ120B, 125A, B, 131A, 140A, 145A, B, 151A, B, 171A</p>
<p>PKG. OF 2</p>  <p>18-2934 18-2934-9① RUBBER SEAL Replaces: 829714 AQ90, 95, 100, 105, 110, 115, 120, 130, MD5A, B, C, 7A, B, 11D, MD2001, 2002, 2003T</p>	<p>PKG. OF 2</p>  <p>18-2935 18-2935-9① RUBBER SEAL Replaces: 418411 AQ90, 95, 100, 105, 110, 115, 120, 130, MB18, 20, BB30, 100, MD11C, D, 17C, D, MD2001, 2002, 2003, 2003T</p>	<p>PKG. OF 2</p>  <p>18-2936 18-2936-9① RUBBER SEAL Replaces: 418445 AQ90, 95, 100, 105, 110, 115, 120, 130, MB18, 20, BB30, 100, MD11C, D, 17C, D, 2001, 2002, 2003, 2003T</p>	<p>PKG. OF 2</p>  <p>18-2937 18-2937-9① RUBBER SEAL Replaces: 418412 AQ90, 95, 100, 110, 120B, 125A, B, 131A, 140A, 145A, B, 151A, B, 165A, 170, 171A, MD21A, B</p>

① Priced per Package

<p>PKG. OF 5</p>  <p>18-2994 18-2994-9① RUBBER SEAL Replaces: 430020 AQ120B, 125A, B, 131A, 140A, 145A, B, 151A, B, 171A</p>	<p>PKG. OF 5</p>  <p>18-2996 18-2996-9① OUTDRIVE SEAL Replaces: 3852560 3.0L GL, GS, 4.3L GL, GS, GI, 5.0L FL, FI, 5.7L GL, GI, 5.8L FL, FI, FSI</p>	<p>PKG. OF 2</p>  <p>18-0322 18-0322-9① REAR SEAL GASKET Replaces: 3852656 GM 5.0L & 5.7L</p>
<p>PKG. OF 2</p>  <p>18-2929 18-2929-9① COVER PLATE GASKET Replaces: 856028 AQ105, 115, 130, BB115, MB20</p>	<p>PKG. OF 2</p>  <p>18-2939 18-2939-9① RUBBER SEAL Replaces: 814356 AQ200, 250, 270, 275, 280, 290</p>	<p>PKG. OF 2</p>  <p>18-0874 18-0874-9① DISTRIBUTOR GASKET For GM V6 & V8 Replaces: 3852109</p>
<p>PKG. OF 2</p>  <p>18-0943-2 18-0943-2-9① EXHAUST ELBOW GASKET Replaces: 3850496 Late Model Volvo Applications</p>	<p>PKG. OF 2</p>  <p>18-2990 18-2990-9① UPPER GEAR HOUSING GASKET Replaces: 832669 AQ270, 275, 280, 290</p>	 <p>18-2199 SHORT YOKE SPACER Replaces: 832675 AQ270, 275, 280, 290</p>
 <p>18-2945 18-29451-9① (PKG. OF 50) DRAIN SCREW GASKET For: use with 18-2944 drain screw</p>	 <p>18-2432 POWER TRIM HOSE Replaces: 873228 For: DP, DPX</p>	 <p>18-2433 POWER TRIM HOSE Replaces: 873229 For: DP, DPX</p>
 <p>18-21751 ENGINE COUPLER Replaces: 3853962-3 Fits: 2.5L (1986), 3.0L (1986-90), 4.3L, 5.0L, 5.7L (1986) KW & KWB suffix only, 7.4L (1990-98), 8.2L (1992-93, 1998)</p>	 <p>18-21752-1 ENGINE COUPLER Replaces: 3858437-1 Fits: 4.3L (1986-Current), 5.0L (1986-88, 1998-Current), 5.7 (1986-92, 1994, 1996-Current)</p>	 <p>18-21753 ENGINE COUPLER Replaces: 985727, 3853862-5 Fits: Ford Engines 5.0L & 5.8L (1989-96)</p>

① Priced per Package



18-6456
IDLER PULLEY
 Replaces: 855507
 Fits: 251A, AQ171A, AQ171C



18-9096
TRAILERING CLIP
 Volvo 3847547
 Fits: Volvo SX-A, DPS-A (2007-Up)



Display Package

18-9098
TRAILERING CLIPS
 Replaces: 174448
 Set of 2
 For all SX Models thru 2006



18-2772-1
TRANSOM SEAL KIT
 For: SX Drives



— CONTAINS —

Part #	Description	O.E. #	Qty.
18-2100	Gimbal Bearing	3853807	1
18-2765	Bellows	3854127	1
18-1074	Bellows	3850426-2	1
18-2996	Seal	3852560, 911823	1
18-710-64-2	Hose Clamp	853012-3	1



STAINLESS STEEL CLAMPS

Part #	Sizes	O.E. #
18-7300 ① ②	50MM	—
18-7306 ① ②	38MM	853548
118-710-48-2	—	3852604
18-710-64-2	122MM	853012



18-2744
DRIVE BELLOWS KIT
 Replaces: 875826, 876294
 (with ridge)
 AQ200, 250, 270, 270T, 275, 280, 280T,
 PT, 290 DP UNIT: 280, 290



18-2755
DRIVE BELLOWS KIT
 Replaces: 875827
 SAIL DRIVE: 100S, AQ DRIVE: 100, 100B



18-2757
EXHAUST BELLOWS KIT
 with flapper valve
 Replaces: 875828, 876633
 AQ175, 280, 280DP, T, PT, AQD40,
 AQAD40, V-8



18-2758
EXHAUST BELLOWS KIT
 Replaces: 875848, 876631
 AQ200, 250, 270, 275, 280, 280DP,
 290, 290DP



18-1074
EXHAUST BELLOWS
 Replaces: 3850426
 For: SX Drives includes 302, 432,
 434, 502, 572, 584, 744 (1994-98)
 Uses 18-710-48-2 Clamp



18-2765
U-JOINT BELLOWS
 Replaces: 3854127
 For: DP-S, SX



18-2766
EXHAUST HOSE
 Replaces: 834751
 (I.D. 95MM, LENGTH 160 MM)
 V-8

① This product is priced per piece. To order priced per package, please add -9 to the part number.

② Priced per Package



**18-6523
SPRING SET**

For reverse tilt lock: Fits: AQ250, 270, 275, 275A, 280, 280DP, 280L, 285A, 290, 290A, 290DP, SP-A, SP-A/MT, SP-A1, SP-A2, DP-A, DP-A1, DP-A2, DP-B, DP-B1



**18-0184
RUBBER RING**

Replaces: 804190
For clamp ring: Fits: 230A/SP-A/MT, 250A/SP-A/MT, 500A, 501A, 571A, 740A, AQ100, AQ105, AQ110, AQ115A, AQ110B, AQ120A, AQ120B, AQ125A/B, AQ130A/B, AQ131A/D, AQ175A, AQ190A, AQ200A/C/D/F, AQ210A, AQ211A, AQ225A/B/C/D/E/F, AQ231A/B, AQ240A, AQ255A/B, AQ260A/B, AQ271A/B/C/D, AQ280A, AQ290A, AQ311A/B, AQ60F, AQ80, AQ90, AQ95, AQD19, AQD29A, AQD32A



**18-8368
RUBBER RING**

Replaces: 813967
For clamp ring: 230A/SP-A/SP, A1, 230B, 250A/B, 251A, 430A/B, 431A/B, 432A, 434A, 500B, 501B, 570A, 572A, 740B, AD31A/B/D/XD, AD40B, AD41A/B/D, AQ100, AQ105, AQ110, AQ115A/B, AQ130A/B, AQ131B/C, AQ140A, AQ145A/B, AQ151A/B/C, AQ171A/C, AQ205A, AQ60F, AQ90, AQ95, AQAD30A, AQAD31A, AQAD40A/B, AQAD41A, AQD19, AQD21A/B, AQD40A, D41A/B/D, KAD32, KAD42A/B/P, KAD43P, KAD44P, KAMD42A, TAMD41A



**HEAVY DUTY U-JOINTS
(Rockwell Style)**

Part #	O.E. #	Application
18-2104	897707,	AQ200,250,270,
	853255	280,290
18-2174	3850812	3.0L GS, GL, 4.3L GL, GS, GI, 5.0L GL, GI, 5.7L GL, GI, 5.8L FL, FI, FSI



**18-6406
U-JOINT**

Replaces: 3860232
GKN new style with external clips.



**18-2100
LINK BELT
GIMBAL BEARING**

Replaces: 3853807
Fits: OMC/Volvo- 3.0L, 4.3L, 5.0L, 5.7L, 7.4L (1994-1998), 5.8L (1994-1996), 8.2L(1998)



**18-2146
UNIVERSAL U-JOINT
ASSEMBLY**
Replaces: 3850815



**18-2339
U-JOINT ASSEMBLY**
Replaces: 3852384



**18-2337
YOKE**
Replaces: 3850814
Fits: 3.0L GS, GL, 4.3L GS, GL, GI, 5.0L FL, FI, 5.7L GL, GI, 5.8L FL, FI, FSI



**18-2128
CENTER SOCKET**
Replaces: 3850813, 912213

Drive Model	U-joint Assy. #	O.E. U-joint Assy. #	Long Yoke #	O.E. Long Yoke #	Short Yoke #	O.E.Short Yoke #	Double Yoke #	O.E. Double Yoke #
SX, DP-SM	18-2339	3852384	18-2146	3850815	18-2337	3850814	18-2128	3850813



**18-4204
PLASTIC BUSHING**
Replaces: 826341, 876278
AQ200, 250, 270, 275, 280, 280DP,290DP,
NOT FOR 270T, 280T, AND 290



**18-2366
LOWER
GEARCASE SEAL**
Replaces: 876279
290, 290A, 290DP, SP-A, SP-A1 & SP-A2



**18-4205
PLASTIC BUSHING**
Replaces: 832820
A270T, 280T



**18-4206
STERNDRIVE COVER**
Replaces: 832570
AQ200, 250, 270, 275, 280, 290



**FISH LINE
PROTECTOR SPACER**

Part #	O.E. #	Application
18-4208	839423	AQ280, 290
18-4209	839534	AQ250, 270, 275
18-4234	832965	AQ110S, 200



**18-4210
PROP CONE**
Replaces: 850785, 854045
AQ200, 250, 270, 270T, 275, 280, 280T, 280PT, 290



**18-4211
PLASTIC WASHER**
Replaces: 850888



**18-3730
LOCK NUT**
Replaces: 3852648-9
For: SX Drives



**18-4212
PROP CONE SCREW**
Replaces: 850889
(5/16" - 18 thread)



**18-4213
SPACER**
Replaces: 851261,
854047
AQ275, 280, 290



**18-4214
LOCKING WASHER**
Replaces: 897367
AQ Drive Units: 200, 250,
270, 270T (TID UTF) 275, 280,
280T, 280PT (TID UTF)



**18-4215
COVER SCREW**
Replaces: 941816
(1/4" — 20)



**18-2153
SETTING PIVOT PIN**
Replaces: 814301
AQ200, 250, 270, 275, 280



**18-2454
DRAIN PLUG**
3/8" - 16 thread
Replaces: 3854539
For: Volvo SX drives
Use o-ring **18-7145**

②18-3733D Display Package



**18-3733
PROP NUT KIT**
For: SX Cobra
— Contains —

Part #	Description	Qty.
18-4194	Spacer	1
18-3708-1	Nut & Keeper	1
18-3741	Cotter Pin	1



**18-4194
PROP SPACER**
Replaces: 3852350
For: Lower gearcase models SX-M (1994)



**18-3708-1
PROP NUT & KEEPER**
Replaces: 3850984

PKG. OF 10



**18-3744
18-3744-9^①
COTTER PIN**
Replaces: 3852255
For: XDP, MDSSL, MD22P, TMD22,
TMD22P, TAMD22P, PJX, SX, DPS,
DP, 3.0L GS, GL, 4.3L GL, GS, GI,
5.0L FL, FI, 5.7L GL, GI, 5.8L FL, FI, FSI

PKG. OF 3



**18-3745
18-3745-9^①
COTTER PIN**
Replaces: 17253-6

PKG. OF 5



**18-4238
18-4238-9^①
LOCK CATCH SCREW**
For Stern Drive Cover 18-4206
Replaces: 943218
AQ200, 250, 270, 275, 280, 290



**18-4239
LOCK CATCH**
For Stern Drive Cover 18-4206
Replaces: 897873
AQ200, 250, 270, 275, 280, 290

PKG. OF 5



**18-4241
18-4241-9^①
ROLL PIN**
Replaces: 951924
AQ200, 250, 270, 275, 280, 290



**18-1501
DETENT BALL**
Replaces: 3852023
For: 3.0L GS, GL, 4.3L GL, GS, GI,
5.0L FL, FI, 5.7L GL, GI, 5.8L FL, FI, FSI

PKG. OF 5



**18-3722
18-3722-9^①
STAINLESS STEEL LOCKNUT**
Replaces: 3852005
For: PJX, SX, DPS, DP, DPX, 3.0L GL, GS,
4.3L GL, GS, GI, 5.0L FL, FI, 5.7L GL, GI,
5.8L FL, FI, FSI, 7.4L GL, GI, GSI, 8.2L GL



**18-0549
PLUG OFF CAP
1"**
Replaces: 3852476
For: 4.3L GL, GS, GI, GSI, 5.0L FL, FI, 5.7L GL,
GI, 5.8L FL, FI, FSI, 7.4L GL, GI, GSI, 8.3L GI,
GSI, GXI, 8.2L GL, GSI



**18-2138
PIVOT PIN BEARING**
Replaces: 3852544
For: 3.0L GS, GL, 4.3L GL, GS, GI,
5.0L FL, FI, 5.7L GL, GI, 5.8L FL, FI, FSI

^① Priced per Package

^② Items ending in "D" are Display Packaged - Regular number is Non-Display

Zinc is for saltwater only applications.
Magnesium is for fresh water only applications.
Aluminum is for brackish water, or if boat is used in both fresh and salt environments.



③ **18-6123Z**
ANODE
Replaces: 873395
Transom Shield



③ **18-6124Z**
ANODE
Replaces: 872793
DPS Steering Arm



① **18-6125A**
② **18-6125M**
③ **18-6125Z**
TRANSOM PLATE
Replaces:
3586461 (Alumuminum)
3855610 (Magnesium)
3854130 (Zinc)



① **18-6126A**
② **18-6126M**
③ **18-6126Z**
TRANSOM ANODE
(with bolt)
Replaces:
3888816 (Alumuminum)
3888818 (Magnesium)
3888817 (Zinc)
SX-A, DPS-A, DPS-A Oxi



① **18-6127A**
② **18-6127M**
③ **18-6127Z**
TRANSOM ANODE
(with bolt)
Replaces:
3888813 (Alumuminum)
3888815 (Magnesium)
3888814 (Zinc)
SX-A, DPS-A, DPS-A Oxi



③ **18-6000**
① **18-6000A**
② **18-6104**
ANODE
Replaces: 832598,
873179
For 200, 250, 250C, 250D, 270,
270B, 270C, 270D, 275, 280,
280C, 280D, 280DP, 280L, 280PT



③ **18-6001**
ANODE
Replaces: 838929
AQ200 (For shield), MD19, 21,
27, 29, 32, 2003, AQ30, 31, 40, 41
For Fresh Water Cooler



③ **18-6004**
① **18-6004A**
② **18-6105**
ANODE
Replaces: 852835,
873178
For 290, 290A, 290ADP, 290B



③ **18-6005**
ANODE
Replaces: 875805
AQ250, 270, 270T, 275



③ **18-6009**
① **18-6009A**
ANODE
Replaces: 875815



③ **18-6028**
① **18-6028A**
② **18-6102**
ANODE
Replaces: 3855411, 984513
(18-6028), 3863193 (18-6028A),
3855412 (18-6102)
For use on Gearcases: 2.3L (1987-90), 2.6L/
3.5L/4.6L (1989), 3.0L/4.3L/5.0L/5.8L (1987-
93), 5.7L (1987-92), 7.4L (1987-88)



③ **18-6010**
① **18-6010A**
② **18-6106**
ANODE
Replaces: 875821
280DP, 290DP



18-6130
ANODE
Replaces: Volvo
Fits: Volvo IPS Drives



18-6131
ANODE
Replaces: Volvo
Fits: Volvo IPS Drives



18-6128A
ANODE KIT
Replaces: Volvo
Fits: Volvo SX-A & DPS Drives



18-6128M
ANODE KIT
Replaces: Volvo
Fits: Volvo SX-A & DPS Drives



18-6128Z
ANODE KIT
Replaces: Volvo
Fits: Volvo SX-A & DPS Drives



18-6129A
ANODE KIT
Replaces: Volvo
Fits: Volvo DPH Drives



18-6129M
ANODE KIT
Replaces: Volvo
Fits: Volvo DPH Drives



18-6129Z
ANODE KIT
Replaces: Volvo
Fits: Volvo DPH Drives



18-1076
BELLOWS
Replaces: Volvo 3888916
Fits: Volvo SX-A & DPS-A Drives



③ **18-6021**
ANODE PLUG
Replaces: 838928
AQ30, 31, 40, 41, MD10, 21,
27, 29, 32, 2003



18-2598
LOWER UNIT SEAL KIT
Replaces: 3855275
Fits: Volvo SX Thru 2006



18-2586
UPPER UNIT SEAL KIT
Replaces: 3850594
Fits: Volvo SX Thru 2006



18-2726
UPPER UNIT SEAL KIT
Replaces: 3888917
Fits: Volvo SX-A/DPS-A (2007& Up)

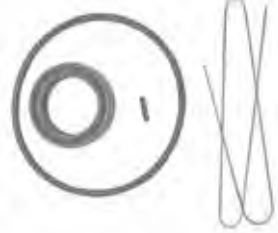

18-3893
GEAR SHIFT MECHANISM GASKET SET
Fits: 275A, 280, 280DP, 280T, 285A, 290, 290A, 290DP, SP-A, SP-A/MT, SP-A1, SP-A2, SP-C, SP-C1, DP-A, DP-A1, DP-A2, DP-B, DP-B1, DP-C, DP-C1, DP-D, DP-D1, DP-E, DP-G, DPX, DPX-S, XDP-B



**18-2597
UPPER GEAR
UNIT SEAL KIT**

For intermediate housing: Fits: 200, 250, 270, 270T, 275, 275A, 280, 280DP, 280T, 285A, 290, 290A, 290DP, SP-A, SP-A/MT, SP-A1, SP-A2, SP-C, SP-C1, DP-A, CP-A1, DP-B, DP-B1, DP-C, DP-C1, DP-D, DP-D1, DP-E, DP-G, DPX, DPX-S, DPX-S1



**18-3888
LOWER GEAR
UNIT SEAL KIT**

For intermediate housing: Fits: 200, 250, 270, 270T, 275, 275A, 280, 280DP, 280T, 285A, 290, 290A, 290DP, SP-A, SP-A/MT, SP-A1, SP-A2, SP-C, SP-C1, DP-A, CP-A1, DP-B, DP-B1, DP-C, DP-C1, DP-D



**18-8357
COMPLETE
GEARCASE SEAL KIT**
Replaces: 875741
For: 280DP/290DP

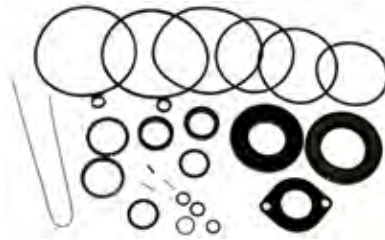

**18-8361
UPPER SEAL KIT**
Replaces: 576266-8
For: AQ200-AQ290

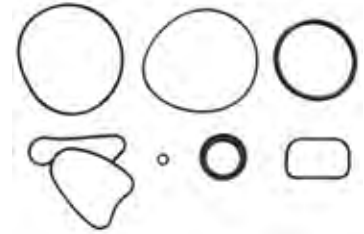

**18-2583
LOWER UNIT SEAL KIT**
Replace: 3888821
Fits: SX-A Drives (2007 and UP)



**18-2584
LOWER UNIT SEAL KIT**
Replaces: 3888822
Fits: DPS-A Drives (2007 and UP)

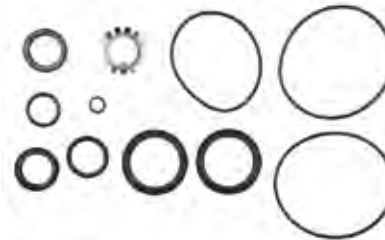

**18-8358
LOWER UNIT SEAL KIT**
Replaces: 876267
For: 280DP/290DP

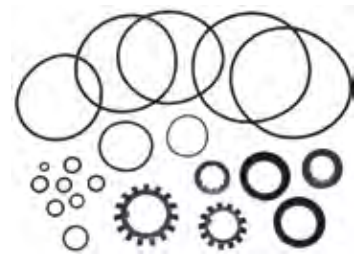

**18-8359
LOWER GEARCASE
SEAL KIT**
Replaces: 876268
For: AQ200-AQ290



**18-2791
LOWER UNIT SEAL KIT**
Replaces: 3850597



**18-2625
STERNDRIVE GASKET KIT**
Replaces: 875192
AQ200, 250, 270, 275, 280, 290



**18-32882
WATER TUBE SEAL**
Replaces: 3852315



OIL SEALS

Part #	O.E. #	Dimensions (mm)		
		I.D.	O.D.	Width
18-0558	851407	44	58.33	7
18-2039	804695	13	25.4	6
18-2040	853670	45	75	8
18-2041	897426	33	45.25	7
18-2043	958838	25	35	7
18-2044	833996	12	24	7
18-2045	827247	16	28	7
18-2046	946242	35	55	10
18-2047	958860	35	62	7
18-2057	181620	34	42	4

O-RINGS

Part #	Pkg.	O.E. #	Dimensions (mm)		Part #	Pkg.	O.E. #	Dimensions (mm)	
			I.D.	Width				I.D.	Width
18-7122		925095	—	—	18-7181	5	925091, 975672	50.5	3
18-7154		949656	—	—	18-7182	5	925092	55	3
18-7102	5	3852073	.430	.065	18-7183	5	925093	69.5	3
18-7116		3852045	.360	.10	18-7184	5	925256	79	3
18-7135		3852089	.750	.135	18-7186	5	925259	102	3
18-7141	5	3852165	.180	.065	18-7187	5	925261	106	3
18-7143	5	3852169	1.310	.100	18-7188	5	955983	9.1	1.6
18-7147-9	5	949658-9	24	3	18-7190	5	925065	34	3
18-7149	5	955989	15	1.5	18-7192	5	955995	25.1	1.6
18-7162	5	3852044	2.025	.135	18-7193	5	955974	10.3	2.4
18-7168	5	3852033	.370	.065	18-7194	5	956000	37.1	1.6
18-7178	5	125017	23.5	3.5	18-7406	5	3852523	.250	.065
18-7179	5	925054	9.3	2.4	18-7407	5	3852531	4.125	.135
18-7180	5	925055	11.3	2.4					



① This product is priced per piece. To order priced per package, please add -9 to the part number.



**18-3060
IMPELLER**
Replaces: 835512, 3854286
Sherwood 9959,
Jabsco 18838-0001
Oberdorfer 132-0317
OMC 3854286
Neoprene, 12 FINS



**18-5280
COMPLETE TUNE-UP KIT**
For: In-line 4

— CONTAINS —

Part #	Description	Qty.
18-5361	DISTRIBUTOR CAP	1
18-5406	ROTOR	1



**18-5278
COMPLETE TUNE-UP KIT**
For: V-6



**18-5301
TUNE-UP KIT**
Replaces:
Fits: male cap v-8 flamethrower distributors



**18-5302
TUNE-UP KIT**
Replaces:
Fits: male cap v-8 flamethrower distributors



**18-59640
ALTERNATOR**
Replaces: Prestolite



**18-6843
ALTERNATOR**
Replaces: Mando A000B0341,
TA000B0341,
Yamaha 19-1400-10
Fits: Crusader and Yamaha Sterndrive
engines



**18-6834
STARTER**
Replaces: GM Engines Universal
Used on all GM Engines with either 14 1/4"
or 12 3/4" flywheels



**18-6835
STARTER**
Replaces: GM Engines Universal
Used on all GM Engines with either 14 1/4" or 12 3/4"
flywheels

PREMIUM MARINE SPARK PLUG WIRE LEADS

Sierra's MAGFORCE Ignition Wires are "Electronics Friendly" protecting all of your electronic devices and electronic engine controls from RFI and EMI while delivering the maximum amount of voltage. Exact fit design ensures easy installation and years of trouble - free service.

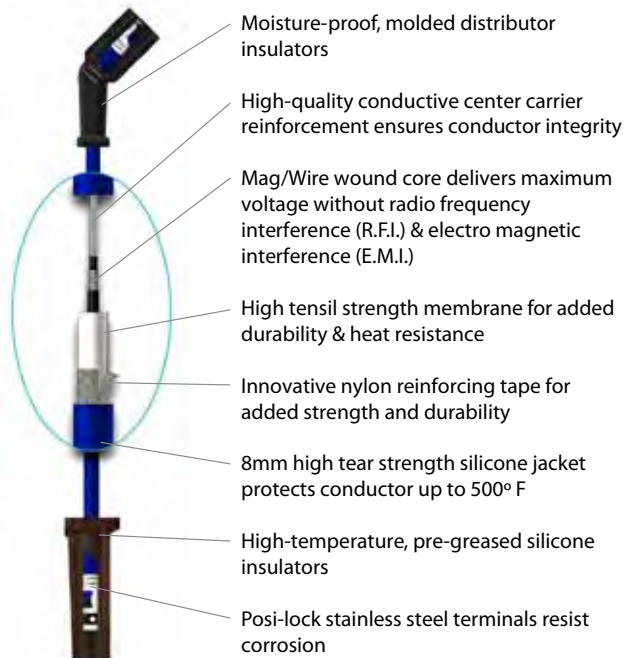

YAMAHA STERNDRIVE APPLICATION					
Model	Cyl.	Distributor	Year Start	Year End	Plug Wire Set
3.0L	4	Delco EST	1990	1993	18-8835-1
4.3L	6	YEMS	1989	1989	18-8835-1
4.3L	6	Delco EST	1990	1990	18-8835-1
5.0L	8	YEMS	1989	1989	18-8836-1
5.7L	8	Delco EST	1989	1990	18-8836-1
7.4L	8	Delco EST	1992	1992	18-8836-1



FUEL WATER SEPARATORS



Sierra offers a complete line of 10 and 21 micron fuel water separating filters including drainable bowl filters to protect your carbureted and fuel injected engine.

Refer to pages 136-140 for a complete listing of OEM and universal applications.

Sierra fuel water separators remove over 99.8% of emulsified water from your gasoline. Sierra's 10 micron filters are over 90% efficient at removing particles as small as 10 micron. All filters flow @ 90 GPH to feed even the hungriest motor. Sierra 10 micron filters are recommended to prevent damage to sensitive inboard and outboard fuel injection systems.



STERNDRIVE & INBOARD OIL FILTERS

All 3.0L	YSC-13231-20-0C	18-7824-2
All V-8 5.0L, 5.7L (Spin on Lube)	YSC-14231-20-0C	18-7876-1
All V-8 5.0L, 5.7L, 7.4L	YSC-16231-20-0C	18-7875

SEE PAGES 182-184 & 1147-1170 FOR ADDITIONAL INFORMATION

V-BELTS

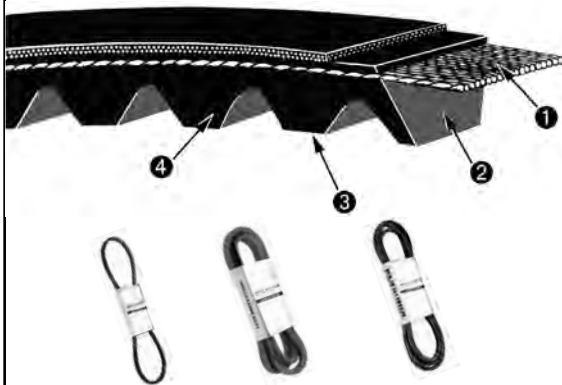

- 1** High strength synthetic cords resist shockload failure. Their low stretch properties assure uniform performance over the life of the belt.
- 2** The compression section is a special rubber compound that assures smooth and even transfer of load forces to the cords.
- 3** Cogs are molded to precise engineering tolerances to improve flexibility and maintain cord support. Cog geometry provides a large area for air circulation to keep the belt cool and prevent damaging heat build up in the cushion section.
- 4** Rubber edges maintain positive, no-slip contact with pulley grooves for reliable energy transfer.

Part #	OE #	Application
18-15106	YSC-13260-60-0C	L4 Sterndrive 3.0L (For: water pump)
18-15109	YSC-22260-00-0C	V-8 Sterndrive 7.4L (For: alternator)
18-15110	YSC-10260-10-0C	V-6 Sterndrive 4.3L/V-8, 5.7L (For: crank/power steering)
18-15111	YSC-10260-00-0C	V-6 Sterndrive 4.3L/V-8 5, 5.7L (For: crank/pump alternator)

YAMAHA STERNDRIVE GASKETS

<p>PKG. OF 2</p>  <p>18-0164 18-0164-9① THERMOSTAT GASKET Replaces: YSC-13080-00-0C, GM 3789161</p>	<p>PKG. OF 2</p>  <p>18-0876 18-0876-9① FUEL PUMP GASKET Replaces: YSG-10108-43-8G</p>	<p>PKG. OF 2</p>  <p>18-0889 18-0889-9① FUEL PUMP GASKET Replaces: YSG-10114-14-1G</p>	<p>PKG. OF 2</p>  <p>18-0891 18-0891-9① WATER PUMP MOUNTING GASKET Replaces: YSG-37545-87-G0</p>	<p>PKG. OF 2</p>  <p>18-0874 18-0874-9① DISTRIBUTOR GASKET Replaces: YSG-10108-44-5G</p>
<p>PKG. OF 2</p>  <p>18-2909 18-2909-9① EXHAUST MANIFOLD GASKET Replaces: YSC-12190-00-AC For: 262 CID (4.3L)</p>	<p>PKG. OF 2</p>  <p>18-0903 18-0903-9① WATER PUMP GASKET Replaces: YSG-38600-39-G0</p>	<p>PKG. OF 2</p>  <p>18-0887 18-0887-9① TIMING COVER GASKET Replaces: YSG-14096-15-6G</p>	<p>PKG. OF 2</p>  <p>18-0905 18-0905-9① OIL PAN DRAIN PLUG GASKET Replaces: YSG-14090-90-8G</p>	<p>PKG. OF 2</p>  <p>18-4698 18-46981-9① (PKG. OF 50) DRAIN FILL WASHER Replaces: 90430-08020-00</p>

① Priced per Package

MALLERY DISTRIBUTOR PARTS GUIDE

Distributor No.	Cyl. & Rotation	Description	Contact Set	Condenser	Dist. Cap	Rotor	Tune-Up Kit
ZD345A, B	8RH	Crusader	18-5314	18-5344	18-5376	18-5404-1	—
ZD347A	8LH	Crusader	18-5314	18-5344	18-5375	18-5411	—
ZD347B	8RH	Crusader	—	18-5344	18-5375	18-5411	—
YD349A	4LH	Burmeister & Wain	18-5314	18-5338	18-5355	18-5427	—
YD350A	8LH	Dearborn	18-5314	18-5338	18-5375	18-5411	18-5256 ①
YL350A	8LH	262, 272, 292, 312 Eng.	18-5314	18-5338	18-5376	18-5404-1	18-5251 ②
ZD352	8RH	Crusader	18-5314	18-5344	18-5375	18-5411	—
YD356A	8RH	Flagship Owens	18-5314	18-5338	18-5375	18-5411	18-5256 ①
YL356A	8RH	Flagship Owens	18-5314	18-5338	18-5375	18-5411	18-5256 ①
YL356A-2	8RH	Flagship	18-5314	18-5338	18-5375	18-5411	18-5256 ①
ZD358A	8LH	Crusader	18-5314	18-5344	18-5375	18-5411	—
YD359C, D, E, F	8LH	Gray (250, 327) AM Mtrs.	18-5314	18-5338	18-5376	18-5404-1	18-5251 ②
YL362A, B	8LH	Dearborn 390 Eng.	18-5314	18-5338	18-5375	18-5411	18-5256 ①
YD362A, B	8LH	Dearborn 390 Eng.	18-5314	18-5338	18-5375	18-5411	18-5256 ①
YL362C, D, E, F, G, H	8LH	390, 427 Eng.	18-5314	18-5338	18-5375	18-5411	18-5256 ①
YL362AV, BV, CV, DV	8LH	Dearborn 390 Eng.	18-5314	18-5338	18-5375	18-5411	18-5256 ①
ZD366A, B	8LH	Crusader (Cadillac 275 Eng.)	18-5314	18-5344	18-5375	18-5411	—
YD370A	4RH	Universal Mts.	18-5314	18-5338	18-5355	18-5427	—
YD370B	6RH	Universal Mts.	18-5314	18-5338	—	18-5427	—
YD370C	4RH	Universal Mts.	18-5314	18-5338	18-5355	18-5427	—
YL370A	4RH	Universal Mts.	18-5314	18-5338	18-5355	18-5427	—
YL370B	6RH	Universal Mts.	18-5314	18-5338	—	18-5427	—
YD372A, B, C, D	8LH	Chris Craft 430 Eng.	18-5314	18-5338	18-5375	18-5411	18-5256 ①
YL372C, D	8LH	Chris Craft 430 Eng.	18-5314	18-5338	18-5375	18-5411	18-5256 ①
YD372F-2	8LH	431 Eng.	18-5314	18-5338	18-5375	18-5411	18-5256 ①
YD375A	8RH	Chrysler M80	18-5314	18-5338	18-5376	18-5404-1	18-5251 ②
YD377A	6LH	Palmer	18-5314	18-5338	—	18-5427	—
YL387A	8LH	Dearborn	18-5314	18-5338	18-5376	18-5404-1	18-5251 ②
YD396A	6RH	Palmer 308 Eng.	18-5314	18-5338	—	18-5427	—
YD397A	6RH	Palmer 308 Eng.	18-5314	18-5338	—	18-5427	—
YD410A	4RH	Gray	18-5314	18-5338	18-5355	18-5427	—
YD410C	6RH	Gray	18-5314	18-5338	—	18-5427	—
YD411A	4RH	Gray	18-5314	18-5338	18-5355	18-5427	—
YD411B	4LH	Gray	18-5314	18-5338	18-5355	18-5427	—
YD411C	6RH	Gray	18-5314	18-5338	—	18-5427	—
YD411D	6LH	Gray	18-5314	18-5338	—	18-5427	—
YL411A	4RH	F-4 Turbo	18-5314	18-5338	18-5355	18-5427	—
YL411B	4LH	F-4 Turbo	18-5314	18-5338	18-5355	18-5427	—
YL411C	6RH	F-6 Turbo	18-5314	18-5338	—	18-5427	—
YL411D	6LH	F-6 Turbo	18-5314	18-5338	—	18-5427	—
YL414D, E, J, K	6RH	Dearborn	18-5314	18-5338	—	18-5427	—
YD420A, B, C, D	8RH	Palmer 345 Eng.	18-5314	18-5338	18-5375	18-5411	18-5256 ①
YL420E	8RH	IHC 304, 345, 392 Eng.	18-5314	18-5338	18-5375	18-5411	18-5256 ①
YD429A, B	8LH	Gray	18-5314	18-5338	18-5376	18-5404-1	18-5251 ②
YD429C, D	8LH	Gray	18-5314	18-5338	18-5375	18-5411	18-5256 ①
YL429C, D	8LH	138, 175 Eng.	18-5314	18-5338	18-5375	18-5411	18-5256 ①
ZD430A	8RH	170, 220, 225 HP	—	18-5338	18-5375	18-5411	—
YL431A	8RH	Crusader	18-5314	18-5338	18-5375	18-5411	18-5256 ①
ZYLD431A	8RH	185, 220, 230 HP	18-5314	18-5338	18-5375	18-5411	18-5256 ①
YL436A,B	6RH	Dorsett	18-5314	18-5338	—	18-5427	—

① 18-5272 Kit with distributor cap ② 18-5271 Kit with distributor cap

MALLORY DISTRIBUTOR PARTS GUIDE (CONT.)

Distributor No.	Cyl. & Rotation	Description	Contact Set	Condenser	Dist. Cap	Rotor	Tune-Up Kit
YL445A, B, BD, JV, KV	8LH	Dearborn	18-5314	18-5338	18-5375	18-5411	18-5256 ①
YP451A, B, C, D, E, F, G, H	6 RH	Chrysler M170 & M225 Engs.	18-5314	18-5338	—	—	—
YL455A, B,	8RH	Gray	18-5314	18-5338	18-5376	18-5404-1	18-5251 ②
YL457AC,AV, BV, CV, DV	8LH	Dearborn	18-5314	18-5338	18-5375	18-5411	18-5256 ①
YL458B	8RH	Gray	18-5314	18-5338	18-5376	18-5404-1	18-5251 ②
YL459A	8RH	Gray	18-5314	18-5338	18-5375	18-5411	18-5256 ①
YL461A, B	8RH	Crusader 409 Eng.	18-5314	18-5338	18-5376	18-5404-1	18-5251 ②
YL461A-2, B-2	8RH	427 Eng.	18-5314	18-5338	18-5376	18-5404-1	18-5251 ②
YL467A	8RH	Daytona (283, 327 Chevy Eng.)	18-5314	18-5338	18-5376	18-5404-1	18-5251 ②
YL469A	8RH	Chris-Craft (283, 327 Chevy Eng.)	18-5314	18-5338	18-5375	18-5411	18-5256 ①
YL474D, E	6RH	Dearborn (200 Ford Eng.)	18-5314	18-5338	—	18-5427	—
YL481A, B	6RH	Chevy 230, 292 Engs.	18-5314	18-5338	—	18-5427	—
YL486A,B,	6RH	Crusader (230, 292 Chevy Eng.	18-5314	18-5338	—	18-5427	—
YL486C,D,	4 RH	Crusader 153 Eng.	18-5314	18-5338	18-5355	18-5427	—
YL487A	8RH	Crusader (283, 327 Chevy Eng.	18-5314	18-5338	18-5376	18-5404-1	18-5251 ②
YL494A, BO	8LH	Dearborn	18-5314	18-5338	18-5376	18-5404-1	18-5251 ②
YL494A-2, B-2	8LH	427 Eng.	18-5314	18-5338	18-5376	18-5404-1	18-5251 ②
YL495A,B	6RH	Dearborn (170 Ford Eng.)	18-5314	18-5338	—	18-5427	—
YL496A, B,	8LH	Holman & Moody	18-5314	18-5338	18-5375	18-5411	18-5256 ①
YL501AV, CV, EV, GV	8LH	Oldsmobile Eng.	18-5314	18-5338	18-5375	18-5404-1	18-5251 ②
YL502A, B	8LH	Chris-Craft (427 Ford Eng.)	18-5314	18-5338	18-5375	18-5411	18-5256 ①
YL512A	8LH	289 Eng.	18-5314	18-5338	18-5376	18-5404-1	18-5251 ②
YL512CV, DV	8LH	Ford 302 Eng.	18-5314	18-5338	18-5376	18-5404-1	18-5251 ②
YL513A, B	8LH	Dearborn (289 Ford Eng.)	18-5314	18-5338	18-5376	18-5404-1	18-5251 ②
YL513CV, DV	8LH	Ford 289, 302 Engs.	18-5314	18-5338	18-5376	18-5404-1	18-5251 ②
YL514A, B, C, D	8LH	352, 390, 427, 428 Engs.	18-5314	18-5338	18-5376	18-5404-1	18-5251 ②
YL515A, B	8RH	283, 327 Engs.	18-5314	18-5338	18-5375	18-5411	18-5256 ①
YL519A, B, AV, BV	8LH	Dearborn (289 Ford Eng.)	18-5314	18-5338	18-5375	18-5411	18-5256 ①
YL520AV, BV, CV, CV2, DV, EV, JV	8RH	OMC	18-5314	18-5338	18-5375	18-5411	18-5256 ①
YL524AV, BV	6RH	300 Eng.	18-5314	18-5338	—	18-5427	—
YL529A, B	8RH	Crusader (283, 327 Engs.)	18-5314	18-5338	18-5375	18-5411	18-5256 ①
YL539AV	8RH	Chris-Craft (327 Chevy Eng.)	18-5314	18-5338	18-5375	18-5411	18-5256 ①
YL554CV, DV, EV, FV	8LH	Ford 351W Eng.	18-5314	18-5338	18-5376	18-5404-1	18-5251 ②
YL555CV, DV	8LH	Ford 351W Eng.	18-5314	18-5338	18-5376	18-5404-1	18-5251 ②
YL558AV, BV	8LH	Ford 351C Eng.	18-5314	18-5338	18-5375	18-5411	18-5256 ①
YL566AV	8RH	Chris-Craft (327 Chevy Eng.)	18-5314	18-5338	18-5375	18-5411	18-5256 ①
YL567CV, DV	8LH	Ford 351 Eng.	18-5314	18-5338	18-5376	18-5404-1	18-5251 ②
YL585AV, CV-2	8RH	Chris-Craft	18-5314	18-5338	18-5375	18-5411	18-5256 ①
YL623AV	8	Chris-Craft Thermo-Electron	18-5314	18-5338	18-5376	18-5404-1	18-5251 ②
YL623AV-2	8	Chris-Craft, Mercury	18-5314	18-5338	18-5375	18-5404-1	18-5251 ②
YL624AV	8	Gale Banks, Maritec,Mercury	18-5314	18-5338	18-5375	18-5404-1	18-5251 ②
YL624AV-2	8	Harmin	18-5314	18-5338	18-5375	18-5404-1	18-5251 ②
YL624JV	8	O.M.C.	18-5314	18-5338	18-5376	18-5404-1	18-5251 ②
YL624MV	8	Mercury (Mercuriser)	18-5314	18-5338	18-5376	18-5404-1	18-5251 ②
YL670AV	8	Chevy - Exc 348, 409 Eng.	18-5314	18-5338	18-5376	18-5404-1	18-5251 ②
YL673AV	4	Chevy 153 Eng.	18-5314	18-5338	18-5397	18-5404-1	18-5251 ②
YL676AV	6	Chevy In Line	18-5314	18-5338	—	—	18-5251 ②
YL677AV	6	Chevy Odd Fire	18-5314	18-5338	—	18-5404-1	—
YL/YS700AV	6	Chevy Even Fire	18-5314	18-5338	—	18-5404-1	18-5251 ②
YL703AV	8	Crusader/Thermo-Electron	18-5314	18-5338	18-5376	18-5404-1	18-5251 ②

① 18-5272 Kit with distributor cap

② 18-5271 Kit with distributor cap

PRESTOLITE DISTRIBUTOR PARTS GUIDE

Distributor Number	Contact Set	Condenser ③	Rotor	Cap	Ignition Coil	Tune-Up Kit
IAD-6004-2F, 2N, 2P	18-5307	18-5345	—	—	18-5435 ①	—
IAO-4109-1M	18-5307	18-5345	18-5430	18-5392	18-5435 ①	—
IAO-4113-1M	18-5307	18-5345	18-5430	18-5392	18-5435 ①	—
IAO-4114-1M	18-5307	18-5345	18-5430	18-5392	18-5435 ①	—
IAY-4010, A	18-5307	18-5345	18-5427	—	18-5435 ①	—
IAY-4014	18-5307	—	18-5427	—	18-5435 ①	—
IAY-4014C	18-5307	18-5345	18-5427	—	18-5435 ①	—
IBB-4205	18-5303 ②	—	18-5407	—	18-5435 ①	—
IBB-4301B	18-5303 ②	18-5345	18-5407	18-5369	18-5433	18-5255 ⑦
IBB-7003	18-5303 ②	18-5345	18-5407	18-5369	18-5435 ①	18-5255 ⑦
IBM-4106	18-5303	18-5345	18-5407	18-5369	—	18-5255 ⑦
IBM-4107, A	18-5303	18-5345	18-5407	18-5369	18-5435 ①	18-5255 ⑦
IBM-4108, A, B, C	18-5303	18-5345	18-5407	18-5369	—	18-5255 ⑦
IBM-4109, A	18-5303	18-5345	18-5407	18-5369	—	18-5255 ⑦
IBM-4110	18-5303	18-5345	18-5429	18-5391	—	18-5259
IBM-4112	18-5303	18-5345	18-5429	18-5391	18-5435 ①	18-5259
IBM-4115	18-5303	18-5345	18-5429	18-5391	18-5435	18-5258
IBM-4116	18-5303	18-5345	18-5429	18-5391	18-5435	18-5258
IBM-4117A	18-5303	18-5345	18-5407	18-5369	18-5435 ①	18-5255 ⑦
IBM-4118A	18-5303	18-5345	18-5429	18-5391	18-5435 ①	18-5259
IBM-4119, A	18-5303	18-5345	18-5429	18-5391	18-5435 ①	18-5259
IBM-4120	18-5303	18-5347	18-5429	18-5391	18-5433	18-5259
IBM-4122	18-5303	18-5347	18-5407	18-5369	18-5435 ①	18-5258 ⑦
IBM-7003B, BS	18-5303	18-5345	18-5407	18-5369	18-5433	18-5255 ⑦
IBM-7004A, AS, B, BS	18-5303	18-5345	18-5407	18-5369	18-5435 ①	18-5255 ⑦
IBM-7007, A, AS, S	18-5303	18-5345	18-5407	18-5369	18-5435 ①	18-5255 ⑦
IBM-7008, A, AS, B, BS, C, CS, S	18-5303	18-5345	18-5407	18-5369	18-5435 ①	18-5255 ⑦
IBM-7010	—	18-5345	18-5407	18-5369	18-5433	—
IBM-7011	18-5303	18-5345	18-5407	18-5369	18-5433	18-5255 ⑦
IBM-7011A	18-5303	18-5345	18-5407	18-5369	18-5435 ①	18-5255 ⑦
IBM-7011B	—	18-5345	18-5407	18-5369	18-5435 ①	—
IBM-7011C, D	18-5303	18-5345	18-5407	18-5369	18-5435 ①	18-5255 ⑦
IBM-7013	18-5303	18-5345	18-5403	18-5352	—	18-5260 ④
IBM-7013A	18-5303	18-5345	18-5403	18-5352	18-5433	18-5260 ④
IBM-7013B	—	18-5345	18-5403	18-5352	—	—
IBM-7013C, D, E	18-5303	18-5345	18-5403	18-5352	—	18-5260 ④
IBM-7014	18-5303	18-5345	18-5403	18-5353	—	18-5260 ⑥
IBM-7014A	18-5303	18-5347	18-5403	18-5353	18-5433	18-5258 ⑥
IBM-7016	18-5303	18-5345	18-5409	18-5352	—	18-5260 ④
IBM-7017	18-5303	18-5345	18-5409	18-5352	—	18-5260 ④
IBM-7018	18-5303	18-5345	18-5409	18-5353	—	18-5260 ⑥
IBM-7019, A, AS, S	18-5303	18-5345	18-5403	18-5352	18-5435 ①	18-5260 ④
IBM-7020, A, AS, B, BS, C, CS, S	18-5303	18-5345	18-5403	18-5352	18-5435 ①	18-5260 ④
IBM-7021	18-5303	18-5345	18-5403	18-5353	—	18-5260
IBP-4105, A	—	18-5345	18-5407	18-5369	18-5435 ①	—
IBP-4110, A, B	—	18-5345	18-5429	18-5391	18-5435 ①	—
IBP-4111A	—	18-5345	18-5407	18-5369	18-5435 ①	—
IBP-4112A, B	—	18-5345	18-5429	18-5391	18-5435 ①	—
IBP-4113A, B, C	—	18-5345	18-5429	18-5391	18-5435 ①	—
IBR-4205, A, S	—	18-5347	—	—	18-5435 ①	—
IBR-7002, A, AS, S	18-5307	18-5345	18-5430	18-5392	18-5433	—
IDD-7001	N/A	N/A	18-5407	18-5369	—	N/A
IDH-7001, S	N/A	N/A	18-5407	18-5369	—	N/A
IDH-7002, S	N/A	N/A	18-5407	18-5369	—	N/A
IDH-7003, A, AS, S	N/A	N/A	18-5407	18-5369	—	N/A
IDH-7004	N/A	N/A	18-5409	18-5352	—	N/A
IDH-7005	N/A	N/A	18-5409	18-5352	—	N/A
IDH-7006, A	N/A	N/A	18-5403	18-5352	—	N/A
IDH-7802	N/A	N/A	18-5403	—	18-5433	N/A
IDU-7601	N/A	N/A	18-5403	18-5353	—	N/A
IDU-7801, A, B	N/A	N/A	18-5403	18-5352	18-5433	N/A
IGC-5501A	18-5307	18-5345	18-5430	—	18-5435 ①	—
IGW-4056	—	—	—	—	18-5433	—
IGW-4118A	—	—	—	—	18-5435 ①	—
IGW-4199B, C	—	—	—	—	18-5435 ①	—
IGW-4301	—	—	—	—	18-5435 ①	—
IGW-4409A	—	—	—	—	18-5435 ①	—

N/A Not Applicable ① 12 Volt System Only ② 2 Required ③ Condensers 18-5340 (Wire Conductor) and 18-5347 (Strap Conductor) are interchangeable.

④ 18-5275 Kit with distributor cap

⑥ 18-5276 Kit with distributor cap

⑦ 18-5277 Kit with distributor cap

Evinrude Outboards 1950-1979			Evinrude Outboards 1950-1979			Evinrude Outboards 1950-1979			Evinrude Outboards 1950-1979		
MODEL NO.	HP	YEAR	MODEL NO.	HP	YEAR	MODEL NO.	HP	YEAR	MODEL NO.	HP	YEAR
3402	3	1964	6203	6	1972	10925	9.9	1979	25702	25	1977
3412	3	1964	6302	6	1973	10935	9.9	1979	25703	25	1977
3432	3	1964	6303	6	1973	10954	9.9	1979	25752	25	1977
3433	3	1964	6402	6	1974	10955	9.9	1979	25753	25	1977
3502	3	1965	6403	6	1974	15032	18	1960	25802	25	1978
3512	3	1965	6502	6	1965	15033	18	1960	25803	25	1978
3532	3	1965	6503	6	1965	15034	18	1961	25852	25	1978
3533	3	1965	6504	6	1975	15035	18	1961	25853	25	1978
3602	3	1966	6505	6	1975	15036	18	1962	25902	25	1969
3603	3	1966	6602	6	1966	15037	18	1962	25903	25	1969
3606	3	1966	6603	6	1966	15404	15	1974	25904	25	1979
3612	3	1966-67	6604	6	1976	15405	15	1974	25905	25	1979
3632	3	1966	6605	6	1976	15454	15	1974	25952	25	1979
3633	3	1966	6702	6	1967	15455	15	1974	25953	25	1979
3636	3	1966	6703	6	1967	15504	15	1975	28202	28	1962
3702	3	1967	6704	6	1977	15505	15	1975	28203	28	1962
3703	3	1967	6705	6	1977	15554	15	1975	28302	28	1963
3706	3	1967	6802	6	1968	15555	15	1975	28303	28	1963
3707	3	1967	6803	6	1968	15604	15	1976	28352	28	1963
3712	3	1967	6804	6	1978	15605	15	1975	28402	28	1964
3716	3	1967	6805	6	1978	15654	15	1976	28403	28	1964
3732	3	1967	6902	6	1969	15655	15	1976	28452	28	1964
3733	3	1967	6903	6	1969	15704	15	1977	33002	33	1970
3736	3	1967	6904	6	1979	15705	15	1977	33003	33	1970
3737	3	1967	6905	6	1979	15754	15	1977	33052	33	1970
3802	3	1968	9022	9.5	1970	15755	15	1977	33053	33	1970
3803	3	1968	9023	9.5	1970	15804	15	1978	33502	33	1965
3806	3	1968	9122	9.5	1971	15805	15	1978	33503	33	1965
3807	3	1968	9123	9.5	1971	15854	15	1978	33552	33	1965
3832	3	1968	9222	9.5	1972	15855	15	1978	33553	33	1965
3833	3	1968	9223	9.5	1972	15904	15	1979	33602	33	1966
3836	3	1968	9322	9.5	1973	15905	15	1979	33603	33	1966
3837	3	1968	9323	9.5	1973	15954	15	1979	33652	33	1966
4006	4	1970	9422	9.5	1964	15955	15	1979	33653	33	1966
4036	4	1970	9423	9.5	1964	18002	18	1970	33702	33	1967
4106	4	1971	9522	9.5	1965	18003	18	1970	33703	33	1967
4136	4	1971	9523	9.5	1965	18102	18	1971	33752	33	1967
4206	4	1972	9622	9.5	1966	18103	18	1971	33753	33	1967
4236	4	1972	9623	9.5	1966	18202	18	1972	33802	33	1968
4306	4	1973	9722	9.5	1967	18203	18	1972	33803	33	1968
4336	4	1973	9723	9.5	1967	18302	18	1963	33852	33	1968
4406	4	1974	9822	9.5	1968	18303	18	1963	33853	33	1968
4436	4	1974	9823	9.5	1968	18304	18	1973	33902	33	1969
4506	4	1975	9922	9.5	1969	18305	18	1973	33903	33	1969
4536	4	1975	9923	9.5	1969	18402	18	1964	33952	33	1969
4606	4	1976	10020	10	1960	18403	18	1964	33953	33	1969
4636	4	1976	10021	10	1960	18502	18	1965	35018	40	1960
4706	4	1977	10022	10	1961	18503	18	1965	35019	40	1960
4736	4	1977	10023	10	1961	18602	18	1966	35022	40	1961
4806	4	1978	10024	10	1962	18603	18	1966	35023	40	1961
4836	4	1978	10025	10	1962	18702	18	1967	35028	40	1962
4837	4	1978	10302	10	1963	18703	18	1967	35029	40	1962
4902	4	1969	10303	10	1963	18802	18	1968	35520	40	1960
4904	4	1979	10422	9.5	1964	18803	18	1968	35521	40	1960
4906	4	1969	10424	9.9	1974	18902	18	1969	35524	40	1961
4932	4	1979	10425	9.9	1974	18903	18	1969	35525	40	1961
4933	4	1979	10454	9.9	1974	25002	25	1970	35530	40	1962
4936	4	1969	10455	9.9	1974	25003	25	1970	35531	40	1962
5302	5.5	1963	10522	9.5	1965	25102	25	1971	35602	35	1976
5303	5.5	1963	10524	9.9	1975	25103	25	1971	35603	35	1976
5402	5.5	1964	10525	9.9	1975	25202	25	1972	35652	35	1976
5403	5.5	1964	10554	9.9	1975	25203	25	1972	35653	35	1976
5502	5	1965	10555	9.9	1975	25252	25	1972	35702	35	1977
5503	5	1965	10622	9.5	1966	25253	25	1972	35703	35	1977
5520	5.5	1960	10624	9.9	1976	25302	25	1973	35752	35	1977
5521	5.5	1960	10625	9.9	1976	25303	25	1973	35753	35	1977
5522	5.5	1961	10654	9.9	1976	25352	25	1973	35802	35	1978
5523	5.5	1961	10655	9.9	1976	25353	25	1973	35803	35	1978
5524	5.5	1962	10722	9.5	1967	25402	25	1974	35852	35	1978
5525	5.5	1962	10724	9.9	1977	25403	25	1974	35853	35	1978
5602	5	1966	10725	9.9	1977	25452	25	1974	35902	35	1979
5603	5	1966	10754	9.9	1977	25453	25	1974	35903	35	1979
5702	5	1967	10755	9.9	1977	25502	25	1975	35932	40	1962
5703	5	1967	10822	9.5	1968	25503	25	1975	35933	40	1962
5802	5	1968	10824	9.9	1978	25552	25	1975	35952	35	1979
5803	5	1968	10825	9.9	1978	25553	25	1975	35953	35	1979
6002	6	1970	10835	9.9	1978	25602	25	1976	40002	40	1970
6003	6	1970	10854	9.9	1978	25603	25	1976	40003	40	1970
6102	6	1971	10855	9.9	1978	25652	25	1976	40052	40	1970
6202	6	1972	10924	9.9	1979	25653	25	1976	40053	40	1970

Evinrude Outboards 1950-1979			Evinrude Outboards 1950-1979			Evinrude Outboards 1950-1979			Evinrude Outboards 1950-1979		
MODEL NO.	HP	YEAR	MODEL NO.	HP	YEAR	MODEL NO.	HP	YEAR	MODEL NO.	HP	YEAR
40072	40	1970	50272	50	1972	70573	70	1975	100693	100	1966
40073	40	1970	50273	50	1972	70673	70	1976	100782	100	1967
40102	40	1971	50302	50	1973	70773	70	1977	100783	100	1967
40103	40	1971	50303	50	1973	70873	70	1978	100882	100	1968
40152	40	1971	50372	50	1973	70973	70	1979	100883	100	1968
40153	40	1971	50373	50	1973	75352	75	1963	100990	100	1979
40202	40	1972	50442	50	1974	75353	75	1963	100993	100	1979
40203	40	1972	50443	50	1974	75382	75	1963	100999	100	1979
40252	40	1972	50472	50	1974	75383	75	1963	115083	115	1970
40253	40	1972	50473	50	1974	75392	75	1963	115393	115	1973
40302	40	1963	50522	75	1960	75393	75	1963	115493	115	1974
40303	40	1963	50523	75	1960	75432	75	1964	115499	115	1974
40304	40	1973	50524	75	1961	75433	75	1964	115593	115	1975
40305	40	1973	50525	75	1961	75452	75	1964	115693	115	1976
40352	40	1963	50528	75	1962	75453	75	1964	115699	115	1976
40353	40	1963	50529	75	1962	75482	75	1964	115742	115	1967-68
40354	40	1973	50542	50	1975	75483	75	1964	115790	115	1977
40355	40	1973	50543	50	1975	75492	75	1964	115793	115	1977
40362	40	1963	50572	50	1975	75493	75	1964	115799	115	1977
40363	40	1963	50573	50	1975	75532	75	1965	115890	115	1978
40372	40	1963	50802	50	1978	75533	75	1965	115893	115	1978
40373	40	1963	50803	50	1978	75542	75	1975	115899	115	1978
40402	40	1964	50902	50	1979	75543	75	1975	115983	115	1969
40403	40	1964	50903	50	1979	75552	75	1965	115990	115	1979
40404	40	1974	50926	75	1961	75553	75	1965	115993	115	1979
40405	40	1974	50927	75	1961	75582	75	1965	115999	115	1979
40452	40	1964	50930	75	1962	75583	75	1965	125183	125	1971
40453	40	1964	50931	75	1962	75592	75	1965	125283	125	1972
40454	40	1974	55642	55	1976	75593	75	1965	135342	135	1973
40455	40	1974	55643	55	1976	75642	75	1976	135383	135	1973
40462	40	1964	55672	55	1976	75643	75	1976	135443	135	1974
40463	40	1964	55673	55	1976	75742	75	1977	135483	135	1974
40472	40	1964	55772	55	1977	75743	75	1977	135489	135	1974
40473	40	1964	55773	55	1977	75842	75	1978	135543	135	1975
40502	40	1965	55872	55	1968	75843	75	1978	135583	135	1975
40503	40	1965	55873	55	1968	75942	75	1979	135589	135	1975
40504	40	1975	55874	55	1978	75943	75	1979	135643	135	1976
40505	40	1975	55875	55	1978	80652	80	1966	135683	135	1976
40552	40	1965	55902-55903	55	1979	80653	80	1966	140740	140	1977
40553	40	1965	55972	55	1969	80682	80	1966	140743	140	1977
40554	40	1975	55973	55	1969	80683	80	1966	140783	140	1977
40555	40	1975	55974	55	1979	80692	80	1966	140840	140	1978
40562	40	1965	55975	55	1979	80693	80	1966	140843	140	1978
40563	40	1965	60062	60	1970	80752	80	1967	140883	140	1978
40572	40	1965	60063	60	1970	80753	80	1967	140940	140	1979
40573	40	1965	60072	60	1970	80792	80	1967	140943	140	1979
40602	40	1966	60073	60	1970	80793	80	1967	140983	140	1979
40603	40	1966	60162	60	1971	85093	85	1970	150840	150	1978
40604	40	1976	60163	60	1971	85193	85	1971	150849	150	1978
40605	40	1976	60172	60	1971	85293	85	1972	150940	150	1979
40652	40	1966	60173	60	1971	85393	85	1973	150949	150	1979
40653	40	1966	60432	60	1964	85493	85	1974	175740	175	1977
40654	40	1976	60433	60	1964	85593	85	1975	175749	175	1977
40655	40	1976	60452	60	1964	85693	85	1976	175840	175	1978
40662	40	1966	60453	60	1964	85699	85	1976	175849	175	1978
40663	40	1966	60532	60	1965	85790	85	1977	175940	175	1979
40672	40	1966	60533	60	1965	85793	85	1977	175949	175	1979
40673	40	1966	60552	60	1965	85799	85	1977	200640	200	1976
40702	40	1967	60553	60	1965	85852	85	1968	200649	200	1976
40703	40	1967	60632	60	1966	85853	85	1968	200740	200	1977
40752	40	1967	60633	60	1966	85890	85	1968	200749	200	1977
40753	40	1967	60652	60	1966	85892	85	1968	200840	200	1978
40772	40	1967	60653	60	1966	85893	85	1968	200849	200	1978
40773	40	1967	60732	60	1967	85895	85	1978	200940	200	1979
40802	40	1968	60733	60	1967	85899	85	1978	200949	200	1979
40803	40	1968	60752	60	1967	85990	85	1979	235840	235	1978
40852	40	1968	60753	60	1967	85993	85	1969	235849	235	1978
40853	40	1968	65272	65	1972	85995	85	1979	235940	235	1979
40872	40	1968	65273	65	1972	85999	85	1979	235949	235	1979
40873	40	1968	65372	65	1973	90482	90	1964			
40902	40	1969	65373	65	1973	90483	90	1964			
40903	40	1969	65832	65	1968	90492	90	1964			
40952	40	1969	65833	65	1968	90493	90	1964			
40953	40	1969	65852	65	1968	90582	90	1965			
40972	40	1969	65853	65	1968	90583	90	1965			
40973	40	1969	70442	70	1974	90592	90	1965			
50172	50	1971	70443	70	1974	90593	90	1965			
50173	50	1971	70472	70	1974	100193	100	1971			
50202	50	1972	70473	70	1974	100293	100	1972			
50203	50	1972	70572	70	1975	100683	100	1966			
									Johnson Outboards 1960-1979		
									1R69	1.5	1969
									1R70	1.5	1970
									2R71	2	1971
									2R72	2	1972
									2R73	2	1973
									2R74	2	1974
									2R75	2	1975

Johnson Outboards 1960-1979			Johnson Outboards 1960-1979			Johnson Outboards 1960-1979			Johnson Outboards 1960-1979		
MODEL NO.	HP	YEAR	MODEL NO.	HP	YEAR	MODEL NO.	HP	YEAR	MODEL NO.	HP	YEAR
2R76	2	1976	25E75-25EL75	25	1975	85EL76	85	1976	235TXL79	235	1979
2R77	2	1977	25E76-25EL76	25	1976	85EL77	85	1977	CD-17	5.5	1960
2R78	2	1978	25E77-25EL77	25	1977	85ESL69	85	1969	CD-18	5.5	1961
2R79	2	1979	25E78-25EL78	25	1978	85ESL70	85	1970	CD-19	5.5	1962
4R69-4RL69	4	1969	25E79-25EL79	25	1979	85ESL71	85	1971	CD-20	5.5	1963
4R70-4RL70	4	1970	25R69-25RL69	25	1969	85ESL72	85	1972	CD-21	5.5	1964
4R71-4RL71	4	1971	25R70-25RL70	25	1970	85ESL73	85	1973	CD-22	6	1965
4R72-4RL72	4	1972	25R71-25RL71	25	1971	85ESL74	85	1974	CD-23	6	1966
4R73-4RL73	4	1973	25R72-25RL72	25	1972	85ESL75	85	1975	CD-24	6	1967
4R74-4RL74	4	1974	25R73-25RL73	25	1973	85ETLR76	85	1976	CD-25	6	1968
4R75-4RL75	4	1975	25R74-25RL74	25	1974	85ETLR77	85	1977	FD-14	18	1960
4R76-4RL76	4	1976	25R75-25RL75	25	1975	85ETLR78	85	1978	FD-15	18	1961
4R77-4RL77	4	1977	25R76-25RL76	25	1976	85ML78	85	1978	FD-16	18	1962
4R78-4RL78	4	1978	25R77-25RL77	25	1977	85ML79	85	1979	FD-17	18	1963
4R79-4RL79	4	1979	25R78-25RL78	25	1978	85TL79	85	1979	FD-18	18	1964
4W69	4	1969	25R79-25RL79	25	1979	85TXL79	85	1979	FD-19	18	1965
4W70-4WL70	4	1970	33E69-33EL69	33	1969	85TXLR77	85	1977	FD-20	20	1966
4W71-4WL71	4	1971	33E70-33EL70	33	1970	85TXLR78	85	1978	FD-21	20	1967
4W72	4	1972	33R69-33RL69	33	1969	100ESL71	100	1971	FD-22	20	1968
4W73	4	1973	33R70-33RL70	33	1970	100ESL72	100	1972	JH-19	3	1964
4W74	4	1974	35E76-35EL76	35	1976	100ML79	100	1979	JH-20	3	1965
4W75	4	1975	35E77-35EL77	35	1977	100TLR79	100	1979	JH-21	3	1966
4W76	4	1976	35E78-35EL78	35	1978	100TXLR79	100	1979	JH-22	3	1967
4W77	4	1977	35E79-35EL79	35	1979	115EL76	115	1976	JH-23	3	1968
4W78	4	1978	35R76-35RL76	35	1976	115EL77	115	1977	JHF-21	3	1967
4W79	4	1979	35R77-35RL77	35	1977	115ESL69	115	1969	JHF-22	3	1967
6R69-6RL69	6	1969	35R78-35RL78	35	1978	115ESL70	115	1970	JHF-23	3	1968
6R70-6RL70	6	1970	35R79-35RL79	35	1979	115ESL73	115	1973	JW-16	3	1960
6R71-6RL71	6	1971	40E69-40EL69	40	1969	115ESL74	115	1974	JW-17	3	1961-62
6R72-6RL72	6	1972	40E70-40EL70	40	1970	115ESL75	115	1975	JW-18	3	1963
6R73-6RL73	6	1973	40E71-40EL71	40	1971	115ETL74	115	1974	JW-19	3	1964
6R74-6RL74	6	1974	40E72-40EL72	40	1972	115ETL75	115	1975	JW-20	3	1965
6R75-6RL75	6	1975	40E73-40EL73	40	1973	115ETL76	115	1976	JW-21	3	1966
6R76-6RL76	6	1976	40E74-40EL74	40	1974	115ETL77	115	1977	JW-22	3	1967
6R77-6RL77	6	1977	40E75-40EL75	40	1975	115ETL78	115	1978	JW-23	3	1968
6R78-6RL78	6	1978	40E76-40EL76	40	1976	115ML78	115	1978	JWF-21	3	1967
6R79-6RL79	6	1979	40ES69-40ESL69	40	1969	115ML79	115	1979	JWF-23	3	1968
8RC1-8RLC1	7.5	1981	40ES70-40ESL70	40	1970	115TL79	115	1979	LD-10	5	1965
8RCN-8RLCN	7.5	1982	40R69-40RL69	40	1969	115TXL77	115	1977	LD-11	5	1966
8RCS-8RLCS	7.5	1980	40R70-40RL70	40	1970	115TXL78	115	1978	LD-12	5	1967
8RCT-8RLCT	7.5	1983	40R71-40RL71	40	1971	115TXL79	115	1979	LD-13	5	1968
9R69-9RL69	9.5	1969	40R72-40RL72	40	1972	125ESL71	125	1971	MQ-10	9.5	1964
9R70-9RL70	9.5	1970	40R73-40RL73	40	1973	125ESL72	125	1972	MQ-11	9.5	1965
9R71-9RL71	9.5	1971	40R74-40RL74	40	1974	135EL76	135	1976	MQ-12	9.5	1966
9R72-9RL72	9.5	1972	40R75-40RL75	40	1975	135ESL73	135	1973	MQ-13	9.5	1967
9R73-9RL73	9.5	1973	40R76-40RL76	40	1976	135ESL74	135	1974	MQ-14	9.5	1968
10E74-10EL74	9.9	1974	50ES71-50ESL71	50	1971	135ESL75	135	1975	QD-21	10	1960
10E75-10EL75	9.9	1975	50ES72-50ESL72	50	1972	135ETL74	135	1974	QD-22	10	1961
10E76-10EL76	9.9	1976	50ES73-50ESL73	50	1973	135ETL75	135	1975	QD-23	10	1962
10E77-10EL77	9.9	1977	50ES74-50ESL74	50	1974	135ETL76	135	1976	QD-24	10	1963
10E78-10EL78	9.9	1978	50ES75-50ESL75	50	1975	140ML77	140	1977	RD-22	40	1960
10E79-10EL79	9.9	1979	50R72-50RL72	50	1972	140ML78	140	1978	RD-23	40	1961
10R74-10RL74	9.9	1974	50R73-50RL73	50	1973	140ML79	140	1979	RD-24	40	1962
10R75-10RL75	9.9	1975	50R77-50RL77	50	1977	140TL77	140	1977	RD-25	40	1963
10R76-10RL76	9.9	1976	50R78-50RL78	50	1978	140TL78	140	1978	RD-26	40	1964
10R77-10RL77	9.9	1977	50R79-50RL79	50	1979	140TL79	140	1979	RD-27	40	1965
10R78-10RL78	9.9	1978	55E76-55EL76	55	1976	140TXL77	140	1977	RD-28	40	1966
10R79-10RL79	9.9	1979	55E77-55EL77	55	1977	140TXL78	140	1978	RD-29	40	1967
10SEL78	9.9	1978	55E78-55EL78	55	1978	140TXL79	140	1979	RD-30	40	1968
10SEL79	9.9	1979	55E79-55EL79	55	1979	150TL78	150	1978	RDS-22	40	1960
15E74-15EL74	15	1974	55ES69-55ESL69	55	1969	150TL79	150	1979	RDS-23	40	1961
15E75-15EL75	15	1975	55R79-55RL79	55	1979	150TXL78	150	1978	RDS-24	40	1962
15E76-15EL76	15	1976	60ES70-60ESL70	60	1970	150TXL79	150	1979	RDS-25	40	1963
15E77-15EL77	15	1977	60ES71-60ESL71	60	1971	175TL77	175	1977	RDS-26	40	1964
15E78-15EL78	15	1978	65ES72-65ESL72	65	1972	175TL78	175	1978	RDS-27	40	1965
15E79-15EL79	15	1979	65ES73-65ESL73	65	1973	175TL79	175	1979	RDS-28	40	1966
15R74-15RL74	15	1974	65ESLR72	65	1972	175TXL77	175	1977	RDS-29	40	1967
15R75-15RL75	15	1975	65ESR73-65ESLR73	65	1973	175TXL78	175	1978	RDS-30	40	1968
15R76-15RL76	15	1976	70EL76	70	1976	175TXL79	175	1979	RK-24	40	1962
15R77-15RL77	15	1977	70EL77	70	1977	200TL76	200	1976	RK-25	40	1963
15R78-15RL78	15	1978	70EL78	70	1978	200TL77	200	1977	RK-26	40	1964
15R79-15RL79	15	1979	70EL79	70	1979	200TL78	200	1978	RK-27	40	1965
20R69-20RL69	20	1969	70ES74-70ESL74	70	1974	200TL79	200	1979	RK-28	40	1966
20R70-20RL70	20	1970	70ES75-70ESL75	70	1975	200TXL76	200	1976	RK-29	40	1967
20R71-20RL71	20	1971	70ESLR74	70	1974	200TXL77	200	1977	RK-30	40	1968
20R72-20RL72	20	1972	75ER76-75ELR76	75	1976	200TXL78	200	1978	RX-10	28	1962
20R73-20RL73	20	1973	75ER77-75ELR77	75	1977	200TXL79	200	1979	RX-11	28	1963
25E72-25EL72	25	1972	75ER78-75ELR78	75	1978	235TL78	235	1978	RX-12	28	1964
25E73-25EL73	25	1973	75ER79-75ELR79	75	1979	235TL79	235	1979	RX-13	33	1965
25E74-25EL74	25	1974	75ESR75-75ESLR75	75	1975	235TXL78	235	1978	RX-14	33	1966

Johnson Outboards 1980 & Later			Johnson Outboards 1980 & Later			Johnson Evinrude Commercial			Johnson Evinrude Commercial		
MODEL NO.	HP	YEAR	MODEL NO.	HP	YEAR	MODEL NO.	HP	YEAR	MODEL NO.	HP	YEAR
150TLCU-150TXCU	150	1987	300CXES	300	1990	10RSC-M	10	1983	25RWA-25RWLA	25	1988
150TLES-150TXES	150	1990	300PLCC-300PXCC	300	1988	10RSD-10RSLD	10	1985	25RWCD-25RWLCD	25	1986
150TRLCI-150TRXCI	150	1981	300PLCE-300PXCE	300	1989	10RSE-10RSL	10	1987	25RWCI-25RWLCI	25	1981
150TRLCN-150TRXCN	150	1982	300PLCU-300PXCU	300	1987	10RSG-2-10RSLG-2	10	1981	25RWCN-25RWLCN	25	1982
150TRLCS-150TRXCS	150	1980	300PLES-300PXES	300	1990	10RSJ-10RSLJ	10	1989	25RWCO-25RWLCO	25	1985
150TRLCT-150TRXCT	150	1983	300PTLCD-300PTXCDC	300	1986	10RSL-10RSL	10	1983	25RWCR-25RWLCR	25	1984
175STLAC	175	1988	300TLCO-300TXCO	300	1985	10RSN-10RSLN	10	1990	25RWCT-25RWLCT	25	1983
175STLCC	175	1988	C-275TLCO	275	1985	10RSR-10RSLR	10	1986	25RWCU-25RWLCU	25	1987
175STLCE	175	1990	C-275TXCO	275	1985	10RSU-10RSLU	10	1988	25RWES-25RWLES	25	1990
175TLCC-175TXCC	175	1988	C-300TLCO	300	1985	10RSW-10RSLW	10	1982	25RWK-25RWLK	25	1989
175TLCD-175TXCD	175	1986	C-300TXCO	300	1985	10RSY-10RSLY	10	1983	35RSP-35RSLP	35	1981
175TLCE-175TXCE	175	1989	C-E275PTLCD	275	1986	10RSYD	10	1985	40R78B-40R78B	40	1978
175TLCO-175TXCO	175	1985	C-E275PTXCD	275	1986	10RSYR	10	1986	40R79E-40R79E	40	1979
175TLCU-175TXCU	175	1987	C-E300PTLCD	300	1986	10RSYZ	10	1984	40RCA-40RCLA	40	1989
175TLES-175TXES	175	1990	C-E300PTXCD	300	1986	10RSZ-10RSLZ	10	1984	40RCB-40RCLB	40	1986
175TRLCI-175TRXCI	175	1981	CO-CC	1.2	1988	11KCA-11KCLA	11	1983	40RCH-40RCLH	40	1985
175TRLCN-175TRXCN	175	1982	CO-CD	1.2	1986	11KCG-11KCLG	11	1985	40RCK-40RCLK	40	1990
175TRLCS-175TRXCS	175	1980	CO-CE	1.2	1990	11KCS-11KCLS	11	1984	40RCP-40RCLP	40	1984
175TRLCT-175TRXCT	175	1983	CO-CU	1.2	1987	11KCW-11KCLW	11	1986	40RCT-40RCLT	40	1987
185ESXES	185	1990	CO-ES	1.2	1990	11KSLW-11KSYW	11	1986	40RCV-40RCLV	40	1983
185ESXW	185	1989	JR-CC	1.2	1988	12K79S	12	1979	40RCY-40RCLY	40	1988
185TLCO-185TXCO	185	1985	JR-CD	1.2	1986	12KCCSC	12	1980	40RCYA	40	1989
185TLCR-185TXCR	185	1984	JR-CE	1.2	1989	12KCLCSC	12	1980	40RCYB	40	1986
200CXCE	200	1989	JR-CU	1.2	1987	12KCXCSC	12	1980	40RCYH	40	1985
200CXES	200	1990	JR-ES	1.2	1990	12KXL79S	12	1979	40RCYK	40	1990
200SLES	200	1990	KT-11C	15A	1987	12L79S	12	1979	40RCYP	40	1984
200STLAC	200	1988	KT-12R	15A	1988	12R78S	12	1978	40RCYT	40	1987
200STLCC	200	1988	KT-13A	15A	1989	12RL78S	12	1978	40RCYV	40	1983
200STLCD	200	1986	KT-14M	15A	1990	12RL79C-R	12	1979	40RCYY	40	1988
200STLCE	200	1989	RTE-11C	45SS	1987	12RSCSA	12	1980	40RSCSD	40	1980
200STLCU	200	1987	RTE-12R	45SS	1988	12RSLCSA	12	1980	40RSD-R	40	1981
200STLES	200	1990	RTE-13A	45SS	1989	12RSXCSA	12	1980	40RSLCSD	40	1980
200TLCT-200TRXCT	200	1983	RTE-14M	45SS	1990	12RXL78S	12	1978	40RSLD-R	40	1981
200TRLCI-200TRXCI	200	1981	STE-13A	SST-60	1989	12RXL79R	12	1979	40RSR-40RSLR	40	1982
200TRLCN-200TRXCN	200	1982	STE-14M	SST-60	1990	14RSB-14RSLB	14	1990	40RWCD-40RWLCD	40	1986
200TRLCS-200TRXCS	200	1980				14RSE-14RSL	14	1982	40RWCI-40RWLCI	40	1981
200TXCC	200	1988				14RSF-14RSLF	14	1985	40RWCN-40RWLCN	40	1982
200TXCD	200	1986				14RSH-14RSLH	14	1989	40RWCO-40RWLCO	40	1985
200TXCE	200	1989				14RSLR-2	14	1981	40RWCR-40RWLCR	40	1984
200TXCU	200	1987				14RSLU-J	14	1983	40RWCT-40RWLCT	40	1983
200TXES	200	1990				14RSN-14RSLN	14	1984	45RCCD-45RCLCD	45	1986
225CLCU-225CXCU	225	1987				14RSP-14RSLP	14	1988	45RCCU-45RCLCU	45	1987
225CXCC	225	1988	4RST-4RSLT	4	1981	14RSQ-14RSLQ	14	1986	45RCE-45RCL	45	1989
225CXCE	225	1989	4RSY-4RSLY	4	1982	14RSR-2	14	1981	45RCR-45RCLR	45	1988
225CXES	225	1990	6K79S-6KL79S	6	1979	14RSU-J	14	1983	45RSD-45RSLD	45	1986
225PLAE	225	1989	6KCB-6KCLB	6	1983	14RSV-14RSLV	14	1987	45RSE-45RSL	45	1988
225PLAS	225	1990	6KCCSC	6	1980	14RSYF	14	1985	45RSJ-45RSLJ	45	1990
225PLCC-225PXCC	225	1988	6KCH-6KCLH	6	1981	14RSYQ	14	1984	45RSR-45RSLR	45	1987
225PLCU-225PXCU	225	1987	6KCLCSC	6	1980	14RSYR	14	1986	45RSU-45RSLU	45	1989
225PLES-225PXES	225	1990	6KCT-6KCLT	6	1984	14RSYD	14	1983	45RSYD	45	1986
225PLES-225SPXES	225	1990	6KCLCSC	6	1980	15RSH-B	15	1983	45RSYK	45	1988
225PTLCD-225PTXCD	225	1986	6RS78B-6RSL78B	6	1978	15RSLH-B	15	1983	45RSYR	45	1987
225SCXES	225	1990	6RS79E-6RSL79E	6	1979	23R79C-R	12	1979	45RSYU	45	1989
225SLES	225	1990	6RSCSD-6RSLCSD	6	1980	25KCG-25KCLG	25	1986	45RSYZ	45	1985
225STLES	225	1990	6RSM-6RSLM	6	1981	25KCS-25KCLS	25	1985	45RSZ-45RSLZ	45	1985
225STLAE	225	1989	6RSZ-6RSLZ	6	1983	25KCW-25KCLW	25	1987	45RWD-45RWLD	45	1986
225STLAS	225	1990	7RSA-7RSLA	6.5	1989	25RPB-25RPLB	25	1984	45RWLE-45RWLYE	45	1988
225STLCC-225TXCC	225	1988	7RSB-7RSLB	7	1986	25RPD	25	1989	45RWLJ-45RWYJ	45	1990
225STLCD-225TXCD	225	1986	7RSF-7RSLF	6.5	1981	25RPH-25RPLH	25	1982	45RWLR-45RWYR	45	1987
225STLCE-225TXCE	225	1989	7RSH-7RSLH	6.5	1985	25RPR	25	1990	45RWLU-45RWYU	45	1989
225STLCU-225TXCU	225	1987	7RSL-7RSL	7	1987	25RST-25RSL	25	1983	45RWYD	45	1986
225STLES-225TXES	225	1990	7RSP-7RSLP	6.5	1984	25RS78C-25RSL78C	25	1978	45RWZ-45RWLZ	45	1985
235STLCO	235	1985	7RSQ-7RSLQ	6.5	1982	25RS79R-25RSL79R	25	1979	45WMLE	45	1989
235STLCR	235	1984	7RST-7RSLT	7	1987	25RSA-25RSLA	25	1981	45WMLES	45	1990
235STLCT	235	1983	7RSV-7RSLV	6.5	1983	25RSC-25RSLC	25	1986	50RS78C-G	50	1978
235TLCO-235TXCO	235	1985	7RSY-7RSLY	7	1988	25RSCSA-25RSLCSA	25	1980	50RS79R-50RSL79R	50	1979
235TLCD-235TXCD	235	1986	9K79S	9	1979	25RSG-2-25RSLG-2	25	1984	50RSL78C-G	50	1978
235TLCE-235TXCE	235	1989	9KCCSC	9	1980	25RSK-25RSLK	25	1982	55AWQ-55AWLQ	55	1985
235TLCU-235TXCU	235	1987	9KCLCSC	9	1980	25RSM-25RSLM	25	1987	55RCI-55RLCI	55	1981
235TRLCI-235TRXCI	235	1981	9KXCSC	9	1980	25RSP-25RSLP	25	1990	55RCN-55RCLN	55	1982
235TRLCN-235TRXCN	235	1982	9KL79S	9	1979	25RSS-25RSL	25	1983	55RCT-55RCLT	55	1983
235TRLCS-235TRXCS	235	1980	9KXL79S	9	1979	25RSW-25RSLW	25	1985	55RCS	55	1980
235TRLCT-235TRXCT	235	1983	9R78S	9	1978	25RSY	25	1986	55RCSB-55RSLB	55	1989
275CLCU-275CXCU	275	1987	9R79C-R	9	1979	25RSYD	25	1989	55RCS-55RSLCS	55	1980
275CXCC	275	1988	9RL78S	9	1978	25RSYG-2	25	1984	55RSF-55RSLF	55	1984
275PLCC-275PXCC	275	1988	9RL79C-R	9	1979	25RSY	25	1987	55RSH-55RSLH	55	1988
275PLCU-275PXCU	275	1987	9RSCSA	9	1980	25RSYS	25	1983	55RSJ-55RSLJ	55	1982
275PTLCD-275PTXCD	275	1986	9RSLCSA	9	1980	25RSY	25	1988	55RSN-55RSLN	55	1983
275TLCO-275TXCO	275	1985	9RSXCSA	9	1980	25RSYD	25	1989	55RSP-55RSLP	55	1987
300CLCUR-300CXCU	300	1987	9RXL78S	9	1978	25RSY-2	25	1984			
300CXCC	300	1988	9RXL79R	9	1979	25RSY	25	1987			
300CXCE	300	1989	10KCC-10KCLC	10	1987	25RSYS	25	1983			
			10KCLD	10	1990	25RSY	25	1988			
			10KSLC	10	1987	25RSZ-25RSLZ	25	1988			

Mercury Outboard				Mercury Outboard				Mercury Outboard				Mercury Outboard			
HP	CYL	BEG.S/N	YEAR	HP	CYL	BEG.S/N	YEAR	HP	CYL	BEG.S/N	YEAR	HP	CYL	BEG.S/N	YEAR
7.5	2	4087015	1975	25	2	6593849	1985	65	4	2119749	1967	115	6	4112635	1975
7.5	2	4314385	1976	25	2	A911346	1986	65	4	2309311	1968	115	6	4310785	1976
7.5	2	4691222	1977	25	2	B114231	1987	65	4	2503991	1969	115	6	4567952	1977
7.5	2	4851693	1978	25	2	B238464	1988	65	4	2803562	1970	115	6	4855153	1978
7.5	2	5226935	1979	25	2	B385500	1989	65	4	2997339	1971	115	6	5168574	1979
7.5	2	5524660	1980-81	25	2	C221500	1990	65	3	3293184	1972	115	6	5600967	1980-81
7.5	2	5936301	1982	35	4	1570507	1963	65	3	3547987	1973	115	6	6006834	1982
7.5	2	6239857	1983	35	2	1628795	1964	65	3	3807833	1974	115	6	6262961	1983
7.5	2	6430041	1984	35	2	1755799	1965	65	3	4136685	1975	115	6	6440183	1984
7.5	2	6611886	1985	35	2	1960827	1966	65	3	4382057	1976	115	6	6630171	1985
8	2	A197112	1986	35	2	2097800	1967	70	3	1296411	1960	115	6	A907777	1986
8	2	B114231	1987	35	2	2300972	1968	70	3	1413611	1961	115	6	B117567	1987
8	2	B233200	1988	35	2	2487558	1969	70	3	1503459	1962	115	6	B239242	1988
8	2	B385500	1989	35	2	6445653	1984	70	3	4382057	1976	115	4	C100000	1989
8	2	C221500	1990	35	2	6626696	1985	70	3	4571652	1977	115	4	C221500	1990
9.8	2	5206550	1979	35	2	A922171	1986	70	3	4825249	1978	125	6	2314956	1968
9.8	2	5541280	1980-81	35	2	B110789	1987	70	3	5128280	1979	125	6	2536210	1969
9.8	2	5965263	1982	35	2	B238644	1988	70	3	5579017	1980-81	135	6	2839369	1970
9.8	2	6263906	1983	35	2	B393190	1989	70	3	5974683	1982	135	6	3036066	1971
9.8	2	6438338	1984	35 (300)	4	1271885	1960	70	3	6279960	1983	V-135	6	A909997	1986
9.8	2	6620196	1985	40	2	2874704	1970	70	3	B110054	1987	V-135	6	B116662	1987
9.8 (100)	2	1397581	1961	40	2	3043031	1971	70	3	B240451	1988	V-135	6	B241881	1988
9.8 (110)	2	1455240	1962	40	2	3219678	1972	70	3	C100000	1989	V-135	6	C100861	1989
9.8 (110)	2	1474328	1963	40	2	3474578	1973	75	4	6432901	1984	V-135	6	C221500	1990
9.8 (110)	2	1607083	1964	40	2	3859435	1974	75	4	6613221	1985	140	6	3293234	1972
9.8 (110)	2	1742746	1965	40	2	4118385	1975	75	4	A197882	1986	140	6	4865678	1978
9.8 (110)	2	1865779	1966	40	2	4362215	1976	75	3	C100000	1989	140	6	5189788	1979
9.8 (110)	2	2098352	1967	40	2	4564002	1977	75	3	C221500	1990	140	6	5625108	1980-81
9.8 (110)	2	2290663	1968	40	2	4860103	1978	80	4	1335465	1960	150	6	3502806	1973
9.8 (110)	2	2508759	1969	40	2	5174089	1979	80	4	1398630	1961	150	6	3752620	1974
9.8 (110)	2	2798057	1970	40	2	5556230	1980-81	80	4	2559001	1969	150	6	4125985	1975
9.8 (110)	2	3002814	1971	40	2	5991215	1982	80	4	2783253	1970	150XS	6	4319880	1976
9.8 (110)	2	3263263	1972	40	2	6228285	1983	80	4	2986444	1971	150XS	6	4602012	1977
9.8 (110)	2	3482753	1973	40	4	C159200	1989	80	4	3186263	1972	150XS	6	4868648	1978
9.8 (110)	2	3795658	1974	40	4	C221500	1990	80	4	4831999	1978	V-150	6	4868998	1978
9.8 (110)	2	4079675	1975	40 350	2	1356948	1961	80	4	5141097	1979	V-150	6	5129480	1979
9.8 (110)	2	4304785	1976	45	4	1476510	1962	80	4	5582562	1980-81	V-150	6	5503247	1980-81
9.8 (110)	2	4605112	1977	45	4	A914859	1986	80	4	5987161	1982	V-150	6	5944791	1982
9.8 (110)	2	4839254	1978	45	4	B110789	1987	80	4	6232941	1983	V-150	6	6220254	1983
9.9	2	A918999	1986	45	4	B238644	1988	80	3	A966142	1987	V-150	6	6443213	1984
9.9	2	B114231	1987	45	4	B393190	1989	80	3	B240451	1988	V-150	6	6616991	1985
9.9	2	B233200	1988	45 (400)	4	1279685	1960	80	3	C100000	1989	V-150	6	A904646	1986
9.9	2	B385500	1989	45 (400)	4	1384806	1961	85	6	1460999	1963	V-150	6	B116662	1987
9.9	2	C221500	1990	50	4	1421113	1961	85	6	1648888	1964	V-150	6	B242881	1988
10	2	1290910	1960	50	4	1477910	1962	85	4	3493913	1973	V-150	6	C100861	1989
15	2	1288910	1960	50	4	1552535	1963	85	4	3865695	1974	V-150	6	C221500	1990
15	2	1346448	1961	50	4	1605952	1964	85	4	4092965	1975	V-150XR2	6	A905191	1986
15	2	B293117	1988	50	4	1755549	1965	85	4	4590512	1977	V-150XR2	6	B289430	1988
15	2	B385500	1989	50	4	1870389	1966	85XS	4	4366802	1976	V-150XR4	6	B242885	1988
15	2	C221500	1990	50	4	2097445	1967	90	6	1755444	1965	V-175	6	4301235	1976
18	2	5860332	1980-81	50	4	2305101	1968	90	6	4854301	1978	V-175	6	4563802	1977
18	2	5954911	1982	50	4	2514919	1969	90	6	5160324	1979	V-175	6	4838074	1978
18	2	6171607	1983	50	4	2736807	1970	90	6	5594657	1980-81	V-175	6	5180109	1979
18	2	6443973	1984	50	4	3009934	1971	90	6	5996390	1982	V-175	6	5488752	1980-81
18	2	6617631	1985	50	4	3235063	1972	90	6	6246856	1983	V-175	6	6618751	1985
20	2	1558310	1963	50	4	3478003	1973	90	6	6436123	1984	V-175	6	A918329	1986
20	2	1606903	1964	50	4	3816308	1974	90	6	6623151	1985	V-175	6	B116662	1987
20	2	1755849	1965	50	4	4141450	1975	90	6	A902436	1986	V-175	6	B241881	1988
20	2	1866496	1966	50	4	4357650	1976	90	3	B110054	1987	V-175	6	C100861	1989
20	2	1997990	1967	50	4	4576237	1977	90	3	B240451	1988	V-175	6	C221500	1990
20	2	2296267	1968	50	4	4962056	1978	90	3	C100000	1989	V-200	6	4839034	1978
20	2	2550065	1969	50	4	5193259	1979	90	3	C221500	1990	V-200	6	5158929	1979
20	2	2827677	1970	50	4	5531630	1980-81	90cc	2	A907702	1986	V-200	6	5464486	1980-81
20	2	2991679	1971	50	4	5949386	1982	90cc	2	B114221	1987	V-200	6	6073192	1982
20	2	3226958	1972	50	4	6275323	1983	95	6	1869776	1966	V-200	6	6203991	1983
20	2	3537531	1973	50	4	6448808	1984	95	6	2097280	1967	V-200	6	6435503	1984
20	2	3755885	1974	50	4	6586624	1985	100	6	1503332	1962	V-200	6	6625221	1985
20	2	4103290	1975	50	3	A912478	1986	100	6	1518384	1963	V-200	6	A913228	1986
20	2	4293920	1976	50	3	B110789	1987	100	6	1665002	1964	V-200	6	B116662	1987
20	2	4580036	1977	50	3	B239242	1988	100	6	1755459	1965	V-200	6	B241881	1988
20	2	4819249	1978	50	3	B396036	1989	100	6	2318586	1968	V-200	6	C100861	1989
20	2	5183393	1979	50	3	C221500	1990	100	6	2484633	1969	V-200	6	C221500	1990
20	2	5606492	1980-81	60	3	1303411	1960	100	4	B209468	1988	210cc	2	A918999	1986
20	2	A910971	1986	60	3	6428681	1984	100	4	C100000	1989	210cc	2	B114231	1987
20	2	B114231	1987	60	3	6609651	1985	100	4	C221500	1990	210cc	2	B233405	1988
20	2	B238464	1988	60	3	A197392	1986	102cc	2	A819211	1988	210cc	2	B385500	1989
20	2	B385500	1989	60	3	B110789	1987	102cc	2	A837101	1989	V-220	6	B241881	1988
20	2	C221500	1990	60	3	B239242	1988	110	6	1870204	1966	V-225	6	5615282	1980-81
22 (200)	2	1292910	1960	60	3	B396036	1989	110	6	2097385	1967	V-250	6	C139860	1989
22 (200)	2	1339948	1961	60	3	C221500	1990	115	6	2836019	1970	V-250	6	C221500	1990
25	2	1467499	1962	65	4	1542745	1963	115	6	3023086	1971	V-275	6	C139860	1989
25	2	5705532	1980-81	65	4	1606282	1964	115	6	3270480	1972	V-275	6	C221500	1990
25	2	5942041	1982	65	4	1765044	1965	115	6	3525441	1973	V-300	6	5611648	1980-81
25	2	6185159	1983	65	4	1869564	1966	115	6	3761035	1974	V-300	6	6239853	1983
25	2	6453343	1984												

Mercruiser Inboard/Outdrive			
Sea Ray			
MODEL NO.	MERC. NO.	S/N	YEAR
3.0L	3.0L	B787205-B917529	88
4.3L2	4.3L	B785483-B921276	88
4.3L4	4.3LX	B785981-B922330	88
5.7L	5.7L	B784799-B917017	88
SRX7.4L	350 Mag	B785241-B919012	88
SRX7.4L	454 Mag		
	Alpha	B785149-B924857	88
SRX7.4L-H	454 Mag		
	Bravo	B721206-B919343	88

Stern Drives

3.0L-SRX7.4L	Alpha	B803866-C348032	88
SRX7.4L-H	Bravo	B803872-B999972	88

Inboard Engines

5.7L	5.7L	B788204-B919356	88
7.4L	7.4L	B788179-B913769	88

Renault 4 Cylinder (Stern Drive)

MODEL	S/N	YEAR
60	1887079-2049044	65-68
80	2049045-2851423	66-69
90	2851424-3226957	70-72

GM 4 Cylinder (Stern Drive)

MODEL	S/N	YEAR
110	1537370-2044033	63-66
120	1666601-3377340	64-72
120	3377341-3770649	72-73
120	3770650-4952700	74-77
120	4952701-5192048	78
120	5192049-6229717	79-82
120	6229718-6853913	83-84
120	6853914-B531853	85-86
120/2.5L	B531854-C853255	87-89
140	2508261-6229717	68-82
140/3.0L	6229718-C856558	82-89
3.0L/LX	C856559-UP	90-

Mercury Marine 4 Cylinder (Stern Drive)

MODEL	S/N	YEAR
470 (2bbl.)	4208730-5520114	76-79
470 (2bbl.)	5520115-6218036	80-82
470 (2bbl.)	6218037-6916778	83-84
170 (2bbl.)	6916779-UP	85-86
165/3.7L (2bbl.)	6916779-UP	87-89
485 (2bbl.)	5685394-6218036	80-82
488 (4bbl.)	6170297-6916778	83-84
190 (4bbl.)	6916779-UP	85-86
180/3.7LX (4bbl.)	6916779-UP	87-89

Mercruiser Inboard/Outdrive
GM Inline 6 Cylinder (Stern Drive)

MODEL	S/N	YEAR
140	1538930-1725960	63
150	1666495-2048046	64-66
160	2048022-2770031	67-69
165	2770032-5178958	70-78
165	5178959-5813433	79-81
200	2453769-2712072	69

GM V6 (Stern Drive)

MODEL	S/N	YEAR
185 (4bbl.)	6330183-6919655	83-84
185 (2bbl.)	A331455-B527954	85-87
175/4.3L (2bbl.)	B527955-D714106	87-92
4.3L (GEN II)(2bbl.)	D714107-F000877	92-93
4.3L (GEN II)(2bbl.)	F000878-F601126	93-95
4.3L (GEN II)(2bbl.)	F601127-F000878	96
4.3LX (GEN+)(2bbl.)	F803000-K999999	96-97
4.3L (GEN+)(2bbl.)	L010044-UP	98-
4.3L EFI (GEN+)(TBI)	L012009-UP	98-
205 (4bbl.)	A331455-B527954	85-87
205/4.3LX (4bbl.)	B527955-D714369	87-91
4.3LX (GEN II)(4bbl.)	D714370-F001219	92-93
4.3LX (GEN II)(4bbl.)	F001220-F601126	93-95
4.3LX (GEN II)(4bbl.)	F601127-F802999	96
4.3LXH (GEN+)(4bbl.)	F803114-UP	96-97
4.3LH(GEN+)(4bbl.)	L010044-UP	98
262 Mag. (TBI)(GEN+)	F803800-K999999	96-97

Ford V8 (Stern Drive)

MODEL	S/N	YEAR
888 (2bbl.)	3108723-4887829	71-77
215 (4bbl.)	2781153-3385720	70-72
225 (4bbl.)	3385721-4166999	73-74
225-S (4bbl.)	3385721-4166999	73-74
233	4173000-4902304	75-77
255	3258728-4175499	71-74

Mercruiser Inboard/Outdrive
GM V8 283, 327, 305 & 350 CID (Stern Drive)

MODEL	S/N	YEAR
190	1564539-1730903	63-64
898 (2bbl.)	4762210-6218461	77-82
898 (2bbl.)	6218462-B525981	83-84
200/5.0L (2bbl.)	6218462-F600999	85-95
5.0L (2bbl.)	L015751-UP	98-
5.0L EFI	L012052-L340000	98-99
228 (4bbl.)	4765100-5170008	77-78
228 (4bbl.)	5170009-6218461	79-82
228 (4bbl.)	6218462-B525981	82-84
230 (4bbl.)	6218462-B525981	85-86
230/5.0LX (4bbl.)	B525982-F600999	87-95
225	1539620-2694014	63-69
250	2314301-2639854	68-69
255	4175500-4767999	75-76
250	4768000-4908849	77
260/5.7L	4908850-6218461	78-82
260/5.7L	621462-B525981	82-86
260/5.7L	B525982-F600999	87-95
5.7L (2bbl.)	F601000-UP	96-98
5.7L EFI	F225560-UP	95-
5.7LX (4bbl.)	F601000-K999999	96-97
5.7LX EFI	F752400-K999999	96-97
5.7LX Bravo EFI	F800300-K999999	96-97
350 Mag. Alpha	A635178-B525981	86-87
350 Mag. Alpha	B525982-F600999	87-95
350 Mag. Alpha	F601000-K001526	96
350 Mag. Alpha	K001527-K999999	97
350 Mag. Alpha EFI	F800300-K999999	96-97
350 Mag. Bravo MPI	F415189-K999999	95-97
350 Mag. MPI (GEN +)	F602000-K999999	96-97
350 Mag. MPI (GEN+)	L010019-UP	98-
270	2851074-3385720	69-72
280TRS	4176250-4770199	75-76
300 Tempest	6668677-B430367	85-86
320 (EFI)	A543604-C622418	87-89

Mercruiser Inboard/Outdrive			Mercruiser Inboard/Outdrive				Mercruiser Inboard/Outdrive		
GM V8 427, 454, 502, 540 & 572 (Stern Drive)			MCM 4, 5, 6 & V8 Cylinder Diesel Stern Drive Engines				GM MIE V8 427, 454, 482 & 502 CID (Inboard)		
MODEL	S/N	YEAR	MODEL	HP	S/N	YEAR	MODEL	S/N	YEAR
325	2278747-3780449	69-72	Rover	60	31400000F-UP	65-67	325	2278747-3780449	68-74
330	4623115-6083144	77-81	530 D-TA	150	B993000-B993492	89	330	4623115-5889913	77-80
330	6083145-B816450	82-87	636 D-TA	180	B993500-C696047	89	340/7.4L		
7.4L Bravo	B771113-D603117	88-91	D183	140	B993493-D725149	90-93	w/B/W MK4	5889914-UP	81-92
7.4L Bravo (Gen.V)	D603118-F800699	92-96	D219	170	C696048-D850124	90-93	7.4L w/Hurth (LH) MK4	C391564-D715493	89-92
7.4L Bravo (Gen. VI)	F800700-K999999	96-97	D254	200	C849484-D554729	90-93	7.4L (LH)	D715494-K999999	92-97
7.4LX Bravo (MPI)(Gen.V)	F602010-F801999	96	D3.0L	140	D725150-UP	94-	7.4L MPI (LH)	F563052-K999999	95-97
7.4LX Bravo (MPI)(Gen.VI)	F802000-K999999	96-97	D3.6L	170	D850125-UP	94-	7.4L MPI (L29) Gen VI	L002006-UP	98
7.4L MPI (Gen. VI)	L010003-UP	98	D4.2L	200	D554730-UP	94-	7.4L TBI (LH) Gen VI	F874815-K999999	96-97
7.4LX Bravo (TBI)(Gen.VI)	F820000-K999999	96-97	D7.3L	238	F060000-UP	94-	454 Mag. MPI Horizon	L002200-L086049	98-99
454 Mag. Alpha	A631894-UP	86-88	Mercury Marine MIE 4 Cylinder (Inboard)				454 Mag. MPI (Gen.V)	F215800-F820099	95-96
454 Mag. Bravo (Gen.V)	D805069-F304999	92-94	MODEL	S/N	YEAR	454 Mag. MPI (SKL)(Gen.VI)	F820100-K999999	96-97	
454 Mag. Bravo (Gen.V)	F305000-F801699	95-96	470	5520115-6218036	80-81	350	9780450-4623109	74-76	
454 Mag. Bravo (Gen.VI)	F801700-K999999	96-97	Ford MIE V8 (Inboard)				390	2781129-2825059	69-70
454 EFI (Gen.V)	F115700-F802349	94-96	MODEL	S/N	YEAR	8.2L w/ Hurth	C878221-D857199	90-92	
454 Mag. MPI (Gen.VI)	F802350-K999999	96-97	215	2781153-3563181	70-72	8.2L (Gen.V)	D857200-F819619	93-96	
454 Mag. MPI (Gen.VI)	L010029-L085399	98	225	3385721-4176999	70-72	8.2L MPI (LH) Gen VI	F819620-K999999	96-97	
454 Mag. MPI (Gen.VI)	L085400-UP	99-	233	4173000-4775784	75-76	8.2L MPI (LH) Gen VI	L002450-L0086012	98	
370 TRS	4179554-6721527	78-85	255	3258728-4178299	73-74	8.2L MPI (LH) Gen VI	L0086013-UP	99	
370 TRS	6721528-B714586	85-87	GM MIE V8 305,327,350 CID (Inboard)						
400 TRS	4179554-B457644	80-86	MODEL	S/N	YEAR				
420	A398941-D937011	87-89	198	4762210-6218461	77				
425	A398941-D937011	90-93	228	4765100-5170008	77-78				
440 TRS	4179554-B485220	83-86	228	5170009-5907057	79-80				
450 (Gen. V)	F347100-F347277	95-96	230/5.0L (4bbl.)	5907058-B788151	81-87				
525 SC	D456000-F348963	91-92	225	2278647-2694014	68				
525 SC (Gen.V)	D456000-F348963	92-95	250	2314301-2639854	68-69				
525 SC (Gen.V)	F615814-F745215	96	255	4175500-5907057	75-80				
525 SC (Gen.VI)	F745260-UP	96-97	260/5.7L	5907058-F024999	81-93				
390	2781129-3042731	69-70	270	2851074-3077735	69-72				
460 TRS	4719554-6181046	83-86	5.7L	F025000-K999999	94-97				
465	C849992-F213244	90-92	5.7L (Gen+)	L002003-UP	98				
465 (Gen.V)	C849992-F213244	92-94	5.7L MPI	K040300-K999999	97				
500 (Gen.V)	F213293-F745159	94-96	350 Mag. MPI (Gen+)	L002008-L304499	98				
500 (Gen.VI)	F745195-L001772	97-98	350 Mag. MPI (Gen+)	L304500-UP	99				
502 Mag. Bravo	C878221-D824588	90-92	350 Horizon	L304700-UP	99-				
502 Mag. Bravo (Gen.V)	D824589-F114528	92-93	5.7L Ski	A338533-B514626	85-87				
502 EFI (Gen.V)	D840650-F802599	93-96	5.7L Competition Ski	B514627-F775199	87-95				
502 Mag. MPI (Gen.VI)	F802600-K999999	96-97	5.7L Competition Ski	F775200-K040003	96				
500 EFI	L001477-UP	99-	5.7L Competition Ski (Gen+)	L002005-UP	98-				
502 Mag. MPI (Gen.VI)	L085433-UP	98	350 Mag. Ski	D505450-K999999	91-97				
600 SC	D456489-F877642	91-92	350 Mag. EFI Ski	F215561-K999999	94-97				
600 SC (Gen.V)	D456489-F877642	92-96	350 Mag. MPI Ski	F350583-F799999	95-98				
600 SC (Gen.VI)	K000227-UP	97	Black Scorpion Ski	F800000-UP	96-98				
500 Bulldog	C577254-F745405	90-96							
500 Bulldog	K000248-UP	97							
575	A677429-D763716	86-92							
800 SC (Gen.V)	D763836-UP	93-96							

Mercruiser Inboard/Outdrive			
MIE 5, 6 & V8 Cylinder Diesel Inboard Engines			
MODEL	HP	S/N	YEAR
530 D-TA	150	B993002-C539258	89
636 D-TA	180	B993750-C696011	89
D183	150	C539259-D725149	90-93
D219	180	C696012-D850124	90-93
D254	210	C849461-D554729	90-93
D3.0L	150	D725150-UP	94-
D3.6L	180	D850125-UP	94-
D4.2L	210	D554730-UP	94-
D7.3L	262	F060000-UP	94-

MC 60, 80 & 90 Stern Drives & Transom Plates		
MODEL	S/N	YEAR
60 (O)	1830753-2063740	65-66
80	2063741-2898029	66-69
90	2898020-3225967	70-72

MC I, II & III		
MODEL	S/N	YEAR
I	1534570-1684187	63
II (1.33:1)	1474909-2278488	62-67
II (1.78:1)	2398798-2671321	68-69
III	2373127-3002613	68-72
III	5128065-UP	78-

MC 1A, 1B & 1C		
MODEL	S/N	YEAR
1A, 1B & 1C	1684188-1777798	64
1A, 1B & 1C (E-Z Shift)	1776349-2065189	65-66

Mercruiser Inboard/Outdrive		
MC 120, 140, 160 & 165		
MODEL	S/N	YEAR
120/140	2062141-378049	67-73
120/140	3780850-4893634	74-77
120/140	4893635-6225576	78-82
160	2065190-2763441	67-69
165	2763442-3780849	70-73
165	3780849-4890459	74-77
165	4890460-6268064	78-82

MC470 & 485		
MODEL	S/N	YEAR
470	4208730-4893834	76-77
470	4893835-6225576	78-82
485	5487437-6225576	80-82

MC 888, 225S & 233		
MODEL	S/N	YEAR
888	3106717-3784374	71-73
888	3784375-4782329	74-77
225S	3856268-4200499	74
233	4200500-4782329	75-77

MC 898, 228, 250 & 260		
MODEL	S/N	YEAR
898/228	4782330-4898729	77
898/228	4898730-6229157	78-82
250	4791300-4898729	77
260	4898730-6229157	78-82

MC R, MR, Alpha One, Alpha One SS & Alpha One Gen II		
MODEL	S/N	YEAR
R	6152230-6847029	83-84
MR	6810538-A479506	85
Alpha One	A470165-UP	86-90
Alpha One SS	A545004-UP	86-89
Alpha One Gen II	D469859-UP	91-

Mercruiser Inboard/Outdrive		
MC Bravo & Blackhawk		
MODEL	S/N	YEAR
Bravo One	B664190-UP	88-
Bravo Two	C564952-UP	89-
Bravo Three	D763691-UP	93-
Blackhawk	F186717-UP	94-

MC 215E & 215H		
MODEL	S/N	YEAR
215H	2782203-2909034	70
215E	2782203-2909034	70-72

MCTR & TRS		
MODEL	S/N	YEAR
TR	3377316-3787239	73
TR	3787240-4794899	74-76
TR	4794900-5009866	77
TR	5009867-UP	78-
TRS	3787240-4203749	74-75
TRS	4203750-4795399	76
TRS	4795400-UP	77-

MC II, III, IV & V SSM		
MODEL	S/N	YEAR
II SSM	Z2021100C-Z2021313C	82-84
	A544504Z-C576702Z	85-90
III SSM	Z38022378C-X38092085C	78-84
	A568120-UP	86-
IV SSM	A568120-UP	86-
V SSM	C576812-UP	89-
VI SSM	D456231-UP	91-

ARCO		ARCO (Cont.)		ARCO (Cont.)		BARR (Cont.)	
ARCO No.	Sierra No.	ARCO No.	Sierra No.	ARCO No.	Sierra No.	BARR No.	Sierra No.
3410	18-6418	6266	18-6789	R040	18-6266	20-0100	18-1939
3412	18-6432	6267	18-6259	R177	18-6268	CC47 1650 05944	18-0470
3420	18-6410	6270	18-6765	R211	18-5729	CC-1-07686	18-1914
3421	18-6420	6275	18-6769-1	R473	18-5705	CC47-1650-06022	18-0473
3422	18-6411	6276	18-6777	R670	18-6271	CHV-1-83	18-1997-1
3423	18-6421	6277	18-6757	R832	18-5704	CHV470000	18-2902
3424	18-6412	6278	18-6273-1	SR102	18-6250	CHVA470000	18-0418
3425	18-6422	7325	18-5618	SR104	18-6251	CM-1-5972-A	18-1915
3426	18-6413	7326	18-6282	SR410	18-56001	CM-1-5972B	18-1911
3427	18-6423	10112	18-5906	SR412	18-56003	CM-1-5972P	18-0474
3428	18-6415	10113	18-6292	SR420	18-56003	CM-1-6677A	18-1940
3429	18-6424	20102	18-5950	SR422	18-56003	CM-1-6672-B	18-1941
3430	18-6425	20104	18-5951	SR423	18-56003	CM-1-6672-J	18-0472
3431	18-6426	20800	18-6293	SR424	18-56004	CM-20-2847405	18-1913
3432	18-6427	20800	18-6298	SR425	18-56003	CM-20-4142411	18-1944
3440	18-6414	20810	18-5983	SR426	18-56005	CM-20-6672	18-1946
3442	18-6417	20820	18-5984	SR427	18-56004	CM206672JP	18-4360
3444	18-6416	20820	18-6450	SR428	18-56006	CM-20-6674	18-1945
5360	18-6435	20825	18-6288	SR429	18-56007	CM-20-6674P	18-4361
5362	18-6436	20830	18-6299	SR440	18-56008	CM206674P	18-4361
5364	18-6437	20840	18-6454	SR442	18-56008	CM-20-9234	18-1948
5365	18-6438	20850	18-6455	SR444	18-56009	CM-20-9234 P	18-8501
5366	18-5601	30119	18-5900	SW054	18-5816	CM-20-6674JP	18-8506
5367	18-5611	30121	18-5901	SW058	18-5817	CR 20 97169	18-1916
5368	18-5623	30122	18-5902	SW064	18-5818	CR 20 97386	18-1918
5369	18-5617	30140	18-5905	SW079	18-5840	CR 20 97387	18-1919
5369	18-6434	30450	18-5910	SW081	18-5807	CR 20 97624	18-1924
5370	18-5635	30456	18-5907	SW090	18-5805	CR 20 97772	18-1927
5371	18-5630	30457	18-5908	SW091	18-5806	CR 20 98068	18-1934
5372	18-5634	30459	18-5603	SW092	18-5809	CR-1-97752	18-1925
5373	18-5600	30460	18-5911	SW097	18-5819	CR-1-97992	18-1929
5374	18-5602	30462	18-6443	SW099	18-5820	CR-1-97993	18-1933
5375	18-5604	30470	18-6275	SW109	18-5834	CR-1-97753	18-1926
5376	18-5629	40112	18-5954	SW125	18-6291	CR-20-97296	18-1917
5377	18-5636	40152	18-5964	SW268	18-5812	CR2097924	18-1928
5379	18-5605	50143	18-6272	SW268	18-5812	FM183	18-1998-1
5380	18-5608	60050	18-5957	SW268	18-5812	MC-1-65603	18-1962-1
5381	18-6283	60055	18-5967	SW275	18-5815	MC-1-65604	18-1958-1
5382	18-6439	60060	18-5960	SW288	18-5814	MC-1-77234	18-1950-1
5386	18-5628	60065	18-5965	SW295	18-5835	MC-1-77235	18-1951-1
5387	18-5619	60070	18-6261	SW394	18-5801	MC-1-87114	18-1953-2
5388	18-5606	60071	18-6265	SW412	18-5842	MC-1-89011	18-1957-1
5389	18-5624	60072	18-5979	SW424	18-5843	MC-1-99746	18-1952-1
5390	18-5627	60108	18-6263	SW450	18-6287	MC199798	18-1956-1
5391	18-5612	60122	18-6262	SW580	18-5823	MC-20-12076	18-1975-1
5392	18-5610	60125	18-6260	SW580	18-5823D	MC-20-44354	18-1976-1
5393	18-5613	70100	18-5903	SW590	18-5833	MC-20-55538	18-1973
5393	18-5613	70101	18-5904	SW590	18-5833D	MC2060426P	18-4362
5394	18-5622	70110	18-5914	SW622	18-5808	MC-20-60426	18-1971
5395	18-5620	70111	18-5915	SW661	18-5836	MC-20-61851A2	18-1906
5396	18-5621	70112	18-6276	SW774	18-5803	MC-20-76325	18-1972
5397	18-5614	70114	18-5916	SW917	18-5841	MC-20-76771	18-1978
5398	18-5631	70116	18-5917	SW926	18-5822	MC-20-90880	18-1905
5399	18-5632	70125	18-5920	SW926	18-5822D	MC-20-93320A3	18-1908
5400	18-6440	80108	18-5939	SW945	18-5821	MC-20-98502	18-1974-1
5551	18-6441	84135	18-6284	SW975	18-5838	MC-20-98504	18-1970-2
6204	18-6755	84150	18-6278	SW981	18-5802	MC-20-60207	18-4008
6206	18-6761	5381X	18-5609	SW984	18-5837	MC2947441	18-1977-1
6208	18-6767-1	AR103	18-5708	TAK217	18-6253	MC47-27-33395	18-0872
6209	18-6754	AR104	18-5709	TR208	18-6252	MC47-27-33395A2	18-4394
6211	18-6764	AR351	18-5707	TR217	18-6254	MC472735898	18-0332
6212	18-6279	BK900	18-5697	VR404	18-5711	MC47273589A4	18-4395
6214	18-6257	DV366	18-5650	VR405	18-5710	MC472739915	18-2819
6216	18-6762	DV373	18-5674	VR406	18-5727	MC472739917	18-1209
6217	18-6763	DV374	18-5656	VR407	18-5712	MC472739923	18-1210
6218	18-6772	DV376	18-5655	VR785	18-5740	MC-47-27-41811	18-0672
6220	18-6759	DV381	18-5658			MC47-27-41813	18-0897
6223	18-6758	DV389	18-5678			MC47-27-46401	18-2830
6224	18-6274	DV390	18-5671			MC47-27-46401A1	18-4396
6227	18-6770	DV393	18-5673			MC47-27-46820	18-0418
6228	18-6756	DV394	18-5677			MC472746820A1	18-4397
6238	18-6281	DVK68	18-5679			MC472747590	18-2831
6239	18-6258	M525	18-6771			MC472747644	18-0342
6241	18-6780	PWB 1000	18-6442			MC472748042	18-0885
6242	18-6280	PWK440	18-6294			MC47-27-48043	18-2832
6243	18-6285	PWK650	18-6295			MC472748818	18-2844
6244	18-6277	PWP650	18-6296			MC472752546	18-2896
6245	18-6779	PWY500	18-6289			MC47-27-53354	18-2912
6250	18-6773	PWY650	18-6290			MC47-27-53354A1	18-4398
6255	18-6286	R036	18-6264			MC472754014	18-2847
				BARR			
				BARR No.	Sierra No.		
				10107	18-2854		
				147638	18-1995		
				160252	18-4009		
				200082	18-1999		
				1-73813	18-1990		
				1-54870	18-1912		
				200087P	18-1992-1		
				200089P	18-1991		
				20-0097	18-1949		

FRAM (Cont.)		GLM (Cont.)		GLM (Cont.)		GLM (Cont.)	
FRAM No.	Sierra No.	GLM No.	Sierra No.	GLM No.	Sierra No.	GLM No.	Sierra No.
G3870	18-7936	11210	18-2201	12320	18-3420	12821	18-3226
G8174	18-7830	11215	18-2256	12330	18-3421	12822	18-3197
P1115	18-7937	11216	18-2358	12341	18-2354	12824	18-3151
P1116	18-7938	11220	18-2203	12350	18-3416	12825	18-3222
P1146G	18-7829	11225	18-2257	12352	18-3445	12826	18-2722
P1146G	18-7867	11226	18-2364	12360	18-3419	12829	18-3221
P3726	18-7939	11230	18-2204	12370	18-3414	12830	18-3110
P4102A	18-7942	11235	18-2258	12380	18-3422	12836	18-2728
P8043	18-7940	11236	18-2365	12390	18-3119	12840	18-3106
P8263	18-7802	11238	18-6353	12391	18-3145	12860	18-3115
PH13	18-7876	11240	18-2205	12395	18-3405	12880	18-3346
PH13	18-7876	11245	18-2259	12400	18-3129	12881	18-6070
PH16	18-7878	11246	18-2363	12405	18-3206	12883	18-6112
PH25	18-7923	11300	18-2200	12410	18-3116	12884	18-6091
PH2821	18-7886	11312	18-2407	12415	18-3571	12885	18-6090
PH2821A	18-7886	11380	18-2299	12416	18-3572	12886	18-6036
PH2870A	18-7925	11381	18-2298	12420	18-3118	12887	18-6032
PH30	18-7824	11405	18-2191	12430	18-3130	12888	18-6098
PH3306A	18-7926	11406	18-1702	12440	18-3363	12889	18-6033
PH3545	18-7927	11410	18-1158	12450	18-3336	12920	18-2707
PH3593A	18-7910	11416	18-1708	12460	18-3180	12930	18-2715
PH3612	18-7874	11420	18-1157	12470	18-3367	13010	18-3553
PH3614	18-7884	11430	18-1356	12500	18-3122	13020	18-3550
PH3614	18-7915	11500	18-2171	12501	18-3350	13030	18-3551
PH3980	18-7879-1	11510	18-2173	12502	18-3351	13040	18-3555
PH43	18-7878	11520	18-2172	12510	18-3117	13050	18-3552
PH4743	18-7886	11610	18-5967	12520	18-3107	13060	18-3554
PH4967	18-7906	11620	18-2372	12540	18-3139	13070	18-3558
PH4967	18-7916	11800	18-8210	12550	18-3127	13080	18-3557
PH49A	18-7880	11810	18-8211	12560	18-3126	13100	18-3649
PH5046	18-7917	12000	18-3315-2	12590	18-3141	13101	18-3647
PH6017A	18-7902	12010	18-3507	12610	18-3178	13120	18-3549
PH6017A	18-7910	12020	18-3423	12620	18-3343	13124	18-3569
PH6017A	18-7911	12030	18-3424	12630	18-3359	13150	18-3561
PH6607	18-7910	12041	18-3151	12670	18-6011	13170	18-3500
PH6607	18-7911	12042	18-3214	12675	18-6068	13200	18-3556
PH7317	18-7914	12043	18-3154	12680	18-6014	13220	18-1977-1
PH7575	18-7884	12050	18-3327	12690	18-6249	13230	18-1994
PH7575	18-7915	12060	18-3383	12700	18-6015-9	13270	18-3673
PH8842	18-7880	12061	18-3401	12702	18-6093	13280	18-3674
PH8A	18-7875	12070	18-3382	12703	18-6067	13350	18-3672
PH977A	18-7887	12071	18-3381	12703	18-6114	13370	18-3650
PH977A	18-7899	12082	18-3216	12704	18-6089	13380	18-3646
PS3808	18-7844	12084	18-3237	12704	18-6092	13380	18-3651
PS3808	18-7845	12085	18-3309	12710	18-6016	13381	18-3662
		12088	18-3150	12711	18-6080	13390	18-3668
		12091	18-3212-1	12712	18-6094	13400	18-3652
		12100	18-3324	12713	18-6066	13410	18-3671
		12101	18-3393	12730	18-6017	13420	18-3667
		12102	18-3392	12731	18-6018	13430	18-3653
		12103	18-3391	12733	18-6027	13440	18-3670
		12104	18-3390	12736	18-6025	13450	18-3669
		12105	18-3211	12737	18-6095	13520	18-3678
		12106	18-3210	12738	18-6026	13530	18-1993
		12107	18-3215	12739	18-6115	13540	18-3531
		12108	18-3201	12740	18-6012	13550	18-3532
		12110	18-3317	12741	18-6029	13950	18-8112
		12120	18-3320	12743	18-6113	13984	18-4461
		12130	18-3321	12744	18-6097	13990	18-4224
		12140	18-3314	12745	18-6034	13991	18-4227
		12150	18-3316	12750	18-6013	13992	18-4226
		12170	18-3322	12760	18-3121	13993	18-4218
		12180	18-3323	12770	18-6020	14010	18-4500
		12190	18-3386	12772	18-6019	14020	18-4505
		12200	18-3219	12773	18-6101	14030	18-4515
		12202	18-3220	12774	18-6028	14040	18-4520
		12210	18-3378	12775	18-6103	14060	18-4535
		12211	18-3380	12776	18-6024	14110	18-4510
		12221	18-3385	12780	18-6000	14115	18-4010
		12243	18-3994	12781	18-6023	14120	18-4545
		12244	18-3388	12782	18-6004	14125	18-4011
		12246	18-3387	12784	18-6005	14130	18-4525
		12250	18-3207	12787	18-6009	14135	18-4012
		12251	18-3400	12788	18-6010	14140	18-4560
		12260	18-3252	12789	18-6001	14145	18-4013
		12270	18-3239	12810	18-3114	14155	18-4014
		12280	18-3517	12812	18-3358	14160	18-4575
		12290	18-3217	12813	18-3179	14165	18-4015
		12305	18-3149-1	12817	18-3113	14190	18-4090
		12310	18-3417	12820	18-3109	14210	18-3918
GLM							
GLM No.	Sierra No.						
1056	18-7315						
1070	18-7314						
1073	18-7307						
1100	18-7316						
10561	18-3290						
10562	18-3566						
11013	18-2408						
11020	18-2409						
11030	18-2286						
11040	18-2130						
11050	18-2348						
11051	18-2398						
11052	18-2399						
11055	18-1502						
11060	18-2202						
11061	18-2236						
11071	18-3293						
11091	18-2406						
11100	18-2410						
11110	18-2167						
11120	18-2180						
11130	18-2179						
11131	18-2324						
11140	18-2261						
11150	18-2166						
11151	18-2239						
11155	18-2166						
11163	18-2181						
11190	18-3719						
11200	18-6350						

GLM (Cont.)		GLM (Cont.)		GLM (Cont.)		GLM (Cont.)	
GLM No.	Sierra No.	GLM No.	Sierra No.	GLM No.	Sierra No.	GLM No.	Sierra No.
14220	18-3919	21100	18-2151	21649	18-0201	22380	18-3136
14230	18-3920	21110	18-3750	21710	18-2157	22388	18-0653
14240	18-3921	21111	18-3768	21711	18-2145	22390	18-0190
14250	18-3922	21120	18-3751	21715	18-2245-1	22391	18-3233
14260	18-3923	21130	18-2152	21725	18-4236	22407	18-9219
14270	18-3924	21131	18-2357	21731	18-2375	22408	18-2279
14275	18-3927	21136	18-4295	21731	18-23751-9	22409	18-2277
14280	18-3925	21140	18-2161	21731	18-2378	22410	18-2185
14315	18-4600	21160	18-3720	21731	18-23781-9	22411	18-2184
14320	18-4555	21161	18-2344	21740	18-3245	22412	18-2183
14330	18-4565	21170	18-3721	21740	18-6245	22413	18-2186
14410	18-4635	21180	18-3722	21750	18-2170	22414	18-2187
14430	18-4637	21190	18-3723	21770	18-4289	22416	18-2252
14440	18-4636	21210	18-3200	21771	18-2345	22417	18-2251
14470	18-4626	21220	18-3204	21780	18-2160	22420	18-2244
14480	18-4627	21230	18-3700	21790	18-7321	22420	18-22441-9
14490	18-4628	21231	18-3737	21791	18-7311	22420	18-2387
14600	18-4055	21240	18-3704	21800	18-4267	22420	18-23871-9
14610	18-4056	21241	18-3726	21811	18-2140	22421	18-2288
14640	18-4059	21242	18-3703	21820	18-1156	22430	18-2361
14650	18-4060	21245	18-0654	21830	18-1166	22433	18-2326
14660	18-4623	21250	18-3701	21840	18-1153	22435	18-2327
14670	18-4624	21251	18-3782	21850	18-2101	22436	18-2330
14680	18-4625	21260	18-3702	21860	18-1154	22440	18-3229
14910	18-3979	21261	18-3781	21870	18-3199	22445	18-8551
14920	18-3980	21290	18-4233	21880	18-3198	22490	18-2243
14930	18-3981	21300	18-4220	21885	18-1500	22491	18-1501
14940	18-3982	21321	18-8348	21887	18-8111	22500	18-4040
14950	18-3983	21330	18-7426	21890	18-3232	22520	18-1600
14960	18-3984	21350	18-4221	21892	18-4258	22540	18-1602
15100	18-3575	21360	18-3714	21893	18-4263	22560	18-1601
15201	18-3583	21370	18-2462	21894	18-4264	22612	18-2217
15201	18-3599	21380	18-2463	21896	18-4265	22616	18-2290
15301	18-3574	21419	18-3749	21900	18-2100	22620	18-2217
15400	18-3584	21420	18-2169	21910	18-2461	22625	18-2216
15500	18-3581	21421	18-2322	21930	18-2148	22630	18-2221
15600	18-3582	21423	18-3236	21951	18-8205	22631	18-2218
15700	18-3578	21424	18-2395	21960	18-8206	22633	18-2220
16100	18-4035	21425	18-2464	21961	18-8212	22661	18-2310
16120	18-4036	21430	18-2149	21962	18-2771	22662	18-2309
16150	18-4037	21432	18-3754	21980	18-2142	22663	18-2308
16180	18-1186	21433	18-2303	22010	18-2176	22670	18-2210
16200	18-1194	21440	18-2600	22020	18-2177	22671	18-2207
16210	18-4038	21450	18-2603	22030	18-4251	22672	18-2208
16220	18-1374	21451	18-2190	22031	18-4273	22673	18-2209
16230	18-1376	21453	18-2604	22040	18-2156	22681	18-2289
16240	18-1375	21460	18-2159	22050	18-2178	22683	18-2287
16300	18-1366	21480	18-2396	22090	18-2380	22700	18-1362
16310	18-1371	21481	18-2397	22100	18-3740	22710	18-1377
16320	18-1367	21510	18-1165	22110	18-3741	22720	18-1099
16330	18-1365	21511	18-1179	22120	18-3742	22750	18-1112
16340	18-1370	21512	18-1129	22130	18-3743	22760	18-1113
16350	18-1363	21520	18-1160	22140	18-3744	22770	18-1114
16360	18-1364	21540	18-1161	22150	18-3705	22780	18-1115
16370	18-1368	21541	18-1170	22160	18-3706	22800	18-1352
16400	18-4039	21542	18-1172	22170	18-3707	22810	18-1353
16420	18-1195	21543	18-1171	22185	18-3708-1	22820	18-1361
16470	18-1347	21560	18-1142	22190	18-4231	22830	18-1378
16520	18-1196	21570	18-1164	22191	18-4274	22840	18-1359
17000	18-2402	21580	18-1143	22200	18-3715	22850	18-1360
18000	18-2401	21584	18-1193	22220	18-4223	22860	18-1350
18100	18-2443	21590	18-1159	22230	18-4222	22870	18-1351
19100	18-2450	21591	18-1173	22240	18-4230	22880	18-1357
19200	18-2451	21592	18-1130	22250	18-4228	22890	18-1354
19300	18-2452	21593	18-1197	22252	18-4194	22900	18-1355
19310	18-3729	21600	18-1150	22260	18-4232	22910	18-1358
19350	18-3728	21610	18-1117	22280	18-0550	22920	18-1372
19400	18-2453	21620	18-1155	22290	18-0549	22930	18-1373
21010	18-2154	21622	18-1346	22300	18-2377	22940	18-1369
21015	18-2353	21623	18-1345	22317	18-4244	22960	18-1118
21020	18-2155	21625	18-1398	22320	18-3153	22980	18-1121
21030	18-2150	21630	18-1162	22321	18-4276	22990	18-1122
21031	18-2320	21641	18-0193	22322	18-4277	23010	18-2778
21032	18-0647	21642	18-0195	22323	18-3133	23011	18-2777
21033	18-0655	21643	18-0194	22325	18-3365	23020	18-2939
21040	18-2193	21644	18-0198	22330	18-3725	23030	18-2199
21060	18-2164	21645	18-0200	22340	18-3717	23040	18-4210
21070	18-2165	21646	18-0199	22350	18-3716	23050	18-4213
21080	18-2141	21647	18-0196	22360	18-3369	23060	18-4214
21090	18-2163	21648	18-0197	22370	18-3135	23070	18-4211

GLM (Cont.)		GLM (Cont.)		GLM (Cont.)		GLM (Cont.)	
GLM No.	Sierra No.	GLM No.	Sierra No.	GLM No.	Sierra No.	GLM No.	Sierra No.
23080	18-2153	25135	18-2369	30230	18-0893	31180	18-2948
23090	18-4204	26030	18-2119	30240	18-0897	31190	18-2841
23100	18-4206	26040	18-2105	30260	18-2810	31200	18-2828
23110	18-2194	26050	18-2106	30270	18-2809	31210	18-2560
23140	18-2342	26060	18-2107	30290	18-2563	31220	18-2558
23141	18-3759	26070	18-2108	30290	18-2566	31230	18-2559
23150	18-4208	26080	18-2109	30300	18-4380	31260	18-2568
23160	18-4209	26090	18-2120	30320	18-2565	31270	18-2569
23200	18-2346	26100	18-2103	30330	18-0344	31280	18-2570
23203	18-7296	26110	18-2112	30350	18-0464	31300	18-2571
23210	18-2294	26120	18-2113	30351	18-1238	31310	18-2567
23220	18-2285	26130	18-2110	30353	18-0428	31330	18-4261
23230	18-4215	26140	18-2111	30353	18-2845	31340	18-0164
23240	18-4212	26170	18-2123	30354	18-0322	31350	18-0327
23260	18-2283	26180	18-2124	30357	18-0664	31360	18-0889
23261	18-2282	26190	18-2114	30359	18-0311	31370	18-0874
23270	18-2293	26200	18-2134	30360	18-0887	31380	18-0891
23280	18-2292	26200	18-2137	30363	18-0740	31390	18-0332
23300	18-2295	26210	18-2116	30370	18-0905	31400	18-0879
23510	18-2231	26220	18-2126	30380	18-2848	31410	18-2819
23580	18-2230	26240	18-2115	30381	18-0435	31420	18-1210
23590	18-2229	26250	18-2136	30390	18-0419	31430	18-2831
23710	18-3931	26310	18-2701	30410	18-0867	31440	18-2830
23800	18-4122	26320	18-2336	30430	18-2514	31450	18-2846
23810	18-4121	26330	18-2702-1	30440	18-0980	31460	18-2553
23810	18-4294	26340	18-4288	30450	18-0350	31470	18-0342
23820	18-4112	26350	18-2341	30470	18-0352	31480	18-0885
23830	18-4111	26380	18-2428	30480	18-0982	31490	18-2832
23840	18-4102	26400	18-2427	30490	18-0898	31500	18-2802
23850	18-4101	26410	18-2426	30510	18-0353	31510	18-2844
23910	18-4107	26440	18-0652	30530	18-0976	31520	18-2833
23930	18-4127	26460	18-2425	30570	18-0904	31530	18-0378
23940	18-4123	26470	18-2424	30580	18-0354	31540	18-0462
23950	18-4113	26480	18-2465-9	30610	18-0182	31550	18-2896
23960	18-4103	26490	18-2466-9	30640	18-0910	31560	18-2917
24010	18-4120	26500	18-2420	30670	18-0129	31570	18-2912
24020	18-4110	26510	18-2421	30680	18-2806	31580	18-2515
24030	18-4100	26520	18-2423	30700	18-0912	31590	18-0568
24040	18-4124	26530	18-2422	30720	18-0914	31600	18-2838
24050	18-4065	27700	18-3767	30730	18-0149	31620	18-2834
24060	18-4114	27720	18-1731	30740	18-0359	31630	18-2554
24080	18-4104	27782	18-1712	30760	18-0918	31640	18-0988
24090	18-4067	27931	18-2192	30770	18-0131	31650	18-2572
24100	18-4066	27940	18-1729	30790	18-0410	31660	18-0356
24110	18-4125	28020	18-2104	30800	18-0922	31670	18-2552
24112	18-4115	28030	18-2174	30850	18-4366	31680	18-2501
24130	18-4105	28040	18-2097	30860	18-0868	31690	18-2509
24140	18-4068	28050	18-9218	30870	18-0363	31710	18-0992
24210	18-3904	28060	18-6401	30880	18-0926	31720	18-2835
24240	18-3910	28100	18-2128	30890	18-2513	31730	18-2573
24250	18-3975	28180	18-1152	30900	18-0133	31740	18-0434
24260	18-3911	28190	18-1151	30920	18-0928	31750	18-0158
24280	18-3912	28300	18-3231	30930	18-2512	31770	18-0903
24290	18-3974	28310	18-2125	30940	18-0932	31780	18-0942
24300	18-3905	28315	18-2146	30960	18-0101	31790	18-0137
24310	18-3913	28317	18-2337	30970	18-0866	31810	18-2804
24330	18-3915	28318	18-2339	30980	18-0372	31820	18-0685
24410	18-4106	28325	18-2338	30990	18-0103	31830	18-0389
24430	18-3933	28330	18-3712	31000	18-0938	31840	18-2843
24430	18-4126	28340	18-6400	31010	18-2914	31850	18-0365
24570	18-3907	28350	18-3752	31020	18-2915	31860	18-2800
24590	18-3908	28360	18-3713	31030	18-2801	31870	18-0369
24830	18-7826	28370	18-0577	31040	18-2826	31880	18-0151
24840	18-7859	28380	18-2296	31050	18-2919	31890	18-2507
24841	18-7869	28390	18-4296	31060	18-2823	31900	18-0147
24880	18-7860	28400	18-2381	31070	18-2824	31900	18-0747
24900	18-7861	28402	18-2382	31080	18-2825	31910	18-0105
24910	18-7862	30010	18-2340	31090	18-2827	31920	18-2805
24930	18-7846	30020	18-0681	31100	18-0872	31930	18-2836
24940	18-7845	30030	18-2316	31100	18-2949	31940	18-0934
24941	18-7844	30050	18-0123	31101	18-2902	31950	18-2837
24950	18-7852-1	30060	18-0870	31105	18-8536	31960	18-0371
24951	18-7848-1	30090	18-2564	31110	18-2829	31970	18-0373
24970	18-7854	30100	18-0328	31120	18-2847	31980	18-0139
24980	18-7855	30120	18-0329	31130	18-2820	31990	18-0936
25000	18-7853-1	30160	18-0895	31141	18-2743	32000	18-2561
25110	18-8207	30170	18-0333	31150	18-0894	32010	18-2500
25115	18-2404	30180	18-0334	31160	18-2840	32030	18-5399
25120	18-8208	30190	18-1209	31170	18-29451-9	32040	18-0422
25125	18-2405	30220	18-0672	31171	18-42481-9	32050	18-2839

GLM (Cont.)		GLM (Cont.)		GLM (Cont.)		GLM (Cont.)	
GLM No.	Sierra No.	GLM No.	Sierra No.	GLM No.	Sierra No.	GLM No.	Sierra No.
32070	18-0946	33210	18-2887	34280	18-3836	35440	18-1202
32080	18-2849	33220	18-2880	34290	18-2866	35460	18-0150
32090	18-2504	33230	18-2871	34300	18-0117	35480	18-0157
32100	18-2555	33240	18-2870	34310	18-2543	35540	18-0161
32110	18-0385	33250	18-0426	34320	18-2853	35620	18-0633
32120	18-2803	33280	18-2876	34330	18-0969	35650	18-3898
32130	18-0357	33330	18-2861	34340	18-0971	35730	18-0978
32140	18-0360	33340	18-2860	34350	18-2878	35740	18-0130
32150	18-2502	33370	18-2900	34370	18-2544	35750	18-0987
32160	18-0667	33400	18-2960	34380	18-0979	35780	18-0965
32170	18-2909	33410	18-2865	34390	18-0981	35800	18-0963
32175	18-8533	33420	18-2855	34400	18-3837	35830	18-3895
32180	18-0994	33430	18-2877	34410	18-0189	35840	18-2954
32190	18-2575	33440	18-2858	34420	18-0975	35850	18-3861
32200	18-2910	33450	18-2874	34430	18-0989	35860	18-3862
32210	18-0347	33460	18-0973	34440	18-0675	35870	18-3864
32220	18-0320	33470	18-0947	34450	18-2547	35880	18-3863
32280	18-2574	33480	18-0949	34460	18-2550	35890	18-3871
32300	18-0948	33500	18-0677	34470	18-0995	35900	18-3872
32320	18-2807	33510	18-0955	34480	18-0997	35930	18-3866
32330	18-0952	33511	18-0108	34490	18-0999	35940	18-3896
32350	18-0384	33530	18-2873	34520	18-0124	35950	18-3838
32360	18-2562	33540	18-2956	34530	18-1212	35960	18-3897
32370	18-0111	33560	18-2856	34540	18-0134	35990	18-2957
32390	18-0185	33570	18-1204	34550	18-2865	36080	18-2968
32400	18-0160	33580	18-0680	34560	18-3360	36090	18-2970
32420	18-2505	33590	18-2545	34570	18-3803	36100	18-3879
32440	18-2808	33600	18-2546	34580	18-2905	36100	18-7879-1
32450	18-2510	33610	18-0148	34590	18-3839	36110	18-3877
32460	18-0113	33620	18-2549	34610	18-2913	36120	18-3878
32470	18-0881	33630	18-0985	34620	18-2938	36130	18-3880
32480	18-0950	33640	18-2864	34630	18-2548	36140	18-3881
32500	18-0388	33650	18-0977	34640	18-0933	36150	18-2946
32510	18-2511	33660	18-0991	34650	18-0927	36160	18-3876
32520	18-2506	33680	18-0102	34700	18-0937	36170	18-3883
32530	18-2503	33690	18-0106	34710	18-0188	36180	18-3887
32540	18-2508-1	33700	18-3899	34720	18-2911	36200	18-3825
32560	18-0945	33710	18-2852	34730	18-2918	36220	18-3822
32580	18-0114	33730	18-2557	34740	18-0935	36230	18-3823
32600	18-0318	33740	18-0118	34750	18-0923	36240	18-3824
32630	18-0954	33750	18-2857	34770	18-2916	36250	18-3820
32640	18-2815	33760	18-0418	34771	18-0911	36260	18-3814
32650	18-7106	33765	18-8532	34780	18-0941	36290	18-3855
32680	18-0431	33770	18-2875	34790	18-0424	36300	18-3857
32730	18-0386	33780	18-0401	34800	18-1218	36820	18-0476
32740	18-0916	33790	18-0183-1	34850	18-1224	36830	18-2854
32750	18-0876	33795	18-8509	34860	18-0951	36840	18-0475
32760	18-0323	33800	18-0956	34870	18-0953	37000	18-4313
32770	18-0324	33810	18-0943	34880	18-0957	37010	18-4312
32780	18-0336	33820	18-0673	34890	18-0397	37020	18-4314
32800	18-2343	33830	18-2961	34910	18-3827	37100	18-2991
32820	18-0339	33840	18-2947	34920	18-3829	37110	18-0962
32830	18-0670	33850	18-2884	34930	18-3830	37120	18-0869
32840	18-0341	33860	18-2888	34940	18-3831	37130	18-0154
32870	18-0930	33870	18-2964	34950	18-3805	37150	18-0960
32880	18-0135	33880	18-3804	34960	18-3832	37160	18-0417
32890	18-0374	33890	18-3828	34970	18-0959	37190	18-0968
32920	18-0380	33900	18-0548	34980	18-0961	37200	18-0119
32930	18-0940	33910	18-0884	34990	18-0967	37210	18-0853
32940	18-0944	33930	18-0104	35020	18-2929	37220	18-0855
32950	18-0107	33950	18-0913	35030	18-0391	37240	18-0857
32960	18-0970	33960	18-0880	35060	18-0398	37250	18-0861
32980	18-2850	33970	18-0440	35070	18-0346	37260	18-0141
32990	18-2883-1	34000	18-0679	35070	18-0349	37270	18-0152
33010	18-2851	34010	18-3841-2	35080	18-2971	37290	18-0863
33020	18-0110	34020	18-2889	35090	18-2729	37310	18-0873
33030	18-0430	34030	18-2959	35180	18-0983	37320	18-0314
33050	18-0939	34040	18-2891	35190	18-0112	37330	18-0115
33060	18-2863	34050	18-2892	35200	18-0120	37360	18-0958
33080	18-2907	34080	18-0850	35320	18-0122	37370	18-0915
33090	18-2862	34090	18-2893	35330	18-0126	37400	18-0315
33100	18-2890	34120	18-0882	35340	18-0128	37410	18-0854
33110	18-2879	34140	18-2963	35360	18-0136	37430	18-0415
33120	18-2908	34150	18-2895	35370	18-0138	37470	18-0622
33130	18-2903	34200	18-2897	35380	18-0140	37490	18-0345
33140	18-2906	34220	18-2881	35390	18-0142	37500	18-0416
33150	18-2709	34230	18-0917	35400	18-0144	37520	18-0624
33170	18-2901	34240	18-3801	35410	18-0441	37530	18-0644
33180	18-2867	34250	18-3802	35420	18-0851	37540	18-0645
33190	18-2904	34260	18-0929	35430	18-1205	37550	18-0646

GLM (Cont.)		GLM (Cont.)		GLM (Cont.)		GLM (Cont.)	
GLM No.	Sierra No.	GLM No.	Sierra No.	GLM No.	Sierra No.	GLM No.	Sierra No.
37560	18-0642	39690	18-4392	45020	18-7179	56250	18-1998-1
37570	18-0643	39700	18-4393	45030	18-7180	70010	18-5303
37590	18-0641	39710	18-4375	45050	18-7190	70020	18-5311
37630	18-2942	39720	18-4376	45060	18-7181	70030	18-5310
37640	18-2621	39730	18-4337	45080	18-7183	70040	18-5318
37650	18-2741	39740	18-4378	45090	18-7184	70050	18-5317
37660	18-2740	39750	18-4379	45100	18-7186	70060	18-5314
37670	18-2943	39770	18-4369	45160	18-7194	70070	18-5156
37680	18-2611	39780	18-4370	45170	18-7185	70080	18-5157
37690	18-2610	39790	18-4371	45180	18-7187	70082	18-5305
37760	18-2582	39800	18-4372	45200	18-7137	70100	18-5306
37795	18-0626	39810	18-4373	45230	18-7100	70110	18-5148
37796	18-0628	39820	18-4374	45250	18-0298	70160	18-5153
37797	18-0627	39830	18-4368	45280	18-7405	70170	18-5140
39010	18-4386	39840	18-0405	46100	18-1219	70200	18-5141
39020	18-4387	39850	18-1237	46110	18-1221	70500	18-5349
39030	18-4385	39870	18-4347-1	46120	18-3562	70510	18-5347
39040	18-4381	39880	18-4349	46130	18-1222	70520	18-5344
39050	18-4383	39890	18-4348	46140	18-3567	70530	18-5345
39060	18-4384	39910	18-0604	46150	18-1243	70540	18-5346
39080	18-4303-1	39920	18-0603	46160	18-3565	70570	18-5199
39090	18-4304-1	40130	18-7832	46170	18-3564	70580	18-5338
39100	18-4358	40130	18-7838	46180	18-3563	70590	18-5200
39110	18-4382	40140	18-7829	47110	18-3602	70591	18-5348
39120	18-4397	40150	18-7830	47120	18-3601	70640	18-5205
39130	18-0340	40160	18-7831	47130	18-3603	70660	18-5169
39140	18-4350	40280	18-7818-1	50006	18-4008	70670	18-5212
39150	18-4351	40290	18-7817	50310	18-1908K	70680	18-5206
39160	18-0407	40310	18-7804	50330	18-1906	71000	18-5428
39170	18-0465	40320	18-7807	50610	18-1985	71020	18-5418
39180	18-4352	40330	18-7808	51010	18-4009	71030	18-5420
39190	18-4353	40340	18-7809	51030	18-1990	71040	18-5404-1
39210	18-4354	40350	18-7811	51110	18-1970-2	71050	18-5407
39230	18-0153	40360	18-7812	51120	18-1971	71050	18-5425
39240	18-4357	40370	18-7813	51130	18-1972	71060	18-5403
39250	18-4319	40380	18-7814	51140	18-1976-1	71070	18-5432
39260	18-0411	40390	18-7810	51160	18-1975-1	71080	18-5431
39270	18-4396	40410	18-7004	51180	18-1937	71090	18-5411
39280	18-4394	40420	18-7005	51190	18-1978	71100	18-5405
39290	18-4395	40435	18-7006-1	51210	18-1956-1	71110	18-5408
39300	18-4398	40460	18-7007	51212	18-1955-1	71120	18-5406
39310	18-4399	40470	18-7013	51220	18-1952-1	71130	18-5403
39320	18-4367	40480	18-7021	51224	18-1960-1	71400	18-5354
39330	18-4355	40490	18-7211-1	51230	18-1953-2	71410	18-5362
39331	18-4340	40500	18-7033	51237	18-1950-1	71420	18-5361
39332	18-4339	40501	18-7037	51238	18-1951-1	71450	18-5393
39333	18-4336	40510	18-7043	51240	18-1957-1	71460	18-5394
39335	18-4334	40530	18-7024	51250	18-1958-1	71470	18-5356
39336	18-4326	40540	18-7026	51252	18-1962-1	71480	18-5358
39337	18-4325	40550	18-7223	51320	18-1921	71490	18-5357
39338	18-4338	40560	18-7042	51330	18-1909	71500	18-5396
39340	18-4315	40570	18-7046	51340	18-1922	71510	18-5395
39350	18-4300	40580	18-7220	51410	18-1902	71520	18-5384
39350	18-4302	40590	18-7221	51420	18-1903	71530	18-5386
39354	18-4310	40600	18-7219	51430	18-1986	71540	18-5385
39355	18-4324	40610	18-7212	51442	18-1901	71550	18-5389
39360	18-4301	40620	18-7213	51480	18-1848	71560	18-5352
39370	18-4305	40630	18-7214	51510	18-1935-1	71570	18-5369
39380	18-4306	40640	18-7215	51520	18-1936	71580	18-5375
39390	18-4321	40650	18-7750-1	51610	18-1930-1	71590	18-5376
39400	18-4322	40651	18-7226	51630	18-1931-1	71600	18-5353
39410	18-4323	40710	18-7093	51640	18-1932	71700	18-5270
39420	18-4307	40720	18-7094	52080	18-1938	71710	18-5269
39430	18-4309	40800	18-7801	52090	18-1984	71720	18-5268
39440	18-4317	40810	18-7823	52230	18-1983	71730	18-5275
39470	18-0466	40820	18-7820	52240	18-1982	71740	18-5277
39490	18-0348	40830	18-7821	53100	18-4362	71750	18-5276
39500	18-0611	40840	18-7822	53300	18-8529	71760	18-5271
39520	18-4359	40850	18-7800	53330	18-8554	71770	18-5267
39550	18-4356	40860	18-7805	53360	18-8556	71780	18-5273
39560	18-4316	40870	18-7806-1	53430	18-8555	71790	18-5274
39590	18-2614	40900	18-7233	53770	18-8539	71800	18-5272
39600	18-2620	40910	18-7061	54110	18-1899	71810	18-5281
39620	18-2619-1	40920	18-7057	54250	18-1996	71820	18-5278
39630	18-2613	40930	18-7041	56030	18-1949	71830	18-5280
39640	18-2615	40950	18-7062	56110	18-1999	72010	18-5179
39650	18-4388	40970	18-7295	56120	18-1907	72020	18-5196
39660	18-4389	41120	18-7477	56140	18-1939	72030	18-5172
39670	18-4390	44990	18-7956	56230	18-1997-1	72040	18-5192
39680	18-4391	45010	18-4217	56240	18-1898	72050	18-5194

GLM (Cont.)		GLM (Cont.)		GLM (Cont.)		GLM (Cont.)	
GLM No.	Sierra No.	GLM No.	Sierra No.	GLM No.	Sierra No.	GLM No.	Sierra No.
72060	18-5170	75370	18-5755	80420	18-7161	83440	18-7159
72070	18-5193	75380	18-5759	80440	18-7415	84026	18-7474
72080	18-5176	75390	18-5760	81030	18-7197	85010	18-2016
72100	18-5181	75400	18-5758	81070	18-7111	85020	18-2049
72110	18-5433	76068	18-7070	81080	18-0175	85030	18-2003
72113	18-5443	76068	18-7746	81080	18-7145	85040	18-2013
72114	18-5442	76081	18-7081	81090	18-7404	85040	18-2026
72115	18-5434	76082	18-7080	81100	18-7116	85050	18-2009
72120	18-5178	76082	18-7089	81100	18-7417	85060	18-2056
72130	18-5108	76083	18-7076	81120	18-7134	85070	18-2014
72240	18-5740	76084	18-7078	81140	18-7174	85080	18-2011
72260	18-5711	76085	18-7097	81140	18-7416	85090	18-0523
72310	18-5707	76086	18-7098	81160	18-7158	85100	18-2019
72320	18-5708	76088	18-7017	81170	18-7440-1	85110	18-2012
72350	18-5709	76096	18-7096	81180	18-7153	85120	18-2051
72360	18-5801	76101	18-7000	81190	18-7103	85130	18-2002
72370	18-5815	76102	18-7001	81210	18-7408	85130	18-2077
72380	18-5820	76103	18-7008	81220	18-7146	85140	18-2944
72390	18-5816	76104	18-7040	81230	18-7156	85150	18-0521
72400	18-5817	76105	18-7085	81230	18-7409	85160	18-0583
72402	18-5819	76107	18-7075	81240	18-7411	85170	18-0522
72403	18-5812	76111	18-7071	81250	18-7143	85200	18-0563
72410	18-5802	76120	18-7086	81260	18-7164	85210	18-2015
72420	18-5807	76123	18-7077	81270	18-7198	85230	18-0514
72430	18-5808	76150	18-7095	81280	18-7403	85260	18-0515
72440	18-5814	76160	18-7072	81290	18-7461	85270	18-0516
72460	18-5837	77010	18-1256	81310	18-7126	85290	18-2017
72480	18-5836	77010	18-7256	81320	18-7457	85330	18-2006
72490	18-5838	77011	18-7286	81340	18-7128	85380	18-0525
72500	18-5834	77040	18-7267	81360	18-7171	85440	18-0517
72510	18-5297	77050	18-7266	81380	18-7130	85460	18-0527
72520	18-5296-2	77060	18-7265	81390	18-7176	85480	18-2008
72530	18-5298	77070	18-7274	81400	18-7123	85490	18-1211
72540	18-5299	77080	18-7269	81430	18-0858	85520	18-2052
72550	18-5295	77090	18-7275	81430	18-7163	85530	18-2053
72570	18-5294	77101	18-7263	81440	18-7401	85580	18-2055
72590	18-5265	77102	18-7268	81450	18-7108	85581	18-2054
72600	18-5284	77103	18-7270	81470	18-7419	85590	18-2599
72610	18-5250	77105	18-7260	81510	18-7467	85600	18-2007
72620	18-5251	77106	18-7272	81520	18-0860	85610	18-2010
72630	18-5252	77108	18-7271	81540	18-7110	85630	18-0539
72640	18-5253	77113	18-7284	81550	18-7400	85680	18-2048
72650	18-5260	77114	18-7278	81570	18-7449	85700	18-2076
72660	18-5258	77115	18-7289	82030	18-7118	85790	18-0519
72660	18-5264	77116	18-7288	82050	18-7472	85800	18-0526
72670	18-5254	77200	18-4200	82060	18-7959	85810	18-0531
72680	18-5256	77200	18-7200	82080	18-7490	85830	18-0540
72800	18-5011	77220	18-7201	82100	18-7135	85840	18-8353
72810	18-5006	77230	18-7202	82110	18-7420	85850	18-2349
72820	18-5002	77250	18-7208	82130	18-7178	85860	18-1508
72830	18-5003	77260	18-72000	82140	18-7114	85910	18-2094
72840	18-5001	77290	18-7210	82150	18-7117	85960	18-0520
72970	18-5012	79110	18-7605	82170	18-7112	86010	18-2071
72980	18-5008	79120	18-7615	82200	18-7170	86011	18-8300
73010	18-5705	79120	18-7618	82230	18-7155	86012	18-8301
73020	18-5704	79140	18-7616	82240	18-7115	86013	18-8325
73110	18-5116-1	79150	18-7617	82240	18-7464	86030	18-2001
73120	18-5115-1	79180	18-7609	82250	18-7173	86040	18-2020
73180	18-6769-1	79190	18-7608	82260	18-7162	86050	18-2058
73190	18-5107-1	79210	18-7603	82270	18-7196	86060	18-2060
74000	18-5750	80070	18-7421	82280	18-7104	86070	18-2066
74000	18-5950	80080	18-7141	82280	18-7459	86080	18-2072
74000	18-5956	80090	18-7120	82310	18-7152	86090	18-2073
74001	18-5951	80100	18-7101	82320	18-7140	86100	18-3111
74001	18-5957	80100	18-7109	82340	18-7151	86120	18-2025
74100	18-5903	80100	18-7406	82350	18-7121	86130	18-2536
74110	18-5904	80110	18-7413	82360	18-7172	86140	18-2532
74140	18-5905	80120	18-7168	82370	18-7127	86150	18-2027
74140	18-5910	80130	18-7102	82380	18-7169	86160	18-2059
74150	18-5900	80140	18-7165	82390	18-7167	86170	18-2028
74150	18-5911	80160	18-7166	82400	18-7133	86180	18-2029
74170	18-5902	80160	18-7466	82430	18-7407	86190	18-2031
74170	18-5908	80170	18-7410	82440	18-7144	86200	18-2033
74180	18-5901	80180	18-7105	82460	18-7418	86210	18-2537
74180	18-5907	80190	18-7445	82480	18-7107	86230	18-2539
74190	18-5913	80220	18-7129	82900	18-7957	86240	18-2061
75330	18-5754	80330	18-7414	83200	18-7139	86250	18-2062
75340	18-5753	80350	18-7412	83250	18-7138	86270	18-2063
75350	18-5756	80380	18-7177	83340	18-7160	86300	18-2996
75360	18-5757	80390	18-7195	83410	18-7157	86310	18-2516

GLM (Cont.)		GLM (Cont.)		GLM (Cont.)		MALLORY (Cont.)	
GLM No.	Sierra No.	GLM No.	Sierra No.	GLM No.	Sierra No.	MALLORY No.	Sierra No.
86350	18-2021	87604	18-2679	89580	18-3001	9-01412	18-01404
86360	18-2022	87605	18-2682	89590	18-3299	9-01413	18-01406
86370	18-2000	87606	18-2684	89592	18-3138	9-01414	18-01408
86380	18-2018	87607	18-2686	89593	18-3295	9-01416	18-01402
86390	18-2023	87608	18-2689	89594	18-3294	9-01417	18-01416
86400	18-2024	87609	18-2690	89595	18-3108	9-01418	18-01418
86410	18-2005	87611	18-2691	89596	18-3326	9-01419	18-01707
86420	18-2030	87614	18-2694	89600	18-3012	9-01420	18-01422
86430	18-2032	87616	18-2680	89610	18-3060	9-01504	18-03200
86440	18-2074	87617	18-2681	89611	18-3061	9-01505	18-03206
86450	18-2035	87618	18-2683	89612	18-3044	9-01506	18-03208
86460	18-2064	87619	18-2685	89614	18-8903	9-01601	18-01500
86470	18-2075	87620	18-2663	89615	18-8901	9-01703	18-03400
86480	18-2704	87621	18-2687	89620	18-3046	9-01704	18-03404
86481	18-2391	87622	18-2688	89621	18-3047	9-01805	18-01600
86490	18-2703	87630	18-2665	89630	18-3056	9-01806	18-01602
86491	18-2705	87640	18-2664	89640	18-3057	9-02003	18-03600
86492	18-3329	87650	18-2667	89650	18-3002	9-02004	18-03602
86494	18-3337	87651	18-2666	89660	18-3083	9-02005	18-03606
86496	18-2392	87652	18-2669	89670	18-3003	9-02006	18-03608
86497	18-2708	87653	18-2670	89680	18-3043	9-02108	18-01701
86500	18-2706	87654	18-2673	89690	18-3055	9-02109	18-01703
86510	18-2034	87655	18-2671	89710	18-3053	9-02110	18-01705
86520	18-2065	87656	18-2672	89740	18-3087	9-02201	18-07400
86530	18-2067	87660	18-2698	89750	18-3051	9-02412	18-09200
86540	18-2769	87670	18-8360	89760	18-3086	9-02413	18-09202
86570	18-7481	87680	18-2658	89770	18-3050	9-02415	18-09002
86610	18-2068	87690	18-2657	89780	18-3368	9-02416	18-09400
86620	18-0166	87700	18-2625	89790	18-3104	9-02418	18-09602
86630	18-2541	87800	18-2630	89800	18-3054	9-02419	18-09606
86640	18-7475	87802	18-2637	89810	18-3039	9-15000	18-5640
86654	18-8352	87803	18-2632	89820	18-3052	9-15001	18-5601
86660	18-7963	87804	18-2638	89830	18-3007	9-15002	18-5642
86700	18-2767	87805	18-2639	89840	18-3017	9-15003	18-5608
86710	18-2768	87806	18-2633	89850	18-3072	9-15004	18-5613
86711	18-2724	87807	18-2640	89860	18-3073	9-15005	18-5629
86712	18-2692	87808	18-2624	89870	18-3066	9-15006	18-5630
86720	18-1240	87809	18-2635	89880	18-3074	9-15007	18-5634
86740	18-0173	87810	18-2636	89890	18-3067	9-15008	18-5648
86750	18-0174	88170	18-7175	89900	18-3068	9-15009	18-5636
86760	18-0542	89010	18-2757	89910	18-3069	9-15010	18-6441
86760	18-0592	89020	18-2758	89920	18-3070	9-15011	18-5617
86770	18-0543	89030	18-2744	89930	18-3071	9-15012	18-6439
86790	18-8307	89040	18-2752	89940	18-3082	9-15013	18-5622
86810	18-8367	89050	18-2751	89950	18-3058	9-15014	18-5618
86840	18-0584	89060	18-2759	89990	18-3366	9-15015	18-5622
87010	18-2990	89070	18-2762	90050	18-4442	9-15016	18-5621
87020	18-2047	89080	18-2753-2	90065	18-4446	9-15017	18-6437
87030	18-2040	89090	18-2761	90070	18-9099	9-15018	18-6438
87050	18-2043	89100	18-2750	90100	18-9803	9-15019	18-6436
87060	18-2041	89120	18-2748	90110	18-9806E	9-15020	18-5619
87070	18-2057	89130	18-2746	90140	18-9817	9-15021	18-6434
87120	18-2093	89140	18-2756	90160	18-9853	9-15022	18-5611
87130	18-8351	89150	18-2760	90170	18-9855	9-15023	18-6415
87140	18-8350	89160	18-2733	90180	18-9856	9-15024	18-5602
87400	18-2649	89170	18-2732	90190	18-9858	9-15025	18-5605
87410	18-2291	89180	18-2747	90200	18-9861	9-15026	18-5606
87480	18-2643	89190	18-2764	90210	18-9857	9-15027	18-5610
87490	18-2645	89200	18-2765	90220	18-9854	9-15028	18-5620
87500	18-2648	89210	18-2763	90230	18-9868	9-15029	18-5636
87501	18-2644	89220	18-2745	90240	18-9842	9-15030	18-6825
87510	18-2652	89222	18-2780	90260	18-9837	9-15031	18-6283
87511	18-2646-1	89224	18-2779	90270	18-9829	9-15032	18-5612
87513	18-2642	89230	18-2781	90280	18-9819	9-15034	18-5624
87520	18-2653	89240	18-4456			9-15036	18-5628
87530	18-2654	89250	18-4457			9-15037	18-6826
87540	18-2655	89260	18-4458			9-15038	18-6413
87550	18-2590	89450	18-3030			9-15039	18-6440
87561	18-2622	89451	18-3062			9-15040	18-5631
87562	18-3760	89470	18-3005			9-15041	18-6863
87573	18-2627	89480	18-3006			9-15042	18-6282
87574	18-2628	89490	18-3090			9-15043	18-5627
87575	18-2629	89500	18-3091			9-15044	18-6828
87576	18-2697-1	89510	18-3079			9-15045	18-6829
87580	18-8371	89520	18-3080			9-15046	18-6422
87590	18-2626	89530	18-3075			9-15048	18-6432
87600	18-2623	89540	18-3081			9-15049	18-6411
87601	18-2660	89550	18-3077			9-15050	18-6421
87602	18-2656	89560	18-3078			9-15051	18-6416
87603	18-2659	89570	18-3059			9-15052	18-6410
				MALLORY			
				MALLORY No.	Sierra No.		
				9-01102	18-01000	9-15041	18-6863
				9-01103	18-01100	9-15042	18-6282
				9-01208	18-01302	9-15043	18-5627
				9-01209	18-01308	9-15044	18-6828
				9-01210	18-01311	9-15045	18-6829
				9-01211	18-01312	9-15046	18-6422
				9-01212	18-01313	9-15048	18-6432
				9-01213	18-01314	9-15049	18-6411
				9-01214	18-01301	9-15050	18-6421
				9-01301	18-01200	9-15051	18-6416
				9-01302	18-01202	9-15052	18-6410

MALLORY (Cont.)		MALLORY (Cont.)		MALLORY (Cont.)		MALLORY (Cont.)	
MALLORY No.	Sierra No.	MALLORY No.	Sierra No.	MALLORY No.	Sierra No.	MALLORY No.	Sierra No.
9-15053	18-6430	9-18101	18-6767-1	9-19201	18-6455	9-25512	18-5876
9-15054	18-6417	9-18102	18-6761	9-19202	18-5929	9-25513	18-25513
9-15055	18-6425	9-18103	18-6780	9-19203	18-6844	9-25600	18-25600
9-15056	18-6414	9-18104	18-6759	9-19204	18-6455	9-25601	18-5183
9-15057	18-3423	9-18105	18-6285	9-23100	18-5192	9-25602	18-25602
9-15058	18-6427	9-18106	18-6281	9-23101	18-5196	9-25604	18-25604
9-15059	18-6426	9-18107	18-6277	9-23102	18-5181	9-25605	18-25605
9-15060	18-6433	9-18108	18-6816	9-23103	18-5176	9-25650	18-25650
9-15061	18-15061	9-18110	18-5632	9-23104	18-5170	9-25651	18-25651
9-15062	18-6418	9-18200	18-6279	9-23105	18-5194	9-25652	18-25652
9-15063	18-6833	9-18201	18-6774	9-23106	18-5172	9-26000	18-5480
9-15070	18-6873	9-18202	18-6775	9-23107	18-5179	9-26002	18-26002
9-15074	18-6868	9-18203	18-6777	9-23108	18-5193	9-26101	18-5309-1
9-15075	18-6868	9-18204	18-6773	9-23200	18-5186	9-26102	18-5312-1
9-15076	18-6908	9-18205	18-6273-1	9-23201	18-5187	9-26103	18-5339-1
9-15077	18-6867	9-18206	18-6273-1	9-23203	18-5182	9-26104	18-26104-1
9-15078	18-6862	9-18207	18-6772	9-23204	18-5185	9-26105	18-5313-1
9-15080	18-15080	9-18208	18-18208	9-23205	18-23205	9-26106	18-5315-1
9-15100	BA58003	9-18209	18-6279	9-23206	18-5180	9-26107	18-26107-1
9-15101	18-5806	9-18210	18-6799	9-23207	18-23207	9-26110	18-26110-1
9-15102	18-5837	9-18211	18-6286	9-23250	18-23250	9-26111	18-26111-1
9-15103	18-5836	9-18212	18-6765	9-23251	18-23251	9-26112	18-26112-1
9-15104	18-5808	9-18213	18-6273-1	9-23601	18-23601	9-26301	18-5495-2
9-15104-10	18-5808	9-18214	18-6757	9-23602	18-23602	9-26302	18-5489-2
9-15105	18-5801	9-18215	18-6774	9-24500	18-5888	9-26303	18-5496-2
9-15106	18-5802	9-18300	18-6785	9-24501	18-5889	9-26305	18-5497-2
9-15107	18-5812	9-18301	18-6786-1	9-24502	18-5890	9-26306	18-5494-2
9-15108	18-5814	9-18302	18-6793	9-25000	18-5759	9-26307	18-5498-1
9-15109	18-5807	9-18303	18-18303	9-25001	18-5760	9-26308	18-5486-2
9-15110	18-5810	9-18304	18-18304	9-25002	18-5758	9-26309	18-5487-2
9-15111	18-5815	9-18305	18-18305	9-25004	18-5782	9-26310	18-26310-2
9-15112	18-5817	9-18306	18-6822	9-25005	18-5783	9-26311	18-26311-2
9-15112-10	18-5817	9-18400	18-6782	9-25006	18-5784	9-26700	18-5484-1
9-15113	18-5816	9-18401	18-6789	9-25007	18-5761	9-26702	18-5476
9-15115	18-5819	9-18402	18-6783	9-25008	18-5762	9-26750	18-5350
9-15116	18-5820	9-18403	18-6821	9-25009	18-5763	9-26751	18-5351
9-15117	18-5834	9-18405	18-6760	9-25010	18-5764	9-26800	18-26800
9-15118	18-5823	9-18406	18-6259	9-25011	18-5766	9-26804	18-26804
9-15119	18-5833	9-18407	18-6781	9-25012	18-5767	9-26807	18-26807
9-15120	18-5853	9-18408	18-6788	9-25013	18-5785	9-26810	18-26810
9-15121	18-5821	9-18409	18-18409	9-25017	18-5772	9-26811	18-26811
9-15122	18-5879	9-18410	18-6787	9-25018	18-5773	9-26812	18-26812
9-15125	18-5811	9-18411	18-6798	9-25019	18-5781	9-26813	18-26813
9-15200	18-5705	9-18412	18-6836	9-25020	18-5893	9-26815	18-26815
9-15200-10	18-5705	9-18500	18-6769-1	9-25021	18-5770	9-26820	18-26820
9-15201	18-6271	9-18540	18-6823	9-25022	18-5891	9-26821	18-26821
9-15202	18-6268	9-18600	18-6755	9-25023	18-5892	9-26823	18-26823
9-15203	18-5821	9-18601	18-6257	9-25024	18-5885	9-26825	18-26825
9-15210	18-5849	9-18602	18-6779	9-25025	18-5883	9-26900	18-5297
9-15211	18-5851	9-18603	18-6758	9-25026	18-5794	9-26901	18-5294
9-15212	18-5852	9-18604	18-6274	9-25027	18-5887	9-26902	18-5299
9-15213	18-5850	9-18607	18-6754	9-25028	18-5774	9-26903	18-5298
9-15214	18-15214	9-18608	18-6790	9-25029	18-5780	9-26904	18-5296-2
9-15450	18-65450	9-18609	18-6791	9-25030	18-5884	9-28000	18-8803-2
9-15500	18-69550	9-18610	18-6792	9-25100	18-5775	9-28001	18-8804-1
9-15501	18-15501	9-18611	18-6771	9-25101	18-5776	9-28002	18-8804-1
9-15510	18-8220	9-18612	18-6778	9-25102	18-5777	9-28003	18-8802-1
9-15900	18-5913	9-18613	18-6822	9-25103	18-5778	9-28004	18-8811-1
9-15901	18-5919	9-18614	18-6804	9-25104	18-5881	9-28005	18-5228-1D
9-15902	18-5920	9-18615	18-6806	9-25105	18-5787	9-28006	18-5231-1
9-15903	18-5910	9-18616	18-6274	9-25107	18-5790	9-28009	18-8828-1
9-15904	18-5910	9-18618	18-18618	9-25108	18-5791	9-28010	18-8803-2
9-15905	18-5907	9-19100	18-5956	9-25109	18-5793	9-28011	18-8832-1
9-15906	18-6937	9-19101	18-5966	9-25110	18-5792	9-28012	18-8803-2
9-15907	18-6275	9-19102	18-5967	9-25200	18-25200	9-28013	18-8813-1
9-15908	18-5603	9-19103	18-5965	9-25201	18-25201	9-28014	18-8808-2
9-17100	18-5707	9-19104	18-5960	9-25300	18-25300	9-28015	18-8801-1
9-17101	18-5743	9-19105	18-6927	9-25302	18-5132	9-28016	18-8810-1
9-17200	18-5708	9-19106	18-5959	9-25400	18-25400	9-28017	18-8809-1
9-17201	18-5709	9-19107	18-6299	9-25500	18-5854	9-28018	18-28018
9-17202	18-5827	9-19108	18-5984	9-25502	18-5857	9-28019	18-8845-1
9-17203	18-5825	9-19109	18-5983	9-25503	18-5859	9-28020	18-8800-1
9-17204	18-5829	9-19110	18-6293	9-25504	18-5860	9-28021	18-8803-2
9-17205	18-5831	9-19111	18-6298	9-25505	18-5864	9-28022	18-8823-1
9-17206	18-5828	9-19112	18-6454	9-25506	18-5865	9-28023	18-8835-1
9-17207	18-5832	9-19113	18-5957	9-25507	18-5870	9-28024	18-8830-1
9-17208	18-5830	9-19114	18-5943	9-25508	18-5871	9-28025	18-8805-1
9-17300	18-17300	9-19115	18-5959	9-25509	18-5873	9-28026	18-8806-1
9-17301	18-17301	9-19116	18-19116	9-25510	18-5874	9-28027	18-8814-1
9-18100	18-6756	9-19200	18-6960	9-25511	18-5875	9-28028	18-8811-1

MALLORY (Cont.)		MALLORY (Cont.)		MALLORY (Cont.)		MALLORY (Cont.)	
MALLORY No.	Sierra No.	MALLORY No.	Sierra No.	MALLORY No.	Sierra No.	MALLORY No.	Sierra No.
9-28029	18-8820-1	9-29307	18-5284	9-31107	18-31107	9-34110	18-34110
9-28030	18-8802-1	9-29308	18-5281	9-31108	18-7231	9-34120	18-34120
9-28031	18-8838-1	9-29309	18-5260	9-31109	18-7232	9-34140	18-34140
9-28032	18-8801-1	9-29310	18-5258	9-32100	18-7655	9-34500	18-34500
9-28035	18-8807-1	9-29311	18-5268	9-32101	18-7656	9-34600	18-34600
9-28039	18-8817-1	9-29312	18-5272	9-32150	18-32150	9-34601	18-34601
9-28042	18-28042	9-29313	18-5271	9-32151	18-32151	9-34602	18-34602
9-28043	18-8823-1	9-29314	18-5276	9-32200	18-7657	9-34603	18-34603
9-28044	18-28044	9-29315	18-5275	9-32201	18-7658	9-34604	18-34604
9-28046	18-28046	9-29316	18-5277	9-33100	18-33100	9-34605	18-34605
9-28050	18-28050	9-29317	18-5274	9-33102	18-7688	9-35000	18-35000
9-28056	18-8833-1	9-29318	18-5247	9-33103	18-7698	9-35101	18-35101
9-28057	18-8829-1	9-29319	18-5246	9-33104	18-33104	9-35102	18-35102
9-28060	18-8818-1	9-29320	18-5280	9-33105	18-7686	9-35300	18-7334
9-28080	18-28080	9-29321	18-5278	9-33106	18-7685	9-35301	18-7349
9-28081	18-28081	9-29323	18-5012	9-33107	18-7689	9-35302	18-35302
9-28082	18-28082	9-29324	18-5283	9-33200	18-7652	9-35304	18-35304
9-28083	18-28083	9-29330	18-5012	9-33201	18-33201	9-35305	18-7334
9-28084	18-28084	9-29350	18-5273	9-33202	18-7683	9-35325	18-7839
9-28085	18-28085	9-29351	18-5012	9-33207	18-33207	9-35326	18-7843
9-28086	18-28086	9-29400	18-5396	9-33208	18-7663	9-35327	18-7788
9-28090	18-8840-1	9-29401	18-5385	9-33209	18-33209	9-35328	18-7787
9-28091	18-8810-1	9-29402	18-5376	9-33210	18-7662	9-35329	18-7822
9-28092	18-8839-1	9-29403	18-5395	9-33211	18-33211	9-35345	18-0849
9-28100	18-28100	9-29404	18-5393	9-33300	18-7691	9-35350	18-7350
9-28101	18-28101	9-29405	18-5394	9-33301	18-7695	9-35351	18-7351
9-28102	18-28102	9-29406	18-5356	9-33302	18-7692	9-35352	18-7352
9-28120	18-5225	9-29407	18-5386	9-33303	18-7696	9-35353	18-7353
9-28122	18-5224	9-29408	18-5384	9-33304	18-7693	9-35400	18-7254
9-28123	18-5752	9-29409	18-5357	9-33305	18-7690	9-35401	18-7255
9-28124	18-5750	9-29410	18-5358	9-33306	18-7694	9-35402	18-7256
9-28150	18-28150	9-29411	18-5354	9-33400	18-7697	9-35404	18-7258
9-28151	18-28151	9-29412	18-5352	9-33401	18-7632	9-35405	18-7260
9-28175	18-28175	9-29413	18-5369	9-33402	18-7704	9-35408	18-7264
9-29000	18-5317	9-29414	18-5359	9-33403	18-7705	9-35409	18-7265
9-29001	18-5148	9-29416	18-5375	9-33500	18-7703	9-35410	18-7266
9-29002	18-5307	9-29417	18-29417	9-33503	18-7677	9-35411	18-7267
9-29003	18-5310	9-29418	18-5397	9-33504	18-7679	9-35412	18-7268
9-29004	18-5303	9-29419	18-5244	9-33600	18-7668	9-35414	18-7270
9-29005	18-5314	9-29420	18-5243	9-33601	18-7684	9-35416	18-7272
9-29006	18-5311	9-29421	18-5389	9-33602	18-7682	9-35417	18-7274
9-29008	18-5156	9-29423	18-5248	9-33603	18-7668	9-35418	18-7275
9-29009	18-5318	9-29424	18-5361	9-33604	18-7660	9-35419	18-7278
9-29100	18-5345	9-29425	18-5362	9-33700	18-7757	9-35421	18-7281
9-29101	18-5338	9-29426	18-5353	9-33701	18-7630	9-35422	18-7282
9-29102	18-5169	9-29700	18-5433	9-33702	18-7700	9-35423	18-7283
9-29103	18-5344	9-29701	18-5438	9-33800	18-33800	9-35424	18-7284
9-29104	18-5345	9-29702	18-5434	9-33850	18-7513	9-35425	18-7286
9-29106	18-5342	9-29703	18-5435	9-34000	18-7609-1	9-35426	18-7288-1
9-29107	18-5348	9-29704	18-7492	9-34001	18-7608-1	9-35427	18-7289
9-29108	18-5347	9-29705	18-5437	9-34002	18-7610-1	9-35428	18-7326
9-29109	18-5206	9-29707	18-5436	9-34003	18-7603-1	9-35429	18-7326
9-29110	18-5207	9-29708	18-5443	9-34004	18-7615-1	9-35430	18-7330
9-29114	18-5346	9-29709	18-7648	9-34005	18-7616-1	9-35431	18-7331
9-29200	18-5431	9-29710	18-7493	9-34006	18-7617-1	9-35432	18-8868
9-29201	18-5407	9-29711	18-5465	9-34007	18-7605-1	9-35433	18-35433
9-29202	18-5418	9-29716	18-29716	9-34008	18-7618-1	9-35434	18-7333
9-29203	18-5403	9-29717	18-29717	9-34009	18-7604-1	9-35435	18-35435
9-29204	18-5419	9-29720	18-29720	9-34010	18-7619-1	9-35436	18-35436
9-29205	18-5428	9-29722	18-29722	9-34011	18-7613-1	9-35437	18-35437
9-29206	18-5102	9-29723	18-29723	9-34013	18-7611-2	9-35438	18-35438
9-29207	18-5404-1	9-29800	18-5107-1	9-34040	18-7665	9-35439	18-35439
9-29208	18-5430	9-29801	18-5488	9-34041	18-7664	9-35440	18-35440
9-29209	18-5405	9-29804	18-5116-1	9-34064	18-7609-1	9-36700	18-8115
9-29210	18-5411	9-29806	18-7642	9-34066	18-7611-2	9-36800	18-7094
9-29211	18-5427	9-29807	18-5117	9-34068	18-7611-2	9-36801	18-7093
9-29212	18-5428	9-29808	18-5103	9-34069	18-7605-1	9-36802	18-7061
9-29213	18-5429	9-29809	18-5105	9-34070	18-7604-1	9-36803	18-7296
9-29214	18-5403	9-29820	18-7706	9-34071	18-7618-1	9-36850	18-36850
9-29217	18-5245	9-29821	18-7646	9-34074	18-7618-1	9-36900	18-7210
9-29218	18-5432	9-29822	18-7643	9-34075	18-34075	9-36901	18-7201
9-29220	18-5406	9-29823	18-7708	9-34076	18-7615-1	9-36903	18-7202
9-29221	18-5408	9-29900	18-5450	9-34077	18-7615-1	9-36905	18-36905
9-29222	18-5402	9-29901	18-5451	9-34078	18-7615-1	9-36906	18-36906
9-29223	18-5413	9-29904	18-29904	9-34081	18-7489	9-36950	18-7209
9-29300	18-5250	9-31100	18-7228	9-34082	18-7605-1	9-36951	18-7381
9-29301	18-5251	9-31101	18-7234	9-34084	18-7640	9-36952	18-7380
9-29303	18-5256	9-31102	18-31102	9-34085	18-7640	9-36953	18-36953
9-29304	18-5260	9-31103	18-31103	9-34086	18-7604-1	9-36954	18-7382
9-29305	18-5264	9-31104	18-31104	9-34100	18-34100	9-36955	18-7208

MALLORY (Cont.)		MALLORY (Cont.)		MALLORY (Cont.)		MALLORY (Cont.)	
MALLORY No.	Sierra No.	MALLORY No.	Sierra No.	MALLORY No.	Sierra No.	MALLORY No.	Sierra No.
9-36956	18-36956	9-37632	18-7017	9-38001	18-80406	9-40413	18-1924
9-37000	18-7037	9-37633	18-7040	9-38002	18-8079	9-40414	18-1925
9-37100	18-7046	9-37637	18-79900	9-38003	18-8085	9-40415	18-1928
9-37101	18-7223	9-37638	18-79901	9-38004	18-8076	9-40416	18-1929
9-37102	18-7247	9-37639	18-7748	9-38005	18-80420	9-40417	18-1934
9-37103	18-7248	9-37640	18-7749	9-38006	18-8071	9-40418	18-8112
9-37104	18-7024	9-37700	18-7821	9-38007	18-80400	9-40419	18-1938
9-37105	18-7042	9-37701	18-7800	9-38008	18-38008	9-40430	18-1984
9-37106	18-7043	9-37702	18-7820	9-38009	18-80401	9-40440	18-1917
9-37107	18-7222	9-37750	18-7808	9-38010	18-8063	9-40470	18-8515
9-37108	18-7221	9-37751	18-7812	9-38011	18-8091	9-40471	18-8521
9-37109	18-7219	9-37752	18-7813	9-38012	18-80402	9-40473	18-8524
9-37110	18-7220	9-37753	18-7814	9-38013	18-8062	9-40475	18-8536
9-37300	18-7005	9-37754	18-7818-1	9-38014	18-8056	9-40476	18-8519
9-37302	18-7013	9-37755	18-7810	9-38015	18-8092	9-40477	18-8523
9-37303	18-7211-1	9-37756	18-7811	9-38016	18-8055	9-40478	18-8547
9-37304	18-7212	9-37800	18-7844	9-38016-25	18-8055	9-40479	18-8547
9-37305	18-7213	9-37801	18-7845	9-38017	18-8042	9-40500	18-1960-1
9-37306	18-7007	9-37803	18-7846	9-38017-25	18-8042	9-40501	18-1962-1
9-37307	18-7007	9-37804	18-7789	9-38018	18-8074	9-40502	18-1958-1
9-37308	18-7006-1	9-37805	18-7967	9-38018-25	18-8074	9-40503	18-1950-1
9-37309	18-7354	9-37806	18-7968	9-38019	18-8054	9-40504	18-1951-1
9-37310	18-7355	9-37807	18-7866	9-38020	18-8073	9-40505	18-1952-1
9-37311	18-7356	9-37808	18-7865	9-38021	18-8109	9-40506	18-1957-1
9-37400	18-7752	9-37810	18-7948	9-38022	18-8108	9-40507	18-1953-2
9-37401	18-7773	9-37811	18-7919	9-38023	18-8043	9-40530	18-1908
9-37402	18-7753	9-37812	18-7947	9-38030	18-80403	9-40531	18-1985
9-37403	18-7754	9-37815	18-7861	9-38031	18-8070	9-40532	18-1906
9-37404	18-7755	9-37820	18-7860	9-38032	18-8069	9-40540	18-4008
9-37500	18-7293	9-37821	18-7784	9-38033	18-8082	9-40541	18-4009
9-37501	18-7291	9-37822	18-7854	9-38034	18-8068	9-40543	18-1995
9-37502	18-7766	9-37823	18-7859	9-38039	18-8078	9-40545	18-4256
9-37503	18-7768	9-37824	18-37824	9-38040	18-8075	9-40546	18-4264
9-37504	18-7747	9-37825	18-7717	9-38041	18-8083	9-40550	18-1905
9-37505	18-7765	9-37826	18-7721	9-38100	18-8004EP-1	9-40551	18-1937
9-37506	18-7769	9-37827	18-7977	9-38120	18-8013EP-1	9-40552	18-1972
9-37507	18-7772	9-37850	18-7848-1	9-38121	18-8032EP-1	9-40553	18-1973
9-37508	18-7737	9-37851	18-7852-1	9-38140	18-8015EP-1	9-40554	18-1974-1
9-37509	18-7756	9-37852	18-7775-1	9-40100	18-1999	9-40555	18-1975-1
9-37510	18-7738	9-37853	18-7848-1	9-40102	18-1898	9-40556	18-1978
9-37511	18-7736	9-37855	18-7777-1	9-40110	18-1997-1	9-40557	18-1970-2
9-37512	18-7743	9-37856	18-7776-1	9-40111	18-1998-1	9-40558	18-1971
9-37513	18-7741	9-37857	18-7965-1	9-40112	18-1907	9-40559	18-1976-1
9-37514	18-7747	9-37860	18-7853-1	9-40113	18-1939	9-40570	18-8512
9-37515	18-7742	9-37861	18-7775	9-40120	18-1992-1	9-40571	18-8508
9-37516	18-7759	9-37862	18-7777	9-40130	18-1949	9-40573	18-8520
9-37517	18-7739	9-37863	18-7776	9-40170	18-4362	9-40574	18-8531
9-37518	18-7744	9-37880	18-7932	9-40171	18-4364	9-40575	18-8532
9-37519	18-7740	9-37881	18-7951	9-40172	18-8538	9-40576	18-8533
9-37600	18-7000	9-37882	18-7928	9-40173	18-8535	9-40577	18-8500
9-37601	18-7001	9-37883	18-7929	9-40174	18-8536	9-40578	18-8505
9-37602	18-7008	9-37884	18-7922	9-40200	18-1914	9-40579	18-8514
9-37603	18-7085	9-37885	18-7924	9-40270	18-8516	9-40580	18-8529
9-37604	18-7071	9-37886	18-7937	9-40300	18-1915	9-40581	18-8530
9-37605	18-7075	9-37887	18-7938	9-40301	18-1941	9-40582	18-8554
9-37606	18-7076	9-37903	18-8124	9-40302	18-1942	9-40583	18-8555
9-37607	18-7078	9-37905	18-7942	9-40303	18-1940	9-40584	18-8556
9-37608	18-7081	9-37906	18-7940	9-40310	18-1913	9-40585	18-8551
9-37610	18-7086	9-37907	18-37907	9-40311	18-1944	9-40586	18-4362
9-37611	18-7096	9-37908	18-7858	9-40312	18-1945	9-40601	18-1903
9-37612	18-7098-1	9-37950	18-7828-1	9-40313	18-1946	9-40602	18-1902
9-37613	18-7727	9-37951	18-7720	9-40314	18-1948	9-40610	18-1921
9-37614	18-7728	9-37952	18-7786	9-40315	18-6600	9-40611	18-1922
9-37615	18-7729	9-37952-10	18-7786	9-40340	18-1911	9-40670	18-8534
9-37616	18-7070	9-37953	18-7785	9-40370	18-8517	9-40671	18-8502
9-37617	18-7077	9-37954	18-7790	9-40371	18-8526	9-40672	18-8507
9-37618	18-7097	9-37955	18-7791	9-40372	18-8527	9-40770	18-8535
9-37619	18-7080	9-37956	18-8225	9-40373	18-4360	9-40800	18-1996
9-37620	18-7072	9-37957	18-8226	9-40374	18-7512	9-40810	18-1899
9-37621	18-7095	9-37958	18-7829	9-40375	18-8501	9-40870	18-8503
9-37622	18-7236	9-37959	18-7830	9-40376	18-8506	9-40871	18-8504
9-37623	18-7237	9-37960	18-7831	9-40377	18-8518	9-40900	18-1930-1
9-37624	18-7238	9-37961	18-7979	9-40400	18-1926	9-40901	18-1931-1
9-37625	18-7239	9-37965	18-79910	9-40401	18-1927	9-40902	18-1986-1
9-37626	18-7241	9-37966	18-79907	9-40402	18-1933	9-40910	18-1935-1
9-37627	18-7242	9-37967	18-79900	9-40403	18-1982	9-40911	18-1909-1
9-37628	18-7243	9-37968	18-79901	9-40404	18-1983	9-40970	18-8511
9-37629	18-7244	9-37969	18-7713	9-40410	18-1916	9-40971	18-8539
9-37630	18-7245	9-37970	18-7981	9-40411	18-1918	9-40972	18-8510
9-37631	18-7246	9-37980	18-7113-9	9-40412	18-1919	9-41100	18-9010

MALLORY (Cont.)		MALLORY (Cont.)		MALLORY (Cont.)		MALLORY (Cont.)	
MALLORY No.	Sierra No.	MALLORY No.	Sierra No.	MALLORY No.	Sierra No.	MALLORY No.	Sierra No.
9-41200	18-4224	9-43177	18-3608	9-44053	18-70944	9-45300-10	18-3007-10
9-41201	18-4218	9-43178	18-3609	9-44054	18-70935	9-45301	18-8900
9-41202	18-4227	9-43200	18-3206	9-44055	18-70933	9-45301-10	18-8900
9-41203	18-4226	9-43201	18-3119	9-44056	18-70925	9-45302	18-3098
9-41203-10	18-4226	9-43202	18-3118	9-44057	18-70938	9-45302-10	18-3098
9-41205	18-4258	9-43203	18-3405	9-44058	18-70940	9-45303	18-3057
9-42400	18-5897	9-43204	18-3336	9-44059	18-70932	9-45303-10	18-3057
9-42401	18-5898	9-43205	18-3367	9-44060	18-70939	9-45304	18-3054
9-42402	18-7600	9-43206	18-3363	9-44061	18-70941	9-45305	18-3039
9-42404	18-7601	9-43208	18-3129	9-44062	18-75100	9-45305-10	18-3039
9-42406	18-7702	9-43209	18-3180	9-44063	18-70942	9-45306	18-3017
9-42407	18-7647	9-43211	18-3116	9-44064	18-70943	9-45306-10	18-3017-10
9-42500	18-1989	9-43212	18-43212	9-44065	18-70930	9-45307	18-3056
9-42501	18-3531	9-43220	18-1398	9-44066	18-75125	9-45307-10	18-3056-10
9-42502	18-1994	9-43250	18-3170	9-44067	18-70945	9-45308	18-3012
9-42503	18-1977-1	9-43251	18-3171	9-44068	18-70946	9-45309	18-3062
9-42506	18-1977-1	9-43252	18-3173	9-44069	18-70947	9-45309-10	18-3062
9-42601	18-3573	9-43254	18-3356	9-44070	18-70948	9-45310	18-3016-1
9-42602	18-3581	9-43262	18-3185	9-44072	18-71218	9-45310-10	18-3016-1
9-42604	18-3574	9-43263	18-43263	9-44073	18-70957	9-45311	18-3052
9-42605	18-3575	9-43300	18-3424	9-44074	18-70958	9-45312	18-45312
9-42606	18-3583	9-43301	18-3423	9-44075	18-70949	9-45375	18-3087
9-42607	18-3584	9-43302	18-3422	9-44077	18-70950	9-45375-10	18-3087
9-42608	18-42608	9-43304	18-3414	9-44079	18-70952	9-45400	18-8923
9-42700	18-2766	9-43305	18-3416	9-44080	18-70953	9-45401	18-8920
9-42720	18-0549	9-43306	18-3417	9-44081	18-70954	9-45402	18-8924
9-42721	18-0550	9-43307	18-3419	9-44083	18-70955	9-45404	18-45404
9-42800	18-2727	9-43308	18-3420	9-44084	18-70956	9-45500	18-3099
9-42801	18-2733	9-43309	18-3421	9-44092	18-44092	9-45501	18-3094
9-42802	18-2732	9-43330	18-3445	9-45000	18-8901	9-45502	18-3095
9-43000	18-3552	9-43400	18-3117	9-45001	18-3030	9-45503	18-3023
9-43001	18-3555	9-43401	18-3141	9-45001-10	18-3030	9-45504	18-3097
9-43002	18-3649	9-43403	18-3343	9-45003	18-45003	9-45507	18-3035
9-43004	18-3662	9-43404	18-3178	9-45004	18-8903	9-45600	18-3067
9-43005	18-3663	9-43405	18-3359	9-45100	18-3245	9-45601	18-3068
9-43006	18-3658	9-43407	18-3107	9-45101	18-3246	9-45601-10	18-3068
9-43007	18-3654	9-43408	18-3126	9-45102	18-3247	9-45602	18-3069
9-43008	18-3660	9-43413	18-3122	9-45103	18-3248	9-45602-10	18-3069
9-43009	18-3539	9-43500	18-3145	9-45104	18-3250	9-45603	18-3070
9-43010	18-3666	9-43502	18-3114	9-45105	18-3249	9-45603-10	18-3070
9-43011	18-3664	9-43504	18-3358	9-45106	18-3031	9-45604	18-3072
9-43012	18-3659	9-43505	18-3346	9-45200	18-3051	9-45605	18-3074
9-43013	18-3551	9-43508	18-3182	9-45200-10	18-3051	9-45606	18-3088
9-43014	18-3549	9-43525	18-3179	9-45201	18-3050	9-45607	18-3040
9-43015	18-43015	9-43601	18-3113	9-45201-10	18-3050-10	9-45608	18-3063
9-43016	18-3555	9-43603	18-3329	9-45202	18-3055	9-45609	18-3071
9-43017	18-43017	9-43604	18-3110	9-45203	18-3043	9-45609-10	18-3071
9-43018	18-3656	9-43612	18-2705	9-45204	18-3104	9-45610	18-3066
9-43019	18-3553	9-43613	18-3337	9-45204-10	18-3104	9-45611	18-3073
9-43020	18-3550	9-43615	18-2392	9-45205	18-3091	9-45612	18-3042
9-43021	18-3554	9-43622	18-7139	9-45206	18-3059	9-45613	18-3065
9-43022	18-3559	9-43623	18-3109	9-45206-10	18-3059-10	9-45614	18-8910
9-43023	18-3561	9-43624	18-2708	9-45207	18-3053	9-45615	18-8911
9-43024	18-3557	9-43628	18-2599	9-45207-10	18-3053	9-45616	18-9825
9-43025	18-3556	9-43629	18-2948	9-45208	18-3368	9-45617	18-45617
9-43026	18-3676	9-43631	18-7116	9-45209	18-3083	9-45700	18-3089
9-43027	18-3560	9-43632	18-7481	9-45209-10	18-3083	9-45701	18-3075
9-43028	18-3677	9-43700	18-3326	9-45210	18-3090	9-45702	18-3080
9-43029	18-3534	9-43702	18-3293	9-45211	18-3104	9-45703	18-3081
9-43030	18-3546	9-43703	18-3108	9-45212	18-3366	9-45704	18-3306
9-43031	18-3545	9-43711	18-9075	9-45213	18-3082	9-45705	18-3205
9-43032	18-3544	9-43712	18-9076	9-45214	18-3091	9-45706	18-3047
9-43035	18-3540	9-43713	18-9078	9-45215	18-3002	9-45707	18-3060
9-43036	18-3544	9-43714	18-9077	9-45215-10	18-3002	9-45707-10	18-3060
9-43037	18-3541	9-43715	18-9079	9-45216	18-3001	9-45708	18-3061
9-43038	18-3609	9-43716	18-43716	9-45216-10	18-3001	9-45709	18-3076
9-43051	18-43051	9-43720	18-3293	9-45217	18-3006	9-45710	18-3077
9-43052	18-43052	9-43801	18-3136	9-45218	18-3003	9-45711	18-3078
9-43100	18-3648	9-43813	18-2379	9-45218-10	18-3003	9-45712	18-45712
9-43101	18-3672	9-43814	18-2377	9-45219	18-3096	9-45713	18-45713
9-43150	18-3668	9-44000	18-4456	9-45220	18-3044	9-45714	18-45714
9-43151	18-3646	9-44001	18-4457	9-45221	18-45221	9-45715	18-3078
9-43152	18-3651	9-44002	18-4458	9-45222	18-3006	9-45716	23-2000
9-43153	18-3650	9-44003	18-2778	9-45280	18-3058	9-45717	18-3079
9-43154	18-3671	9-44004	18-2775	9-45281	18-3086	9-45800	18-3586
9-43155	18-3569	9-44005	18-2774	9-45283	18-3212-1	9-48200	18-3315-2
9-43156	18-3653	9-44010	18-3221	9-45284	18-3286	9-48201	18-3327
9-43157	18-3647	9-44050	18-70931	9-45285	18-3348	9-48202	18-3211
9-43175	18-43175	9-44051	18-70934	9-45286	18-3386	9-48203	18-3392
9-43176	18-3624	9-44052	18-71337	9-45300	18-3007	9-48204	18-3378

MALLORY (Cont.)		MALLORY (Cont.)		MALLORY (Cont.)		MALLORY (Cont.)	
MALLORY No.	Sierra No.	MALLORY No.	Sierra No.	MALLORY No.	Sierra No.	MALLORY No.	Sierra No.
9-48205	18-3381	9-51303	18-1412	9-54217	18-3902	9-57817	18-7915-1
9-48206	18-3384	9-51304	18-1417	9-54219	18-3916	9-57818	18-7895
9-48207	18-3399	9-51306	18-1416	9-54225	18-3982	9-57819	18-7905
9-48208	18-3393	9-51401	18-1411	9-54229	18-3979	9-57820	18-8003
9-48209	18-3394	9-51403	18-4077	9-54231	18-3981	9-57821	18-7921
9-48210	18-3390	9-51406	18-4078	9-54233	18-3921	9-57822	18-7758
9-48211	18-3382	9-52100	18-1752	9-54235	18-3923	9-57823	18-7918
9-48212	18-3383	9-52101	18-1753	9-54237	18-4050	9-57824	18-57824
9-48213	18-3389	9-52300	18-1757	9-54239	18-4052	9-57825	18-7824-2
9-48214	18-2704	9-52301	18-1759	9-54400	18-3913	9-57826	18-57826
9-48215	18-2706	9-52302	18-1758	9-54401	18-3914	9-57902	18-7871
9-48216	18-2703	9-52400	18-1755	9-54402	18-3915	9-57905	18-7926
9-48217	18-7963	9-52401	18-1756	9-54404	18-3931	9-57906	18-0032
9-48218	18-3133	9-52404	18-4157	9-54406	18-3933	9-57907	18-7878-1
9-48219	18-3135	9-53200	18-4620	9-54412	18-3910	9-57908	18-7974
9-48220	18-3400	9-53202	18-4622	9-54413	18-3911	9-57909	18-7926
9-48222	18-3388	9-53210	18-4018	9-54414	18-3912	9-57910	18-7880
9-48300	18-3207	9-53224	18-4530	9-54416	18-3904	9-57911	18-7884
9-48301	18-3507	9-53232	18-4635	9-54417	18-3906	9-58000	18-2193
9-48302	18-3323	9-53233	18-4636	9-54418	18-3905	9-59000	18-4489
9-48303	18-3322	9-53240	18-4014	9-54420	18-3901	9-59004	18-4485
9-48304	18-3217	9-53246	18-4623	9-54422	18-3905	9-59005	18-4486
9-48305	18-3317	9-53248	18-4625	9-54424	18-4088	9-59020	18-4495
9-48306	18-3319	9-53250	18-4626	9-54425	18-4089	9-60001	18-2933
9-48307	18-3320	9-53252	18-4628	9-54426	18-4090	9-60002	18-0182
9-48308	18-3321	9-53256	18-4643	9-54432	18-3975	9-60003	18-0844
9-48309	18-3314	9-53257	18-4644	9-54434	18-3974	9-60004	18-0339
9-48310	18-3316	9-53260	18-4639	9-54436	18-3907	9-60005	18-2553
9-48311	18-3517	9-53261	18-4640	9-54438	18-3908	9-60006	18-2554
9-48312	18-3324	9-53265	18-4575	9-54804	18-3963	9-60007	18-2917
9-48313	18-3214	9-53401	18-4115	9-54808	18-3960	9-60007-10	18-2917
9-48314	18-3571	9-53412	18-4107	9-54812	18-3969	9-60008	18-2552
9-48315	18-3147	9-53413	18-4117	9-54816	18-3934	9-60009	18-0398
9-48316	18-3237	9-53416	18-4124	9-54817	18-3936	9-60010	18-2844
9-48317	18-48317	9-53417	18-4114	9-54904	18-4294	9-60011	18-2834
9-48350	18-3150	9-53418	18-4104	9-55000	18-15550	9-60012	18-2831
9-48600	18-3148	9-53420	18-4120	9-55001	18-15520	9-60016	18-2858
9-48601	18-3310	9-53421	18-4110	9-55002	18-15460	9-60017	18-2947
9-48602	18-3370	9-53422	18-4100	9-55003	18-15480	9-60020	18-2564
9-48603	18-3395	9-53424	18-4112	9-55004	18-15410	9-60021	18-2563
9-48604	18-3397	9-53425	18-4111	9-55005	18-15370	9-60022	18-2565
9-48605	18-3148	9-53426	18-4102	9-55006	18-15440	9-60023	18-2566
9-48606	18-3370	9-53427	18-4101	9-55007	18-15490	9-60026	18-2593
9-48608	18-3451	9-53430	18-4122	9-55020	18-18000	9-60027	18-0622
9-48609	18-3433	9-53432	18-4063	9-55021	18-18100	9-60028	18-2801
9-48610	18-3440	9-53434	18-4064	9-55022	18-15113	9-60029	18-2824
9-48611	18-3442	9-53436	18-4195	9-55023	18-15115	9-60030	18-2825
9-48612	18-3430	9-53437	18-4086	9-55024	18-15105	9-60031	18-2919
9-48613	18-3450	9-53438	18-4165	9-55025	18-15113	9-60033	18-2841
9-48614	18-3311	9-53439	18-4087	9-55026	18-15102	9-60034	18-2914
9-48615	18-3313	9-53442	18-4190	9-55027	18-15104	9-60035	18-2915
9-48616	18-3371	9-53443	18-4079	9-55028	18-15122	9-60036	18-2826
9-48617	18-3433	9-53445	18-4058	9-56000	18-95560	9-60037	18-0894
9-48618	18-3396	9-53462	18-4067	9-56005	18-95605	9-60038	18-2562
9-48619	18-48619	9-53463	18-4068	9-56006	18-95606	9-60039	18-2823
9-48700	18-3279	9-53466	18-4065	9-56481	18-56481	9-60040	18-0315
9-48701	18-3280	9-53467	18-4066	9-56482	18-56482	9-60041	18-0115
9-48702	18-3282	9-53468	18-4123	9-56501	18-4508	9-60042	18-0879
9-48703	18-3278	9-53469	18-4113	9-56870	18-56870	9-60043	18-0670
9-50000	18-50000	9-53470	18-4103	9-56871	18-4514	9-60044	18-2835
9-50001	18-50001	9-53805	18-4144	9-57700	18-7907	9-60045	18-0378
9-51000	18-51000	9-53806	18-4145	9-57701	18-7890	9-60046	18-2506-1
9-51001	18-51001	9-53807	18-4146	9-57702	18-57702	9-60047	18-2807
9-51002	18-51002	9-53810	18-4141	9-57725	18-7997	9-60048	18-0324
9-51003	18-51003	9-53811	18-4142	9-57726	18-7999	9-60049	18-2513
9-51100	18-1361	9-53812	18-4143	9-57800	18-7913	9-60050	18-2513
9-51103	18-1374	9-53815	18-4097	9-57801	18-7824-2	9-60051	18-0642
9-51104	18-1360	9-53817	18-4099	9-57802	18-7875	9-60052	18-0131
9-51105	18-1391	9-53820	18-4128	9-57803	18-7879-1	9-60053	18-0918
9-51106	18-1395	9-53821	18-4129	9-57804	18-7911-1	9-60054	18-0970
9-51200	18-1346	9-53822	18-4130	9-57806	18-7878-1	9-60056	18-0645
9-51202	18-1154	9-53823	18-4131	9-57807	18-7903	9-60057	18-0936
9-51204	18-1345	9-53825	18-4133	9-57808	18-7906-1	9-60058	18-0988
9-51206	18-1195	9-53830	18-4080	9-57809	18-7902	9-60059	18-0139
9-51207	18-1347	9-53831	18-4081	9-57810	18-7910-1	9-60060	18-2501
9-51209	18-1196	9-54200	18-3966	9-57811	18-7876	9-60061	18-0320
9-51210	18-1186	9-54202	18-3968	9-57813	18-7916	9-60062	18-0129
9-51211	18-4038	9-54208	18-4019	9-57814	18-7896	9-60063	18-0870
9-51300	18-1414	9-54210	18-4021	9-57815	18-7897	9-60065	18-0891
9-51302	18-1415	9-54216	18-3927	9-57816	18-7918	9-60066	18-0903

MALLORY (Cont.)		MALLORY (Cont.)		MALLORY (Cont.)		MALLORY (Cont.)	
MALLORY No.	Sierra No.	MALLORY No.	Sierra No.	MALLORY No.	Sierra No.	MALLORY No.	Sierra No.
9-60067	18-0327	9-60422	18-0136	9-61010	18-4380	9-61602	18-0887
9-60074	18-0164	9-60423	18-0138	9-61011	18-0994	9-61603	18-4375
9-60100	18-4698	9-60424	18-2865	9-61012	18-2743	9-61610	18-1213
9-60100-50	18-46981-9	9-60425	18-1205	9-61040	18-4377	9-61612	18-1233
9-60101	18-2945	9-60426	18-2876	9-61041	18-0889	9-61620	18-1211
9-60101-50	18-29451-9	9-60427	18-0118	9-61042	18-0876	9-61621	18-0519
9-60102	18-2945	9-60428	18-0134	9-61051	18-61051	9-61622	18-1234
9-60102-50	18-29451-9	9-60429	18-0983	9-61100	18-4374	9-61623	18-0864
9-60103	18-60103	9-60430	18-2913	9-61101	18-4384	9-61650	18-4024
9-60103-50	18-60103-50	9-60431	18-2938	9-61102	18-4387	9-61652	18-4022
9-60104	18-0905	9-60432	18-1207	9-61103	18-4383	9-61653	18-4024
9-60105	18-2430	9-60433	18-2545	9-61104	18-4385	9-61700	18-1271
9-60202	18-8331	9-60434	18-2866	9-61105	18-4373	9-61701	18-1270
9-60202-50	18-8331	9-60435	18-0117	9-61200	18-0868	9-61702	18-1275
9-60301	18-99027	9-60436	18-0850	9-61201	18-0465	9-61703	18-1256
9-60309	18-0757	9-60437	18-0424	9-61202	18-1231	9-61704	18-1273
9-60312	18-99000	9-60438	18-2867	9-61204	18-0410	9-61705	18-1274
9-60313	18-99002	9-60439	18-1212	9-61208	18-0607	9-61706	18-1265
9-60314	18-99003	9-60440	18-0963	9-61210	18-4388	9-61707	18-1266
9-60315	18-99006	9-60441	18-0148	9-61211	18-4365	9-61708	18-1267
9-60317	18-99008	9-60442	18-0142	9-61212	18-4389	9-62601	18-2619-1
9-60318	18-99010	9-60443	18-0161	9-61213	18-0488	9-62601-25	18-2619-1
9-60319	18-99012	9-60444	18-0122	9-61214	18-0487	9-62602	18-2614
9-60320	18-99014	9-60445	18-2852	9-61217	18-0403	9-62602-25	18-2614
9-60321	18-99016	9-60446	18-0130	9-61221	18-61221	9-62603	18-2617
9-60322	18-99018	9-60447	18-0144	9-61300	18-2845	9-62604	18-2615
9-60323	18-99019	9-60448	18-0977	9-61302	18-0464	9-62605	18-2613
9-60324	18-99021	9-60449	18-2546	9-61305	18-0664	9-62606	18-2699
9-60325	18-99023	9-60450	18-0987	9-61307	18-0352	9-62650	18-2918
9-60326	18-99024	9-60451	18-0941	9-61308	18-0609	9-63700	18-2946
9-60328	18-99032	9-60452	18-2544	9-61311	18-25001	9-63701	18-3877
9-60329	18-99033	9-60453	18-0440	9-61312	18-2815	9-63702	18-3878
9-60330	18-99034	9-60454	18-2873	9-61313	18-0685	9-63703	18-3874
9-60335	18-99005	9-60455	18-0110	9-61315	18-25002	9-63704	18-3880
9-60336	18-99009	9-60463	18-2857	9-61316	18-0311	9-63705	18-3881
9-60339	18-99017	9-60464	18-2549	9-61317	18-0347	9-63706	18-3876
9-60340	18-99020	9-60501	18-99040	9-61318	18-0346	9-63707	18-3879
9-60341	18-99026	9-60503	18-99039	9-61319	18-61319	9-63708	18-3883
9-60342	18-0618	9-60505	18-99091	9-61400	18-0418	9-63709	18-3860
9-60343	18-0656	9-60508	18-60508	9-61401	18-0872	9-63711	18-3878
9-60344	18-99047	9-60510	18-0829	9-61402	18-4394	9-63800	18-3855
9-60345	18-99047	9-60511	18-99124	9-61403	18-4395	9-63801	18-3857
9-60346	18-99028	9-60512	18-60512	9-61404	18-4396	9-63803	18-3852
9-60347	18-99028	9-60513	18-60513	9-61405	18-4398	9-63804	18-3854
9-60348	18-99028	9-60518	18-60518	9-61406	18-4367	9-63805	18-3853
9-60353	18-99001	9-60519	18-60519	9-61407	18-2833	9-63806	18-3858
9-60354	18-99004	9-60520	18-60520	9-61409	18-1210	9-63807	18-3851
9-60356	18-99013	9-60521	18-60521	9-61411	18-0113	9-63820	18-3837
9-60357	18-99079	9-60522	18-60522	9-61412	18-0881	9-63821	18-3836
9-60358	18-99015	9-60523	18-60523	9-61413	18-0897	9-63822	18-3838
9-60360	18-99022	9-60525	18-99075	9-61414	18-2849-1	9-63823	18-2888
9-60361	18-99025	9-60526	18-99070	9-61415	18-0954	9-63825	18-3839
9-60362	18-99030	9-60527	18-60527	9-61416	18-2830	9-63826	18-3866
9-60365	18-99045	9-60528	18-60528	9-61417	18-2912	9-63827	18-2960
9-60366	18-99046	9-60529	18-60529	9-61418	18-0956	9-63828	18-2956
9-60378	18-0239	9-60530	18-60530	9-61419	18-1204	9-63829	18-2964
9-60380	18-0756-1	9-60531	18-60531	9-61420	18-0183-1	9-63830	18-3803
9-60382	18-0240	9-60532	18-60532	9-61421	18-2909	9-63832	18-2963
9-60395	18-0785	9-60534	18-60534	9-61422	18-0672	9-63833	18-3802
9-60396	18-0813	9-60535	18-60535	9-61423	18-2819	9-63834	18-7110
9-60398	18-99037	9-60536	18-99069	9-61424	18-2832	9-63850	18-7400
9-60399	18-99038	9-60537	18-99074	9-61426	18-2896	9-63851	18-3861
9-60400	18-0880	9-60538	18-0754	9-61428	18-0680	9-63852	18-3872
9-60401	18-2557	9-60539	18-0836	9-61450	18-4369	9-63853	18-3862
9-60402	18-0969	9-60540	18-60540	9-61451	18-4371	9-63854	18-3864
9-60404	18-2855	9-60541	18-60541	9-61452	18-0943-1	9-63855	18-3863
9-60406	18-0882	9-60915	18-60915	9-61453	18-4347-1	9-63856	18-3871
9-60408	18-4248	9-60916	18-60916	9-61455	18-4349	9-63900	18-3808
9-60408-50	18-42481-9	9-60917	18-60917	9-61500	18-1239	9-63902	18-3810
9-60409	18-2709	9-60918	18-60918	9-61501	18-0348	9-63903	18-3809
9-60410	18-2911	9-60919	18-60919	9-61502	18-0407	9-63950	18-3891
9-60413	18-2864	9-60920	18-60920	9-61503	18-0340	9-63951	18-3894
9-60414	18-0965	9-61001	18-0467	9-61504	18-1237	9-63952	18-3831
9-60415	18-0933	9-61003	18-0462	9-61505	18-0405	9-63953	18-3830
9-60416	18-0979	9-61004	18-2848	9-61507	18-1235	9-63955	18-99140
9-60417	18-0985	9-61005	18-0353	9-61508	18-1232	9-63956	18-3892
9-60418	18-0989	9-61006	18-0354	9-61509	18-0466	9-63958	18-3805
9-60419	18-0975	9-61007	18-0356	9-61511	18-0322	9-63959	18-3832
9-60420	18-2550	9-61008	18-0360	9-61513	18-61513	9-63960	18-3804
9-60421	18-0128	9-61009	18-0357	9-61600	18-0976	9-63961	18-3848

MALLORY (Cont.)		MALLORY (Cont.)		MALLORY (Cont.)		MALLORY (Cont.)	
MALLORY No.	Sierra No.	MALLORY No.	Sierra No.	MALLORY No.	Sierra No.	MALLORY No.	Sierra No.
9-63962	18-3828	9-72001-10	18-3722	9-72654	18-2378	9-73542	18-1288
9-63963	18-99062	9-72002	18-3720	9-72655	18-2387	9-73543	18-1289
9-63964	18-3827	9-72002-10	18-3720	9-72656	18-72656	9-73544	18-1290
9-63965	18-3829	9-72003	18-3723	9-72657	18-8331	9-73550	18-1291
9-63966	18-63966	9-72003-10	18-3723	9-72659	18-1236	9-73560	18-2221
9-63968	18-63968	9-72004	18-3721	9-72660	18-4249	9-73561	18-2218
9-64002	18-4312	9-72004-10	18-3721	9-72700	18-2752	9-73564	18-2220
9-64006	18-4314	9-72005	18-72005	9-72701	18-2751	9-73890	18-73890
9-64100	18-4402	9-72009	18-2560	9-72702	18-2756	9-73891	18-73891
9-64101	18-4321	9-72100	18-2603	9-72703	18-2750	9-73892	18-73892
9-64102	18-4302	9-72101	18-2604	9-72704	18-2747	9-73893	18-73893
9-64106	18-4428	9-72140	18-2192	9-72705	18-2753-2D	9-73900	18-3200
9-64107	18-4406	9-72150	18-2149	9-72706	18-2764	9-73901	18-3704
9-64108	18-4323	9-72151	18-2162	9-72707	18-2765	9-73902	18-3714
9-64109	18-4322	9-72152	18-2163	9-72708	18-2758	9-73903	18-3705
9-64110	18-4310	9-72153	18-2161	9-72709	18-2763	9-73904	18-4194
9-64111	18-4304-1	9-72154	18-3752	9-72710	18-2744	9-73905	18-4231
9-64112	18-4303-1	9-72155	18-3751	9-72711	18-1074	9-73906	18-3773
9-64113	18-4305	9-72156	18-2145	9-72721	18-8368	9-73907	18-73907
9-64114	18-4307	9-72157	18-2190	9-72800	18-2780-1	9-73908	18-3732
9-64115	18-4309	9-72158	18-2158	9-72801	18-2781	9-73909	18-3726
9-64117	18-4301	9-72159	18-2159	9-72802	18-2779	9-73911	18-2380
9-64200	18-4317	9-72160	18-2157	9-72803	18-2757	9-73912	18-3735
9-64201	18-4319	9-72161	18-2622	9-72804	18-2770	9-73914	18-73914
9-64204	18-4359	9-72162	18-3760	9-72805	18-2748	9-73915	18-4274
9-64207	18-4337	9-72164	18-2303	9-72806	18-2745	9-73918	18-73918
9-64209	18-4336	9-72200	18-2176	9-72807	18-2759	9-73951	18-3717
9-64210	18-4339	9-72201	18-2177	9-72808	18-2762	9-73952	18-3716
9-64211	18-4340	9-72202	18-6399	9-72809	18-2761	9-73953	18-3715
9-64212	18-4319	9-72203	18-3725	9-72810	18-2760	9-73960	18-3701
9-64213	18-4356	9-72204	18-2178	9-72811	18-2746	9-73961	18-3702
9-64214	18-4325	9-72352	18-2239	9-72812	18-2768	9-73963	18-3703
9-64215	18-4326	9-72400	18-2125	9-72813	18-2767	9-73964	18-73964
9-64216	18-4338	9-72401	18-2146	9-72814	18-2780-1	9-73978	18-73978
9-64217	18-64217	9-72402	18-6400	9-72900	18-8218	9-73979	18-73979
9-64221	18-64221	9-72403	18-2128	9-72901	18-8205	9-73990	18-73990
9-64401	18-4419	9-72404	18-2104	9-72902	18-2601-1	9-73991	18-3781
9-64402	18-4427	9-72405	18-2174	9-72903	18-8219	9-73992	18-3782
9-64404	18-4405	9-72406	18-2097	9-72904	18-8206-1	9-73993	18-73993
9-64405	18-4404	9-72408	18-6402	9-72905	18-8212-1	9-73994	18-73994
9-64406	18-4403	9-72409	18-9218	9-72906	18-8218	9-74000	18-8366
9-64407	18-4415	9-72410	18-2100	9-72907	18-8219	9-74001	18-8365
9-64410	18-4400	9-72412	18-21005	9-72930	18-2771	9-74002	18-8362-1
9-64411	18-4411	9-72413	18-6406	9-72931	18-2772-1	9-74100	18-2656
9-64412	18-99103	9-72414	18-6406	9-73001	18-3601	9-74101	18-2658
9-64415	18-64415	9-72415	18-21006	9-73002	18-3602	9-74102	18-2659
9-64418	18-99073	9-72420	18-2724	9-73003	18-3603	9-74103	18-2660
9-65100	18-2875	9-72425	18-21005K	9-73100	18-7311	9-74104	18-2694
9-65200	18-0470	9-72426	18-2100K	9-73101	18-7314	9-74105	18-2684
9-65300	18-2941	9-72450	18-2166	9-73102	18-7316	9-74106	18-2623
9-65301	18-0471	9-72460	18-2180	9-73103	18-7315	9-74107	18-8341
9-65302	18-0472	9-72461	18-2179	9-73104	18-7312	9-74108	18-74108
9-65303	18-0474	9-72462	18-2324	9-73115	18-7321	9-74109	18-8373
9-65400	18-0305	9-72463	18-2331	9-73117	18-1728	9-74110	18-8374
9-65401	18-0309	9-72475	18-2169	9-73118	18-1710	9-74111	18-8337
9-65402	18-0475	9-72476	18-2150	9-73130	18-1705	9-74112	18-2657
9-65500	18-0476	9-72477	18-2320	9-73131	18-73131	9-74113	18-2692
9-65501	18-2854	9-72500	18-2172	9-73340	18-1551	9-74114	18-2691
9-65700	18-0677	9-72501	18-2173	9-73420	18-1550	9-74115	18-2685
9-65800	18-2971	9-72502	18-2171	9-73431	18-1550	9-74200	18-2626
9-65801	18-2991	9-72503	18-2412	9-73432	18-1560	9-74201	18-2655
9-71102	18-71102	9-72504	18-2413	9-73450	18-1551	9-74202	18-2654
9-71500	18-2103	9-72505	18-2414	9-73451	18-1564	9-74203	18-2653
9-71501	18-2105	9-72506	18-2321	9-73452	18-1566	9-74204	18-2635
9-71502	18-2106	9-72507	18-2323	9-73454	18-1565	9-74205	18-2624
9-71503	18-2107	9-72510	18-72510	9-73464	18-2236	9-74206	18-2646-1
9-71504	18-2108	9-72600	18-2370	9-73474	18-2202	9-74207	18-2640
9-71505	18-2109	9-72601	18-2191	9-73500	18-2210	9-74208	18-8382
9-71506	18-2112	9-72602	18-2376	9-73501	18-2207	9-74209	18-2642
9-71507	18-2113	9-72603	18-1567	9-73502	18-2208	9-74210	18-2697-1
9-71508	18-2114	9-72640	18-2298	9-73504	18-2209	9-74212	18-2628
9-71509	18-2115	9-72641	18-2299	9-73510	18-2315	9-74300	18-2645
9-71510	18-2116	9-72642	18-2354	9-73511	18-2310	9-74301	18-2643
9-71512	18-2436	9-72643	18-2298	9-73512	18-2309	9-74302	18-2644
9-71514	18-2136	9-72644	18-0557	9-73514	18-2308	9-74303	18-2648
9-71515	18-2137	9-72650	18-2244	9-73520	18-2289	9-74304	18-2652
9-71516	18-2435	9-72650-10	18-22441-9	9-73530	18-2290	9-74400	18-2665
9-71702	18-2432	9-72651	18-2375	9-73534	18-2216	9-74401	18-2671
9-71703	18-2433	9-72652	18-2374	9-73540	18-1293	9-74402	18-2672
9-72001	18-3722	9-72653	18-2371	9-73541	18-1287	9-74500	18-0020

MALLORY (Cont.)		MALLORY (Cont.)		MALLORY (Cont.)		MALLORY (Cont.)	
MALLORY No.	Sierra No.	MALLORY No.	Sierra No.	MALLORY No.	Sierra No.	MALLORY No.	Sierra No.
9-74501	18-74501	9-76204	18-2027	9-76567	18-7403	9-79000	18-9098
9-74502	18-0021	9-76205	18-2059	9-76568	18-7445	9-79001	18-9099
9-74503	18-0028	9-76206	18-2060	9-76569	18-7961	9-79101	18-2411
9-74504	18-74504	9-76207	18-2028	9-76571	18-7475	9-79126	18-2415
9-74507	18-74507	9-76208	18-2030	9-76573	18-7485	9-79127	18-2401
9-74510	18-74510	9-76209	18-2031	9-76574	18-7440-1	9-79200	18-2405
9-74511	18-99073	9-76210	18-2032	9-76578	18-7956	9-79202	18-2256
9-74512	18-74512	9-76211	18-2033	9-76579	18-7956	9-79203	18-2259
9-74513	18-74513	9-76212	18-2001	9-76581	18-7449	9-79800	18-4442
9-74514	18-0023	9-76213	18-2064	9-76586	18-8325	9-79801	18-9803
9-74515	18-74515	9-76214	18-2065	9-76615	18-7436	9-79802	18-9802
9-74516	18-0024	9-76217	18-8326	9-76651	18-7121	9-79803	18-9801
9-74518	18-99104	9-76218	18-2029	9-76652	18-7401	9-79804	18-9800
9-74526	18-74526	9-76219	18-2061	9-76653	18-4253-9	9-79805	18-9861
9-74527	18-74527	9-76220	18-2062	9-76654	18-7404	9-79806	18-9806-1
9-74528	18-0030	9-76221	18-8300	9-76689	18-76689	9-79807	18-9842
9-74529	18-0031	9-76222	18-2058	9-76690	18-76690	9-79808	18-9868
9-74530	18-0027	9-76228	18-2020	9-76691	18-76691	9-79809	18-9854
9-74531	18-0026	9-76230	18-2094	9-76692	18-76692	9-79810	18-9809
9-74534	18-0025	9-76410	18-0554	9-76693	18-76693	9-79811	18-9847
9-74535	18-74535	9-76411	18-0296	9-76694	18-76694	9-79812	18-9872
9-74539	18-2794-1	9-76412	18-0265	9-76695	18-76695	9-79813	18-79813
9-74540	18-74540	9-76413	18-0297	9-77000	18-2702-04D	9-79814	18-79814
9-74544	18-74544	9-76414	18-0587	9-77000-20	18-2702	9-79815	18-79815
9-74546	18-74546	9-76421	18-0265	9-77001	18-4288	9-79816	18-79816
9-74700	18-8335	9-76422	18-0266	9-77001-20	18-4288	9-79816-24	18-79816-24
9-74701	18-8338	9-76423	18-0267	9-77002	18-2341-1	9-79817	18-79817
9-74702	18-8339	9-76500	18-7145	9-77002-20	18-2341-1	9-79820	18-79820
9-74703	18-8340	9-76501	18-7173	9-77003	18-2701	9-79821	18-9870
9-74805	18-74805	9-76502	18-7170	9-77004	18-2701-04	9-79822	18-9896
9-75100	18-1190	9-76503	18-2516	9-77100	18-2461	9-79823	18-79823
9-75104	18-1397	9-76504	18-7198	9-77101	18-2464	9-79824	18-9141
9-75106	18-1179	9-76505	18-7153	9-77102	18-2462	9-79825	18-79825
9-75107	18-1143	9-76506	18-7105	9-77103	18-2463	9-79833	18-79833
9-75108	18-1162	9-76507	18-7117	9-77200	18-2465-9	9-79834	18-79834
9-75110	18-1166	9-76508	18-2996	9-77200-20	18-2465	9-81000	18-9783
9-75111	18-1157	9-76509	18-7100	9-77201	18-2466-9	9-81001	18-9782
9-75112	18-1158	9-76511	18-7134	9-77201-20	18-2466	9-81002	18-9781
9-75113	18-1153	9-76512	18-2944	9-77900	18-8357	9-81003	18-9794
9-75114	18-1155	9-76516	18-0858	9-77901	18-2625	9-81004	18-9788
9-75115	18-1173	9-76517	18-2536	9-77902	18-8361	9-81006	18-81006
9-75117	18-1165	9-76518	18-2769	9-77903	18-8358	9-81100	18-81100
9-75118	18-1156	9-76519	18-7101	9-77904	18-8359	9-81101	18-81101
9-75119	18-1197	9-76520	18-7102	9-78001	18-1240	9-81102	18-81102
9-75120	18-1159	9-76521	18-7104	9-78002	18-4261	9-81103	18-81103
9-75121	18-1117	9-76522	18-7108	9-78003	18-2742	9-82100	18-9550-0
9-75122	18-1161	9-76525	18-7118	9-78005	18-2715	9-82101	18-9550-3
9-75123	18-1160	9-76526	18-7120	9-78007	18-2534	9-82150	18-9750-0
9-75125	18-1193	9-76527	18-7127	9-78009	18-2539	9-82151	18-9750-0
9-76100	18-2016	9-76528	18-7130	9-78013	18-4251	9-82200	18-9013
9-76101	18-2076	9-76529	18-7133	9-78100	18-0577	9-82201	18-9024
9-76102	18-2003	9-76530	18-7135	9-78103	18-3719	9-82202	18-9080
9-76103	18-2007	9-76531	18-7137	9-78105	18-4296	9-82250	18-9570-0
9-76104	18-2008	9-76532	18-7128	9-78106	18-2342	9-82275	18-9775
9-76105	18-2009	9-76533	18-7138	9-78107	18-3712	9-82276	18-9065
9-76106	18-2010	9-76535	18-7140	9-78108	18-2343	9-82300	18-9500-1
9-76107	18-2011	9-76536	18-7142	9-78109	18-4295	9-82301	18-9500-2
9-76108	18-2013	9-76537	18-7143	9-78110	18-3151	9-82302	18-9500-3
9-76109	18-2014	9-76539	18-7146	9-78111	18-2357	9-82303	18-9500-4
9-76110	18-2048	9-76540	18-7151	9-78112	18-2261	9-82305	18-9500-7
9-76111	18-2049	9-76541	18-7155	9-78114	18-3198	9-82311	18-9798
9-76112	18-2050	9-76542	18-7157	9-78115	18-3199	9-82350	18-9420-2
9-76113	18-2051	9-76543	18-7158	9-78117	18-3713	9-82351	18-9420-3
9-76114	18-2052	9-76544	18-7159	9-78120	18-2382	9-82352	18-9420-7
9-76115	18-2053	9-76545	18-7160	9-78121	18-2381	9-82360	18-9410-2
9-76116	18-2054	9-76546	18-7161	9-78126	18-2346	9-82361	18-9410-4
9-76117	18-2055	9-76547	18-7162	9-78127	18-3229	9-82363	18-9410-7
9-76119	18-2077	9-76549	18-7167	9-78129	18-3231	9-82380	18-9400-2
9-76127	18-0579	9-76550	18-7168	9-78130	18-3197	9-82382	18-9400-4
9-76128	18-0580	9-76551	18-7169	9-78132	18-2130	9-82383	18-9400-7
9-76129	18-0583	9-76552	18-7172	9-78133	18-2286	9-82390	18-9440-2
9-76130	18-2056	9-76553	18-7174	9-78134	18-2349	9-82391	18-9440-3
9-76131	18-0500	9-76554	18-7176	9-78135	18-2348	9-82392	18-9440-4
9-76133	18-2154	9-76555	18-7178	9-78137	18-4267	9-82393	18-9440-7
9-76134	18-2155	9-76556	18-7180	9-78138	18-4270	9-82400	18-9600-0
9-76136	18-2353	9-76557	18-7183	9-78139	18-3219	9-82401	18-9600-2
9-76200	18-2018	9-76559	18-7188	9-78140	18-3220	9-82402	18-9600-5
9-76201	18-2025	9-76562	18-7426	9-78141	18-4273	9-82403	18-9600-6
9-76202	18-2002	9-76564	18-7419	9-78212	18-0605	9-82404	18-9600-7
9-76203	18-2026	9-76565	18-7420	9-78213	18-0619	9-82500	18-9650-0

MALLORY (Cont.)		OSCO		OSCO (Cont.)		OSCO (Cont.)	
MALLORY No.	Sierra No.	OSCO No.	Sierra No.	OSCO No.	Sierra No.	OSCO No.	Sierra No.
9-82501	18-9650-2	106	18-1941	0879-G	18-0113	FLCR818	18-1998-1
9-82502	18-9650-5	121	18-0471	0879-MK	18-8500	FL-GH	18-0183-1
9-82503	18-9650-6	150	18-1911	106-T	18-1942	M0002	18-0677
9-82504	18-9650-7	188	18-1922	121-MK	18-8501	MC552-SB	18-1994
9-82601	18-9620-2	402	18-6600	143-DEG	18-3551	MC55-TSB	18-1977-1
9-82602	18-9620-5	480	18-2941	2076-MK	18-8551	MWS	18-1995
9-82700	18-9200	639	18-1913	244-MK	18-8502	MWS-G	18-1209
9-82750	18-9710-1	689	18-1945	28001-MK	18-8503	NWK	18-8540
9-82751	18-9710-0	794	18-1946	29001-MK	18-8504	VO418	18-1930-1
9-82752	18-9700-2	826	18-1940	3320-MK	18-8554	VO-GH	18-2991
9-82801	18-9680-2	879	18-1905	3320-MK-X	18-8555	VO-MK	18-8539
9-82802	18-9680-5	992	18-1999	3322-MK	18-8556		
9-82804	18-9680-7	994	18-1997-1	4354-MK	18-8505		
		1851	18-1906	480-FW	18-0472		
		2018	18-1907	480-MK	18-4360		
		2076	18-1975-1	480-MK-FW	18-8506		
		2441	18-1902	50456-G	18-0943		
		2442	18-1903	50456-MK	18-8507		
		3320	18-1908	5538-G	18-2819		
		3322	18-1985	5538-MK	18-8508		
		4354	18-1976-1	560-MK	18-8509		
		5538	18-1973	56879-MK	18-8510		
		5603	18-1962-1	5805-MK	18-8511		
		5604	18-1958-1	60252-MK	18-8512		
		5639	18-1944	6325-MK	18-8552		
		5805	18-1931-1	6371-MK	18-4362		
		5862	18-1954-1	6371-MK-SP	18-8514		
		5944	18-0470	6562-MK	18-8515		
		6022	18-0473	7056-MK	18-8516		
		6108	18-0305	7081-GH	18-0474		
		6325	18-1972	7081-MK	18-8517		
		6351	18-1971	7087-MK	18-8518		
		6562	18-0309	7087-OR	18-7512		
		6705	18-1955-1	7114B2	18-1953-2		
		6771	18-1978	7169-MK	18-8519		
		7056	18-1914	7214-MK	18-8520		
		7081	18-1915	7234B	18-1950-1		
		7169	18-1916	7235B	18-1951-1		
		7296	18-1917	775-MK	18-8521		
		7386	18-1918	775-MK-A	18-8522		
		7387	18-1919	7772-MK	18-8523		
		7624	18-1924	799-MK	18-8524		
		7752	18-1925	8125-MK	18-8544		
		7753	18-1926	8128-MK	18-8546		
		7772	18-1927	8243-MK	18-8545		
		7854	18-8112	826-MK	18-8526		
		7924	18-1928	826-MK-SS	18-8527		
		7992	18-1929	826-SS	18-8528		
		7993	18-1933	8503A	18-1970-2		
		8068	18-1934	8503A-MK	18-8529		
		8125	18-1982	8503-GB	18-0672		
		8128	18-1984	8503-GO	18-2849		
		8243	18-1983	8503-GR	18-0897		
		8502	18-1974-1	8561-G	18-0881		
		8561	18-1937	8561-MK	18-8530		
		8759	18-1960-1	8759-MK	18-8531		
		9011	18-1957-1	9011-MK	18-8532		
		9015	18-1938	9015-G	18-0475		
		9234	18-1948	9015-MK	18-8547		
		9745	18-1952-1	9745-MK	18-8533		
		9798	18-1956-1	9863-G	18-0943		
		9863	18-1921	9863-MK	18-8534		
		28001	18-1996	992-G	18-2854		
		29001	18-1899	992-G-FW	18-0476		
		35908	18-2971	992-MK	18-4364		
		41812	18-2554	992-MK-FW	18-8535		
		47510	18-2553	994-MK	18-8536		
		48043	18-2832	994S	18-1949		
		50456	18-1909	CRR-1	18-1999		
		52076	18-2833	CRR-MK-FW	18-8535		
		52374	18-1986	CS-GH	18-2909		
		54870	18-1912	CVCR-MK	18-8536		
		56879	18-1935-1	CV-GH	18-0872		
		58764	18-0353	CV-GH	18-0872		
		60207	18-4008	CW994	18-1898		
		60252	18-4009	CW-GH	18-0418		
		99204	18-1939	CY4-GH	18-2896		
		1016004	18-8111	CY6-GH	18-2830		
		1016012	18-4258	FL994	18-1998-1		
		0188-G	18-2875	FL-994MK	18-8538		

MOELLER

SEADOG

SEADOG (Cont.)		SEADOG (Cont.)		WISECO (Cont.)		WIX (Cont.)	
SEADOG No.	Sierra No.	SEADOG No.	Sierra No.	WISECO No.	Sierra No.	WIX No.	Sierra No.
420429	MP39302	420487-1	MP40970-1	3115P3	18-4104	51064	18-7910
420441	RK21892	420488-1	MP40990	3115PS	18-4124	51068	18-7878
420446	RK21892	420489-1	MP40990	31164P4	18-4132	51069	18-7824
420460	TG21132	WISECO		3116PS	18-4128	51307	18-7878
420465	TG40002			3116S4	18-4133	51334	18-7910
420479	MP39242			3116SS	18-4129	51348	18-7884
420486	MP40962			3118P3	18-4102	51348	18-7915
420487	MP40972-1			3118PS	18-4122	51356	18-7914
420489	MP40992			3118S3	18-4101	51358	18-7902
420101-1	TG40020-1			3118SS	18-4121	51365	18-7911
420102-1	TG40030-1			3119P3	18-4067	51394	18-7916
420103-1	TG40450-1			3119PS	18-4065	51515	18-7875
420104-1	TG40460-1			3119S3	18-4068	51773	18-7887
420105-1	TG40160-1	3119SS	18-4066	51791	18-7880		
420108-1	TG40040-1	3121P3	18-4103	51806	18-7886		
420109-1	TG40050-1	3121PS	18-4123	51970	18-7874		
420111-1	TG40060	3123P2	18-4530	51970	18-7899		
420112-1	TG40080	3123P3	18-4515				
420118-1	TG40070	3123PS	18-4500				
420119-1	TG40090	3125KD	18-3921				
420121-1	TG40300	3127P3	18-4127				
420122-1	TG40310	3127PS	18-4107				
420123-1	TG40320	3130P2	18-4142				
420124-1	TG40330	3130P3	18-4143				
420125-1	TG40340	3130PS	18-4141				
420128-1	TG19520	3131P3	18-4099				
420129-1	TG19530	3131PS	18-4097				
420201-1	RK19400	3132P3	18-4093				
420202-1	RK19410	3132PS	18-4091				
420203-1	RK19420	3136P3	18-4126				
420204-1	RK19430	3136PS	18-4106				
420208-1	RK19490	3145KD	18-3922				
420209-1	RK19480	3155KD	18-3923				
420211-1	RK19440	3172P3	18-4064				
420212-1	RK19450	3172PS	18-4063				
420213-1	RK19460	3173P3	18-4100				
420218-1	RK19540	3173PS	18-4120				
420219-1	RK19550	3184P2	18-4139				
420241-1	RK40140	3184P3	18-4140				
420242-1	RK40150	3184PS	18-4138				
420243-1	RK40480	3187KD	18-3913				
420245-1	RK40360	3190P2	18-4136				
420248-1	RK40170	3190PS	18-4137				
420249-1	RK40350	3190PS	18-4135				
420251-1	RK40100	3217KD	18-3915				
420252-1	RK40120	3228KD	18-3969				
420258-1	RK40110	3312KD	18-3951				
420259-1	RK40130	3375KD	18-3927				
420350-1	MP39060	3500KD	18-3904				
420351-1	MP39040	3520KD	18-3906				
420355-1	MP39080	3530KD	18-3905				
420360-1	MP39120	3544KD	18-3934				
420361-1	MP39780	3625KD	18-3907				
420365-1	MP39200	3685KD	18-3975				
420366-1	MP41030	3715KD	18-3974				
420369-1	MP39830	B1029	18-1375				
420375-1	MP41040	3030PS	18-4141	CW24	18-4292		
420379-1	MP39800	3031P3	18-4099	S474	18-4281		
420381-1	MP41000	3031PS	18-4097	S493	18-4280		
420382-1	MP39760	3032P3	18-4093	W4958	18-4294		
420383-1	MP41070-1	3032PS	18-4091	W5217	18-1374		
420385-1	MP41010	3036P3	18-4126	W5263	18-4290		
420386-1	MP41080	3036PS	18-4106	WIX			
420390-1	MP39530	3072P3	18-4064				
420396-1	MP39390	3072PS	18-4063				
420400-1	MP39610	3073P3	18-4100				
420410-1	MP39570	3073PS	18-4120				
420415-1	MP39690	3102PS	18-4600				
420416-1	MP39680	3108P2	18-4525				
420420-1	MP39310	3108P3	18-4540				
420421-1	MP39320	3108PS	18-4510				
420422-1	MP39320	3108S2	18-4560				
420427-1	MP39160	3108S3	18-4575				
420429-1	MP39300	3108SS	18-4545				
420441-1	RK21890	3109P2	18-4520				
420446-1	RK21890	3109P3	18-4535				
420460-1	TG21130	3109PS	18-4505				
420465-1	TG40000	3111P3	18-4105				
420479-1	MP39240	3111PS	18-4125				
420486-1	MP40960	3115P2	18-4114				

GENERATOR PRODUCTS

FISCHER PANDA			NORTHERN LIGHTS			Westerbeke (Cont.)		
O.E. #	SIERRA #	PAGE #	O.E. #	SIERRA #	PAGE #	O.E. #	SIERRA #	PAGE #
IC78.460.000A	23-1105	110	11-10015	23-0830	116	33417	23-0803	115
IC78.460.000B	23-1104	110	24-22009	23-1102	110	33966	23-0807	115
J009-1027B-1	23-3312	113	24-28003	23-1103	110	34093	23-2800	118
J009-46840	23-3311	113	25-12009	23-3315	113	34113	23-2701	117
JABSCO			25-12009	23-2005	112	34196	23-0802	115
22799-0001	23-2003	112	25-12031	23-0400	113	34440	23-3307	113
JOHNSON PUMP			ONAN			34552	23-5601	Obsolete
09-808B-1	23-2001	112	122-0185	23-7841	119	35109	23-5840	111
KOHLER			122-0810	23-7840	119	35595	23-7801	118
26987	23-7762	111	130-4434	23-6401	120	35608	23-2702	117
229432	23-0810	115	130-6228	23-6402	120	35610	23-2801	118
229433	23-0812	116	132-0349	23-3300	112	35736	23-3601	114
229678	23-7822	119	132-0436	23-3309	113	35828	23-7825	119
229715	23-7751	110	149-0428	23-7750	111	35920	23-7720	111
229826	23-2002	112	149-1445	23-7720	111	36450	23-7200	110
229826	23-3303	112	149-2106	23-7760	111	36918	23-7800	118
229955	23-3304	112	185-5835	23-7842	119	37387	23-3602	114
229963	23-0813	116	185-7444	23-7804	118	37922	23-0808	115
249433	23-7771	111	309-0130	23-3606	114	38100	23-7201	110
249865	23-0811	115	541-1519	23-3310	113	39181	23-4000	120
249930	23-3608	114	A026K278	23-7760	111	39378	23-3603	114
250872	23-2003	112	SHERWOOD			39705	23-1101	110
252896	23-3609	114	09000K	23-2002	112	40154	23-7826	119
252898	23-7740	110	10077K	23-2000	112	40434	23-0805	115
260085	23-6400	120	WESTERBEKE			40859	23-2700	117
267709	23-1100	110	11672	23-4001	120	40860	23-2802	118
267714	23-7823	119	11885	23-6400	120	42201	23-2804	118
267717	23-3610	115	11907	23-3301	112	42260	23-0800	115
267718	23-0809	115	13810	23-4005	113	43050	23-2803	118
278857	23-1130	110	24132	23-5880	111	43060	23-4500	118
279449	23-7820	118	24323	23-0806	115	45232	23-4003	120
326817	23-7803	118	24353	23-1000	122	46097	23-3604	114
352018	23-3607	114	24363	23-7764	111	46124	23-0801	115
352031	23-0814	116	24639	23-5800	120	46592	23-2703	117
352122	23-3308	113	24690	23-3605	114	46596	23-4501	118
359771	23-7821	119	26488	23-3600	114	46622	23-3306	113
359978	23-2004	112	30200	23-7770	111	47060	23-7770	111
359978	23-3314	113	30376	23-4007	114	48076	23-7802	118
249930 & 29963	23-3664	117	30475	23-4004	120	24688 & 24323	23-3650	116
252896 & 229432	23-3665	117	30592	23-4002	120	24688 & 33966	23-3658	117
267717 & 267718	23-3663	117	30593	23-5600	120	24688 & 34196	23-3653	116
352018 & 352031	23-3666	117	30594	23-5900	120	24688 & 40434	23-3662	117
GM24510	23-7202	110	31152	23-4006	114	24690 & 33373	23-3660	117
GM32359	23-7761	111	32620	23-3305	112	24690 & 33417	23-3657	116
GM34570	23-7780	111	33104	23-3313	113	35736 & 33417	23-3652	116
GM47465	23-7824	119	33112	23-3302	112	35736 & 34196	23-3651	116
			33373	23-0804	115	35736 & 40434	23-3661	117
						37387 & 37922	23-3659	117
						39378 & 42260	23-3654	116
						39378 & 46124	23-3655	116
						46097 & 33417	23-3656	116

SIERRA MARINE PRODUCTS

A.C. DELCO			Barr (Cont.)			Barr (Cont.)		
O.E. #	SIERRA #	PAGE #	O.E. #	SIERRA #	PAGE #	O.E. #	SIERRA #	PAGE #
GF-61	18-7856-1	140	200087P		898, 970	MC 1 99798	18-1956-3	777
GF-61P	18-7857-1	140	200089P	18-1991	569, 608, 630, 898, 970	MC-1-65603	18-1962-1	777
ARCTIC CAT			20-0100	18-1907	642	MC-1-65604	18-1958-1	777
0436-879	72-5100-3	193	20-0100	18-1939	569, 586, 609, 618,	MC-1-77234	18-1950-1	776
0436-880	72-5100-2	193	20-0102	18-1907	569, 586, 609,	MC-1-77235	18-1951-1	776
0436-901	72-5102-4	194	CHV-1-83	18-1964	639	MC-1-87114	18-1953-2	776
1436-159	72-5102-2	194	CHV-1-83	18-1997-1	569, 586, 607, 630,	MC-1-89011	18-1957-2	777
1436-434	72-5101-2	193	CHV-47-000	18-2949	571, 611, 631,	MC-1-99746	18-1952-1	776
1436-435	72-5101-3	193	CHVA-1-84	18-1898	569, 586, 607, 642,	MC-20-44354	18-1976-2	779
4639-349	72-5103-2	193	CM 20-0097	18-1949	569, 609, 642, 779, 970	MC-20-55538	18-1973	778
5639-469	72-5103-3	193	CM-1-6672-B	18-1941	587	MC-20-60207	18-4008	780
ARCTIC CAT PWC			CM-1-6672-H	18-1942	587	MC20-60426P	18-4362	778
3008-093	18-6919	552	CM-1-6677A	18-1940	586	MC-20-76325	18-1972	778
3008-327	18-6919	552	CM-1-6677SS P	18-8527	588	MC-20-76771	18-1978	778
3008-462	18-6919	552	CM-20-414211	18-1944	586	MC-20-93322A3	18-1985	779
3008-536	18-6919	552	CM-20-6672	18-1946	586	MC-20-98502	18-1974-1	779
BARR			CM206672JP	18-4360	587	MC-20-98504	18-1970-2	778
160252	18-4009	780	CM-20-6674	18-1945	586	OMC-1-914035	18-1986-1	969
01-0105	18-0476-1	643, 899, 971	CM-20-6674JP	18-8506	588	BORG-WARNER		
01-0107	18-2854-1	571, 611, 631, 643	CM-20-6674JP	18-8507	899, 971	A4876HA	18-2590	559
1-73813	18-1990	780	CM-20-6674P	18-4361	587	BOSCH		
20-0082	18-1999	569, 607, 630, 642, 778, 898, 970	CM-20-9232P	18-8518	588	0-001-109-035	18-6944	662
20-0082-P	18-4364	570, 588, 609, 618, 630, 642, 781, 899, 970	CM-20-9234	18-1948	587	0331-302-050	18-5806	954
200087P	18-1992-1	569, 608, 630, 778,	CM-20-9234 P	18-8501	588	0331-302-081	18-5806	954
			FM-1-83	18-1996	630	0331-302-085	18-5806	954
			FM-1-83	18-1998-1	569, 607, 630, 642,	0331-302-581	18-5806	954
			FM-1-83-P	18-4363	570, 609, 630, 642,	0331-302-585	18-5806	954
			MC 1 58759	18-1960-1	777			
			MC 1 96705	18-1955-1	777			

BRP			Chrysler Force (Cont.)			Chrysler Force (Cont.)		
O.E. #	SIERRA #	PAGE #	O.E. #	SIERRA #	PAGE #	O.E. #	SIERRA #	PAGE #
5007987	18-8387	346	25-201951	18-7134	239	39-820641A1	18-3999	233
420956741	18-8880	552	25-32507	18-7127	239	398-832075A4	18-5870	221
CAN-AM			25-45258	18-7950	239	398-832075A6	18-5873	221
XPS #779139	72-5101-2	193	25-85549	18-7956	239	44-850308	18-2254	238
XPS #779140	72-5101-3	193	25-85594	18-7100	239	449541-3	18-6762	224
CATERPILLAR			25-88657	18-7952	239	46-43024A7	18-3214	230
3001117	18-6955	661, 953	25-F24278	18-7169	239	47-19453	18-8900	230
10-258	18-6955	661, 953	25-F45530	18-7457	239	47-42038-2	18-3062	230
163-3361	18-6944	662	25-F498618	18-7120	239	47-430262	18-3056	229
1R-0658	18-7880	183, 672	25-F74305	18-7176	239	47-803630T	18-3030	229
1R-0714	18-7927	182, 673	25-F84305	18-7127	239	47-803631T	18-3017	229
CERLIST DIESEL			26-41131	18-0579	239	47-85089-3	18-3057	229
1512903	18-7970	139	26-41132	18-0580	239	47-89984T4	18-3017	229
1512904	18-7934	139	26-41365A3	18-2697-1	237	47-F40065-2	18-3084	230
CHRIS-CRAFT			26-43035	18-0583	239	47-F433065	18-45003	230
1869704	18-5346	561	26-43035A4	18-2626	236	47-F436065-2	18-8903	230
16.11-01236	18-2845	571	26-66022	18-0584	239	47-F462065	18-8901	230
16.50-00074	18-0889	571	26-76384	18-8347	239	47-F694065	18-3017	229
16.50-00078	18-0891	571	26-814669A1	18-2635	237	47-F84065	18-3085	230
16.50-00162	18-0874	571	26-814669A2	18-2635	237	50-803900T	18-6441	224
16.50-00204	18-2946	571	26-816464	18-8347	239	50-803903T	18-6439	224
16.50-00232	18-0868	571	26-8164641	18-8347	239	50-819968	18-5618	224
16.50-00250	18-3876	571	26-817472	18-0500	237, 239, 442	50-8199681	18-5618	224
16.50-00259	18-3877	571	26-819396	18-0502	239	50-819968-2	18-5618	224
16.50-05756	18-0876	571	26-820645A	18-2636	237	50-8199683	18-5618	224
16.61-00042	18-5911	565	26-828627	18-8354	239	50-8199684	18-5618	224
16.69-00039	18-5314	561	26-85090A1	18-2629	442	50-820193	18-5622	224
16.69-00040	18-5338	561	26-85090A2	18-2624	236	50-820193T1	18-5622	224
16.69-00042	18-5411	561	26-99325	18-0586	239	50-898265003	18-5618	224
16.69-00049	18-5311	561	26-F318307	18-0592	239	50-F514955	18-6441	224
16.69-00050	18-5345	561	26-F346118	18-0584	239	50-F575955	18-6439	224
16.69-00051	18-5418	561	26-F40307-2	18-0503	239	700-834794A4	18-4630	233
16.69-00052	18-5385	561	26-F84307-1	18-0512	239	700-834794A5	18-4631	233
16.69-00100	18-5375	561	26-F901307-2	18-0593	239	700-834794T3	18-4629	233
16.69-00148	18-5376	561	27-19701	18-0622	236	700-834800A4	18-4632	233
16.69-00149	18-5404-1	561	27-819138-2	18-3859	235	700-834800A5	18-4633	233
16.69-0022	18-5427	561	27-819377	18-0873	236	700-834800A6	18-4634	233
16.81-06536	18-7875	183, 571	27-820438	18-3855	234	815279T2	18-5742	224
16.81-08746	18-7824-2	571	27-820500A3	18-0869	235	815279T3	18-5742	224
16.83-08758	18-7265	149, 567	27-824615	18-3857	235	815279T4	18-5744	224
16.83-90006	18-7860	568	27-824615-2	18-3857	235	815279T5	18-5744	224
FI6900165	18-5375	561	27-828316	18-0314	235	817764A2	18-5150	221
FI8308762	18-7265	149, 567	27-F178168	18-0314	235	818903A1	18-6777	224
CHRYSLER FORCE			27-F178168-1	18-0314	235	819479A1	18-6777	224
75384	18-5697	224	27-F201529-1	18-3856	234	819480A1	18-6777	224
455541	18-6762	224	27-F286529-3	18-3851	234	819762A4	18-6777	224
811902	18-5677	225	27-F307279-2	18-0115	235	819762A7	18-6777	224
817411	18-5742	224	27-F372154-1	18-0958	235	81977A8	18-6777	224
819222	18-5673	224	27-F40223	18-0869	235	81977A9	18-6777	224
820545	18-6279	224	27-F40279-1	18-0154	236	822870A1	18-6777	224
824051	18-6775	224	27-F406406	18-0915	235	827675A1	18-6286	224
1736073	18-7264	149, 578	27-F440906	18-0315	235	830179A1	18-5744	224
2279913	18-7264	149, 578	27-F476067	18-0854	236	830179A2	18-5742	224
3745414	18-7254	149, 578	27-F476529-4	18-3857	235	830250A3	18-6777	224
3745415	18-7255	149, 578	27-F481836	18-0152	235	830250T3	18-6777	224
8152792	18-5742	224	27-F513529	18-3852	234	832021A1	18-6777	224
8152794	18-5744	224	27-F523031	18-0415	236	832021A2	18-6777	224
8174111	18-5744	224	27-F658529	18-3854	234	832021T2	18-6777	224
11-35921	18-3719	238	27-F691529-1	18-3853	234	832021T4	18-6777	224
11-47411	18-3719	238	27-F694830	18-0416	236	854514A1	18-5744	224
11-826375	18-3719	238	27-F84031	18-0417	236	855654A1	18-6777	224
11-F694188	18-3719	238	27-F85154-1	18-0119	235	855654T2	18-6777	224
18495A26	18-5790	221	27-F85168-2	18-0855	235	856747T1	18-5744	224
19217A1	18-6777	224	27-F85748-2	18-0861	235	883071A1	18-5744	224
19217A5	18-6777	224	27-F85762	18-0141	235	89-803822T	18-5835	221
19291A3	18-2370	236	27-F85906	18-0960	235	89-817109A2	18-5834	221
197787-3	18-8062	229	27-F97067	18-0873	236	89-817109A3	18-5835	221
21-42990A10	18-7817	225	31-F523143	18-1113	239	89-F460917-1	18-5835	221
21-42990A7	18-7817	225	31-F523901	18-1112	239	F010790	18-7057	225
21-42990A8	18-7817	225	332-5772A5	18-5881	221	F12042-1	18-5169	221
21-42990A9	18-7817	225	332-5772A7	18-5881	221	F12044	18-5149	221
21-857005A1	18-7817	225	332-7778A12	18-5775	221	F12181-1	18-5241	221
25-20195	18-7134	239	339-7370A13	18-5186	221	F15100	18-5673	224
			339-7370B13	18-5186	221	F15110	18-5673	224
			339-832757B4	18-5186	221	F15150	18-5655	225
			398-176	18-5206	223	F15164	18-5697	224
			39-817869A1	18-39010	233	F177917	18-5803	221
			39-820457A2	18-3998	233	F178168	18-0314	235

Crusader (cont.)			GLM			Honda (Cont.)		
O.E. #	SIERRA #	PAGE #	O.E. #	SIERRA #	PAGE #	O.E. #	SIERRA #	PAGE #
98125	18-1982	607	21090	18-2163E-9	833	17105-ZY3-004	18-0390	248
98126	18-1938	608	GM			17105-ZY6-000	18-0300	248
98128	18-1984	609				17109-XY6-000	18-0382	248
201104	18-7824-2	183, 612	3701777	18-2917	907	17109-ZY3-004	18-0396	248
201104	18-7876-1	183, 647	6269358	18-3577-1	S/S to 18-3577-2	17151-ZW5-00	18-0248	248
700425	18-5899	601	6269358	18-3577-2	887	17650-921-003ZB	18-80420	242
700427	18-5898	601	6269577	18-3876	632	17650-ZW9-003	18-80408	242
705786	18-5427	592	6414989	18-7258	150	17660-ZV5-902	18-38008	242
705787	18-5345	591	10482803	18-5117	680	17670-ZW1-030GH	18-7947	139, 241
705788	18-5307	591	14077948	18-4173	903, 979	17670-ZW1-801AH	18-7948	139, 241
707125	18-5717	597	14077949	18-4164	903	17700-ZW9-010	18-81042EP-2	141, 242
1003026	18-3060	600	14089025	18-3937	903, 979	17700-ZW9-020	18-81042EP-2	141, 242
1003062	18-3046	600	14089026	18-3938	903, 979	17710-ZW9-033	18-80407	242
1003317	18-5375	593	HITACHI			19021-ZW1-003	18-3214	244
1003318	18-5411	592				129470-77200	18-6929	661
3000121	18-5389	593	LR135-105	18-6925	661	19210-881-A02	18-3245	244
3000122	18-5420	592	LR135-74	18-6928	661	19210-ZV4-013	18-3246	244
3000124	18-5318	591	LR135-74B	18-6928	661	19210-ZV4-651	18-3246	244
7057500	18-3876	612	LR180-03A	18-6929	661	19210-ZV4-651	18-3247	244-246
7142520	18-3599-1	S/S to 18-3599-2	LR180-03B	18-6929	661	19210-ZV5-003	18-3248	244-246
7142520	18-3599-2	601	LR180-03C	18-6929	661	19210-ZV7-003	18-3249	244-246
7243110	18-5107-1	596	LR180-03C	18-6929	661	19210-ZW1-003	18-3056	244
7243200	18-5443	596	S114-257	18-6880	662	19210-ZW1-B04	18-3250	244-247
9002514	18-7875	183, 612	S114-257G	18-6880	662	19210-ZW9-003	18-3100	244
R130012	18-15214	597	S114-303	18-6937	662	19210-ZW9-013	18-3100	244
RO29015	18-1938	608	S114-303A	18-6937	662	19210-ZW9-A02	18-3245	244
RP061022	18-8926	600	S114-483	18-6880	662	19210-ZW9-A31	18-32455	244
CUMMINS			S114-483A	18-6880	662	19210-ZW9-A32	18-32455	244
160596	18-3078	555	S114-559B	18-6861	478	19210-ZY3-003	18-3031	244
166758	18-3078	555	S114-682	18-6942	478	19231-ZW1-003	18-3122	244
214169	18-6952	661	S114-837	18-6831	461	19232-881-850	18-2608	247
216040	18-5982	661	S114-837A	18-6831	461	19232-ZV1-A10	18-2524	247
299670	18-7874	Obsolete	S13-68	18-6934	662	19232-ZV4-610	18-2495	247
556540	18-3078	555	S13-68A	18-6934	662	19232-ZW1-003	18-2563	247
556850	18-3078	555	S13-68C	18-6934	662	19232-ZW9-000	18-99153	245
650607	18-3077	556	S13-86	18-6934	662	19233-ZV5-000	18-2496	247
3920618	18-6952	661	HONDA			19234-881-850	18-2609	247
21601R	18-3078	555				06192-881-C00	18-3279	245
3603853RX	18-6952	661	06192-ZV1-C00	18-3278	245	19234-ZW1-B00	18-0481	245
3604234RX	18-5982	661	06192-ZV4-000	18-3280	245	19234-ZX2-C00	18-99154	245
DELCO			06192-ZV4-A00	18-4536	245	19234-ZY3-000	18-2499	247
1100077	18-6952	661	06192-ZV5-003	18-3282	245	19242-ZV5-000	18-0176	247
1100093	18-6952	661	06192-ZV7-000	18-3281	245	19242-ZW1-003	18-2565	247
1100211	18-6952	661	06192-ZW1-000	18-3283	245	19242-ZW1-B00	18-0482	245
1100274	18-6952	661	06192-ZW1-305	18-3187	244	19300-881-741	18-3629	243
1105474	18-6952	661	06192-ZW1-B01	18-3492	245	19300-881-761	18-3627	243
1105475	18-6952	661	06192-ZW9-000	18-3493	245	19300-ZV5-043	18-3630	244
1105476	18-6952	661	06192-ZW9-A30	18-3478	245	19300-ZW9-003	18-3628-1	243
1114356	18-5838	875	06192-ZX2-C00	18-3489	245	30520-PNA-007	18-7494	240
1114458	18-5838	875	06192-ZY3-000	18-3285	245	30520-PWC-003	18-23251	240
1115202	18-5433	680	06192-ZY6-000	18-3284	245	30530-P8F-A01	18-7559	243
10459244	18-6952	661	08208-0080	72-5102-2	194	30530-PPL-A01	18-7558	243
DENSO			15400-PFB-007	18-7911-1	184, 249	31200-HW1-671	18-6877	551
995435	18-6868	551	15400-PFB-014	18-7913	184, 249	31200-ZV5-013	18-6433	240
101211-3020	18-6960	703	15400-PLM-A01PE	18-7909	184, 249	31200-ZW1-004	18-15061	241
101211-3021	18-6960	703	15400-POH-305	18-7909	184, 249	31200-ZW9-802	18-6445	241
101211-3460	18-6844	703	15400-POH-305PE	18-7909	184, 249	31200-ZY6-003	18-6959	241
101211-9940	18-6849	661	15400-ZJI-004	18-7909	184, 249	31200-ZY9-003	18-6959	241
128000-4860	18-6868	551	16010-881-003	18-2482	248	31200-ZY9A-0031	18-6959	241
128000-4861	18-6868	551	16010-ST5-993	18-7785	241	31630-ZW5-003	18-6475	240
128000-4862	18-6868	551	16010-ZV4-005	18-2480	247	31630-ZY6-003	18-6476	240
128000-4863	18-6868	551	16010-ZW9-003	18-2481	247	35655-ZY3-013	18-7657	243
128000-4864	18-6868	551	16011-881-741	18-7048	243	35655-ZY3-C01	18-32153	243
228000-4550	18-6867	551	16011-ZV4-005	18-7047	243	35655-ZY6-013	18-7659	243
428000-0081	18-6873	551	16176-POA-004	18-0737	248	35655-ZY9-003	18-7658	243
DETROIT DIESEL			16201-881-850	18-2473	248	35655-ZZ5-004	18-32153	243
5574508	18-7931	139, 670	16221-ZV4-610	18-2470	248	36120-ZV5-821	18-6258	241
ELECTROLUX			16221-ZW1-000	18-2472	248	36120-ZV5-822	18-6793	241
5024/120	18-6758	956	16221-ZW9-000	18-2471	248	36120-ZY6-013	18-6745	241
KS3448/290	18-6790	956	16900-SA5-004	18-7786	241	36120-ZY9-003	18-6743	241
FRAM			16900-SR3-004	18-7720	241	37500-PNB-003	18-25200	243
CCS 1136	18-7935	139, 670	16901-ZY3-003	18-79909	242	37510-PNB-003	18-25201	243
			16910-GB2-005	18-7712	242	37830-PGK-A01	18-7552	243
			16910-ZV4-015	18-8226	242	41107-ZV5-00-00	18-6165A	250
			16911-ZY3-010	18-79908	242	41107-ZW1-003ZA	18-6011	250
			16977-ZV5-900	18-80406	242	41107-ZW1-003ZA	18-6011A	250
			16977-ZV5-A00	18-80400	242	41107-ZW1-003ZA	18-6241	250

Honda (Cont.)			Jabsco (Cont.)			Johnson/Evinrude (Cont.)		
O.E. #	SIERRA #	PAGE #	O.E. #	SIERRA #	PAGE #	O.E. #	SIERRA #	PAGE #
41109-ZW1-003	18-6068	249	21676-0001	18-45712	556	881150K1	18-9895	202
90508-ZW1-003	18-3200	250	22405-0001	18-3076	555	KAWASAKI		
90752-ZV4-650	18-3268	244	22799-0001	23-2003	112	21163-3715	18-6873	551
90752-ZV5-003	18-3270	244	2877-0001	18-3075	555	21163-3719	18-6873	551
90752-ZV7-000	18-3269	244	3101-0000	18-3125	556	21163-3720	18-6904	551
90752-ZW1-B02	18-3271	244	4528-0001	18-3079	555	21163-3720	18-6904	551
90752-ZW9-A30	18-3022	245	4568-0001	18-3075	555	21174-3703	18-6875	552
90752-ZW9-A30	18-3025	245	4598-0001	18-3021	556	K61021-208A	72-5103-2	193
90752-ZY3-003	18-3273	244	673-0001	18-3080	555	MALIBU		
91051-ZW1-003	18-1156	249	673-0003	18-3036	555	S556162	18-32152	615
91053-ZW1-003	18-1158	249	6760-0001	18-3304	555	MALLORY		
91057-ZW1-003	18-1157	249	836-0001	18-3078	555	670	18-26800	165
91251-ZW1-003	18-0583	250	836-0003	18-3037	555	5421	18-35101	647
91251-ZW1-B04	18-1820	245	920-0001	18-3077	555	29217	18-29717	644
91252-935-004	18-8298	248	920-0003	18-3038	555	29349	18-26815	165
91252-ZV1-003	18-3288	248	92700-0060	18-2005	556	29716	18-29716	644
91252-ZW1-003	18-2002	250	JOHNSON PUMP			54212	18-35102	647
91253-ZW1-003	18-2054	250	01-42401	18-3303	557	29440M	18-29720	644
91254-ZW1-003	18-0522	250	09-1026B	18-3080	556	4110M	18-34110	647
91255-ZW1-003	18-2053	250	09-1026B-1	18-3080	965	4140M	18-34140	647
91301-ZG3-000	18-71335	245	09-1026B-9	18-3036	556	5110MFI	18-34120	647
91353-ZW1-003	18-7198	250	09-1026B-9	18-3080	556	9-26103	18-5339-1	685, 869
91356-ZY3-003	18-8299	248	09-1027B	18-3081	556	9-29418	18-5397	679, 864
HP2	72-5103-2	193	09-1027B-9	18-3020	557	9-34081	18-7489	648
HP2	72-5103-3	193	09-1028B	18-3077	556	9-72152	18-2163E-9	833
HP2	72-5103-4	193	09-1028B-9	18-3038	557	YL512CV	18-5309-1	165, 595, 622
HP2	72-5103-5	193	09-1029B	18-3078	556	YL554CV	18-5312-1	165, 622, 684, 869
HP2	72-5103-7	193	09-1029B-9	18-3037	556	YL566AV	18-5339-1	165, 685, 869
HP4	72-5100-2	193	09-102BB	18-3277	964	YL567EV	18-26104-1	165, 685, 869
ILMOR			09-45589	18-3076	557	YL579AV	18-26110-1	165, 685, 869
550022689	18-9558-2	190	09-45589	18-3510	557	YL624AV	18-5313-1	165, 684
550046126	18-9558-4	190	09-45825	18-3089	557, 965	YL624BV	18-5316-1	165, 685, 869
MV8V1021	18-57824	183	09-801B	18-3075	556	YL624MW	18-5313-1	564, 595, 622, 869
S556162	18-32152	615	09-802-B	18-3304	616	YL648AV	18-26111-1	165, 683
INDMAR			09-806B	18-3079	556	YL673AV	18-5315-1	165, 684, 869
573001	18-5603	615	09-808B	18-3076	557	YL700AV	18-26107-1	165
575010	18-6288	615	09-810B	18-45713	557	YLM512CV	18-5495-2	164, 868, 942
575011	18-5984	615	09-812B	18-3306	556	YLM554CV	18-5489-2	164, 868
575014	18-6451	615	09814B	18-45712	557	YLM566AV	18-26311-2	164
685001	18-3587-1	616	09-819B	18-3275	556	YLM567CV	18-5496-2	164, 684, 868
685011	18-3586-1	616	10-24228-1	18-3586-1	557	YLM624BV	18-5498-2	164, 685, 869, 942
751007	18-5303	613	10-24232-1	18-3587-1	557	YLM673AV	18-5486-2	164, 868
755017	18-5345	613	3298-0000	18-3125	557	YLM673AV	18-5486-2	164, 868
755021	18-5277	613	JOHNSON/EVINRUDE			YLM676AV	18-5487-2	164, 684, 868
872003	18-9555-2	190	302035	18-71336	284, 285	YLM700AV	18-26310-2	164
872004	18-9555-4	190	302325	18-1597	284, 285	MANDO		
872005	18-9554-2	190	321129	18-1827	285	A000B0341	18-6843	994
872006	18-9554-4	190	324640	18-4578	285	TA000B0341	18-6843	994
872025	18-8779	183, 616	324641	18-4551	285	MARINE POWER		
50-1001	18-7824-2	183	325040	18-99156	285	402001	18-6299	618
501022S	18-8623	616	328725	18-1596	285	612011	18-1985	779
53-2009	18-1907	569, 586, 609, 642,	328754	18-2147	284, 285	0100-000	18-2434	558
		569, 586, 609, 642,	331130	18-3026	285	0170-000	18-5603	618
		779, 898, 970	331894	18-3566	289	0991-110	18-1898	569, 586, 607, 642,
53-2018	18-1907	569, 586, 609, 642,	338485	18-4579	284, 285			776, 897, 969
		779, 898, 970	338486	18-4549	284, 285	0992-593	18-1939	569, 586, 609, 642,
S525009	18-31104	618	338601	18-1826	284			779, 898, 970
S556003	18-37824	618	339720	18-4569	279	0994-000	18-8536	618
S556050	18-42608	616	340811	18-1825	285	McCULLOCH		
S556162	18-32152	615	342370	18-71340	285	1340135	18-5153	354
S985009	18-43017	616	346865	18-71338	284	36550135	18-5153	354
JABSCO			349354	18-1824	284	38850115	18-5241	254
1210-0001	18-3081	555	353590	18-1595	284	75101A	18-5153	354
1210-0003	18-3020	556	353690	18-1821	285	MERCURY MARINE		
124310-46090	18-3075	555	354578	18-9084	284	10-14834	18-2375	435, 846
13554-0001	18-3306	555	354580	18-1822	284	10-14834A1	18-2375	435, 846
14510-46090	18-3075	555	354580	18-1822	284	10-14834A1	18-23751-9	435, 846
17636-0001	18-45712	556	355169	18-5701	284	10-20259	18-2244	435, 846
17935-0001	18-3275	555	355209	18-5703	284	10-20518	18-2303	836
17937-0003	18-3038	555	360347	18-4571	279	10-28634	18-2244	435, 846
18653-0001	18-45713	555	586768	18-6826	266	10-28634A1	18-2244	435, 846
18838-0001	18-3046	555	5005034	18-3753	329			
18838-0001	18-3060	964, 994	5005831	18-6815	260			
18948-0001	18-3047	555	5007554	18-4568	279			
18948-0001	18-3061	964	5007770	18-1823	284			
			5008967	18-4539	277			
			5036972	18-6945	266			

Mercury Marine (Cont.)			Mercury Marine (Cont.)			Mercury Marine (Cont.)		
O.E. #	SIERRA #	PAGE #	O.E. #	SIERRA #	PAGE #	O.E. #	SIERRA #	PAGE #
10-28668	18-3229	735	12-191833	18-2945	425, 812	17-44167A1	18-2397	852
10-30206	18-2361	813	12-20260	18-2945	425, 812	17-45735	18-2152	852
10-30720	18-3226	735	12-22388	18-4275	425	17-45738	18-2151	852
10-31700	18-2163	833	12-23245	18-2948	425, 812	17-815953	18-2395	852
10-31700	18-2163E-9	833	12-25410	18-0203	813	17-815953A1	18-2395	852
10-32470	18-6245	441	12-25945	18-4275	425	17-815953T1	18-2464	850
10-36289	18-3729	813	12-29245	18-4275	425	17-828507 1	18-15129	372
10-43749	18-8410	780	12-29395	18-4267	813	17-85056	18-2462	850
10-44387	18-8411	780	12-31060	18-7180	449, 858	17-8M0020941	18-2357	841
10-45590	18-2170	832	12-31211	18-3714	439, 847	17-8M0084681	18-2357	841
10-67373	18-3197	735, 813	12-31211A2	18-3714	439, 847	17-8M0100263	18-2357	841
10-76156	18-3197	735, 813	12-31211A3	18-3714	439, 847	17-99207	18-2463	850
10-79953	18-2244	435, 846	12-31211Q03	18-3714	439, 847	18-52457	18-2848	808
10-79953A2	18-2244	435, 846	12-31266	18-2340	813	18-524571	18-2848	808
10-79953Q04	18-2244	435, 846	12-32733	18-4275	425	19-14842	18-2465-9	850
10-79953Q2	18-2244	435, 846	12-32834	18-0681	813	19-148421	18-2465-9	850
10-8053432	18-8402	700	12-34961	18-9805	207	19-32652	18-4272	913
10-8053433	18-8403	Obsolete	12-35935	18-0203	813	19-42682	18-4273	813
10-805763	18-2361	813	12-36001	18-4270	813	19-47579	18-3232	853
10-8083434	18-8404-1	700	12-38753	18-4275	425	19-47591	18-3232	853
10-816601	18-3230	813	12-45176	18-4858-9	425	19-815951	18-2466-9	850
10-853163	18-2361	813	12-45810	18-3712	832	21-42990A10	18-7817	382
10-86801	18-1706	831	12-49221	18-2948	425, 812	21-42990A7	18-7817	382
10-8M0084649	18-2170	832	12-492211	18-2948	425, 812	21-42990A8	18-7817	382
10-97934	18-3729	813	12-77674	18-2316	813	21-42990A9	18-7817	382
10-97934A1	18-2141	813	12-77987	18-4220	440	21-806118	18-33800	709
10-98794	18-3231	813	12-77987A1	18-4220	440	21-857005A1	18-7817	382
10-F50109	18-2244	435, 846	12-815472	18-0318	813	22-13563A3	18-8076	386
11-13439-1	18-3721	813	12-824793	18-4275	425	22-13563A6	18-8091	386
11-20361	18-3722	438, 849	12-835467	18-4220	440	22-13563A7	18-8091	386
11-21298	18-3721	438, 849	12-8354671	18-4220	440	22-13563Q3	18-8076	386
11-22178	18-3721	438, 849	12-835467Q01	18-4220	440	22-13563Q7	18-8091	386
11-22339	18-3713	832	12-855682-2	18-9078	440	22-13563T3	18-80410-1	386, 457
11-24648	18-3721	438, 849	12-86645	18-2560	425	22-13563T7	18-8091	386
11-29241	18-3721	438, 849	12-866451	18-2560	425	22-14213M	18-8075	386
11-33962	18-3721	438, 849	12-88263	18-1186	406	22-14213Q	18-8075	386
11-34932	18-3720	438, 849	12-8M0042641	18-4267	813	22-16610M	18-8084	386
11-34933	18-3721	438, 849	12-8M2001219	18-0681	813	22-16951A1	18-4218	783
11-35888	18-3722	438, 849	12-92647M	18-4233	440	22-16951Q1	18-4218	783
11-35921	18-3719	436, 842	12-92721	18-2343	813	22-16951T1	18-4218	783
11-36084	18-3713	832	12-93416	18-0681	813	22-22175	18-7413	449, 859
11-39823	18-3785	847	12-934161	18-0681	813	22-30139	18-4263	780
11-39907	18-3785	847	13-888363-2	18-9077	440	22-32802	18-4263	780
11-42633	18-2346	842	14-17460	18-2298	438, 843	22-328021	18-4263	780
11-45592	18-3723	438, 849	14-18323	18-2298	438, 843	22-328022	18-4263	780
11-46355	18-3721	438, 849	14-31210	18-3200	439, 847	22-32803	18-4264	780
11-47411	18-3719	436, 842	14-34817	18-3788-9	847	22-33198	18-4258	643, 780
11-52707	18-3700	439	14-52833	18-2299	438, 843	22-33198A1	18-4258	643, 780
11-52707A1	18-3701	439, 847	14-76281	18-3204	439	22-36305	18-8216	783
11-52707A2	18-3701	439, 847	14-79447	18-2299	438, 843	22-36305T	18-8216	783
11-52707Q1	18-3701	439, 847	14-816629	18-3200	439, 847	22-36392	18-8111	780
11-54034	18-3785	847	14-816629Q	18-3200	439, 847	22-41622	18-4258	643, 780
11-69578	18-3704	439	14-F697140	18-3200	439, 847	22-41622	18-4258	643, 780
11-69578A1	18-3702	439	15-23097A1	18-2293	826	22-424254	18-8958	382
11-69578Q1	18-3702	439	15-31535A1	18-2284	826	22-42861	18-4265	780
11-69578T1	18-3702	439	15-32563A1	18-2282	826	22-428611	18-4265	780
11-805092	18-3783	847	15-33143A1	18-2295	826	22-46754	18-4258	643, 780
11-805092T	18-3783	847	15-35931A1	18-2285	826	22-63186	18-8054	145, 385
11-805093	18-3786	847	15-35980A1	18-2292	826	22-63187	18-8055	145, 385
11-826375	18-3719	436, 842	15-36178A02	18-2293	826	22-64426	18-4218	783
11-8267089	18-3722	438, 849	15-36178A1	18-2293	826	22-67892	18-2375	435, 846
11-82671015	18-3721	438, 849	15-39899A1	18-2293	826	22-67892A05	18-2375	435, 846
11-82671127	18-3785	847	15-42637A1	18-2294	826	22-67892A06	18-2375	435, 846
11-827614	18-3700	439	15-45691A1	18-2283	826	22-67892A1	18-2375	435, 846
11-859116	18-3721	813	15-45811	18-2296	826	22-67892A1	18-23751-9	435, 846
11-859131	18-3783	847	15-47397A1	18-2285	826	22-806608A02	18-4226	783
11-862907	18-3786	847	15-57007A1	18-2295	826	22-806608A1	18-4226	783
11-863332	18-3728	813	15-71013	18-2296	826	22-806926	18-4227	783
11-88228	18-3703	439	15-8M0063267	18-2294	826	22-806926A1	18-4224	783
11-88462	18-2460	846	17-14872	18-2393	852	22-807155	18-4461	643, 783
11-95702	18-3721	438, 849	17-14872A1	18-2463	850	22-81042M	18-8075	386
11-97522	18-3713	832	17-14873	18-2394	852	22-816856T2	18-80412	386
11-99298	18-3728	813	17-14873A1	18-2462	850	22-818994	18-8957	382
11-F694188	18-3719	436, 842	17-30632	18-2357	841	22-8189941	18-8957	382
12-12577	18-1191	432	17-35973	18-3227	393, 735	22-841908	18-4263	780
12-13171	18-4220	440	17-44166	18-2396	852	22-861187	18-4265	780
12-19183	18-2945	425, 812	17-44166T1	18-2461	850	22-862210	18-4227	783
12-191832	18-2945	425, 812	17-44167	18-2397	852	22-862210A01	18-4224	783

Mercury Marine (Cont.)			Mercury Marine (Cont.)			Mercury Marine (Cont.)		
O.E. #	SIERRA #	PAGE #	O.E. #	SIERRA #	PAGE #	O.E. #	SIERRA #	PAGE #
22-87238	18-4218	783	23-818469001	18-1317	795	25-33466	18-7164	449, 858
22-87543	18-4264	780	23-818471	18-1316	795	25-33466	18-7164	449, 858
22-88847A1	18-2460	846	23-818471001	18-1316	795	25-33504	18-7170	449, 858
22-8M0001721	18-8956	382	23-818473	18-1315	Obsolete	25-35027	18-7117	449, 858
23-11992	18-1327	795	23-818473001	18-1315	Obsolete	25-35029	18-7121	449, 858
23-11992001	18-1327	795	23-818477	18-1314	Obsolete	25-35276	18-7135	449, 858
23-15960	18-1300	795	23-853853	18-1148	795	25-35480	18-7411	449, 859
23-15961	18-1308	795	23-853853002	18-1148	795	25-35984	18-7169	449, 858
23-1596110	18-1309	795	23-853853A1	18-1148	795	25-36318	18-7440-1	449, 859
23-1596120	18-1341	795	23-85669	18-1317	795	25-36390	18-7410	449, 859
23-1761515	18-0208	826	23-85677	18-1329	795	25-38933	18-7120	449, 858
23-1761516	18-0210	826	23-85684	18-1305	795	25-39572	18-7151	449, 858
23-1761517	18-0212	826	23-85686	18-1315	Obsolete	25-39695	18-7464	449, 859
23-1761518	18-0214	826	23-85691	18-1333	795	25-45254	18-7166	449, 858
23-1761519	18-0216	826	23-85698	18-1300	795	25-45710	18-7198	449, 858
23-1761520	18-0218	826	23-85701	18-1308	795	25-45711	18-7174	449, 858
23-1761522	18-0222	826	23-85704	18-1309	795	25-47254	18-7961	449, 859
23-1761523	18-0224	826	23-85705	18-1341	795	25-47386	18-7411	449, 859
23-1761524	18-0226	826	23-85715	18-1317	795	25-47632	18-7146	449, 858
23-1761526	18-0230	826	23-85718	18-1316	795	25-48171	18-7168	449, 858
23-29804	18-3109	393, 734	23-85726	18-1334	795	25-48451	18-7159	449, 858
23-29804T	18-3109	393, 734	23-85726001	18-1334	795	25-53421	18-7177	449, 859
23-30617A1	18-2154	843	23-888690	18-9075	440	25-54029	18-0858	449, 858
23-30617A2	18-2154	843	23-888690-1	18-9076	440	25-54030	18-7467	449, 859
23-32632	18-3236	813	23-89574	18-2701	853	25-55801	18-7445	449, 859
23-34464	18-1317	795	23-89574	18-2701-04	853	25-59712	18-7177	449, 859
23-37428A1	18-2155	435	23-90203	18-2336	853	25-60342A1	18-2291	851
23-43045	18-0568-9	425	23-99291	18-2702-04	853	25-60342A2	18-2291	851
23-43293	18-1339	795	23-99291	18-2702-1	853	25-62384	18-7414	449, 859
23-43293T	18-1339	795	23-99291T	18-2702-04	853	25-62700	18-0860	449, 858
23-44165	18-4288	853	23-99291T	18-2702-1	853	25-62702	18-7413	449, 859
23-45736	18-2701	853	24-17057A1	18-1234	800	25-62704	18-7116	449, 858
23-45736	18-2701-04	853	24-17997A1	18-2715	833	25-62705	18-7105	449, 858
23-47392	18-2336	853	24-29340A1	18-6506	376	25-62706	18-7102	449
23-48351	18-1329	795	24-29340T1	18-6506	376	25-62817	18-7175	449, 858
23-49163	18-1315	Obsolete	24-30893	18-2348	841	25-64068	18-7145	449, 858
23-49168	18-1334	795	24-38191	18-4161	791	25-64966	18-7415	449, 859
23-49171	18-1333	795	24-46312	18-4252	852	25-65936	18-7143	449, 858
23-52211	18-1300	795	24-801879	18-1234	800	25-67202	18-7107	449, 858
23-52221	18-1308	795	24-801879T	18-1234	800	25-67675	18-7164	449, 858
23-52224	18-1309	795	24-811554	18-1234	800	25-69202	18-7419	449, 859
23-52225	18-1341	795	25-16524	18-7421	449, 859	25-70937	18-7169	449, 858
23-52242	18-1329	795	25-20081	18-7151	449, 858	25-801334436	18-7168	449, 858
23-52261	18-1317	795	25-20195	18-7134	858	25-803513007	18-76695	449
23-52264	18-1316	795	25-201951	18-7134	858	25-805726	18-7188	449, 859
23-52270	18-1308	795	25-20365	18-7135	449, 858	25-806609	18-7165	449, 858
23-52273	18-1309	795	25-20587	18-7168	449, 858	25-8071341	18-1508	741
23-52274	18-1341	795	25-20633	18-7116	449, 858	25-807149	18-7163	449, 858
23-52928	18-3109	393, 734	25-20679	18-7153	449, 858	25-809086	18-0715	378
23-55419A1	18-2155	435	25-20826	18-7459	449, 859	25-818573	18-7400	417
23-61290	18-2701	853	25-20863	18-7152	449, 858	25-82275M	18-0298	449
23-61290	18-2701-04	853	25-21720	18-7168	449, 858	25-82289M	18-0299	449
23-61291	18-2336	853	25-21836	18-7420	449, 859	25-823683	18-7414	449, 859
23-67370	18-2349	846	25-22174	18-7116	449, 858	25-843315	18-7114	449, 858
23-67484	18-1340	795	25-23145	18-7114	449, 858	25-846356	18-7164	449, 858
23-69884	18-1334	795	25-25439	18-7153	449, 858	25-846357	18-7158	449, 858
23-69887	18-1333	795	25-26543	18-0175	449, 858	25-846361	18-7464	449, 859
23-77631A2	18-2155	435	25-26722	18-7115	449, 858	25-85148	18-7116	449, 858
23-79373A1	18-2622	832	25-26802	18-7180	449, 858	25-853220	18-7163	449, 858
23-801793	18-1311	795	25-26834	18-7168	449, 858	25-85491A87	18-4325	414
23-801801	18-1321	Obsolete	25-26855	18-7155	449, 858	25-85549	18-7956	449
23-801803	18-1320	795	25-27018	18-7173	449, 858	25-85594	18-7100	449
23-805041A2	18-2622	832	25-29439	18-7156	449, 858	25-861844	18-7167	449, 858
23-806036A1	18-3760	832	25-29845	18-7103	449, 858	25-861844	18-7961	449, 859
23-807073	18-4288	853	25-29976	18-7157	449, 858	25-87400A2	18-2649	851
23-811858	18-1337	795	25-30224	18-7173	449, 858	25-882613	18-7121	449, 858
23-811858001	18-1337	795	25-30271	18-7426	449, 859	25-896523	18-7176	449, 858
23-815921A10	18-2353	843	25-30529	18-7171	449, 858	25-897536	18-7113-9	390
23-815921A17	18-2353	843	25-30613	18-7158	449, 858	25-8M0027717	18-7195	449, 859
23-815921A21	18-2353	843	25-31305	18-7172	449, 858	25-8M2000816	18-7411	449, 859
23-815921A6	18-2353	843	25-31534	18-7159	449, 858	25-8M2000926	18-7180	449, 858
23-815921A8	18-2353	843	25-31986	18-7160	449, 858	25-94288	18-7474	449, 859
23-815950	18-2341-1	853	25-32424	18-7162	449, 858	25-97387	18-7449	449, 859
23-8159501	18-2341-1	853	25-32507	18-7127	858	25-98277	18-7113-9	390
23-815950Q01	18-2341-1	853	25-32509	18-7165	449, 858	25-F24342	18-7116	449, 858
23-816583	18-3222	735	25-32546	18-7161	449, 858	25-F455342	18-7174	449, 858
23-818465	18-1300	795	25-33145	18-7162	449, 858	25-F461342	18-7165	449, 858
23-818469	18-1317	795	25-33465	18-7163	449, 858	25-F50342-1	18-7413	449, 859

Mercury Marine (Cont.)			Mercury Marine (Cont.)			Mercury Marine (Cont.)		
O.E. #	SIERRA #	PAGE #	O.E. #	SIERRA #	PAGE #	O.E. #	SIERRA #	PAGE #
25-F523555	18-7467	449, 859	26-49947	18-1211	800	26-89238	18-2014	857
25-F53795-1	18-7153	449, 858	26-54799	18-1213	800	26-89238A1	18-2652	855
25-F702736	18-7114	449, 858	26-55682	18-2050	857	26-89238A2	18-2655	443
25-F74305	18-7176	449, 858	26-55682A1	18-2653	443	26-896600	18-0560	446
25-F7848342	18-7105	449, 858	26-56397	18-0527	446, 857	26-897153	18-2010	446, 857
25-F84305	18-7127	858	26-56788	18-2008	446, 857	26-897154	18-2006	446, 857
26-11973	18-1213	800	26-56866	18-1230	800	26-8M0050563	18-4024	800
26-12224	18-2076	857	26-56868	18-0528	800	26-90562	18-2011	857
26-14077	18-2077	857	26-58094	18-0518	800	26-90925	18-0864	800
26-14240	18-0519	446, 800, 857	26-58094	18-4023	800	26-94038	18-2007	857
26-16709A1	18-2643	854	26-58203	18-1211	800	26-96503	18-2056	857
26-16709A2	18-2643	854	26-62818	18-0529	446, 857	26-965031	18-2056	857
26-16977	18-2013	857	26-66022	18-0584	446	26-97335	18-1213	800
26-16977	18-2026	857	26-66303	18-0595	446	26-97530	18-0172	446, 857
26-20070	18-2004	446, 857	26-66303A1	18-2627	441	26-97664	18-4024	800
26-20079	18-2016	857	26-67388	18-0578	800, 857	26-976641	18-4024	800
26-20465	18-2013	857	26-67863	18-4022	800	26-99325	18-0586	446
26-20465	18-2026	857	26-69188	18-2051	857	26-F694305	18-2014	857
26-21642	18-2055	857	26-69189	18-2052	857	26-F697118	18-2076	857
26-23300	18-2011	857	26-70019	18-2002	857	26-F697555	18-2077	857
26-23517	18-2015	857	26-70081	18-2053	446, 857	27-11338	18-2513	420
26-24590	18-2048	857	26-72564	18-0518	800	27-11338A85	18-4319	414
26-25329	18-0514	425	26-72564	18-4023	800	27-11338A88	18-4319	414
26-25776	18-2009	857	26-72785	18-0531	446, 857	27-11977	18-4408	802
26-25837	18-2016	857	26-75413	18-0518	800	27-11977A88	18-4388	804
26-27163	18-2019	857	26-75413	18-4023	800	27-11977A92	18-4388	804
26-29476	18-2016	857	26-75624	18-0518	800	27-11986	18-3879	807
26-29595	18-2011	857	26-75624	18-4023	800	27-11987	18-4408	802
26-29677	18-3110	393, 734	26-75982	18-4022	800	27-11988	18-0311	810
26-30530	18-0515	446, 857	26-75988	18-4022	800	27-11999	18-2845	810
26-30550	18-2002	446	26-76384	18-2054	857	27-13218	18-3877	807
26-30696	18-8308	446	26-76384	18-8347	446	27-13461A88	18-4340	413
26-30727	18-2007	857	26-76868	18-2002	446, 857	27-13461A89	18-4340	413
26-30900	18-8310	446	26-76868A04	18-2645	855	27-13461A90	18-4340	413
26-30913	18-0516	446, 857	26-76868A1	18-2645	855	27-13461A99	18-4340	413
26-31249	18-2009	857	26-76868A2	18-2645	855	27-13687	18-3877	807
26-31489	18-2007	857	26-77066A1	18-2628	442	27-13709	18-3878	807
26-31507	18-2013	857	26-77634	18-2014	857	27-13709T	18-3878	807
26-31507	18-2026	857	26-79831	18-2055	857	27-13865	18-1237	805
26-32080	18-2003	857	26-79831	18-2055	857	27-138651	18-1237	805
26-32121	18-2017	857	26-79831A1	18-2654	443	27-13937-6	18-0320	420
26-32511	18-2049	857	26-79884	18-2013	857	27-139581	18-2621	420
26-32511A1	18-2648	855	26-79884	18-2026	857	27-14241	18-0322	812
26-32911	18-0517	445, 857	26-80239M	18-2730-9	425	27-14247	18-0405	805
26-33144	18-2014	857	26-814622	18-1211	800	27-142471	18-61513	806
26-33144A1	18-2652	855	26-814669A2	18-2635	442	27-14247T1	18-61513	806
26-33144A2	18-2652	855	26-814754	18-8305	425	27-14250	18-0976	810
26-34217	18-0518	446, 800	26-81607M	18-2731	425	27-14318 3	18-0323	423
26-35025	18-2017	857	26-816464	18-8347	446	27-14318-2	18-0323	423
26-36054	18-2003	857	26-8164641	18-2054	857	27-146972	18-0644	420
26-36143	18-2094	812	26-8164641	18-8347	446	27-14697A87	18-4339	413
26-36556	18-0563	425, 855	26-816575A1	18-2646-1	443	27-14765	18-25001	810
26-36557	18-0521	425	26-816575A2	18-2599	441, 832	27-14901	18-0466	805
26-36557A1	18-3110	393, 734	26-816575A3	18-2646-1	443	27-14901A1	18-0466	805
26-37259	18-2056	857	26-816575A4	18-8382	444	27-15172	18-0324	419
26-38970	18-3110	393, 734	26-816575A5	18-2642	442	27-15172-3	18-0324	419
26-41131	18-0579	446	26-821309	18-3013	393	27-151724	18-0324	419
26-41132	18-0580	446	26-821310	18-3014	393	27-167371	18-0645	420
26-41365	18-0581	446	26-821928	18-0585	446	27-17145	18-0868	806
26-41365A3	18-2697-1	444	26-821947	18-1233	800	27-17467	18-0664	810
26-41953	18-2016	857	26-8219471	18-1233	800	27-18272	18-0881-1	782
26-42102	18-2728	425	26-82234M	18-0297	446	27-18307-1	18-0643	422
26-421021	18-2728	425	26-82257M	18-0267	446	27-183076	18-0643	422
26-42750	18-1213	800	26-82389A	18-2003	857	27-187851	18-3861	417
26-43034A1	18-2626	441	26-830749	18-2430	425	27-187853	18-3861	417
26-43034A2	18-2626	441	26-830749	18-24301-9	425	27-18785T	18-3861	417
26-43034A3	18-2626	441	26-830749A01	18-2725	444	27-18786-1	18-3871	417
26-43035	18-0583	446	26-84813M	18-0554	446	27-188891	18-0624	420
26-43035A4	18-2626	441	26-85090A1	18-2629	442	27-18937	18-3828	417
26-43036	18-0522	446, 857	26-85090A2	18-2624	441	27-18937M	18-3828	417
26-43993	18-0523	446, 857	26-85107	18-0537	446, 857	27-19050	18-0642	421
26-45577	18-2944	812	26-854017M	18-0296	446	27-190502	18-0642	421
26-455771	18-2944	812	26-864319	18-3289	812	27-190503	18-0642	421
26-45587	18-0525	446, 857	26-88397A1	18-2644	854	27-190505	18-0642	421
26-46021	18-2009	857	26-88416	18-2094	812	27-190506	18-2735	422
26-48443	18-0526	446, 857	26-888483	18-0564	446	27-19138	18-3804	417
26-49131	18-4022	800	26-892361	18-2009	857	27-19138M	18-3804	417
26-49154	18-1233	800	26-89237	18-2056	857	27-19202	18-2559	423

Mercury Marine (Cont.)			Mercury Marine (Cont.)			Mercury Marine (Cont.)		
O.E. #	SIERRA #	PAGE #	O.E. #	SIERRA #	PAGE #	O.E. #	SIERRA #	PAGE #
27-19204-2	18-2558	423	27-39164	18-3881	807	27-430341	18-2563	424
27-19206	18-0633	419	27-39316	18-0371	420	27-43047	18-2565	424
27-192061	18-0633	419	27-39401	18-0333	422	27-430471	18-2565	424
27-19315	18-3877	807	27-39402	18-0334	422	27-430472	18-2565	424
27-194541	18-2593	424	27-39623	18-2827	424	27-43186A1	18-4381	805
27-19551	18-2824	424, 812	27-39625	18-2828	424	27-43337	18-2713	422
27-19552	18-2841	424	27-39915	18-2819-1	782	27-433371	18-2713	422
27-19553	18-2823	424, 812	27-39923	18-1210	S/S to 18-1210-1	27-433372	18-2713	422
27-19701	18-0622	424	27-39923	18-1210-1	782, 809	27-433373	18-2713	422
27-22023	18-2572	419	27-41245-1	18-3872	417	27-433374	18-2713	422
27-25848	18-2568	419	27-41246-1	18-3862	417	27-43337A1	18-2713	422
27-25849	18-2569	420	27-41382	18-2837	422	27-43777	18-2810	422
27-25851	18-2570	420	27-41417	18-2710	420	27-437771	18-2810	422
27-26891	18-2800	419	27-414171	18-2710	420	27-437772	18-2810	422
27-27936	18-0870	421	27-414172	18-2710	420	27-43779	18-2809	423
27-279361	18-0870	421	27-41418	18-2712	420	27-437791	18-2809	423
27-30603	18-2914	425, 812	27-414181	18-2712	420	27-437792	18-2809	423
27-30604	18-2915	425, 812	27-41449	18-0633	419	27-43779A87	18-4326	412
27-30803	18-0385	422	27-414491	18-0633	419	27-443281	18-2943	421
27-31402	18-2571	419	27-41475	18-2717	422	27-443282	18-2943	421
27-31436	18-2837	422	27-414751	18-2717	422	27-443283	18-2943	421
27-31439	18-2836	421	27-414752	18-2717	422	27-443284	18-2943	421
27-31557	18-0385	422	27-414753	18-2717	422	27-45088	18-0373	420
27-32433	18-2914	425, 812	27-414754	18-2717	422	27-45588	18-2622	832
27-32434	18-2915	425, 812	27-414755	18-2717	422	27-45748	18-0385	422
27-32438	18-2801	424	27-414756	18-2717	422	27-45821	18-2614	814
27-32769	18-2823	424, 812	27-414757	18-2717	422	27-45821	18-2820	811
27-32770	18-2824	424, 812	27-414758	18-2717	422	27-46110	18-0942	421
27-32771	18-2825	424, 812	27-41499	18-2716	422	27-46110A1	18-4353	415
27-32816	18-2896-1	782, 810	27-414991	18-2716	422	27-46110A2	18-4353	415
27-32910	18-0356	807	27-414992	18-2714	422	27-46110A72	18-4353	415
27-33121	18-2830-1	809	27-414993	18-2714	422	27-46233	18-2836	421
27-33179	18-2917	808	27-414994	18-2714	422	27-46401	18-2830-1	809
27-331791	18-2552	808	27-414995	18-2714	422	27-46401A1	18-4396	803
27-331792	18-2552	808	27-41499A87	18-4334	412	27-46820	18-0418	643, 782
27-33395	18-2949	782, 810	27-41610	18-0467	808	27-46820A1	18-4397	803
27-33395A1	18-4394	802	27-41636A1	18-4381	805	27-47453	18-3881	807
27-33395A2	18-4394	802	27-41670-3	18-0336	422	27-47453A1	18-4389	804
27-33918	18-0398	809	27-41670-5	18-0336	422	27-47510	18-2553	808
27-33956	18-0327	811	27-41811	18-0672	782	27-47510Q	18-2553	808
27-34041	18-0347	810	27-41812	18-2554	808	27-47590	18-2831	808
27-34042	18-0346	810	27-41812Q	18-2554	808	27-475901	18-2831	808
27-34043	18-2845	810	27-41813	18-0897	782, 809	27-47644	18-0342	812
27-34208	18-0328	811	27-41899M	18-2785	444	27-47644	18-0342	812
27-34209	18-0329	811	27-42178	18-0633	419	27-476441	18-0342	812
27-34213	18-0889	807	27-42206	18-2559	423	27-48042	18-0885-1	782
27-34213A1	18-4375	806	27-42457A1	18-4377	806	27-48043	18-2832-1	809
27-34213A2	18-4375	806	27-42631	18-2919	425, 812	27-48043	18-2832-1-9	782, 809
27-34216	18-0887	810	27-426311	18-2919	425, 812	27-480431	18-2832-1	782, 809
27-34273	18-3880	807	27-42744	18-3879	807	27-480431	18-2832-1-9	782, 809
27-342731	18-3880	807	27-43004009	18-2741	422	27-48164	18-2802	419
27-34274	18-3881	807	27-430041	18-2741	422	27-481641	18-2802	419
27-34278	18-3876	807	27-430042	18-2741	422	27-48330	18-3876	807
27-34486	18-0874	808	27-430043	18-2741	422	27-48399	18-0462	808
27-344861	18-0874	808	27-430045	18-2741	422	27-48713	18-0982-1	423
27-344863	18-0874	808	27-430047	18-2741	422	27-48818	18-2844	808
27-34502	18-0905	813	27-43004A86	18-4336	412	27-488181	18-2844	808
27-34614	18-2570	420	27-43004A90	18-4336	412	27-48818Q1	18-2844	808
27-34891	18-0874	808	27-43004A99	18-4336	412	27-49104	18-3877	807
27-34895	18-0976	810	27-430051	18-2740	421	27-49107	18-0348	805
27-34896	18-0891	811	27-430052	18-2740	421	27-49109	18-0980	810
27-34897	18-0891	811	27-430053	18-2740	421	27-49110	18-0903	811
27-34898	18-0876	807	27-430055	18-2740	421	27-49121	18-0464	810
27-35380	18-0893	811	27-430056	18-2740	421	27-49814	18-0467	808
27-35898A2	18-4395	803	27-430057	18-2740	421	27-49936	18-0346	810
27-35898A3	18-4395	803	27-43006-2	18-0339	423	27-49953	18-0887	810
27-35898A4	18-4395	803	27-430066	18-0339	423	27-49955	18-0905	813
27-35982	18-2840	811	27-43007	18-0670	422	27-52076	18-2833	809
27-35996	18-2556	811	27-430073	18-0670	422	27-52144	18-0466	805
27-35996	18-2617	814	27-430075	18-0670	422	27-52145	18-0347	810
27-35996A1	18-2556	811	27-43008	18-0341	422	27-52184	18-0874	808
27-35996A1	18-2617	814	27-430082	18-0341	422	27-52202	18-2845	810
27-37724	18-0879	422	27-430083	18-0341	422	27-52364	18-2946	807
27-37725	18-0103	422	27-430085	18-0341	422	27-524572	18-2848	808
27-37816	18-2507	421	27-430086	18-0341	422	27-52546	18-2896-1	782, 810
27-37976	18-0988	423	27-43033	18-2564	424	27-52550	18-0348	805
27-38501	18-0879	422	27-430331	18-2564	424, 811	27-52571	18-0403	802
27-385011	18-0879	422	27-43034	18-2563	424	27-52579	18-0372	421

Mercury Marine (Cont.)			Mercury Marine (Cont.)			Mercury Marine (Cont.)		
O.E. #	SIERRA #	PAGE #	O.E. #	SIERRA #	PAGE #	O.E. #	SIERRA #	PAGE #
27-52584	18-2830-1	809	27-64818A20	18-2820	811	27-733771	18-2804	419
27-52892	18-0133	420	27-64818A3	18-2619-1	814	27-73397	18-0101	419
27-52893	18-2500	421	27-64818A3	18-2619-1	814	27-73440A76	18-4357	416
27-53045	18-2917	808	27-64818A4	18-2614	814	27-73645	18-0926	421
27-530451	18-2917	808	27-64818A4	18-2820	811	27-73645A32	18-4354	415
27-53354	18-2912-1	782	27-64818Q4	18-2614	814	27-73645A76	18-4354	415
27-53354A1	18-4398	803	27-64818Q4	18-2820	811	27-73645A87	18-4354	415
27-53650	18-2514	420	27-64818T1	18-2614	814	27-73665	18-0133	420
27-53863	18-2807	421	27-64857	18-0131	420	27-73666	18-0685	807
27-54014	18-2620	814	27-64940	18-2807	421	27-73814	18-0928-1	809
27-54014	18-2847	811	27-65184	18-0465	804	27-738141	18-0928-1	809
27-54014A1	18-2620	814	27-65577	18-0357	807	27-73866	18-0183-1	643, 781, 809
27-54014A1	18-2847	811	27-65744	18-0129	420	27-74264	18-3878	807
27-54014Q1	18-2620	814	27-657441	18-0129	420	27-74264A1	18-4382	805
27-54014Q1	18-2847	811	27-657442	18-0129	420	27-74511	18-2504	421
27-54014T1	18-2620	814	27-657443	18-0129	420	27-74830	18-2843	808
27-54014T1	18-2847	811	27-65788	18-2806	421	27-74830A1	18-4382	805
27-54529	18-0980	810	27-66101	18-2835	423	27-74830A3	18-4382	805
27-54529A1	18-4378	806	27-66102	18-0912	423	27-75450	18-0365	809
27-54566	18-0183-1	643, 781, 809	27-661021	18-0912	423	27-75483	18-0611	806
27-54566A1	18-4399	803	27-66358	18-2837	422	27-75611	18-3876	807
27-55279	18-2838	421	27-66847	18-0914	423	27-75611001	18-3876	807
27-552791	18-2838	421	27-67208	18-2513	420	27-75611A03	18-1254	804
27-55306A72	18-4355	415	27-67275	18-0359	420	27-75611A1	18-4392	804
27-55306A73	18-4355	415	27-672751	18-0359	420	27-75611A2	18-4392	804
27-55306A74	18-4355	415	27-67389	18-0864	800	27-75646	18-3883	807
27-55306A75	18-4355	415	27-67738	18-2501	420	27-75647	18-3883	807
27-55308	18-0940	421	27-67751	18-2509	419	27-75648	18-0410	806
27-55810	18-0894	811	27-68714	18-4380	806	27-75791	18-2800	419
27-558101	18-0894	811	27-68714A6	18-4380	806	27-757911	18-2800	419
27-56110	18-3883	807	27-68714A7	18-4380	806	27-75909	18-0369	422
27-56173	18-0352	810	27-68715	18-0956-1	810	27-75952	18-0151	421
27-56304	18-0982-1	423	27-69238	18-2835	423	27-76401	18-2504	421
27-56859	18-0898	812	27-692381	18-2835	423	27-76589	18-0139	422
27-56870A1	18-0407	806	27-69524	18-0918	420	27-76589A77	18-4357	416
27-56880	18-0147	811	27-695241	18-0918	420	27-76589A78	18-4357	416
27-56883	18-0889	807	27-695242	18-0918	420	27-76589A79	18-4357	416
27-56884	18-0357	807	27-69525	18-0131	420	27-76636	18-0151	421
27-58025	18-7143	449, 858	27-695251	18-0131	420	27-76862	18-0932	421
27-58764	18-0353	781	27-695252	18-0131	420	27-768621	18-0932	421
27-60208	18-2834	808	27-69659	18-2800	419	27-76952	18-0101	419
27-60286	18-2512	420	27-70142	18-0360	808	27-77417	18-2841	424
27-60310	18-2504	421	27-70143	18-0994	808	27-78026	18-2507	421
27-60317	18-0904	422	27-701431	18-0994	808	27-78027	18-0940	421
27-60475	18-2573	421	27-70143B1	18-0994	808	27-78028A78	18-4355	415
27-60476	18-2574	421	27-70335	18-0922	421	27-78035	18-2836	421
27-60476A72	18-4356	416	27-703351	18-0922	421	27-78068	18-2503	423
27-60476A73	18-4356	416	27-70905	18-0158	809	27-78069	18-0934-1	423
27-60476A74	18-4356	416	27-72098	18-4380	806	27-78087	18-2837	422
27-60476A75	18-4356	416	27-72142	18-2573	421	27-78246	18-0135	422
27-60477	18-2839	421	27-721421	18-2573	421	27-782461	18-0135	422
27-60479	18-2835	423	27-72479	18-4366	806	27-78409	18-0371	420
27-60715	18-0354	807	27-72479A5	18-4366	806	27-78410	18-0372	421
27-60721	18-0905	813	27-72479T	18-4366	806	27-78411	18-0373	420
27-60945	18-0912	423	27-72486	18-0942	421	27-78623	18-0139	422
27-61224	18-3877	807	27-72486A32	18-4353	415	27-78690	18-0936	423
27-61782	18-0403	802	27-72486A76	18-4353	415	27-79373	18-2622	832
27-62386	18-0182	423	27-72486A78	18-4353	415	27-79650	18-0103	422
27-62860	18-0988	423	27-72486A79	18-4353	415	27-796501	18-0103	422
27-628601	18-0988	423	27-72487	18-2507	421	27-79986	18-3878	807
27-63309	18-2572	419	27-72496	18-0103	422	27-801328158	22423	Obsolete
27-64173	18-2835	423	27-72505	18-2500	421	27-801761363	22423	Obsolete
27-64203	18-0107	420	27-72506	18-2807	421	27-801853	18-4387	804
27-64203A73	18-4351	414	27-72507	18-2574	421	27-801855	18-4365	804
27-64203A74	18-4351	414	27-72508	18-0944	421	27-803508	18-3844	417
27-64203A75	18-4351	414	27-72509	18-2839	421	27-803508017	18-60917	422
27-64204	18-0944	421	27-72510	18-0107	420	27-804908A00	18-74805	Obsolete
27-64692	18-0356	807	27-72622	18-3881	807	27-805215	18-0916	811
27-64763	18-3883	807	27-72627	18-0153	805	27-8052151	18-0916	811
27-64763A2	18-4391	804	27-72637	18-0868	806	27-805396	18-0740-1	S/S to 18-0740-1
27-64798	18-0407	806	27-72779	18-0916	811	27-805396	18-0740-1	420
27-64818	18-2614	814	27-72780	18-0386	811	27-805403A1	18-0404	802
27-64818	18-2820	811	27-72915	18-0371	420	27-805722A1	18-0403	802
27-64818A1	18-2614	814	27-72916	18-0372	421	27-806452	18-0347	810
27-64818A1	18-2820	811	27-72917	18-0373	420	27-807218	18-0928-1	809
27-64818A2	18-2619-1	814	27-72918	18-2837	422	27-807473A1	18-0488	806
27-64818A2	18-2743	811	27-72919	18-2836	421	27-807982	18-0994	808
27-64818A20	18-2614	814	27-73377	18-2804	419	27-8079821	18-0994	808

Mercury Marine (Cont.)			Mercury Marine (Cont.)			Mercury Marine (Cont.)		
O.E. #	SIERRA #	PAGE #	O.E. #	SIERRA #	PAGE #	O.E. #	SIERRA #	PAGE #
27-807982B	18-0994	808	27-850470	18-3887	807	27-88449A32	18-4357	416
27-81031M	18-0232	421	27-850836001	18-60916	417	27-88449A80	18-4357	416
27-81084	18-2946	807	27-85087	18-2561	423	27-88451	18-0139	422
27-810846	18-1239	805	27-852957	18-7690	711	27-884511	18-0139	422
27-810846T	18-1239	805	27-853702005	18-60920	423	27-88907	18-0952	423
27-811546	18-3874	807	27-85487	18-2507	421	27-892157	18-2714	422
27-811547	18-3887	807	27-85488	18-0940	421	27-892158	18-2717	422
27-811566	18-1232	805	27-854881	18-0940	421	27-89221	18-0384	419
27-811572	18-0468	810	27-854882	18-0940	421	27-892211	18-0384	419
27-811588	18-25002	810	27-85489-2	18-0105	420	27-89221A32	18-4319	414
27-812712	18-0403	802	27-85490-2	18-2805	415, 421	27-89221A84	18-4319	414
27-812755	18-2610	422	27-85491	18-0942	421	27-89221A85	18-4319	414
27-8127551	18-2611	422	27-854911	18-0942	421	27-89221A88	18-4319	414
27-812755A01	18-2611	422	27-85491-2	18-0942	421	27-89656	18-2555	808
27-8127754	18-2610	422	27-854913	18-0942	421	27-896561	18-2555	808
27-8127755	18-2611	422	27-85491A90	18-4325	414	27-89656A1	18-4381	805
27-812867	18-2749	421	27-85492-2	18-0137	420	27-89657	18-0111	809
27-8128671	18-2749	421	27-85493	18-2500	421	27-89937	18-0385	422
27-8128672	18-2729	420	27-85494	18-2807	421	27-8M0027781	18-0384	419
27-812867A91	18-4337	412	27-85495	18-2574	421	27-8M0049045	18-3877	807
27-812867A96	18-4337	412	27-854951	18-2574	421	27-8M0050224	18-0465	804
27-812867A97	18-4337	412	27-854952	18-2574	421	27-8M0077608	18-0905	813
27-813859	18-0646	420	27-85496	18-0944	421	27-8M0090319	18-2914	425, 812
27-81417M	18-0292	423	27-854961	18-0944	421	27-8M2021920	18-0398	809
27-814210	18-0463	808	27-85497	18-2839	421	27-90430	18-2803	419
27-81421M	18-0294	423	27-854971	18-2839	421	27-904301	18-2803	419
27-814703	18-2815	811	27-854972	18-2839	421	27-90458	18-0411	806
27-814754A00	18-4338	412	27-85498	18-0107	420	27-90458A1	18-0411	806
27-815528	18-0680	810	27-85498-1	18-0107	420	27-90484	18-2502	421
27-815791A00	18-64217	417	27-85608	18-2914	425, 812	27-904841	18-2502	421
27-815791A92	18-4359	416	27-856081	18-2914	425, 812	27-90484A32	18-4317	413
27-815792A90	18-4359	416	27-85609	18-2915	425, 812	27-90484A86	18-4317	413
27-815809A90	18-4359	416	27-856091	18-2915	425, 812	27-90484A88	18-4317	413
27-815810A90	18-4359	416	27-85610	18-2826	424, 812	27-90556	18-2554	808
27-816460	18-3879	807	27-856101	18-2826	424, 812	27-91831	18-0464	810
27-817277	18-2566	424, 812	27-85653	18-0946	421	27-91892	18-0185	811
27-8172771	18-2566	424	27-85653-1	18-0946	421	27-92166	18-3878	807
27-817533	18-0384	419	27-85653A32	18-4356	416	27-921661	18-3878	807
27-818188	18-1231	805	27-85653A79	18-4356	416	27-92331	18-2717	422
27-8181881	18-1231	805	27-85653A87	18-4356	416	27-92332	18-2716	422
27-818832	18-2849-1	809	27-856704	18-2826	424, 812	27-92648M	18-2787	444
27-81987	18-4698	425	27-856705	18-0113-1	809	27-92720	18-0954	809
27-81987M	18-4698	425	27-856730	18-0946	421	27-93214	18-0324	419
27-81987M	18-46981-9	425	27-85817A1	18-0153	805	27-93536	18-2501	420
27-822189	18-0345	424	27-858524	18-2915	425, 812	27-935361	18-2501	420
27-822217	18-99155	398	27-858524	18-2915	425, 812	27-94914	18-0386	811
27-822844-1	18-3864	417	27-858935	18-0649	422	27-94915	18-0916	811
27-823142	18-0378	422	27-85978	18-2710	420	27-94996	18-2619-1	814
27-823142 2	18-0378	422	27-85979	18-2712	420	27-94996	18-2743	811
27-824326	18-1238	805	27-860231	18-0672	782	27-949962	18-2743	811
27-824326002	18-0487	806	27-860232	18-2849-1	809	27-94996A1	18-2619-1	814
27-8243261	18-0487	806	27-860233	18-0897	782	27-94996A1	18-2743	811
27-824853	18-0835	423	27-863724	18-0897	782	27-94996A2	18-2619-1	814
27-8248531	18-0835	423	27-863725	18-0672	782	27-94996A2	18-2743	811
27-825032	18-3845	417	27-8637251	18-0672	782	27-94996A20	18-2619-1	814
27-825482	18-3827	417	27-863726	18-2849-1	809	27-94996A20	18-2743	811
27-8254821	18-3827	417	27-863891	18-2736	417	27-94996A3	18-2743	811
27-827154	18-61319	810	27-863893	18-2736	417	27-94996Q2	18-2619-1	814
27-827284	18-2721	420	27-863895	18-2736	417	27-94996Q2	18-2743	811
27-828292	18-0641	419	27-864547A02	18-0721	783	27-94996T2	18-2619-1	814
27-828553	18-0319	422	27-864547A1	18-0721	783	27-96171	18-2505	421
27-832933006	18-2739	422	27-864547A1	18-0722	783	27-961711	18-2505	421
27-8329331	18-2739	422	27-864549A02	18-0720	783	27-96278	18-2808	421
27-8329332	18-2739	422	27-864549A1	18-0720	783	27-96286	18-2713	422
27-8329333	18-2739	422	27-864850A02	18-0722	783	27-96429	18-1204-1	782, 810
27-8329334	18-2739	422	27-87105	18-2849-1	809	27-96429	18-1204-1-9	782, 810
27-8329335	18-2739	422	27-871051	18-2849-1	809	27-96440	18-2508-1	423
27-834952001	18-60919	423	27-87396	18-2502	421	27-96483	18-2810	422
27-835383001	18-60915	Obsolote	27-87707	18-0948	808	27-96485	18-2809	423
27-835427003	18-60918	423	27-879150139	18-3874	807	27-96542-1	18-3863	417
27-835427A04	18-64221	417	27-879150140	18-3879	807	27-96761	18-2510	420
27-83899M	18-3828	417	27-879150141	18-3887	807	27-967611	18-2510	420
27-83940M	18-0380	420	27-88046	18-0950	812	27-97529	18-3877	807
27-845628	18-1232	805	27-880729	18-0791	422	27-97542	18-0113-1	809
27-84733M	18-3804	417	27-881715	18-0322	812	27-97863	18-0881-1	782
27-850283	18-2737	420	27-883964	18-0405	805	27-98185	18-2807	421
27-850318	18-3675	421	27-883964T	18-0405	805	27-981851	18-2807	421
27-8503181	18-3675	421	27-88449	18-2504	421	27-9818512	18-2807	421

Mercury Marine (Cont.)			Mercury Marine (Cont.)			Mercury Marine (Cont.)		
O.E. #	SIERRA #	PAGE #	O.E. #	SIERRA #	PAGE #	O.E. #	SIERRA #	PAGE #
27-981853	18-2807	421	30-862540A3	18-21006	831	31-8M0045428	18-1194	406
27-98769	18-0970	420	30-862540T1	18-21005	831	31-8M0045430	18-4039	406
27-987691	18-0970	420	30-862540T1	18-21005K	831	31-8M0103473	18-1129	844
27-98823	18-0388	812	30-862540T1	18-21006	831	31-8M0103474	18-1126	844
27-988231	18-0388	812	30-879194A01	18-21005	831	31-92366	18-1150	844
27-98990M	18-3828	417	30-879194A01	18-21005K	831	31-92366A1	18-1150	844
27-99049M	18-74501	444	30-879194A01	18-21006	831	31-F506818	18-1129	844
27-99173-2	18-2511	423	30-879194A02	18-2100	831	31-F523058	18-1158	432, 845
27-99176	18-2506-1	423	30-879194A02	18-21001	831	31-F694057	18-1117	432
27-991762	18-2506-1	423	30-879194A02	18-2100K	831	31-F84901	18-1162	433, 844
27-991763	18-2506-1	423	30-88957	18-1155	432, 845	31-M8004528	18-1194	406
27-991764	18-2506-1	423	30-88957A1	18-1155	432, 845	32-14358	18-2746	834
27-99177	18-2503	423	30-88957T	18-1155	432, 845	32-14358T	18-2746	834
27-991771	18-2503	423	31-12576	18-1112	432	32-16011	18-70955	752
27-991772	18-2503	423	31-12578	18-1113	432	32-16012	18-70956	752
27-99326	18-2562	424	31-12578T	18-1113	432	32-16021	18-70925	754
27-993261	18-2562	424	31-14358001	18-2746	834	32-160211	18-70925	754
27-99506	18-0667	808	31-17514	18-1194	406	32-32461	18-3601	753
27-995061	18-0667	808	31-17514A1	18-1194	406	32-32461A1	18-3601	753
27-99757	18-2909	810	31-17514A2	18-1194	406	32-38377	18-2160	835
27-99776	18-2508-1	423	31-17514A2	18-4039	406	32-41642A1	18-70957	Obsolete
27-997761	18-2508-1	423	31-29982	18-1115	432	32-41642A3	18-70957	Obsolete
27-99777	18-2833	809	31-30894A1	18-1156	432, 844	32-4172533	18-3602	754
27-997771	18-2833	809	31-30894A5	18-1182	844	32-43437	18-3603	754
27-997772	18-2833	809	31-30895	18-1157	432, 844	32-44348	18-2748	834
27-99777A1	18-4367	802	31-30895T	18-1157	432, 844	32-44348T	18-2748	834
27-99960	18-0389	809	31-30956	18-1158	432, 845	32-45327	18-2110	439
28-43037	18-3293	393, 735	31-30956T	18-1158	432, 845	32-45959	18-2111	439
28-81603M	18-3294	393	31-32573A1	18-1142	843	32-45973	18-2105	848
28-81912M	18-3305	393	31-32575A1	18-1179	844	32-45974	18-2106	848
28-83444M	18-3300	393	31-32575T1	18-1179	844	32-47373	18-2103	847
28-83701M	18-3305	393	31-32898	18-1115	432	32-47640	18-70931	754
28-8M0058389	18-2375	435, 846	31-32898T	18-1115	432	32-48131	18-71218	755
29-47270	18-4036	406	31-33138A1	18-1193	844	32-48132	18-71218	755
29-71422	18-4037	406	31-35246	18-1120	843	32-48418	18-2126	849
29-88258	18-1186	406	31-35928A1	18-1159	432	32-52481	18-70930	754
30-17927	18-1155	432, 845	31-35928T1	18-1159	432	32-52951A1	18-2126	849
30-20066	18-1151	359	31-35988A12	18-1160	845	32-5346170	18-75125	755
30-20464	18-1153	406, 432, 845	31-35988A2	18-1160	845	32-54236	18-3220	735
30-20839	18-1190	432	31-35990A1	18-1161	844	32-55816	18-2107	848
30-20839T	18-1190	432	31-36387A1	18-1143	432, 844	32-59841	18-2108	848
30-20861	18-1398	407	31-38356A1	18-1162	433, 844	32-59841A1	18-2108	848
30-23679	18-1152	359	31-42647	18-1117	432	32-59842	18-2109	848
30-35914	18-1155	432, 845	31-42647A1	18-1117	432, 843	32-66073	18-2103	847
30-36056	18-2101	831	31-42677A1	18-1118	432	32-68676	18-2103	847
30-36418	18-2101	831	31-43012A1	18-1195	406	32-71613	18-70928	754
30-41421	18-1345	406	31-44348001	18-2748	834	32-73004	18-2103	847
30-43011	18-1346	407	31-47245A1	18-4038	406	32-73005	18-2109	848
30-43011T	18-1346	407	31-48939A2	18-1144	432	32-73123	18-2108	848
30-49313	18-1153	406, 432, 845	31-48941A1	18-1163	433, 844	32-73794	18-70929	754
30-54215	18-1153	406, 432, 845	31-54036A1	18-1126	433	32-73795	18-70927	754
30-562540A3	18-21005	831	31-54038A1	18-1127	844	32-73796	18-70926	754
30-60794A2	18-2100	831	31-54042T	18-1180	844	32-79431	18-2103	847
30-60794A2	18-21001	831	31-54928	18-1356	843	32-802885Q	18-7876-1	183, 790
30-60794A2	18-2100K	831	31-55332A1	18-4038	406	32-8066351	18-70938	753
30-60794A4	18-2100	831	31-58859A1	18-4038	406	32-8066361	18-70939	753
30-60794A4	18-21001	831	31-61100A1	18-1165	844	32-8066362	18-70946	753
30-60794A4	18-2100K	831	31-61424A2	18-4038	406	32-806825	18-71337	755
30-62699	18-1190	432	31-62596A1	18-4038	406	32-806856	18-70935	753
30-63326	18-1153	406, 432, 845	31-62799A1	18-1111	432	32-807407	18-70949	752
30-63326T	18-1153	406, 432, 845	31-63075A1	18-4038	406	32-807458T	18-2770	834
30-63742	18-1154	406, 432	31-67526	18-1194	406	32-8078961	18-70951	752
30-63742T	18-1154	432	31-67526A1	18-1194	406	32-8078962	18-70951	752
30-67923	18-1345	406	31-67526A2	18-1194	406	32-808033	18-70948	752
30-67923T	18-1345	406	31-73363	18-1122	432	32-8080441	18-70953	752
30-72961	18-1398	407	31-73363T	18-1122	432	32-814384	18-3221	735
30-803097T1	18-8213	834	31-74248	18-1196	406	32-858104K08	18-8024EP-2	143, 384
30-803097T1	18-2601-1	833	31-74248T	18-1196	406	32-858104Q08	18-8024EP-2	143, 384
30-803098T1	18-8217	834	31-78172A1	18-1166	433	32-858105K08	18-8025EP-2	143, 385
30-803098T1	18-8205	833	31-803090T1	18-8208	855	32-858105Q08	18-8025EP-2	143, 385
30-803099T1	18-8218	834	31-812767A1	18-1170	433	32-858109K12	18-8016EP-2	143, 385
30-803099T1	18-8206-1	833	31-814337A1	18-1194	406	32-858109K12	18-8016S-1	147
30-803100T1	18-8219	834	31-815480	18-1189	Obsolete	32-858109Q12	18-8016EP-2	143, 385
30-803100T1	18-8212-1	833	31-821146A1	18-1194	406	32-858114K08	18-8012EP-2	142, 384
30-862540A04	18-21005	831	31-828437A2	18-1173	844	32-858114Q08	18-8012EP-2	142, 384
30-862540A04	18-21005K	831	31-828439A2	18-1197	432, 844	32-860089	18-70954	752
30-862540A04	18-21006	831	31-86748A1	18-1129	844	32-8600891	18-70954	752
30-862540A3	18-21005K	831	31-88269T	18-1347	432	32-860144	18-70940	753

Mercury Marine (Cont.)			Mercury Marine (Cont.)			Mercury Marine (Cont.)		
O.E. #	SIERRA #	PAGE #	O.E. #	SIERRA #	PAGE #	O.E. #	SIERRA #	PAGE #
32-860205	18-70951	752	35-57250	18-7845	136, 389, 732	35-866340Q	18-7824-2	183, 774
32-860220	18-3221	735	35-57250	18-7944	136, 389, 732	35-866340Q02	18-7824-2	183, 774
32-86036	18-2103	847	35-57250	18-7945	136, 389, 732	35-866340Q02	18-7824-2	183, 774
32-86036A1	18-2103	847	35-57250A1	18-7848-1	136, 387, 731	35-866340Q02	18-7876-1	183, 790
32-86036Q	18-2103	847	35-57250A1	18-7983-1	136, 387, 731	35-866340Q03	18-7824-2	183, 774
32-861127	18-2435	848	35-60494	18-7944	136, 389, 732	35-866340Q03	18-7876-1	183, 790
32-861128	18-2436	849	35-60494	18-7945	136, 389, 732	35-877565T	18-7714	389
32-861590A05	18-71337	755	35-604941	18-7845	136, 389, 732	35-877565T1	18-7714	389
32-861590A1	18-71337	755	35-604941	18-7944	136, 389, 732	35-877761K01	18-7758	183, 411
32-861590A2	18-71337	755	35-604941	18-7945	136, 389, 732	35-877761Q01	18-7758	183, 411
32-861635	18-44092	753	35-60494A1	18-7848-1	136, 387, 731	35-877767K01	18-7921	184, 411
32-862124	18-70947	752	35-60494A1	18-7983-1	136, 387, 731	35-877768K01	18-7914	184, 411
32-862139	18-70945	752	35-60494A4	18-7845	136, 389, 732	35-877769K01	18-7918	184, 411
32-864588	18-2137	848	35-60494A4	18-7848-1	136, 387, 731	35-87946A3	18-7802	389
32-864589	18-2136	848	35-60494A4	18-7983-1	136, 387, 731	35-87946Q3	18-7802	389
32-864959	18-2115	848	35-802884Q	18-7879-1	183, 790	35-87946Q4	18-7802	389
32-864960	18-2114	848	35-802885Q	18-7824-2	183, 774	35-879885T	18-7718	389
32-865672070	18-75125	755	35-802886Q	18-7875	183, 790	35-883701K01	18-7918	184, 411
32-87116	18-70925	754	35-802893A4	18-7983-1	136, 387, 731	35-884380T	18-7981	390
32-87117	18-70932	754	35-802893Q	18-7844	136, 389, 732	35-886638	18-7948	139, 389, 732
32-871171	18-70932	754	35-802893Q	18-7944	136, 389, 732	35-888289T2	18-7936	389
32-87234	18-2112	848	35-802893Q	18-7945	136, 389, 732	35-892665	18-7715	733
32-87235	18-2113	848	35-802893Q4	18-7848-1	136, 387, 731	35-896247	18-7999	390
32-88005	18-2110	439	35-802893Q4	18-7983-1	136, 387, 731	35-896546T	18-7921	184, 411
32-88006	18-2111	439	35-80365M	18-7713	389	35-8M0008397	18-7914	184, 411
32-883702K	18-7879-1	183, 790	35-803897Q1	18-7784	733	35-8M0020349	18-7981	390
32-883702Q	18-7879-1	183, 790	35-805369	18-7944	136, 389, 732	35-8M0064104	18-7914	184, 411
32-887952	18-70952	752	35-805369	18-7945	136, 389, 732	35-8M0079962	18-79911	136, 389, 732
32-89653	18-70704	755	35-8053691	18-7845	136, 389, 732	35-8M0082290	18-79912	136
32-897181	18-70934	753	35-8053691	18-7944	136, 389, 732	35-8M0103095	18-7919	137, 389, 732, 733
32-897491	18-70943	753	35-8053691	18-7945	136, 389, 732	35-93568	18-7717	733
32-8M0062309	18-3602	754	35-805369A4	18-7848-1	136, 387, 731	39-15320M	18-3976	403
32-8M0062614	18-75100	755	35-805809	18-7871	182, 672, 790	39-15320T	18-3976	403
32-8M0062665	18-75125	755	35-805809T	18-7871	182, 672, 790	39-15322M	18-3978	403
32-8M0071007	18-70931	754	35-806771	18-7845	136, 389, 732	39-17464	18-3937	791
32-8M0090859	18-3603	754	35-806771	18-7944	136, 389, 732	39-17465	18-3938	791
32-90949	18-2761	834	35-806771	18-7945	136, 389, 732	39-18487A12	18-3924	405
32-90949T	18-2761	834	35-807172	18-7844	136, 389, 732	39-18653A1	18-3967	403
32-95858	18-2435	848	35-807172	18-7845	136, 389, 732	39-18653A12	18-3966	403
32-95859	18-2436	849	35-807172	18-7944	136, 389, 732	39-18653A2	18-3968	403
32-96246	18-70958	753	35-807172	18-7945	136, 389, 732	39-18939M	18-3977	403
32-96246A1	18-70958	753	35-807172A4	18-7848-1	136, 387, 731	39-19721A1	18-4020	403
32-96246A4	18-70958	753	35-807172A4	18-7983-1	136, 387, 731	39-19721A2	18-4021	403
32-96879	18-70931	754	35-808275	18-7873	139, 670, 733	39-19721A6	18-4019	403
32-97153A1	18-2110	439	35-809097	18-7919	137, 389, 732, 733	39-34479	18-3942	791
32-97154A1	18-2111	439	35-809099	18-7920	138, 389, 732	39-34988	18-3937	791
32-99902	18-2136	848	35-809100	18-7929	137	39-45155A12	18-3902	403
32-99902-1	18-2114	848	35-813405	18-7964	S/S to 18-7964-1	39-45204A12	18-3916	403
32-99903	18-2137	848	35-813405	18-7964-1	733	39-48344	18-3939	791
32-99903-1	18-2115	848	35-813405A1	18-7964	S/S to 18-7964-1	39-48345	18-3938	791
32-99904	18-2116	849	35-813405A1	18-7964-1	733	39-58096	18-3942	791
32-99904Q	18-2116	849	35-815419	18-7964	S/S to 18-7964-1	39-65153	18-3937	791
35-11004A1	18-7784	733	35-815419	18-7964-1	733	39-66217	18-3939	791
35-134301	18-7830	140, 390	35-816296	18-7829	140, 390	39-67119	18-3942	791
35-14571A1	18-7967	136, 389	35-8162961	18-7830	140, 390	39-67123	18-3937	791
35-16248	18-7712	389	35-816296-1	18-7830	140, 390	39-67126	18-3938	791
35-16494	18-7829	140, 390	35-816296B1	18-7830	140, 390	39-67127	18-3940	791
35-164941	18-7830	140, 390	35-816296B2	18-7830	140, 390	39-67132	18-3942	791
35-17808A1	18-7967	136, 389	35-816296K03	18-7829	140, 390	39-74381A1	18-3928	791
35-184585	18-7968	136, 389	35-816296Q	18-7829	140, 390	39-75422	18-3928	791
35-18458A2	18-7967	136, 389	35-816296Q2	18-7830	140, 390	39-75609	18-3944	791
35-18458A3	18-7967	136, 389	35-816296T	18-7829	140, 390	39-78811A12	18-3916	403
35-18458Q3	18-7967	136, 389	35-816296T1	18-7830	140, 390	39-78816A12	18-3902	403
35-18458Q4	18-7968	136, 389	35-816396Q1	18-7830	140, 390	39-78918A4	18-3922	405
35-49088	18-7860	733	35-8226267	18-7906-1	184, 411	39-81096M	18-3986	403
35-49088A2	18-7860	733	35-822626K04	18-7914	184, 411	39-813011A12	18-3927	405
35-49088Q2	18-7860	733	35-822626Q03	18-7913	184, 411	39-815267A4	18-3925	405
35-52456	18-7944	136, 389, 732	35-822626Q04	18-7914	184, 411	39-817096A16	18-3919	403
35-52456	18-7945	136, 389, 732	35-822626Q1	18-7913	184, 411	39-817096A26	18-3920	403
35-52456A1	18-7848-1	136, 387, 731	35-822626Q15	18-7906-1	184, 411	39-817096A6	18-3918	403
35-52456A1	18-7983-1	136, 387, 731	35-822626Q2	18-7914	184, 411	39-822321A12	18-3982	403
35-53336	18-7859	717	35-822626T2	18-7914	184, 411	39-822321A2	18-3984	403
35-53336Q	18-7859	717	35-822626T7	18-7906-1	184, 411	39-824905A12	18-3982	403
35-55501	18-7845	136, 389, 732	35-853333	18-7997	390	39-826293A12	18-4051	405
35-55501	18-7944	136, 389, 732	35-853333T	18-7997	390	39-826297A12	18-4052	405
35-55501	18-7945	136, 389, 732	35-864572	18-7721	733	39-827179A12	18-4050	405
35-55501A1	18-7848-1	136, 387, 731	35-866171A01	18-7977	733	39-83196M	18-3992	403
35-55501A1	18-7983-1	136, 387, 731	35-866340K01	18-7824-2	183, 774	39-85636A4	18-3923	405

Mercury Marine (Cont.)			Mercury Marine (Cont.)			Mercury Marine (Cont.)		
O.E. #	SIERRA #	PAGE #	O.E. #	SIERRA #	PAGE #	O.E. #	SIERRA #	PAGE #
39-88392	18-3917	403	45-55796	18-2179	832	46-96148A8	18-3316	396
39-88392A12	18-3917	403	45-557961	18-2324	832	46-96148A8	18-3517	396, 737
39-93481A12	18-3921	405	45-816919	18-2261	842	46-96148T1	18-3116	393, 735
39-96170A12	18-3979	403	45-853647	18-2331	842	47-11590M	18-3066	392
39-96170A4	18-3981	403	45-853648	18-2331	842	47-16154	18-3098	392
39-97125	18-3939	791	46-32437A1	18-3517	396	47-161543	18-3098	392
40-52035	18-4294	403	46-32437A3	18-3316	396	47-19453	18-8900	393
43-17064A3	18-2407	841	46-42040A1	18-3149-1	S/S to 18-3149-2	47-20813	18-3008	392
43-18410A2	18-2201	829	46-42040A1	18-3149-2	394	47-22748	18-3012	392
43-18411A2	18-2201	829	46-42040A3	18-3149-1	S/S to 18-3149-2	47-25287	18-3008	392
43-42933A2	18-2407	841	46-42040A3	18-3149-2	394	47-30221	18-3017	392, 734
43-42933A3	18-2407	841	46-42040A5	18-3149-1	S/S to 18-3149-2	47-39074	18-3039	392
43-45814A5	18-2203	829	46-42040A5	18-3149-2	394	47-420381	18-3062	392
43-55765A2	18-2203	829	46-42579A3	18-3419	394	47-420382	18-3062	392
43-55765A3	18-2203	829	46-42579A4	18-3319	396	47-42038Q02	18-3062	392
43-55766A2	18-2205	829	46-42579A4	18-3517	396	47-430261	18-3056	392
43-55766A3	18-2205	829	46-43024A3	18-3572	397	47-430262	18-3056	392
43-55778A3	18-2205	829	46-44292A3	18-3420	735	47-430264	18-3056	392
43-59832A2	18-2201	829	46-44292A4	18-3517	396	47-43026Q06	18-3265	395
43-59832A4	18-2201	829	46-44292Q03	18-3420	735	47-43026T11	18-3214	394
43-61027	18-2200	840	46-44292T1	18-3420	735	47-43026T11	18-3265	395
43-75325A2	18-2204	829	46-48743A1	18-3116	393, 735	47-43026T2	18-3056	392
43-75325A3	18-2204	829	46-48744A3	18-3448	398	47-43026T6	18-3214	394, 736
43-803069T1	18-2369	828	46-48745A1	18-3422	394	47-43026T8	18-3214	394, 736
43-803071T1	18-2368	828	46-48746A1	18-3118	393	47-56780	18-3052	392
43-803079T1	18-2404	841	46-48746A3	18-3118	393	47-59362	18-3087	734
43-803091T1	18-2405	841	46-48747A3	18-3517	396	47-59362A4	18-3216	736
43-803101T1	18-2259	830	46-48748A1	18-3421	735	47-59362Q08	18-3318	736
43-803102T1	18-2358	828	46-57234A1	18-3417	735	47-59362T	18-3087	734
43-803103T1	18-6351K	828	46-57234A3	18-3517	396	47-65957	18-3039	392
43-803104T1	18-6350K	828	46-58618A4	18-3517	396	47-65958	18-3052	392
43-803105T1	18-6353K	828	46-59112A2	18-3600	736	47-65960	18-3017	392, 734
43-803106T1	18-6352K	828	46-60366A1	18-3507	396	47-68988	18-3054	392
43-803112T1	18-2257	830	46-60367A4	18-3517	396	47-72774A89	18-3155	736
43-803114T1	18-2258	830	46-63450A2	18-3600	736	47-80395M	18-3072	392
43-803116T1	18-2256	829	46-64141A1	18-3116	393, 735	47-81242M	18-3063	392
43-803118T1	18-2363	828	46-64141A11	18-3517	396	47-81423M	18-3069	392
43-803119T1	18-2364	828	46-65498A1	18-3422	394	47-81604M	18-3067	392
43-803120T1	18-2365	828	46-68390A1	18-3422	394	47-82824M	18-3069	392
43-803615T1	18-1564	436	46-69222A3	18-3517	396	47-84027M	18-3074	392
43-803615T2	18-1551	436	46-70941A3	18-3446	397	47-84027T	18-3074	392
43-803615T2	18-1564	436	46-72774A11	18-3600	736	47-84797M	18-3067	392
43-821823A1	18-6350	829	46-72774A32	18-3600	736	47-85089-3	18-3057	392
43-823072A2	18-2407	841	46-73640A1	18-3423	394	47-85089T7	18-3215	394
43-828072A2	18-2206-1	840	46-73640A2	18-3323	397	47-85460	18-3017	392, 734
43-828072A3	18-2360	840	46-73802A2	18-3416	394	47-862232A2	18-3016-1	734
43-828073A1	18-2206-1	840	46-73802A3	18-3517	396	47-89980	18-3054	392
43-828073A1	18-2408	840	46-73804A1	18-3414	394	47-89981	18-3039	392
43-828175A1	18-1566	437	46-73804A3	18-3517	396	47-89982	18-3052	392
43-850036	18-1560	436	46-73823A7	18-3600	736	47-89982T1	18-3252	395
43-850036T	18-1560	436	46-73842A2	18-3422	394	47-89983	18-3007	391, 734
43-853640A2	18-6350	829	46-77177A1	18-3424	394	47-89983Q1	18-3207	394
43-853641A2	18-6351	829	46-77177A3	18-3324	397	47-89983T	18-3007	391
43-853642A2	18-6352	829	46-77516A1	18-3422	394	47-89983T2	18-3207	394
43-853643A2	18-6353	829	46-77516A3	18-3322	396	47-89984	18-3017	392, 734
43-878072A3	18-2406	840	46-77822A1	18-3118	393	47-899842	18-3017	392, 734
43-878087A2	18-2206-1	840	46-78400A1	18-3416	394	47-899844	18-3017	392, 734
43-878087A2	18-2360	840	46-78400A2	18-3316	396	47-89984T3	18-3017	392, 734
43-878087A2	18-2406	840	46-78400A2	18-3517	396	47-89984T4	18-3017	392, 734
43-878087A4	18-2407	841	46-8037502	18-43212	394	47-8M0100526	18-3265	395
43-881260A3	18-1550	436	46-803750A02	18-43212	394	47-95289	18-45312	393
43-92320	18-2409	840	46-803750A03	18-48317	398	47-952892	18-45312	393
43-92320T	18-2409	840	46-807151A12	18-36001	736	47-95611M	18-3063	392
43-96084A4	18-2200	840	46-807151A14	18-3150	736	47-96305M	18-3073	392
43-96084A5	18-2410	840	46-807151A7	18-3150	736	47-96619M	18-3074	392
43-96084A7	18-2410	840	46-812966A7	18-3445	394	47-97108M	18-3069	392
44-17915	18-2260	436	46-812996A3	18-3445	394	50-12066A1	18-4915	376
44-55857	18-2166	841	46-812996A9	18-3445	394	50-12066A9	18-4915	376
44-66060	18-2166	841	46-84277M	18-3148	397	50-12066Q9	18-4915	376
44-660602	18-2166	841	46-84277T	18-3148	397	50-12121A2	18-6275	697
44-660603	18-2166	841	46-862914A13	18-3160-1	736	50-12177A2	18-5910	698
44-824110	18-2166	841	46-879194401	18-3506	734	50-12177A2	18-6275	697
44-850308	18-2254	436, 841	46-96146A2	18-3416	394	50-12872	18-5903	699
44-94148	18-2239	436	46-96146A5	18-3414	394	50-17251A2	18-5908	698
44-98418	18-2260	436	46-96146A6	18-3416	394	50-17251A3	18-5908	698
45-42634	18-2180	842	46-96148	18-3116	393, 735	50-17251A3	18-5911	697
45-43031A1	18-1736	436	46-96148A1	18-3116	393, 735	50-22791A1	18-4915	376
45-440001	18-1737	436	46-96148A5	18-3517	396, 737	50-28985A2	18-4915	376

Mercury Marine (Cont.)			Mercury Marine (Cont.)			Mercury Marine (Cont.)		
O.E. #	SIERRA #	PAGE #	O.E. #	SIERRA #	PAGE #	O.E. #	SIERRA #	PAGE #
50-38890A1	18-5601	373	50-822462	18-5621	374	56-864641A24	18-2464	850
50-41583	18-6828	374	50-822462T1	18-5621	374	57-13457	18-15290	756
50-44369	18-5606	373	50-825991A2	18-6940	374	57-13457Q	18-15290	756
50-44369A1	18-5602	373	50-830308T	18-6437	373	57-13457T	18-15290	756
50-44369A1	18-5606	373	50-831001562	18-6949	662, 699	57-13458	18-15550	756
50-44369A1	18-5642	373	50-831001671	18-6954	662	57-13458Q	18-15550	756
50-44414	18-5608	373	50-831001672	18-6954	662	57-13458T	18-15550	756
50-44414	18-5608	373	50-831001961	18-6949	662, 699	57-32850	18-15400	756
50-44415	18-5608	373	50-831002050	18-6954	662	57-32850	18-15410	756
50-44415	18-5608	373	50-831002051	18-6954	662	57-33170	18-15520	756
50-45093	18-4915	376	50-831002052	18-6954	662	57-33170Q	18-15520	756
50-47455	18-5908	698	50-8329972	18-6282	373	57-36356	18-15415	756
50-55601	18-5601	373	50-8331535	18-6283	373	57-37619T	18-15520	756
50-55601A2	18-5601	373	50-834749	18-6436	372	57-45856	18-15440	756
50-56886	18-5903	699	50-852570	18-6829	374	57-48120	18-15460	756
50-57465A1	18-5636	374	50-852570T	18-6829	374	57-48120A1	18-15460	756
50-57867	18-5636	374	50-853329T	18-6440	373	57-48120Q1	18-15460	756
50-58788A3	18-5602	373	50-854178	18-6957	662, 699	57-48122	18-15480	756
50-58788A3	18-5636	374	50-854636T	18-6438	373	57-48122Q	18-15480	756
50-60315	18-5606	373	50-855507	18-6957	662, 699	57-49043	18-15410	756
50-60594A	18-6824	374	50-857065	18-6829	374	57-49043A1	18-15410	756
50-60594A1	18-6824	374	50-859168	18-6829	374	57-49211	18-15430	756
50-60594T01	18-6824	374	50-859168T	18-6829	374	57-49211	18-15435	756
50-64975	18-5636	374	50-859169T	18-6437	373	57-49213A1	18-15440	756
50-65784A1	18-5908	698	50-859170T	18-6438	373	57-49756	18-15300	756
50-66015	18-5642	373	50-859171T	18-6436	372	57-52692	18-15390	756
50-660151	18-5610	374	50-859377T	18-6435	372	57-53215	18-15290	756
50-660153	18-5610	374	50-863007A1	18-6275	697	57-53215T	18-15290	756
50-66015T	18-5610	374	50-864340A2	18-5913	697	57-64032	18-15410	756
50-66015T1	18-5642	373	50-864340A2	18-6275	697	57-64032A1	18-15410	756
50-67341	18-5602	373	50-86976	18-6825	374	57-64032Q1	18-15410	756
50-69865A1	18-5903	699	50-884044T	18-6435	372	57-64416	18-15430	756
50-72467	18-5636	374	50-884045T	18-6438	373	57-64416	18-15435	756
50-72550A2	18-5907	697	50-888151T	18-6437	373	57-65607	18-15370	756
50-73521	18-5605	373	50-888160T	18-6438	373	57-65607Q	18-15370	756
50-73521T	18-5605	373	50-888161T	18-6435	372	57-65607T	18-15370	756
50-76965A3	18-5908	698	50-892339T	18-6440	373	57-69143Q	18-15400	756
50-76965A4	18-5911	697	50-893890T	18-5621	374	57-69143T	18-15400	756
50-76967A1	18-5908	698	50-893891T	18-5602	373	57-74271	18-15345	756
50-76967A4	18-5908	698	50-893891T	18-5642	373	57-74271Q	18-15345	756
50-77141	18-5608	373	50-893892T	18-5610	374	57-74271T	18-15345	756
50-77141	18-5608	373	50-893894	18-6943	374	57-76269	18-15405	756
50-77328A1	18-6275	697	50-897755T	18-6840	372	57-76269Q	18-15405	756
50-77328A3	18-5911	697	50-898265005	18-5605	373	57-77274	18-15345	756
50-77328A3	18-6275	697	50-8M0033984	18-5611	374	57-77274A1	18-15325	756
50-79472	18-5608	373	50-8M8021116	18-6946	699	57-78200	18-15470	756
50-79472	18-5608	373	50-90983A1	18-5611	374	57-78200A1	18-15470	756
50-79472 1	18-5608	373	50-90983T1	18-5611	374	57-78200Q1	18-15470	756
50-79472 1	18-5608	373	50-97499A2	18-5907	697	57-8077554	18-15112	762
50-79604A3	18-5907	697	50-97499R4	18-5907	697	57-8077555	18-15113	762
50-801333980	18-6957	662, 699	50-99417A2	18-5911	697	57-807755Q04	18-15112	762
50-804312T1	18-6425	737	50-99418A2	18-5910	698	57-816295Q	18-15490	756
50-805833	18-6870	662	50-99418A2	18-6275	697	57-816295T	18-15490	756
50-805833T	18-6870	662	50-99419A3	18-5908	698	57-816544	18-15410	756
50-805991	18-6947	662, 699	50-99419A3	18-5911	697	57-817113	18-15125	762
50-806963A4	18-5919	698	52-12777	18-2236	436	57-828507Q4	18-18100	372
50-806964A2	18-6275	697	52-34239	18-2236	436	57-861049	18-15114	762
50-806964A3	18-6275	697	52-66063	18-2202	841	57-8610491	18-15102	762
50-806964A4	18-6275	697	52-814756	18-2236	436	57-861049Q	18-15114	762
50-806965A2	18-5919	698	52-822539	18-2236	436	57-861050	18-15103	762
50-806965A4	18-5919	698	52-822539T	18-2236	436	57-861757	18-15115	762
50-807904A1	18-6275	697	52-824112	18-2202	841	57-861757Q	18-15115	762
50-808011A05	18-5908	698	52-850048T	18-1562	436	57-861758	18-15116	762
50-808011A1	18-5908	698	52-853594	18-2202	841	57-861758Q	18-15116	762
50-808011A3	18-5908	698	52-853594T	18-2202	841	57-861759	18-15117	762
50-808011A4	18-5603	696	52-859340T	18-1565	436	57-862086	18-15101	762
50-808011A4	18-5908	698	53-29641	18-4295	843	57-8620861	18-15101	762
50-812428A3	18-5913	697	53-805272	18-4289	853	57-862086A1	18-15101	762
50-812428A3	18-6275	697	53-815949	18-2345	853	57-862087A1	18-15100	762
50-812604A2	18-5913	697	53-850048	18-1562	436	57-862088	18-15105	762
50-812604A2	18-6275	697	54-31765	18-710-72-2	106, 837, 914	57-862088A1	18-15105	762
50-818445-2	18-5620	374	54-32533	18-710-48-2	837	57-862089	18-15104	762
50-818445-3	18-5620	374	54-38863	18-7321	835	57-862089A1	18-15104	762
50-8184455	18-5620	374	54-41582-7	18-8020	145	57-8623523	18-15119	762
50-819271	18-6864	374	54-815504348	18-710-48-2	837	57-862807	18-15100	762
50-820193A1	18-6864	374	54-866507	18-7321	835	57-8638761	18-15119	762
50-822330A2	18-5913	697	54-8M0090424	18-7321	835	57-86387610	18-15122	762
50-822330A2	18-6275	697	56-18541A75	18-2464	850	57-8638763	18-15100	762

Mercury Marine (Cont.)			Mercury Marine (Cont.)			Mercury Marine (Cont.)		
O.E. #	SIERRA #	PAGE #	O.E. #	SIERRA #	PAGE #	O.E. #	SIERRA #	PAGE #
57-8638764	18-15101	762	84-816761A4	18-8804-1	171-181, 693	91-14311A1	18-9874	206
57-8638765	18-15121	762	84-816761A4	18-8821-1	171-181, 693	91-14311A2	18-9874	206
57-8638766	18-15102	762	84-816761A7	18-8800-1	171-181, 693	91-15755	18-9808	206
57-8638767	18-15103	762	84-816761A8	18-8809-1	171-181, 693	91-15755T	18-9808	206
57-8638768	18-15104	762	84-816761A9	18-8803-2	171-181, 693	91-17256	18-9803	206, 840
57-8638769	18-15105	762	84-816761K14	18-8833-1	171-181, 693	91-17257	18-9809	206
57-864639	18-15123	762	84-816761Q10	18-8803-2	171-181, 693	91-17262A1	18-9810	206
57-865423005	18-15121	762	84-816761Q12	18-8802-1	171-181, 693	91-17275A1	18-9812	206
57-865615001	18-15119	762	84-816761Q13	18-8811-1	171-181, 693	91-23033	18-9817	206
57-865615003	18-15100	762	84-816761Q16	18-8810-1	171-181, 693	91-23033T	18-9817	206
57-865615004	18-15101	762	84-816761Q17	18-8821-1	171-181, 693	91-24150	18-9817	206
57-865615005	18-15121	762	84-816761Q3	18-8804-1	171-181, 693	91-29310	18-9814	206
57-865615006	18-15102	762	84-816761Q3	18-8821-1	171-181, 693	91-30366T1	18-9816	212
57-865615007	18-15103	762	84-816761Q4	18-8804-1	171-181, 693	91-30500	18-9785	201
57-865615008	18-15104	762	84-816761Q4	18-8821-1	171-181, 693	91-31107	18-9817	206
57-865615009	18-15105	762	84-816761Q5	18-8800-1	171-181, 693	91-31107T	18-9817	206
57-865615010	18-15122	762	84-816761Q6	18-8808-2	171-181, 693	91-31109	18-9808	206
57-865615Q01	18-15119	762	84-816761Q7	18-8801-1	171-181, 693	91-31229	18-9819	212
57-865615Q03	18-15100	762	84-816761Q8	18-8809-1	171-181, 693	91-31229A7	18-9820	207
57-865615Q04	18-15101	762	84-816761Q9	18-8803-2	171-181, 693	91-32325	18-9821	206
57-865615Q05	18-15121	762	84-821945A56	18-28080	171, 363	91-32325T	18-9821	206
57-865615Q06	18-15102	762	84-847701A7	18-8837-1	171-181, 693	91-32336	18-9822	207
57-865615Q07	18-15103	762	84-847701Q7	18-8837-1	171-181, 693	91-33489	18-9823	206
57-865615Q08	18-15104	762	84-863656A1	18-8828-1	171-181, 693	91-33491	18-9824	206
57-865615Q09	18-15105	762	84-863656A2	18-8829-1	171-181, 693	91-33492	18-9825	206
57-865615Q10	18-15122	762	84-881262A2	18-6500	372	91-33492T	18-9825	206
57-880566014	18-15128	372	84-881698	18-8838-1	171-181, 693	91-33493	18-9826	206
57-881754	18-15124	762	84-881908T	18-28083	171, 363	91-33493T	18-9826	206
57-892318	18-18000	372	84-881908T	18-28084	171, 363	91-34379T	18-9827	206
57-895120	18-15149	411	84-881908T	18-28085	171, 363	91-36235	18-9803	840
57-895120002	18-15150	411	84-881908T	18-28086	171, 363	91-36379	18-9828	212
57-91035	18-15495	756	84-90816A26	18-5225	363, 696	91-36569	18-9829	207
57-91035A1	18-15495	756	84-93212A1	18-5225	363, 696	91-36569T	18-9829	207
57-91035Q1	18-15495	756	84-93475A26	18-5225	363, 696	91-36571	18-9830	207
57-96834	18-15550	756	84-99215A26	18-5225	363, 696	91-36571T	18-9830	207
57-96834Q	18-15500	756	87-17009A2	MP41070-2	28, 363	91-36577	18-9831	207
57-96834T	18-15500	756	87-17009A5	MP51090	23, 29, 363	91-36577T	18-9831	207
81-64851	18-5346	678	87-17009A5	MP51092	23, 29, 363	91-37263	18-9808	206
84-43376A12	18-8802-1	171-181, 693	87-18211	18-5729	369	91-37292	18-9832	212
84-43376A7	18-8800-1	171-181, 693	87-19761	18-5737	369	91-37311	18-9833	212
84-43376A8	18-8809-1	171-181, 693	87-71831	18-5317	677	91-37312	18-9834	212
84-43376A9	18-8803-2	171-181, 693	87-861780A2	18-5116-1	680	91-37323	18-9835	207
84-813706A26	18-5225	363, 696	87-861780Q4	18-5116-1	680	91-37324	18-9815	212
84-813706A56	18-28081	171, 363	87-88107	MP41000	28, 363	91-37350	18-9836	207
84-813715A1	18-5227-1	362	87-88107A5	MP52000	23, 29, 363	91-37384	18-4442	212, 840
84-813715A1	18-5228-1	362	87-88107A5	MP52002	23, 29, 363	91-38277A1	18-4444	439, 847
84-813715A8	18-28082	171, 363	87-892150A02	18-5116-1	680	91-38628T	18-9837	207
84-813720A10	18-8803-2	171-181, 693	88-79023A91	18-8220	704	91-38756	18-9838	207
84-813720A11	18-8810-1	171-181, 693	88-93582	18-15501	702	91-38918T	18-9839	207
84-813720A12	18-8802-1	171-181, 693	89-15857	18-5815	368, 701	91-38919	18-9840	207
84-813720A13	18-8811-1	171-181, 693	89-18080	18-5837	700	91-42840T	18-9841	207
84-813720A2	18-8804-1	171-181, 693	89-61053	18-5815	368, 701	91-43506T	18-9842	207
84-813720A3	18-8804-1	171-181, 693	89-65258	18-5815	368, 701	91-43559	18-9843	207
84-813720A3	18-8821-1	171-181, 693	89-68258A4	18-5815	368, 701	91-43579	18-9844	207
84-813720A4	18-8804-1	171-181, 693	89-76416A1	18-5801	700	91-43591T	18-9845	208
84-813720A4	18-8821-1	171-181, 693	89-76545	18-5815	368, 701	91-44110	18-9846	208
84-813720A5	18-8800-1	171-181, 693	89-76545T	18-5815	368, 701	91-44307A1	18-9874	206
84-813720A6	18-8808-2	171-181, 693	89-817109A2	18-5834	369	91-45497A1	18-9847	208
84-813720A7	18-8801-1	171-181, 693	89-818864	18-5818	368	91-47448A1	18-9896	205
84-813720A8	18-8809-1	171-181, 693	89-818864T	18-5818	368	91-48347	18-4442	212, 840
84-813720A9	18-8803-2	171-181, 693	89-818997A1	18-5819	368	91-52393	18-9848	212
84-816608A14	18-8833-1	171-181, 693	89-818997A2	18-5819	368	91-52394	18-9849	212
84-816608A68	18-8832-1	171-181, 693	89-818997T1	18-5819	368	91-53459	18-9850	208
84-816608A71	18-8836-1	171-181, 693	89-818999A2	18-5820	368, 701	91-55916	18-9851	208
84-816608A81	18-8822-1	171-181, 693	89-825096T	18-5821	368	91-55918	18-9852	208
84-816608A83	18-8834-1	171-181, 693	89-825842A1	18-5820	368, 701	91-56048001	18-9853	208
84-816608K68	18-8832-1	171-181, 693	89-850188T1	18-5820	368, 701	91-56048T	18-9853	208
84-816608Q14	18-8833-1	171-181, 693	89-853654A1	18-5815	368, 701	91-56775T	18-9854	208
84-816608Q61	18-8804-1	171-181, 693	89-91975	18-5816	368, 701	91-57797A1	18-4442	212, 840
84-816608Q68	18-8832-1	171-181, 693	89-96054	18-5816	368, 701	91-57797A2	18-4442	212, 840
84-816608Q71	18-8836-1	171-181, 693	89-96054T	18-5816	368, 701	91-57797A3	18-4442	212, 840
84-816608Q78	18-8824-1	172-174, 594, 614,	89-96158	18-5817	368, 701	91-60523	18-9855	208
84-816608Q80	18-8830-1	171-181, 693	89-96158T	18-5817	368, 701	91-60526T	18-9856	208
84-816608Q81	18-8822-1	171-181, 693	89-99253	18-5838	700	91-61067A3	18-9857	208
84-816608Q82	18-8835-1	171-181, 693	91-12037	18-9806E	205	91-61069T	18-9858	208
84-816608Q83	18-8834-1	171-181, 693	91-12427	18-9807	206	91-61077	18-9868	208
84-816761A12	18-8802-1	171-181, 693	91-12427T	18-9807	206	91-63616	18-9859	208
84-816761A17	18-8821-1	171-181, 693	91-14311A04	18-9874	206	91-63638T	18-9860	208

Mercury Marine (Cont.)			Mercury Marine (Cont.)			Mercury Marine (Cont.)		
O.E. #	SIERRA #	PAGE #	O.E. #	SIERRA #	PAGE #	O.E. #	SIERRA #	PAGE #
91-74057Q6	18-9782	200	92-858007Q01	18-9600-5P	196	332-5772A1	18-5881	359
91-74057Q6	18-9783	200	92-858008Q01	18-9650-5	196	332-5772A2	18-5881	359
91-75132	18-9896	205	92-858008Q01	18-9650-5P	196	332-5772A3	18-5881	359
91-78310	18-9861	209	92-858037K01	18-9530-3	186	332-5772A5	18-5881	359
91-813653	18-9873	212	92-858039K01	18-9530-7	186	332-7778A1	18-5775	358
91-817570T	18-9869	209	92-858042K01	18-9553-3	187	332-7778A12	18-5775	358
91-818162	18-9870	209	92-858042Q01	18-9553-3	187	332-7778A3	18-5775	358
91-818169T	18-9871	209	92-858057K01	18-9440-7P	188	332-7778A6	18-5775	358
91-821571A1	18-9872	209	92-858057K01	18-9440-7	188	332-7778A7	18-5775	358
91-821887A1	18-4459	439, 847	92-858058Q01	18-9600-2	196	332-7778A9	18-5775	358
91-850730Q01	18-9781	200	92-858058Q01	18-9600-2P	196	336-3948A2	18-5139	356
91-859046Q4	18-4459	439, 847	92-858061Q01	18-9600-6	196	336-3948A3	18-5139	356
91-859046T4	18-4459	439, 847	92-858062Q01	18-9600-7	196	336-3996A7	18-5855	366
91-87119	18-9862	212	92-858062Q01	18-9600-7P	196	336-4318A2	18-5139	356
91-878232	18-9896	205	92-858064Q01	18-9650-2	196	336-4318A3	18-5139	356
91-879172T28	18-79816	198	92-858064Q01	18-9650-2P	196	336-4318A4	18-5139	356
91-883704Q03	18-9794	200	92-858067Q01	18-9650-6	196	339-6222A8	18-5788	359
91-895343A02	18-9897	205	92-858067Q01	18-9650-6P	196	339-7370A13	18-5186	221
91-895343T01	18-9897	205	92-858068Q01	18-9650-7	196	339-7452A1	18-5776	358
91-895343T02	18-9897	205	92-858068Q01	18-9650-7P	196	339-7452A11	18-5778	358
91-896661	18-79814	205	92-858084K01	18-9552-3	187	339-7452A14	18-5778	358
91-89865	18-9863	209	92-877770K1	18-9300	Obsolete	339-7452A15	18-5777	358
91-89897	18-9866	209	92-883722K01	18-9440-8	189	339-7452A19	18-5777	358
91-8M0067546	18-4442	212, 840	92-883723K01	18-9440-3	189	339-7452A2	18-5776	358
91-8M0072133	18-9781	200	92-883724K01	18-9440-2	188	339-7452A21	18-5778	358
91-90244A1	18-9875	209	92-883724K01	18-9440-2P	188	339-7452A3	18-5776	358
91-90455	18-9896	205	92-883725K01	18-9440-4	188	339-7452A7	18-5777	358
91-904551	18-9896	205	92-883725K01	18-9440-4P	188	339-7452A8	18-5778	358
91-90455T	18-9896	205	92-8M0062765	18-8606	199	339-7452A9	18-5777	358
91-90455T1	18-9896	205	92-8M0071837	18-9200-2	197	339-832757A4	18-5186	221
91-90774	18-9865	209	92-8M0071837	18-9200-4	197	339-850227	18-5187	358
91-95830	18-4444	439, 847	92-8M0071838	18-9200-0	197	339-856991A1	18-5187	358
91-95830A1	18-4444	439, 847	92-8M0071841	18-9200-1	197	339-859738T1	18-23205	358
91-99379	18-9802	212, 365	92-8M0078618	18-9420CAT-7	191	339-880615T01	18-5154	358
91-99750A1	18-9801	210, 365	92-8M0078618	18-9420CAT-7P	191	339-883778A01	18-5159	358
91-99750A1	18-9801	210, 365	92-8M0078621	18-9400CAT-7	191	339-883778A02	18-5159	358
92-12564 2	22423	Obsolete	92-8M0078621	18-9400CAT-7P	191	339-8M0077473	18-5159	358
92-12564-1	22423	Obsolete	92-8M0078624	18-9440CAT-7	191	391-5075	18-5376	679
92-34227	1525607	201	92-8M0078624	18-9440CAT-7P	191	391-5075Q1	18-5376	679
92-342271	1525607	201	92-8M0078625	18-9420CAT-2	191	391-5076	18-0422	808
92-34227Q02	1525607	201	92-8M0078625	18-9420CAT-2P	191	391-5081	18-7143	449, 858
92-41669-1	37534	202	92-8M0078626	18-9420CAT-3	191	391-5088	18-5404-1	678
92-59327-1	37509	201	92-8M0078626	18-9420CAT-3P	191	391-5090	18-5314	677
92-730611	22423	Obsolete	92-8M0078627	18-9400CAT-2	191	391-5092	18-5338	678
92-755051	22423	Obsolete	92-8M0078627	18-9400CAT-2P	191	391-5092	18-5338	678
92-78383A12	18-9013	198	92-8M0078629	18-9440CAT-2	191	391-5093	18-5338	678
92-78383A12	18-9024	198	92-8M0078629	18-9440CAT-2P	191	391-7057	18-5404-1	678
92-78383A12	18-9065	198	97-31640B4	18-6011	440	391-7057T	18-5404-1	678
92-78383A12	18-9080	198	97-31640Q4	18-6011	440	391-898253001	18-5338	678
92-802833Q1	18-9420-2P	188	97-34672C	18-6013	853	391-898253004	18-5314	677
92-802833Q1	18-9420-2	188	97-762145	18-6016	440, 853	391-898253029	18-5404-1	678
92-802835Q1	18-9420-3P	188	97-76214Q5	18-6016	440, 853	392-2529	18-6256	702
92-802835Q1	18-9420-3	188	97-806188A1	18-6117A	853	392-2940	18-6254	702
92-802835Q1	18-9420-30	188	97-806188A1	18-6117M	853	392-6318	18-5369	679
92-802835Q1	18-9420-30P	188	97-806188A1	18-6117Z	853	392-6318T	18-5369	679
92-802836A1	18-9420-7P	188	97-806188Q01	18-6117A	853	392-6324	18-5347	678
92-802836A1	18-9420-7	188	97-806188Q01	18-6117M	853	392-6325	18-5303	677
92-802837Q1	18-9400-2P	188	97-806188Q01	18-6117Z	853	392-6326	18-5407	678
92-802837Q1	18-9400-2	188	97-806189	18-6067	854	392-6326T	18-5407	678
92-802841A1	18-9400-7P	188	97-806189	18-6067A	854	392-6329	18-5399	679
92-802841A1	18-9400-7	188	97-806189Q1	18-6067	854	392-7803A4	18-5438	680
92-802844Q02	18-9600-0	196	97-806189Q1	18-6067A	854	392-805570A2	18-5438	680
92-802859A1	18-9240-0	197, 840	97-806190	18-6089	854	392-806529A1	18-5433	358, 680
92-802863A1	18-9240-1	197, 840	97-806190B4	18-6089	854	392-8261A1	18-6768	702
92-802881A1	1525607	201	97-806190Q1	18-6089	854	392-8261A1	18-6799	702
92-802882A1	37534	202	97-821629Q1	18-6080	854	392-8263	18-6768	702
92-809056979	22423	Obsolete	97-821629Q1	18-6099	854	392-8263	18-6799	702
92-809819	37478	201	97-821630Q1	18-6094	854	392-863704T	18-5465	625
92-809820	37479	201	97-826134Q	18-6068	440, 854	392-881732	18-7648	680
92-809824	37509	201	97-888755Q03	18-6158M	853	392-898253002	18-5347	678
92-817529A12	18-9013	198	97-888756Q03	18-6158A	853	392-898253005	18-5303	677
92-817529A12	18-9024	198	97-888758Q03	18-6159A	853	392-8989	18-6255	702
92-817529A12	18-9065	198	97-888759Q03	18-6159M	853	392-9086	18-5353	678
92-817529A12	18-9080	198	97-888760Q03	18-6160M	853	392-9086T	18-5353	678
92-823506 1	37534	202	97-888761Q03	18-6160A	853	392-9089	18-5403	678
92-857389A1	18-9400-4P	188	332-4911A5	18-5787	358	392-9089Q	18-5403	678
92-857389A1	18-9400-4	188	332-4911A8	18-5787	358	392-9089T	18-5403	678
92-858007Q01	18-9600-5	196	332-5524A1	18-5775	358	392-9766	18-5352	678

Mercury Marine (Cont.)			Mercury Marine (Cont.)			Mercury Marine (Cont.)		
O.E. #	SIERRA #	PAGE #	O.E. #	SIERRA #	PAGE #	O.E. #	SIERRA #	PAGE #
392-9766Q1	18-5352	678	735-9715	18-4178	791	1347-804623R02	18-7605-1	153, 714
392-9766T	18-5352	678	735-97151	18-4178	791	1347-804623R1	18-7604-1	153, 714
392-9767	18-5403	678	735-9715T1	18-4178	791	1347-804624 R02	18-7615-1	153, 714
393-3230	18-5389	679	736-2343	18-4180	791	1347-804624 R1	18-7618-1	153, 715
393-4988	18-5389	679	737-6523	18-4189	791	1347-804624R02	18-7618-1	153, 715
393-4988T	18-5389	679	737-879194035	18-4189	791	1347-804624R1	18-7615-1	153, 714
393-4988T2	18-5389	679	743-3193A2	18-4620	403	1347-804625R02	18-7617-1	153, 715
393-9459	18-5385	679	743-3193A4	18-4620	403	1347-804625R1	18-7617-1	153, 715
393-9459Q1	18-5385	679	743-3366A1	18-4621	403	1347-804626 R02	18-7616-1	153, 715
393-9459T	18-5385	679	743-3366A2	18-4621	403	1347-816373A4	18-7615-1	153, 714
394-1100A2	18-5148	357	743-5172A6	18-4620	403	1347-818619	18-7609-1	153, 714
394-1100A3	18-5148	357	743-7716A2	18-4622	403	1347-818619 1	18-7609-1	153, 714
394-1130	18-5169	357	759-592010	18-4109	791	1347-818619 1R02	18-7609-1	153, 714
394-1130A1	18-5169	357	759-592012	18-4134	791	1347-818620	18-7608-1	153, 714
394-352A1	18-5148	357	759-661010	18-4109	791	1347-818620 1	18-7608-1	153, 714
397-359	18-5169	357	759-661012	18-4134	791	1347-818620R02	18-7608-1	153, 714
397-741	18-5169	357	759-80661A3	18-4109	791	1347-818621	18-7610-1	153, 714
398-174	18-5153	357	759-80661A7	18-4109	791	1347-818621 1	18-7610-1	153, 714
398-2202	18-5140	357	759-80661A8	18-4134	791	1347-818621 1R02	18-7610-1	153, 714
398-5255	18-5856	366	759-806661A5	18-4134	791	1347-818622	18-7603-1	153, 714
398-5454A17	18-5854	366	759-831210	18-4109	791	1347-818622 1	18-7603-1	153, 714
398-5454A21	18-5874	365	759-831212	18-4134	791	1347-818622R02	18-7603-1	153, 714
398-5454A22	18-5859	366	759-8312A2	18-4109	791	1347-8288A1	18-7616-1	153, 715
398-5454A25	18-5874	365	759-8312A6	18-4134	791	1347-8289A1	18-7618-1	153, 715
398-5454A32	18-5871	365	759-9015A4	18-4134	791	1347-8460A3	18-7619-1	153, 715
398-5454A35	18-5860	366	761-7131M	18-4135	403	1347-9142A2	18-7619-1	153, 715
398-5454A63	18-5874	365	761-7133M	18-4135	403	1347-9661A3	18-7605-1	153, 714
398-5454A7	18-5857	366	761-7134M	18-4135	403	1347-9863A3	18-7617-1	153, 715
398-5704A7	18-5865	366	761-7196M	18-4138	403	1356-4066	18-7096	720
398-5919A2	18-5874	365	761-7197M	18-4138	403	1356-4092	18-7096	720
398-5919A3	18-5859	366	761-7198M	18-4138	403	1356-5155	18-7096	720
398-5919A4	18-5866	366	761-7982M	18-4135	403	1356-5169	18-7096	720
398-5919A6	18-5874	365	761-7982T	18-4135	403	1376-5659A1	18-7603-1	153, 714
398-5919A7	18-5859	366	761-8484M	18-4138	403	1389-815396A2	18-7370N	152, 714
398-5919A8	18-5874	365	765-7443A11	18-4013	405	1389-8490A2	18-7370N	152, 714
398-6231A10	18-5872	Obsolete	765-7443A12	18-4560	405	1389-9350A2	18-7370N	152, 714
398-693	18-5206	357	765-7443A2	18-4560	405	1389-9562A1	18-7370N	152, 714
398-713	18-5207	357	765-7446A11	18-4014	405	1395-4808	18-7006-1	377
398-818535A15	18-5874	365	766-8667A36	18-4565	405	1395-6200	18-7004	377
398-832075A14	18-5874	365	766-8667A43	18-4565	405	1395-6452	18-7005	377
398-832075A20	18-5874	365	774-9137A10	18-4515	403	1395-7824	18-7233	378
398-832075-A21	18-5870	365	774-9137A14	18-4535	403	1395-811222	18-7750-1	378
398-832075A4	18-5870	365	776-8898A2	18-4535	403	1395-8112231	18-7211-1	377
398-832075A6	18-5873	365	776-9096A1	18-4156	403	1395-811357	18-7212	377
398-9610A19	18-5876	365	777-815965A4	18-4623	403	1395-811691 2	18-7355	377
398-9873A4	18-5867	365	777-815965A5	18-4624	403	1395-811691 3	18-7356	377
65L-13915-00-00	18-79901	733	777-815965A6	18-4625	403	1395-823635	18-7750-1	378
700-858294T1	18-4639	406	777-815965T4	18-4623	403	1395-8236351	18-7750-1	378
700-858295T1	18-4640	406	778-9015A2	18-4109	791	1395-8236352	18-7750-1	378
700-878571A2	18-4641	406	778-9441A3	18-4109	791	1395-8236353	18-7750-1	378
700-878572A2	18-4642	406	778-9441A5	18-4134	791	1395-8236354	18-7750-1	378
700-878573A2	18-4643	406	780-9229A10	18-4621	403	1395-8318	18-7061	378
700-878574A2	18-4644	406	780-9229A11	18-4622	403	1395-83181	18-7061	378
733-2278	18-4180	791	780-9229A7	18-4620	403	1395-8506	18-7354	377
733-3818	18-4160	791	783-9613A2	18-4017	403	1395-8673	18-7208	378
733-38181	18-4160	791	783-9613A3	18-4018	403	1395-879194024	18-7006-1	377
733-3819	18-4161	791	783-9613T2	18-4017	403	1395-8983	18-7208	378
733-3819	18-4191	791	783-9613T3	18-4018	403	1395-9022	18-7295	378
733-38191	18-4191	791	785-9737A10	18-4637	406	1395-9024	18-7215	377
733-4028	18-4161	791	785-9737T9	18-4635	406	1395-9179	18-7212	377
733-4028	18-4191	791	785-97386	18-7961	859	1395-9258	18-7057	378
733-66217	18-4180	791	785-9738T10	18-4638	406	1395-9258 1	18-7057	378
733-803850T	18-4161	791	785-9738T9	18-4636	406	1395-9267	18-36956	378
733-803850T	18-4191	791	936-810840	18-4489	649, 790	1395-9293	18-7209	378
735-6370	18-4173	791	936-986767	18-4489	649, 790	1395-9377	18-7212	377
735-6370	18-4173	791	938-803860T	18-4486	649, 790	1395-9594	18-72000	378
735-6371	18-4164	791	938-827178	18-4491	649, 790	1395-95951	18-7062	378
735-6538	18-4181	791	938-883297 1	18-4486	649, 790	1395-9599	18-7750-1	378
735-808661	18-4173	791	938-883490	18-4485	649, 790	1395-9645	18-7212	377
735-808674	18-4173	791	938-883490R1	18-4485	649, 790	1395-9650	18-7226	377
735-808674A1	18-4173	791	938-883490R50	18-4485	649, 790	1395-9725	18-7212	377
735-850097	18-4173	791	938-884741R	18-4485	649, 790	1395-9761	18-7212	377
735-850098	18-4164	791	938-884741R50	18-4485	649, 790	1395-97611	18-7212	377
735-9431	18-4164	791	1337-2103	18-7078	720	1395-9803	18-7212	377
735-9686	18-4173	791	1337-2604	18-7078	720	1396-4148	18-7227	721
735-9687	18-4164	791	1346-2770	18-7080	720	1396-4656	18-7081	720
735-9703	18-4173	791	1347-804623A1	18-7605-1	153, 714	1396-5222	18-7096	720
735-9704	18-4164	791	1347-804623R02	18-7604-1	153, 714	1396-5238	18-7096	720

Mercury Marine (Cont.)			Mercury Marine (Cont.)			Mercury Marine (Cont.)		
O.E. #	SIERRA #	PAGE #	O.E. #	SIERRA #	PAGE #	O.E. #	SIERRA #	PAGE #
1397-2060	18-7200	721	1547-815930A16	18-2416	827	819762A4-A7	18-6777	364
1397-2067	18-7746	720	1547-815930A3	18-2419	827	81977A8-A9	18-6777	364
1397-2072	18-7070	719	1547-815930A6	18-2416	827	85785-2	18-7229	724
1397-2133	18-7078	720	1547-8265A15	18-2450	827	99186-1	18-6273-1	364
1397-2150	18-7855	733	1547-8265A16	18-2451	827	F694961-1	18-2346	842
1397-2605	18-7078	720	1547-8265A17	18-2452	827	F74305-1	18-7176	449, 858
1397-2631	18-7746	720	1547-8265A17	18-2453	827	6325	18-5345	678
1397-2634	18-7746	720	1547-861063A12	18-2416	827	12415	18-5896	391
1397-2637	18-7070	719	1547-861063A4	18-2411	826	12449	18-5957	703
1397-2637	18-7746	720	1547-861063A6	18-2419	827	12449	18-5965	703
1397-3306	18-7072	720	1547-9412A20	18-2450	827	12449	18-5966	703
1397-3327	18-7201	721	1547-9412A21	18-2451	827	12708	18-1240	811
1397-3458	18-7071	719	1547-9412A22	18-2452	827	12784	18-6400	830
1397-3459	18-7746	720	1547-9412A23	18-2453	827	13037	18-5804	700
1397-3462	18-7078	720	1547-9412A30	18-2450	827	13220	18-7751	646, 719
1397-3464	18-7070	719	1547-9412A35	18-2450	827	14244	18-0616	790
1397-3464	18-7746	720	1547-9412A36	18-2452	827	14259	18-0612	790
1397-4329	18-7072	720	1623-4110A13	18-2443	827	14586	18-3549	391
1397-5635	18-7072	720	1623-4110A4	18-2443	827	14698	18-2373	850
1397-5830	18-7075	719	1623-4110A6	18-2443	827	14760	18-0615	790
1397-5831	18-7075	719	1623-5356A18	18-2443	827	14957	18-7824-2	183, 790
1397-5837	18-7202	721	1623-5356A19	18-2443	827	14957	18-7876-1	183, 790
1397-6367	18-7076	720	1623-5356A20	18-2443	827	16253	18-7381	378
1397-6367A1	18-7076	720	1623-5356A3	18-2443	827	16755	18-2516	811
1397-6638	18-7072	720	1623-5356A4	18-2402	827	16755	18-2615	814
1397-7099	18-7075	719	1623-815822A3	18-2400	826	17340	18-1400	791
1397-7539	18-7095	720	1623-815822A32	18-2400	826	17437	18-3599-1	S/S to 18-3599-2
1397-7540	18-7095	720	1623-815822A36	18-2415	827	17437	18-3599-2	734
1397-7542	18-7070	719	1623-815822A5	18-2400	826	17646	18-6771	702
1397-7542	18-7746	720	1623-815822A53	18-2400	826	17649	18-6772	702
1397-7543	18-7070	719	1623-8951A14	18-2443	827	17670	18-3577-1	S/S to 18-3577-2
1397-7543	18-7746	720	1623-8951A15	18-2401	827	17670	18-3577-2	734
1397-7544	18-7095	720	1623-8951A19	18-2443	827	18525	18-6771	702
1397-7547	18-7746	720	1623-8951A2	18-2443	827	18717	18-8309	425
1397-8535	18-7095	720	1623-8951A23	18-2443	827	19273	18-7249	378
1397-8545	18-7869	733	1623-8951A27	18-2401	827	19643	18-4261	425
1397-8546	18-7201	721	1623-8951A37	18-2401	827	20121	18-5224	363, 696
1397-8582	18-7666	721	1623-8951A43	18-2443	827	20175	18-2146	830
1397-8760	18-7075	719	1623-8951A5	18-2401	827	20250	18-2015	857
1397-8767	18-7869	733	1647-9148R84	18-4851	437	20311	18-7459	449, 859
1397-8872	18-7070	719	1647-9148T93	18-4832	437	22879	18-2149	836
1397-8872	18-7746	720	1667-9011G59	18-4830	437	25661	18-5836	369, 701
1397-8873	18-7746	720	1667-9011R6	18-4850	437	29196	18-8070	386
1397-8952	18-7077	720	2704-812896A2	18-4626	403	29196	18-8084	386
1397-8959	18-7201	721	2704-821896A3	18-4627	403	29880	18-2149	836
1397-9723	18-7095	720	2704-821896A4	18-4628	403	30605	18-3117	393, 735
1398-3089	18-7080	720	2704-821896A6	18-4626	403	31640	18-6011	440
1399-1136	18-7832	389	2704-826191A4	18-4626	403	31640	18-6011A	440
1399-1138	18-7057	378	2704-826191A6	18-4626	403	31640	18-6241	440, 853
1399-1473	18-7057	378	2704-826191T4	18-4626	403	31659	18-2753-2	834
1399-1717	18-7006-1	377	3302-804844	18-7098-1	720	32170	18-6013	853
1399-1754	18-7832	389	3302-804844001	18-7098-1	720	32435	18-3117	393, 735
1399-2015	18-7006-1	377	3302-804844002	18-7098-1	720	32489	18-3219	832
1399-3523	18-7006-1	377	3302-804845	18-7097	720	32716	18-7824-2	183, 774
1399-3938	18-7832	389	3302-9031	18-7202	721	32716	18-7876-1	183, 790
1399-5135	18-7007	377	3302-9033	18-7859	717	32717	18-7824-2	183, 774
1399-5137	18-7815	378	3302-9437	18-7097	720	32717	18-7876-1	183, 790
1399-5198	18-7007	377	3304-9354A2	18-7604-1	153, 714	32722	18-7256	149, 725
1399-99	18-2575	420	3310-806077A2	18-7370N	152, 714	32728	18-3551	740
1547-3917A13	18-2450	827	3310-806078A2	18-7370N	152, 714	32734	18-2750	834
1547-3917A16	18-2451	827	3310-806969 R01	18-7613-1	153, 714	32768	18-3107	393
1547-3917A21	18-2450	827	3310-806969A1	18-7613-1	153, 714	33149	18-2193	813
1547-3917A30	18-2451	827	3310-807312A1	18-7611-2	153, 714	33261	18-5838	700
1547-3917A32	18-2450	827	3310-807312R02	18-7611-2	153, 714	33266	18-5315-1	684
1547-3917A37	18-2450	827	3310-860070A2	18-7370N	152, 714	33270	18-5717	700
1547-3917A38	18-2451	827	3310-861245A1	18-7376N	152, 714	33316	18-5838	700
1547-3917A4	18-2451	827	3310-861448A1	18-7375N	152, 714	33662	18-5345	678
1547-3917A8	18-2451	827	3310-861448A1	18-7375N	152, 714	33667	18-5385	679
1547-5523A11	18-2451	827	3310-864941A01	18-7373N	152, 714	33700	18-5310	677
1547-5523A12	18-2450	827	3310-864942A01	18-7375N	152, 714	33706	18-5344	678
1547-5523A2	18-2450	827	3310-864943A01	18-7376N	152, 714	33707	18-5300	678
1547-5523A49	18-2453	827	3310-864943A01	18-7639	153, 714	33708	18-5384	679
1547-5523A67	18-2452	827	3310-866142A03	18-79994N	715	33765	18-5386	679
1547-5523A67	18-2453	827	3310-866142A04	18-79994N	715	33957	18-3575	S/S to 18-3593
1547-5523A68	18-2450	827	3310-866143A03	18-79995N	715	33981	18-2162	832
1547-5523A8	18-2451	827	815279-1	18-5741	368	33981	18-2162E	832
1547-5523A9	18-2450	827	815279-3	18-5743	368	34127	18-6012	853
1547-815930A13	18-2419	827	815279-5	18-5743	368	34235	18-5311	676

Mercury Marine (Cont.)			Mercury Marine (Cont.)			Mercury Marine (Cont.)		
O.E. #	SIERRA #	PAGE #	O.E. #	SIERRA #	PAGE #	O.E. #	SIERRA #	PAGE #
34282	18-1402	791	54705	18-3107	393	72778	18-3350	735
34623	18-5899	751	54793	18-3599-1	S/S to 18-3599-2	73345	18-4233	440
34625	18-5898	751	54793	18-3599-2	734	73813	18-1990	780
35329	18-4492	648, 791	54870	18-1990	780	73873	18-8227	791
35341	18-3599-1	S/S to 18-3599-2	54981	18-5802	368, 700	74639	18-2753-2	834
35341	18-3599-2	734	55481	18-7853-1	136, 387, 730	75384	18-5697	375
35583	18-1402	791	55989	18-60151-9	853	75639	18-0615	790
35884	18-3551	740	56045	18-6841	703	75661	18-5674	375
35915	18-3759	842	56045	18-6842	703	75692	18-3553	391
35957	18-3593	734	56045	18-5956	703	75832	18-2104	831
35983	18-4296	832	56045	18-5957	703	75832	18-2174	831
35992	18-3752	832	56153	18-1401	791	76214	18-6016	440, 853
36147	18-2101	831	56879	18-3584	734	76214	18-60161	440, 853
36223	18-2752	834	57380	18-5650	375	76214	18-6016A	440, 853
36312	18-2104	831	57882	18-7232	646, 724	76214	18-6244	440, 853
36312	18-2174	831	58033	18-5318	677	76270	18-3552	740
36525	18-5897	751	58034	18-5346	678	76865	18-2130	843
37369	18-3575	S/S to 18-3593	58086	18-3584	734	77123	18-1705	831
37369	18-3593	734	58217	18-5418	678	77326	18-2144	411
37721	18-0539	425	58231	18-5315-1	684	77443	18-2148	850
37951	18-3599-1	S/S to 18-3599-2	58749	18-2104	831	77481	18-2150	843
37951	18-3599-2	734	58749	18-2174	831	77594	18-7278	149, 725
37967	18-2196	842	59078	18-3550	740	78016	18-5420	678
37973	18-2150	843	59137	18-3551	740	78249	18-2143	411
38463	18-7878-1	183, 790	59755	18-6841	703	78385	18-5724	704
38547	18-5433	358, 680	59755	18-6842	703	78458	18-2760	834
39383	18-2128	830	59755	18-5956	703	78477	18-6841	703
39384	18-2125	830	59755	18-5957	703	78477	18-6842	703
39920	18-1973	778	59972	18-3577-1	S/S to 18-3577-2	78477	18-5956	703
41431	18-2104	831	59972	18-3577-2	734	78477	18-5957	703
41431	18-2174	831	60207	18-4008	780	78485	18-7274	149, 725
41639	18-7230	724	60252	18-4009	780	78687	18-2144	411
41815	18-7879-1	183, 790	60565	18-7875	183, 790	78820	18-7275	149, 725
42785	18-5740	704	60658	18-3599-1	S/S to 18-3599-2	79448	18-3751	438, 843
42838	18-8305	425	60658	18-3599-2	734	85552	18-2742	441
43023	18-1838	393	60687	18-5838	700	86177	18-5658	375
43433	18-2149	836	60930	18-2727	735	86234	18-7278	149, 725
43436	18-3754	836	61073	18-2196	842	86246	18-7274	149, 725
43557	18-5395	679	61851	18-1906	779	86247	18-7275	149, 725
43585	18-1730	393	62092	18-7267	149, 725	86459	18-9099	850
43713	18-2724	833	62092	18-7267	149, 725	86814	18-1710	834
45523	18-2148	850	62104	18-2322	832	87581	18-5315-1	684
46020	18-2125	830	62424	18-5315-1	684	88035	18-2372	850
46472	18-1402	791	62981	18-3553	391	88726	18-8305	425
46692	18-7878-1	183, 790	63196	18-7275	149, 725	89876	18-7853-1	136, 387, 730
46744	18-1402	791	64850	18-5317	677	89902	18-5838	700
46860	18-7275	149, 725	65028	18-2150	843	90794	18-6841	703
46895	18-3139	393	65057	18-5802	368, 700	90794	18-6842	703
47441	18-1977-1	741	65142	18-3575	S/S to 18-3593	90794	18-5956	703
47585	18-7278	149, 725	65142	18-3593	734	90794	18-5957	703
47587	18-1910	741	65547	18-1705	831	90806	18-5899	751
47588	18-1910	741	65864	18-5420	678	90880	18-1905	779
47594	18-3557	740	66062	18-2130	843	92497	18-5957	703
47638	18-1995	780	66066	18-2150	843	92497	18-5965	703
47886	18-5808	368	66067	18-2286	842	92497	18-5966	703
48045	18-1990	780	66071	18-3752	832	92802	18-2733	735
48752	18-3114	393, 734	66850	18-3553	391	93320	18-1908	779
48753	18-3115	393	67209	18-2144	411	93322	18-1985	779
49117	18-1402	791	67210	18-2143	411	93423	18-3199	843
49139	18-3577-1	S/S to 18-3577-2	67859	18-3577-1	S/S to 18-3577-2	93424	18-3198	843
49139	18-3577-2	734	67859	18-3577-2	734	93476	18-0613	790
52022	18-7824-2	183, 774	68100	18-2342	842	93477	18-0615	790
52022	18-7876-1	183, 790	68575	18-5656	375	94318	18-5817	368, 701
52226	18-3599-1	S/S to 18-3599-2	69668	18-8305	425	94576	18-3350	735
52226	18-3599-2	734	69729	18-6841	703	94916	18-3351	735
52352	18-5315-1	684	69729	18-6842	703	97257	18-5897	751
52353	18-3575	S/S to 18-3593	69729	18-5956	703	97258	18-5898	751
52353	18-3593	734	69729	18-5957	703	97351	18-2707	843
52444	18-7848-1	136, 387, 731	70125	18-7665	721	97399	18-7288-1	150, 725
52731	18-7824-2	183, 774	70977	18-3113	393	97401	18-7283	149, 725
52731	18-7876-1	183, 790	70981	18-2762	834	99186	18-6273-1	364
52999	18-4009	780	71327	18-7278	149, 725	110990	18-0980	810
53114	18-2759	834	71464	18-7667	721	195141	18-5315-1	684
54111	18-7824-2	183, 774	71646	18-7274	149, 725	256611	18-5836	369, 701
54111	18-7876-1	183, 790	71683	18-3584	734	316403	18-6011	440
54534	18-3577-1	S/S to 18-3577-2	72625	18-7667	721	316404	18-6011	440
54534	18-3577-2	734	72638	18-1402	791	324351	18-3117	393, 735
54552	18-7267	149, 725	72777	18-3351	735	393831	18-2128	830

Mercury Marine (Cont.)			Mercury Marine (Cont.)			Mercury Marine (Cont.)		
O.E. #	SIERRA #	PAGE #	O.E. #	SIERRA #	PAGE #	O.E. #	SIERRA #	PAGE #
428381	18-8305	425	824519	18-2346	842	8213542	18-4577	393
460201	18-2125	830	826134	18-6068	440, 854	8216631	18-6960	703
621041	18-2322	832	828151	18-5849	369	8227731	18-0202-9	438
681001	18-2342	842	828708	18-6773	364	8227772	18-6014	440, 853
684311	18-7083	386	834832	18-6844	703	8235471	18-1839	393
758321	18-2104	831	834832	18-6454	372	8503991	18-3599-1	S/S to 18-3599-2
758321	18-2174	831	835076	18-7749	720	8503991	18-3599-2	734
762142	18-6016	440, 853	846070	18-5817	368, 701	8504541	18-3577-1	S/S to 18-3577-2
774811	18-2150	843	849899	18-7683	709	8504541	18-3577-1	S/S to 18-3577-2
802206	18-7116	449, 858	849934	18-7682	709	8504541	18-3577-2	734
802231	18-7121	449, 858	850399	18-3599-1	S/S to 18-3599-2	8504541	18-3577-2	734
802276	18-2013	857	850399	18-3599-2	734	8504851	18-5408	678
802276	18-2026	857	850454	18-3577-1	S/S to 18-3577-2	8507521	18-2162	832
802464	18-5107-1	680	850454	18-3577-2	734	8507521	18-2162E	832
802630	18-7663	709	850458	18-0614	790	8507522	18-2162	832
802632	18-33104	710	850484	18-5362	677	8507522	18-2162E	832
803148	18-7757	710	850485	18-5408	678	16066004	18-25400	358
803149	18-7697	709	850487	18-5107-1	680	46020002	18-2125	830
803470	18-7878-1	183, 790	853292	18-5852	369	80707809	18-1957-2	777
804184	18-7382	378	854445	18-7668	710	88245191	18-2346	842
804412	18-5107-1	680	858763	18-7083	386	392889925	18-7493	680
804418	18-5354	678	859168	18-6829	374	802630001	18-7663	709
804424	18-5408	678	861249	18-7550	709	811637001	18-5107-1	680
804540	18-3638	391	861260	18-7692	711	811637002	18-5107-1	680
805100	18-3784	846	861425	18-7551	710	833072002	18-3537	390
805629	18-5021	780	861578	18-8297	791	833072003	18-3536	390
806105	18-6079	854	862132	18-1711	830	833072004	18-3537	390
806105	18-6093	854	862209	18-1710	834	850399002	18-3599-1	S/S to 18-3599-2
806105	18-6093A	854	862998	18-7701	709	850399002	18-3599-2	734
806189	18-6114	854	864493	18-43015	740	850454002	18-3577-1	S/S to 18-3577-2
806190	18-6092	854	878187	18-7554	710	850454002	18-3577-2	734
806190	18-6092A	854	878341	18-3599-1	S/S to 18-3599-2	855676002	18-43175	390
806490	18-5897	751	878341	18-3599-2	734	864297001	18-7556	680
807057	18-5851	369	878342	18-3577-1	S/S to 18-3577-2	879150150	18-7682	709
808483	18-5354	678	878342	18-3577-2	734	879194024	18-7006-1	377
808484	18-5405	678	879036	18-2830-1	809	879194241	18-7964	S/S to 18-7964-1
809064	18-7748	720	879078	18-9099	850	879194241	18-7964-1	733
809065	18-7749	720	879366	18-1194	406	881693002	18-7698	710
809066	18-7664	721	880817	18-3575	S/S to 18-3593	885599004	18-3535	390
809462	18-5811	368, 701	880817	18-3593	734	892615001	18-7646	710
809463	18-5811	368, 701	881540	18-7979	389	892615002	18-7646	710
809569	18-7380	378	881731	18-7660	709	898253003	18-5345	678
809910	18-0612	790	882571	18-6948	661, 703	898253005	18-5345	678
811091	18-5897	751	883514	18-3573	734	898253007	18-5318	677
811536	18-36906	721	883885	18-3584	734	898253008	18-5418	678
811549	18-0614	790	883925	18-3573	734	898253009	18-5402	678
811573	18-3577-1	S/S to 18-3577-2	884727	18-3575	S/S to 18-3593	898253010	18-5405	678
811573	18-3577-2	734	884727	18-3593	734	898253011	18-5406	678
811618	18-6751	363	884790	18-5245	678	898253012	18-5408	678
811628	18-6774	364	884792	18-5244	678	898253013	18-5245	678
811635	18-5361	678	885176	18-7688	710	11497M	18-7833	382
811636	18-5406	678	888731	18-5243	678	11502M	18-7765	378
811637	18-5107-1	680	892615	18-7646	710	12076A1	18-1975-1	779
811639	18-5108	680	892681	18-33211	709	12076A2	18-1972	778
811841	18-3599-1	S/S to 18-3599-2	893409	18-3607	440	12076A2	18-1975-1	779
811841	18-3599-2	734	895338	18-3556	391	12449A1	18-5957	703
814472	18-6275	697	934231	18-3199	843	12449A1	18-5965	703
814755	18-3575	S/S to 18-3593	934233	18-3199	843	12449A1	18-5966	703
814755	18-3593	734	934241	18-3198	843	12449A1	18-5966	703
815425	18-5899	751	934243	18-3198	843	12632A3	18-2195	837
815471	18-2145E	836	1100990	18-0980	810	12632A4	18-2175	837
816597	18-3151	393, 735	4602002	18-2125	830	12632A6	18-2321	837
816607	18-1728	834	8052732	18-3649	740	12632A7	18-2195	837
816685	18-3749	832	8055361	18-2097	830	12644A1	18-4457	106, 856
816770	18-5707	368	8072521	18-3551	740	12644Q01	18-4457	856
816877	18-7083	386	8072522	18-3649	740	12784A10	18-6401	830
817276	18-3122	393, 735	8072531	18-3551	740	12784A4	18-6401	830
817377	18-5475	683	8094621	18-5811	368, 701	12784T	18-6400	830
817378	18-5443	680	8094631	18-5811	368, 701	12886A6	18-1800	411
821509	18-5852	369	8107492	18-7213	377	13191A1	18-4221	440
821629	18-6080A	854	8107493	18-7214	377	13310T1	18-5674	375
821630	18-6094A	854	8168111	18-3752	832	13330A3	18-8005EP-1	140, 385
821630	18-6240	854	8168112	18-3752	832	13330A3	18-8005S	146
821663	18-6960	703	8168771	18-7083	386	13330Q	18-8005S	146
822777	18-6014	440, 853	8168772	18-7083	386	13447A1	18-5313-1	684
823033	18-5182	358	8168773	18-7083	386	13524A4	18-5432	678
823034	18-5793	359	8172761	18-3122	393, 735	13524A5	18-5431	678
823728	18-7749	720	8172763	18-3122	393, 735	13524A6	18-5432	678

Mercury Marine (Cont.)			Mercury Marine (Cont.)			Mercury Marine (Cont.)		
O.E. #	SIERRA #	PAGE #	O.E. #	SIERRA #	PAGE #	O.E. #	SIERRA #	PAGE #
13524Q06	18-5432	678	19405A4	18-5432	678	35993A1	18-0577	832
13524T1	18-5431	678	19543A10	18-2157	835	36223A1	18-2752	834
13753A2	18-5396	679	19543A10	18-2159	835	36223A2	18-2752	834
14034A3	18-2420	851	19543A10	18-2190	835	37611A1	18-2189	835
14034A5	18-2420	851	19543A10	18-2190E	835	38399A2	18-2189	835
14034F1	18-2420	851	19543A2	18-2157	835	38965A1	18-2171	837
14034T	18-2420	851	19543A2	18-2159	835	38965A2	18-2171	837
14034T10	18-2420	851	19543A2	18-2190	835	39383T	18-2128	830
14035A3	18-2421	851	19543A2	18-2190E	835	39920A1	18-1973	778
14035A5	18-2421	851	19543A2	18-2190E	835	41141A2	18-7284	149, 725
14035F1	18-2421	851	19543A4	18-2157	835	41155A1	18-9099	850
14035T	18-2421	851	19543A4	18-2159	835	41155A2	18-9099	850
14035T10	18-2421	851	19543A4	18-2190	835	41639A1	18-7230	724
14244T	18-0616	790	19543A8	18-2157	835	41951A1	18-2157	835
14336A15	18-6747	701	19543A8	18-2159	835	41951A1	18-2159	835
14336A15	18-6813	702	19543A8	18-2190	835	41951A1	18-2190	835
14336A15	18-6752	701	19543A8	18-2190E	835	41951A1	18-2190E	835
14336A17	18-6747	701	19543T1	18-2603	836	42419A1	18-6749	701
14336A17	18-6752	701	19543T1	18-2603E	836	42419A1	18-6749	701
14336A20	18-6813	702	19543T2	18-2603	836	42419A1	18-6750	701
14336A20	18-6274	365	19543T2	18-2603E	836	42431M	18-3426	398
14336A20	18-6746	702	19755A08	18-2196	842	42724A3	18-3219	832
14336A20	18-6746	702	19755A2	18-2286	842	42725A3	18-35437	725
14336A22	18-6747	701	19755A4	18-2196	842	42725A3	18-7282	149, 725
14336A22	18-6752	701	22831A1	18-8069	386	42909A1	18-7818-1	382
14336A25	18-6746	702	22831A3	18-8069	386	42909A2	18-7818-1	382
14336A28	18-6747	701	22831A4	18-8069	386	42909A3	18-7818-1	382
14336A28	18-6752	701	22831B3	18-8069	386	42909A4	18-7818-1	382
14336A31	18-6746	702	22831Q3	18-8069	386	43396A2	18-6249	441
14336A6	18-6747	701	23014A1	18-7804	382	43396A2	18-6249A	441
14336A6	18-6813	702	25661T1	18-5836	369, 701	43432A2	18-2145	835
14336A6	18-6752	701	30185A1	18-8070	386	43557A1	18-5395	679
14336A8	18-6813	702	30185A1	18-8084	386	43567A1	18-1567	433
14336A8	18-6746	702	30185A3	18-8070	386	43567T1	18-1567	433
14336A8	18-6769-1	702	30185A3	18-8084	386	43994A2	18-6066	853
14336A9	18-6747	701	30185B3	18-8070	386	43994A2	18-6066A	853
14336A9	18-6813	702	30185B3	18-8084	386	43994A2	18-6243	853
14336A9	18-6752	701	30185Q3	18-8070	386	44354A10	18-1976-2	779
14336A9	18-6753	701	30185Q3	18-8084	386	44354A13	18-1976-2	779
14505A2	18-2172	837	31640A1	18-6011	440	44354A3	18-1976-2	779
14586A3	18-43052	390	31640A1	18-6011A	440	44354A9	18-1976-2	779
14698T	18-2373	850	31640A1	18-6241	440, 853	45518A1	18-2161	832
14698T10	18-2373	850	31640A2	18-6011	440	45518A2	18-2161	832
15103A3	18-1137	795	31640A4	18-6011	440	45518A3	18-2161	832
16061T	18-5792	359	31640Q4	18-6011A	440	45589A1	18-2169	832
16457A4	18-5395	679	31640Q4	18-6241	440, 853	45589A3	18-2169	832
16610M	18-8070	386	31640T6	18-6011	440	45706A1	18-2142	850
16755A1	18-2516	811	31640T6	18-6011A	440	45706A12	18-2142	850
16755A1	18-2615	814	31640T6	18-6241	440, 853	45706A14	18-2142	850
16755Q1	18-2516	811	32170A1	18-6013	853	45706A3	18-2142	850
16755Q1	18-2615	814	32193A2	18-5433	358, 680	45706A4	18-2148	850
16755T1	18-2615	814	32489A2	18-3219	832	45706A6	18-2142	850
16792A33	18-7508	791	32492A2	18-2171	837	45706A8	18-2142	850
16792A39	18-7508	791	32492A3	18-2171	837	46020T	18-2125	830
17177A1	18-5313-1	684	32492A5	18-2171	837	463999A2	18-6014	440, 853
17340T	18-1400	791	32657A3	18-9099	850	46399A1	18-6014	440, 853
17649T	18-6772	702	32657A4	18-9099	850	46399A1	18-6014A	440, 853
17693A2	18-7633	850	32734A3	18-2750	834	47441A1	18-1977-1	741
18309A2	18-2412	S/S to 18-2412-1	32992A1	18-2189	835	47487T	18-5978	704
18309A2	18-2412-1	837	33662Q	18-5345	678	47587A2	18-1910	741
18311A17	18-2412	S/S to 18-2412-1	33765T	18-5386	679	47638A1	18-1995	780
18311A17	18-2412-1	837	33981T	18-2162	832	47886T	18-5808	368
18311A2	18-2412	S/S to 18-2412-1	33981T1	18-2162	832	48752T	18-3114	393, 734
18311A2	18-2412-1	837	33981T1	18-2162E	832	49518A1	18-2248	835
18312A3	18-2382	832	34086A1	18-2189	835	49964A1	18-1971	778
18495A12	18-5790	359	34127A1	18-6012	853	49964A2	18-1971	778
18495A19	18-5790	359	34127A2	18-6012	853	52073A1	18-1960-1	777
18495A26	18-5790	359	34127T1	18-6012	853	52390A1	18-1955-1	777
18525A1	18-6771	363, 702	34127T2	18-6012	853	52731A1	18-7824-2	183, 774
18643A5	18-2323	837	34235Q1	18-5250	676	52731A1	18-7876-1	183, 790
18654A1	18-2750	834	34235T	18-5311	676	52969A1	18-1960-1	777
19052A3	18-5791	359	34235T1	18-5250	676	53114A1	18-2759	834
19052A5	18-5791	359	34762A1	18-6013	853	53779A1	18-1978	778
19052A8	18-5791	359	34765A1	18-4456	106, 856	53779A2	18-1978	778
19217A1	18-6777	364	34765A2	18-4456	856	54099A1	18-1962-1	777
19217A5	18-6777	364	35187A1	18-2248	835	54099A5	18-1962-1	777
19291A3	18-2370	433	35187A2	18-2248	835	54100A1	18-1958-1	777
19297A3	18-2145	835	35187A4	18-2248	835	54100A5	18-1958-1	777

Mercury Marine (Cont.)			Mercury Marine (Cont.)			Mercury Marine (Cont.)		
O.E. #	SIERRA #	PAGE #	O.E. #	SIERRA #	PAGE #	O.E. #	SIERRA #	PAGE #
54293A10	18-5822	368	66599A1	18-7811	382	78403A1	18-5957	703
54293A13	18-5822	368	66599A2	18-7812	382	78403A2	18-6841	703
54293A4	18-5822	368	66599A3	18-7813	382	78403A2	18-6842	703
55278A1	18-7807	382	67914A2	18-6763	702	78403A2	18-5956	703
55278A3	18-7809	382	68162A1	18-5798	366	78403A2	18-5957	703
55278A4	18-7809	382	68162A3	18-5797	366	78458A1	18-2760	834
55278A5	18-7808	382	68162A5	18-5798	366	78459A1	18-1993	741
55538A2	18-1973	778	68162A6	18-5797	366	786214A2	18-6016	440, 853
55989A3	18-60151-9	853	68162A8	18-5798	366	78687T	18-2144	411
55989A3	18-6015-9	853	68521A3	18-5313-1	684	78984A08	18-1993	741
55989A3	18-6015A-9	853	68521A4	18-5313-1	684	78984A1	18-1993	741
55989A3	18-6242-9	853	68704A1	18-1148	795	79271A4	18-6763	702
55989A4	18-60151-9	853	69354A1	18-2413	837	79271A4	18-6768	702
55989A9	18-60151-9	853	69354A2	18-2413	837	79271A4	18-6799	702
55989Q9	18-60151-9	853	70125A02	18-7665	721	802128A1	18-7831	140, 390
55989Q9	18-6015-9	853	70125A1	18-7665	721	802371A1	18-5181	358
55989Q9	18-6015A-9	853	70981A3	18-2762	834	802630T	18-7663	709
55989Q9	18-6242-9	853	71464A01	18-7667	721	802630T01	18-7663	709
55989T9	18-60151-9	853	71683A1	18-3584	734	802632T	18-33104	710
55989T9	18-6015-9	853	72436A1	18-6011	440	802706A1	18-7738	377
55989T9	18-6015A-9	853	73020A1	18-2191	842	803061T1	18-3569	390
55989T9	18-6242-9	853	73020A14	18-2191	842	803470Q	18-7878-1	183, 790
56211A1	18-2191	842	73020A20	18-2376	843	803844T01	18-25513	358
57882T	18-7232	646, 724	73345A1	18-4233	440	804346T1	18-7743	377
58217Q	18-5418	678	73679A2	18-2157	835	804483T	18-5354	678
58397A2	18-6749	701	73679A2	18-2159	835	805016A1	18-7234	724
58397A3	18-6749	701	73679A2	18-2190	835	805025A2	18-7326	150, 725
58759A1	18-1960-1	777	73679A2	18-2190E	835	805025A2	18-8867	724
58759A10	18-1960-1	777	73723A01	18-2248	835	805101T	18-3787	847
58759A13	18-1960-1	777	73723A1	18-2248	835	805185A36	18-5471	683
58759A14	18-1960-1	777	73813A1	18-1990	780	805185A37	18-5470	683
59078A1	18-3550	740	73813F1	18-1990	780	805217A1	18-7684	709
59078T3	18-3650	740	73873A1	18-8227	791	805218T	18-7600	709
59137A1	18-3551	740	74313A4	18-1131	795	805222A1	18-5484-1	683
59341A1	18-56870	650	74436A9	18-6768	702	805223T	18-7702	751
59826A1	18-2173	837	74436A9	18-6799	702	805224A1	18-7632	S/S to 18-7632-1
59826A3	18-2173	837	74639A2	18-2753-2	834	805224A1	18-7632-1	709
59829A1	18-9218	830	74905A3	18-5313-1	684	805226A1	18-7630	709
59830A1	18-2146	830	75282A1	18-4221	440	805320A03	18-7633	850
59830A5	18-9218	830	75832A1	18-2104	831	805320A1	18-7633	850
59830A7	18-2146	830	75832A1	18-2174	831	805536A1	18-2097	830
59861A1	18-1993	741	75832A2	18-2104	831	805536A2	18-2097	830
59861A4	18-1993	741	75832A2	18-2174	831	805544T	18-7703	710
60252A2	18-4009	780	75832A3	18-2104	831	805656A2	18-7326	150, 725
60372A1	18-1910	741	75832A3	18-2174	831	805656A2	18-8867	724
60372A2	18-1910	741	75832T	18-2104	831	805656A5	18-7326	150, 725
60426A1	18-1971	778	75832T	18-2174	831	805656A5	18-8867	724
60427A2	18-1978	778	75832T1	18-2104	831	805656A6	18-7326	150, 725
60932A1	18-2751	834	75832T1	18-2174	831	805656A6	18-8867	724
60932A4	18-2751	834	75962A10	18-43052	390	805759A1	18-5395	679
62092T	18-7267	149, 725	75962A11	18-43052	390	805759A2	18-5395	679
6231A4	18-5872	Obsolete	75962A9	18-43052	390	805759A5	18-5395	679
6231A5	18-5872	Obsolete	762142A1	18-6016	440, 853	805759Q3	18-5273	677
6231A6	18-5872	Obsolete	76214A5	18-6016	440, 853	805759T	18-5395	679
62351A1	18-5707	368	76214Q5	18-60161	440, 853	805759T1	18-5395	679
62351A2	18-5707	368	76214Q5	18-6016A	440, 853	805759T3	18-5273	677
63115A12	18-7633	850	76214Q5	18-6244	440, 853	805884T	18-5965	703
63908A2	18-1910	741	76214T3	18-60161	440, 853	80606M	18-7839	382
65057A1	18-5802	368, 700	76214T3	18-6016A	440, 853	806105A1	18-6079	854
65057T1	18-5802	368, 700	76214T3	18-6244	440, 853	806105A1	18-6093	854
65142A1	18-3575	S/S to 18-3593	76270T	18-3552	740	806105A1	18-6093A	854
65142A1	18-3593	734	76314A3	18-5866	366	806105Q1	18-6079	854
65603A12	18-1962-1	777	76325A2	18-1972	778	806105Q1	18-6093	854
65603A4	18-1962-1	777	76351A04	18-1971	778	806105Q1	18-6093A	854
65604A12	18-1958-1	777	76351A1	18-1971	778	806105T1	18-6079	854
65604A4	18-1958-1	777	76351A2	18-1971	778	806105T1	18-6093	854
66065A1	18-2157	835	76771A2	18-1978	778	806105T1	18-6093A	854
66065A1	18-2159	835	76771A3	18-1978	778	806189A1	18-6067	854
66065A1	18-2190	835	76850A2	18-2171	837	806189A1	18-6067A	854
66065A1	18-2190E	835	77123A1	18-1705	831	806189A1	18-6114	854
66067T	18-2286	842	77234A2	18-1950-1	776	806189Q1	18-6114	854
66069A2	18-2157	835	77234A7	18-1950-1	776	806189T1	18-6114	854
66069A2	18-2159	835	77235A2	18-1951-1	776	806190A1	18-6089	854
66069A2	18-2190	835	77235A8	18-1951-1	776	806190A1	18-6092	854
66069A2	18-2190E	835	77442A1	18-2148	850	806190A1	18-6092A	854
66081A1	18-0577	832	78403A1	18-6841	703	806190Q1	18-6092	854
66081A2	18-0577	832	78403A1	18-6842	703	806190Q1	18-6092A	854
66081A4	18-0577	832	78403A1	18-5956	703	806190T1	18-6089	854

Mercury Marine (Cont.)			Mercury Marine (Cont.)			Mercury Marine (Cont.)		
O.E. #	SIERRA #	PAGE #	O.E. #	SIERRA #	PAGE #	O.E. #	SIERRA #	PAGE #
806190T1	18-6092	854	815922A5	18-2354	843	823653A5	18-6765	364
806190T1	18-6092A	854	815933A1	18-6080	854	823653A9	18-6765	364
806191T	18-2373	850	815933A1	18-6099	854	825096T01	18-5821	368
806490T	18-5897	751	815935A3	18-2422	851	825467A1	18-7901	183, 411
806612T	18-7677	710	815935A7	18-2422	851	825467T1	18-7901	183, 411
806673T	18-5442	680	815954A3	18-2423	851	826134A1	18-6068	440, 854
806673T1	18-5442	680	815954A7	18-2423	851	826763A	18-3154	393
806807A1	18-7691	711	816148A1	18-5313-1	684	828151A1	18-5849	369
806867A 8	18-1956-3	777	816329A3	18-1966-1	778	828692A1	18-2382	832
806867A12	18-1966-1	778	816431A1	18-2747	834	828708A1	18-6774	364
806867A2	18-1966-1	778	816610A1	18-2244	435, 846	830250A3	18-6777	364
806867A3	18-1966-1	778	816610A2	18-2244	435, 846	830250T3	18-6777	364
806867A8	18-1966-1	778	816770T	18-5707	368	832021A1	18-6777	364
806867A9	18-1966-1	778	817019A1	18-9099	850	832021A2	18-6777	364
807057T	18-5851	369	817019A2	18-9099	850	832021T2	18-6777	364
807074A1	18-3531	741	817019Q2	18-9099	850	832021T4	18-6777	364
807078A 6	18-1957-2	777	817119A1	18-5957	703	833232E	18-4173	791
807078A2	18-1957-2	777	817119A1	18-5965	703	834832T2	18-6844	703
807078A4	18-1957-2	777	817119A1	18-5966	703	835392Q	18-15147	411
807078T10	18-1957-2	777	817119A4	18-5957	703	84141M	18-7840	382
807166A3	18-2732	735	817119A4	18-5965	703	84188M	18-3425	398
807252Q3	18-3646	740	817119A4	18-5966	703	84188T	18-3425	398
807252Q4	18-3668	741	817275A08	18-3406	395	84262M	18-7837	382
807252Q5	18-3647	740	817275A09	18-3407	395	84265M	18-7838	382
807252T1	18-3551	740	817275A1	18-3571	397	84419M	18-7290	377
807252T2	18-3649	740	817275A2	18-3572	397	84456M	18-7770	378
807252T4	18-3668	741	817275K05	18-3147	736	84475M	18-7291	377
807252T6	18-3646	740	817275T4	18-3147	736	845668T	18-0614	790
807252T8	18-3647	740	817373A1	18-6094	854	84829M	18-3426	398
807476A6	18-1908K	779	817377T	18-5475	683	850484T	18-5362	677
807652T	18-5967	703	817378T	18-5443	680	850484T2	18-5362	677
807653T	18-5960	703	818298A1	18-6249	441	850484T3	18-5278	677
807757T	18-6457	734	818298A1	18-6249A	441	85147A5	18-2145	835
807914A1	18-1976-2	779	818298Q1	18-6249	441	852956A1	18-7685	710
807929A1	18-2354	843	818298Q1	18-6249A	441	853678T	18-7700	709
807929A2	18-2354	843	818349A1	18-2286	842	854472A2	18-6777	364
807964A1	18-5476	683	818349T1	18-2286	842	854472A3	18-6777	364
807988A03	18-1976-2	779	818763A10	18-2376	843	854472A4	18-6777	364
807988A2	18-1976-2	779	818763A4	18-2376	843	855654A1	18-6777	364
808015T	18-7553	710	818903A1	18-6777	364	855654T2	18-6777	364
808064A1	18-3531	741	819479A1	18-6777	364	855676A1	18-3642	391
808483K2	18-5291	676	819480A1	18-6777	364	857006A3	18-6844	703
808483Q2	18-5281	677	821354A2	18-4531	398	857006T	18-6454	372
808483T3	18-5354	678	821509T1	18-5852	369	85784A1	18-7285	724
808484 1	18-5405	678	821629A1	18-6080	854	85785A2	18-7231	724
809449A1	18-7216	Obsolote	821629A1	18-6080A	854	85785T	18-7229	724
809463A1	18-5811	368, 701	821629A1	18-6099	854	859168T	18-6829	374
811536T	18-36906	721	821629Q1	18-6080A	854	860235A03	18-1966-1	778
811618A1	18-6751	363	821630A1	18-6094	854	860235A04	18-1956-3	777
811635Q2	18-5280	677	821630A1	18-6094A	854	860246A10	18-1953-2	776
811635T3	18-5361	678	821630A1	18-6240	854	860246A3	18-1953-2	776
811636 1	18-5406	678	821630C2	18-6094	854	860246A7	18-1953-2	776
811637T	18-5107-1	680	821630Q1	18-6094A	854	860246A9	18-1953-2	776
811639T	18-5108	680	821630Q1	18-6240	854	860256A2	18-3530-1	741
811673 1	18-6775	364	821630T1	18-6094A	854	860256A4	18-3530-1	741
81242M	18-3427	398	821630T1	18-6240	854	860336A2	18-1953-2	776
812454A1	18-7288-1	150, 725	821631A1	18-6066	853	860337A2	18-1953-2	776
812454A3	18-7288-1	150, 725	821631B1	18-6066	853	860349A1	18-33207	709
812843A1	18-6751	363	821631C	18-6066	853	861006A1	18-1989	648, 741
812964A2	18-2412	S/S to 18-2412-1	821631Q1	18-6066	853	861155A2	18-8868	725
812964A2	18-2412-1	837	821631Q1	18-6066A	853	861155A3	18-8868	725
813442A1	18-6751	363	821631Q1	18-6243	853	861155A5	18-7326	150, 725
813442A2	18-6751	363	821663A1	18-6960	703	861155A5	18-8867	724
814309A1	18-2434	558, 699	821759A1	18-2354	843	861155A6	18-7326	150, 725
814481M	18-7769	378	821759A2	18-2354	843	861155A6	18-8867	724
814819A2	18-9218	830	821759A3	18-2354	843	861156A02	18-8861	724
815279A2	18-5741	368	821759A4	18-2354	843	861156A03	18-8862	724
815407A2	18-5396	679	822777A1	18-6014	440, 853	861156A1	18-35433	725
815425T	18-5899	751	822777A1	18-6014A	440, 853	861188A1	18-3531	741
815471A3	18-2145	835	822777A3	18-6014	440, 853	861245A1	18-7639	153, 714
815471A3	18-2145E	836	822777A4	18-6014	440, 853	861249A1	18-7550	709
815471A6	18-2145	835	822777Q1	18-6014	440, 853	861260T	18-7692	711
815471A6	18-2145E	836	822777Q1	18-6014A	440, 853	861493A07	18-1910	741
815471T1	18-2604	836	822870A1	18-6777	364	861493A3	18-1910	741
815471T1	18-2604E	836	823034T	18-5793	359	861523A9	18-2412	S/S to 18-2412-1
815919A1	18-2320	843	823426A1	18-7072	720	861523A9	18-2412-1	837
815921A2	18-2353	843	823426A1	18-7077	720	861676A1	18-35437	725
815922A1	18-2354	843	823427A1	18-7746	720	861676T09	18-35437	725

Mercury Marine (Cont.)			Mercury Marine (Cont.)			Mercury Marine (Cont.)		
O.E. #	SIERRA #	PAGE #	O.E. #	SIERRA #	PAGE #	O.E. #	SIERRA #	PAGE #
861676T09	18-7282	149, 725	88183A12	18-6813	702	8M0058164	18-7283	149, 725
861677T	18-8860	725	88183A12	18-6752	701	8M0058677	18-6157A	440
861678A1	18-7283	149, 725	88183A12	18-6753	701	8M0060495	18-5247	676
861678A1	18-7283	149, 725	88183A3	18-6747	701	8M0061335	18-5247	676
86177 1	18-5658	375	88183A5	18-6813	702	8M0061381	18-1989	648, 741
862030T	18-5983	703	88183A5	18-6746	702	8M0062084	18-5408	678
862031T	18-6293	703	88183A5	18-6769-1	702	8M0062406	18-2756	834
862031T1	18-6293	703	88183A6	18-6752	701	8M0064021	18-6454	372
862048A1	18-7288-1	150, 725	88183A8	18-6813	702	8M0065179	18-15148	411
862077A1	18-7284	149, 725	882751A04	18-5850	369	8M0068784	18-5899	751
862132T	18-1711	830	882751A1	18-5849	369	8M0069803	18-7663	709
86234A05	18-7278	149, 725	882751A2	18-5849	369	8M0072670	18-15146	411
86234A3	18-7278	149, 725	883072T	18-5743	368	8M0073435	18-35437	725
86234A4	18-7278	149, 725	883166A1	18-6778	702	8M0074922	18-43017	740
86246A1	18-7274	149, 725	883166A2	18-6778	702	8M0076464	18-43017	740
86246T	18-7274	149	88475A4	18-6768	702	8M0077471	18-5158	358
86247A2	18-7275	149, 725	88475A4	18-6799	702	8M0084523	18-6948	661, 703
86247T	18-7275	149, 725	884794A02	18-5351	683	8M0084600	18-5224	363, 696
862548A1	18-6749	701	884794A1	18-5351	683	8M0089715	18-3551	740
862548A1	18-6750	701	88553A1	18-6749	701	8M0090819	18-3633	391
863077T	18-6298	703	88678A4	18-7633	850	8M0091470	18-3649	740
863358T	18-43017	740	88678A5	18-7633	850	8M0095485	18-8212-1	833
864308T01	18-1843	778	888751A02	18-5350	683	8M0098795	18-2412	S/S to 18-2412-1
864591T02	18-1845	779	888751A03	18-5350	683	8M0098795	18-2412-1	837
86459A1	18-9099	850	888751A1	18-5350	683	8M0104229	18-3016-1	734
86459A2	18-9099	850	888755A1	18-6158M	853	8M0110717	18-2373	850
864612T01	18-1842	778	888755Q01	18-6158M	853	8M0117413	18-3640	391
864856A1	18-7684	709	888756A2	18-6150A	854	8M0708280	18-2425	851
865049T01	18-1843	778	888756A2	18-6150M	854	8M2009865	18-2130	843
865202T	18-5851	369	888756A2	18-6150Z	854	8M6001217	18-5338	678
865380A02	18-6747	701	888756Q01	18-6158A	853	8M6001218	18-5345	678
865380A03	18-6746	702	888756Q02	18-6150A	854	8M6001219	18-5303	677
865380A05	18-6747	701	888756Q02	18-6150M	854	8M6001224	18-5404-1	678
865380A13	18-6813	702	888756Q02	18-6150Z	854	8M6001249	18-5347	678
865380A13	18-6746	702	888756Q4	18-6150A	854	8M6001250	18-5314	677
865380A15	18-6747	701	888756Q4	18-6150M	854	90363A1	18-7810	382
865380A25	18-6747	701	888756Q4	18-6150Z	854	90576A4	18-5432	678
865436A02	18-2157	835	888757Q01	18-6159M	853	90746A1	18-5395	679
865436A02	18-2159	835	888758A1	18-6159A	853	907964A1	18-5476	683
865436A02	18-2190	835	888758Q01	18-6159A	853	90806A1	18-5899	751
865436A02	18-2190E	835	888759A1	18-6159M	853	91748M	18-7834	382
865436A03	18-2603	836	888760A1	18-6160M	853	91823A3	18-5313-1	684
865436A03	18-2603E	836	888760Q01	18-6160M	853	92459A4	18-6765	364
865437A02	18-2145	835	888761A1	18-6160A	853	92497A3	18-5957	703
865493A01	18-6406	831	888761Q01	18-6160A	853	92497A3	18-5965	703
865496A01	18-6406	831	888909A1	18-0557	433	92520M	18-7293	377
865496A01	18-6406	831	88893A4	18-6749	701	92975A28	18-6763	364
865503T	18-6404	830	889955A03	18-6454	372	92975A32	18-6763	364
865510T	18-6406	831	89011A8	18-1957-2	777	92975A6	18-6763	702
865511T	18-6406	831	89031A1	18-7811	382	93247A4	18-6799	702
865735A02	18-1843	778	89031A2	18-7812	382	93247A7	18-6768	702
866169A01	18-8864	724	89031A3	18-7813	382	93247A7	18-6799	702
866169T01	18-8864	724	89031A4	18-7814	382	93320A13	18-1908K	779
866170A01	18-8865	724	891736T	18-6772	702	93320A2	18-1908K	779
86617A20	18-5864	366	892864T04	18-3631	391	93320A3	18-1908K	779
86840A05	18-2756	834	892864T06	18-3635	391	93320A5	18-1908K	779
86840A3	18-2756	834	892874T01	18-8866	382	93320A6	18-1908K	779
87114A19	18-1953-2	776	892940T	18-5929	372	93477T	18-0615	790
87114A19	18-1953-2	776	893640T01	18-5732	368	94998A1	18-2381	832
87114A30	18-1953-2	776	893929A01	18-6751	363	94998A2	18-2381	832
87290A4	18-1994	741	89396A38	18-8004EP-1	140, 385	94998A3	18-2381	832
87399A1	18-2428	851	89396A38	18-8004S	146, 148	94998A4	18-2381	832
87399A2	18-2428	851	89396Q38	18-8004EP-1	140, 385	95661M	18-3427	398
87399A3	18-2429	851	89396Q38	18-8004S	146, 148	95755A2	18-1970-1	S/S to 18-1970-2
875285T1	18-6454	372	896173A01	18-2700	440	95755A2	18-1970-2	778
875286A1	18-6455	372	897755T	18-6840	372	95862A5	18-1954-1	776
875286T	18-6455	372	898253T22	18-5244	678	95864A2	18-1975-1	779
87581T	18-5315-1	684	898253T23	18-5243	678	96184A1	18-1567	433
878265A4	18-6773	364	898253T24	18-5433	358, 680	96455A1	18-5797	366
878265A6	18-6774	364	898253T27	18-5443	680	96455A15	18-5796	366
879984A1	18-5158	358	898253T28	18-5246	676	96455A6	18-5798	366
879984T00	18-5158	358	898253T29	18-5247	676	96455A8	18-5797	366
879984T01	18-5158	358	89876A3	18-7853-1	136, 387, 730	96455A9	18-5798	366
881150K1	18-9895	202	899106T01	18-8866	382	96477A3	18-6752	701
881247A1	18-6455	372	8M0027721	18-2560	425	96705A1	18-1955-1	777
881248T	18-6454	372	8M0045604	18-2700	440	96863A15	18-7633	850
88183A11	18-6752	701	8M0054588	18-5465	625	97257A1	18-5897	751
88183A12	18-6747	701	8M0054726	18-7660	709	97258A1	18-5898	751

Mercury Marine (Cont.)			Mercury Marine (Cont.)			Mercury Marine (Cont.)		
O.E. #	SIERRA #	PAGE #	O.E. #	SIERRA #	PAGE #	O.E. #	SIERRA #	PAGE #
97399A2	18-7288-1	150, 725	F74305	18-7176	449, 858	FI1101322	18-3938	791
97401A2	18-7283	149, 725	F749301	18-5775	358	FI1101334	18-4173	791
97401A8	18-7283	149, 725	F7778A9	18-5775	358	FI1101336	18-4164	791
97432A2	18-2414	837	F8077	18-2945	425, 812	FI1101656	18-0322	812
97793M	18-3426	398	F8186	18-2945	425, 812	FI1110294	18-25001	810
97793T	18-3426	398	F84903	18-1162	433, 844	FI1110958	18-25001	810
98230A1	18-73131	831	FA84901	18-1162	433, 844	FI5000074	18-0889	807
98502A2	18-1974-1	779	FFF001138	18-7964	S/S to 18-7964-1	FI5000077	18-0891	811
98503A2	18-1970-1	S/S to 18-1970-2	FFF001138	18-7964-1	733	FI5000078	18-0891	811
98503A2	18-1970-2	778	FI000034	18-1190	432	FI5000096	18-2917	808
98504A3	18-1970-1	S/S to 18-1970-2	FI1001079	18-3593	734	FI5000119	18-2815	811
98504A3	18-1970-2	778	FI1100014	18-4492	648, 791	FI5000161	18-2845	810
98555A1	18-5957	703	FI1100229	18-0348	805	FI5000162	18-0874	808
98555A1	18-5965	703	FI110026	18-1211	800	FI5000178	18-0411	806
98555A1	18-5966	703	FI110027	18-1211	800	FI5000183	18-0411	806
98562A6	18-1937	779	FI1100305	18-1308	795	FI5000199	18-2815	811
98703A11	18-2424	851	FI1100349	18-1402	791	FI5000200	18-0327	811
98703A12	18-2424	851	FI1100381	18-1309	795	FI5000201	18-0887	810
98703A17	18-2424	851	FI1100382	18-1341	795	FI5000204	18-2946	807
98703A26	18-2424	851	FI1100386	18-3937	791	FI5000219	18-0327	811
98703A3	18-2426	851	FI1100387	18-3939	791	FI5000229	18-0348	805
98704A11	18-2425	851	FI1100399	18-1402	791	FI5000232	18-0868	806
98704A12	18-2425	851	FI110041	18-1211	800	FI5000245	18-0348	805
98704A17	18-2425	851	FI1100495	18-4492	648, 791	FI5000263	18-0868	806
98704A26	18-2425	851	FI1100570	18-1308	795	FI5005756	18-0876	807
98704A3	18-2427	851	FI1100573	18-1309	795	FI5110032	18-0153	805
99155A1	18-3555	740	FI1100692	18-3937	791	FI5110037	18-0153	805
99155T1	18-3568	740	FI1100694	18-3938	791	FI5810151	18-4263	780
99155T2	18-3555	740	FI1100742	18-3599-1	S/S to 18-3599-2	FI5880010	18-4264	780
99186T	18-6273-1	364	FI1100742	18-3599-2	734	FI6900023	18-5347	678
99297A1	18-2193	813	FI1100779	18-4161	791	FI6900031	18-5303	677
99297A2	18-2193	813	FI1100779	18-4191	791	FI6900031	18-5345	678
993247A4	18-6768	702	FI1100780	18-4161	791	FI6900032	18-5347	678
99356A2	18-2587	558	FI1100780	18-4191	791	FI6900040	18-5338	678
99370A2	18-2733	735	FI1100781	18-4160	791	FI6900044	18-5407	678
99660A1	18-6751	363	FI1100783	18-3939	791	FI6900052	18-5385	679
99746A17	18-1952-1	776	FI1100785	18-3575	S/S to 18-3593	FI6900083	18-5347	678
99746A8	18-1952-1	776	FI1100785	18-3593	734	FI6900148	18-5376	679
99798A16	18-1956-3	777	FI1100853	18-1316	795	FI6900152	18-5898	751
99798A18	18-1966-1	778	FI1100862	18-1402	791	FI6900184	18-5369	679
99798A18	18-1956-3	777	FI1100912	18-1315	Obsolete	FI6900185	18-5352	678
99798A3	18-1956-3	777	FI1100954	18-1402	791	FI6900186	18-5403	678
99798A9	18-1956-3	777	FI1100968	18-4022	800	FI6900189	18-5347	678
F10077105	18-2917	808	FI1100980	18-1334	795	FI6900190	18-5403	678
F1348	18-3713	832	FI1100986	18-1233	800	FI6900198	18-5898	751
F17510	18-7413	449, 859	FI1100997	18-3577-1	S/S to 18-3577-2	FI6901224	18-5404-1	678
F1881	18-3713	832	FI1100997	18-3577-2	734	FI8390006	18-7860	733
F2769931	18-1402	791	FI1101000	18-0903	811	FI9608751	18-7964	S/S to 18-7964-1
F2774666	18-3575	S/S to 18-3593	FI1101007	18-1339	795	FI9608751	18-7964-1	733
F2774666	18-3593	734	FI1101053	18-3577-1	S/S to 18-3577-2	FT8935	37509	201
F328506	18-3937	791	FI1101053	18-3577-2	734	MC 1 95862	18-1954-1	776
F328516	18-3938	791	FI1101057	18-3944	791	YLM579AV	18-5497-2	164, 684
F347013	18-1315	Obsolete	FI1101079	18-3575	S/S to 18-3593	MOTOROLA		
F3746241	18-4492	648, 791	FI1101101	18-4189	791	510-802	18-5976	953
F3750884	18-1339	795	FI1101117	18-4022	800	510-821	18-5976	953
F3829064	18-1316	795	FI1101134	18-3939	791	510-835	18-5976	953
F3860315	18-25001	810	FI1101184	18-4173	791	510-836	18-5976	953
F3866612	18-4022	800	FI1101185	18-4164	791	510-845	18-5975	661
F3892364	18-3937	791	FI1101200	18-4024	800	510-856	18-5976	953
F3910555	18-1308	795	FI1101208	18-3599-1	S/S to 18-3599-2	510-860	18-5975	661
F3916351	18-1308	795	FI1101208	18-3599-2	734	510-861	18-5976	953
F3932344	18-0874	808	FI1101222	18-1402	791	510-862	18-5976	953
F40109	18-2244	435, 846	FI1101236	18-2845	810	510-864	18-5975	661
F50342	18-7413	449, 859	FI1101276	18-2917	808	9AR3743G	18-5976	953
F50556	18-2945	425, 812	FI1101281	18-1237	805	9AR3855G	18-5975	661
F508814	18-1129	844	FI1101287	18-0664	810	9AR3959G	18-5975	661
F5232670	18-1402	791	FI1101291	18-2917	808	9AR6000G	18-5975	661
F532555	18-7467	449, 859	FI1101292	18-3599-1	S/S to 18-3599-2	NISSAN-TOHATSU		
F53795	18-7153	449, 858	FI1101292	18-3599-2	734	332600052M	18-72656	459
F6269358	18-3577-1	S/S to 18-3577-2	FI1101293	18-1315	Obsolete	332600060M	18-60103	459
F6269358	18-3577-2	734	FI1101295	18-0612	790	332600060M	18-72656	459
F694555	18-7176	449, 858	FI1101296	18-0868	806	334650210M	18-8921	458
F694961	18-2346	842	FI1101297	18-0976	810	345650210M	18-8923	458
F700633	18-4263	780	FI1101300	18-0519	800	345871224M	18-7290	457
F7040	18-3700	439	FI1101317	18-4178	791	346-01032-0	18-60920	459
F720301	18-5881	359	FI1101318	18-4173	791	346760100M	18-6431	456
F724073	18-1300	795	FI1101320	18-4164	791			
F724102	18-1401	791	FI1101321	18-3937	791			

Nissan-Tohatsu			OMC (Cont.)			OMC (Cont.)		
O.E. #	SIERRA #	PAGE #	O.E. #	SIERRA #	PAGE #	O.E. #	SIERRA #	PAGE #
346871220M	18-7291	457	122838	18-8052	146, 275	302588	18-7115	350, 933
346873217M	18-74611	458	123009	18-6017	343	302675	18-2889	310
353650210M	18-45404	458	123009	18-6017A	343	302804	18-3740	329
353760104M	18-6418	456	123009	18-6100	343	302994	18-2890	309
369022300M	18-7712	457	123018	18-1599	914	303059	18-7134	350, 933
369060210M	18-5143	455	124249	18-8201	145, 276, 887	303067	18-7116	350, 933
369871221M	18-7765	457	125530	18-2881	316	303069	18-3103	277
398873213M	18-74610	458	127084	18-4222	329	303191	18-7413	350, 933
3A0060401M	18-5133	455	160084	18-1501	921	303339	18-2891	315
3A0060481M	18-5133	455	171960	18-5898	891	303345	18-2022	347, 931
3AA050040M	18-51000	459	172521	18-5011	252	303347	18-7180	350, 933
3B2650160M	18-43212	458	172522	18-5006	252	303355	18-2892	310
3B2650211M	18-8920	458	172523	18-5002	252	303360	18-7117	350, 933
3B2702501M	18-8088	457	172525	18-5001	252, 862	303438	18-2885	306
3B2-70260-0	18-8089	457	172527	18-5250	862	303598	18-7150	350, 933
3B2702810M	18-8079	457	172531	18-5256	862	303615	18-0850	309
3B2873214M	18-74805	Obsolete	172543	18-6762	260	303750	18-2893	309
3B2873222M	18-48317	458	172543	18-6822	955	303804	18-2060	347
3B7650212M	18-8924	458	172588	18-6816	260	304023	18-2880	314
3B7871218M	18-4436	458	172806	18-5003	252	304026	18-3332	315
3C7650211M	18-8924	458	172850	18-6767-1	260	304174	18-7165	350, 933
3C8010055M	18-3850	459	172869	18-5814	261, 875	304314	18-2894	312
3C8650212M	18-8922	458	173029	18-6017	343	304720	18-2951	306
3C8750140M	18-56002	456	173029	18-6017A	343	304762	18-2871	311
3C8760101M	18-6432	456	173029	18-6100	343	304764	18-0882	314
3C8-87121-4	18-4434	458	173231	18-7875	183, 902	305123	18-7133	350, 933
3F0060491M	18-5182	455	173233	18-7876-1	183	305176	18-2870	311
3F0-06153-0	18-5182	455	173311	18-8055	145, 275, 887	305185	18-7826	274
3F0061530M	18-5182	455	173312	18-8074	145, 275, 887	305242	18-7118	350, 933
3F3010051M	18-4299	459	173326	18-7930	138, 886	305270	18-7155	350, 933
3F3871210M	18-4435	458	173564	18-6767-1	260	305303	18-3102	277
3G2-06040-2	18-5166	455	173596	18-6767-1	260	305306	18-2027	347, 931
3G2060602M	18-5134	455	173619	18-5251	862	305312	18-2869	315
3G3060211M	18-5165	455	173690	18-5258	862	305739	18-7101	350, 933
3GR702500M	18-80410-1	386, 457	173829	18-5260	862	305762	18-2532	315
3M3060482M	18-5166	455	173834	18-7879-1	183, 902	305987	18-2018	347
3R0074220M	18-76695	459	173944	18-6816	260	306048	18-2959	306
3R0-07615-0	18-7911-1	184, 458	174177	18-8072	275, 887	306205	18-2901	313
3R3010300M	18-43175	458	174275	18-9013	198	306643	18-3135	309
3T9010050M	18-3886	459	174275	18-9024	198	307069	18-2957	306
3V1010050M	18-60916	459	174275	18-9065	198	307082	18-7152	350, 933
3V1010240M	18-60917	459	174275	18-9080	198	307103	18-7428	314, 345
3V1013030M	18-60918	459	174448	18-9098	925	307133	18-2876	313
3V1020110M	18-60915	Obsolete	174508	18-8056	275	307239	18-7170	350, 933
3V1023050M	18-60919	459	174509	18-8014EP-2	142, 275	307257	18-2872	313
3V1060400M	18-23207	455	174509	18-8014S-1	147	307450	18-7102	350, 933
3V1871210M	18-64221	458	174511	18-8004EP-1	140, 275	307551	18-2387	911
65750-95500	18-8079	457	174511	18-8004S	146, 148	307551	18-23871-9	328, 911
B29A-90500A	18-6430	456	174512	18-8005EP-1	140, 275	307551	18-4255	328
OBERDORFER			174512	18-8005S	146	307552	18-2945	328, 911
6603	18-3021	558	174512	18-9013	198	307573	18-6501	316
7054	18-3078	557	175068	18-9024	198	307583	18-7106	268
8922	18-3061	557	175068	18-9065	198	307853	18-7120	350, 933
132-0317	18-3060	964, 978	175068	18-9080	198	308186	18-4075	295
B6620	18-3075	557	175158	18-0871	268	308458	18-7461	350, 933
C7441	18-3077	557	175266	18-3715	329, 925	308500	18-8351	347
OETIKER			175267	18-3716	329, 925	308621	18-7121	350, 933
787133	18-9125	202, 276	175268	18-3717	329	308624	18-7103	350, 933
14100082	18-9141	202, 276, 495	176288	MP28890	30, 259, 871	308626	18-7198	350, 933
16700004	18-9126-9	202, 276	176445	18-8092	275	308627	18-7104	350, 933
16700006	18-9127-9	202, 276	202893	18-7168	350, 933	308799	18-2863	910
16700007	18-9128-9	202, 276	203034	18-2952	306	308825	18-0653	924
16700010	18-9129-9	202, 276	203130	18-3841-2	307	308876	18-7123	350, 933
16700011	18-9130-9	202, 276	203171	18-2886	312	308928	18-3108	890
16700012	18-9131-9	202, 276	203698	18-6513	316	309044	18-2534	315
16700013	18-9132-9	202, 276	277181	18-3001	276	309243	18-1236	328, 911
16700016	18-9133-9	202, 276, 495	300599	18-2035	347	309612	18-2950	306
16700017	18-9134-9	202, 276	300611	18-3326	278	309731	18-7156	350, 933
16700020	18-9140-9	202, 276	301824	18-7111	350, 933	309955	18-3741	329
16700024	18-9135-9	202, 276	301877	18-7100	350, 933	309956	18-2898	312
16700031	18-9136-9	202, 276	301967	18-7440-1	350, 933	309989	18-2000	347, 931
16700037	18-9137-9	202, 276	302325	18-3369	309	310058	18-0182	313
16700040	18-9138-9	202, 276	302337	18-7162	350, 933	310137	18-2868	312
16700053	18-9139-9	202, 276	302493	18-7112	350, 933	310327	18-7173	350, 933
OMC			302497	18-3329	315	310414	18-7167	350, 933
114812	18-45312	277	302537	18-7164	350, 933	310584	18-7135	350, 933
121731	18-3722	927	302540	18-7114	350, 933	310585	18-7158	350, 933
			302557	18-2887	316	310599	18-2012	347, 931

OMC (Cont.)			OMC (Cont.)			OMC (Cont.)		
O.E. #	SIERRA #	PAGE #	O.E. #	SIERRA #	PAGE #	O.E. #	SIERRA #	PAGE #
310649	18-2020	347, 931	316506	18-2243	337, 921	320745	18-2964	307
310913	18-2947	908	316563	18-2377	328	320785	18-3743	329
310953	18-15460	893	316705	18-4913	212, 316	320862	18-2002	347, 931
310967	18-7158	350, 933	316706	18-4914	212, 316	320880	18-1219	315
311046	18-15440	893	317178	18-7109	350, 933	320936	18-0540	315
311068	18-2896-1	900, 908	317201	1525607	201	320943	18-2704	315
311069	18-0164	907	317232	18-2234	341	320961	18-8353	315
311121	18-2861-1	908	317245	18-1243	288	320981	18-3343	278
311130	18-2860	908	317305	18-0951	310	321008	18-2706	315
311131	18-2859	908	317624	18-1279	914	321027	18-3563	288
311145	18-0679	314	317831	18-4290	292	321028	18-2544	313
311210	18-3880	907	317838	18-2219	336, 922	321117	18-7141	350, 933
311338	18-7105	350, 933	317841	18-3182	278	321120	18-2536	314
311508	18-0917	315	317843	18-2026	347	321163	18-7510	350, 933
311598	18-4248	328, 911	317914	18-2866	311	321182	18-2545	311
311598	18-42481-9	328, 911	317951	18-0953	314	321183	18-0979	310
311606	18-15400	893	317955	18-0117	311	321184	18-2546	314
311684	18-7854	886	318156	18-0955	311	321220	18-3565	289
312456	18-7860	887	318223	18-2059	347, 931	321221	18-3567	289
312634	18-2879	310	318303	18-2209	336	321222	18-3562	288
312679	18-2900	310	318304	18-2208	336	321435	18-2549	311
312780	18-0874	907	318334	18-2872	313	321459	18-2027	347, 931
312781	18-71337	893	318335	18-2873	313	321467	18-2060	347, 931
312797	18-0398	908	318358	18-2956	306	321479	18-0981	311
312797	18-2917	907	318372	18-7137	350, 933	321481	18-2029	347
312800	18-0876	907	318373	18-0957	312	321497	18-0983	310
312932	18-6511	316	318395	18-3564	288	321504	18-8351	347
313065	18-2901	313	318544	18-2378	911	321573	18-2862	311
313080	18-2767	919	318544	18-23781-9	328, 911	321648	18-5655	266
313175	18-7107	350, 933	318544	18-4249	329	321692	18-2391	289, 315
313176	18-3141	890	318609	18-2543	313	321722	18-0985	310
313244	18-0923	911	318717	18-7138	350, 933	321724	18-70936	301
313258	18-2021	347	318841	18-4222	925	321727	18-2864	312
313282	18-2023	347, 931	318914	18-2963	306	321786	18-2030	347, 931
313283	18-0173	347	318917	18-0397	313	321787	18-2031	347, 931
313284	18-2005	347, 931	318924	18-0959	310	321788	18-2032	347
313340	18-7126	350, 933	318925	18-2853	311	321794	18-0989	310
313353	18-2058	347, 931	318932	18-0961	309	321830	18-8304	331, 347
313368	18-2851	910	318940	18-1505	316	321831	18-0542	347, 931
313413	18-2960	306	318944	18-6503	316	321886	18-3290	275
313416	18-0929	313, 907	318971	18-3706	329	321895	18-0543	347, 931
313446	18-7127	350, 933	318972	18-2025	347, 931	321907	18-0991	311
313448	18-1714	924	318973	18-2028	347	321921	18-7411	350
313507	18-0543	347, 931	318995	18-3178	278	321928	18-2033	347, 931
313754	18-7128	350, 933	319085	18-7139	350, 933	321932	18-0675	313
313763	18-2865	312	319097	18-2913	312	321940	18-3126	278
313782	18-2884	306	319126	18-3369	285	322119	18-7133	350, 933
313893	18-7108	350, 933	319174	18-2867	311	322119	18-7142	350, 933
313992	18-2016	347	319256	18-2029	347	322236	18-4911	212, 316
314008	18-2703	315	319275	18-3127	278	322332	18-2962	306
314082	18-2855	314	319332	18-0967	313	322411	18-0892	313, 909
314115	18-0933	310	319348	18-2904	313	322501	18-7143	350, 933
314167	18-2024	347, 931	319586	18-0969	314	322652	18-8020	276, 887
314322	18-0935	310	319633	18-2954	306	322653	18-8200	145, 276, 887
314421	18-2877	312	319661	18-0971	313	322654	18-8202	145, 276, 887
314491	18-7129	350, 933	319662	18-7457	350, 933	322656	18-8051	146, 275
314502	18-3742	329	319664	18-2093	334	322858	18-2547	314
314503	18-3705	329, 925	319665	18-2856	313	322941	18-3763	325, 327, 914
314728	18-7130	350, 933	319710	18-2878	312	323214	18-2550	312
314730	18-3719	920	319771	18-2857	310	323217	18-0945	311
314731	18-0195	331, 921	319890	18-4229	329	323222	18-0995	312
314745	18-2231	341, 914	319891	18-3707	329	323311	18-0446	314
314809	18-2858	907	319895	18-2287	336	323312	18-0445	314
314832	18-2389	315	320041	18-2379	328	323361	18-2230	341, 914
314876	18-2874	314	320140	18-7178	350, 933	323362	18-2229	341, 914
315052	18-0973	311	320166	18-2224	341	323459	18-0999-9	311
315055	18-0937	907	320167	18-2225	341	323469	18-0102	311
315189	18-0939	910	320168	18-2226	341	323582	18-8372	315
315232	18-7296	268	320169	18-2227	341	323626	18-3136	309
315288	18-0542	347, 931	320170	18-2228	341	323653	18-6522	316
315538	18-0941	313	320303	18-7140	350, 933	323664	18-2220	336, 922
315539	18-2958	306	320305	18-4230	329	323889	18-2232	341
315748	18-2705	315	320311	18-2398	337	323890	18-2233	341
315810	18-4228	329, 925	320499	18-1377	295	323943	18-4232	329
315837	18-3337	315	320533	18-2963	306	324073	22423	Obsolete
315868	18-1218	311	320570	18-4231	329, 925	324097	18-3179	278
315869	18-1224	311	320630	18-2220	336, 922	324323	18-0106	311
316499	18-0949	315	320658	18-3802	307	324324	18-3803	307

OMC (Cont.)			OMC (Cont.)			OMC (Cont.)		
O.E. #	SIERRA #	PAGE #	O.E. #	SIERRA #	PAGE #	O.E. #	SIERRA #	PAGE #
324334	18-4276	285, 309	329922	18-2061	347, 931	335523	18-7110	307
324369	18-2399	337, 925	329923	18-2062	347, 931	335633	18-0963	310
324430	18-4277	285, 309	330081	18-4076	295	335677	18-9219	334
324449	18-0108	314	330137	18-2001	347, 931	335679	18-2279	334
324639	18-2034	347, 931	330273	18-1221	315	335722	18-2277	334
324670	18-0110	314	330327	18-2063	347, 931	335818	18-1283	312
324701	18-2557	314	330412	18-0155	314	335819	18-1284	312
324717	18-0112	312	330525	18-6512	316	335981	18-1507	289
324766	18-0198	331, 921	330560	18-3363	279	336226	18-0694	312
324825	18-8204	145, 276, 887	330619	18-3295	278	336227	18-0693	312
324937	18-2537	315	330621	18-2852	312	336232	18-1286	300
324981	18-7481	314	330698	18-0157	310	336388	18-0696	312
325092	18-0118	309	330818	18-2963	306	336389	18-0695	312
325211	18-0120	311	330854	18-1391	296	336430	18-0945	311
325260	18-0122	310	330909	18-0159	310	336530	18-2709	314
325273	18-3800	307	331103	18-8307	347	336562	18-2216	336
325398	18-3352	281	331107	18-3299	278	336982	18-42531-9	328, 911
325537	18-0124	314	331188	18-7143	350, 933	336982	18-4253-9	328, 911
325647	18-3801	307	331203	18-2890	309	337020	18-1290	337
325721	18-2907	303, 313	331211	18-3838	307	337068	18-0412	313
326260	18-2862	311	331353	18-7963	315	337772	18-2216	336
326264	18-0126	311	331363	18-2879	310	337774	18-2216	336
326468	18-0128	312	331380	18-7150	350, 933	337778	18-1500	337, 924
326649	18-7174	350, 933	331499	18-2908	309	338484	18-2557	314
326716	18-0174	347	331532	18-0161	310	338518	18-7108	350, 933
326741	18-7418	350, 933	331598	18-0978	310	338534	18-6522	316
326751	18-2075	347	331880	18-3765	337	338813	18-2582	309
326765	18-4292	292	331916	18-2913	312	338876	18-2879	310
326849	18-7144	350, 933	331917	18-2938	312	338878	18-2908	309
326877	18-6509	316	331979	18-3133	309	338879	18-2900	310
326926	18-1212	311	331980	18-1704	316, 911	338880	18-2903	309
326953	18-2888	306	331999	18-4826	328	338882	18-2579	309
327031	18-2035	347	332000	18-2769	315	338884	18-2906	309
327035	18-2392	315	332010	18-2888	306	338886	18-2890	309
327361	22423	Obsolete	332108	18-2548	314	339601	18-0692	312
327606	18-6018	343	332205	18-2064	347, 931	339620	18-2074	347
327655	18-1289	337	332253	18-8352	309	340115	18-3866	307
327656	18-0200	331	332261	18-2065	347, 931	340490	18-2219	336, 922
327674	18-3899	313	332266	18-0130	310	340619	18-3455	278
327707	18-0134	309	332319	18-0987	311	340919	18-0492	307
327795	18-3802	307	332369	18-0977	313	340975	18-70936	301
327861	18-4280	292	332403	18-2881	316	340976	18-70937	301
328283	18-0136	312	332489	18-2309	337	341013	18-1598	914
328313	18-1288	336	332491	18-2308	336	341280	18-8300	347
328360	18-9885	205	332584	18-7475	350, 933	341281	18-8301	347
328361	18-9886	205	332585	18-0559	347, 931	341440	18-9892	205
328363	18-9887	205	332598	18-7120	933	341501	18-0628	309
328364	18-9888	205	332694	18-2900	310	342786	18-8325	347
328365	18-9889	205	332696	18-2903	309	342787	18-8326	347
328366	18-9890	205	332816	18-3895	307	343863	18-1207	311
328367	18-9891	205	332817	18-3896	307	344470	18-3295	278
328506	18-3937	903	332819	18-3898	307	346004	18-1723	334
328516	18-3938	903	333008	18-0975	310	346007	18-0491	307
328536	18-3940	903	333077	18-2219	336, 922	346150	18-9140-9	202, 276
328590	18-0138	312	333096	18-2093	334	346151	18-9135-9	202, 276
328603	18-8350	347	333418	18-2906	309	346152	18-9136-9	202, 276
328604	18-0140	310	333572	18-7145	350, 933	346153	18-9137-9	202, 276
328622	18-0142	310	333592	18-4223	329, 925	346785	18-9132-9	202, 276
328623	18-3837	307	333670	18-3839	307	346786	18-9133-9	202, 276
328626	18-0144	310	333725	18-0197	331	346930	18-9126-9	202, 276
328751	18-3358	278	333758	18-2708	315	346931	18-9131-9	202, 276
328753	18-2539	314	333771	18-0201	331	347107	18-9129-9	202, 276
328755	18-3359	278	333879	18-0965	312	347108	18-9130-9	202, 276
329076	18-0441	313	333957	18-1343	337, 924	347205	18-0690	312
329103	18-2961	306	334163	18-3766	337, 924	348838	18-9127-9	202, 276
329380	18-7416	350, 933	334353	18-0437	309	348839	18-9134-9	202, 276
329381	18-7417	350, 933	334516	18-2216	336	349516	18-9128-9	202, 276
329390	18-3360	313	334665	18-4197	295	349729	18-9139-9	202, 276
329419	18-3803	307	334726	18-3839	307	349759	18-9138-9	202, 276
329653	18-8203	145, 276, 887	334742	18-1734	289	349957	18-9876	205, 914
329654	18-8034	145, 276, 887	334897	18-3138	278	352165	18-0313	314
329718	18-0148	310	334913	18-7150	350, 933	352670	18-0465	905
329826	18-0851	314	334950	18-8367	347	353076	18-2075	347
329828	18-1205	312	335334	18-7796	271	357159	18-0153	905
329830	18-1202	313	335359	18-3802	307	357159	18-0411	905
329833	18-1207	311	335360	18-2964	307	370409	18-3944	903
329836	18-3836	307	335361	18-3801	307	375638	18-3002	276
329920	18-2905	303, 313	335403	18-1285	312	377139	18-1154	920

OMC (Cont.)			OMC (Cont.)			OMC (Cont.)		
O.E. #	SIERRA #	PAGE #	O.E. #	SIERRA #	PAGE #	O.E. #	SIERRA #	PAGE #
377178	18-3003	276	384777	18-5648	265	390509	18-3907	292
377230	18-3083	277	384781	18-5671	266	390510	18-3908	292
378065	18-3543	289	384848	38653	201	390641	18-1396	296
378231	18-5437	865	384884	37509	201	390770	18-3380	281
378444	18-5807	261, 875	384956	18-3376	280	390905	22355	201
378891	18-3006	276	385043	18-1371	332, 920	390928	79040	201
378895	18-7093	268	385068	18-1367	332	391170	18-3913	292
379312	18-7038	268	385072	18-3044	276	391264	18-6759	260
379313	18-7094	268	385356	18-7024	267	391300	18-4303-1	302
379475	18-3086	888	385391	18-5753	255	391305	18-7223	268
379504	18-1350	332, 920	385416	18-4300	301	391416	18-3915	292
379628	18-2192	878	385503	18-1395	296	391472	18-2187	335
379763	18-3201	279	385529	18-5634	265	391511	18-5619	265
379766	18-3203	279	385662	18-3906	292	391635	18-3378	281
379777	18-7801	270	385781	18-7352	270	391638	18-7350	270
379957	18-4218	898	385952	18-5697	266	391653	18-4101	292
380186	18-7071	880	386014	18-1296	Obsolete	391698	18-3327	280
380537	18-5345	863	386084	18-3050	276	391698	18-3400	283
380538	18-5311	863	386124	18-3384	282	391735	18-5648	265
380541	18-5385	864	386280	18-3933	292	391937	18-7223	268
380542	18-5419	864	386430	18-6434	264	391988	18-4304-1	302
380543	18-5310	863	386533	18-3388	282	392061	18-7042	267
380640	18-3575	S/S to 18-3593	386545	MP39100	29, 30, 259	392061	18-7222	267
380640	18-3593	887	386545	MP39830	29, 259	392123	18-6027	343, 927
380986	18-7258	150	386573	18-2857	310	392133	18-5629	265
381389	18-7200	882	386591	18-5629	265	392455	18-4123	292
381494	18-7609-1	156, 879	386657	18-5648	265	392462	18-6026	343
381538	18-3059	277	386659	18-2355	335	392475	18-1287	336
381668	18-7608-1	156, 879	386697	18-3327	280	392550	18-7046	267
381690	18-7860	887	386764	18-1354	332	392567	18-4307	303
382045	18-7043	267	386765	18-1355	332	392615	18-4307	303
382046	18-7043	267	387041	18-1353	295	392621	18-4107	292
382047	18-7043	267	387094	18-5640	264	393023	18-6024	343, 926
382049	18-7043	267	387139	18-4040	296	393023	18-6024A	343, 926
382050	18-7010	267	387142	18-4040	296	393061	18-0466	905
382051	18-7010	267	387247	18-1158	332, 920	393088	18-7823	271
382052	18-7024	267	387262	18-7038	268	393103	18-7820	270
382053	18-7024	267	387277	18-6761	260	393159	18-0153	605
382054	18-7010	267	387284	18-4124	292	393271	18-4120	292
382057	18-7026	267	387285	18-4114	292	393279	18-9894	205
382125	18-5344	863	387326	18-3325	280	393301	MP39760	28, 259
382133	18-5375	864	387361	18-3090	277	393433	18-4305	302
382135	18-5314	863	387610	18-3327	280	393509	18-3381	281
382136	18-5338	863	387656	18-1365	332, 920	393561	18-0927	311
382138	18-6754	878	387661	18-4062	292	393566	18-4122	292
382218	18-3599-1	S/S to 18-3599-2	387683	18-5674	266	393570	18-5628	265
382218	18-3599-2	887	387684	18-5630	265	393612	18-4102	292
382221	18-45221	277	387684	18-5630	265	393630	18-3382	281
382296	18-3402	283	387787	18-1361	295	393632	18-3367	279
382343	18-1356	332	387817	18-1117	920	393659	18-3543	289
382354	18-7352	270	387818	18-2252	335, 922	393896	18-1393	296
382363	18-7210	268	387879	18-2250	335	393924	18-4120	292
382385	18-3557	289	388268	18-7352	270	393988	18-6759	260
382407	18-1351	332, 920	388344	18-1378	295	394176	18-6759	260
382408	18-1366	332, 920	388517	37478	201	394394	18-3401	283
382468	18-3377	280	388602	18-4301	301	394408	18-1222	289
382547	18-3082	277	388644	18-3393	283	394409	18-3500	289
382715	18-6822	955	388644	18-3403	284	394411	18-1506	289
382733	18-7609-1	156, 879	388891	18-3238	280	394461	18-4063	292
382821	18-7605-1	156, 879	389039	18-1358	920	394462	18-1752	295
383052	18-7043	267	389042	18-1370	332, 920	394488	18-4148-1	295
383067	18-7043	267	389112	18-3327	280	394534	18-3059	277
383087	18-7201	882	389143	18-3388	282	394543	18-7352	270
383307	18-3554	891	389206	18-4307	303	394546	18-4306	303
383440	18-5711	877	389275	18-5630	265	394711	18-3327	280
383444	18-5437	865	389275	18-5630	265	394711	18-3400	283
383587	18-5384	864	389289	18-3059	277	394885	18-4309	303
383615	18-7070	880	389556	18-4303-1	302	394930	18-3904	292
383766	18-7605-1	156, 879	389576	18-3091	277	395060	18-3390	282
383918	18-7095	880	389589	18-3055	277	395072	18-3391	283
384087	18-3336	279	389642	18-3043	276	395073	18-3393	283
384163	18-5630	265	389954	18-5634	265	395091	18-7350	270
384163	18-5630	265	390055	18-7046	267	395204	18-5825	263
384194	18-7605-1	156, 879	390076	18-4318	304	395207	18-5640	264
384195	18-1357	332	390078	18-4302	302	395209	18-2187	335, 922
384719	18-3560	289	390082	18-3972	293	395270	18-3383	281
384735	18-5418	864	390286	18-3366	277	395270	18-3401	283
384743	18-7072	880	390381	18-3379	281	395271	18-3401	283

OMC (Cont.)			OMC (Cont.)			OMC (Cont.)		
O.E. #	SIERRA #	PAGE #	O.E. #	SIERRA #	PAGE #	O.E. #	SIERRA #	PAGE #
395289	18-3051	276	432073	18-4066	292	436195	18-3561	289
395419	18-5808	261, 875	432077	18-4067	292	436232	18-2326	334
395460	18-6501	316	432078	18-4068	292	436234	18-2327	334
395627	18-1374	295	432230	MP28880	30, 259, 871	436235	18-2330	334
395713	18-7352	270	432230	MP28900	30, 260	436242	18-4055	Obsolete
395861	18-1753	295	432230	MP28902-1	30, 260	436254	18-3901	292
395864	18-3059	277	432264	18-1369	332	436353	18-4088	294
395867	18-7821	270	432451	18-7352	270	436354	18-4090	294
395911	18-6527	341	432570	18-4322	304	436367	18-5886	257
396041	18-1360	295	432803	18-4069	293	436740	18-2251	335, 922
396161	18-6528	341	432925	18-5612	265	436745	18-6024	343, 926
396235	18-5619	265	432941	18-3104-1	277	436745	18-6024A	343, 926
396349	18-2660	344	432955	18-3129	279	436746	18-2218	336, 922
396350	18-2656	343	432955	18-3389	282	436834	18-1725	335
396351	18-2658	344	432956	18-3387	282	436859	18-4079	292
396352	18-2657	343	432962	18-7822	270	436860	18-4190	292, 294
396355	18-2659	344	432969	18-4065	292	436888	18-2252	335, 922
396377	18-3910	292	432970	18-4066	292	436891	18-4323	305
396378	18-3911	292	433003	18-4067	292	436954	18-3129	279
396379	18-3912	292	433004	18-4068	292	436957	18-3389	282
396503	18-3906	292	433017	18-2251	335, 922	437059	18-3104-1	277
396504	18-3905	292	433067	18-1721	334	437090	18-3545	289
396520	18-7038	268	433190	18-79781	274	437155	18-4406	305
396521	18-7093	268	433226	18-6285	260	437228	18-0993	268
396522	18-7094	268	433379	18-3643	289	437327	18-7248	268
396583	18-4104	292	433386	18-7353	270	437409	18-4063	292
396585	18-4100	292	433387	18-7352	270	437725	18-4428	305
396587	18-4103	292	433458	18-6025	343, 927	437779	18-4402	305
396588	18-4100	292	433503	18-1299	332	437801	18-6280	260
396644	18-4529	285	433519	18-7800	270	437907	18-3491	285
396701	18-7042	267	433548	18-3394	283	438039	18-1702	923
396701	18-7222	267	433549	18-3394	283	438040	18-1703	923
396725	18-3053-1	277	433550	18-2694	345	438399	18-1722	334
396750	18-4310	303	433570	18-2289	Obsolete	438529	18-6780	260
396809	18-3368	277	433580	18-6115	343	438531	18-6780	260
396852	18-3015	276	433935	18-3015	276	438555	18-7353	270
396932	18-3385	282	433941	18-4307	303	438556	18-7352	270
396933	18-3399	283	434063	18-2218	336, 922	438562	18-7351	270
396987	18-3557	289	434107	18-3913	292	438591	18-3129	279
397003	18-6525	341	434109	18-3915	292	438591	18-3389	282
397004	18-6526	341	434137	18-3500	289	438592	18-3394	283
397023	18-5619	265	434381	18-4309	303	438592	18-3454	280
397128	18-2289	Obsolete	434400	18-1703	923	438616	18-7800	270
397131	18-3059	277	434421	18-3390	282	438786	18-6281	260
397274	18-7350	270	434421	18-3392	283	438996	18-7221	267
397338	18-2207	Obsolete	434424	18-3001	276	438996	18-7247	267
397537	18-1363	332	434496	18-6780	260	439015	18-4195	292
397538	18-1364	332	434588	18-1729	337	439071	18-7043	267
397541	18-2288	335	434839	18-7916	184, 301	439072	18-7223	268
397627	18-2310	337	434841	18-3543	289	439073	18-7219	267
397768	18-6029	927	434844	18-1376	295	439076	18-7046	267
397839	18-7350	270	434888	18-7046	267	439077	18-3378	281
398042	18-3708-1	329	435022	18-2251	335, 922	439077	18-3399	283
398047	18-4321	304	435027	18-3346	278	439078	18-7248	268
398051	18-2093	334	435096	18-1703	923	439079	18-7248	268
398319	18-7831	140, 274	435276	18-4841	328	439138	18-2288	335
398327	18-7830	274	435277	18-4840	328	439141	18-2623	343
398331	18-6025	343, 927	435279	18-4843	328	439202	18-4420	305
398338	18-7352	270	435390	18-3180	279	439476	18-4807	337
398387	18-7352	270	435442	18-7221	267	439515	18-4165	292
398452	18-7223	268	435442	18-7247	267	439516	18-4086	292
398453	18-7223	268	435443	18-7046	267	439517	18-4087	292
398483	18-4064	292	435447	18-3390	282	439538	18-3947	292
398514	18-7821	270	435491	18-3544	289	439561	18-5828	263
398526	18-7046	267	435548	18-6277	260	439937	18-6281	260
398532	18-7043	267	435673	18-3129	279	439948	18-3059	277
398549	18-8009EP-2	142, 275	435676	18-7248	268	439967	18-2672	929
398549	18-8009S-1	147	435677	18-7248	268	458625	18-0153	605
398602	18-1282	30, 259	435678	18-7248	268	458625	18-0411	905
398729	18-7042	267	435748	18-3059	277	473424	18-1211	904
398729	18-7222	267	435752	18-7248	268	500421	37477	201
398901	18-1368	332	435760	18-2325	334	500422	37478	201
431708	18-6095	343, 927	435761	18-2328	334	500423	37479	201
431708	18-6095A	343, 927	435821	18-3059	277	502036	18-1402	903
431844	18-3974	292	435929	18-3315-2	284	502867	18-8063	275
431870	18-3975	292	435957	18-3501	278	502880	18-5196	253
431897	18-7219	267	435959	18-3405	279	502881	18-5172	253
432072	18-4065	292	436137	18-8906	277	502888	18-5192	253

OMC (Cont.)			OMC (Cont.)			OMC (Cont.)		
O.E. #	SIERRA #	PAGE #	O.E. #	SIERRA #	PAGE #	O.E. #	SIERRA #	PAGE #
502890	18-5194	253	582365	18-8816-1	171, 258	585114	18-5781	S/S to 18-5781-1
502900	18-7875	183, 902	582365	18-8818-1	171-181, 872	585114	18-5781-1	256
502901	18-7876-1	183	582366	18-5176	253	585134	MP28870	30, 259
502903	18-7879-1	183, 902	582382	18-5193	253	585145	18-5774	S/S to 18-5774-1
502904	18-7878-1	183, 902	582399	18-5708	263	585145	18-5774-1	256
502905	18-7846	138, 274, 886	582400	18-5760	255	585189	18-5780	256
502905	18-7946	138, 274, 886	582452	18-5758	255	585219	18-5828	263
502906	18-7789	138, 274, 886	582453	18-5758	255	585261	18-5785	256
502906	18-7989	138, 274, 886	582472	18-5705	261, 878	585267	18-5679	266
503747	18-8807-1	171-181, 872	582508	18-5179	253	585269	18-5678	266
503748	18-8800-1	171-181, 872	582556	18-5760	255	585459	18-5627	265
503749	18-8811-1	171-181, 872	582642	18-5760	255	585995	18-5831	263
503749	18-8814-1	171-181	582705	18-5782	256	586000	18-5832	263
503749	18-8841-1	171-181	582708	18-5808	261, 875	586048	18-5829	263
503750	18-8801-1	171-181, 872	582811	18-5783	256	586075	18-5830	263
503751	18-8810-1	171-181, 872	582995	18-5181	253	586212	18-5781	S/S to 18-5781-1
503752	18-8802-1	171-181, 872	583110	18-5784	S/S to 18-5784-1	586212	18-5781-1	256
503752	18-8803-2	171-181, 872	583110	18-5784-1	256	586217	18-5893	257
503752	18-8823-1	171-181, 872	583114	18-5761	255	586224	18-5705	261, 878
503753	18-8842-1	171-181, 872	583170	18-5763	255	586271	18-5831	263
503754	18-8820-1	171-181, 872	583266	18-5832	263	586274	18-5617	265
503755	18-8802-1	171-181, 872	583298	18-5170	253	586277	18-5631	265
503755	18-8803-2	171-181, 872	583380	18-5758	255	586279	18-5624	265
503755	18-8823-1	171-181, 872	583408	18-5708	263	586281	18-5648	265
503756	18-8843-1	171-181, 872	583473	18-5627	265	586284	18-5632	265
508105	18-2613	906	583476	18-5893	257	586285	18-5628	265
508180	MP39760	28, 259	583482	18-5624	265	586286	18-5612	265
508235	1525607	201	583605	18-5891	257	586287	18-5612	265
508626	18-3543	289	583689	18-5832	263	586288	18-5640	264
508871	18-0348	905	583737	18-5176	253	586343	18-5884	257
508872	18-0407	905	583740	18-5170	253	586661	18-5781	S/S to 18-5781-1
508876	18-0411	905	583748	18-5766	255	586661	18-5781-1	256
509395	18-7278	149	583865	18-5885	257	586667	18-5893	257
509404	18-7283	149	583896	18-5794	256	586696	18-5764	255
509407	18-7282	149	584028	18-5770	S/S to 18-5770-1	586730	18-5801	261, 875
509408	18-7284	149	584028	18-5770-1	256	586731	18-5619	265
509409	18-7274	149	584032	18-5771	256	586774	18-5833	261
509410	18-7275	149	584037	18-5893	257	586842	18-5801	261, 875
510364	18-5224	259, 871	584041	18-5772-1	S/S to 18-5772-1	678882	18-7093	268
510883	18-5226	259	584041	18-5772-1	256	740120	18-1922	898
552906	18-3744	329	584107	18-6761	260	763364	18-7903	184, 301
553126	18-7172	350, 933	584122	18-5886	257	763735	18-3090	277
554545	18-7146	350, 933	584128	18-5813	261	763793	18-5782	256
580148	18-5156	252	584329	18-5794	256	763794	18-5783	256
580256	18-5200	252, 863	584331	18-5794	256	763803	18-5774	S/S to 18-5774-1
580290	18-5157	252	584416	18-5705	261, 878	763803	18-5774-1	256
580321	18-5199	252	584424	18-5832	263	764354	18-9530-3	186
580339	18-5750	259, 475, 562,	584476	18-5827	263	764357	18-9540-3	186
580740	18-5193	253	584477	18-5181	253	764708	18-5755	255
581027	18-5750	259, 475, 562, 576,	584488	18-5883	256	765012	18-3803	307
		595, 624, 871, 946	584489	18-5794	256	765350	18-3104-1	277
581032	18-5194	253	584561	18-5176	253	766779	18-2964	307
581130	18-5163	253	584580	18-5823	261	766870	18-2950	306
581207	18-5141	252	584632	18-5194	253	771839	18-7920	138, 886
581311	18-5753	255	584636	18-5781	S/S to 18-5781-1	772577	18-4911	316
581397	18-5755	255	584636	18-5781-1	256	772578	18-4913	316
581407	18-5196	253	584641	18-5831	263	772579	18-4914	36
581419	18-5205	252	584642	18-5773	256	772584	18-5226	259
581528	18-5814	261, 875	584643	18-5877	260	772681	18-8063	275
581610	18-5192	253	584783	18-5767	256	772681	18-8063	275
581713	18-5757	255	584799	18-5619	265	772831	18-7609-1	156, 879
581726	18-5754	255	584818	18-5631	265	775518	18-3002	276
581731	18-5753	255	584890	18-5826	263	775519	18-3003	276
581778	18-5709	263	584908	18-5768	256	775521	18-3006	276
581786	18-5172	253	584980	18-5632	265	775613	18-9013	198
581805	18-5759	255	584981	18-5878	260	775613	18-9024	198
582048	18-6761	260	584985	18-5887	257	775613	18-9065	198
582056	18-5756	255	585001	18-5827	263	775613	18-9080	198
582057	18-5757	255	585050	18-5648	265	775640	18-8056	275
582091	18-5192	253	585051	18-5634	265	775641	18-8092	275
582125	18-5759	255	585056	18-5624	265	777120	18-9540-7	186
582138	18-5760	255	585057	18-5634	265	777130	18-3086	888
582155	18-6761	260	585058	18-5648	265	777213	18-3083	277
582160	18-5194	253	585059	18-5627	265	777228	18-9530-7	186
582261	18-5764	255	585060	18-5628	265	778885	18-7915-1	184, 301
582285	18-5763	255	585061	18-5629	265	778886	18-7896	183, 301
582365	18-5231-1	258	585062	18-5640	264	778887	18-7897	183, 301
582365	18-8815-1	171, 258	585063	18-5630	265	778888	18-7895	183, 301

OMC (Cont.)			OMC (Cont.)			OMC (Cont.)		
O.E. #	SIERRA #	PAGE #	O.E. #	SIERRA #	PAGE #	O.E. #	SIERRA #	PAGE #
778992	18-5640	264	911666	18-02066	914	912978	18-4408	906
778994	18-5628	265	911667	18-02067	914	912979	18-1238	905
778995	18-5617	265	911668	18-0207	914	912981	18-0347	909
778996	18-5631	265	911669	18-0209	914	912988	18-0887	910
787133	18-9125	202, 276	911669	18-0211	914	912989	18-1213	904
787145	18-9125	202, 276	911670	18-0209	914	913270	18-0664	909
787145	18-9141	202, 276	911670	18-0211	914	913275	18-0887	910
797407	18-3015	276	911671	18-0209	914	913276	18-2815	910
907761	18-0114	SS to 18-0114-1	911671	18-0211	914	913277	18-0347	909
907761	18-0114-1	899, 908	911672	18-0209	914	913393	18-0401	908
907764	18-0104	908	911672	18-0211	914	913488	18-75100	893
907774	18-3111	890	911673	18-0209	914	913745	18-0528	904
907775	18-2883-1	908	911673	18-0211	914	913758	18-0352	909
907866	18-3731	920	911674	18-0209	914	913783	18-0943-2	908
907932	18-2830-1	908	911674	18-0211	914	913783	18-0943-2-9	908
907967	18-2073	931	911675	18-0209	914	913784	18-1909-1	898
908013	18-2875-1	900, 908	911675	18-0211	914	914036	18-2764	919
908013	18-2875-1-9	900	911676	18-0209	914	914323	18-0518	911
908034	18-7859	887	911676	18-0211	914	914445	18-4024	911
908062	18-4251	920	911677	18-0209	914	914488	18-8369	911
908063	18-2176	920	911678	18-0211	914	914555	18-3937	903
908064	18-3725	920	911678	18-0227	914	914556	18-3939	903
908065	18-2071	931	911679	18-0229	914	914557	18-3938	903
908069	18-2177	920	911680	18-02060	914	914716	18-2383	922
908070	18-2072	931	911681	18-02061	914	914723	18-0652	924
908079	18-2912-1	908	911685	18-2067	347, 931	914736	18-0655	924
908087	18-2184	922	911686	18-7169	350, 933	914743	18-0654	924
908158	18-3153	285, 309	911693	18-1701	921	914787	18-15450	893
908194	18-7400	350, 933	911698	18-0911	909	914816	18-4161	903
908237	18-3881	907	911700	18-7407	350, 933	914817	18-1213	904
908383	18-7401	350, 933	911701	18-2068	347, 931	914820	18-1239	905
908611	18-2946	907	911702	18-2916	910	914849	18-3877	907
908717	18-0183-1	643, 781	911703	18-3121	890	914899	18-1848	898
908765	18-0435	907	911704	18-2541	908	914930	18-3879	907
908852	18-2071	931	911705	18-0166	910	914971	18-3876	907
908894	18-2072	931	911718	18-7408	350, 933	915025	18-2909	909
908929	18-15455	893	911734	18-4837	890	915236	18-4160	903
908935	18-2850-1	900	911750	18-4828	924	915272	18-2383	922
909048	18-7477	350, 933	911751	18-3768	329, 924	915325	18-3887	907
909121	18-2183	921	911752	18-3610	924	915326	18-0468	910
909314	18-2902-1	900	911753	18-3769	920	915702	18-2068	347, 931
909314	18-2902-1-9	900	911787	18-2138	927	915716	18-2104	915
909316	18-7403	350, 933	911795	18-8349	347	915717	18-2174	915
909515	18-0548	909	911797	18-2533	919	915719	18-0440	909
909527	18-2768	919	911820	18-4250	911	915720	18-4833	890
909529	18-0947	909	911823	18-2996	911	915735	18-5433	865
909533	18-3365	285, 309	911826	18-2763	919	915840	18-2918	911
909613	18-0418	909	911836	18-2918	911	916058	18-2068	347, 931
909747	18-7404	350, 933	911844	18-3145	890	916096	18-1922	898
909748	18-0188	911	911851	18-7153	350, 933	916262	18-0183-1	643, 781
909753	18-2185	922	911871	18-7409	350, 933	976669	18-6020	343, 926
909758	18-0434	907	911878	18-0880	910	979659	18-7072	880
909786	18-0943-2	899, 908	911937	18-3770	915	979719	18-7080	880
909818	18-15500	893	912029	18-4835	920	979774	18-5803	875
909829	18-0549	911	912157	18-0190	910	980014	18-1712	337
909830	18-0550	911	912164	18-1204-1	909	980152	18-5386	864
909835	18-0891	910	912164	18-1204-1-9	909	980183	18-2156	925
909863	18-1921	898	912212	18-2146	915	980477	18-3599-1	S/S to 18-3599-2
909971	18-15460	893	912213	18-2128	919	980477	18-3599-2	887
910048	56507	202, 276	912214	18-2104	915	980528	18-7608-1	156, 879
910113	18-0673	908	912227	18-3879	907	980530	18-7609-1	156, 879
910139	18-7855	889	912374	18-2745	919	980613	18-5897	891
910169	18-5399	907	912405	18-0956-1	908	980617	18-1876	970
910236	18-2911	910	912418	18-15500	893	980803	18-5903	874
910305	18-75100	893	912424	18-75100	893	980892	18-5407	863
910343	18-15415	893	912441	18-1902	897	980893	18-5303	863
910380	18-1922	898	912442	18-1903	897	980894	18-5347	863
910384	18-4009	898	912471	18-0431	908	980902	18-5309-1	869
910414	18-15380	893	912477	18-0430	908	980959	18-1904	897
910582	18-7174	350, 933	912509	18-15435	893	981078	18-5911	873
910641	18-7792	886	912614	18-3502	890	981080	18-5312-1	869
910995	18-2216	336	912714	18-15520	893	981195	18-2071	347
911019	18-2066	347, 931	912766	18-3878	907	981196	18-2072	347, 931
911311	18-7406	350, 933	912768	18-0464	909	981268	18-2073	347, 931
911616	18-8021	145, 276, 887	912793	18-75125	893	981288	18-5908	874
911662	18-02062	914	912954	18-0468	910	981289	18-5907	873
911663	18-02063	914	912955	18-0405	905	981359	18-7615-1	153, 879
911665	18-02065	914	912965	18-2845	909	981428	18-7615-1	153, 879

OMC (Cont.)			OMC (Cont.)			OMC (Cont.)		
O.E. #	SIERRA #	PAGE #	O.E. #	SIERRA #	PAGE #	O.E. #	SIERRA #	PAGE #
981564	18-7615-1	153, 879	983967	18-4750	924	986779	18-3575	S/S to 18-3593
981566	18-7229	884	983973	18-2765	919	986779	18-3593	887
981650	18-7268	149, 883	984012	18-1602	922	986782	18-7236	881
981705	18-7615-1	153, 879	984054	18-1901	897	986783	18-7235	881
981797	18-2663	928	984180	18-7609-1	156, 879	986784	18-7237	881
981799	18-2666	928	984264	18-6399	915	986796	18-7238	881
981801	18-2669	929	984290	18-21752-1	919	986799	18-7237	881
981803	18-7615-1	153, 879	984356	18-6814	878	986800	18-7239	881
981821	18-5903	874	984360	18-3575	S/S to 18-3593	986804	18-7241	881
981911	18-7861	887	984360	18-3593	887	986865	18-7229	884
982019	18-6950	878	984398	18-5353	864	987136	18-5303	863
982058	18-6755	878	984401	18-5352	864	987251	18-2791	930
982063	18-7267	149, 883	984456	18-5910	874	987313	18-7242	881
982069	18-6764	878	984458	18-2672	929	987315	18-7243	881
982073	18-6764	878	984459	18-2673	930	987317	18-7244	881
982121	18-5911	873	984461	18-3212-1	891	987319	18-7245	881
982132	18-2595	347	984461	18-3348	891	987438	18-7246	881
982195	18-5908	874	984487	18-7086	880	987440	18-7246	881
982202	18-5907	873	984491	18-7854	886	987447	18-3577-1	S/S to 18-3577-2
982209	18-5376	864	984513	18-6028	927	987447	18-3577-2	887
982211	18-5404-1	863	984513	18-6028A	927	987467	18-2765	919
982217	18-7608-1	156, 879	984513	18-6102	927	987485	18-7246	881
982217	18-7609-1	156, 879	984536	18-6270	873	987603	18-2673	930
982219	18-7608-1	156, 879	984536	18-6276	873	987661	18-2245-1	919
982223	18-7615-1	153, 879	984537	18-21754	919	987678	18-2246	919
982230	18-7862	887	984547	18-6103	927	987738	18-5888	865
982240	18-7278	149, 883	984547	18-6103A	927	987739	18-5889	865
982277	18-6019	926	984628	18-5917	874	987740	18-5890	865
982336	18-5369	864	984629	18-21755	919	987774	18-6261	877
982342	18-5411	864	984744	18-3206	890	987784	18-1922	898
982352	18-7018	880	984748	18-7634	927	987811	18-5920	873
982364	18-5957	877	984765	18-4806	914	987894	18-5303	863
982384	18-7070	880	984770	18-4804	914	987895	18-5347	863
982422	18-1099	924	984771	18-4805	914	987925	18-5258	862
982424	18-2186	922	984876	18-3578	887	987926	18-5260	862
982438	18-6019	926	984982	18-5908	874	987986	18-5413	864
982515	18-3584	887	985050	18-2218	336, 922	988013	18-6270	873
982517	18-3584	887	985052	18-7017	880	988013	18-6276	873
982537	18-7081	880	985063	18-5812	875	988037	18-7330	150, 884
982539	18-7096	881	985064	18-5801	261, 875	988162	18-0410	905
982554	18-3558	891	985083	18-3937	903	988217	18-5919	873
982650	18-5899	891	985218	18-5397	864	988247	18-6841	877
982706	18-6755	878	985237	18-6759	260	989966	18-2218	336
982880	18-5403	863	985316	18-1401	903	1984462	18-5717	875
982946	18-2665	928	985429	18-3599-1	S/S to 18-3599-2	3850216	18-5811	875
982947	18-2664	928	985429	18-3599-2	887	3850357	18-7677	878
982949	18-2667	929	985518	18-2674	930	3850379	18-1238	905
982957	18-6257	878	985560	18-5313-1	869	3850396	18-7684	878
982997	18-7289	150, 883	985602	18-7278	149, 883	3850426	18-1074	919
983195	18-6257	878	985603	18-7278	149, 883	3850456	18-1909-1	898
983218	18-3386	891	985612	18-2671	929	3850495	18-2875-1	900, 908
983247	18-6842	646	985613	18-2672	929	3850495	18-2875-1-9	900
983296	18-3577-1	S/S to 18-3577-2	985630	18-0868	905	3850496	18-0943-2	899, 908
983296	18-3577-2	887	985822	18-7615-1	153, 879	3850595	18-0893	910
983298	18-3119	890	985902	18-5890	865	3850597	18-2791	930
983318	18-6764	878	985966	18-5911	873	3850799	18-1922	898
983424	18-6841	877	986007	18-5908	874	3850809	18-7326	150, 884
983424	18-6842	646	986074	18-3577-1	S/S to 18-3577-2	3850810	18-7331	150, 884
983444	18-5911	873	986074	18-3577-2	887	3850812	18-2174	915
983494	18-6101	927	986103	18-0410	905	3850813	18-2128	919
983538	18-7081	880	986104	18-0410	905	3850814	18-2337	915
983790	18-5911	873	986120	18-21752-1	919	3850815	18-2146	915
983825	18-1600	922	986145	18-2438	Obsolete	3852109	18-0874	907
983826	18-1601	922	986232	18-21754	919	3852111	18-0398	908
983836	18-6841	877	986280	18-6779	878	3852113	18-0876	907
983836	18-6842	646	986336	18-3937	903	3852215	18-5894	19, 887, 962
983855	18-7615-1	153, 879	986338	18-21751	919	3852338	18-1848	898
983864	18-7095	880	986364	18-2673	930	3852350	18-4194	925
983870	18-7855	886	986380	18-4806	914	3852374	18-1986-1	897
983871	18-7201	882	986381	18-4804	914	3852384	18-2339	915
983877	18-1172	920	986382	18-4805	914	3852455	18-0183-1	643, 781
983878	18-1171	920	986423	18-2674	930	3852477	18-0891	910
983880	18-2338	915	986505	18-5910	874	3852531	18-7407	350, 933
983891	18-1161	332, 920	986629	18-2783	930	3852548	18-8349	374, 931
983892	18-1170	920	986642	18-5108	864	3852560	18-2996	911
983895	18-3058	888	986643	18-5361	864	3852563	18-1713	914
983902	18-21751	919	986651	18-5406	863	3852565	18-7153	350, 933
983937	18-2100	914	986658	18-0647	924	3852568	18-4749-9	914

OMC (Cont.)			OMC (Cont.)			OMC (Cont.)		
O.E. #	SIERRA #	PAGE #	O.E. #	SIERRA #	PAGE #	O.E. #	SIERRA #	PAGE #
3852648	18-3730	925	3854809	18-6261	877	5035703	18-7895	183, 301
3852654	18-0468	910	3854905	18-7679	878	5035974	18-7953	274
3852655	18-0405	905	3854942	18-0311	909	5036216	18-3498	271
3852656	18-0322	910	3854956	18-0518	911	173232, 502902	18-7824-2	183, 902
3852657	18-0519	904	3855104	18-7792	886	173232, 502902	18-7824-2	183, 902
3852687	18-0664	909	3855182	18-7689	878	175158+437228	18-7044	268
3852691	18-0887	910	3855270	18-1909-1	898	584605, 586275	18-6863	266
3852692	18-2815	910	3855412	18-6028	927	85R-4541	18-7096	881
3852693	18-0347	909	3855412	18-6028A	927			
3852696	18-2779	899	3855412	18-6102	927			
3852741	18-2780-1	963	3855958	18-7330	150, 884	PERKINS		
3852742	18-2781	899	3856127	18-1400	903	2654403	18-7886	182, 672
3852824	18-0147	909	3856138	18-1237	905	185086600	18-6944	662
3853132	18-0518	911	3856444	18-1909-1	898	2871A651	18-5975	661
3853226	18-4024	911	3856600	18-6261	877			
3853256	18-0680	909	3857561	18-6261	877	PLEASURECRAFT		
3853268	18-3937	903	3857650	18-7330	150, 884	3705042	18-0889	631
3853336	18-2946	907	3857656	18-1848	898	9-37824	18-37824	628
3853340	18-4161	903	3857723	18-1986-1	897	R017066	18-3700	632
3853341	18-1213	904	3857944	18-1909-1	898	R020027	18-7677	627
3853342	18-0327	909	3857985	18-7331	150, 884	R020035A	18-7646	627
3853361	18-0903	909	3857986	18-7326	150, 884	R026002E	18-3551	628
3853380	18-3876	907	3858261	18-7326	150, 884	R047111	18-7480	628
3853477	18-4160	903	3858340	18-3593	887	R077001	18-7875	183, 632
3853510	18-1232	905	3858437	18-21752-1	919	R077002	18-7824-2	183, 902
3853511	18-3874	907	3858714	18-7331	150, 884	R084003	18-7697	627
3853512	18-0468	910	3860095	18-1233	904	R094020A	18-2702-1	853
3853528	18-1234	904	3860171	18-6261	877	R096116	18-4220	632
3853655	18-2068	347, 931	3911020	18-4173	903	R096117	18-3200	632
3853732	18-3883	907	3911023	18-4164	903	R098002	18-5727	Obsolete
3853742	18-0183-1	643, 781	3921473	18-0466	905	R103001	18-5404-1	620
3853796	18-3584	887	3923440	18-0466	905	R103003	18-5407	620
3853799	18-3558	891	3930912	18-0346	909	R103004	18-5403	620
3853818	18-6028	927	3931593	18-0348	905	R103011	18-5245	620
3853818	18-6028A	927	3935449	18-0980	910	R108001	18-5376	621
3853818	18-6102	927	5000074	18-1702	923	R114001	18-5314	620
3853827	18-1230	904	5000309	18-8383	346	R114002	18-5303	620
3853847	18-1401	903	5000356	18-4801	914	R114004	18-5314	620
3853850	18-3599-1	S/S to 18-3599-2	5000363	18-1703	923	R115001	18-5338	620
3853850	18-3599-2	887	5000400	18-4421	305	R115002	18-5345	620
3853862	18-21753	919	5000581	18-6528	341	R117001	18-5433	625
3853912	18-0410	905	5001036	18-3546	289	R117012	18-7648	625
3853913	18-0410	905	5001344	18-5768	256	R119001	18-5450	625
3853917	18-21752-1	919	5001593	18-3059	277	R130001	18-5801	626
3853945	18-6779	878	5001594	18-3390	282	R130012	18-15214	626
3853960	18-3937	903	5001594	18-3392	283	R142006	18-2434	558, 632
3853962	18-21751	919	5001595	18-3315-2	284	RA057004	18-3584	628
3854001	18-5108	864	5004257	18-1703	284	RA057018	18-3599-1	S/S to 18-3599-2
3854002	18-5443	865	5004705	18-4148-1	295	RA057018	18-3599-2	628
3854003	18-5107-1	864	5005113	18-6802	261	RA057019	18-3577-1	S/S to 18-3577-2
3854017	18-3575	S/S to 18-3593	5005114	18-6801	261	RA057019	18-3577-2	628
3854017	18-3593	887	5005115	18-6803	261	RA057023	18-3586-1	628
3854033	18-1402	903	5005254	18-6281	260	RA057024	18-3587-1	628
3854072	18-30585	888	5005266	18-7722	274	RA057036	18-42608	628
3854095	18-1231	905	5005440	18-3543	289	RA097002	18-5957	626
3854118	18-3577-1	S/S to 18-3577-2	5006319	18-6744	260	RA097003	18-5957	626
3854118	18-3577-2	887	5006373	18-8384	346	RA097006	18-5957	626
3854127	18-2765	919	5006511	18-3453	280	RA097007B	18-5984	626
3854158	18-7601	878	5007556	18-3476	285	RA097007B	18-6288	626
3854182	18-6261	877	5007662	18-6803	261	RA097007C	18-6453	626
3854190	18-5920	873	5007972	18-3472	284	RA097009	18-6452	626
3854194	18-6291	875	5008968	18-8905	279	RA107001	18-5309-1	622
3854217	18-5248	864	5008972	18-4537	284	RA108002	18-5369	621
3854252	18-3939	903	5030087	18-3735	329	RA108003	18-5352	621
3854269	18-0868	905	5030699	18-3499	271	RA108009	18-5244	621
3854280	18-7330	150, 884	5030973	18-74108	346	RA122001	18-5244	621
3854286	18-3060	964, 978	5031411	18-7915-1	184, 301	RA122001	18-5903	626
3854299	18-3879	907	5031417	18-8904	277	RA122008	18-5920	626
3854311	18-5408	863	5031456	18-8337	346	RA122008	18-5907	625
3854331	18-5362	864	5032238	18-7719	274	RA122009	18-5603	625
3854406	18-0410	905	5032323	18-7716	274	RA122009	18-5908	625
3854512	18-7703	878	5032424	18-7773	267	RA122019	18-6443	625
3854539	18-2454	927	5033102	18-7903	184, 301	RK122014	18-5920	626
3854548	18-5354	864	5033112	18-3099	277	RM0002	18-0677-1	631
3854549	18-5405	863	5033372	18-3497	271	RM0003	18-0878	631
3854620	18-7326	150, 884	5033539	18-7896	183, 301	RM0007	18-0183-1	631
3854661	18-3469	891	5033542	18-8907	277	RM0017	18-0898	631
3854751	18-5913	874	5033919	18-7897	183, 301	RM0032	18-3883	632
						RM0099	18-0676-1	631
						RN0067	18-7227	626

Suzuki (Cont.)			Suzuki (Cont.)			Suzuki (Cont.)		
O.E. #	SIERRA #	PAGE #	O.E. #	SIERRA #	PAGE #	O.E. #	SIERRA #	PAGE #
15170-94320	18-3496	462	17471-87E01	18-3192	465	55320-95310	18-6032	470
15170-94J00	18-3498	462	17471-92D10	18-3193	465	56132-95J00	18-0650	470
15170-94JOV	18-3498	462	17471-92J00	18-3192	465	57630-92E00	18-3775	470
15170-99E00	18-3499	462	17471-93902	18-3190	465	57630-94300	18-3777	470
15410-87J10	18-7716	463	17471-94501	18-3191	465	57630-94500	18-3774	470
15410-87J30	18-7953	463	17471-98503	18-3188	465	57630-96300	18-3778	470
15410-94400	18-7735	463	17472-91J00	18-0761	467	65720-94401	18-80409	464
15410-96J00	18-7711	463	17472-92D10	18-0479	467	65720-94411	18-8087	464
15410-98500	18-7719	463	17472-93911	18-0478	467	65720-986B0	18-80425	464
15412-93J00	18-7936	463	17472-93J00	18-0778	467	65740-95500	18-8078	464
16510-05240	18-7903	184, 469	17472-95200	18-0459	467	65750-87J10	18-80419	464
16510-45H10	18-8870	184, 469	17472-95310	18-0460	467	65750-87J11	18-80419	464
16510-61A20-MHL	18-7896	183, 469	17472-96301	18-0461	467	65750-94404	18-80418	464
16510-82703	18-7897	183, 469	17472-98503	18-0477-9	467	65750-95500	18-8079	464
16510-87J00	18-7915-1	184, 469	17472-98611	18-0480	467	65750-95510	18-8079	464
16510-93J00	18-7895	183, 469	17472-98J00	18-0651	470	65750-98505	18-8062	464
16510-96J00	18-7905-1	184, 469	17582-93J00	18-0793	467	990C0-10W40-1GL	18-9551-3	187
17400-87D11	18-3253	466	17685-87D10	18-0797	467	990C0-10W40-1QT	18-9551-2	187
17400-87E03	18-3254	466	17685-97J00	18-0794	467	99105-00192	18-8071	464
17400-87E04	18-3254	466	17685-98J00	18-0795	467	99105-00193	18-8078	464
17400-90J11	18-3258	466	17685-99E00	18-0796	467	99105-20004-BWL	18-7922-1	137, 463
17400-90J20	18-3258	466	18213-98J00	18-32154	463	99105-20005	18-7948	139, 463
17400-92D01	18-3255	466	25223-94400	18-8334	470	99105-20006	18-7947	139, 463
17400-93951	18-3256	466	25700-87D00	18-8335	471	99105-20006-BWL	18-7987	139, 463
17400-93J00	18-3264	466	25700-90J01	18-8373	471	UNIVERSAL		
17400-93J02	18-3264	466	25700-92J00	18-8374	471	288182	18-6263	634
17400-94611	18-3257	466	25700-93J00	18-8380	470	288759	18-6263	634
17400-94700	18-3243	466	25700-94400	18-8337	471	299381	18-7884	182, 672
17400-94701	18-3243	466	25700-94500	18-8338	471	301068	18-6140	559
17400-95350	18-3244	466	25700-94700	18-8339	471	301069	18-6141	559
17400-95351	18-3244	466	25700-95500	18-8340	471	VALEO		
17400-95550	18-3244	466	25700-95D00	18-8341	471	541663	18-5943	953
17400-96350	18-3242	466	25700-95J00	18-8385	472	2541451	18-5939	953
17400-96351	18-3242	466	25700-98J00	18-8386	472	2937430	18-5976	953
17400-96353	18-3242	466	25700-99E00	18-8381	470	2939590	18-5975	661
17400-98551	18-3259	466	31100-89J00	18-6419	461	A0002655299	18-6848	953
17400-98652	18-3260	466	31100-90J00	18-6831	461	A13N147M	18-5959	952
17400-98661	18-3266	467	31100-92E00	18-6417	461	A13N148M	18-5959	952
17400-98J00	18-3267	467	31100-93J00	18-6941	461	A13N1M	18-5959	952
17400-98J01	18-3267	467	31100-94600	18-6827	461	A13N234	18-5939	953
17411-93901	18-3480	467	31100-94601	18-6827	461	A13N259	18-5943	953
17411-94421	18-3481	467	31100-94610	18-6416	461	A13N2M	18-5959	952
17461-87E11	18-3049	464	31100-94610	18-6827	461	VOLVO		
17461-87E12	18-3049	464	31100-94702	18-6429	461	35254	18-5436	941
17461-90J00	18-3023	464	31100-95313	18-6428	461	72021	18-6846	661, 953
17461-90J01	18-3023	464	31100-95600	18-6414	461	82744	18-4217	Obsolete
17461-92D02	18-3000	464	31100-95J00	18-6945	461	82745	18-4218	972
17461-93001	18-3092	464	31100-95J01	18-6945	461	125017	18-7178	993
17461-93003	18-3092	464	31100-96J00	18-6941	461	174448	18-9098	988
17461-93004	18-3092	464	31100-96J01	18-6941	461	181620	18-2057	993
17461-93901	18-3099	465	31173-95310	18-56008	461	192212	18-4201	977
17461-93902	18-3099	465	31173-99E00	18-56009	461	233991	18-6872	662, 952
17461-93903	18-3099	465	32140-93900	18-5152	460	240149	18-5306	939
17461-93J00	18-3035	464	32900-93911	18-5144	460	240501	18-6872	662, 952
17461-94500	18-3023	464	33410-92L10	18-5151	460	241669	18-5393	940
17461-94501	18-3023	464	33410-94400	18-5151	460	241812	18-6271	955
17461-94502	18-3023	464	37100-87J00-OEP	18-18304	462	243460	18-5305	939
17461-94503	18-3023	464	37110-99-E00	MP51010	23, 460	243632	18-5357	940
17461-94504	18-3023	464	37110-99-E00	MP51012	23, 460	243653	18-5342	939
17461-94505	18-3023	464	38100-87000-OIT	18-6785	462	243658	18-5394	940
17461-94506	18-3023	464	38100-87D10-OED	18-6786-1	462	243797	18-5356	940
17461-94510	18-3023	464	38100-87D10-OIT	18-6786-1	462	243799	18-5305	939
17461-94511	18-3023	464	38100-87D10-35J	18-6786-1	462	243801	18-5319	939
17461-94520	18-3023	464	38100-87E10-OED	18-6785	462	243903	18-5428	940
17461-94700	18-3094	465	38100-87E20-OED	18-6785	462	273663	18-7783	670
17461-94701	18-3094	465	38100-87J0EP	18-18304	462	324825	18-8204	963
17461-95300	18-3095	465	38100-87J11	18-6793	462	328516	18-3938	979
17461-95301	18-3095	465	38100-87J20	18-6793	462	329653	18-8203	963
17461-95302	18-3095	465	38100-92E00-OED	18-6786-1	462	370409	18-3944	979
17461-96301	18-3096	465	38100-92J02	18-18303	462	416033	18-2933	984
17461-96311	18-3096	465	38100-92J10	18-18303	462	418265	18-2974	984
17461-96312	18-3096	465	38100-93J01	18-18303	462	418411	18-2935	986
17461-98501	18-3097	465	38100-93J02	18-18303	462	418412	18-2937	986
17461-98502	18-3097	465	38100-96J00	18-18303	462	418445	18-2936	986
17461-98503	18-3097	465	38860-76F01	18-5731	462	418870	18-2922	984
17461-985M0	18-3097	465	48600-94511-OED	18-6865	Obsolete			
17462-93990	18-3292	465	55125-87D00	18-6033	470			
17471-87D01	18-3189	465	55125-96310	18-6098	470			

Volvo (Cont.)			Volvo (Cont.)			Volvo (Cont.)		
O.E. #	SIERRA #	PAGE #	O.E. #	SIERRA #	PAGE #	O.E. #	SIERRA #	PAGE #
419310	18-2965	982	834476	18-2531	986	852835	18-6004A	991
419652	18-4474	976	834520	18-5806	954	852835	18-6105	991
419653	18-4473	976	834548	18-4044	976	852928	18-6274	956
419678	18-2923	985	834560	18-5348	939	852928	18-6838	955
419734	18-4468	976	834609	18-5959	952	852928	18-6881	955
419735	18-4470	976	834751	18-2766	988	852928	18-6822	955
423135	18-7926	182, 673	834893	18-5911	951	853012	18-710-64-2	988
430017	18-2518	985	834963	18-5959	952	853255	18-2104	989
430018	18-2525	986	834975	18-5425	940	853548	18-7306	988
430020	18-2994	987	835304	18-5314	939	853670	18-2040	993
430039	18-2924	985	835308	18-5338	939	853868	18-25251	986
430143	18-7878-1	183, 977	835390	18-3599-1	S/S to 18-3599-2	854031	18-2777	973
430172	18-2526	986	835390	18-3599-2	963	854045	18-4210	989
461092	18-2925	984	835417	18-0398	984	854047	18-4213	990
461511	18-1479	976	835440	18-7824-2	183, 977	854329	18-6792	956
462623	18-2966	982	835512	18-3060	964	854346	18-6770	955
463377	18-4029	976	835576	18-7859	961	855326	18-5911	951
463505	18-7890	977	835702	18-5369	940	855383	18-2991-1	984
463587	18-2926	985	835704	18-5345	939	855383	18-2991-1-9	972, 984
463902	18-4245	977	835705	18-5303	939	855387	18-1930-2	969
463999	18-2927	985	835804	18-1931-1	969	855507	18-6456	988
466634	18-7880	182, 977	835874	18-3047	964	855798	18-5657	946
466987	18-7942	139, 670, 961	835874	18-3061	964	855845	18-5403	939
477024	18-4200	977	835966	18-2949	984	855889	18-7072	956
477556	18-0034	182, 672, 977	835998	18-5433	941	855967	18-2991-1	972, 984
502036	18-1402	979	837924	18-6872	662, 952	855967	18-2991-1-9	972, 984
803762	18-1727	977	838513	18-70704	966	856028	18-2929	987
804190	18-0184	989	838637	18-4466	976	856034	18-2949	984
804261	18-4259	986	838638	18-4471	976	856037	18-2995	984
804695	18-2039	993	838928	18-6021	992	856044	18-2928	984
806256	18-3106	963	838929	18-6001	991	856116	18-2909	970
807036	18-4216	972	839423	18-4208	989	856306	18-70704	966
808007	18-3274	964	839430	18-6790	956	856364	18-3599-1	S/S to 18-3599-2
812994	18-4150	973	839534	18-4209	989	856364	18-3599-2	963
813967	18-8368	989	840808	18-5906	951	856470	18-7099	957
814301	18-2153	990	841070	18-5352	940	856471	18-7000	958
814356	18-2939	987	841161	18-7286	150, 958	856472	18-7000	958
818525	18-5419	940	841162	18-7862	961	856474	18-3876	983
820545	18-6822	955	841177	18-6268	955	856609	18-3577-1	S/S to 18-3577-2
820652	18-59710	952	841207	18-3876	983	856609	18-3577-2	963
822454	18-59710	952	841243	18-5411	940	856883	18-1931-1	969
824633	18-2928	984	841244	18-5375	940	856891	18-1935-1	970
824677	18-2989	984	841262	18-5349	939	856894	18-1932	969
824803	18-7099	957	841263	18-5358	940	857037	18-1936	968, 969, 971, 972
826341	18-4204	989	841292	18-7000	958	858201	18-7858	139, 670, 961
826423	18-75125	966	841380	18-59700	952	858459	18-35444	670
826493	18-7281	149, 958	841640	18-3586-1	963	858467	18-3175	963
826495	18-5959	952	841750	18-7879-1	183, 977	858488	18-7907	977
826648	18-7888	963	841762	18-5959	952	859155	18-3843	983
827247	18-2045	993	841762	18-59700	952	859428	18-35442	958
827303	18-59710	952	841763	18-59700	952	859647	18-3867	983
829207	18-15460	966	841765	18-5959	952	861250	18-0307	985
829592	18-4219	972	841765	18-59700	952	861251	18-0310	985
829620	18-4464	976	841766	18-5959	952	861477	18-8126	139, 961
829714	18-2934	986	841766	18-59700	952	862293	18-7888	963
829913	18-8124	139, 961	841821	18-15430	966	870670	18-6271	955
831009	18-3106	963	841907	18-5403	939	870690	18-5357	940
831617	18-2527	986	841926	18-5353	940	870998	18-6958	662, 952
831622	18-2519	986	841994	18-7086	957	872022	18-6846	661, 953
831891	18-2528	986	842775	18-6872	662, 952	872066	18-7647	962
831892	18-2529	986	843511	18-6872	662, 952	872235	18-5939	953
832570	18-4206	989	845363	18-28050	172, 178, 179, 944	872241	18-5906	951
832598	18-6000	991	845792	18-75125	966	872272	18-6268	955
832598	18-6000A	991	845940	18-6846	661, 953	872300	18-6266	955
832598	18-6104	991	847651	18-59710	952	872449	18-6838	955
832669	18-2990	987	847741	18-0032	182, 672, 977	872449	18-6881	955
832675	18-2199	987	849561	18-59710	952	872757	18-6846	661, 953
832820	18-4205	989	849602	18-59710	952	872793	18-6124Z	991
832831	18-2776	973	850046	18-6791	956	872926	18-5943	953
832846	18-2778	973	850785	18-4210	989	873051	18-6838	955
832965	18-4234	989	850834	18-6758	956	873178	18-6004	991
833188	18-4463	976	850888	18-4211	989	873178	18-6004A	991
833274	18-3842	983	850889	18-4212	990	873178	18-6105	991
833453	18-3834	983	851120	18-6951	955	873179	18-6000	991
833950	18-4005	977	851261	18-4213	990	873179	18-6000A	991
833995	18-3076	964	851407	18-0558	993	873179	18-6104	991
833996	18-2044	993	852520	18-6791	956	873228	18-2432	987
834337	18-7884	182, 977	852835	18-6004	991	873229	18-2433	987

Volvo (Cont.)			Volvo (Cont.)			Volvo (Cont.)		
O.E. #	SIERRA #	PAGE #	O.E. #	SIERRA #	PAGE #	O.E. #	SIERRA #	PAGE #
873395	18-6123Z	991	877066	18-3275	964	1378864	18-2926	985
873635	18-6846	661, 953	877349	18-3658	974	1378870	18-2972	985
873757	18-6846	661, 953	881681	18-6872	662, 952	1378879	18-2930	984
873770	18-5939	953	881682	18-6958	662, 952	1378909	18-2927	985
873771	18-6846	661, 953	897367	18-4214	990	1378911	18-2922	984
875192	18-2625	993	897426	18-2041	993	1378913	18-2925	984
875383	18-3209	965	897707	18-2104	989	1502272	18-6846	661, 953
875400	18-2983	982	897720	18-6792	956	1542389	18-4469	976
875401	18-2980	982	897873	18-4239	990	1542472	18-4467	976
875407	18-7085	956	908611	18-2946	982	2430184	18-3037	964
875422	18-2596	981	912213	18-2128	989	2430184	18-3078	964
875550	18-2793	977	912227	18-3879	983	2655301	18-6847	953
875569	18-2982	982	912957	18-0519	980	2656299	18-6848	953
875571	18-8813-1	171-181, 944	912979	18-1238	971	3287677	18-5745	941
875574	18-3205	965	914323	18-0518	980	3517857	18-7878-1	183, 977
875575	18-3075	964	914445	18-4024	980	3523301	18-6839	952
875580	18-3666	974	914556	18-3939	979	3547991	18-2530	986
875583	18-3076	964	914557	18-3938	979	3580309	18-0498	982
875584	18-3208	965	914816	18-4161	979	3582310	18-35443	670
875660	18-3037	964	914930	18-3879	983	3582358	18-7908	977
875660	18-3078	964	915236	18-4160	979	3582561	18-4473	976
875698	18-3263	965	925054	18-7179	993	3582606	18-4474	976
875736	18-3037	964	925055	18-7180	993	3582609	18-4465	976
875736	18-3078	964	925065	18-7190	993	3582732	18-0035	182, 672, 977
875741	18-8357	993	925091	18-7181	975, 993	3582733	18-0036	182, 672, 977
875759	18-3262	965	925092	18-7182	471, 993	3583443	18-8125	139, 961
875769	18-3261	965	925093	18-7183	471, 993	3583555	18-6944	662
875779	18-3654	973	925095	18-7122	993	3583786	18-3868	983
875781	18-3656	974	925256	18-7184	993	3586461	18-6125A	991
875784	18-3658	974	925259	18-7186	993	3586498	18-3079	965
875785	18-3659	974	925261	18-7187	993	3586765	18-6838	955
875787	18-3660	974	941816	18-4215	990	3587079	18-6806	955
875791	18-3663	974	941907	18-4236	973	3587597	18-3615	974
875794	18-3662	974	943218	18-4238	990	3587625	18-5913	951
875795	18-3664	974	943414	18-2367	977	3588475	18-3504	964
875796	18-3665	974	946242	18-2046	993	3803227	18-5943	953
875805	18-6005	991	949656	18-7154	993	3803227	18-59700	952
875808	18-3080	965	950813	18-15410	966	3803260	18-5939	953
875815	18-6009	991	950818	18-15460	966	3803645	18-6953	661
875815	18-6009A	991	951924	18-4241	990	3808516	18-7708	941
875821	18-6010	991	952141	18-15500	966	3825038	18-79007	962
875821	18-6010A	991	955974	18-7193	993	3825133	18-7942	139, 670, 961
875821	18-6106	991	955983	18-7188	993	3827069	18-7974	184, 977
875822	18-2775	973	955989	18-7149	237, 993	3831424	18-3538	974
875826	18-2744	988	955995	18-7192	993	3831425	18-3660	974
875827	18-2755	988	956000	18-7194	993	3831426	18-3539	973
875828	18-2757	988	958303	18-15325	966	3840335	18-7709	961
875847	18-2774	973	958310	18-15390	966	3841697	18-3038	964
875848	18-2758	988	958311	18-15405	966	3841697	18-3077	964
876037	18-5704	955	958314	18-15435	966	3841697	18-30777	S/S to 18-3077
876038	18-6271	955	958320	18-15495	966	3842343	18-9410-2	189
876039	18-5705	955	958357	18-15415	966	3842344	18-9410-4	189
876040	18-6266	955	958498	18-4046	976	3843751	18-7705	962
876069	18-57702	183, 977	958838	18-2043	993	3847501	18-1986-1	969
876097	18-3656	974	958860	18-2047	993	3847547	18-9096	988
876120	18-3287	964	966382	18-15435	966	3847644	18-8149	138, 961
876185	18-7890	977	966857	18-4046	976	3850216	18-5811	954
876267	18-8358	993	975672	18-7181	975, 993	3850357	18-7677	878
876268	18-8359	993	984513	18-6028	991	3850379	18-1238	971
876278	18-4204	989	985316	18-1401	979	3850379	18-4408	971
876279	18-2366	989	985727	18-21753	987	3850396	18-7684	962
876294	18-2744	988	986280	18-6779	956	3850426	18-1074	988
876300	18-2998	982	988037	18-7330	150, 958	3850495	18-2875-1	971
876302	18-2813	981	1141679	18-9680-2	196	3850495	18-2875-1-9	900
876303	18-3870	981	1141681	18-9680-5	196	3850496	18-0943-2	970
876305	18-3662	974	1141682	18-9680-7	196	3850496	18-0943-2-9	970
876306	18-2814	981	1218630	18-4472	976	3850559	18-7876-1	183
876314	18-0252	981	1218674	18-1478	976	3850594	18-2586	992
876342	18-2983	982	1243632	18-5357	940	3850595	18-0893	986
876356	18-2980	982	1266286	18-7878-1	183, 977	3850597	18-2791	993
876358	18-2982	982	1266796	18-2930	984	3850809	18-7326	150, 958
876359	18-2817	982	1306169	18-5305	939	3850810	18-7331	150, 958
876376	18-4342	981	1306630	18-4031	980	3850812	18-2174	989
876380	18-4341	981	1317466	18-2933	984	3850813	18-2128	989
876384	18-0489	981	1336255	18-2530	986	3850814	18-2337	989
876433	18-2818	982	1357199	18-6839	952	3850815	18-2146	989
876631	18-2758	988	1378645	18-2968	982	3850861	18-7778	138, 960
876633	18-2757	988	1378646	18-2970	982	3850984	18-3708-1	990

Volvo (Cont.)			Volvo (Cont.)			Volvo (Cont.)		
O.E. #	SIERRA #	PAGE #	O.E. #	SIERRA #	PAGE #	O.E. #	SIERRA #	PAGE #
3852005	18-3722	990	3853850	18-3599-1	S/S to 18-3599-2	3857650	18-7330	150, 958
3852023	18-1501	990	3853850	18-3599-2	963	3857656	18-1848	969
3852033	18-7168	993	3853912	18-0410	982	3857723	18-1986-1	969
3852044	18-7162	993	3853913	18-0410	982	3857747	18-6275	951
3852045	18-7116	993	3853945	18-6779	956	3857813	18-6265	952
3852073	18-7102	993	3853960	18-3937	979	3857985	18-7331	150, 958
3852089	18-7135	993	3853982	18-5913	951	3857986	18-7326	150, 958
3852095	18-0889	984	3853983	18-3676	974	3858061	18-9410-7	189
3852096	18-0164	984	3854001	18-5108	941	3858071	18-6817	955
3852109	18-0874	987	3854002	18-5443	941	3858081	18-5700	955
3852113	18-0876	984	3854003	18-5107-1	941	3858256	18-3081	965
3852120	18-0929	974	3854017	18-3575	S/S to 18-3593	3858261	18-7326	150, 958
3852127	18-2858	984	3854017	18-3593	963	3858340	18-3593	963
3852165	18-7141	993	3854018	18-36905	957	3858462	18-15450	966
3852169	18-7143	350, 933	3854020	18-7238	957	3858714	18-7331	150, 958
3852170	18-8020	963	3854026	18-7229	958	3858809	18-5700	955
3852171	18-8200	963	3854033	18-1402	979	3858941	18-7685	962
3852172	18-8202	963	3854095	18-1231	984	3858979	18-7706	941
3852215	18-5894	19, 887, 962	3854105	18-7242	957	3859054	18-5811	954
3852255	18-3744	990	3854106	18-7244	957	3859078	18-7493	941
3852315	18-32882	993	3854107	18-7245	957	3859082	18-7643	941
3852350	18-4194	990	3854116	18-7246	957	3860082	18-5979	952
3852384	18-2339	989	3854127	18-2765	988	3860566	18-6275	951
3852413	18-7789	138, 960	3854130	18-6125Z	991	3860764	18-5913	951
3852413	18-7989	138, 960	3854158	18-7601	962	3860769	18-5957	952
3852455	18-0183-1	643, 984	3854161	18-7492	941	3860879	18-6806	955
3852464	18-15455	966	3854164	18-69550	954	3861267	18-7648	941
3852468	18-2902-1	972	3854190	18-5920	951	3861575	18-6804	955
3852468	18-2902-1-9	972	3854202	18-3869	983	3862014	18-5405	940
3852476	18-0549	990	3854215	18-29322	940	3862228	18-7989	138, 960
3852477	18-0891	985	3854217	18-29322	940	3862281	18-3081	965
3852523	18-7406	993	3854217	18-5248	940	3862281	18-3277	964
3852529	18-8021	963	3854218	18-5413	940	3862500	18-7513	19, 962
3852531	18-7407	993	3854252	18-3939	979	3862567	18-3276-1	964
3852544	18-2138	990	3854261	18-5406	940	3862612	18-6848	953
3852560	18-2996	987	3854269	18-0868	982	3862613	18-6845	953
3852604	18-710-48-2	988	3854280	18-7330	150, 958	3862613	18-6847	953
3852654	18-0468	986	3854286	18-3046	964	3862665	18-6845	953
3852655	18-0405	985	3854286	18-3060	964	3863061	18-1909-1	970
3852656	18-0322	987	3854299	18-3879	983	3863061	18-1909-1	970
3852657	18-0519	980	3854311	18-5408	940	3863085	18-25250	986
3852687	18-0664	985	3854331	18-5362	940	3863130	18-7642	941
3852691	18-0887	986	3854406	18-0410	982	3863193	18-6028A	991
3852692	18-2815	984	3854512	18-7703	962	3863450	18-2780-1	963
3852693	18-0347	985	3854527	18-7702	962	3863450	18-2780-1	963
3852696	18-2779	963	3854539	18-2454	990	3884950	18-5882	952
3852741	18-2780-1	963	3854548	18-5354	940	3884950	18-6845	953
3852742	18-2781	963	3854549	18-5405	940	3885317	18-5913	951
3852805	18-0528	980	3854620	18-7326	150, 958	3888813	18-6127A	991
3852818	18-0352	985	3854751	18-5913	951	3888814	18-6127Z	991
3852824	18-0147	986	3854905	18-7679	962	3888815	18-6127M	991
3853132	18-0518	980	3854942	18-0311	985	3888816	18-6126A	991
3853226	18-4024	980	3854956	18-0518	980	3888817	18-6126Z	991
3853268	18-3937	979	3855017	18-7241	957	3888818	18-6126M	991
3853336	18-2946	982	3855104	18-7792	961	3888821	18-2583	993
3853340	18-4161	979	3855182	18-7689	962	3888822	18-2584	993
3853341	18-1213	980	3855194	18-7704	962	3888916	18-1076	992
3853342	18-0327	985	3855275	18-2598	992	3888917	18-2726	992
3853343	18-1239	985	3855276	18-7268	149, 958	3911020	18-4173	979
3853361	18-0903	985	3855296	18-7757	941	3911023	18-4164	979
3853412	18-2909	970	3855411	18-6028	991	4785974	18-7926	182, 673
3853477	18-4160	979	3855412	18-6102	991	5001677	18-6846	661, 953
3853510	18-1232	985	3855610	18-6125M	991	5003564	18-6839	952
3853511	18-3887	983	3855958	18-7330	150, 958	6209190	18-6956	952
3853512	18-0468	986	3855991	18-3577-1	S/S to 18-3577-2	6643474	18-6271	955
3853528	18-1234	980	3855991	18-3577-2	963	8602629	18-6953	661
3853587	18-3873	983	3856003	18-5919	951	8602710	18-6953	661
3853732	18-3883	983	3856004	18-5913	951	8602714	18-6953	661
3853742	18-0183-1	643, 984	3856127	18-1400	979	8676496	18-6953	661
3853787	18-5897	962	3856138	18-1237	985	8676498	18-6953	661
3853796	18-3584	963	3856393	18-7641	956	8676499	18-6953	661
3853799	18-3558	973	3856884	18-33800	962	8692305	18-8003	184, 977
3853801	18-5403	939	3856961	18-3677	974	8757166	18-8802-1	171-181, 944
3853804	18-8964	976	3857265	18-6274	956	8757166	18-8823-1	171-181, 944
3853807	18-2100	989	3857487	18-7700	962	21124846	18-3506	963
3853815	18-5352	940	3857489	18-6806	955	21148403	18-3557	973
3853827	18-1230	980	3857532	18-5899	962	21213660	18-3276-1	964
3853847	18-1401	979	3857561	18-6261	952	21213664	18-30778	964

Yamaha (Cont.)			Yamaha (Cont.)			Yamaha (Cont.)		
O.E. #	SIERRA #	PAGE #	O.E. #	SIERRA #	PAGE #	O.E. #	SIERRA #	PAGE #
64E-43869-00-00	18-7469	550	66M-45115-00	18-99079	526	67F-82341-00-00	18-5217-1	474
64E-43880-00-00	18-6783	482	66M-46241-00-00	18-15137	517	67F-82344-00-00	18-8847-1	474
64E-43880-01-00	18-6783	482	66M-81800-01-00	18-6943	478	67F-82342-00-00	18-5218-1	474
64J-41133-10	18-99008	524	66M-81800-02-00	18-6943	478	67F-82341-00-00 +		
64X-81800-00-00	18-6862	551	66M-85520-00-00	18-25600	474	67F-82342-00-00 +		
64X-81800-00-00	18-6906	551	66M-85533-00-00	18-25602	Obsolete	67F-82343-00-00 +		
650-11651-04-00	18-1755	516	66M-85540-01-00	18-25300	474	67F-82344-00-00	18-8847-1	474
650-11651-04-00	18-1755K	516	66M-85570-00-00	18-23601	473	67F-82343-00-00	18-5219-1	474
650-24431-00	18-0849	523	66M-85580-00-00	18-25650	474	67F-82344-00-00	18-5220-1	474
650-24431-A0-00	18-0849	523	66M-W0093-00-00	18-7738	483	67F-W0001-20-00	18-74535	549
655-12414-A1-00	18-0232	530	66M-W0093-01-00	18-7738	483	67F-W0078-00	18-3409	502
65E-85570-00-00	18-5119	474	66T-11181-A0-00	18-60522	531	67F-W0078-00-00	18-3451	502
65L-13645-00	18-99066	526	66T-11193-A0-00	18-60520	531	67F-W0093-00-00	18-7443	483
65L-13646-00	18-99067	526	66T-14301-00-00	18-34605	484	67H-8592A-00-00	18-7655	494
65L-13915-00-00	18-79901	492	66T-15713-00-00	18-51003	532	67H-8592A-01-00	18-7655	494
65L-14984-00	18-0715	486	66T-41114-A0-00	18-60532	531	680-85570-00-00	18-5138	474
65L-24564-00-00	18-7487	491	66T-41133-A0-00	18-60529	531	680-85570-02-00	18-5138	474
65L-W0001-C0-00	18-74510	549	66T-44311-00	18-3413	501	680-85570-09-00	18-5112	473
65N-44315-A0	18-0453	505	66T-44323-00-00	18-3196	501	682-11351-A0	18-99095	527
65N-44323-00	18-0408	505	66T-45113-A0-00	18-60528	531	682-11610-01-00	18-3976	515
65N-W0078-A0-00	18-4533	505	66T-W0078-00	18-3413	501	682-11610-11-00	18-3977	515
65W-11169-00	18-99068	526	66T-W0078-00-00	18-3440	501	682-12414-A1-00	18-0836	530
65W-11181-30-00	18-63968	531	66V-81960-00-00	18-6651	552	682-41112-A1	18-99096	527
65W-11351-00	18-99069	526	670-45997-02-00	18-73914	533	682-41133-A0	18-99021	524
65W-11356-00	18-99070	526	676-11181-A0-00	18-3892	521	682-44315-A0-00	18-0768	532
65W-13645-00-00	18-60535	531	676-11181-A1-00	18-3892	521	682-44352-01-00	18-3074	495
65W-14198-00-00	18-76689	550	676-12414-A0-00	18-60540	531	682-44365-00	18-1834	498
65W-14457-10	18-99071	526	676-13646-A0	18-99080	526	682-44366-00	18-1831	498
65W-14901-12-00	18-34602	Obsolete	676-14984-00-00	18-0840-1	529	682-44367-00	18-1832	498
65W-24251-10-00	18-7830	491	676-14985-01-00	18-7392	485	682-45113-A1	18-99022	524
65W-41114-00	18-99072	526	676-41112-A0	18-99081	526	682-82556-00-00	MP28860	30, 475
65W-41114-01-00	18-60531	531	676-41133-A0	18-99014	524	682-W0001-06	18-99097	518
65W-43865-00-00	18-7470	550	676-44315-A1	18-99082	526	682-W0078-A1-00	18-3148	498
65W-43871-00-00	18-7484	482	676-44324-A0	18-99083	526	682-W0078-A1-00	18-3411	498
65W-46241-00-00	18-15135	517	676-45114-A0	18-99015	524	683-45315-A0	18-99152	529
65W-81941-00-00	18-5819	477	676-45127-00	18-99084	526	683-W0001-C1-00	18-74501	549
65W-85570-01-00	18-23205	473	676-45128-00	18-99085	526	688-11181-02-00	18-3805	521
65W-85580-00-00	18-25651	Obsolete	677-14198-A1	18-99145	528	688-11181-A1-00	18-3805	521
65W-W0001-20	18-99073	518	677-14384-01	18-99146	486	688-11193-01-00	18-0767	530
662-44352-01-00	18-3063	495	677-24411-02-00	18-7837	488	688-11603-A0-00	18-3969	515
663-13622-00-00	18-0242	525	677-24471-01-00	18-7838	488	688-11650-03-00	18-1756	516
663-13622-A0-00	18-0242	525	677-W0093-00-00	18-7059	482	688-12414-A1-00	18-0844	530
663-24410-00-00	18-7334	487	677-W0093-04-00	18-7059	482	688-13621-A1	18-99098	527
663-24411-00-00	18-7840	488	679-44316-A0	18-99086	526	688-41112-A0-00	18-0847	530
663-44311-02	18-3408	500	679-45315-A0	18-99087	526	688-41114-A0	18-99148	528
663-44315-A0-00	18-0292	531	679-W0078-00-00	18-3397	500	688-41133-00	18-99023	524
663-44316-A0	18-99149	529	679-W0078-A0-00	18-3397	500	688-41134-A0	18-99024	524
663-44322-00-00	18-3435	500, 502, 503	67C-11356-00	18-99088	526	688-43880-11-00	18-6821	482
663-44323-00-00	18-3436	500, 503	67C-41114-00	18-99089	527	688-44311-01-00	18-3171	496
663-44324-A0-00	18-0294	531	67C-41133-00	18-99016	524	688-44315-A0-00	18-0239	530
663-44366-00	18-1828	497	67C-43880-00-00	18-6748	481	688-44316-A0-00	18-0240	531
663-44366-00	18-1830	498	67C-43880-01-00	18-6748	481	688-44352-03-00	18-3070	495
663-45123-00	18-99009	524	67C-45113-00	18-99091	527	688-45113-A0	18-99151	529
663-45331-00-94	18-2773	532	67C-45123-00	18-99017	524	688-45114-A1	18-99025	524
663-81840-11-00	18-56004	481	67C-W0001-00	18-99092	518	688-45123-00	18-99026	524
663-W0078-00-00	18-3425	503	67C-W0001-20	18-99093	518	688-45331-00-94	18-2782	532
663-W0078-A0-00	18-3425	503	67C-W0001-21-00	18-0020	546	688-45341-00-00	18-2374	532
664-41114-A0-00	18-0250	530	67D-14301-13-00	18-34601	484	688-45341-00-00	18-23741-9	532
664-41134-A0	18-99010	524	67D-15713-00-00	18-51002	532	688-45341-10-00	18-2374	532
664-45371-01-00	18-6096	533	67D-24410-03-00	18-35304	487	688-45341-10-00	18-23741-9	532
66K-13907-00-00	18-7341	487	67D-45113-A0-00	18-60527	531	688-45371-02-00	18-6070	533
66K-13915-00-00	18-79900	492	67D-W0093-00-00	18-7736	483	688-45371-02-00	18-6111	533
66K-14984-00	18-0711	485	67F-11181-02	18-99094	521	688-45611-00-00	18-2388	532
66K-W0001-20-00	18-74512	549	67F-12411-01-00	18-3632	510	688-45997-01-00	18-4274	532
66M-11181-10-00	18-63966	531	67F-14371-01	18-79972	491	688-81800-12-00	18-6423	478
66M-11351-10	18-99074	526	67F-1439A-00-00	18-7056	484	688-81941-00-00	18-5879	477
66M-11356-00	18-99075	526	67F-41133-A1	18-99018	524	688-81950-10-00	18-5879	477
66M-11357-00-00	18-60513	532	67F-41134-A0	18-99019	524	688-85540-16-00	18-5130	473
66M-12411-01-00	18-3541	510	67F-41138-00-00	18-0605	523	688-W0001-00-00	18-4415	520
66M-13329-10	18-99076	526	67F-43880-00-00	18-6787	481	688-W0001-20-00	18-2798	548
66M-13645-00-00	18-60534	531	67F-44311-01	18-3409	502	688-W0001-22-00	18-0021	546
66M-14301-00-00	18-34600	484	67F-44322-00-00	18-3162	502	688-W0001-A0-00	18-4415	520
66M-14301-12-00	18-34600	484	67F-44323-00-00	18-3143	502	688-W0001-C0-00	18-2798	548
66M-24410-10-00	18-35302	487	67F-44352-00-00	18-3042	495	689-11181-02-00	18-3804	521
66M-41114-01-00	18-60530	531	67F-45123-00	18-99020	524	689-11631-00-95	18-4130	515
66M-41133-00	18-99012	524	67F-45127-00-00	18-0617	523	689-15755-01-00	18-50000	481
66M-41138-00	18-99078	526	67F-46241-00-00	18-15131	517	689-44352-02-00	18-3067	495
66M-45113-00	18-99013	524	67F-81800-02-00	18-6425	478	689-45113-A1-00	18-0739	530

Yamaha (Cont.)			Yamaha (Cont.)			Yamaha (Cont.)		
O.E. #	SIERRA #	PAGE #	O.E. #	SIERRA #	PAGE #	O.E. #	SIERRA #	PAGE #
689-81311-40-00	18-5195	473	695-85570-10-00	18-5112	473	6C5-43880-01-00	18-6836	482
689-81800-11	18-6410	477	695-W0001-01-00	18-4417	520	6C5-46241-00-00	18-15130	517
689-81800-12	18-6410	477	695-W0001-02-00	18-4417	520	6CB-12411-10-00	18-3637	510
689-81800-13-00	18-6410	477	695-W0001-A2-00	18-4417	520	6CB-13016-00	18-0707	486
689-81840-11-00	18-56002	456	696-W0093-02-00	18-7290	483	6CB-13915-00	18-79978	493
689-W0001-21-00	18-2785	547	697-11181-A0-00	18-3848	521	6CB-14984-00	18-0716	486
689-W0001-23-00	18-0022	546	697-11181-A1-00	18-3848	521	6CB-24501-00	18-79979	492
689-W0001-A1-00	18-3804	521	697-44352-00-00	18-3069	500-503	6CB-81800-00-00	18-6961	478
689-W0001-C1-00	18-2785	547	697-45114-A0	18-99030	525	6CB-W0078-00-00	18-3474	504
689-W0001-C2-00	18-0023	546	697-81800-12	18-6412	477	6CB-W4624-00-00	18-15134	517
689-W0078-04-00	18-3426	503	697-85570-11-00	18-5111	473	6CE-12411-00-00	18-3524	510
689-W0078-A4-00	18-3426	503	698-W0001-20-00	18-2787	547	6CE-44311-01-00	18-3482	496
689-W0078-A6-00	18-3427	504	698-W0001-21-00	18-0024	546	6CE-44315-00-00	18-3458	502
689-W0093-02-00	18-7770	484	698-W0001-C0-00	18-2787	547	6CE-44323-01-00	18-3459	502
68D-11351-A0-00	18-60518	531	69G-W0001-20-00	18-0025	546	6CE-44352-00-00	18-45617-1	496
68D-E1169-A0-00	18-60512	531	69G-W0078-00	18-3475	504	6CE-W0078-01	18-3470	502
68D-E1193-A0-00	18-60519	531	69J-13440-00-00	18-7906-1	184, 517	6CE-W0078-01 +		
68D-E2414-A0-00	18-0754	530	69J-13440-01-00	18-7906-1	184, 517	6CE-44311-01	18-3471	502
68D-G4311-01-00	18-43263	496	69J-24501-00	18-79981	492	6CJ-44311-00-00	18-3485	496
68D-G5987-00-00	18-73891	533	69J-24501-10-00	18-79905	491	6CJ-44315-00	18-0448	505
68D-WG078-00-00	18-48619	504	69J-24502-00	18-79982	492	6CJ-44316-00	18-0449	505
68F-11181-00	18-99062	521	69J-41134-A0	18-99032	525	6CJ-44324-00	18-0450	505
68F-11193-01	18-99099	527	69J-41135-A0	18-99033	525	6CJ-W0078-00-00	18-3494	505
68F-11381-00	18-99100	527	69J-41136-A0	18-99034	525	6CV-44315-00	18-0451	505
68F-13440-00	18-79971	516	69J-41138-00-00	18-0619	523	6CV-44323-00	18-4572	504
68F-13907-00-00	18-7342	487	69J-43880-00-00	18-6798	481	6D3-81800-00-00	18-6907	551
68F-13907-01-00	18-7342	487	69J-45123-00-00	18-0656	523	6D8-WS24A-00-00	18-79799	491
68F-13915-00-00	18-79904	493	69J-46241-00-00	18-15141	517	6DA-12411-01-00	18-3636	510
68F-24563-00	18-79980	492	69J-81800-00-00	18-6833	478, 480	6DA-W4624-00-00	18-15142	517
68F-24563-10-00	18-7955	491	69L-45371-00-00	18-6122A	533	6E0-24411-00-00	18-7389	487
68F-41114-00	18-99101	527	69L-45371-00-00	18-6122Z	533	6E0-24471-00-00	18-7834	488
68F-45113-00	18-99102	527	69L-81800-00-00	18-6861	478	6E0-44352-00-00	18-3073	495
68F-46241-10-00	18-15145	517	69M-11181-00-00	18-60523	531	6E0-44366-00-00	18-3166	498
68F-81800-01-00	18-6426	478	69M-11196-A0-00	18-60521	531	6E0-W0001-C1-00	18-0028	547
68F-8592A-00-00	18-7656	494	69M-12411-01-00	18-3624	510	6E5-11181-02-00	18-3832	521
68F-W0001-01	18-99103	518	69M-14301-11-00	18-34604	484	6E5-11181-A1-00	18-3832	521
68F-W1135-00-00	18-64415	529	69M-G4323-00	18-0409	505	6E5-11193-A0-00	18-0781	530
68T-13475-00	18-99027	524	69M-G4328-00	18-9091	505	6E5-11381-A1-00	18-0782	530
68T-24251-00-00	18-7710-1	491	69M-WG078-00-00	18-4534	505	6E5-11610-03-00	18-3934	515
68T-44323-00-00	18-3142	501	69W-43880-00-00	18-6811	482	6E5-11610-23-00	18-3936	516
68T-44352-00-00	18-8910	496	69W-81800-00	18-6861	478	6E5-12411-02-00	18-3623	510
68T-44366-00-00	18-3176	498	69W-81800-00-00	18-6942	478	6E5-12411-30-00	18-3540	510
68T-46241-00-00	18-15138	517	6A0-24410-00-00	18-7334	487	6E5-13411-00	18-79975	516
68T-W0001-20-00	18-74544	549	6A0-24410-01-00	18-7334	487	6E5-13621-A1	18-99105	527
68T-W0078-00-00	18-3410	501	6A0-24410-02-00	18-7334	487	6E5-13645-A1-00	18-0823	530
68T-W0078-00-00	18-3450	501	6A0-24410-03-00	18-7334	487	6E5-14198-A1-00	18-0785	529
68V-11325-01-00	18-6118A	533	6A0-24410-04-00	18-7334	487	6E5-14384-02-00	18-0786	529
68V-13766-00-00	18-2083	482, 493	6A0-24410-05-00	18-7334	487	6E5-14384-03-00	18-2592	529
68V-13907-00-00	18-7340	487	6A0-W0001-21	18-99104	518	6E5-14385-00-00	18-7068	485
68V-13907-01-00	18-7340	487	6A1-W0001-22-00	18-0026	547	6E5-14385-01-00	18-7068	485
68V-13907-02-00	18-7340	487	6A1-W0001-23-00	18-0027	547	6E5-14385-02-00	18-7069	485
68V-13907-03-00	18-7340	487	6A1-W0078-01-00	18-3463	503, 507	6E5-14546-00-00	18-7055	484
68V-13915-00-00	18-79903	493	6A1-W0078-02-00	18-3462	503, 507	6E5-24305-05	18-80415	495
68V-14984-00	18-0710	485	6A1-W0093-01-00	18-7293	483	6E5-24410-00-00	18-7349	487
68V-15312-00	18-99028	524	6AH-44311-00-00	18-3484	496	6E5-24410-01-00	18-7349	487
68V-24502-00-00	18-79986	492	6AH-46241-00-00	18-15136	517	6E5-24410-02-00	18-7349	487
68V-24502-01-00	18-79986	492	6AH-W0078-00	18-3479	504	6E5-24410-03-00	18-7349	487
68V-24502-02	18-79986	492	6AW-12411-00-00	18-3634	510	6E5-24410-04-00	18-7349	487
68V-24502-20-00	18-79985	492	6AW-14984-00	18-0714	485	6E5-24410-10-00	18-7349	487
68V-24502-30	18-79985	492	6AW-24502-00-00	18-79984	492	6E5-24411-00-00	18-7843	487, 488
68V-24563-00-00	18-7979	491	6AW-24502-10	18-79984	492	6E5-24471-00-00	18-7842	487, 488
68V-44323-00-00	18-3521	501	6AW-44311-01-00	18-3483	496	6E5-41112-A1-00	18-0799	530
68V-45123-00-00	18-0618	523	6AW-44312-00-00	18-9082	497	6E5-41134-A0	18-99037	525
68V-81800-01-00	18-6427	478	6AW-44315-00	18-0452	504	6E5-41135-A0	18-99038	525
68V-W0001-20-00	18-74515	549	6AW-44322-00-00	18-3457	502	6E5-43880-01-00	18-6821	482
68V-W0078-00	18-3523-1	501	6AW-44323-00	18-0421	504	6E5-43880-02-00	18-6821	482
68V-W0078-00-00	18-3442	501	6AW-44336-00	18-3028	504	6E5-44311-00-00	18-3170	496
692-14590-00-00	18-7060	485	6AW-44352-00-00	18-8925	496	6E5-44312-00-00	18-9081	497
692-14590-01-00	18-7060	485	6AW-44365-00-00	18-1829	497	6E5-44315-A0-00	18-0244	531
692-24410-00-00	18-7334	487	6AW-W0078-00-00	18-3477	504	6E5-44323-00-00	18-3344	499
692-24411-00-00	18-7391	487	6AW-W4624-00-00	18-15139	517	6E5-44352-01-00	18-3071	495
692-W0078-00-00	18-3370	499	6BG-13915-00	18-79970	491	6E5-44365-00-00	18-1835	498
692-W0078-01-00	18-3370	499	6BG-W0078-00-00	18-3490	505	6E5-45371-01-00	18-6097	533
692-W0078-A0-00	18-3370	499	6BX-G4315-01-00	18-60541	531	6E5-45611-01-00	18-2385	532
692-W0078-A0-00	18-3371	499	6C5-13915-00	18-79973	491, 493	6E5-81800-11-00	18-6413	478
695-11181-A0-00	18-3849	521	6C5-14984-00	18-0717	486	6E5-81800-12-00	18-6413	478
695-11181-A1-00	18-3849	521	6C5-24251-00	18-79983	492	6E5-81840-10-00	18-56005	481
695-85540-12-00	18-5131	473	6C5-43880-00-00	18-6836	482	6E5-81941-10-00	18-5853	477

Yamaha (Cont.)			Yamaha (Cont.)			Yamaha (Cont.)		
O.E. #	SIERRA #	PAGE #	O.E. #	SIERRA #	PAGE #	O.E. #	SIERRA #	PAGE #
6E5-81941-11-00	18-5853	477	6G1-45315-A0	18-99116	527	6H3-45123-00	18-99047	525
6E5-85540-10-00	18-5135	474	6G1-81941-10-00	18-5821	477	6H3-81800-10	18-6411	477
6E5-85540-11-00	18-5135	474	6G1-W0001-A2	18-99117	518	6H3-81800-11-00	18-6411	477
6E5-85540-12-00	18-5135	474	6G1-W0001-C1-00	18-0029	547	6H3-85510-A1	18-5746	477
6E5-85570-11-00	18-5110	473	6G1-W0078-01-00	18-3460	503	6H3-W0001-02	18-99176	520
6E5-W0001-51-00	18-2794-1	548	6G1-W0078-A1-00	18-3460	503	6H3-W0001-21-00	18-2788	548
6E5-W0001-F1-00	18-2794-1	548	6G1-W0093-00-00	18-7765	483	6H3-W0001-22-00	18-74504	549
6E5-W0078-01-00	18-3372	499	6G5-11181-00-00	18-3894	521	6H3-W0001-A0-00	18-4427	520
6E5-W0078-A1-00	18-3373	499	6G5-11181-A0-00	18-3894	521	6H3-W0001-C1-00	18-2788	548
6E5-W0093-06-00	18-7002	483	6G5-11193-A0-00	18-0779	530	6H3-W0078-00-00	18-3428-1	500
6E7-11181-00-00	18-3828	521	6G5-11382-A1-00	18-0808	529	6H3-W0078-00-00	18-3461	500, 506, 508
6E7-11181-A1-00	18-3828	521	6G5-11631-00-93	18-4129	515	6H3-W0078-01	18-3466	502
6E7-11631-00-97	18-4135	515	6G5-11636-00-00	18-4133	515	6H3-W0078-01-00	18-3464	S/S to 18-3465
6E7-14227-00	18-99144	528	6G5-11642-00-93	18-4128	515	6H3-W0078-02-00	18-3465	502
6E7-14385-00-00	18-7393	485	6G5-13645-A1-00	18-0809	529	6H3-W0078-02-00	18-3466	502
6E7-14390-12-00	18-7073	485	6G5-14483-A1	18-99118	527	6H3-W0078-A0-00	18-3428-1	500
6E7-85570-10-00	18-5112	473	6G5-41112-A1-00	18-0812	530	6H3-W0078-A0-00	18-3461	500, 506, 508
6E7-85570-19-00	18-5112	473	6G5-41134-A1	18-99039	525	6H3-W0093-02-00	18-7760	484
6E7-W0093-04-00	18-7769	484	6G5-43864-00-00	18-7468	550	6H4-11181-00-00	18-3830	521
6E8-14380-12-00	18-7073	485	6G5-43880-02-00	18-6760	481	6H4-11181-A1-00	18-3830	521
6E9-11193-A0	18-99106	527	6G5-44323-00-00	18-3345	498	6H4-11193-A1-00	18-0815	530
6E9-12414-A1	18-99142	528	6G5-45113-A0-00	18-0813	530	6H4-11610-00-00	18-3960	515
6E9-41114-A0	18-99107	527	6G5-45114-A1	18-99040	525	6H4-11610-10-00	18-3961	515
6E9-82575-02-00	18-65450	30, 475	6G5-45251-01-00	18-6090	533	6H4-11610-20-00	18-3962	515
6E9-W0093-02-00	18-7740	483	6G5-W0001-03-00	18-4404	519	6H4-11631-00-96	18-4141	515
6E9-W0093-03-00	18-7741	483	6G5-W0001-21-00	18-2794-1	548	6H4-11635-01-00	18-4142	515
6EE-G4311-00	18-4567	504	6G5-W0001-A3-00	18-4404	519	6H4-11636-00-00	18-4143	515
6EE-G4322-00	18-4546	504	6G5-W0001-C1-00	18-2794-1	548	6H4-13621-A1	18-99132	528
6EE-G4323-00	18-4573	504	6G5-W0078-01-00	18-3310	498	6H4-14198-01	18-99133	528
6EE-G4366-00	18-1840	504	6G5-W0078-A1-00	18-3311	498	6H4-15369-A1	18-99134	528
6EE-W0078-00-00	18-3473	504	6G5-W0093-08-00	18-7747	483	6H4-41112-A0	18-99135	528
6EG-G4322-00	18-4547	505	6G5-W4599-00-00	18-3782	534	6H4-41114-A0-00	18-0798	530
6EG-G4315-00	18-99157	505	6G8-11181-00-00	18-3827	521	6H4-44352-02-00	18-3068	495
6EG-G4323-00	18-4574	505	6G8-11181-A1-00	18-3827	521	6H4-81800-12-00	18-6422	478
6EG-G4328-00	18-9089	505	6G8-11351-A0	18-99119	527	6H4-W0001-01-00	18-4407	519
6EG-W0078-00-00	18-4532	505	6G8-12414-A0	18-99120	527	6H4-W0001-02-00	18-4419	520
6EK-12411-00-00	18-3639	510	6G8-13440-00-00	18-7901	183, 517	6H4-W0001-03-00	18-4409	522
6F3-W0001-04-00	18-4403	519	6G8-13646-A0	18-99121	528	6H4-W0001-04-00	18-4409	522
6F3-W0001-21-00	18-2794-1	548	6G8-14198-A0	18-99122	528	6H4-W0001-20-00	18-2792	548
6F3-W0001-A4-00	18-4403	519	6G8-15374-00	18-99123	528	6H4-W0001-21-00	18-2792	548
6F3-W0001-C1-00	18-2794-1	548	6G8-45113-A1	18-99045	525	6H4-W0001-A1-00	18-4407	519
6F5-12411-03-00	18-3625	510	6G8-46241-00-00	18-15133	517	6H4-W0001-A2-00	18-4419	520
6F5-24563-00-00	18-7780	491	6G9-W0001-C6-00	18-74527	549	6H4-W0078-00	18-3408	500
6F5-44352-00-00	18-3088	495	6GD-G4325-00-00	18-1079	532	6H4-W0078-00-00	18-3429	500
6F5-81800-11	18-6421	478	6H0-W0093-00-00	18-7742	483	6H4-W0078-A0	18-3408	500
6F5-85540-21-00	18-5136	474	6H1-11631-03-95	18-4097	515	6H4-W0078-A0-00	18-3429	500
6F5-85540-22-00	18-5136	474	6H1-11636-03-00	18-4099	515	6H4-W0093-01-00	18-7767	484
6F5-W0078-00-00	18-3374	S/S to 18-3397	6H1-13411-00	18-79961	516	6H4-W0093-03-00	18-7768	484
6F5-W0078-00-00	18-3374	S/S to 18-3397	6H1-43880-00-00	18-6259	481	6H4-W4599-00-00	18-73990	533
6F5-W0078-00-00	18-3398	500	6H1-43880-02-00	18-6781	481	6H5-43880-02-00	18-6788	481
6F5-W0078-A0-00	18-3374	S/S to 18-3397	6H1-45251-02-00	18-6091	533	6J4-81800-01-00	18-6421	478
6F5-W0078-A0-00	18-3374	S/S to 18-3397	6H1-W0001-00-00	18-4405	519	6J8-11181-00-00	18-3829	521
6F5-W0078-A0-00	18-3398	500	6H1-W0001-01-00	18-4405	519	6J8-11181-A1-00	18-3829	521
6FM-44323-01	18-4576	505	6H1-W0001-A0-00	18-4405	519	6J8-12414-A0-00	18-0829	530
6FM-W0078-00-00	18-4527	505	6H1-W0093-01-00	18-7291	483	6J8-13411-00	18-79974	516
6FP-12411-00-00	18-3641	510	6H1-W4599-00-00	18-3781	534	6J8-14546-00-00	18-7055	484
6G1-11193-A1	18-99108	527	6H2-14591-00-00	18-7056	484	6J8-24471-00-00	18-7841	488
6G1-13621-A1	18-99109	527	6H2-81960-00-00	18-6858	552	6J8-81960-00-00	18-17301	477
6G1-13645-A1	18-99110	527	6H3-11181-01-00	18-3831	521	6J8-W0001-21-00	18-2789	548
6G1-14198-A1	18-99111	527	6H3-11181-A1-00	18-3831	521	6J8-W0001-C2-00	18-2789	548
6G1-14546-00-00	18-7054	484	6H3-11193-A1	18-99141	528	6J8-W0078-A1-00	18-3430	503
6G1-14546-01-00	18-7054	484	6H3-11631-01-96	18-4091	515	6J9-45371-01-00	18-6035	533
6G1-14985-00-00	18-7067	485	6H3-11636-01-00	18-4093	515	6J9-45371-01-00	18-6112	533
6G1-15755-00-00	18-50001	481	6H3-12411-11-00	18-3622	510	6K1-45371-00-00	18-6034	533
6G1-15779-00-00	18-50000	481	6H3-12414-A1	18-99124	528	6K1-45371-02-00	18-6121A	533
6G1-15779-00-00	18-50001	481	6H3-13621-A1	18-99143	528	6K1-45371-02-00	18-6121Z	533
6G1-24305-04	18-80414	495	6H3-13622-00	18-99125	528	6K1-82510-06-00	MP51050	23, 475
6G1-24305-05-00	18-80414	495	6H3-14198-01	18-99126	528	6K1-82510-06-00	MP51052	23, 475
6G1-24411-00-00	18-7388	487	6H3-14590-00-00	18-7056	484	6K5-11601-02-00	18-3963	515
6G1-24431-01	18-99147	528	6H3-14590-01-00	18-7056	484	6K5-11636-03-00	18-4096	515
6G1-24471-00-00	18-7833	488	6H3-41112-A0	18-99128	528	6K7-13645-A1-00	18-0807-1	529
6G1-41112-A1	18-99112	527	6H3-41114-A0	18-99129	528	6K7-13686-A1	18-99136	528
6G1-41114-A0	18-99113	527	6H3-44311-00	18-3466	502	6K7-W0093-09-00	18-7759	483
6G1-41133-A0	18-99114	527	6H3-44315-A0-00	18-0756-1	531	6K8-81960-A0-00	18-6652	552
6G1-44315-A0-00	18-0753	530	6H3-44324-A0-00	18-0757	532	6L2-11181-A1-00	18-3847	521
6G1-44322-00-00	18-3456	503	6H3-44352-00-00	18-3069	500-503	6L2-11181-A2-00	18-3847	521
6G1-44352-00-00	18-3066	495	6H3-45113-A0	18-99130	528	6L2-14384-00-00	18-0765	529
6G1-45113-A1	18-99115	527	6H3-45114-A1	18-99046	525	6L2-14385-00-00	18-7063	485

Yamaha (Cont.)			Yamaha (Cont.)			Yamaha (Cont.)		
O.E. #	SIERRA #	PAGE #	O.E. #	SIERRA #	PAGE #	O.E. #	SIERRA #	PAGE #
6L2-14392-00-00	18-7049	484	90280-03M03-00	18-3297	497	97095-06040-00	18-2607	497
6L2-41112-A1-00	18-0743	530	90280-04M00-00	18-3300	497	97095-08045-00	18-0256	497
6L2-41114-A1-00	18-0744	530	90280-04M04-00	18-3301	497	97595-06535	18-8406	505
6L2-41133-A2	18-99137	528	90280-04M05-00	18-3302	497	97595-06540	18-8407	505
6L2-44311-01-00	18-3486	496	90340-08002-00	18-2371	532	99999-03249-00	18-6412	477
6L2-44322-00	18-4548	497	90340-08002-00	18-2371-9	532	ABA-FBARB-90-DG	18-8040	494
6L2-44328-00	18-9092	505	90340-08M04-00	18-2371	532	ABA-FLINE-BA-RB	18-8055	494
6L2-44352-00-00	18-3065	495	90340-08M04-00	18-2371-9	532	ABB-FUELF-IL-TR	18-7845	136, 490
6L2-44367-00	18-1836	497	90430-08020-00	18-4698	532, 995	ABB-FUELF-IL-TR	18-7945	136, 490
6L2-44367-10	18-1837	497	90430-08020-00	18-4698-9	532, 995	ABB-SPRTR-HD-SS	18-7777-1	136, 489
6L2-45315-A0	18-99138	528	90430-14115-00	18-0826	532	LUB-20W40-FC-12	18-9450-2	186
6L2-45987-01-00	18-73979	533	90430-14228-00	18-0755	523	LUB-2STRK-M1-4	18-9530-3	186
6L2-81800-20-00	18-6420	478	904-30142-28-00	18-0755	523	LUB-2STRK-M1-55	18-9530-7	186
6L2-W0001-01-00	18-4422	520	90430-14M09-00	18-0755	523	LUB-MRNLG-KT-10	18-9393	198, 517
6L2-W0001-02-00	18-4422	520	90790-74001-00	22423	Obsolete	LUB-MRNMD-KT-10	18-9391	197, 517
6L2-W0001-A2-00	18-4422	520	91401-30028-00	18-2380	533	LUB-MRNMR-KT-10	18-9392	198, 517
6L2-W0001-C3-00	18-0030	547	91401-30030-00	18-2380	533	LUB-MRNSM-KT-10	18-9390	197, 517
6L2-W0078-00-00	18-3431	503	91402-30022-00	18-2380	533	MAR-10171-00-10	18-7924	137, 490
6L2-W0093-00-00	18-7739	483	91402-30022-09	18-2380	533	MAR-10171-30-00	18-7606	494
6L5-24251-00	18-79977	492	91402-30028-00	18-2380	533	MAR-24563-00-00	18-7919	137, 490
6L5-44322-00-00	18-3164	505	91402-30028-09	18-2380	533	MAR-FLTHD-AL-12	18-7853-1	136, 489
6L5-44323-00-00	18-3163	507	91490-25030-00	18-73893	533	MAR-FLTHD-SS-12	18-7777	136, 489
6L5-44352-00-00	18-8911	496	91490-30030-00	18-2380	533	MAR-FUELF-IL-TR	18-7866	136, 490, 647
6L5-45616-00-00	18-73892	534	91490-30045-00	18-3748	533	MAR-MINIF-IL-TR	18-7865	138, 490
6M6-81800-10-00	18-6862	551	91490-40030-00	18-3735	533	MAR-MINIF-LT-AS	18-7965-1	138, 490
6M6-8183E00-00	18-15080	552	92900-10600-00	18-0192	516	MAR-SEPAR-AT-OR	18-7852-1	136, 489
6M6-81960-A0-00	18-6650	552	92901-10600-00	18-0192	516	MAR-SEPAR-AT-OR	18-7966-1	136, 489
6N0-W0001-C0-00	18-0031	547	92902-10600-00	18-0192	516	MAR-SPRTR-HD-SS	18-7984-1	136, 489
6N0-W0078-A0-00	18-3460	503	92903-10600-00	18-0192	516	N26-13440-00-00	18-7954	184, 516, 517
6N6-W0001-03-00	18-4411	519	92990-06600-00	18-0191	516	N26-13440-02-00	18-7954	184, 516, 517
6N6-W001-A3-00	18-4411	519	92990-10600-00	18-0192	516	YB-6AW04-1	18-9133-9	202, 495
6N6-W0078-00-00	18-3312	499	92995-10600-00	18-0192	516	YB-6AW04-3	18-9146-9	202, 495
6N6-W0078-01-00	18-3313-1	499	93101-20M07-00	18-0554	550	YB-6AW04-A	18-9145	202, 495
6N6-W0093-02-00	18-7744	483	93101-22067-00	18-0296	550	YB-ACC04	18-79815	205
6N7-81800-10-00	18-6415	478	93101-22M15-00	18-2079	550	YSC-10231-20-0C	18-7824-2	183
6N7-81840-00-00	18-56006	481	93101-23070-00	18-0297	550	YSC-10260-00-0C	18-15111	995
6OV-13646-00	18-99139	528	93101-25M03-00	18-0587	550	YSC-10260-10-0C	18-15110	995
6P2-14984-00	18-0713	485	93101-28M16-00	18-0265	550	YSC-12190-00-AC	18-2909	995
6P2-44323-00-00	18-3518	503	93101-30M17-00	18-0266	550	YSC-13080-00-0C	18-0164	995
6P2-46241-02-00	18-15132	517	93102-23096-00	18-0570	550	YSC-13231-20-0C	18-7824-2	995
6P2-W0078-00-00	18-3515	503	93102-25M28-00	18-0588	550	YSC-13260-60-0C	18-15106	995
6P3-24564-00-00	18-7488	491	93102-35M13-00	18-2085	550	YSC-13260-70-0C	18-15107	Obsolete
6P3-WS24A-00-00	18-79809	491	93102-40M36-00	18-2087	550	YSC-14231-20-0C	18-7876-1	183
6R3-85570-01-00	18-5128	473	93104-22M07-00	18-2091	550	YSC-16231-20-0C	18-7875	183, 995
6R3-W0001-03-00	18-4412	519	93106-09014-00	18-0267	550	YSC-22260-00-0C	18-15109	995
6R3-W0001-A3-00	18-4412	519	93210-05001	18-71330	505	YSC-22260-10-0C	18-15108	Obsolete
6R5-11603-00	18-39320	515	93210-16716-00	18-7511-9	550	YSG-10108-43-8G	18-0876	995
6R5-11631-11-93	18-4081	515	93210-19123-00	18-7463	550	YSG-10108-44-5G	18-0874	995
6R5-11635-11-00	18-4083	515	93210-24M79	18-76694	550	YSG-10114-14-1G	18-0889	995
6R5-11636-11-00	18-4085	515	93210-27ME3-00	18-76691	550	YSG-14090-90-8G	18-0905	995
6R5-11642-11-93	18-4080	515	93210-31MJ5-00	18-76693	550	YSG-14096-15-6G	18-0887	995
6R5-11645-11-00	18-4082	515	93210-32738-00	18-7432	550	YSG-37545-87-0G	18-0891	995
6R5-11646-11-00	18-4084	515	93210-33M85-00	18-7119	550	YSG-38600-39-G0	18-0903	995
6R5-11650-10-00	18-4157	516	93210-37M67-00	18-7483	550			
6R6-W0001-01-00	18-4413	520	93210-41042-00	18-0298	550			
6S5-81800-00-00	18-6909	552	93210-44704	18-71331	504	YANMAR		
6Y1-24305-04	18-80413	495	93210-45161	18-71332	505	104211-42070	18-3079	556
6Y2-24305-05	18-80415	495	93210-46044-00	18-7436	550	104211-42071	18-8952	671
6YL-24306-60-00	18-8017EP-2	144, 494	93210-46M16-00	18-76690	550	104211-49160	18-56601	671
6YL-24306-60-00	18-8017S-1	148, 494	93210-49046	18-71333	504	104211-77010	18-6930	662
703-82510-12-00	MP51020	23, 475	93210-54M54-00	18-7439-9	550	104211-77011	18-6930	662
703-82510-12-00	MP51022	23, 475	93210-59MG7	18-71334	505	104500-55710	18-79960	139, 670
703-82510-43-00	MP51040	23, 475	93210-66M98-00	18-0299	550	114361-77011	18-6936	662
703-82510-43-00	MP51042	23, 475	93210-74M35-00	18-7442	550	114362-77010	18-6936	662
90105-10M00-00	18-6246	533	93210-75M51-00	18-76692	550	114362-77011	18-6936	662
90119-08M13-00	18-2606	497	93210-86M38-00	18-7485	550	114399-77010	18-6936	662
90119-08M15-00	18-8400-9	497	93210-94003-00	18-7471	550	119209-77010	18-6931	662
90119-08M33	18-0260	505	93210-97M55-00	18-0275	550	119225-77010	18-6935	662
90119-08M87-00	18-2605	497	93211-04384-00	18-7444	550	119225-77011	18-6935	662
90171-10M01	18-3773	534	93310-32337-00	18-1410	516	119226-77010	18-6935	662
90171-14056-00	18-3792	534	93310-620V5-00	18-1411	516	119350-35150	18-7910-1	182, 673
90171-14056-00	18-73907	534	93310-730V8-00	18-4077	516	119573-77200	18-6927	661
90171-16011-00	18-3732	534	93310-836V2-00	18-4078	516	119573-77200	18-6929	661
90201-08M54-00	18-73978	533	93604-10M03-00	18-43717	504, 505	119573-77201	18-6927	661
90201-22M01	18-9078	497	93604-18080-00	18-43716	497	119573-77201	18-6929	661
90206-22M19	18-9077	497	95307-16900-00	18-3732	534	119574-42550	18-45714	671
90280-03003-00	18-3305	497	97080-06045	18-0261	504	119574-42552	18-45714	671
90280-03024-00	18-3305	497	97080-08045-00	18-0256	497	119773-42600-00	18-3306	555

Yanmar (Cont.)			Yanmar (Cont.)			Yanmar (Cont.)		
O.E. #	SIERRA #	PAGE #	O.E. #	SIERRA #	PAGE #	O.E. #	SIERRA #	PAGE #
119773-77010	18-6938	662	124610-77010	18-6934	662	129470-77200	18-6927	661
119773-77200	18-6849	661	124610-77019	18-6934	662	129470-77200	18-6970	661
119836-77200	18-6926	661	127610-42200	18-3077	556	129573-77010	18-6880	662
119836-77200-2	18-6926	661	128170-01331	18-55600	671	129612-77230	18-6926	661
119836-77200-3	18-6926	661	128170-11310	18-56000	671	129698-77010	18-6932	662
121120-77010	18-6931	662	128170-42090	18-56602	671	171008-77010	18-6880	662
121120-77011	18-6931	662	128170-77010	18-6937	662	171056-35110	18-7917	182, 673
121120-77012	18-6931	662	128170-77010D	18-6937	662	171056-35111	18-7917	182, 673
121254-77010	18-6939	662	128170-77200	18-6928	661	18-55501	18-55501	671
121254-77011	18-6939	662	128170-77201	18-6928	661	192470-42530	18-3277	964
121254-77012	18-6939	662	128170-77202	18-6928	661	192470-42532	18-3277	964
121254-77019	18-6939	662	128171-01911	18-55601	671	27210-200200	18-6200	672
121370-77010	18-6932	662	128171-12540	18-57704	671	27210-200300	18-6201	672
123500-77010	18-6934	662	128176-42071	18-8951	671	424610-77010	18-6934	662
124085-35113	18-7917	182, 673	128270-12540	18-57703	670	728170-92600	18-55500	671
124223-42092	18-8950	671	128270-77200	18-6925	661	728271-92605	18-55502	671
124450-35100	18-7910-1	182, 673	128271-01911	18-55602	671	728374-92605	18-55503	671
124450-35110	18-7917	182, 673	128374-01911	18-55603	672	ZENITH		
124520-77010	18-6931	662	129242-77010	18-6932	662	K-2035	18-7732	566
124520-77011	18-6931	662	129429-77010	18-6939	662	K-2036	18-7732	566
124550-35110	18-7917	182, 673	129429-77011	18-6939	662			



SIERRA #	PAGE #	SIERRA #	PAGE #	SIERRA #	PAGE #	SIERRA #	PAGE #
GAUGES							
10860	22	62555P	2, 7	67363P	3, 14	69717P	12
1502778	22	62561P	2, 7	67364P	3, 14	69721P	15
1507678P	21	62565P	2, 7	67365P	3, 14	69722P	15
1508370P	22	62714P	6	67382P	3, 14	69723P	16
1827871P	22	62715P	6	67437P	21	69724P	16
18-5896	19	62718P	2, 6	67457P	21	69725P	17
18-5897	19	62719P	2, 6	67653P	9	69726P	17
18-5898	19	62720P	2, 6	67654P	7	69743P	3, 12
18-5899	19	62721P	2, 6	67657P	2, 7	69870P	3, 12
18-7513	19	62722P	2, 6	67669P	9	69992D	4
56353P	21	62723PH	6	67855P	3, 14	69993D	4
56966P	20, 119	62724P	2, 6	68356P	3, 15	69994D	4
56967P	20, 119	62725P	2, 6	68357P	3, 15	69995K	4
56968P	20	62726P	2, 6	68358P	3, 15	69996K	4
56969P	20	62727P	2, 6	68359P	3, 15	69997K	4
56973P	21	62728P	2, 6	68361P	3, 15	69998K	4
57897P	15	62729P	2, 6	68362P	15	69999K	4
57898P	3, 15	62730P	2, 6	68363P	15	70000D	4
57898PH	15	62748P	2, 6	68364P	3, 16	70001D	4
57899P	3, 15	62952P	2, 11	68365P	3, 16	70002D	4
57899PH	15	62960P	2, 11	68366P	3, 16	70003D	4
57900P	3, 15	63076P	3, 12	68367P	3, 16	70004D	4
57900PH	15	63076PH	12	68369P	3, 16	70005D	4
57901P	3, 15	63473P	3, 13	68370P	3, 16	70006D	4
57902P	3, 15	63474P	3, 13	68371P	3, 16	781-294-060P	2, 5, 8
57903P	3, 15	63475P	3, 13	68372P	3, 16	781-310-035P	2, 5, 9
57904P	3, 15	63475PH	13	68373P	3, 16	781-310-060P	2, 5, 9
57905P	3, 15	63476P	3, 13	68374P	3, 16	781-579-035P	3, 5, 15
57929P	3, 15	63476PH	13	68375P	3, 16	781-579-060P	3, 5, 15
58255P	3, 15	63477P	3, 13	68376P	3, 16	781-579-080P	3, 5, 15
58342P	3, 15	63478P	3, 13	68377P	3, 16	781-625-035P	2, 5, 7
58342PH	15	63479P	3, 13	68378P	3, 16	781-625-080P	2, 5, 7
58431P	3, 15	63480P	3, 13	68379P	3, 16	781-625-120P	2, 5, 7
58862P	3, 15	63481P	3, 13	68380P	3, 16	781-627-035P	2, 5, 6
58935P	3, 15	63482P	3, 13	68381P	3, 16	781-627-060P	2, 5, 6
59416P	2, 9	63483P	3, 13	68383P	3, 16	781-627-080P	2, 5, 6
59653P	2, 9	63523P	2, 9	68384P	3, 16	781-627-120P	2, 5, 6
59654P	2, 9	63585P	3, 13	68385P	3, 16	781-683-035P	3, 5, 16
59655P	2, 9	64475P	3, 13	68387P	16	781-683-060P	3, 5, 16
59656P	2, 9	64477FP	2, 10	68388P	16	781-683-080P	3, 5, 16
59657P	2, 9	65129P	2, 10	68389P	3, 17	781-684-035P	3, 5, 17
59677P	21	65205P	3, 15	68390P	3, 17	781-684-060P	3, 5, 17
59703P	3, 12	65206SSP	2, 10	68391P	3, 17	781-684-080P	3, 5, 17
59704P	3, 12	65481P	12	68392P	3, 17	80131P	3, 18
59704PH	12	65485P	12	68393P	3, 17	80134P	3, 18
59705P	3, 12	65495P	2, 10	68394P	3, 17	80150P	3, 18
59706P	3, 12	65496P	2, 10	68395P	3, 17	80180P	3, 18
59707P	3, 12	65497P	2, 10	68396P	3, 17	80181P	3, 18
59708P	3, 12	65498P	2, 10	68397P	3, 17	80514P	3, 18
59709P	3, 12	65501P	2, 10	68398P	3, 17	80514PH	18
59713P	2, 9	65502P	2, 10	68399P	3, 17	80590P	3, 18
59737P	2, 9	65503P	2, 10	68400P	3, 17	80593P	18
61163P	3, 12	65504P	2, 10	68401P	3, 17	80596P	18
61238P	3, 15	65505P	2, 10	68402P	3, 17	80710P	3, 18
61546P	2, 11	65506P	2, 10	68403P	3, 17	80712P	18
61547P	2, 11	65507P	2, 10	68404P	3, 17	80730P	3, 18
61548P	2, 11	65508P	2, 10	68405P	3, 17	82288P	3, 18
61549P	2, 11	65509P	2, 10	68406P	3, 17	82301P	18
61550P	2, 11	65510P	2, 10	68408P	3, 17	82302P	3, 18
61551P	2, 11	65524P	2, 8	68409P	3, 17	82303P	3, 18
61552P	2, 11	65525P	2, 8	68410P	3, 17	82760P	3, 18
61748P	3, 15	65526P	2, 8	68412P	17	84760P	3, 15
61751P	2, 10	65529P	2, 8	68413P	17	FS45430	22
61751PH	10	65530P	2, 8	68443P	3, 15	IA55009	22
61752FP	2, 9	65531P	2, 8	68755P	5	IA62995	22
61752P	2, 10	65535P	2, 8	68960P	3, 14	IA65476	20
61752PH	10	65536P	2, 8	68960PH	14	IA65477	20
61826P	3, 12	65537P	2, 8	68982P	5	IH14767	21
61826PH	12	65545P	2, 8	69044P	15	IH15105	21
61886P	22	65547P	2, 8	69053P	5	OP22891	19
61901P	3, 12	65548P	2, 8	69073FP	14	OP22900	19
61908P	3, 12	65550P	2, 8	69074FP	14	OP24301	19
6219371P	22	65551P	2, 8	69268P	20	OP24891	19
62369P	3, 12	65553P	2, 8	69269P	20	OP72533	19
62375P	2, 11	65670P	2, 10	69270P	20	TS25101	19
62538P	2, 7	65670PH	10	69380P	20	TS26611	19
62540P	2, 7	65671P	2, 10	69381P	20	TS26621	19
62542P	2, 7	65692P	2, 10	69703P	12	TS26631	19
62543P	2, 7	65693P	2, 10	69704P	12	TS26641	19
62546P	2, 7	66956P	3, 12	69708P	15	TS26651	19
62546PH	7	67019P	3, 14	69709P	15		
62547P	2, 7	67020P	3, 14	69710P	16		
62548P	2, 7	67021P	3, 14	69711P	16		
62549P	2, 7	67022P	3, 14	69712P	17		
62550P	2, 7	67023P	3, 14	69713P	17		
62551P	2, 7	67285P	3, 14	69716P	12		

SIERRA #	PAGE #	SIERRA #	PAGE #	SIERRA #	PAGE #	SIERRA #	PAGE #
SIERRA SWITCH & ELECTRICAL							
95001	62	EC01350	61	EC63140	59	FS45392	52
95002	62	EC01360	60	EC63190	59	FS45400	52
95003	Obsolete	EC01370	60	EC63200	59	FS45402	52
95004	62	EC01380	60	EC63240	59	FS45410	51
95005	62	EC01440	60	EC63250	59	FS45412	51
95006	62	EC01450	60	EC63260	59	FS45430	52, 53
95010	Obsolete	EC01460	60	EC63300	59	FS45432	52
95011	62	EC01570	60	EC63720	59	FS45440	52
95013	62	EC01620	60	EC64000	59	FS45442	52
95016	62	EC01630	60	EC64000-100	Obsolete	FS45460	52
95026	62	EC01750	60	EC64110	59	FS45462	52
18-1100	58	EC01760	60	EC64110-100	59	FS45470	51
18-1105	58	EC04000	60	EC64230	59	FS45472	51
18-1106	58	EC04000-100	60	EC64230-100	59	FS45620	51
18-1107	58	EC04010	59	FS22080	52	FS45622	51
18-1109	58	EC04010-100	59	FS22082	52	FS45630	51
18-1110	58	EC04020	59	FS35870	51	FS45632	51
18-1175	58	EC04020-100	59	FS35872	51	FS45640	51
18-1176	58	EC04030-100	59	FS40410	48	FS45642	51
18-1177	58	EC04040-100	59	FS40412	48	FS45650	51
18-1178	58	EC04050	60	FS40420	48	FS45652	51
18-1199	58	EC04050-100	60	FS40422	48	FS46100	49
18-1282	30	EC04070-100	60	FS40430	48	FS46102	49
18-1294	30	EC04080	60	FS40432	48	FS46150	49
18-3746	58	EC04080-100	60	FS40440	48	FS46152	49
18-3747	58	EC04090	60	FS40442	48	FS46200	49
18-3748	58	EC04090-100	60	FS40450	48	FS46202	49
18-5840	57	EC04100	60	FS40452	48	FS46250	49
18-5894	19	EC04100-100	60	FS40500-1	48	FS46252	49
18-79987	58	EC04110	60	FS40502-1	48	FS46300	50
18-79988	58	EC04110-100	60	FS40510-1	48	FS46302	50
BA58003	57	EC04120	59	FS40512-1	48	FS46350	50
BA58010	57	EC04120-100	59	FS40520-1	48	FS46352	50
BA58020	57	EC04130	59	FS40522-1	48	FS46400	49
BA58050	57	EC04130-100	59	FS40530-1	48	FS46402	49
BC88523	57	EC04140	59	FS40540-1	49	FS46450	49
BC88533	57	EC04140-100	59	FS40542-1	49	FS46452	49
BC88543	57	EC04150	60	FS40550-1	49	FS46551	50
BC88553	57	EC04150-100	60	FS40552-1	49	FS46552	50
BC88563	57	EC04160-100	60	FS40560-1	49	FS46561	50
BC88573	57	EC04170	60	FS40562-1	49	FS46562	50
BC88583	57	EC04170-100	60	FS40570-1	49	FS56152	51
BC88593	57	EC04180	60	FS40572-1	49	FS56232	48
BT44430	57	EC04180-100	60	FS40590-1	48	FS56242	48
CB40190	53	EC04190	59	FS40592-1	48	FS56252	48
CB40200	53	EC04190-100	59	FS40600-1	48	FS69100	52
CB40220	53	EC04200	59	FS40602-1	48	FS69110	52
CB40230	53	EC04200-100	59	FS40610-1	48	FS69120	52
CB40240	53	EC04210	60	FS40612-1	48	FS69130	51
CB40250	53	EC04210-100	60	FS40630-1	49	FS69140	52
CB40260	53	EC04220	60	FS40632-1	49	FS69150	52
CB40270	53	EC04220-100	60	FS40640-1	49	FS69160	52
CB40280	53	EC04230	60	FS40642-1	49	FS69170	52
CB41100	53	EC04230-100	60	FS40650-1	49	FS69180	52
CB41200	53	EC04240	59	FS40652-1	49	FS79060	46
CB41210	53	EC04240-100	59	FS40660	51	FS79070	46
CB41210B	53	EC04250	59	FS40662	51	FS79090	46
CB41220	53	EC04250-100	59	FS40670	51	FS79100	46
CB41230	53	EC04260	59	FS40672	51	FS79110	46
CB41240	53	EC04260-100	59	FS40680	51	FS79120	46
CB42240	53	EC04280	60	FS40682	51	FS79130	46
CB42250-1	53	EC04280-100	60	FS40690	51	FS79140	46
CB43240	53	EC04300	59	FS40692	51	FS79150	46
CB43250	53	EC04300-100	59	FS40720	50	FS79160	46
CB45240	53	EC04490	60	FS40722	50	FS79170	46
CB45250	53	EC04490-100	60	FS40730	48	FS79180	46
CB60000-1	53	EC04500	60	FS40732	48	FS79190	46
CB60002-1	53	EC04500-100	60	FS40740	48	FS79200	46
CB60010	53	EC04700-100	Obsolete	FS40742	48	FS79210	46
CB60012	53	EC04710-100	59	FS40750	50	FS79220	46
CL49300	62	EC04720-100	59	FS40752	50	FS79270	46
CL49310	62	EC06230	60	FS45350	52	FS79280	46
CL49320	62	EC09040	61	FS45352	52	FS79470	46
CL49330	62	EC09090	61	FS45360	52	FS79480	47
CL49330KA	62	EC10250	60	FS45362	52	FS79490	47
CL49332	62	EC10290	60	FS45380	52	FS79500	47
CL52422	62	EC63120	59	FS45382	52	FS79510	47
EC01310	61	EC63130	59	FS45390	52	FS79520	47

INTERCHANGE GUIDE — Part Number to Page Number

SIERRA #	PAGE #	SIERRA #	PAGE #	SIERRA #	PAGE #	SIERRA #	PAGE #
SIERRA SWITCH & ELECTRICAL							
FS79530	47	MP39210	53	MP39802	24	MP78910	31
FS79540	47	MP39220	42	MP39820-1	26	MP78912	31
FS79550	47	MP39222	42	MP39822-1	26	MP78942	31
FS79560	47	MP39240	S/S to MP39240-1	MP39830	29	MP78950	31
FS79570	47	MP39240-1	42	MP39832	29	MP78952	31
FS79580	47	MP39242	42	MP40950	30	MP78960	31
FS79590	47	MP39260	46	MP40960	30	MP78962	31
FS79600	46	MP39262	46	MP40962	30	MP79740	31
FS79630	46	MP39270	30	MP40970-1	30	MP79742	31
FS79680	47	MP39280	42	MP40972-1	30	MP79760	31
FS79690	47	MP39282	42	MP40980	30	MP79762	31
FS79820	46	MP39300	45	MP40982	30	N-186913	51
FS79870	46	MP39302	45	MP40990	30	OP22891	19, 53
FS80000	47	MP39310	45	MP40992	30	OP22900	19, 53
FS80010	47	MP39312	45	MP41000	28	RK19210	32
FS80030	47	MP39320	45	MP41002	28	RK19220	32
FS80040	47	MP39322	45	MP41010	27	RK19230	32
FS80050	47	MP39340	45	MP41012	27	RK19240	32
FS80060	47	MP39342	45	MP41020	25	RK19310	32
FS80070	47	MP39350	46	MP41022	25	RK19320	32
FS80080	47	MP39352	46	MP41030	26	RK19400-1	35
FS80090	47	MP39360	45	MP41032	26	RK19410-1	35
FS81000	47	MP39362	45	MP41040	24	RK19410-RED	35
FS81010	47	MP39380	43	MP41042	24	RK19420-1	35
FS81020	47	MP39382	43	MP41070-2	28	RK19430-1	35
FS81030	47	MP39390	43	MP41072-2	28	RK19440-1	35
FS81040	47	MP39390B	43	MP41080	27	RK19450-1	35
FS81050	47	MP39392	43	MP41082	27	RK19460-1	35
FS81060	47	MP39392B	43	MP41090-1	28	RK19480-1	35
FS81080	47	MP39410	45	MP41092-1	28	RK19490-1	35
FS81082	47	MP39412	45	MP41400	53	RK19500K	37
FSC46100	50	MP39420	45	MP49410	61	RK19510K	37
FSC46200	50	MP39422	45	MP49412	61	RK19520K	37
FSC46300	50	MP39510	43	MP49430	61	RK19530K	37
FSC46400	50	MP39512	43	MP49432	61	RK19540-1	35
FSC46550	50	MP39520	43	MP49500	62	RK19550-1	35
FSC46560	50	MP39522	43	MP49510	Obsolete	RK19570	36
MC33502	53	MP39530	43	MP50560	61	RK19572	36
MP21460	44	MP39532	43	MP50562	61	RK19630	38
MP21462	44	MP39540	43	MP51010	23	RK19632	38
MP28850	30	MP39542	43	MP51012	23	RK19640	38
MP28860	30	MP39570	43	MP51020	23	RK19642	38
MP28870	30	MP39572	43	MP51022	23	RK19680	33
MP28872-1	30	MP39580	44	MP51030	23	RK19680TP	33
MP28880	30	MP39582	44	MP51032	23	RK19690	33
MP28890	30	MP39590	44	MP51040	23	RK19690TP	33
MP28900	30	MP39592	44	MP51042	23	RK19700	34
MP28902-1	30	MP39600	44	MP51050	23	RK19700TP	34
MP38910	57	MP39602	44	MP51052	23	RK19710TP	33
MP39010	26	MP39610	43	MP51090	23, 29	RK19720	33
MP39012	26	MP39612	43	MP51092	23, 29	RK19730TP	34
MP39020	26	MP39620	44	MP52000	23, 29	RK19740	34
MP39022	26	MP39622	44	MP52002	23, 29	RK19750TP	33
MP39030	42	MP39640	44	MP59012	31	RK19760	33
MP39032	42	MP39642	44	MP59032	31	RK19770TP	34
MP39040	29	MP39670	45	MP59042	31	RK19780	34
MP39042	29	MP39672	45	MP59102	31	RK19810TP	34
MP39060-1	25	MP39680	45	MP59122	31	RK19820	34
MP39062-1	25	MP39682	45	MP59132	31	RK19830TP	34
MP39070	24	MP39690	45	MP59162	31	RK19840	34
MP39072	24	MP39692	45	MP78372	31	RK19850TP	33
MP39080-1	25	MP39700-1	24	MP78710	31	RK19860	33
MP39082-1	25	MP39702-1	24	MP78712	31	RK19870TP	33
MP39090	29	MP39710-1	27	MP78720	31	RK19880	33
MP39092	29	MP39712-1	27	MP78722	31	RK19890TP	34
MP39100	29	MP39720-1	27	MP78730	31	RK19910	34
MP39102	29	MP39722-1	27	MP78740	31	RK19920-1	35
MP39120	25	MP39730	27	MP78750	Obsolete	RK19930-1	35
MP39122	25	MP39732	27	MP78760	Obsolete	RK19940-1	35
MP39140	46	MP39740-1	28	MP78762	Obsolete	RK21420	38
MP39142	46	MP39742-1	28	MP78800	31	RK21430	38
MP39160	44	MP39760	28	MP78802	31	RK21880	38
MP39162	44	MP39762	28	MP78820	31	RK21890	38
MP39180	44	MP39770	26	MP78822	31	RK22100	33
MP39182	44	MP39772	26	MP78830	31	RK22110	33
MP39190	30	MP39780	25	MP78860	31	RK22120	34
MP39200	26	MP39782	25	MP78870	31	RK22130	34
MP39202	26	MP39800	24	MP78872	31	RK22140	34

SIERRA #	PAGE #	SIERRA #	PAGE #	SIERRA #	PAGE #	SIERRA #	PAGE #
SIERRA SWITCH & ELECTRICAL							
RK22150	34	TC44054	54	TG22042	40	UN19700	38
RK22160	35	TC44094	54	TG23000	40	UN19710	38
Rk22170	35	TC44224	54	TG23010	40	UN19720	38
RK22180	32	TC44254	54	TG23012	40	UN19730	38
RK22190	32	TC44984	55	TG23020	40	UN19740	38
RK22200	32	TC50000	55	TG23022	40	UN19750	38
RK22290	32	TC51000	54	TG23030	40	UN21280	43
RK40100	36	TC51100	54	TG23032	40	UN21282	43
RK40102	36	TC51200	54	TG23040	40	UN21290	43
RK40110	36	TC51300	55	TG23042	40	UN21292	43
RK40112	36	TC52000	54	TG23050	40	UN21320	43
RK40120	36	TG19520	39	TG23052	40	UN21322	43
RK40122	36	TG19522	39	TG40000	41	UN22100	42
RK40130	36	TG19530	39	TG40002	41	UN22102	42
RK40132	36	TG19532	39	TG40010	40	UN22110	42
RK40140	36	TG19540-1	41	TG40012	40	UN22112	42
RK40142	36	TG19542-1	41	TG40020-1	39	UN22120	42
RK40150	36	TG19560-1	41	TG4002252	39	UN22122	42
RK40152	36	TG19562-1	41	TG40030-1	39	UN22150	42
RK40170	36	TG21020-1	S/S to TG21020-2	TG4003252	39	UN22152	42
RK40172	36	TG21020-2	41	TG40040-1	39	UN22160	42
RK40350	36	TG21022-1	41	TG4004252	39	UN22162	42
RK40352	36	TG21040	41	TG40050-1	39	UN42000	46
RK40360	36	TG21042	41	TG4005252	39	UN42002	46
RK40362	36	TG21050-1	41	TG40060	39	UN77310	57
RK40370	37	TG21052-1	41	TG40062	39	WH10003	54
RK40372	37	TG21070	41	TG40070	39	WH10040	56
RK40380	37	TG21072	41	TG40072	39	WH10160	Obsolete
RK40382	37	TG21080	41	TG40080	39	WH10220	57
RK40390	37	TG21082	41	TG40082	39	WH10230	56
RK40392	37	TG21130	42	TG40090	39	WH10240	57
RK40400	37	TG21132	42	TG40092	39	WH10300	55
RK40402	37	TG21140	42	TG40160-1	39	WH10310	55
RK40470	36	TG21142	42	TG4016252	39	WH10320	57
RK40472	36	TG21360	42	TG40300	39	WH10350	54
RK40480	36	TG21362	42	TG40302	39	WH10470-1	56
RK40482	36	TG21390	42	TG40310	39	WH10480-1	56
TC42834	55	TG21392	42	TG40312	39	WH10490-1	56
TC42884	54	TG21500	41	TG40320	39	WH10500-1	56
TC42894	55	TG21502	41	TG40322	39	WH10520-1	56
TC42904	55	TG21590	41	TG40330	39	WH10530-1	56
TC42914	55	TG21592	41	TG40332	39	WH10540-1	56
TC43504	55	TG21600	41	TG40340	39	WH10550-1	56
TC43604	55	TG21602	41	TG40342	39	WH10560	56
TC43614	55	TG22000	40	TG40450-1	39	WH10570	56
TC43624	55	TG22002	40	TG4045252	39	WH10600-1	56
TC43634	55	TG22010	40	TG40460-1	39	WH10602-1	56
TC43654	54	TG22012	40	TG4046252	39	WH10610-1	56
TC43744	54	TG22020	40	TG40490	39	WH10612-1	56
TC43754	54	TG22022	40	TG40492	39	WH10640	56
TC43904	55	TG22030	40	TS25101	53	WH10650	56
TC43924	54	TG22032	40	UN12140	25		
TC43944	55	TG22040	40	UN12142	25		

SHIELDS

16-14X1X10	109	N-184458	106	SERIES 162	80	SERIES 351	84
16-14X2X10	109	N18NEO60	109	SERIES 163	80	SERIES 355	85
16-18X1X10	109	N316NEO60	109	SERIES 164	81	SERIES 365	85
16-18X2X10	109	N38NEO60	109	SERIES 168	81	SERIES 368	86
16-38X1X10	109	SERIES 101	90	SERIES 200	72, 96	SERIES 369	86
16-38X2X10	109	SERIES 105	90	SERIES 202	73, 97	SERIES 400	94
18-4456	106	SERIES 120	67	SERIES 220	104	SERIES 402	94
18-4457	106	SERIES 123	67	SERIES 220S	102	SERIES 420	94
18-4458	106	SERIES 126	108	SERIES 221	104	SERIES 450	95
18-800-1120	90	SERIES 128	107	SERIES 245	104	SERIES 460	95
18-801-1120	90	SERIES 129	107	SERIES 245S	103	SERIES 500	88
18-802-1120	90	SERIES 130	71	SERIES 250	74, 93, 98	SERIES 502	88
18-803-1120	90	SERIES 135	71	SERIES 252	75, 99	SERIES 600	88
18-806-1120	90	SERIES 140	68	SERIES 262	76, 100	SERIES 601	88
18-9093	92	SERIES 141	69, 78	SERIES 272	102	SERIES 700	88
18-9095	92	SERIES 142	68	SERIES 274	102	SERIES 710	106
18-9761	108	SERIES 144	91	SERIES 290	105	SERIES 720	106
18-9883	108	SERIES 146	69, 91	SERIES 290S	103		
18-J662-XXX	88	SERIES 147	68	SERIES 291	105		
18-J664-XXX	88	SERIES 148	70, 78, 92	SERIES 309	82		
18-J-VISE	88	SERIES 149	70, 79	SERIES 315	82		
N14NEO60	109	SERIES 150	79	SERIES 321	77, 87, 101		
N-184456	106	SERIES 151	109	SERIES 337	83		
N-184457	106	SERIES 160	71	SERIES 350	84		

SIERRA #	O.E.M.	O.E. #	PAGE #	SIERRA #	O.E.M.	O.E. #	PAGE #
GENERATOR PARTS							
18-9400-2			120	23-3610	Kohler	267717	115
18-9410-2			120	23-3650	Westerbeke	24688 & 24323	116
18-9420-2			120	23-3651	Westerbeke	35736 & 34196	116
18-9553-2			120	23-3652	Westerbeke	35736 & 33417	116
23-0400	Northern Lights		113	23-3653	Westerbeke	24688 & 34196	116
23-0800	Westerbeke	42260	115	23-3654	Westerbeke	39378 & 42260	116
23-0801	Westerbeke	46124	115	23-3655	Westerbeke	39378 & 46124	116
23-0802	Westerbeke	34196	115	23-3656	Westerbeke	46097 & 33417	116
23-0803	Westerbeke	33417	115	23-3657	Westerbeke	24690 & 33417	116
23-0804	Westerbeke	33373	115	23-3658	Westerbeke	24688 & 33966	117
23-0805	Westerbeke	40434	115	23-3659	Westerbeke	37387 & 37922	117
23-0806	Westerbeke	24232	115	23-3660	Westerbeke	24690 & 33373	117
23-0807	Westerbeke	33966	115	23-3661	Westerbeke	35736 & 40434	117
23-0808	Westerbeke	37922	115	23-3662	Westerbeke	24688 & 40434	117
23-0809	Kohler	267718	115	23-3663	Kohler	267717 & 267718	117
23-0810	Kohler	229432	115	23-3664	Kohler	249930 & 29963	117
23-0811	Kohler	249865	115	23-3665	Kohler	252896 & 229432	117
23-0812	Kohler	229433	116	23-3666	Kohler	352018 & 352031	117
23-0813	Kohler	229963	116	23-4000	Westerbeke	39181	120
23-0814	Kohler	352031	116	23-4001	Westerbeke	11672	120
23-0830	Northern Lights	11-10015	116	23-4002	Westerbeke	30592	120
23-1000	Westerbeke	24353	122	23-4003	Westerbeke	45232	120
23-1100	Kohler	267709	110	23-4004	Westerbeke	30475	120
23-1101	Westerbeke	39705	110	23-4005	Westerbeke	13810	113
23-1102	Northern Lights	24-22009	110	23-4006	Westerbeke	31152	114
23-1103	Northern Lights	24-28003	110	23-4007	Westerbeke	30376	114
23-1104	Fischer Panda	IC78.460.000B	110	23-4500	Westerbeke	43060	118
23-1105	Fischer Panda	IC78.460.000A	110	23-4501	Westerbeke	46596	118
23-1130	Kohler	278857	110	23-5600	Westerbeke	30593	120
23-2000	Sherwood	10077K	112	23-5601	Westerbeke	34552	Obsolete
23-2001	Johnson Pump	09-808B-1	112	23-5800	Westerbeke	24639	120
23-2002	Kohler	229826	112	23-5840	Westerbeke	35109	111
23-2002	Sherwood	09000K	112	23-5880	Westerbeke	24132	111
23-2003	Jabsco	22799-0001	112	23-5900	Westerbeke	30594	120
23-2003	Kohler	250872	112	23-6400	Kohler	260085	120
23-2004	Kohler	359978	112	23-6400	Westerbeke	11885	120
23-2005	Northern Lights	25-12009	112	23-6401	Onan	130-4434	120
23-2700	Westerbeke	40859	117	23-6402	Onan	130-6228	120
23-2701		34113	117	23-7200	Westerbeke	36450	110
23-2702	Westerbeke	35608	117	23-7201	Westerbeke	38100	110
23-2703	Westerbeke	46592	117	23-7202	Kohler	GM24510	110
23-2800		34093	118	23-7720	Onan	149-1445	111
23-2801		35610	118	23-7720	Westerbeke	35920	111
23-2802	Westerbeke	40860	118	23-7740	Kohler	252898	110
23-2803	Westerbeke	43050	118	23-7750	Onan	149-0428	111
23-2804		42201	118	23-7751	Kohler	229715	110
23-3300	Onan	132-0349	112	23-7760	Onan	149-2106	111
23-3301	Westerbeke	11907	112	23-7760	Onan	A026K278	111
23-3302	Westerbeke	33112	112	23-7761	Kohler	GM32359	111
23-3303	Kohler	229826	112	23-7762	Kohler	26987	111
23-3304	Kohler	229955	112	23-7764	Westerbeke	24363	111
23-3305	Westerbeke	32620	112	23-7770	Westerbeke	30200	111
23-3306	Westerbeke	46622	113	23-7770	Westerbeke	47060	111
23-3307	Westerbeke	34440	113	23-7771	Kohler	249433	111
23-3308	Kohler	352122	113	23-7780	Kohler	GM34570	111
23-3309	Onan	132-0436	113	23-7800	Westerbeke	36918	118
23-3310	Onan	541-1519	113	23-7801	Westerbeke	35595	118
23-3311	Fischer Panda	J009-46840	113	23-7802	Westerbeke	48076	118
23-3312	Fischer Panda	J009-1027B-1	113	23-7803	Kohler	326817	118
23-3313	Westerbeke	33104	113	23-7804	Onan	185-7444	118
23-3314	Kohler / Sherwood	359978	113	23-7820	Kohler	279449	118
23-3315	Northern Lights	25-12009	113	23-7821	Kohler	359771	119
23-3600	Westerbeke	26488	114	23-7822	Kohler	229678	119
23-3601	Westerbeke	35736	114	23-7823	Kohler	267714	119
23-3602	Westerbeke	37387	114	23-7824	Kohler	GM47465	119
23-3603	Westerbeke	39378	114	23-7825	Westerbeke	35828	119
23-3604	Westerbeke	46097	114	23-7826	Westerbeke	40154	119
23-3605	Westerbeke	24690	114	23-7840	Onan	122-0810	119
23-3606	Onan	309-0130	114	23-7841	Onan	122-0185	119
23-3607	Kohler	352018	114	23-7842	Onan	185-5835	119
23-3608	Kohler	249930	114				
23-3609	Kohler	252896	114				
SIERRA							
4701			559	4725			559
4702			559	4730			559
4703			559	4731			559
4704			559	4732			559
4705			559	4733			559
4711			559	4734			559
4712			559	4735			559
4713			559	22355	OMC	390905	201
4714			559	22423	Mercury Marine	27-801328158	Obsolete
4715			559	22423	Mercury Marine	27-801761363	Obsolete
4720			559	22423	Mercury Marine	92-12564 2	Obsolete
4721			559	22423	Mercury Marine	92-12564-1	Obsolete
4722			559	22423	Mercury Marine	92-730611	Obsolete
4723			559	22423	Mercury Marine	92-755051	Obsolete
4724			559	22423	Mercury Marine	92-809056979	Obsolete

1 This product is priced per piece. To order, priced per package, please add -9 to the part number
 2 Items ending in "D" are display packaged - regular number is non-display
 3 For discount shop pack of 10, please add -10 to the part number

SIERRA #	O.E.M.	O.E. #	PAGE #	SIERRA #	O.E.M.	O.E. #	PAGE #
SIERRA							
22423	OMC	324073	Obsolete	18-01308			213
22423	OMC	327361	Obsolete	18-0131	Mercury Marine	27-64857	420
22423	Yamaha	90790-74001-00	Obsolete	18-0131	Mercury Marine	27-69525	420
37467			201	18-0131	Mercury Marine	27-695251	420
37477	OMC	500421	201	18-0131	Mercury Marine	27-695252	420
37478	Mercury Marine	92-809819	201	18-01311			214
37478	OMC	388517	201	18-01312			214
37478	OMC	500422	201	18-01313			214
37479	Mercury Marine	92-809820	201	18-01314			214
37479	OMC	500423	201	18-0133	Mercury Marine	27-52892	420
37509	Mercury Marine	92-59327-1	201	18-0133	Mercury Marine	27-73665	420
37509	Mercury Marine	92-809824	201	18-0134	OMC	327707	309
37509	Mercury Marine	FT8935	201	18-0135	Mercury Marine	27-78246	422
37509	OMC	384884	201	18-0135	Mercury Marine	27-782461	422
37534	Mercury Marine	92-41669-1	202	18-0136	OMC	328283	312
37534	Mercury Marine	92-802882A1	202	18-0137	Mercury Marine	27-85492-2	420
37534	Mercury Marine	92-823506 1	202	18-0138	OMC	328590	312
37566			202	18-0139	Mercury Marine	27-76589	422
37643			201	18-0139	Mercury Marine	27-78623	422
37701			201	18-0139	Mercury Marine	27-88451	422
38653	OMC	384848	201	18-0139	Mercury Marine	27-884511	422
56507	OMC	910048	202, 276	18-0140	OMC	328604	310
79040	OMC	390928	201	18-01402			214
1525607	Mercury Marine	92-34227	201	18-01404			214
1525607	Mercury Marine	92-342271	201	18-01406			214
1525607	Mercury Marine	92-34227Q02	201	18-01408			214
1525607	Mercury Marine	92-802881A1	201	18-0141	Chrysler Force	27-F85762	235
1525607	OMC	317201	201	18-01416			214
1525607	OMC	508235	201	18-01418			214
2096059			201	18-0142	OMC	328622	310
18-0020	Yamaha	67C-W0001-21-00	546	18-01422			214
18-0021	Yamaha	688-W0001-22-00	546	18-0144	OMC	328626	310
18-0022	Yamaha	689-W0001-23-00	546	18-0146			971
18-0023	Yamaha	689-W0001-C2-00	546	18-0147	Mercury Marine	27-56880	811
18-0024	Yamaha	698-W0001-21-00	546	18-0147	OMC	3852824	909
18-0025	Yamaha	69G-W0001-20-00	546	18-0147	Volvo	3852824	986
18-0026	Yamaha	6A1-W0001-22-00	547	18-0148	OMC	329718	310
18-0027	Yamaha	6A1-W0001-23-00	547	18-01500			214
18-0028	Yamaha	6E0-W0001-C1-00	547	18-0151	Mercury Marine	27-75952	421
18-0029	Yamaha	6G1-W0001-C1-00	547	18-0151	Mercury Marine	27-76636	421
18-0030	Yamaha	6L2-W0001-C3-00	547	18-0152	Chrysler Force	27-F481836	235
18-0031	Yamaha	6N0-W0001-C0-00	547	18-0153	Mercury Marine	27-72627	805
18-0032	Volvo	847741	182, 672, 977	18-0153	Mercury Marine	27-85817A1	805
18-0033	Volvo	21707133	182, 672, 977	18-0153	Mercury Marine	FI5110032	805
18-0034	Volvo	477556	182, 672, 977	18-0153	Mercury Marine	FI5110037	805
18-0035	Volvo	3582732	182, 672, 977	18-0153	OMC	357159	905
18-0036	Volvo	3582733	182, 672, 977	18-0153	OMC	393159	605
18-00534			215	18-0153	OMC	458625	605
18-00535			215	18-0154	Chrysler Force	27-F40279-1	236
18-0101	Mercury Marine	27-73397	419	18-0155	OMC	330412	314
18-0101	Mercury Marine	27-76952	419	18-0157	OMC	330698	310
18-0102	OMC	323469	311	18-0158	Mercury Marine	27-70905	809
18-0103	Mercury Marine	27-37725	422	18-0159	OMC	330909	310
18-0103	Mercury Marine	27-72496	422	18-01600			214
18-0103	Mercury Marine	27-79650	422	18-01602			214
18-0103	Mercury Marine	27-796501	422	18-0161	OMC	331532	310
18-0104	OMC	907764	908	18-0163			973
18-0105	Mercury Marine	27-85489-2	420	18-0164	OMC	311069	907
18-0106	OMC	324323	311	18-0164	Volvo	3852096	984
18-0107	Mercury Marine	27-64203	420	18-0164	Yamaha	YSC-13080-00-0C	995
18-0107	Mercury Marine	27-72510	420	18-0166	OMC	911705	910
18-0107	Mercury Marine	27-85498	420	18-01701			214
18-0107	Mercury Marine	27-85498-1	420	18-01703			214
18-0108	OMC	324449	314	18-01705			214
18-0110	OMC	324670	314	18-01707			214
18-01101			213	18-0172	Mercury Marine	26-97530	446, 857
18-0111	Mercury Marine	27-89657	809	18-0173	OMC	313283	347
18-0112	OMC	324717	312	18-0174	OMC	326716	347
18-0113-1	Mercury Marine	27-856705	809	18-0175	Mercury Marine	25-26543	449, 858
18-0113-1	Mercury Marine	27-97542	809	18-0176	Honda	19242-ZV5-000	247
18-0114	OMC	907761	SS to 18-0114-1	18-0179	Racor	RK22244	137
18-0114-1	OMC	907761	899, 908	18-0182	Mercury Marine	27-62386	423
18-0115	Chrysler Force	27-F307279-2	235	18-0182	OMC	310058	313
18-0116			201	18-0183-1	Mercury Marine	27-54566	643, 781, 809
18-0117	OMC	317955	311	18-0183-1	Mercury Marine	27-73866	643, 781, 809
18-0118	OMC	325092	309	18-0183-1	OMC	908717	643, 781
18-0119	Chrysler Force	27-F85154-1	235	18-0183-1	OMC	916262	643, 781
18-0120	OMC	325211	311	18-0183-1	OMC	3852455	643, 781
18-01200			213	18-0183-1	OMC	3853742	643, 781
18-01202			213	18-0183-1	Pleasurecraft	RM0007	631
18-0122	OMC	325260	310	18-0183-1	Volvo	3852455	643, 984
18-0124	OMC	325537	314	18-0183-1	Volvo	3853742	643, 984
18-0126	OMC	326264	311	18-0184	Volvo	804190	989
18-0128	OMC	326468	312	18-0185	Mercury Marine	27-91892	811
18-0129	Mercury Marine	27-65744	420	18-0188	OMC	909748	911
18-0129	Mercury Marine	27-657441	420	18-0190	OMC	912157	910
18-0129	Mercury Marine	27-657442	420	18-0191	Yamaha	92990-06600-00	516
18-0129	Mercury Marine	27-657443	420	18-0192	Yamaha	92990-10600-00	516
18-0130	OMC	332266	310	18-0192	Yamaha	92900-10600-00	516
18-01301			213	18-0192	Yamaha	92901-10600-00	516
18-01302			213	18-0192	Yamaha	92902-10600-00	516

1 This product is priced per piece. To order, priced per package, please add -9 to the part number

2 Items ending in "D" are display packaged - regular number is non-display

3 For discount shop pack of 10, please add -10 to the part number

SIERRA #	O.E.M.	O.E. #	PAGE #	SIERRA #	O.E.M.	O.E. #	PAGE #
SIERRA							
18-0192	Yamaha	92903-10600-00	516	18-0314	Chrysler Force	27-F178168	235
18-0192	Yamaha	92995-10600-00	516	18-0314	Chrysler Force	27-F178168-1	235
18-0195	OMC	314731	331, 921	18-0314	Chrysler Force	F178168	235
18-0197	OMC	333725	331	18-0315	Chrysler Force	27-F440906	235
18-0198	OMC	324766	331, 921	18-0318	Mercury Marine	12-815472	813
18-0200	OMC	327656	331	18-0319	Mercury Marine	27-828553	422
18-0201	OMC	333771	331	18-0320	Mercury Marine	27-13937-6	420
18-0202-9	Mercury Marine	8227731	438	18-03200			214
18-0203	Mercury Marine	12-25410	813	18-03206			214
18-0203	Mercury Marine	12-35935	813	18-03208			214
18-02060	OMC	911680	914	18-0322	Mercury Marine	27-14241	812
18-02061	OMC	911681	914	18-0322	Mercury Marine	27-881715	812
18-02062	OMC	911662	914	18-0322	Mercury Marine	F11101656	812
18-02063	OMC	911663	914	18-0322	OMC	3852656	910
18-02065	OMC	911665	914	18-0322	Volvo	3852656	987
18-02066	OMC	911666	914	18-0323	Mercury Marine	27-14318 3	423
18-02067	OMC	911667	914	18-0323	Mercury Marine	27-14318-2	423
18-0207	OMC	911668	914	18-0324	Mercury Marine	27-15172	419
18-0208	Mercury Marine	23-1761515	826	18-0324	Mercury Marine	27-15172-3	419
18-0209	OMC	911669	914	18-0324	Mercury Marine	27-151724	419
18-0209	OMC	911670	914	18-0324	Mercury Marine	27-93214	419
18-0209	OMC	911671	914	18-0327	Mercury Marine	27-33956	811
18-0209	OMC	911672	914	18-0327	Mercury Marine	FI5000200	811
18-0209	OMC	911673	914	18-0327	Mercury Marine	FI5000219	811
18-0209	OMC	911674	914	18-0327	OMC	3853342	909
18-0209	OMC	911675	914	18-0327	Volvo	3853342	985
18-0209	OMC	911676	914	18-0328	Mercury Marine	27-34208	811
18-0209	OMC	911677	914	18-0329	Mercury Marine	27-34209	811
18-0210	Mercury Marine	23-1761516	826	18-0329			910
18-0211	OMC	911669	914	18-0333	Mercury Marine	27-39401	422
18-0211	OMC	911670	914	18-0334	Mercury Marine	27-39402	422
18-0211	OMC	911671	914	18-0336	Mercury Marine	27-41670-3	422
18-0211	OMC	911672	914	18-0336	Mercury Marine	27-41670-5	422
18-0211	OMC	911673	914	18-0337			971
18-0211	OMC	911674	914	18-0339	Mercury Marine	27-43006-2	423
18-0211	OMC	911675	914	18-0339	Mercury Marine	27-430066	423
18-0211	OMC	911676	914	18-03400			214
18-0211	OMC	911678	914	18-03404			214
18-0212	Mercury Marine	23-1761517	826	18-0341	Mercury Marine	27-43008	422
18-0214	Mercury Marine	23-1761518	826	18-0341	Mercury Marine	27-430082	422
18-0216	Mercury Marine	23-1761519	826	18-0341	Mercury Marine	27-430083	422
18-0218	Mercury Marine	23-1761520	826	18-0341	Mercury Marine	27-430085	422
18-0222	Mercury Marine	23-1761522	826	18-0341	Mercury Marine	27-430086	422
18-0224	Mercury Marine	23-1761523	826	18-0342	Mercury Marine	27-47644	812
18-0226	Mercury Marine	23-1761524	826	18-0342	Mercury Marine	27-47644	812
18-0227	OMC	911678	914	18-0342	Mercury Marine	27-476441	812
18-0229	OMC	911679	914	18-0345	Mercury Marine	27-822189	424
18-0230	Mercury Marine	23-1761526	826	18-0346	Mercury Marine	27-34042	810
18-0232	Mercury Marine	27-81031M	421	18-0346	Mercury Marine	27-49936	810
18-0232	Yamaha	655-12414-A1-00	530	18-0346	OMC	3930912	909
18-0239	Yamaha	688-44315-A0-00	530	18-0347	Mercury Marine	27-34041	810
18-0240	Yamaha	688-44316-A0-00	531	18-0347	Mercury Marine	27-52145	810
18-0242	Yamaha	663-13622-00-00	525	18-0347	Mercury Marine	27-806452	810
18-0242	Yamaha	663-13622-A0-00	525	18-0347	OMC	912981	909
18-0244	Yamaha	6E5-44315-A0-00	531	18-0347	OMC	913277	909
18-0248	Honda	17151-ZW5-00	248	18-0347	OMC	3852693	909
18-0250	Yamaha	664-41114-A0-00	530	18-0347	Volvo	3852693	985
18-0252	Volvo	876314	981	18-0348	Mercury Marine	27-49107	805
18-0256	Yamaha	97080-08045-00	497	18-0348	Mercury Marine	27-52550	805
18-0256	Yamaha	97095-08045-00	497	18-0348	Mercury Marine	F11100229	805
18-0260	Yamaha	90119-08M33	505	18-0348	Mercury Marine	FI5000229	805
18-0261	Yamaha	97080-06045	504	18-0348	Mercury Marine	FI5000245	805
18-0265	Yamaha	93101-28M16-00	550	18-0348	OMC	508871	905
18-0266	Yamaha	93101-30M17-00	550	18-0348	OMC	3931593	905
18-0267	Mercury Marine	26-82257M	446	18-0352	Mercury Marine	27-56173	810
18-0267	Yamaha	93106-09014-00	550	18-0352	OMC	913758	909
18-0275	Yamaha	93210-97M55-00	550	18-0352	Volvo	3852818	985
18-0292	Mercury Marine	27-81417M	423	18-0353	Mercury Marine	27-58764	781
18-0292	Yamaha	663-44315-A0-00	531	18-0354	Mercury Marine	27-60715	807
18-0294	Mercury Marine	27-81421M	423	18-0356	Mercury Marine	27-32910	807
18-0294	Yamaha	663-44324-A0-00	531	18-0356	Mercury Marine	27-64692	807
18-0296	Mercury Marine	26-854017M	446	18-0357	Mercury Marine	27-56884	807
18-0296	Yamaha	93101-22067-00	550	18-0357	Mercury Marine	27-65577	807
18-0297	Mercury Marine	26-82234M	446	18-0359	Mercury Marine	27-67275	420
18-0297	Yamaha	93101-23070-00	550	18-0359	Mercury Marine	27-672751	420
18-0298	Mercury Marine	25-82275M	449	18-0360	Mercury Marine	27-70142	808
18-0298	Yamaha	93210-41042-00	550	18-03600			214
18-0299	Mercury Marine	25-82289M	449	18-03602			214
18-0299	Yamaha	93210-66M98-00	550	18-03606			214
18-0300	Honda	17105-ZY6-000	248	18-03608			214
18-0305-1	Crusader	96108	611	18-0365	Mercury Marine	27-75450	809
18-0306-1	Crusader	96216	611	18-0368			963
18-0307	Volvo	861250	985	18-0369	Mercury Marine	27-75909	422
18-0309-1	Crusader	96562	611	18-0371	Mercury Marine	27-39316	420
18-0310	Volvo	861251	985	18-0371	Mercury Marine	27-72915	420
18-0311	Crusader	97686	612	18-0371	Mercury Marine	27-78409	420
18-0311	Mercury Marine	27-11988	810	18-0372	Mercury Marine	27-52579	421
18-0311	OMC	3854942	909	18-0372	Mercury Marine	27-72916	421
18-0311	Volvo	3854942	985	18-0372	Mercury Marine	27-78410	421
18-0313	OMC	352165	314	18-0373	Mercury Marine	27-45088	420
18-0314	Chrysler Force	27-828316	235	18-0373	Mercury Marine	27-72917	420

1 This product is priced per piece. To order, priced per package, please add -9 to the part number

2 Items ending in "D" are display packaged - regular number is non-display

3 For discount shop pack of 10, please add -10 to the part number

SIERRA #	O.E.M.	O.E. #	PAGE #	SIERRA #	O.E.M.	O.E. #	PAGE #
SIERRA							
18-0373	Mercury Marine	27-78411	420	18-0463	Mercury Marine	27-814210	808
18-0376			973	1 18-0464	Mercury Marine	27-49121	810
18-0377			973	1 18-0464	Mercury Marine	27-91831	810
18-0378	Mercury Marine	27-823142	422	1 18-0464	OMC	912768	909
18-0378	Mercury Marine	27-823142 2	422	18-0465	Mercury Marine	27-65184	804
18-0380	Mercury Marine	27-83940M	420	18-0465	Mercury Marine	27-8M0050224	804
18-0382	Honda	17109-XY6-000	248	18-0465	OMC	352670	905
18-0384	Mercury Marine	27-817533	419	18-0466	Mercury Marine	27-14901	805
18-0384	Mercury Marine	27-89221	419	18-0466	Mercury Marine	27-14901A1	805
18-0384	Mercury Marine	27-892211	419	18-0466	Mercury Marine	27-52144	805
18-0384	Mercury Marine	27-8M0027781	419	18-0466	OMC	393061	905
18-0385	Mercury Marine	27-30803	422	18-0466	OMC	3921473	905
18-0385	Mercury Marine	27-31557	422	18-0466	OMC	3923440	905
18-0385	Mercury Marine	27-45748	422	18-0467	Mercury Marine	27-41610	808
18-0385	Mercury Marine	27-89937	422	18-0467	Mercury Marine	27-49814	808
18-0386	Mercury Marine	27-72780	811	18-0468	Mercury Marine	27-811572	810
18-0386	Mercury Marine	27-94914	811	18-0468	OMC	912954	910
18-0388	Mercury Marine	27-98823	812	18-0468	OMC	915326	910
18-0388	Mercury Marine	27-988231	812	18-0468	OMC	3852654	910
18-0389	Mercury Marine	27-99960	809	18-0468	OMC	3853512	910
18-0390	Honda	17105-ZY3-004	248	18-0468	Volvo	3852654	986
18-0396	Honda	17109-ZY3-004	248	18-0468	Volvo	3853512	986
18-0397	OMC	318917	313	18-0470			Obsolete
1 18-0398	Mercury Marine	27-33918	809	18-0471			587
1 18-0398	Mercury Marine	27-8M2021920	809	18-0472-1			587
1 18-0398	OMC	312797	908	18-0474-1			587
1 18-0398	OMC	3852111	908	18-0475-1			611
1 18-0398	Volvo	835417	984	18-0476-1	Barr	01-0105	643, 899, 971
18-0401	OMC	913393	908	18-0476-1			571, 611, 782
18-0403	Mercury Marine	27-52571	802	18-0477-9	Suzuki	17472-98503	467
18-0403	Mercury Marine	27-61782	802	18-0478	Suzuki	17472-93911	467
18-0403	Mercury Marine	27-805722A1	802	18-0479	Suzuki	17472-92D10	467
18-0403	Mercury Marine	27-812712	802	18-0480	Suzuki	17472-98611	467
18-0404	Mercury Marine	27-805403A1	802	18-0481	Honda	19234-ZW1-B00	245
18-0405	Mercury Marine	27-14247	805	18-0482	Honda	19242-ZW1-B00	245
18-0405	Mercury Marine	27-883964	805	18-0483	Yamaha	63D-44316-00-00	530
18-0405	Mercury Marine	27-883964T	805	18-0487	Mercury Marine	27-824326002	806
18-0405	OMC	912955	905	18-0487	Mercury Marine	27-8243261	806
18-0405	OMC	3852655	905	18-0488	Mercury Marine	27-807473A1	806
18-0405	Volvo	3852655	985	18-0489	Volvo	876384	981
18-0406	Yamaha	60X-43315-A0-00	523	18-0491	OMC/Bombardier	346007	307
18-0407	Mercury Marine	27-56870A1	806	18-0492	OMC/Bombardier	340919	307
18-0407	Mercury Marine	27-64798	806	18-0498	Volvo	3580309	982
18-0407	OMC	508872	905	1 18-0499	Chrysler Inboard	10612	579
18-0408	Yamaha	65N-44323-00	505	18-0500	Chrysler Force	26-817472	237, 239, 442
18-0409	Yamaha	69M-G4323-00	505	18-05002			215
18-0410	Mercury Marine	27-75648	806	18-05004			215
18-0410	OMC	986103	905	18-0502	Chrysler Force	26-819396	239
18-0410	OMC	986104	905	18-0503	Chrysler Force	26-F40307-2	239
18-0410	OMC	988162	905	18-0512	Chrysler Force	26-F84307-1	239
18-0410	OMC	3853912	905	18-0514	Mercury Marine	26-25329	425
18-0410	OMC	3853913	905	18-0515	Mercury Marine	26-30530	446, 857
18-0410	OMC	3854406	905	18-0516	Mercury Marine	26-30913	446, 857
18-0410	Volvo	3853912	982	18-0517	Mercury Marine	26-32911	445, 857
18-0410	Volvo	3853913	982	18-0518	Mercury Marine	26-34217	446, 800
18-0410	Volvo	3854406	982	18-0518	Mercury Marine	26-58094	800
18-0411	Mercury Marine	27-90458	806	18-0518	Mercury Marine	26-72564	800
18-0411	Mercury Marine	27-90458A1	806	18-0518	Mercury Marine	26-75413	800
18-0411	Mercury Marine	FI5000178	806	18-0518	Mercury Marine	26-75624	800
18-0411	Mercury Marine	FI5000183	806	18-0518	OMC	914323	911
18-0411	OMC	357159	905	18-0518	OMC	3853132	911
18-0411	OMC	458625	905	18-0518	OMC	3854956	911
18-0411	OMC	508876	905	18-0518	Volvo	914323	980
1 18-0412	OMC	337068	313	18-0518	Volvo	3853132	980
1 18-0415	Chrysler Force	27-F523031	236	18-0518	Volvo	3854956	980
1 18-0416	Chrysler Force	27-F694830	236	18-0519	Mercury Marine	26-14240	446, 800, 857
1 18-0417	Chrysler Force	27-F84031	236	18-0519	Mercury Marine	FI1101300	800
18-0418	Crusader	96653	611	18-0519	OMC	3852657	904
18-0418	Mercury Marine	27-46820	643, 782	18-0519	Volvo	912957	980
18-0418	OMC	909613	909	18-0519	Volvo	3852657	980
18-0421	Yamaha	6AW-44323-00	504	18-0521	Mercury Marine	26-36557	425
18-0422	Mercury Marine	391-5076	808	18-0522	Honda	91254-ZW1-003	250
18-0430	OMC	912477	908	18-0522	Mercury Marine	26-43036	446, 857
18-0431	OMC	912471	908	18-0523	Mercury Marine	26-43993	446, 857
18-0434	OMC	909758	907	18-0525	Mercury Marine	26-45587	446, 857
18-0435	OMC	908765	907	18-0526	Mercury Marine	26-48443	446, 857
18-0437	OMC	334353	309	18-0527	Mercury Marine	26-56397	446, 857
1 18-0440	OMC	915719	909	18-0528	Mercury Marine	26-56868	800
1 18-0441	OMC	329076	313	18-0528	OMC	913745	904
1 18-0445	OMC	323312	314	18-0528	Volvo	3852805	980
18-0446	OMC	323311	314	18-0529	Mercury Marine	26-62818	446, 857
18-0448	Yamaha	6CJ-44315-00	505	18-0531	Mercury Marine	26-72785	446, 857
18-0449	Yamaha	6CJ-44316-00	505	18-0537	Mercury Marine	26-85107	446, 857
18-0450	Yamaha	6CJ-44324-00	505	18-0539	Mercury Marine	37721	425
18-0451	Yamaha	6CV-44315-00	505	18-0540	OMC	320936	315
18-0452	Yamaha	6AW-44315-00	504	18-0542	OMC	315288	347, 931
18-0453	Yamaha	65N-44315-A0	505	18-0542	OMC	321831	347, 931
18-0459	Suzuki	17472-95200	467	18-0543	OMC	313507	347, 931
18-0460	Suzuki	17472-95310	467	18-0543	OMC	321895	347, 931
18-0461	Suzuki	17472-96301	467	18-0544	Suzuki	09282-24004	472
18-0462	Mercury Marine	27-48399	808	18-0545	Suzuki	09289-10002	472

1 This product is priced per piece. To order, priced per package, please add -9 to the part number

2 Items ending in "D" are display packaged - regular number is non-display

3 For discount shop pack of 10, please add -10 to the part number

SIERRA #	O.E.M.	O.E. #	PAGE #	SIERRA #	O.E.M.	O.E. #	PAGE #	
SIERRA								
18-0546	Suzuki	09282-30007	472	18-0648			973	
18-0548	OMC	909515	909	18-0649	Mercury Marine	27-858935	422	
18-0549	OMC	909829	910	18-0650	Suzuki	56132-95J00	470	
18-0549	Volvo	3852476	911	18-0651	Suzuki	17472-98J00	470	
18-0550	OMC	909830	911	18-0652	OMC	914723	924	
18-05500			215	18-0653	OMC	308825	924	
18-05504			215	18-0654	OMC	914743	924	
18-0551	Suzuki	09283-10011	472	18-0655	OMC	914736	924	
18-0554	Mercury Marine	26-84813M	446	18-0656	Yamaha	69J-45123-00-00	523	
18-0554	Yamaha	93101-20M07-00	550	18-0663			412, 521	
18-0557	Mercury Marine	888909A1	433	18-0664	Mercury Marine	27-17467	810	
18-0558	Volvo	851407	993	18-0664	Mercury Marine	F11101287	810	
18-0559	OMC	332585	347, 931	18-0664	OMC	913270	909	
18-0560	Mercury Marine	26-896600	446	18-0664	OMC	3852687	909	
18-0563	Mercury Marine	26-36556	425, 855	18-0664	Volvo	3852687	985	
18-0564	Mercury Marine	26-888483	446	1	18-0665		616	
18-0568-9	Mercury Marine	23-43045	425	1	18-0667	Mercury Marine	27-99506	
18-0569	Suzuki	09284-08003	472	1	18-0667	Mercury Marine	27-995061	
18-0570	Yamaha	93102-23096-00	550	18-0670	Mercury Marine	27-43007	422	
18-0577	Mercury Marine	35993A1	832	18-0670	Mercury Marine	27-430073	422	
18-0577	Mercury Marine	66081A1	832	18-0670	Mercury Marine	27-430075	422	
18-0577	Mercury Marine	66081A2	832	1	18-0672	Mercury Marine	27-41811	
18-0577	Mercury Marine	66081A4	832	1	18-0672	Mercury Marine	27-860231	
18-0578	Mercury Marine	26-67388	800, 857	1	18-0672	Mercury Marine	27-863725	
18-0579	Chrysler Force	26-41131	239	1	18-0672	Mercury Marine	27-8637251	
18-0579	Mercury Marine	26-41131	446	1	18-0673	OMC	910113	
18-0580	Chrysler Force	26-41132	239	18-0675	OMC	321932	313	
18-0580	Mercury Marine	26-41132	446	18-0676-1	Pleasurecraft	RM0099	631	
18-0581	Mercury Marine	26-41365	446	1	18-0677-1	Pleasurecraft	RM0002	
18-0583	Chrysler Force	26-43035	239	18-0679	OMC	311145	314	
18-0583	Honda	91251-ZW1-003	250	18-0680	Mercury Marine	27-815528	810	
18-0583	Mercury Marine	26-43035	446	18-0680	OMC	3853256	909	
18-0584	Chrysler Force	26-66022	239	1	18-0681	Mercury Marine	12-32834	
18-0584	Chrysler Force	26-F346118	239	1	18-0681	Mercury Marine	12-8M2001219	
18-0584	Mercury Marine	26-66022	446	1	18-0681	Mercury Marine	12-93416	
18-0585	Mercury Marine	26-821928	446	1	18-0681	Mercury Marine	12-934161	
18-0586	Chrysler Force	26-99325	239	18-0685	Mercury Marine	27-73666	807	
18-0586	Mercury Marine	26-99325	446	18-0690	OMC/Bombardier	347205	312	
18-0587	Yamaha	93101-25M03-00	550	18-0691	OMC/Bombardier		312	
18-0588	Yamaha	93102-25M28-00	550	18-0692	OMC/Bombardier	339601	312	
18-0590			973	18-0693	OMC/Bombardier	336227	312	
18-0592	Chrysler Force	26-F318307	239	18-0694	OMC/Bombardier	336226	312	
18-0593	Chrysler Force	26-F901307-2	239	18-0695	OMC/Bombardier	336389	312	
18-0595	Mercury Marine	26-66303	446	18-0696	OMC/Bombardier	336388	312	
18-0601			610	18-0707	Yamaha	6CB-13016-00	486	
18-0602			610	18-0710	Yamaha	68V-14984-00	485	
18-0603			570, 611, 616, 631, 643, 782, 802, 900	18-0711	Yamaha	66K-14984-00	485	
18-0604			570, 611, 616, 631, 643, 782, 802, 900	18-0712	Yamaha	63P-14984-00	485	
18-0605	Yamaha	67F-41138-00-00	523	18-0713	Yamaha	6P2-14984-00	485	
18-0606			973	18-0714	Yamaha	6AW-14984-00	485	
18-0607	Chrysler Inboard	3745217	587	18-0715	Mercury Marine	25-809086	378	
18-0609	Chrysler Inboard	4273129	579	18-0715	Yamaha	65L-14984-00	486	
18-0611	Mercury Marine	27-75483	806	18-0716	Yamaha	6CB-14984-00	486	
18-0612	Mercury Marine	14259	790	18-0717	Yamaha	6C5-14984-00	486	
18-0612	Mercury Marine	809910	790	18-0720	Mercuriuser	27-864549A02	783	
18-0612	Mercury Marine	F11101295	790	18-0720	Mercuriuser	27-864549A1	783	
18-0613	Mercury Marine	93476	790	18-0721	Mercuriuser	27-864547A1	783	
18-0614	Mercury Marine	811549	790	18-0722	Mercuriuser	27-864547A1	783	
18-0614	Mercury Marine	850458	790	18-0722	Mercuriuser	27-864850A02	783	
18-0614	Mercury Marine	845668T	790	18-0727	Mercuriuser	16176-POA-004	248	
18-0615	Mercury Marine	14760	790	18-0737	Honda	16176-POA-004	248	
18-0615	Mercury Marine	75639	790	18-0739	Yamaha	689-45113-A1-00	530	
18-0615	Mercury Marine	93477	790	18-0740	Mercury Marine	27-805396	S/S to 18-0740-1	
18-0615	Mercury Marine	93477T	790	18-0740-1	Mercury Marine	27-805396	420	
18-0616	Mercury Marine	14244	790	18-0743	Yamaha	6L2-41112-A1-00	530	
18-0616	Mercury Marine	14244T	790	18-0744	Yamaha	6L2-41114-A1-00	530	
18-0617	Yamaha	67F-45127-00-00	523	18-0753	Yamaha	6G1-44315-A0-00	530	
18-0618	Yamaha	68V-45123-00-00	523	18-0754	Yamaha	68D-E2414-A0-00	530	
18-0619	Yamaha	69J-41138-00-00	523	18-0755	Yamaha	90430-14228-00	523	
18-0622	Chrysler Force	27-19701	236	18-0755	Yamaha	90430-14M09-00	523	
18-0622	Mercury Marine	27-19701	424	18-0755	Yamaha	90430-14M09-00	523	
18-0624	Mercury Marine	27-188891	420	18-0756-1	Yamaha	6H3-44315-A0-00	531	
18-0628	OMC	341501	309	18-0757	Yamaha	6H3-44324-A0-00	532	
1	18-0633	Mercury Marine	27-19206	419	18-0761	Suzuki	17472-91J00	467
1	18-0633	Mercury Marine	27-192061	419	18-0765	Yamaha	6L2-14384-00-00	529
1	18-0633	Mercury Marine	27-41449	419	18-0767	Yamaha	688-11193-01-00	530
1	18-0633	Mercury Marine	27-414491	419	1	18-0768	Yamaha	682-44315-A0-00
1	18-0633	Mercury Marine	27-42178	419	1	18-0775	Yamaha	648-14198-A0-00
1	18-0641	Mercury Marine	27-828292	419	18-0778	Suzuki	17472-93J00	467
18-0642	Mercury Marine	27-19050	421	18-0779	Yamaha	6G5-11193-A0-00	530	
18-0642	Mercury Marine	27-190502	421	18-0781	Yamaha	6E5-11193-A0-00	530	
18-0642	Mercury Marine	27-190503	421	18-0782	Yamaha	6E5-11381-A1-00	530	
18-0642	Mercury Marine	27-190505	421	18-0785	Yamaha	6E5-14198-A1-00	529	
18-0643	Mercury Marine	27-18307-1	422	18-0786	Yamaha	6E5-14384-02-00	529	
18-0643	Mercury Marine	27-183076	422	18-0791	Mercury Marine	27-880729	422	
18-0644	Mercury Marine	27-146972	420	18-0792	Suzuki	13119-91J00	467	
18-0645	Mercury Marine	27-167371	420	18-0793	Suzuki	17582-93J00	467	
18-0646	Mercury Marine	27-813859	420	18-0794	Suzuki	17685-97J00	467	
18-0647	OMC	986658	924	18-0795	Suzuki	17685-98J00	467	
				18-0796	Suzuki	17685-99E00	467	
				18-0797	Suzuki	17685-87D10	467	

1 This product is priced per piece. To order, priced per package, please add -9 to the part number
 2 Items ending in "D" are display packaged - regular number is non-display
 3 For discount shop pack of 10, please add -10 to the part number

SIERRA #	O.E.M.	O.E. #	PAGE #	SIERRA #	O.E.M.	O.E. #	PAGE #
SIERRA							
18-0798	Yamaha	6H4-41114-A0-00	530	1 18-0889	Yamaha	YSG-10114-14-1G	995
18-0799	Yamaha	6E5-41112-A1-00	530	1 18-0891	Chris-Craft	16.50-00078	571
18-0807-1	Yamaha	6K7-13645-A1-00	529	1 18-0891	Mercury Marine	27-34896	811
18-0808	Yamaha	6G5-11382-A1-00	529	1 18-0891	Mercury Marine	27-34897	811
18-0809	Yamaha	6G5-13645-A1-00	529	1 18-0891	Mercury Marine	FI5000077	811
18-0812	Yamaha	6G5-41112-A1-00	530	1 18-0891	Mercury Marine	FI5000078	811
18-0813	Yamaha	6G5-45113-A0-00	530	1 18-0891	OMC	909835	910
18-0815	Yamaha	6H4-11193-A1-00	530	1 18-0891	OMC	3852477	910
18-0823	Yamaha	6E5-13645-A1-00	530	1 18-0891	Volvo	3852477	985
18-0826	Yamaha	90430-14115-00	532	1 18-0891	Yamaha	YSG-37545-87-G0	995
18-0829	Yamaha	61A-12414-A0-00	530	1 18-0892	OMC	322411	313, 909
18-0829	Yamaha	6J8-12414-A0-00	530	1 18-0893	Mercury Marine	27-35380	811
18-0835	Mercury Marine	27-824853	423	1 18-0893	OMC	3850595	910
18-0835	Mercury Marine	27-8248531	423	1 18-0893	Volvo	3850595	986
18-0835	Yamaha	62Y-12414-00-00	530	1 18-0894	Mercury Marine	27-55810	811
18-0836	Yamaha	682-12414-A1-00	530	1 18-0894	Mercury Marine	27-558101	811
18-0840-1	Yamaha	676-14984-00-00	529	1 18-0897	Mercury Marine	27-41813	782, 809
18-0844	Yamaha	688-12414-A1-00	530	1 18-0897	Mercury Marine	27-860233	782
18-0847	Yamaha	688-41112-A0-00	530	1 18-0897	Mercury Marine	27-863724	782
18-0849	Yamaha	650-24431-00	523	1 18-0898	Mercury Marine	27-56859	812
18-0849	Yamaha	650-24431-A0-00	523	1 18-0898	Pleasurecraft	RM0017	631
1 18-0850	OMC	303615	309	1 18-09002			215
1 18-0851	OMC	329826	314	1 18-09006			215
1 18-0854	Chrysler Force	27-F476067	236	1 18-0903	Mercury Marine	27-49110	811
1 18-0855	Chrysler Force	27-F85168-2	235	1 18-0903	Mercury Marine	FI1101000	811
1 18-0856	Yamaha	64D-14384-01-00	S/S to 18-0856-1	1 18-0903	OMC	3853361	909
1 18-0856-1	Yamaha	64D-14384-01-00	523	1 18-0903	Volvo	3853361	985
1 18-0858	Mercury Marine	25-54029	449, 858	1 18-0903	Yamaha	YSG-38600-39-G0	995
1 18-0860	Mercury Marine	25-62700	449, 858	1 18-0904	Mercury Marine	27-60317	422
18-0861	Chrysler Force	27-F85748-2	235	1 18-0905	Mercury Marine	27-34502	813
18-0864	Mercury Marine	26-90925	800	1 18-0905	Mercury Marine	27-49955	813
18-0864	Mercury Marine	27-67389	800	1 18-0905	Mercury Marine	27-60721	813
18-0868	Chris-Craft	16.50-00232	571	1 18-0905	Mercury Marine	27-8M0077608	813
18-0868	Mercury Marine	27-17145	806	1 18-0905	Yamaha	YSG-14090-90-8G	995
18-0868	Mercury Marine	27-72637	806	1 18-0907			973
18-0868	Mercury Marine	FI1101296	806	1 18-0911	OMC	911698	909
18-0868	Mercury Marine	FI5000232	806	1 18-0912	Mercury Marine	27-60945	423
18-0868	Mercury Marine	FI5000263	806	1 18-0912	Mercury Marine	27-66102	423
18-0868	OMC	985630	905	1 18-0912	Mercury Marine	27-661021	423
18-0868	OMC	3854269	905	1 18-0914	Mercury Marine	27-66847	423
18-0868	Volvo	3854269	982	1 18-0915	Chrysler Force	27-F406406	235
1 18-0869	Chrysler Force	27-820500A3	235	1 18-0916	Mercury Marine	27-72779	811
1 18-0869	Chrysler Force	27-F40223	235	1 18-0916	Mercury Marine	27-805215	811
18-0870	Mercury Marine	27-27936	421	1 18-0916	Mercury Marine	27-8052151	811
18-0870	Mercury Marine	27-279361	421	1 18-0916	Mercury Marine	27-94915	811
18-0871	OMC	175158	268	1 18-0917	OMC	311508	315
1 18-0873	Chrysler Force	27-819377	236	1 18-0918	Mercury Marine	27-69524	420
1 18-0873	Chrysler Force	27-F97067	236	1 18-0918	Mercury Marine	27-695241	420
1 18-0874	Chris-Craft	16.50-00162	571	1 18-0918	Mercury Marine	27-695242	420
1 18-0874	Mercury Marine	27-34486	808	1 18-09200			215
1 18-0874	Mercury Marine	27-344861	808	1 18-09202			215
1 18-0874	Mercury Marine	27-344863	808	1 18-0922	Mercury Marine	27-70335	421
1 18-0874	Mercury Marine	27-34891	808	1 18-0922	Mercury Marine	27-703351	421
1 18-0874	Mercury Marine	27-52184	808	1 18-0923	OMC	313244	911
1 18-0874	Mercury Marine	F3932344	808	1 18-0926	Mercury Marine	27-73645	421
1 18-0874	Mercury Marine	FI5000162	808	1 18-0927	OMC	393561	311
1 18-0874	OMC	312780	907	1 18-0928-1	Mercury Marine	27-73814	809
1 18-0874	OMC	3852109	907	1 18-0928-1	Mercury Marine	27-738141	809
1 18-0874	Volvo	3852109	987	1 18-0928-1	Mercury Marine	27-807218	809
1 18-0874	Yamaha	YSG-10108-44-5G	995	1 18-0929	OMC	313416	313, 907
1 18-0875			612, 631	1 18-0929	Volvo	3852120	974
1 18-0876	Chris-Craft	16.50-05756	571	1 18-0932	Mercury Marine	27-76862	421
1 18-0876	Mercury Marine	27-34898	807	1 18-0932	Mercury Marine	27-768621	421
1 18-0876	Mercury Marine	FI5005756	807	1 18-0933	OMC	314115	310
1 18-0876	OMC	312800	907	1 18-0934-1	Mercury Marine	27-78069	423
1 18-0876	OMC	3852113	907	1 18-0935	OMC	314322	310
1 18-0876	Volvo	3852113	984	1 18-0936	Mercury Marine	27-78690	423
1 18-0876	Yamaha	YSG-10108-43-8G	995	1 18-0937	OMC	315055	907
18-0878	Pleasurecraft	RM0003	631	1 18-0939	OMC	315189	910
18-0879	Mercury Marine	27-37724	422	1 18-0940	Mercury Marine	27-55308	421
18-0879	Mercury Marine	27-38501	422	1 18-0940	Mercury Marine	27-78027	421
18-0879	Mercury Marine	27-385011	422	1 18-0940	Mercury Marine	27-85488	421
1 18-0880	OMC	911878	910	1 18-0940	Mercury Marine	27-854881	421
18-0881-1	Mercury Marine	27-18272	782	1 18-0940	Mercury Marine	27-854882	421
18-0881-1	Mercury Marine	27-97863	782	1 18-09400			215
1 18-0882	OMC	304764	314	1 18-0941	OMC	315538	313
1 18-0885-1	Mercury Marine	27-48042	782	1 18-0942	Mercury Marine	27-46110	421
1 18-0887	Mercury Marine	27-34216	810	1 18-0942	Mercury Marine	27-72486	421
1 18-0887	Mercury Marine	27-49953	810	1 18-0942	Mercury Marine	27-85491	421
1 18-0887	Mercury Marine	FI5000201	810	1 18-0942	Mercury Marine	27-854911	421
1 18-0887	OMC	912988	910	1 18-0942	Mercury Marine	27-85491-2	421
1 18-0887	OMC	913275	910	1 18-0942	Mercury Marine	27-854913	421
1 18-0887	OMC	3852691	910	1 18-0943-2	OMC	909786	899, 908
1 18-0887	Volvo	3852691	986	1 18-0943-2	OMC	913783	908
1 18-0887	Yamaha	YSG-14096-15-6G	995	1 18-0943-2	OMC	3850496	899, 908
1 18-0889	Chris-Craft	16.50-00074	571	1 18-0943-2	Volvo	3850496	970
1 18-0889	Mercury Marine	27-34213	807	1 18-0943-2-9	OMC	913783	908
1 18-0889	Mercury Marine	27-56883	807	1 18-0943-2-9	Volvo	3850496	970
1 18-0889	Mercury Marine	FI5000074	807	1 18-0944	Mercury Marine	27-64204	421
1 18-0889	Pleasurecraft	3705042	631	1 18-0944	Mercury Marine	27-72508	421
1 18-0889	Volvo	3852095	984	1 18-0944	Mercury Marine	27-85496	421

1 This product is priced per piece. To order, priced per package, please add -9 to the part number
 2 Items ending in "D" are display packaged - regular number is non-display
 3 For discount shop pack of 10, please add -10 to the part number

SIERRA #	O.E.M.	O.E. #	PAGE #	SIERRA #	O.E.M.	O.E. #	PAGE #
SIERRA							
18-0944	Mercury Marine	27-854961	421	18-1120	Mercury Marine	31-35246	843
18-0945	OMC	323217	311	18-1122	Mercury Marine	31-73363	432
18-0945	OMC	336430	311	18-1122	Mercury Marine	31-73363T	432
18-0946	Mercury Marine	27-85653	421	18-1126	Mercury Marine	31-54036A1	433
18-0946	Mercury Marine	27-85653-1	421	18-1126	Mercury Marine	31-8M0103474	844
18-0946	Mercury Marine	27-856730	421	18-1127	Mercury Marine	31-54038A1	844
1 18-0947	OMC	909529	909	18-1129	Mercury Marine	31-86748A1	844
1 18-0948	Mercury Marine	27-87707	808	18-1129	Mercury Marine	31-8M0103473	844
1 18-0949	OMC	316499	315	18-1129	Mercury Marine	31-F506818	844
18-0950	Mercury Marine	27-88046	812	18-1129	Mercury Marine	F508814	844
18-0951	OMC	317305	310	18-1131	Mercury Marine	74313A4	795
1 18-0952	Mercury Marine	27-88907	423	18-1137	Mercury Marine	15103A3	795
1 18-0953	OMC	317951	314	18-1142	Mercury Marine	31-32573A1	843
18-0954	Mercury Marine	27-92720	809	18-1143	Mercury Marine	31-36387A1	432, 844
18-0955	OMC	318156	311	18-1144	Mercury Marine	31-48939A2	432
18-0956-1	Chrysler Inboard	118-614	587	18-1148	Mercury Marine	23-853853	795
18-0956-1	Mercury Marine	27-68715	810	18-1148	Mercury Marine	23-853853002	795
18-0956-1	OMC	912405	908	18-1148	Mercury Marine	23-853853A1	795
18-0957	OMC	318373	312	18-1148	Mercury Marine	68704A1	795
18-0958	Chrysler Force	27-F372154-1	235	18-1150	Mercury Marine	31-92366	844
1 18-0959	OMC	318924	310	18-1150	Mercury Marine	31-92366A1	844
1 18-0960	Chrysler Force	27-F85906	235	18-1151	Mercury Marine	30-20066	359
18-09602			215	18-1152	Mercury Marine	30-23679	359
18-09606			215	18-1153	Mercury Marine	30-20464	406, 432, 845
1 18-0961	OMC	318932	309	18-1153	Mercury Marine	30-49313	406, 432, 845
1 18-0963	OMC	335633	310	18-1153	Mercury Marine	30-54215	406, 432, 845
1 18-0965	OMC	333879	312	18-1153	Mercury Marine	30-63326	406, 432, 845
1 18-0967	OMC	319332	313	18-1153	Mercury Marine	30-63326T	406, 432, 845
1 18-0969	OMC	319586	314	18-1154	Mercury Marine	30-63742	406, 432
1 18-0970	Mercury Marine	27-98769	420	18-1154	Mercury Marine	30-63742T	432
1 18-0970	Mercury Marine	27-987691	420	18-1154	OMC	377139	920
1 18-0971	OMC	319661	313	18-1155	Mercury Marine	30-17927	432, 845
1 18-0973	OMC	315052	311	18-1155	Mercury Marine	30-35914	432, 845
1 18-0975	OMC	333008	310	18-1155	Mercury Marine	30-88957	432, 845
1 18-0976	Crusader	20129	612	18-1155	Mercury Marine	30-88957A1	432, 845
1 18-0976	Mercury Marine	27-14250	810	18-1155	Mercury Marine	30-88957T	432, 845
1 18-0976	Mercury Marine	27-34895	810	18-1156	Honda	91051-ZW1-003	249
1 18-0976	Mercury Marine	F11101297	810	18-1156	Mercury Marine	31-30894A1	432, 844
1 18-0977	OMC	332369	313	18-1157	Honda	91057-ZW1-003	249
18-0978	OMC	331598	310	18-1157	Mercury Marine	31-30895	432, 844
18-0979	OMC	321183	310	18-1157	Mercury Marine	31-30895T	432, 844
18-0980	Mercury Marine	110990	810	18-1158	Honda	91053-ZW1-003	249
18-0980	Mercury Marine	1100990	810	18-1158	Mercury Marine	31-30956	432, 845
18-0980	Mercury Marine	27-49109	810	18-1158	Mercury Marine	31-30956T	432, 845
18-0980	Mercury Marine	27-54529	810	18-1158	Mercury Marine	31-F523058	432, 845
18-0980	OMC	3935449	910	18-1158	OMC	387247	332, 920
1 18-0981	OMC	321479	311	18-1159	Mercury Marine	31-35928A1	432
18-0982-1	Mercury Marine	27-48713	423	18-1159	Mercury Marine	31-35928T1	432
18-0982-1	Mercury Marine	27-56304	423	18-1160	Mercury Marine	31-35988A12	845
1 18-0983	OMC	321497	310	18-1160	Mercury Marine	31-35988A2	845
18-0985	OMC	321722	310	18-1161	Mercury Marine	31-35990A1	844
1 18-0987	OMC	332319	311	18-1161	OMC	983891	332, 920
18-0988	Mercury Marine	27-37976	423	18-1162	Mercury Marine	31-38356A1	433, 844
18-0988	Mercury Marine	27-62860	423	18-1162	Mercury Marine	31-F84901	433, 844
18-0988	Mercury Marine	27-628601	423	18-1162	Mercury Marine	F84903	433, 844
18-0989	OMC	321794	310	18-1162	Mercury Marine	FA84901	433, 844
1 18-0991	OMC	321907	311	18-1163	Mercury Marine	31-48941A1	433, 844
18-0993	OMC	437228	268	18-1165	Mercury Marine	31-61100A1	844
1 18-0994	Mercury Marine	27-70143	808	18-1166	Mercury Marine	31-78172A1	433
1 18-0994	Mercury Marine	27-701431	808	18-1170	Mercury Marine	31-812767A1	433
1 18-0994	Mercury Marine	27-70143B1	808	18-1170	OMC	983892	920
1 18-0994	Mercury Marine	27-807982	808	18-1171	OMC	983878	920
1 18-0994	Mercury Marine	27-8079821	808	18-1172	OMC	983877	920
1 18-0994	Mercury Marine	27-807982B	808	18-1173	Mercury Marine	31-828437A2	844
18-0995	OMC	323222	312	18-1175			58
18-0999-9	OMC	323459	311	18-1176			58
18-1074	OMC	3850426	919	18-1177			58
18-1074	Volvo	3850426	988	18-1178			58
18-1076	Volvo	3888916	992	18-1179	Mercury Marine	31-32575A1	844
18-1079	Yamaha	6GD-G4325-00-00	532	18-1179	Mercury Marine	31-32575T1	844
18-1099	OMC	982422	924	18-1180	Mercury Marine	31-54042T	844
18-1100			58	18-1182	Mercury Marine	31-30894A5	844
18-1105			58	18-1186	Mercury Marine	12-88263	406
18-1106			58	18-1186	Mercury Marine	29-88258	406
18-1107			58	18-1189	Mercury Marine	31-815480	Obsolete
18-1109			58	18-1190	Mercury Marine	30-20839	432
18-1110			58	18-1190	Mercury Marine	30-20839T	432
18-1111	Mercury Marine	31-62799A1	432	18-1190	Mercury Marine	30-62699	432
18-1112	Chrysler/Force	31-F523901	239	18-1190	Mercury Marine	FI000034	432
18-1112	Mercury Marine	31-12576	432	18-1191	Mercury Marine	12-12577	432
18-1113	Chrysler/Force	31-F523143	239	18-1193	Mercury Marine	31-33138A1	844
18-1113	Mercury Marine	31-12578	432	18-1194	Mercury Marine	879366	406
18-1113	Mercury Marine	31-12578T	432	18-1194	Mercury Marine	31-17514	406
18-1115	Mercury Marine	31-29982	432	18-1194	Mercury Marine	31-17514A1	406
18-1115	Mercury Marine	31-32898	432	18-1194	Mercury Marine	31-17514A2	406
18-1115	Mercury Marine	31-32898T	432	18-1194	Mercury Marine	31-67526	406
18-1117	Mercury Marine	31-42647	432	18-1194	Mercury Marine	31-67526A1	406
18-1117	Mercury Marine	31-42647A1	432, 843	18-1194	Mercury Marine	31-67526A2	406
18-1117	Mercury Marine	31-F694057	432	18-1194	Mercury Marine	31-814337A1	406
18-1117	OMC	387817	920	18-1194	Mercury Marine	31-821146A1	406
18-1118	Mercury Marine	31-42677A1	432	18-1194	Mercury Marine	31-8M0045428	406

1 This product is priced per piece. To order, priced per package, please add -9 to the part number

2 Items ending in "D" are display packaged - regular number is non-display

3 For discount shop pack of 10, please add -10 to the part number

SIERRA #	O.E.M.	O.E. #	PAGE #	SIERRA #	O.E.M.	O.E. #	PAGE #
SIERRA							
18-1194	Mercury Marine	31-M8004528	406	18-1267			655, 656, 657
18-1195	Mercury Marine	31-43012A1	406	18-1268			655, 657
18-1196	Mercury Marine	31-74248	406	18-1270			654
18-1196	Mercury Marine	31-74248T	406	18-1271			653
18-1197	Mercury Marine	31-828439A2	432, 844	18-1273			659
1	18-1199		58	18-1274			653
1	18-1199		58	18-1275			654
1	18-1202	OMC	329830	18-1276			653
	18-1204-1	Mercury Marine	27-96429	782, 810	18-1277		653
	18-1204-1	OMC	912164	909	18-1278		654
	18-1204-1-9	Mercury Marine	27-96429	782, 810	18-1279	OMC	317624
	18-1204-1-9	OMC	912164	909	18-1282	OMC	398602
	18-1205	OMC	329828	312	18-1283	OMC	335818
	18-1206		653	18-1284	OMC	335819	312
	18-1207	OMC	329833	311	18-1285	OMC	335403
	18-1207	OMC	343863	311	18-1286	OMC	336232
	18-1210	Mercury Marine	27-39923	S/S to 18-1210-1	18-1287	OMC	392475
1	18-1210-1	Mercury Marine	27-39923	782, 809	18-1288	OMC	328313
	18-1211	Mercury Marine	26-49947	800	18-1289	OMC	327655
	18-1211	Mercury Marine	26-58203	800	18-1290	OMC	337020
	18-1211	Mercury Marine	26-814622	800	18-1291		336
	18-1211	Mercury Marine	F1110026	800	18-1292		336
	18-1211	Mercury Marine	F1110027	800	18-1293		336
	18-1211	Mercury Marine	F1110041	800	18-1294	Sea-Do	278-002-199
	18-1211	OMC	473424	904	18-1296	OMC	386014
	18-1211		980	18-1299	OMC	433503	Obsolete
	18-1212	OMC	326926	311	18-1300	Mercury Marine	23-15960
	18-1213	Mer cruiser	26-11973	800	18-1300	Mercury Marine	23-52211
	18-1213	Mer cruiser	26-42750	800	18-1300	Mercury Marine	23-818465
	18-1213	Mer cruiser	26-54799	800	18-1300	Mercury Marine	23-85698
	18-1213	Mer cruiser	26-97335	800	18-1300	Mercury Marine	F724073
	18-1213	OMC	912989	904	18-1300		904, 980
	18-1213	OMC	914817	904	18-1305	Mercury Marine	23-85684
	18-1213	OMC	3853341	904	18-1308	Mercury Marine	23-15961
	18-1213	Volvo	3853341	980	18-1308	Mercury Marine	23-52221
	18-1218	OMC	315868	311	18-1308	Mercury Marine	23-52270
	18-1219	OMC	320880	315	18-1308	Mercury Marine	23-85701
1	18-1221	OMC	330273	315	18-1308	Mercury Marine	F3910555
	18-1222	OMC	394408	289	18-1308	Mercury Marine	F3916351
	18-1224	OMC	315869	311	18-1308	Mercury Marine	F11100305
	18-1230	Mercury Marine	26-56866	800	18-1308	Mercury Marine	F11100570
	18-1230	OMC	3853827	904	18-1308		904, 980
	18-1230	Volvo	3853827	980	18-1309	Mercury Marine	23-1596110
	18-1231	Mercury Marine	27-818188	805	18-1309	Mercury Marine	23-52224
	18-1231	Mercury Marine	27-8181881	805	18-1309	Mercury Marine	23-52273
	18-1231	OMC	3854095	905	18-1309	Mercury Marine	23-85704
	18-1231	Volvo	3854095	984	18-1309	Mercury Marine	F11100381
	18-1232	Mercury Marine	27-845628	805	18-1309	Mercury Marine	F11100573
	18-1232	Mercury Marine	27-811566	805	18-1309		904, 980
	18-1232	OMC	3853510	905	18-1311	Mercury Marine	23-801793
	18-1232	Volvo	3853510	985	18-1311		904, 980
	18-1233	Mercury Marine	26-49154	800	18-1314	Mercury Marine	23-818477
	18-1233	Mercury Marine	26-821947	800	18-1315	Mercury Marine	23-49163
	18-1233	Mercury Marine	26-8219471	800	18-1315	Mercury Marine	23-818473
	18-1233	Mercury Marine	F11100986	800	18-1315	Mercury Marine	23-818473001
	18-1233	OMC	3860095	904	18-1315	Mercury Marine	23-85686
	18-1234	Mercury Marine	24-17057A1	800	18-1315	Mercury Marine	F347013
	18-1234	Mercury Marine	24-801879	800	18-1315	Mercury Marine	F11100912
	18-1234	Mercury Marine	24-801879T	800	18-1315	Mercury Marine	F11101293
	18-1234	Mercury Marine	24-811554	800	18-1315		Obsolete
	18-1234	OMC	3853528	904	18-1316	Mercury Marine	23-52264
	18-1234	Volvo	3853528	980	18-1316	Mercury Marine	23-818471
	18-1236	OMC	309243	328, 911	18-1316	Mercury Marine	23-818471001
	18-1237	Mercury Marine	27-13865	805	18-1316	Mercury Marine	23-85718
	18-1237	Mercury Marine	27-138651	805	18-1316	Mercury Marine	F3829064
	18-1237	Mercury Marine	F11101281	805	18-1316	Mercury Marine	F11100853
	18-1237	OMC	3856138	905	18-1317	Mercury Marine	23-34464
	18-1237	Volvo	3856138	985	18-1317	Mercury Marine	23-52261
	18-1238	Mercury Marine	27-824326	805	18-1317	Mercury Marine	23-818469
	18-1238	OMC	912979	905	18-1317	Mercury Marine	23-818469001
	18-1238	OMC	3850379	905	18-1317	Mercury Marine	23-85669
	18-1238	Volvo	912979	971	18-1317	Mercury Marine	23-85715
	18-1238	Volvo	3850379	971	18-1317		904, 980
	18-1239	Mercury Marine	27-810846	805	18-1320	Mercury Marine	23-801803
	18-1239	Mercury Marine	27-810846T	805	18-1321	Mercury Marine	23-801801
	18-1239	OMC	914820	905	18-1327	Mercury Marine	23-11992
	18-1239	Volvo	3853343	985	18-1327	Mercury Marine	23-11992001
	18-1240	Mercury Marine	12708	811	18-1327		904, 980
	18-1241		309	18-1329	Mercury Marine	23-48351	795
	18-1243	OMC	317245	288	18-1329	Mercury Marine	23-52242
	18-1254	Mer cruiser	27-75611A03	804	18-1329	Mercury Marine	23-85677
	18-1255		654	18-1333	Mercury Marine	23-49171	795
	18-1256		657	18-1333	Mercury Marine	23-69887	795
	18-1257		657	18-1333	Mercury Marine	23-85691	795
	18-1258		658	18-1333			904, 980
	18-1259		658	18-1334	Mercury Marine	23-49168	795
	18-1261		658	18-1334	Mercury Marine	23-69884	795
	18-1263		656, 657	18-1334	Mercury Marine	23-85726	795
	18-1264		654	18-1334	Mercury Marine	23-85726001	795
	18-1265		655	18-1334	Mercury Marine	F11100980	795
	18-1266		655, 656	18-1334			904, 980

1 This product is priced per piece. To order, priced per package, please add -9 to the part number
 2 Items ending in "D" are display packaged - regular number is non-display
 3 For discount shop pack of 10, please add -10 to the part number

SIERRA #	O.E.M.	O.E. #	PAGE #	SIERRA #	O.E.M.	O.E. #	PAGE #
SIERRA							
18-1337	Mercury Marine	23-811858	795	18-1478	Volvo	1218674	976
18-1337	Mercury Marine	23-811858001	795	18-1479	Volvo	461511	976
18-1337			904, 980	18-1500	OMC	337778	337, 924
18-1339	Mercury Marine	23-43293	795	18-1501	OMC	160084	921
18-1339	Mercury Marine	23-43293T	795	18-1501	Volvo	3852023	990
18-1339	Mercury Marine	F3750884	795	18-1505	OMC	318940	316
18-1339	Mercury Marine	FI1101007	795	18-1506	OMC	394411	289
18-1339			904, 980	18-15061	Honda	31200-ZW1-004	241
18-1340	Mercury Marine	23-67484	795	18-1507	OMC	335981	289
18-1341	Mercury Marine	23-1596120	795	18-1508	Mercury Marine	25-8071341	741
18-1341	Mercury Marine	23-52225	795	18-15080	Polaris	3240120	552
18-1341	Mercury Marine	23-52274	795	18-15080	Yamaha	6M6-8183E00-00	552
18-1341	Mercury Marine	23-85705	795	18-15100	Mercury Marine	57-862087A1	762
18-1341	Mercury Marine	FI1100382	795	18-15100	Mercury Marine	57-862807	762
18-1341			904, 980	18-15100	Mercury Marine	57-8638763	762
18-1343	OMC	333957	337, 924	18-15100	Mercury Marine	57-865615003	762
18-1344			332	18-15100	Mercury Marine	57-865615Q03	762
18-1345	Mercury Marine	30-41421	406	18-15101	Mercury Marine	57-862086	762
18-1345	Mercury Marine	30-67923	406	18-15101	Mercury Marine	57-8620861	762
18-1345	Mercury Marine	30-67923T	406	18-15101	Mercury Marine	57-862086A1	762
18-1346	Mercury Marine	30-43011	407	18-15101	Mercury Marine	57-8638764	762
18-1346	Mercury Marine	30-43011T	407	18-15101	Mercury Marine	57-865615004	762
18-1347	Mercury Marine	31-88269T	432	18-15101	Mercury Marine	57-865615Q04	762
18-1350	OMC	379504	332, 920	18-15102	Mercury Marine	57-8610491	762
18-1351	OMC	382407	332, 920	18-15102	Mercury Marine	57-8638766	762
18-1353	OMC	387041	295	18-15102	Mercury Marine	57-865615006	762
18-1354	OMC	386764	332	18-15102	Mercury Marine	57-865615Q06	762
18-1355	OMC	386765	332	18-15103	Mercury Marine	57-861050	762
18-1356	Mercury Marine	31-54928	843	18-15103	Mercury Marine	57-8638767	762
18-1356	OMC	382343	332	18-15103	Mercury Marine	57-865615007	762
18-1357	OMC	384195	332	18-15103	Mercury Marine	57-865615Q07	762
18-1358	OMC	389039	920	18-15104	Mercury Marine	57-862089	762
18-1360	OMC	396041	295	18-15104	Mercury Marine	57-862089A1	762
18-1361	OMC	387787	295	18-15104	Mercury Marine	57-8638768	762
18-1363	OMC	397537	332	18-15104	Mercury Marine	57-865615008	762
18-1364	OMC	397538	332	18-15104	Mercury Marine	57-865615Q08	762
18-1365	OMC	387656	332, 920	18-15105	Mercury Marine	57-862088	762
18-1366	OMC	382408	332, 920	18-15105	Mercury Marine	57-862088A1	762
18-1367	OMC	385068	332	18-15105	Mercury Marine	57-8638769	762
18-1368	OMC	398901	332	18-15105	Mercury Marine	57-865615009	762
18-1369	OMC	432264	332	18-15105	Mercury Marine	57-865615Q09	762
18-1370	OMC	389042	332, 920	18-15106	Yamaha	YSC-13260-60-0C	995
18-1371	OMC	385043	332, 920	18-15107	Yamaha	YSC-13260-70-0C	Obsolete
18-1374	OMC	395627	295	18-15108	Yamaha	YSC-22260-10-0C	Obsolete
18-1376	OMC	434844	295	18-15109	Yamaha	YSC-22260-00-0C	995
18-1377	OMC	320499	295	18-15110	Yamaha	YSC-10260-10-0C	995
18-1378	OMC	388344	295	18-15111	Yamaha	YSC-10260-00-0C	995
18-1386			296	18-15112	Mercury Marine	57-8077554	762
18-1389			296	18-15112	Mercury Marine	57-807755Q04	762
18-1391	OMC	330854	296	18-15113	Mercury Marine	57-8077555	762
18-1393	OMC	393896	296	18-15114	Mercury Marine	57-861049	762
18-1395	OMC	385503	296	18-15114	Mercury Marine	57-861049Q	762
18-1396	OMC	390641	296	18-15115	Mercury Marine	57-861757	762
18-1398	Mercury Marine	30-20861	407	18-15115	Mercury Marine	57-861757Q	762
18-1398	Mercury Marine	30-72961	407	18-15116	Mercury Marine	57-861758	762
18-1400	Mercury Marine	17340	791	18-15116	Mercury Marine	57-861758Q	762
18-1400	Mercury Marine	17340T	791	18-15117	Mercury Marine	57-861759	762
18-1400	OMC	3856127	903	18-15119	Mercury Marine	57-8623523	762
18-1400	Volvo	3856127	979	18-15119	Mercury Marine	57-8638761	762
18-1401	Mercury Marine	56153	791	18-15119	Mercury Marine	57-865615001	762
18-1401	Mercury Marine	F724102	791	18-15119	Mercury Marine	57-865615Q01	762
18-1401	OMC	985316	903	18-15121	Mercury Marine	57-8638765	762
18-1401	OMC	3853847	903	18-15121	Mercury Marine	57-865423005	762
18-1401	Volvo	985316	979	18-15121	Mercury Marine	57-865615005	762
18-1401	Volvo	3853847	979	18-15121	Mercury Marine	57-865615Q05	762
18-1402	Mercury Marine	34282	791	18-15122	Mercury Marine	57-86387610	762
18-1402	Mercury Marine	35583	791	18-15122	Mercury Marine	57-865615010	762
18-1402	Mercury Marine	46472	791	18-15122	Mercury Marine	57-865615Q10	762
18-1402	Mercury Marine	46744	791	18-15123	Mercury Marine	57-864639	762
18-1402	Mercury Marine	49117	791	18-15124	Mercury Marine	57-881754	762
18-1402	Mercury Marine	72638	791	18-15125	Mercury Marine	57-817113	762
18-1402	Mercury Marine	F2769931	791	18-15128	Mercury Marine	57-880566014	372
18-1402	Mercury Marine	F5232670	791	18-15129	Mercury Marine	17-828507 1	372
18-1402	Mercury Marine	FI1100349	791	18-15130	Yamaha	6C5-46241-00-00	517
18-1402	Mercury Marine	FI1100399	791	18-15131	Yamaha	67F-46241-00-00	517
18-1402	Mercury Marine	FI1100862	791	18-15132	Yamaha	6P2-46241-02-00	517
18-1402	Mercury Marine	FI1100954	791	18-15133	Yamaha	6G8-46241-00-00	517
18-1402	Mercury Marine	FI1101222	791	18-15134	Yamaha	6CB-W4624-00-00	517
18-1402	OMC	502036	903	18-15135	Yamaha	65W-46241-00-00	517
18-1402	OMC	3854033	903	18-15136	Yamaha	6AH-46241-00-00	517
18-1402	Volvo	502036	979	18-15137	Yamaha	66M-46241-00-00	517
18-1402	Volvo	3854033	979	18-15138	Yamaha	68T-46241-00-00	517
18-1410	Yamaha	93310-32337-00	516	18-15139	Yamaha	6AW-W4624-00-00	517
18-1411	Yamaha	93310-620V5-00	516	18-15140	Yamaha	63P-46241-00-00	517
18-1412	Suzuki	09263-20051	468	18-15141	Yamaha	69J-46241-00-00	517
18-1414	Suzuki	09263-14022	468	18-15142	Yamaha	6DA-W4624-00-00	517
18-1415	Suzuki	09263-18016	468	18-15143	Yamaha	60V-46241-00-00	517
18-1416	Suzuki	09263-27005	468	18-15144	Yamaha	62Y-46241-00-00	517
18-1417	Suzuki	09263-20072	468	18-15145	Yamaha	68F-46241-10-00	517
18-1476			976	18-15146	Mercury Marine	8M0072670	411
18-1477			976	18-15147	Mercury Marine	835392Q	411

1 This product is priced per piece. To order, priced per package, please add -9 to the part number
 2 Items ending in "D" are display packaged - regular number is non-display
 3 For discount shop pack of 10, please add -10 to the part number

SIERRA #	O.E.M.	O.E. #	PAGE #	SIERRA #	O.E.M.	O.E. #	PAGE #
SIERRA							
18-15148	Mercury Marine	8M0065179	411	18-15495	Volvo	958320	966
18-15149	Mercury Marine	57-895120	411	18-15495			893
18-15150	Mercury Marine	57-895120002	411	18-1550	Mercury Marine	43-881260A3	436
18-1522	Yamaha	63P-81950-00	482	18-15500	Mercury Marine	57-96834Q	756
18-1523	Yamaha	61A-81950-01	482	18-15500	Mercury Marine	57-96834T	756
18-15214	Crusader	R130012	597	18-15500	OMC	909818	893
18-15214	Pleasurecraft	R130012	626	18-15500	OMC	912418	893
18-15290	Mercury Marine	57-13457	756	18-15500	Volvo	952141	966
18-15290	Mercury Marine	57-13457Q	756	18-15501	Mercury	88-93582	702
18-15290	Mercury Marine	57-13457T	756	18-1551	Mercury Marine	43-803615T2	436
18-15290	Mercury Marine	57-53215	756	18-15520	Mercury Marine	57-33170	756
18-15290	Mercury Marine	57-53215T	756	18-15520	Mercury Marine	57-33170Q	756
18-15290			893, 966	18-15520	Mercury Marine	57-37619T	756
18-15300	Mercury Marine	57-49756	756	18-15520	OMC	912714	893
18-15300			893, 966	18-15520			966
18-15325	Mercury Marine	57-77274A1	756	18-15550	Mercury Marine	57-13458	756
18-15325	Volvo	958303	966	18-15550	Mercury Marine	57-13458Q	756
18-15325			893	18-15550	Mercury Marine	57-13458T	756
18-15345	Mercury Marine	57-74271	756	18-15550	Mercury Marine	57-96834	756
18-15345	Mercury Marine	57-74271Q	756	18-15550			893, 966
18-15345	Mercury Marine	57-74271T	756	18-1560	Mercury Marine	43-850036	436
18-15345	Mercury Marine	57-77274	756	18-1560	Mercury Marine	43-850036T	436
18-15345			893, 966	18-1562	Mercury Marine	52-850048T	436
18-15370	Mercury Marine	57-65607	756	18-1562	Mercury Marine	53-850048	436
18-15370	Mercury Marine	57-65607Q	756	18-1564	Mercury Marine	43-803615T1	436
18-15370	Mercury Marine	57-65607T	756	18-1564	Mercury Marine	43-803615T2	436
18-15370			893, 966	18-1565	Mercury Marine	52-859340T	436
18-15380	OMC	910414	893	18-1566	Mercury Marine	43-828175A1	437
18-15380			756, 893, 966	18-1567	Mercury Marine	43567A1	433
18-15390	Mercury Marine	57-52692	756	18-1567	Mercury Marine	43567T1	433
18-15390	Volvo	958310	966	18-1567	Mercury Marine	96184A1	433
18-15390			893	18-1595	Johnson/Evinrude	353590	284
18-15400	Mercury Marine	57-32850	756	18-1596	Johnson/Evinrude	328725	285
18-15400	Mercury Marine	57-69143Q	756	18-1597	Johnson/Evinrude	302325	284, 285
18-15400	Mercury Marine	57-69143T	756	18-1598	OMC	341013	914
18-15400	OMC	311606	893	18-1599	OMC	123018	914
18-15400			966	18-1600	OMC	983825	922
18-15405	Mercury Marine	57-76269	756	18-1601	OMC	983826	922
18-15405	Mercury Marine	57-76269Q	756	18-1602	OMC	984012	922
18-15405	Volvo	958311	966	18-1650	Universal		145
18-15405			893	18-1651	Universal		145
18-15410	Mercury Marine	57-32850	756	18-1652	Universal		145
18-15410	Mercury Marine	57-49043	756	18-1653	Universal		145
18-15410	Mercury Marine	57-49043A1	756	18-1654	Universal		145
18-15410	Mercury Marine	57-64032	756	18-1655	Universal		145
18-15410	Mercury Marine	57-64032A1	756	18-1656	Universal		145
18-15410	Mercury Marine	57-64032Q1	756	18-1701	OMC	911693	921
18-15410	Mercury Marine	57-816544	756	18-1702	OMC	438039	923
18-15410	Volvo	950813	966	18-1702	OMC	5000074	923
18-15410			893	18-1703	OMC	434400	923
18-15415	Mercury Marine	57-36356	756	18-1703	OMC	435096	923
18-15415	OMC	910343	893	18-1703	OMC	438040	923
18-15415	Volvo	958357	966	18-1703	OMC	5000363	923
18-15430	Mercury Marine	57-49211	756	18-1703	OMC	5004257	923
18-15430	Mercury Marine	57-64416	756	18-1704	OMC	331980	316, 911
18-15430	Volvo	841821	966	18-1705	Mercury Marine	65547	831
18-15430			893	18-1705	Mercury Marine	77123	831
18-15435	Mercury Marine	57-49211	756	18-1705	Mercury Marine	77123A1	831
18-15435	Mercury Marine	57-64416	756	18-1706	Mercury Marine	10-86801	831
18-15435	OMC	912509	893	18-1710	Mercury Marine	86814	834
18-15435	Volvo	958314	966	18-1710	Mercury Marine	862209	834
18-15435	Volvo	966382	966	18-1711	Mercury Marine	862132	830
18-15440	Mercury Marine	57-45856	756	18-1711	Mercury Marine	862132T	830
18-15440	Mercury Marine	57-49213A1	756	18-1712	OMC	980014	337
18-15440	OMC	311046	893	18-1713	OMC	3852563	914
18-15440			966	18-1714	OMC	313448	924
18-15450	OMC	914787	893	18-1718			341, 914
18-15450	Volvo	3858462	966	18-1721	OMC	433067	334
18-15450			756	18-1722	OMC	438399	334
18-15455	OMC	908929	893	18-1723	OMC	346004	334
18-15455	Volvo	3852464	966	18-1725	OMC	436834	335
18-15455			756	18-1727	Volvo	803762	977
18-15460	Mercury Marine	57-48120	756	18-1728	Mercury Marine	816607	834
18-15460	Mercury Marine	57-48120A1	756	18-1729	OMC	434588	337
18-15460	Mercury Marine	57-48120Q1	756	18-1730	Mercury Marine	43585	393
18-15460	OMC	310953	893	18-17301	Yamaha	6J8-81960-00-00	477
18-15460	OMC	909971	893	18-1734	OMC	334742	289
18-15460	Volvo	829207	966	18-1736	Mercury Marine	45-43031A1	436
18-15460	Volvo	950818	966	18-1737	Mercury Marine	45-440001	436
18-15470	Mercury Marine	57-78200	756	18-1750			332, 920
18-15470	Mercury Marine	57-78200A1	756	18-1752	OMC	394462	295
18-15470	Mercury Marine	57-78200Q1	756	18-1753	OMC	395861	295
18-15470			893, 966	18-1755	Yamaha	650-11651-04-00	516
18-15480	Mercury Marine	57-48122	756	18-1755K	Yamaha	650-11651-04-00	516
18-15480	Mercury Marine	57-48122Q	756	18-1756	Yamaha	688-11650-03-00	516
18-15480			893, 966	18-1757	Suzuki	12161-93902	468
18-15490	Mercury Marine	57-816295Q	756	18-17570			966
18-15490	Mercury Marine	57-816295T	756	18-1757K	Suzuki	12161-93902	468
18-15495	Mercury Marine	57-91035	756	18-1758	Suzuki	12161-91L00	468
18-15495	Mercury Marine	57-91035A1	756	18-1758	Suzuki	12161-96300	468
18-15495	Mercury Marine	57-91035Q1	756	18-1759	Suzuki	12161-92L00	468

1 This product is priced per piece. To order, priced per package, please add -9 to the part number

2 Items ending in "D" are display packaged - regular number is non-display

3 For discount shop pack of 10, please add -10 to the part number

SIERRA #	O.E.M.	O.E. #	PAGE #	SIERRA #	O.E.M.	O.E. #	PAGE #
SIERRA							
18-1759	Suzuki	12161-94400	468	18-1918	Crusader	97386	608
18-1759K	Suzuki	12161-94400	468	18-1919	Crusader	97387	608
18-1800	Mercury Marine	12886A6	411	18-1921	OMC	909863	898
18-18000	Mercury Marine	57-892318	372	18-1922	OMC	987784	898
18-18100	Mercury Marine	57-828507Q4	372	18-1922	OMC	916096	898
18-1820	Honda	91251-ZW1-B04	245	18-1922	OMC	740120	898
18-1821	Johnson/Evinrude	353690	285	18-1922	OMC	3850799	898
18-1822	Johnson/Evinrude	354580	284	18-1922	OMC	910380	898
18-1823	Johnson/Evinrude	5007770	284	18-1924	Crusader	97624	608
18-1824	Johnson/Evinrude	349354	284	18-1925	Crusader	96120	607
18-1825	Johnson/Evinrude	340811	285	18-1925	Crusader	97752	607
18-1826	Johnson/Evinrude	338601	284	18-1926	Crusader	96121	607
18-1827	Johnson/Evinrude	321129	285	18-1926	Crusader	97753	607
18-1828	Yamaha	663-44366-00	497	18-1927	Crusader	97772	608
18-1829	Yamaha	6AW-44365-00-00	497	18-1928	Crusader	97924	608
18-1830	Yamaha	663-44366-00	498	18-1929	Crusader	97114	607
18-18303	Suzuki	38100-92J02	462	18-1929	Crusader	97992	607
18-18303	Suzuki	38100-92J10	462	18-1930-2	Volvo	855387	969
18-18303	Suzuki	38100-93J01	462	18-1930-2	Volvo	834438-4	969
18-18303	Suzuki	38100-93J02	462	18-1931-1	Volvo	835804	969
18-18303	Suzuki	38100-96J00	462	18-1931-1	Volvo	856883	969
18-18304	Suzuki	37100-87J00-OEP	462	18-1932	Volvo	856894	969
18-18304	Suzuki	38100-87J0EP	462	18-1933	Crusader	97115	607
18-1831	Yamaha	682-44366-00	498	18-1933	Crusader	97993	607
18-1832	Yamaha	682-44367-00	498	18-1934	Crusader	98068	608
18-1833	Yamaha	647-44366-00	498	18-1935-1	Volvo	856891	970
18-1834	Yamaha	682-44365-00	498	18-1935-1	Volvo	855384-4	970
18-1835	Yamaha	6E5-44365-00-00	498	18-1936	Volvo	857037	968, 969, 971, 972
18-1836	Yamaha	6L2-44367-00	497	18-19360			971
18-1837	Yamaha	6L2-44367-10	497	18-1937	Mercury Marine	98562A6	779
18-1838	Mercury	43023	393	18-1938	Crusader	98126	608
18-1839	Mercury	8235471	393	18-1938	Crusader	RO29015	608
18-1840	Yamaha	6EE-G4366-00	504	18-1939	Barr	20-0100	569, 586, 609, 618, 642, 779, 898, 970
18-1842	Mercury	864612T01	778				
18-1843	Mercuriser	864308T01	778	18-1939	Marine Power	0992-593	569, 586, 609, 642, 779, 898, 970
18-1843	Mercuriser	865049T01	778				
18-1843	Mercuriser	865735A02	778	18-1940	Barr	CM-1-6677A	586
18-1845	Mercuriser	864591T02	779	18-1940	Chrysler Inboard	3675826	586
18-1848	OMC	3852338	898	18-1940	Chrysler Inboard	4142322	586
18-1848	OMC	3857656	898	18-1941	Barr	CM-1-6672-B	587
18-1848	OMC	914899	898	18-1941	Chrysler Inboard	2846106	587
18-1848	Volvo	3857656	969	18-1942	Barr	CM-1-6672-H	587
18-1876	OMC	980617	970	18-1942	Chrysler Inboard	3675826	587
18-1898	Barr	CHVA-1-84	569, 586, 607, 642, 776, 897, 969	18-1942	Chrysler Inboard	24695566	587
				18-1944	Barr	CM-20-414211	586
18-1898	Marine Power	0991-110	569, 586, 607, 642, 776, 897, 969	18-1944	Chrysler Inboard	2847404	586
18-1899	Pleasurecraft	RO29001	630	18-1944	Chrysler Inboard	2847623	586
18-1901	OMC	984054	897	18-1944	Chrysler Inboard	3745639	586
18-1902	OMC	912441	897	18-1944	Chrysler Inboard	E9923M	586
18-1903	OMC	912442	897	18-1945	Barr	CM-20-6674	586
18-1904	OMC	980959	897	18-1945	Chrysler Inboard	2846689	586
18-1905	Mercury Marine	90880	779	18-1946	Barr	CM-20-6672	586
18-1906	Mercury Marine	61851	779	18-1946	Chrysler Inboard	3527794	586
18-1907	Barr	20-0100	642	18-1948	Barr	CM-20-9234	587
18-1907	Barr	20-0102	569, 586, 609, 779, 898, 970	18-1948	Chrysler Inboard	E9234M	587
				18-1949	Barr	CM 20-0097	569, 609, 642, 779, 970
18-1907	Indmar	53-2009	569, 586, 609, 642, 779, 898, 970	18-1950-1	Barr	MC-1-77234	776
				18-1950-1	Mercury Marine	77234A2	776
18-1907	Indmar	53-2018	569, 586, 609, 642, 779, 898, 970	18-1950-1	Mercury Marine	77234A7	776
				18-1951-1	Barr	MC-1-77235	776
18-1908	Mercury Marine	93320	779	18-1951-1	Mercury Marine	77235A2	776
18-1908K	Mercury Marine	807476A6	779	18-1951-1	Mercury Marine	77235A8	776
18-1908K	Mercury Marine	93320A13	779	18-1952-1	Barr	MC-1-99746	776
18-1908K	Mercury Marine	93320A2	779	18-1952-1	Mercury Marine	99746A17	776
18-1908K	Mercury Marine	93320A3	779	18-1952-1	Mercury Marine	99746A8	776
18-1908K	Mercury Marine	93320A5	779	18-1953-2	Barr	MC-1-87114	776
18-1908K	Mercury Marine	93320A6	779	18-1953-2	Mercury Marine	860246A10	776
18-1909-1	OMC	913784	898	18-1953-2	Mercury Marine	860246A3	776
18-1909-1	OMC	3850456	898	18-1953-2	Mercury Marine	860246A7	776
18-1909-1	OMC	3855270	898	18-1953-2	Mercury Marine	860246A9	776
18-1909-1	OMC	3857944	898	18-1953-2	Mercury Marine	860336A2	776
18-1909-1	OMC	3856444	898	18-1953-2	Mercury Marine	860337A2	776
18-1909-1	Volvo	3863061	970	18-1953-2	Mercury Marine	87114A19	776
18-1909-1	Volvo	3863061	970	18-1953-2	Mercury Marine	87114A19	776
18-1909-1	Volvo	3855270-9	970	18-1954-1	Mercury Marine	MC 1 95862	776
18-1909-1	Volvo	3855270-9	970	18-1954-1	Mercury Marine	95862A5	776
18-1910	Mercury Marine	47587	741	18-1955-1	Barr	MC 1 96705	777
18-1910	Mercury Marine	47588	741	18-1955-1	Mercury Marine	52390A1	777
18-1910	Mercury Marine	47587A2	741	18-1955-1	Mercury Marine	96705A1	777
18-1910	Mercury Marine	60372A1	741	18-1956-3	Barr	MC 1 99798	777
18-1910	Mercury Marine	60372A2	741	18-1956-3	Mercury Marine	806867A 8	777
18-1910	Mercury Marine	63908A2	741	18-1956-3	Mercury Marine	860235A04	777
18-1910	Mercury Marine	861493A07	741	18-1956-3	Mercury Marine	99798A16	777
18-1910	Mercury Marine	861493A3	741	18-1956-3	Mercury Marine	99798A18	777
18-1911			587	18-1956-3	Mercury Marine	99798A3	777
18-1913	Chrysler Inboard	2469556	587	18-1956-3	Mercury Marine	99798A9	777
18-1913	Chrysler Inboard	2469639	587	18-1957-2	Barr	MC-1-89011	777
18-1913	Chrysler Inboard	2847405	587	18-1957-2	Mercury Marine	807078T10	777
18-1916	Crusader	97169	608	18-1957-2	Mercury Marine	80707809	777
18-1917	Crusader	97296	611	18-1957-2	Mercury Marine	807078A4	777

1 This product is priced per piece. To order, priced per package, please add -9 to the part number
 2 Items ending in "D" are display packaged - regular number is non-display
 3 For discount shop pack of 10, please add -10 to the part number

SIERRA #	O.E.M.	O.E. #	PAGE #	SIERRA #	O.E.M.	O.E. #	PAGE #
SIERRA							
18-1957-2	Mercury Marine	807078A2	777	18-1991	Barr	200089P	569, 608, 630, 898, 970
18-1957-2	Mercury Marine	807078A 6	777	18-1992-1	Barr	200087P	569, 608, 630, 778, 898, 970
18-1957-2	Mercury Marine	89011A8	777	18-1993	Mercury Marine	59861A1	741
18-1958-1	Mercury Marine	54100A1	777	18-1993	Mercury Marine	59861A4	741
18-1958-1	Mercury Marine	54100A5	777	18-1993	Mercury Marine	78459A1	741
18-1958-1	Barr	MC-1-65604	777	18-1993	Mercury Marine	78984A08	741
18-1958-1	Mercury Marine	65604A12	777	18-1993	Mercury Marine	78984A1	741
18-1958-1	Mercury Marine	65604A4	777	18-1994	Mercury Marine	87290A4	741
18-1960-1	Mercury Marine	58759A13	777	18-1995	Mercury Marine	47638	780
18-1960-1	Mercury Marine	58759A1	777	18-1995	Mercury Marine	47638A1	780
18-1960-1	Mercury Marine	52969A1	777	18-1996	Barr	FM-1-83	630
18-1960-1	Mercury Marine	52073A1	777	18-1996	Pleasurecraft	RO28001	630
18-1960-1	Barr	MC 1 58759	777	18-1997-1	Barr	CHV-1-83	569, 586, 607, 630, 642, 776, 897, 969
18-1960-1	Mercury Marine	58759A10	777				
18-1960-1	Mercury Marine	58759A14	777	18-1998-1	Barr	FM-1-83	569, 607, 630, 642, 776, 897
18-1962-1	Barr	MC-1-65603	777				
18-1962-1	Mercury Marine	54099A5	777	18-1999	Barr	20-0082	569, 607, 630, 642, 778, 898, 970
18-1962-1	Mercury Marine	54099A1	777				
18-1962-1	Mercury Marine	65603A12	777	18-2000	OMC	309989	347, 931
18-1962-1	Mercury Marine	65603A4	777	18-2001	OMC	330137	347, 931
18-1964	Barr	CHV-1-83	639	18-2002	Honda	91252-ZW1-003	250
18-1966-1	Mercury	806867A12	778	18-2002	Mercury Marine	26-30550	446
18-1966-1	Mercury	806867A2	778	18-2002	Mercury Marine	26-70019	857
18-1966-1	Mercury	806867A3	778	18-2002	Mercury Marine	26-76868	446, 857
18-1966-1	Mercury	806867A8	778	18-2002	OMC	320862	347, 931
18-1966-1	Mercury	806867A9	778	18-2003	Mercury Marine	26-32080	857
18-1966-1	Mercury	816329A3	778	18-2003	Mercury Marine	26-36054	857
18-1966-1	Mercury	860235A03	778	18-2003	Mercury Marine	26-823894	857
18-1966-1	Mercury	99798A18	778	18-2004	Mercury Marine	26-20070	446, 857
18-1970-1	Mercury Marine	95755A2	S/S to 18-1970-2	18-2005	Jabsco	92700-0060	556
18-1970-1	Mercury Marine	98503A2	S/S to 18-1970-2	18-2005	OMC	313284	347, 931
18-1970-1	Mercury Marine	98504A3	S/S to 18-1970-2	18-2006	Mercury Marine	26-897154	446, 857
18-1970-2	Mercury Marine	95755A2	778	18-2007	Mercury Marine	26-30727	857
18-1970-2	Mercury Marine	98503A2	778	18-2007	Mercury Marine	26-31489	857
18-1970-2	Mercury Marine	98504A3	778	18-2007	Mercury Marine	26-94038	857
18-1970-2	Barr	MC-20-98504	778	18-2008	Mercury Marine	26-56788	446, 857
18-1971	Mercury Marine	49964A1	778	18-2009	Mercury Marine	26-25776	857
18-1971	Mercury Marine	49964A2	778	18-2009	Mercury Marine	26-31249	857
18-1971	Mercury Marine	60426A1	778	18-2009	Mercury Marine	26-46021	857
18-1971	Mercury Marine	76351A04	778	18-2009	Mercury Marine	26-892361	857
18-1971	Mercury Marine	76351A1	778	18-2010	Mercury Marine	26-897153	446, 857
18-1971	Mercury Marine	76351A2	778	18-2011	Mercury Marine	26-23300	857
18-1972	Barr	MC-20-76325	778	18-2011	Mercury Marine	26-29595	857
18-1972	Mercury Marine	12076A2	778	18-2011	Mercury Marine	26-90562	857
18-1972	Mercury Marine	76325A2	778	18-2012	OMC	310599	347, 931
18-1973	Barr	MC-20-55538	778	18-2013	Mercury Marine	802276	857
18-1973	Mercury Marine	39920	778	18-2013	Mercury Marine	26-16977	857
18-1973	Mercury Marine	39920A1	778	18-2013	Mercury Marine	26-20465	857
18-1973	Mercury Marine	55538A2	778	18-2013	Mercury Marine	26-31507	857
18-1974-1	Barr	MC-20-98502	779	18-2013	Mercury Marine	26-79884	857
18-1974-1	Mercury Marine	98502A2	779	18-2014	Mercury Marine	26-33144	857
18-1975-1	Mercury Marine	12076A1	779	18-2014	Mercury Marine	26-77634	857
18-1975-1	Mercury Marine	12076A2	779	18-2014	Mercury Marine	26-89238	857
18-1975-1	Mercury Marine	95864A2	779	18-2014	Mercury Marine	26-F694305	857
18-1976-2	Barr	MC-20-44354	779	18-2015	Mercury Marine	20250	857
18-1976-2	Mercury Marine	44354A10	779	18-2015	Mercury Marine	26-23517	857
18-1976-2	Mercury Marine	44354A13	779	18-2016	Mercury Marine	26-20079	857
18-1976-2	Mercury Marine	44354A3	779	18-2016	Mercury Marine	26-25837	857
18-1976-2	Mercury Marine	44354A9	779	18-2016	Mercury Marine	26-29476	857
18-1976-2	Mercury Marine	807914A1	779	18-2016	Mercury Marine	26-41953	857
18-1976-2	Mercury Marine	807988A03	779	18-2016	OMC	313992	347
18-1976-2	Mercury Marine	807988A2	779	18-2017	Mercury Marine	26-32121	857
18-1977-1	Mercury Marine	47441	741	18-2017	Mercury Marine	26-35025	857
18-1977-1	Mercury Marine	47441A1	741	18-2018	OMC	305987	347
18-1978	Mercury Marine	60427A2	778	18-2019	Mercury Marine	26-27163	857
18-1978	Mercury Marine	53779A2	778	18-2020	OMC	310649	347, 931
18-1978	Mercury Marine	53779A1	778	18-2021	OMC	313258	347
18-1978	Barr	MC-20-76771	778	18-2022	OMC	303345	347, 931
18-1978	Mercury Marine	76771A2	778	18-2023	OMC	313282	347, 931
18-1978	Mercury Marine	76771A3	778	18-2024	OMC	314167	347, 931
18-1982	Crusader	98125	607	18-2025	OMC	318972	347, 931
18-1984	Crusader	98128	609	18-2026	Mercury Marine	802276	857
18-1985	Barr	MC-20-93322A3	779	18-2026	Mercury Marine	26-16977	857
18-1985	Marine Power	612011	779	18-2026	Mercury Marine	26-20465	857
18-1985	Mercury Marine	93322	779	18-2026	Mercury Marine	26-31507	857
18-1986-1	OMC	3852374	897	18-2026	Mercury Marine	26-79884	857
18-1986-1	OMC	3857723	897	18-2026	OMC	317843	347
18-1986-1	Barr	OMC-1-914035	969	18-2027	OMC	305306	347, 931
18-1986-1	Volvo	3847501	969	18-2027	OMC	321459	347, 931
18-1986-1	Volvo	3857723	969	18-2028	OMC	318973	347
18-1986-1	Volvo	3852374-2	969	18-2029	OMC	319256	347
18-1987-1			777	18-2029	OMC	321481	347
18-1989	Mercury Marine	861006A1	648, 741	18-2030	OMC	321786	347, 931
18-1989	Mercury Marine	8M0061381	648, 741	18-2031	OMC	321787	347, 931
18-1989K			648, 741	18-2032	OMC	321788	347
18-1990	Barr	1-73813	780	18-2033	OMC	321928	347, 931
18-1990	Mercury Marine	48045	780	18-2034	OMC	324639	347, 931
18-1990	Mercury Marine	54870	780	18-2035	OMC	300599	347
18-1990	Mercury Marine	73813	780	18-2035	OMC	327031	347
18-1990	Mercury Marine	73813A1	780	18-2039	Volvo	804695	993
18-1990	Mercury Marine	73813F1	780	18-2040	Volvo	853670	993

1 This product is priced per piece. To order, priced per package, please add -9 to the part number

2 Items ending in "D" are display packaged - regular number is non-display

3 For discount shop pack of 10, please add -10 to the part number

SIERRA #	O.E.M.	O.E. #	PAGE #	SIERRA #	O.E.M.	O.E. #	PAGE #
SIERRA							
18-2041	Volvo	897426	993	18-2100K	Mercury Marine	30-879194A02	831
18-2043	Volvo	958838	993	18-2101	Mercury Marine	36147	831
18-2044	Volvo	833996	993	18-2101	Mercury Marine	30-36056	831
18-2045	Volvo	827247	993	18-2101	Mercury Marine	30-36418	831
18-2046	Volvo	946242	993	18-2103	Mercury Marine	32-47373	847
18-2047	Volvo	958860	993	18-2103	Mercury Marine	32-66073	847
18-2048	Mercury Marine	26-24590	857	18-2103	Mercury Marine	32-68676	847
18-2049	Mercury Marine	26-32511	857	18-2103	Mercury Marine	32-73004	847
18-2050	Mercury Marine	26-55682	857	18-2103	Mercury Marine	32-79431	847
18-2051	Mercury Marine	26-69188	857	18-2103	Mercury Marine	32-86036	847
18-2052	Mercury Marine	26-69189	857	18-2103	Mercury Marine	32-86036A1	847
18-2053	Honda	91255-ZW1-003	250	18-2103	Mercury Marine	32-86036Q	847
18-2053	Mercury Marine	26-70081	446, 857	18-2103	Pleasurecraft	RO85035	632
18-2054	Honda	91253-ZW1-003	250	18-2104	Mercury Marine	36312	831
18-2054	Mercury Marine	26-76384	857	18-2104	Mercury Marine	41431	831
18-2054	Mercury Marine	26-8164641	857	18-2104	Mercury Marine	58749	831
18-2055	Mercury Marine	26-21642	857	18-2104	Mercury Marine	75832	831
18-2055	Mercury Marine	26-79831	857	18-2104	Mercury Marine	758321	831
18-2055	Mercury Marine	26-79831	857	18-2104	Mercury Marine	75832A1	831
18-2056	Mercury Marine	26-37259	857	18-2104	Mercury Marine	75832A2	831
18-2056	Mercury Marine	26-89237	857	18-2104	Mercury Marine	75832A3	831
18-2056	Mercury Marine	26-96503	857	18-2104	Mercury Marine	75832T	831
18-2056	Mercury Marine	26-965031	857	18-2104	Mercury Marine	75832T1	831
18-2057	Volvo	181620	993	18-2104	OMC	912214	915
18-2058	OMC	313353	347, 931	18-2104	OMC	915716	915
18-2059	OMC	318223	347, 931	18-2104	Volvo	853255	989
18-2060	OMC	303804	347	18-2104	Volvo	897707	989
18-2060	OMC	321467	347, 931	18-2105	Mercury Marine	32-45973	848
18-2061	OMC	329922	347, 931	18-2106	Mercury Marine	32-45974	848
18-2062	OMC	329923	347, 931	18-2107	Mercury Marine	32-55816	848
18-2063	OMC	330327	347, 931	18-2108	Mercury Marine	32-59841	848
18-2064	OMC	332205	347, 931	18-2108	Mercury Marine	32-59841A1	848
18-2065	OMC	332261	347, 931	18-2108	Mercury Marine	32-73123	848
18-2066	OMC	911019	347, 931	18-2109	Mercury Marine	32-59842	848
18-2067	OMC	911685	347, 931	18-2109	Mercury Marine	32-73005	848
18-2068	OMC	911701	347, 931	18-2110	Mercury Marine	32-45327	439
18-2068	OMC	915702	347, 931	18-2110	Mercury Marine	32-88005	439
18-2068	OMC	916058	347, 931	18-2110	Mercury Marine	32-97153A1	439
18-2068	OMC	3853655	347, 931	18-2111	Mercury Marine	32-45959	439
18-2071	OMC	908065	931	18-2111	Mercury Marine	32-88006	439
18-2071	OMC	908852	931	18-2111	Mercury Marine	32-97154A1	439
18-2071	OMC	981195	347	18-2112	Mercury Marine	32-87234	848
18-2072	OMC	908070	931	18-2113	Mercury Marine	32-87235	848
18-2072	OMC	908894	931	18-2114	Mercury Marine	32-864960	848
18-2072	OMC	981196	347, 931	18-2114	Mercury Marine	32-99902-1	848
18-2073	OMC	907967	931	18-2115	Mercury Marine	32-864959	848
18-2073	OMC	981268	347, 931	18-2115	Mercury Marine	32-99903-1	848
18-2074	OMC	339620	347	18-2116	Mercury Marine	32-99904	849
18-2075	OMC	326751	347	18-2116	Mercury Marine	32-99904Q	849
18-2075	OMC	353076	347	18-2125	Mercury Marine	39384	830
18-2076	Mercury Marine	26-12224	857	18-2125	Mercury Marine	46020	830
18-2076	Mercury Marine	26-F697118	857	18-2125	Mercury Marine	460201	830
18-2077	Mercury Marine	26-14077	857	18-2125	Mercury Marine	4602002	830
18-2077	Mercury Marine	26-F697555	857	18-2125	Mercury Marine	4602002	830
18-2079	Yamaha	93101-22M15-00	550	18-2125	Mercury Marine	46020T	830
18-2081	Yamaha	64E-43822-00-00	482	18-2126	Mercury Marine	32-48418	849
18-2082	Yamaha	64E-4384J-00-00	482	18-2126	Mercury Marine	32-52951A1	849
18-2083	Yamaha	68V-13766-00-00	482, 493	18-2128	Mercury Marine	39383	830
18-2085	Yamaha	93102-35M13-00	550	18-2128	Mercury Marine	393831	830
18-2087	Yamaha	93102-40M36-00	550	18-2128	Mercury Marine	39383T	830
18-2091	Yamaha	93104-22M07-00	550	18-2128	OMC	912213	919
18-2093	OMC	319664	334	18-2128	OMC	3850813	919
18-2093	OMC	333096	334	18-2128	Volvo	912213	989
18-2093	OMC	398051	334	18-2128	Volvo	3850813	989
18-2094	Mercury Marine	26-36143	812	18-2130	Mercury Marine	66062	843
18-2094	Mercury Marine	26-88416	812	18-2130	Mercury Marine	76865	843
18-2097	Mercury Marine	8055361	830	18-2130	Mercury Marine	8M2009865	843
18-2097	Mercury Marine	805536A1	830	18-2136	Mercury Marine	32-864589	848
18-2097	Mercury Marine	805536A2	830	18-2136	Mercury Marine	32-99902	848
18-2100	Mercury Marine	30-60794A2	831	18-2137	Mercury Marine	32-864588	848
18-2100	Mercury Marine	30-60794A4	831	18-2137	Mercury Marine	32-99903	848
18-2100	Mercury Marine	30-879194A02	831	18-2138	OMC	911787	927
18-2100	OMC	983937	914	18-2138	Volvo	3852544	990
18-2100	Volvo	3853807	989	18-2140			813
18-21001	Mercury Marine	30-60794A2	831	18-2141	Mercury Marine	10-97934A1	813
18-21001	Mercury Marine	30-60794A4	831	18-2142	Mercury Marine	45706A1	850
18-21001	Mercury Marine	30-879194A02	831	18-2142	Mercury Marine	45706A12	850
18-21005	Mercury Marine	30-562540A3	831	18-2142	Mercury Marine	45706A14	850
18-21005	Mercury Marine	30-862540A04	831	18-2142	Mercury Marine	45706A3	850
18-21005	Mercury Marine	30-862540T1	831	18-2142	Mercury Marine	45706A6	850
18-21005	Mercury Marine	30-879194A01	831	18-2142	Mercury Marine	45706A8	850
18-21005K	Mercury Marine	30-862540A04	831	18-2143	Mercury Marine	67210	411
18-21005K	Mercury Marine	30-862540A3	831	18-2143	Mercury Marine	78249	411
18-21005K	Mercury Marine	30-862540T1	831	18-2144	Mercury Marine	67209	411
18-21005K	Mercury Marine	30-879194A01	831	18-2144	Mercury Marine	77326	411
18-21006	Mercury Marine	30-862540A04	831	18-2144	Mercury Marine	78687	411
18-21006	Mercury Marine	30-862540A3	831	18-2144	Mercury Marine	78687T	411
18-21006	Mercury Marine	30-862540T1	831	18-2145	Mercury Marine	19297A3	835
18-21006	Mercury Marine	30-879194A01	831	18-2145	Mercury Marine	43432A2	835
18-2100K	Mercury Marine	30-60794A2	831	18-2145	Mercury Marine	815471A3	835
18-2100K	Mercury Marine	30-60794A4	831	18-2145	Mercury Marine	815471A6	835

1 This product is priced per piece. To order, priced per package, please add -9 to the part number

2 Items ending in "D" are display packaged - regular number is non-display

3 For discount shop pack of 10, please add -10 to the part number

SIERRA #	O.E.M.	O.E. #	PAGE #	SIERRA #	O.E.M.	O.E. #	PAGE #	
SIERRA								
18-2145	Mercury Marine	85147A5	835	18-2174	Mercury Marine	758321	831	
18-2145	Mercury Marine	865437A02	835	18-2174	Mercury Marine	75832A1	831	
18-2145E	Mercury Marine	815471	836	18-2174	Mercury Marine	75832A2	831	
18-2145E	Mercury Marine	815471A3	836	18-2174	Mercury Marine	75832A3	831	
18-2145E	Mercury Marine	815471A6	836	18-2174	Mercury Marine	75832T	831	
18-2146	Mercury Marine	20175	830	18-2174	Mercury Marine	75832T1	831	
18-2146	Mercury Marine	59830A1	830	18-2174	OMC	915717	915	
18-2146	Mercury Marine	59830A7	830	18-2174	OMC	3850812	915	
18-2146	OMC	912212	915	18-2174	Volvo	3850812	989	
18-2146	OMC	3850815	915	18-2175	Mercury Marine	12632A4	837	
18-2146	Volvo	3850815	989	18-21751	OMC	983902	919	
18-2147	Johnson/Evinrude	328754	284, 285	18-21751	OMC	986338	919	
18-2148	Mercury Marine	45523	850	18-21751	OMC	3853962	919	
18-2148	Mercury Marine	77443	850	18-21751	Volvo	3853962-3	987	
18-2148	Mercury Marine	45706A4	850	18-21752-1	OMC	984290	919	
18-2148	Mercury Marine	77442A1	850	18-21752-1	OMC	986120	919	
18-2149	Mercury Marine	22879	836	18-21752-1	OMC	3853917	919	
18-2149	Mercury Marine	29880	836	18-21752-1	OMC	3858437	919	
18-2149	Mercury Marine	43433	836	18-21752-1	Volvo	3858437-1	987	
18-2150	Mercury Marine	37973	843	18-21753	OMC	3853862	919	
18-2150	Mercury Marine	65028	843	18-21753	Volvo	985727	987	
18-2150	Mercury Marine	66066	843	18-21753	Volvo	3853862-5	987	
18-2150	Mercury Marine	77481	843	18-21754	OMC	984537	919	
18-2150	Mercury Marine	774811	843	18-21754	OMC	986232	919	
18-2151	Mercury Marine	17-45738	852	18-21755	OMC	984629	919	
18-2152	Mercury Marine	17-45735	852	18-2176	OMC	908063	920	
18-2153	Volvo	814301	990	18-2177	OMC	908069	920	
18-2154	Mercury Marine	23-30617A1	843	18-2179	Mercury Marine	45-55796	832	
18-2154	Mercury Marine	23-30617A2	843	18-2180	Mercury Marine	45-42634	842	
18-2155	Mercury Marine	23-37428A1	435	18-2183	OMC	909121	921	
18-2155	Mercury Marine	23-55419A1	435	18-2184	OMC	908087	922	
18-2155	Mercury Marine	23-77631A2	435	18-2185	OMC	909753	922	
18-2156	OMC	980183	925	18-2186	OMC	982424	922	
18-2157	Mercury Marine	19543A10	835	18-2187	OMC	391472	335	
18-2157	Mercury Marine	19543A2	835	18-2187	OMC	395209	335, 922	
18-2157	Mercury Marine	19543A4	835	18-2189	Mercury Marine	32992A1	835	
18-2157	Mercury Marine	19543A8	835	18-2189	Mercury Marine	34086A1	835	
18-2157	Mercury Marine	41951A1	835	18-2189	Mercury Marine	37611A1	835	
18-2157	Mercury Marine	66065A1	835	18-2189	Mercury Marine	38399A2	835	
18-2157	Mercury Marine	66069A2	835	18-2190	Mercury Marine	19543A10	835	
18-2157	Mercury Marine	73679A2	835	18-2190	Mercury Marine	19543A2	835	
18-2157	Mercury Marine	865436A02	835	18-2190	Mercury Marine	19543A4	835	
18-2158			835	18-2190	Mercury Marine	19543A8	835	
18-2159	Mercury Marine	19543A10	835	18-2190	Mercury Marine	41951A1	835	
18-2159	Mercury Marine	19543A2	835	18-2190	Mercury Marine	66065A1	835	
18-2159	Mercury Marine	19543A4	835	18-2190	Mercury Marine	66069A2	835	
18-2159	Mercury Marine	19543A8	835	18-2190	Mercury Marine	73679A2	835	
18-2159	Mercury Marine	41951A1	835	18-2190	Mercury Marine	865436A02	835	
18-2159	Mercury Marine	66065A1	835	18-2190E	Mercury Marine	19543A10	835	
18-2159	Mercury Marine	66069A2	835	18-2190E	Mercury Marine	19543A2	835	
18-2159	Mercury Marine	73679A2	835	18-2190E	Mercury Marine	19543A2	835	
18-2159	Mercury Marine	865436A02	835	18-2190E	Mercury Marine	19543A8	835	
18-2160	Mercury Marine	32-38377	835	18-2190E	Mercury Marine	41951A1	835	
18-2161	Mercury Marine	45518A1	832	18-2190E	Mercury Marine	66065A1	835	
18-2161	Mercury Marine	45518A2	832	18-2190E	Mercury Marine	66069A2	835	
18-2161	Mercury Marine	45518A3	832	18-2190E	Mercury Marine	73679A2	835	
18-2162	Mercury Marine	33981	832	18-2190E	Mercury Marine	865436A02	835	
18-2162	Mercury Marine	8507521	832	18-2191	Mercury Marine	56211A1	842	
18-2162	Mercury Marine	8507522	832	18-2191	Mercury Marine	73020A1	842	
18-2162	Mercury Marine	33981T	832	18-2191	Mercury Marine	73020A14	842	
18-2162	Mercury Marine	33981T1	832	18-2192	OMC	379628	878	
18-2162E	Mercury Marine	33981	832	18-2193	Mercury Marine	33149	813	
18-2162E	Mercury Marine	8507521	832	18-2193	Mercury Marine	99297A1	813	
18-2162E	Mercury Marine	8507522	832	18-2193	Mercury Marine	99297A2	813	
18-2162E	Mercury Marine	33981T1	832	18-2195	Mercury Marine	12632A3	837	
1	18-2163	Mercury Marine	10-31700	833	18-2195	Mercury Marine	12632A7	837
	18-2163E-9	GLM	21090	833	18-2196	Mercury Marine	37967	842
	18-2163E-9	Mallory	9-72152	833	18-2196	Mercury Marine	61073	842
	18-2163E-9	Mercury Marine	10-31700	833	18-2196	Mercury Marine	19755A08	842
	18-2166	Mercury Marine	44-55857	841	18-2196	Mercury Marine	19755A4	842
	18-2166	Mercury Marine	44-66060	841	18-2199	Volvo	832675	987
	18-2166	Mercury Marine	44-660602	841	18-2200	Mercury Marine	43-61027	840
	18-2166	Mercury Marine	44-660603	841	18-2200	Mercury Marine	43-96084A4	840
	18-2166	Mercury Marine	44-824110	841	18-2201	Mercury Marine	43-18410A2	829
	18-2169	Mercury Marine	45589A1	832	18-2201	Mercury Marine	43-18411A2	829
	18-2169	Mercury Marine	45589A3	832	18-2201	Mercury Marine	43-59832A2	829
	18-2170	Mercury Marine	10-45590	832	18-2201	Mercury Marine	43-59832A4	829
	18-2170	Mercury Marine	10-8M0084649	832	18-2202	Mercury Marine	52-66063	841
	18-2171	Mercury Marine	32492A2	837	18-2202	Mercury Marine	52-824112	841
	18-2171	Mercury Marine	32492A3	837	18-2202	Mercury Marine	52-853594	841
	18-2171	Mercury Marine	32492A5	837	18-2202	Mercury Marine	52-853594T	841
	18-2171	Mercury Marine	38965A1	837	18-2203	Mercury Marine	43-45814A5	829
	18-2171	Mercury Marine	38965A2	837	18-2203	Mercury Marine	43-55765A2	829
	18-2171	Mercury Marine	76850A2	837	18-2203	Mercury Marine	43-55765A3	829
	18-2172	Mercury Marine	14505A2	837	18-2204	Mercury Marine	43-75325A2	829
	18-2173	Mercury Marine	59826A1	837	18-2204	Mercury Marine	43-75325A3	829
	18-2173	Mercury Marine	59826A3	837	18-2205	Mercury Marine	43-55766A2	829
	18-2174	Mercury Marine	36312	831	18-2205	Mercury Marine	43-55766A3	829
	18-2174	Mercury Marine	41431	831	18-2205	Mercury Marine	43-55778A3	829
	18-2174	Mercury Marine	58749	831	18-2206-1	Mercury Marine	43-828072A2	840
	18-2174	Mercury Marine	75832	831	18-2206-1	Mercury Marine	43-828073A1	840

1 This product is priced per piece. To order, priced per package, please add -9 to the part number

2 Items ending in "D" are display packaged - regular number is non-display

3 For discount shop pack of 10, please add -10 to the part number

SIERRA #	O.E.M.	O.E. #	PAGE #	SIERRA #	O.E.M.	O.E. #	PAGE #
SIERRA							
18-2206-1	Mercury Marine	43-878087A2	840	18-2290			337
18-2207	OMC	397338	Obsolete	18-2291	Mercury Marine	25-60342A1	851
18-2208	OMC	318304	336	18-2291	Mercury Marine	25-60342A2	851
18-2209	OMC	318303	336	18-2292	Mercury Marine	15-35980A1	826
18-2210			Obsolete	18-2293	Mercury Marine	15-23097A1	826
18-2216	OMC	334516	336	18-2293	Mercury Marine	15-36178A02	826
18-2216	OMC	336562	336	18-2293	Mercury Marine	15-36178A1	826
18-2216	OMC	337772	336	18-2293	Mercury Marine	15-39899A1	826
18-2216	OMC	337774	336	18-2294	Mercury Marine	15-42637A1	826
18-2216	OMC	910995	336	18-2294	Mercury Marine	15-8M0063267	826
18-2217			336	18-2295	Mercury Marine	15-33143A1	826
18-2218	OMC	434063	336, 922	18-2295	Mercury Marine	15-57007A1	826
18-2218	OMC	436746	336, 922	18-2296	Mercury Marine	15-45811	826
18-2218	OMC	985050	336, 922	18-2296	Mercury Marine	15-71013	826
18-2218	OMC	989966	336	18-2298	Mercury Marine	14-17460	438, 843
18-2219	OMC	317838	336, 922	18-2298	Mercury Marine	14-18323	438, 843
18-2219	OMC	333077	336, 922	18-2299	Mercury Marine	14-52833	438, 843
18-2219	OMC	340490	336, 922	18-2299	Mercury Marine	14-79447	438, 843
18-2220	OMC	320630	336, 922	1 18-2303	Mercury Marine	10-20518	836
18-2220	OMC	323664	336, 922	18-2308	OMC	332491	336
18-2221			336	18-2309	OMC	332489	337
1 18-2224	OMC	320166	341	18-2310	OMC	397627	337
1 18-2225	OMC	320167	341	18-2315			337
1 18-2226	OMC	320168	341	1 18-2316	Mercury Marine	12-77674	813
1 18-2227	OMC	320169	341	18-2320	Mercury Marine	815919A1	843
1 18-2228	OMC	320170	341	18-23205	Mercury	339-859738T1	358
1 18-2229	OMC	323362	341, 914	18-23205	Yamaha	65W-85570-01-00	473
18-2230	OMC	323361	341, 914	18-23207	Nissan/Tohatsu	3V1060400M	455
18-2231	OMC	314745	341, 914	18-2321	Mercury Marine	12632A6	837
18-2232	OMC	323889	341	18-2322	Mercury Marine	62104	832
18-2233	OMC	323890	341	18-2322	Mercury Marine	621041	832
1 18-2234	OMC	317232	341	18-2323	Mercury Marine	18643A5	837
18-2236	Mercury Marine	52-12777	436	18-2324	Mercury Marine	45-557961	832
18-2236	Mercury Marine	52-34239	436	18-2325	OMC	435760	334
18-2236	Mercury Marine	52-814756	436	18-23251	Honda	30520-PWC-003	240
18-2236	Mercury Marine	52-822539	436	18-2326	OMC	436232	334
18-2236	Mercury Marine	52-822539T	436	18-2327	OMC	436234	334
18-2239	Mercury Marine	44-94148	436	18-2328	OMC	435761	334
1 18-2243	OMC	316506	337, 921	18-2330	OMC	436235	334
18-2244	Mercury Marine	10-20259	435, 846	18-2331	Mercury Marine	45-853647	842
18-2244	Mercury Marine	10-28634	435, 846	18-2331	Mercury Marine	45-853648	842
18-2244	Mercury Marine	10-28634A1	435, 846	18-2334			559
18-2244	Mercury Marine	10-79953	435, 846	1 18-2336	Mercury Marine	23-47392	853
18-2244	Mercury Marine	10-79953A2	435, 846	1 18-2336	Mercury Marine	23-61291	853
18-2244	Mercury Marine	10-79953Q04	435, 846	1 18-2336	Mercury Marine	23-90203	853
18-2244	Mercury Marine	10-79953Q2	435, 846	18-2337	OMC	3850814	915
18-2244	Mercury Marine	10-F50109	435, 846	18-2337	Volvo	3850814	989
18-2244	Mercury Marine	816610A1	435, 846	18-2338	OMC	983880	915
18-2244	Mercury Marine	816610A2	435, 846	18-2339	OMC	3852384	915
18-2244	Mercury Marine	F40109	435, 846	18-2339	Volvo	3852384	989
18-22441-9			435, 846	1 18-2340	Mercury Marine	12-31266	813
18-2245-1	OMC	987661	919	12 18-2341-1	Mercury Marine	23-815950	853
18-2246	OMC	987678	919	12 18-2341-1	Mercury Marine	23-8159501	853
18-2248	Mercury Marine	35187A1	835	12 18-2341-1	Mercury Marine	23-815950Q01	853
18-2248	Mercury Marine	35187A2	835	18-2342	Mercury Marine	68100	842
18-2248	Mercury Marine	35187A4	835	18-2342	Mercury Marine	681001	842
18-2248	Mercury Marine	49518A1	835	1 18-2343	Mercury Marine	12-92721	813
18-2248	Mercury Marine	73723A01	835	1 18-2345	Mercury Marine	53-815949	853
18-2248	Mercury Marine	73723A1	835	18-2346	Mercury Marine	824519	842
18-2250	OMC	387879	335	18-2346	Mercury Marine	88245191	842
18-2251	OMC	433017	335, 922	18-2346	Mercury Marine	11-42633	842
18-2251	OMC	435022	335, 922	18-2346	Mercury Marine	F694961	842
18-2251	OMC	436740	335, 922	18-2346	Mercury Marine	F694961-1	842
18-2252	OMC	387818	335, 922	1 18-2348	Mercury Marine	24-30893	841
18-2252	OMC	436888	335, 922	18-2349	Mercury Marine	23-67370	846
18-2254	Chrysler/Force	44-850308	238	18-2353	Mercury Marine	23-815921A10	843
18-2254	Mercury Marine	44-850308	436, 841	18-2353	Mercury Marine	23-815921A17	843
18-2256	Mercury Marine	43-803116T1	829	18-2353	Mercury Marine	23-815921A21	843
18-2257	Mercury Marine	43-803112T1	830	18-2353	Mercury Marine	23-815921A6	843
18-2258	Mercury Marine	43-803114T1	830	18-2353	Mercury Marine	23-815921A8	843
18-2259	Mercury Marine	43-803101T1	830	18-2353	Mercury Marine	815921A2	843
18-2260	Mercury Marine	44-17915	436	18-2354	Mercury Marine	807929A1	843
18-2260	Mercury Marine	44-98418	436	18-2354	Mercury Marine	807929A2	843
18-2261	Mercury Marine	45-816919	842	18-2354	Mercury Marine	815922A1	843
18-2277	OMC	335722	334	18-2354	Mercury Marine	815922A5	843
18-2279	OMC	335679	334	18-2354	Mercury Marine	821759A1	843
18-2282	Mercury Marine	15-32563A1	826	18-2354	Mercury Marine	821759A2	843
18-2283	Mercury Marine	15-45691A1	826	18-2354	Mercury Marine	821759A3	843
18-2284	Mercury Marine	15-31535A1	826	18-2354	Mercury Marine	821759A4	843
18-2285	Mercury Marine	15-35931A1	826	18-2355	OMC	386659	335
18-2285	Mercury Marine	15-47397A1	826	18-2357	Mercury Marine	17-30632	841
18-2286	Mercury Marine	66067	842	18-2357	Mercury Marine	17-8M0020941	841
18-2286	Mercury Marine	19755A2	842	18-2357	Mercury Marine	17-8M0084681	841
18-2286	Mercury Marine	66067T	842	18-2357	Mercury Marine	17-8M0100263	841
18-2286	Mercury Marine	818349A1	842	18-2358	Mercury Marine	43-803102T1	828
18-2286	Mercury Marine	818349T1	842	18-2359	Mercury Marine		436, 842
18-2287	OMC	319895	336	18-2360	Mercury Marine	43-828072A3	840
18-2288	OMC	397541	335	18-2360	Mercury Marine	43-878087A2	840
18-2288	OMC	439138	335	18-23601	Yamaha	66M-85570-00-00	473
18-2289	OMC	397128	Obsolete	18-23602	Yamaha	63V-85570-00-00	473
18-2289	OMC	433570	Obsolete	1 18-2361	Mercury Marine	10-30206	813

1 This product is priced per piece. To order, priced per package, please add -9 to the part number
 2 Items ending in "D" are display packaged - regular number is non-display
 3 For discount shop pack of 10, please add -10 to the part number

SIERRA #	O.E.M.	O.E. #	PAGE #	SIERRA #	O.E.M.	O.E. #	PAGE #	
SIERRA								
1	18-2361	Mercury Marine	10-805763	813	18-2407	Mercury Marine	43-878087A4	841
1	18-2361	Mercury Marine	10-853163	813	18-2408	Mercury Marine	43-828073A1	840
	18-2363	Mercury Marine	43-803118T1	828	18-2409	Mercury Marine	43-92320	840
	18-2364	Mercury Marine	43-803119T1	828	18-2409	Mercury Marine	43-92320T	840
	18-2365	Mercury Marine	43-803120T1	828	18-2410	Mercury Marine	43-96084A5	840
	18-2366	Volvo	876279	989	18-2410	Mercury Marine	43-96084A7	840
	18-2367	Volvo	943414	977	18-2411	Mercury Marine	1547-861063A4	826
	18-2368	Mercury Marine	43-803071T1	828	18-2412	Mercury Marine	18309A2	S/S to 18-2412-1
	18-2369	Mercury Marine	43-803069T1	828	18-2412	Mercury Marine	18311A17	S/S to 18-2412-1
	18-2370	Chrysler Force	19291A3	236	18-2412	Mercury Marine	18311A2	S/S to 18-2412-1
	18-2370	Mercury Marine	19291A3	433	18-2412	Mercury Marine	812964A2	S/S to 18-2412-1
	18-2371	Yamaha	90340-08002-00	532	18-2412	Mercury Marine	861523A9	S/S to 18-2412-1
	18-2371	Yamaha	90340-08M04-00	532	18-2412	Mercury Marine	8M0098795	S/S to 18-2412-1
	18-23711-9	Yamaha	90340-08002-00	532	18-2412-1	Mercury Marine	18309A2	837
	18-23711-9	Yamaha	90340-08M04-00	532	18-2412-1	Mercury Marine	18311A17	837
	18-2372	Mercury Marine	88035	850	18-2412-1	Mercury Marine	18311A2	837
	18-2373	Mercury Marine	14698	850	18-2412-1	Mercury Marine	812964A2	837
	18-2373	Mercury Marine	14698T	850	18-2412-1	Mercury Marine	861523A9	837
	18-2373	Mercury Marine	14698T10	850	18-2412-1	Mercury Marine	8M0098795	837
	18-2373	Mercury Marine	806191T	850	18-2413	Mercury Marine	69354A1	837
	18-2373	Mercury Marine	8M0110717	850	18-2413	Mercury Marine	69354A2	837
	18-2374	Yamaha	688-45341-00-00	532	18-2414	Mercury Marine	97432A2	837
	18-2374	Yamaha	688-45341-10-00	532	18-2415	Mercury Marine	1623-815822A36	827
	18-23741-9	Yamaha	688-45341-00-00	532	18-2416	Mercury Marine	1547-815930A16	827
	18-23741-9	Yamaha	688-45341-10-00	532	18-2416	Mercury Marine	1547-815930A6	827
2	18-2375	Mercury Marine	10-14834	435, 846	18-2416	Mercury Marine	1547-861063A12	827
2	18-2375	Mercury Marine	10-14834A1	435, 846	18-2419	Mercury Marine	1547-815930A13	827
2	18-2375	Mercury Marine	22-67892	435, 846	18-2419	Mercury Marine	1547-815930A3	827
2	18-2375	Mercury Marine	22-67892A05	435, 846	18-2419	Mercury Marine	1547-861063A6	827
2	18-2375	Mercury Marine	22-67892A06	435, 846	18-2420	Mercury Marine	14034A3	851
2	18-2375	Mercury Marine	22-67892A1	435, 846	18-2420	Mercury Marine	14034A5	851
2	18-2375	Mercury Marine	28-8M0058389	435, 846	18-2420	Mercury Marine	14034F1	851
2	18-2375			236	18-2420	Mercury Marine	14034T	851
	18-23751-9	Mercury Marine	10-14834A1	435, 846	18-2420	Mercury Marine	14034T10	851
	18-23751-9	Mercury Marine	22-67892A1	435, 846	18-2421	Mercury Marine	14035A3	851
	18-23751-9			236	18-2421	Mercury Marine	14035A5	851
	18-2376	Mercury Marine	73020A20	843	18-2421	Mercury Marine	14035F1	851
	18-2376	Mercury Marine	818763A10	843	18-2421	Mercury Marine	14035T	851
	18-2376	Mercury Marine	818763A4	843	18-2421	Mercury Marine	14035T10	851
1	18-2377	OMC	316563	328	18-2422	Mercury Marine	815935A3	851
	18-2378	OMC	318544	911	18-2422	Mercury Marine	815935A7	851
	18-23781-9	OMC	318544	328, 911	18-2423	Mercury Marine	815954A3	851
1	18-2379	OMC	320041	328	18-2423	Mercury Marine	815954A7	851
1	18-2380	Yamaha	91401-30028-00	533	18-2424	Mercury Marine	98703A11	851
1	18-2380	Yamaha	91401-30030-00	533	18-2424	Mercury Marine	98703A12	851
1	18-2380	Yamaha	91402-30022-00	533	18-2424	Mercury Marine	98703A17	851
1	18-2380	Yamaha	91402-30022-09	533	18-2424	Mercury Marine	98703A26	851
1	18-2380	Yamaha	91402-30028-00	533	18-2425	Mercury Marine	8M0708280	851
1	18-2380	Yamaha	91402-30028-09	533	18-2425	Mercury Marine	98704A11	851
1	18-2380	Yamaha	91490-30030-00	533	18-2425	Mercury Marine	98704A12	851
	18-2381	Mercury Marine	94998A1	832	18-2425	Mercury Marine	98704A17	851
	18-2381	Mercury Marine	94998A2	832	18-2425	Mercury Marine	98704A26	851
	18-2381	Mercury Marine	94998A3	832	18-2426	Mercury Marine	98703A3	851
	18-2381	Mercury Marine	94998A4	832	18-2427	Mercury Marine	98704A3	851
	18-2382	Mercury Marine	18312A3	832	18-2428	Mercury Marine	87399A1	851
	18-2382	Mercury Marine	828692A1	832	18-2428	Mercury Marine	87399A2	851
	18-2383	OMC	914716	922	18-2429	Mercury Marine	87399A3	851
	18-2383	OMC	915272	922	18-2430	Mercury Marine	26-830749	425
	18-2385	Yamaha	6E5-45611-01-00	532	18-24301-9	Mercury Marine	26-830749	425
	18-2387	OMC	307551	911	18-2432	Volvo	873228	987
	18-23871-9	OMC	307551	328, 911	18-2433	Volvo	873229	987
	18-2388	Yamaha	688-45611-00-00	532	18-2434	Crusader	96938	558, 597
	18-2389	OMC	314832	315	18-2434	Marine Power	0100-000	558
	18-2391	OMC	321692	289, 315	18-2434	Mercury Marine	814309A1	558, 699
	18-2392	OMC	327035	315	18-2434	Pleasurecraft	R142006	558, 632
	18-2393	Mercury Marine	17-14872	852	18-2434	Volvo	3857846-4	558
	18-2394	Mercury Marine	17-14873	852	18-2435	Mercury Marine	32-861127	848
	18-2395	Mercury Marine	17-815953	852	18-2435	Mercury Marine	32-95858	848
	18-2395	Mercury Marine	17-815953A1	852	18-2436	Mercury Marine	32-861128	849
	18-2396	Mercury Marine	17-44166	852	18-2436	Mercury Marine	32-95859	849
	18-2397	Mercury Marine	17-44167	852	18-2438	OMC	986145	Obsolete
	18-2397	Mercury Marine	17-44167A1	852	18-2443	Mercury Marine	1623-4110A13	827
	18-2398	OMC	320311	337	18-2443	Mercury Marine	1623-4110A4	827
	18-2399	OMC	324369	337, 925	18-2443	Mercury Marine	1623-4110A6	827
	18-2400	Mercury Marine	1623-81582243	826	18-2443	Mercury Marine	1623-5356A18	827
	18-2400	Mercury Marine	1623-815822A32	826	18-2443	Mercury Marine	1623-5356A19	827
	18-2400	Mercury Marine	1623-815822A5	826	18-2443	Mercury Marine	1623-5356A20	827
	18-2400	Mercury Marine	1623-815822A53	826	18-2443	Mercury Marine	1623-5356A3	827
	18-2401	Mercury Marine	1623-8951A15	827	18-2443	Mercury Marine	1623-8951A14	827
	18-2401	Mercury Marine	1623-8951A27	827	18-2443	Mercury Marine	1623-8951A19	827
	18-2401	Mercury Marine	1623-8951A37	827	18-2443	Mercury Marine	1623-8951A2	827
	18-2401	Mercury Marine	1623-8951A5	827	18-2443	Mercury Marine	1623-8951A23	827
	18-2402	Mercury Marine	1623-5356A4	827	18-2443	Mercury Marine	1623-8951A43	827
	18-2404	Mercury Marine	43-803079T1	841	18-2446	Mercury / BRP		197
	18-2405	Mercury Marine	43-803091T1	841	18-2447			197
	18-2406	Mercury Marine	43-878072A3	840	18-2448			197, 249, 459, 532
	18-2406	Mercury Marine	43-878087A2	840	18-2450	Mercury Marine	1547-3917A13	827
	18-2407	Mercury Marine	43-17064A3	841	18-2450	Mercury Marine	1547-3917A21	827
	18-2407	Mercury Marine	43-42933A2	841	18-2450	Mercury Marine	1547-3917A32	827
	18-2407	Mercury Marine	43-42933A3	841	18-2450	Mercury Marine	1547-3917A37	827
	18-2407	Mercury Marine	43-823072A2	841	18-2450	Mercury Marine	1547-5523A12	827

1 This product is priced per piece. To order, priced per package, please add -9 to the part number

2 Items ending in "D" are display packaged - regular number is non-display

3 For discount shop pack of 10, please add -10 to the part number

SIERRA #	O.E.M.	O.E. #	PAGE #	SIERRA #	O.E.M.	O.E. #	PAGE #
SIERRA							
18-2450	Mercury Marine	1547-5523A2	827	1 18-2513	Mercury Marine	27-67208	420
18-2450	Mercury Marine	1547-5523A68	827	1 18-2514	Mercury Marine	27-53650	420
18-2450	Mercury Marine	1547-5523A9	827	1 18-2516	Mercury Marine	16755	811
18-2450	Mercury Marine	1547-8265A15	827	1 18-2516	Mercury Marine	16755A1	811
18-2450	Mercury Marine	1547-9412A20	827	1 18-2516	Mercury Marine	16755Q1	811
18-2450	Mercury Marine	1547-9412A30	827	1 18-2518	Volvo	430017	985
18-2450	Mercury Marine	1547-9412A35	827	1 18-2519	Volvo	831622	986
18-2451	Mercury Marine	1547-3917A16	827	1 18-25200	Honda	37500-PNB-003	243
18-2451	Mercury Marine	1547-3917A30	827	1 18-25201	Honda	37510-PNB-003	243
18-2451	Mercury Marine	1547-3917A38	827	1 18-2524	Honda	19232-ZV1-A10	247
18-2451	Mercury Marine	1547-3917A4	827	1 18-2525	Volvo	430018	986
18-2451	Mercury Marine	1547-3917A8	827	1 18-25250	Volvo	3863085	986
18-2451	Mercury Marine	1547-5523A11	827	1 18-25251	Volvo	853868	986
18-2451	Mercury Marine	1547-5523A8	827	1 18-2526	Volvo	430172	986
18-2451	Mercury Marine	1547-8265A16	827	1 18-2527	Volvo	831617	986
18-2451	Mercury Marine	1547-9412A21	827	1 18-2528	Volvo	831891	986
18-2452	Mercury Marine	1547-5523A67	827	1 18-2529	Volvo	831892	986
18-2452	Mercury Marine	1547-8265A17	827	1 18-2530	Volvo	1336255	986
18-2452	Mercury Marine	1547-9412A22	827	1 18-2530	Volvo	3547991	986
18-2452	Mercury Marine	1547-9412A36	827	1 18-25300	Yamaha	66M-85540-01-00	474
18-2453	Mercury Marine	1547-5523A49	827	1 18-2531	Volvo	834476	986
18-2453	Mercury Marine	1547-5523A67	827	1 18-2532	OMC	305762	315
18-2453	Mercury Marine	1547-8265A17	827	1 18-2533	OMC	911797	919
18-2453	Mercury Marine	1547-9412A23	827	1 18-2534	Chrysler Force	F184122-1	236
18-2454	OMC	3854539	927	1 18-2534	OMC	309044	315
18-2454	Volvo	3854539	990	1 18-2536	OMC	321120	314
18-2455			202	1 18-2537	OMC	324937	315
18-2460	Mercuriser	11-88462	846	1 18-2539	OMC	328753	314
18-2460	Mercuriser	22-88847A1	846	1 18-25400	Mercury	16066004	358
18-2461	Mercury Marine	17-44166T1	850	1 18-2541	OMC	911704	908
18-2462	Mercury Marine	17-14873A1	850	1 18-2543	OMC	318609	313
18-2462	Mercury Marine	17-85056	850	1 18-2544	OMC	321028	313
18-2463	Mercury Marine	17-14872A1	850	1 18-2545	OMC	321182	311
18-2463	Mercury Marine	17-99207	850	1 18-2546	OMC	321184	314
18-2464	Mercury Marine	17-815953T1	850	1 18-2547	OMC	322858	314
18-2464	Mercury Marine	56-18541A75	850	1 18-2548	OMC	332108	314
18-2464	Mercury Marine	56-864641A24	850	1 18-2549	OMC	321435	311
18-2465-9	Mercury Marine	19-14842	850	1 18-2550	OMC	323214	312
18-2465-9	Mercury Marine	19-148421	850	1 18-25513	Mercury	803844T01	358
18-2466-9	Mercury Marine	19-815951	850	1 18-2552	Mercury Marine	27-331791	808
18-2470	Honda	16221-ZV4-610	248	1 18-2552	Mercury Marine	27-331792	808
18-2471	Honda	16221-ZW9-000	248	1 18-2553	Mercury Marine	27-47510	808
18-2472	Honda	16221-ZW1-000	248	1 18-2553	Mercury Marine	27-47510Q	808
18-2473	Honda	16201-881-850	248	1 18-2554	Mercury Marine	27-41812	808
18-2480	Honda	16010-ZV4-005	247	1 18-2554	Mercury Marine	27-41812Q	808
18-2481	Honda	16010-ZW9-003	247	1 18-2554	Mercury Marine	27-90556	808
18-2482	Honda	16010-881-003	248	1 18-2555	Mercury Marine	27-89656	808
18-2495	Honda	19232-ZV4-610	247	1 18-2555	Mercury Marine	27-896561	808
18-2496	Honda	19233-ZV5-000	247	1 18-2556	Mercury Marine	27-35996	811
18-2499	Honda	19234-ZY3-000	247	1 18-2556	Mercury Marine	27-35996A1	811
1 18-2500	Mercury Marine	27-52893	421	1 18-2557	OMC	324701	314
1 18-2500	Mercury Marine	27-72505	421	1 18-2557	OMC	338484	314
1 18-2500	Mercury Marine	27-85493	421	1 18-2558	Mercury Marine	27-19204-2	423
1 18-25001	Mercury Marine	27-14765	810	1 18-2559	Mercury Marine	27-19202	423
1 18-25001	Mercury Marine	F3860315	810	1 18-2559	Mercury Marine	27-42206	423
1 18-25001	Mercury Marine	FI1110294	810	1 18-2560	Mercury Marine	12-86645	425
1 18-25001	Mercury Marine	FI1110958	810	1 18-2560	Mercury Marine	12-866451	425
1 18-25002	Mercury Marine	27-811588	810	1 18-2560	Mercury Marine	8M0027721	425
1 18-2501	Mercury Marine	27-67738	420	1 18-25600	Yamaha	66M-85520-00-00	474
1 18-2501	Mercury Marine	27-93536	420	1 18-25602	Yamaha	66M-85533-00-00	Obsolete
1 18-2501	Mercury Marine	27-935361	420	1 18-25604	Yamaha	63V-85533-00-00	474
1 18-2502	Mercury Marine	27-87396	421	1 18-2561	Mercury Marine	27-85087	423
1 18-2502	Mercury Marine	27-90484	421	1 18-2562	Mercury Marine	27-99326	424
1 18-2502	Mercury Marine	27-904841	421	1 18-2562	Mercury Marine	27-993261	424
1 18-2503	Mercury Marine	27-78068	423	1 18-2563	Honda	19232-ZW1-003	247
1 18-2503	Mercury Marine	27-99177	423	1 18-2563	Mercury Marine	27-43034	424
1 18-2503	Mercury Marine	27-991771	423	1 18-2563	Mercury Marine	27-430341	424
1 18-2503	Mercury Marine	27-991772	423	1 18-2564	Honda	19234-ZW1-003	247
1 18-2504	Mercury Marine	27-60310	421	1 18-2564	Mercury Marine	27-43033	424
1 18-2504	Mercury Marine	27-74511	421	1 18-2564	Mercury Marine	27-430331	424, 811
1 18-2504	Mercury Marine	27-76401	421	1 18-2565	Honda	19242-ZW1-003	247
1 18-2504	Mercury Marine	27-88449	421	1 18-2565	Mercury Marine	27-43047	424
1 18-2505	Mercury Marine	27-96171	421	1 18-2565	Mercury Marine	27-430471	424
1 18-2505	Mercury Marine	27-961711	421	1 18-2565	Mercury Marine	27-430472	424
1 18-2506-1	Mercury Marine	27-99176	423	1 18-25650	Yamaha	66M-85580-00-00	474
1 18-2506-1	Mercury Marine	27-991762	423	1 18-25651	Yamaha	65W-85580-00-00	Obsolete
1 18-2506-1	Mercury Marine	27-991763	423	1 18-25652	Yamaha	63V-85580-01-00	474
1 18-2506-1	Mercury Marine	27-991764	423	1 18-2566	Mercury Marine	27-817277	424, 812
1 18-2507	Mercury Marine	27-37816	421	1 18-2566	Mercury Marine	27-8172771	424
1 18-2507	Mercury Marine	27-72487	421	1 18-2568	Mercury Marine	27-25848	419
1 18-2507	Mercury Marine	27-78026	421	1 18-2569	Mercury Marine	27-25849	420
1 18-2507	Mercury Marine	27-85487	421	1 18-2570	Mercury Marine	27-25851	420
1 18-2508-1	Mercury Marine	27-96440	423	1 18-2570	Mercury Marine	27-34614	420
1 18-2508-1	Mercury Marine	27-99776	423	1 18-2571	Mercury Marine	27-31402	419
1 18-2508-1	Mercury Marine	27-997761	423	1 18-2572	Mercury Marine	27-22023	419
1 18-2509	Mercury Marine	27-67751	419	1 18-2572	Mercury Marine	27-63309	419
1 18-2510	Mercury Marine	27-96761	420	1 18-2573	Mercury Marine	27-60475	421
1 18-2510	Mercury Marine	27-967611	420	1 18-2573	Mercury Marine	27-72142	421
1 18-2511	Mercury Marine	27-99173-2	423	1 18-2573	Mercury Marine	27-721421	421
1 18-2512	Mercury Marine	27-60286	420	1 18-2574	Mercury Marine	27-60476	421
1 18-2513	Mercury Marine	27-11338	420	1 18-2574	Mercury Marine	27-72507	421

1 This product is priced per piece. To order, priced per package, please add -9 to the part number

2 Items ending in "D" are display packaged - regular number is non-display

3 For discount shop pack of 10, please add -10 to the part number

SIERRA #	O.E.M.	O.E. #	PAGE #	SIERRA #	O.E.M.	O.E. #	PAGE #
SIERRA							
1	18-2574	Mercury Marine	27-85495	421	18-2630	Chrysler Force	FK1060 237
1	18-2574	Mercury Marine	27-854951	421	18-2631	Chrysler Force	FK1061 237
1	18-2574	Mercury Marine	27-854952	421	18-26310-2	Mallory	YLM700AV 164
1	18-2575	Mercury Marine	1399-99	420	18-26311-2	Mallory	YLM566AV 164
	18-2579	OMC	338882	309	18-2632	Chrysler Force	FK1063-1 237
	18-2582	OMC	338813	309	18-2632	Chrysler Force	FK1063-2 237
	18-2583	Volvo	3888821	993	18-2633	Chrysler Force	FK1127 237
	18-2584	Volvo	3888822	993	18-2635	Chrysler Force	26-814669A1 237
	18-2586	Volvo	3850594	992	18-2635	Chrysler Force	26-814669A2 237
	18-2587	Mercury Marine	99356A2	558	18-2635	Chrysler Force	FK1234 237
	18-2588			558	18-2635	Mercury Marine	26-814669A2 442
	18-2589			558	18-2636	Chrysler Force	26-820645A 237
	18-2590	Borg-Warner	A4876HA	559	18-2636	Chrysler Force	FK1074 237
	18-2591			559	18-2637-1	Chrysler Force	FK1064 237
	18-2592	Yamaha	6E5-14384-03-00	529	18-2638	Chrysler Force	FK1065 237
	18-2593	Mercury Marine	27-194541	424	18-2639	Chrysler Force	FK1068 237
	18-2595	OMC	982132	347	18-2640	Chrysler Force	FK1203 237
	18-2596	Volvo	875422	981	18-2640	Chrysler Force	FK1203-1 237
	18-2597			993	18-2642	Mercury Marine	26-816575A5 442
	18-2598	Volvo	3855275	992	18-2643	Mercury Marine	26-16709A1 854
	18-2599	Mercury Marine	26-816575A2	441, 832	18-2643	Mercury Marine	26-16709A2 854
	18-2600			836	18-2644	Mercury Marine	26-88397A1 854
	18-26002-1			683	18-2645	Mercury Marine	26-76868A04 855
	18-2601-1	Mercury Marine	30-803097T1	833	18-2645	Mercury Marine	26-76868A1 855
	18-2603	Mercury Marine	19543T1	836	18-2645	Mercury Marine	26-76868A2 855
	18-2603	Mercury Marine	19543T2	836	18-2646-1	Mercury Marine	26-816575A1 443
	18-2603	Mercury Marine	865436A03	836	18-2646-1	Mercury Marine	26-816575A3 443
	18-2603E	Mercury Marine	19543T1	836	18-2648	Mercury Marine	26-32511A1 855
	18-2603E	Mercury Marine	19543T2	836	18-2649	Mercury Marine	25-87400A2 851
	18-2603E	Mercury Marine	865436A03	836	18-2652	Mercury Marine	26-33144A1 855
	18-2604	Mercury Marine	815471T1	836	18-2652	Mercury Marine	26-33144A2 855
	18-2604E	Mercury Marine	815471T1	836	18-2652	Mercury Marine	26-89238A1 855
	18-2605	Yamaha	90119-08M87-00	497	18-2653	Mercury Marine	26-55682A1 443
	18-2606	Yamaha	90119-08M13-00	497	18-2654	Mercury Marine	26-79831A1 443
	18-2607	Yamaha	97095-06040-00	497	18-2655	Mercury Marine	26-89238A2 443
	18-2608	Honda	19232-881-850	247	18-2656	OMC	396350 343
	18-2609	Honda	19234-881-850	247	18-2657	OMC	396352 343
	18-2610	Mercury Marine	27-812755	422	18-2658	OMC	396351 344
	18-2610	Mercury Marine	27-8127754	422	18-2659	OMC	396355 344
	18-26104-1	Mallory	YL567EV	165, 685, 869	18-2660	OMC	396349 344
	18-26107-1	Mallory	YL700AV	165	18-2663	OMC	981797 928
	18-2611	Mercury Marine	27-8127551	422	18-2664	OMC	982947 928
	18-2611	Mercury Marine	27-812755A01	422	18-2665	OMC	982946 928
	18-2611	Mercury Marine	27-8127755	422	18-2666	OMC	981799 928
	18-26110-1	Mallory	YL579AV	165, 685, 869	18-2667	OMC	982949 929
	18-26111-1	Mallory	YL648AV	165, 683	18-2669	OMC	981801 929
	18-2613	OMC	508105	906	18-2671	OMC	985612 929
2	18-2614	Mercury Marine	27-64818	814	18-2672	OMC	439967 929
2	18-2614	Mercury Marine	27-45821	814	18-2672	OMC	984458 929
2	18-2614	Mercury Marine	27-64818A1	814	18-2672	OMC	985613 929
2	18-2614	Mercury Marine	27-64818A20	814	18-2673	OMC	984459 930
2	18-2614	Mercury Marine	27-64818A4	814	18-2673	OMC	986364 930
2	18-2614	Mercury Marine	27-64818Q4	814	18-2673	OMC	987603 930
2	18-2614	Mercury Marine	27-64818T1	814	18-2674	OMC	985518 930
	18-2615	Mercury Marine	16755	814	18-2674	OMC	986423 930
	18-2615	Mercury Marine	16755A1	814	18-2679		
	18-2615	Mercury Marine	16755Q1	814	18-2680		
	18-2615	Mercury Marine	16755T1	814	18-26800	Mallory	670 165
	18-2617	Mercury Marine	27-35996	814	18-2681		
	18-2617	Mercury Marine	27-35996A1	814	18-26810		165, 596, 625, 680, 865, 946
2	18-2619-1	Mercury Marine	27-64818A2	814	18-26811		165, 596, 625, 680, 865, 946
2	18-2619-1	Mercury Marine	27-64818A3	814	18-26812		165, 596, 625, 680, 865, 946
2	18-2619-1	Mercury Marine	27-64818A3	814	18-26813		165, 596, 625, 680, 865, 946
2	18-2619-1	Mercury Marine	27-94996	814	18-26815	Mallory	29349 165
2	18-2619-1	Mercury Marine	27-94996A1	814	18-2682		344
2	18-2619-1	Mercury Marine	27-94996A2	814	18-26820		166
2	18-2619-1	Mercury Marine	27-94996A20	814	18-26821		166
2	18-2619-1	Mercury Marine	27-94996Q2	814	18-2683		344
2	18-2619-1	Mercury Marine	27-94996T2	814	18-2684		344
	18-2620	Mercury Marine	27-54014	814	18-2685		344
	18-2620	Mercury Marine	27-54014A1	814	18-2686		345
	18-2620	Mercury Marine	27-54014Q1	814	18-2687		345
	18-2620	Mercury Marine	27-54014T1	814	18-2688		345
	18-2621	Mercury Marine	27-139581	420	18-2689		345
	18-2622	Mercury Marine	23-79373A1	832	18-2690		345
	18-2622	Mercury Marine	23-805041A2	832	18-2691		345
	18-2622	Mercury Marine	27-45588	832	18-2692		345
	18-2622	Mercury Marine	27-79373	832	18-2694	OMC	433550 345
	18-2623	OMC	439141	343	18-2697-1	Chrysler Force	26-41365A3 237
	18-2624	Chrysler Force	26-85090A2	236	18-2697-1	Mercury Marine	26-41365A3 444
	18-2624	Mercury Marine	26-85090A2	441	18-2698		926
	18-2625	Volvo	875192	993	18-2699		906, 981
	18-2626	Chrysler Force	26-43035A4	236	18-2700	Mercury Marine	896173A01 440
	18-2626	Mercury Marine	26-43034A1	441	18-2700	Mercury Marine	8M0045604 440
	18-2626	Mercury Marine	26-43034A2	441	1 18-2701	Mercury Marine	23-45736 853
	18-2626	Mercury Marine	26-43034A3	441	1 18-2701	Mercury Marine	23-61290 853
	18-2626	Mercury Marine	26-43035A4	441	1 18-2701	Mercury Marine	23-89574 853
	18-2627	Mercury Marine	26-66303A1	441	2 18-2701-04	Mercury Marine	23-45736 853
	18-2628	Mercury Marine	26-77066A1	442	2 18-2701-04	Mercury Marine	23-61290 853
	18-2629	Chrysler Force	26-85090A1	442	2 18-2701-04	Mercury Marine	23-89574 853
	18-2629	Mercury Marine	26-85090A1	442	2 18-2702-04	Mercury Marine	23-99291 853

1 This product is priced per piece. To order, priced per package, please add -9 to the part number

2 Items ending in "D" are display packaged - regular number is non-display

3 For discount shop pack of 10, please add -10 to the part number

SIERRA #	O.E.M.	O.E. #	PAGE #	SIERRA #	O.E.M.	O.E. #	PAGE #		
SIERRA									
2	18-2702-04	Mercury Marine	23-99291T	853	18-2744	Volvo	876294	988	
1	18-2702-1	Mercury Marine	23-99291	853	18-2745	OMC	912374	919	
1	18-2702-1	Mercury Marine	23-99291T	853	18-2746	Mercury Marine	31-14358001	834	
1	18-2702-1	Pleasurecraft	R094020A	853	18-2746	Mercury Marine	32-14358	834	
1	18-2703	OMC	314008	315	18-2746	Mercury Marine	32-14358T	834	
1	18-2704	OMC	320943	315	18-2747	Mercury Marine	816431A1	834	
1	18-2705	OMC	315748	315	18-2748	Mercury Marine	31-44348001	834	
1	18-2706	OMC	321008	315	18-2748	Mercury Marine	32-44348	834	
1	18-2707	Mercury Marine	97351	843	18-2748	Mercury Marine	32-44348T	834	
1	18-2708	OMC	333758	315	18-2749	Mercury Marine	27-812867	421	
1	18-2709	OMC	336530	314	18-2749	Mercury Marine	27-8128671	421	
	18-2710	Mercury Marine	27-41417	420	18-2750	Mercury Marine	32734	834	
	18-2710	Mercury Marine	27-414171	420	18-2750	Mercury Marine	18654A1	834	
	18-2710	Mercury Marine	27-414172	420	18-2750	Mercury Marine	32734A3	834	
	18-2710	Mercury Marine	27-85978	420	18-2751	Mercury Marine	60932A1	834	
	18-2712	Mercury Marine	27-41418	420	18-2751	Mercury Marine	60932A4	834	
	18-2712	Mercury Marine	27-414181	420	18-2752	Mercury Marine	36223	834	
	18-2712	Mercury Marine	27-85979	420	18-2752	Mercury Marine	36223A1	834	
	18-2713	Mercury Marine	27-43337	422	18-2752	Mercury Marine	36223A2	834	
	18-2713	Mercury Marine	27-433371	422	2	18-2753-2	Mercury Marine	31659	834
	18-2713	Mercury Marine	27-433372	422	2	18-2753-2	Mercury Marine	74639	834
	18-2713	Mercury Marine	27-433373	422	2	18-2753-2	Mercury Marine	74639A2	834
	18-2713	Mercury Marine	27-433374	422	18-2755	Volvo	875827	988	
	18-2713	Mercury Marine	27-43337A1	422	18-2756	Mercury Marine	86840A05	834	
	18-2713	Mercury Marine	27-96286	422	18-2756	Mercury Marine	86840A3	834	
	18-2714	Mercury Marine	27-414992	422	18-2756	Mercury Marine	8M0062406	834	
	18-2714	Mercury Marine	27-414993	422	18-2757	Volvo	875828	988	
	18-2714	Mercury Marine	27-414994	422	18-2757	Volvo	876633	988	
	18-2714	Mercury Marine	27-414995	422	18-2758	Volvo	875848	988	
	18-2714	Mercury Marine	27-892157	422	18-2758	Volvo	876631	988	
	18-2715	Mercury Marine	24-17997A1	833	18-2759	Mercury Marine	53114	834	
	18-2716	Mercury Marine	27-41499	422	18-2759	Mercury Marine	53114A1	834	
	18-2716	Mercury Marine	27-414991	422	18-2760	Mercury Marine	78458	834	
	18-2716	Mercury Marine	27-92332	422	18-2760	Mercury Marine	78458A1	834	
	18-2717	Mercury Marine	27-41475	422	18-2761	Mercury Marine	32-90949	834	
	18-2717	Mercury Marine	27-414751	422	18-2761	Mercury Marine	32-90949T	834	
	18-2717	Mercury Marine	27-414752	422	18-2762	Mercury Marine	70981	834	
	18-2717	Mercury Marine	27-414753	422	18-2762	Mercury Marine	70981A3	834	
	18-2717	Mercury Marine	27-414754	422	2	18-2763	OMC	911826	919
	18-2717	Mercury Marine	27-414755	422	18-2764	OMC	914036	919	
	18-2717	Mercury Marine	27-414756	422	18-2765	OMC	983973	919	
	18-2717	Mercury Marine	27-414757	422	18-2765	OMC	987467	919	
	18-2717	Mercury Marine	27-414758	422	18-2765	OMC	3854127	919	
	18-2717	Mercury Marine	27-892158	422	18-2765	Volvo	3854127	988	
	18-2717	Mercury Marine	27-92331	422	18-2766	Volvo	834751	988	
	18-2721	Mercury Marine	27-827284	420	18-2766	Volvo	834751	988	
	18-2724	Mercury Marine	43713	833	18-2767	OMC	313080	919	
	18-2725	Mercury Marine	26-830749A01	444	18-2768	OMC	909527	919	
	18-2726	Volvo	3888917	992	1	18-2769	OMC	332000	315
	18-2727	Mercury Marine	60930	735	18-2770	Mercury Marine	32-807458T	834	
	18-2728	Mercury Marine	26-42102	425	18-2771			918	
	18-2728	Mercury Marine	26-421021	425	18-2772-1			918, 988	
	18-2729	Mercury Marine	27-8128672	420	18-2773	Yamaha	663-45331-00-94	532	
	18-2730-9	Mercury Marine	26-80239M	425	18-2774	Volvo	875847	973	
	18-2731	Mercury Marine	26-81607M	425	18-2775	Volvo	875822	973	
1	18-2732	Mercury Marine	807166A3	735	18-2776	Volvo	832831	973	
	18-2733	Mercury Marine	92802	735	18-2777	Volvo	854031	973	
	18-2733	Mercury Marine	99370A2	735	18-2778	Volvo	832846	973	
	18-2735	Mercury Marine	27-190506	422	18-2779	OMC	3852696	899	
	18-2736	Mercury Marine	27-863891	417	18-2779	Volvo	3852696	963	
	18-2736	Mercury Marine	27-863893	417	18-2780-1	OMC	3852741	963	
	18-2736	Mercury Marine	27-863895	417	18-2780-1	Volvo	3852741	963	
	18-2737	Mercury Marine	27-850283	420	18-2780-1	Volvo	3863450	963	
	18-2739	Mercury Marine	27-832933006	422	18-2780-1	Volvo	3863450	963	
	18-2739	Mercury Marine	27-8329331	422	18-2781	OMC	3852742	899	
	18-2739	Mercury Marine	27-8329332	422	18-2781	Volvo	3852742	963	
	18-2739	Mercury Marine	27-8329333	422	18-2782	Yamaha	688-45331-00-94	532	
	18-2739	Mercury Marine	27-8329334	422	18-2783	OMC	986629	930	
	18-2739	Mercury Marine	27-8329335	422	18-2785	Mercury Marine	27-41899M	444	
	18-2740	Mercury Marine	27-430051	421	18-2785	Yamaha	689-W0001-21-00	547	
	18-2740	Mercury Marine	27-430052	421	18-2785	Yamaha	689-W0001-C1-00	547	
	18-2740	Mercury Marine	27-430053	421	18-2787	Mercury Marine	27-92648M	444	
	18-2740	Mercury Marine	27-430055	421	18-2787	Yamaha	698-W0001-20-00	547	
	18-2740	Mercury Marine	27-430056	421	18-2787	Yamaha	698-W0001-C0-00	547	
	18-2740	Mercury Marine	27-430057	421	18-2788	Yamaha	6H3-W0001-21-00	548	
	18-2741	Mercury Marine	27-43004009	422	18-2788	Yamaha	6H3-W0001-C1-00	548	
	18-2741	Mercury Marine	27-430041	422	18-2789	Yamaha	6J8-W0001-21-00	548	
	18-2741	Mercury Marine	27-430042	422	18-2789	Yamaha	6J8-W0001-C2-00	548	
	18-2741	Mercury Marine	27-430043	422	18-2791	OMC	987251	930	
	18-2741	Mercury Marine	27-430045	422	18-2791	OMC	3850597	930	
	18-2741	Mercury Marine	27-430047	422	18-2791	Volvo	3850597	993	
	18-2742	Mercury Marine	85552	441	18-2792	Yamaha	6H4-W0001-20-00	548	
	18-2743	Mercury Marine	27-64818A2	811	18-2792	Yamaha	6H4-W0001-21-00	548	
	18-2743	Mercury Marine	27-94996	811	18-2793	Volvo	875550	977	
	18-2743	Mercury Marine	27-949962	811	18-2794-1	Yamaha	6E5-W0001-51-00	548	
	18-2743	Mercury Marine	27-94996A1	811	18-2794-1	Yamaha	6E5-W0001-F1-00	548	
	18-2743	Mercury Marine	27-94996A2	811	18-2794-1	Yamaha	6F3-W0001-21-00	548	
	18-2743	Mercury Marine	27-94996A20	811	18-2794-1	Yamaha	6F3-W0001-C1-00	548	
	18-2743	Mercury Marine	27-94996A3	811	18-2794-1	Yamaha	6G5-W0001-21-00	548	
	18-2743	Mercury Marine	27-94996Q2	811	18-2794-1	Yamaha	6G5-W0001-C1-00	548	
	18-2744	Volvo	875826	988	18-2798	Yamaha	688-W0001-20-00	548	
					18-2798	Yamaha	688-W0001-C0-00	548	

1 This product is priced per piece. To order, priced per package, please add -9 to the part number

2 Items ending in "D" are display packaged - regular number is non-display

3 For discount shop pack of 10, please add -10 to the part number

SIERRA #	O.E.M.	O.E. #	PAGE #	SIERRA #	O.E.M.	O.E. #	PAGE #
SIERRA							
18-2799	Yamaha	61A-W0001-21-00	548	18-2832-1	Mercury Marine	27-480431	782, 809
18-2799	Yamaha	61A-W0001-C1-00	548	18-2832-1-9	Mercury Marine	27-48043	782, 809
1 18-2800	Mercury Marine	27-26891	419	18-2832-1-9	Mercury Marine	27-480431	782, 809
1 18-2800	Mercury Marine	27-69659	419	1 18-2833	Mercury Marine	27-52076	809
1 18-2800	Mercury Marine	27-75791	419	1 18-2833	Mercury Marine	27-99777	809
1 18-2800	Mercury Marine	27-757911	419	1 18-2833	Mercury Marine	27-997771	809
1 18-2801	Mercury Marine	27-32438	424	1 18-2833	Mercury Marine	27-997772	809
18-28019	Chrysler Inboard	3745215	172	1 18-2834	Mercury Marine	27-60208	808
1 18-2802	Mercury Marine	27-48164	419	1 18-2835	Mercury Marine	27-60479	423
1 18-2802	Mercury Marine	27-481641	419	1 18-2835	Mercury Marine	27-64173	423
1 18-2803	Mercury Marine	27-90430	419	1 18-2835	Mercury Marine	27-66101	423
1 18-2803	Mercury Marine	27-904301	419	1 18-2835	Mercury Marine	27-69238	423
18-28033	Mercuriser		172	1 18-2835	Mercury Marine	27-692381	423
1 18-2804	Mercury Marine	27-73377	419	1 18-2836	Mercury Marine	27-31439	421
1 18-2804	Mercury Marine	27-733771	419	1 18-2836	Mercury Marine	27-46233	421
18-28042	Universal		172	1 18-2836	Mercury Marine	27-72919	421
18-28043	Pleasurecraft		172	1 18-2836	Mercury Marine	27-78035	421
18-28044	Pleasurecraft		172, 173, 562	1 18-2837	Mercury Marine	27-31436	422
18-28044	Volvo Penta		172, 173, 562	1 18-2837	Mercury Marine	27-41382	422
18-28046	OMC		172	1 18-2837	Mercury Marine	27-66358	422
18-28046	Pleasurecraft		172	1 18-2837	Mercury Marine	27-72918	422
1 18-2805	Mercury Marine	27-85490-2	415, 421	1 18-2837	Mercury Marine	27-78087	422
1 18-28050	Volvo	845363	172, 178, 179, 944	1 18-2838	Mercury Marine	27-55279	421
1 18-2806	Mercury Marine	27-65788	421	1 18-2838	Mercury Marine	27-552791	421
1 18-2807	Mercury Marine	27-53863	421	1 18-2839	Mercury Marine	27-60477	421
1 18-2807	Mercury Marine	27-64940	421	1 18-2839	Mercury Marine	27-72509	421
1 18-2807	Mercury Marine	27-72506	421	1 18-2839	Mercury Marine	27-85497	421
1 18-2807	Mercury Marine	27-85494	421	1 18-2839	Mercury Marine	27-854971	421
1 18-2807	Mercury Marine	27-98185	421	1 18-2839	Mercury Marine	27-854972	421
1 18-2807	Mercury Marine	27-981851	421	1 18-2840	Mercury Marine	27-35982	811
1 18-2807	Mercury Marine	27-9818512	421	1 18-2841	Mercury Marine	27-19552	424
1 18-2807	Mercury Marine	27-981853	421	1 18-2841	Mercury Marine	27-77417	424
1 18-2808	Mercury Marine	27-96278	421	1 18-2843	Mercury Marine	27-74830	808
18-28080	Mercury	84-821945A56	171, 363	1 18-2844	Mercury Marine	27-48818	808
18-28081	Mercury	84-813706A56	171, 363	1 18-2844	Mercury Marine	27-488181	808
18-28082	Mercury	84-813715A8	171, 363	1 18-2844	Mercury Marine	27-48818Q1	808
18-28083	Mercury	84-881908T	171, 363	18-2845	Chris-Craft	16.11-01236	571
18-28084	Mercury	84-881908T	171, 363	18-2845	Crusader	91351	612
18-28085	Mercury	84-881908T	171, 363	18-2845	Mercury Marine	27-11999	810
18-28086	Mercury	84-881908T	171, 363	18-2845	Mercury Marine	27-34043	810
1 18-2809	Mercury Marine	27-43779	423	18-2845	Mercury Marine	27-52202	810
1 18-2809	Mercury Marine	27-437791	423	18-2845	Mercury Marine	FI101236	810
1 18-2809	Mercury Marine	27-437792	423	18-2845	Mercury Marine	FI5000161	810
1 18-2809	Mercury Marine	27-96485	423	18-2845	OMC	912965	909
18-28090	Johnson/Evinrude		171, 258	1 18-2847	Mercury Marine	27-54014	811
18-28092	Johnson/Evinrude		258	1 18-2847	Mercury Marine	27-54014A1	811
1 18-2810	Mercury Marine	27-43777	422	1 18-2847	Mercury Marine	27-54014Q1	811
1 18-2810	Mercury Marine	27-437771	422	1 18-2847	Mercury Marine	27-54014T1	811
1 18-2810	Mercury Marine	27-437772	422	1 18-2848	Mercury Marine	18-52457	808
1 18-2810	Mercury Marine	27-96483	422	1 18-2848	Mercury Marine	18-524571	808
18-28100			172, 634	1 18-2848	Mercury Marine	27-524572	808
18-28101			172, 634	1 18-2849-1	Mercury	27-860232	809
18-28102			172, 634	1 18-2849-1	Mercury	27-863726	809
18-2813	Volvo	876302	981	1 18-2849-1	Mercury	27-87105	809
18-2814	Volvo	876306	981	1 18-2849-1	Mercury Marine	27-818832	809
18-2815	Mercury Marine	27-814703	811	1 18-2849-1	Mercury Marine	27-871051	809
18-2815	Mercury Marine	FI5000119	811	1 18-2850-1	OMC	908935	900
18-2815	Mercury Marine	FI5000199	811	1 18-2851	OMC	313368	910
18-2815	OMC	913276	910	1 18-2852	OMC	330621	312
18-2815	OMC	3852692	910	1 18-2853	OMC	318925	311
18-2815	Volvo	3852692	984	1 18-2854-1	Barr	01-0107	571, 611, 631, 643, 782, 900, 971
18-28150			166, 644	1 18-2855	OMC	314082	314
18-28151			166, 644	1 18-2856	OMC	319665	313
18-2817	Volvo	876359	982	1 18-2857	OMC	319771	310
18-28175			166, 645	1 18-2857	OMC	386573	310
1 18-2818	Volvo	876433	982	1 18-2857	OMC	314809	907
1 18-2819-1	Mercury Marine	27-39915	782	1 18-2858	OMC	3852127	984
1 18-2820	Mercury Marine	27-45821	811	1 18-2858	Volvo	311131	908
1 18-2820	Mercury Marine	27-64818	811	1 18-2859	OMC	311130	908
1 18-2820	Mercury Marine	27-64818A1	811	1 18-2860	OMC	311121	908
1 18-2820	Mercury Marine	27-64818A20	811	1 18-2861-1	OMC	321573	311
1 18-2820	Mercury Marine	27-64818A4	811	1 18-2862	OMC	326260	311
1 18-2820	Mercury Marine	27-64818Q4	811	1 18-2862	OMC	308799	910
1 18-2823	Mercury Marine	27-19553	424, 812	1 18-2863	OMC	321727	312
1 18-2823	Mercury Marine	27-32769	424, 812	1 18-2864	OMC	313763	312
1 18-2824	Mercury Marine	27-19551	424, 812	1 18-2865	OMC	317914	311
1 18-2824	Mercury Marine	27-32770	424, 812	1 18-2866	OMC	319174	311
1 18-2825	Mercury Marine	27-32771	424, 812	1 18-2867	OMC	310137	312
1 18-2826	Mercury Marine	27-85610	424, 812	1 18-2868	OMC	305312	315
1 18-2826	Mercury Marine	27-856101	424, 812	1 18-2869	OMC	305176	311
1 18-2826	Mercury Marine	27-856704	424, 812	1 18-2870	OMC	304762	311
1 18-2827	Mercury Marine	27-39623	424	1 18-2871	OMC	307257	313
1 18-2828	Mercury Marine	27-39625	424	1 18-2872	OMC	318334	313
18-2830-1	Mercury Marine	879036	809	1 18-2872	OMC	318335	313
18-2830-1	Mercury Marine	27-33121	809	1 18-2873	OMC	314876	314
18-2830-1	Mercury Marine	27-46401	809	1 18-2874	OMC	908013	900, 908
18-2830-1	Mercury Marine	27-52584	809	18-2875-1	OMC	3850495	900, 908
18-2830-1	OMC	907932	908	18-2875-1	OMC	3850495	971
1 18-2831	Mercury Marine	27-47590	808	18-2875-1-9	Volvo	908013	900
1 18-2831	Mercury Marine	27-475901	808	18-2875-1-9	OMC	3850495	900
18-2832-1	Mercury Marine	27-48043	809	18-2875-1-9	OMC	3850495	900

1 This product is priced per piece. To order, priced per package, please add -9 to the part number

2 Items ending in "D" are display packaged - regular number is non-display

3 For discount shop pack of 10, please add -10 to the part number

SIERRA #	O.E.M.	O.E. #	PAGE #	SIERRA #	O.E.M.	O.E. #	PAGE #	
SIERRA								
1	18-2875-1-9	Volvo	3850495	900	18-2926	Volvo	1378864	985
1	18-2876	OMC	307133	313	18-2927	Volvo	463999	985
1	18-2877	OMC	314421	312	18-2927	Volvo	1378909	985
1	18-2878	OMC	319710	312	18-2928	Volvo	824633	984
1	18-2879	OMC	312634	310	18-2928	Volvo	856044	984
1	18-2879	OMC	331363	310	1 18-2929	Volvo	856028	987
1	18-2879	OMC	338876	310	18-2930	Volvo	1266796	984
1	18-2880	OMC	304023	314	18-2930	Volvo	1378879	984
1	18-2881	OMC	125530	316	18-29322	Volvo	3854215	940
1	18-2881	OMC	332403	316	18-29322	Volvo	3854217	940
1	18-2883-1	OMC	907775	908	18-29322			620, 865
1	18-2884	OMC	313782	306	1 18-2933	Volvo	416033	984
1	18-2885	OMC	303438	306	1 18-2933	Volvo	1317466	984
1	18-2886	OMC	203171	312	1 18-2934	Volvo	829714	986
1	18-2887	OMC	302557	316	1 18-2935	Volvo	418411	986
1	18-2888	OMC	326953	306	1 18-2936	Volvo	418445	986
1	18-2888	OMC	332010	306	1 18-2937	Volvo	418412	986
1	18-2889	OMC	302675	310	1 18-2938	OMC	331917	312
1	18-2890	OMC	302994	309	1 18-2939	Volvo	814356	987
1	18-2890	OMC	331203	309	1 18-2941	Chrysler Inboard	2469559	588
1	18-2890	OMC	338886	309	1 18-2941	Chrysler Inboard	2847480	588
1	18-2891	OMC	303339	315	18-2943	Mercury Marine	27-443281	421
1	18-2892	OMC	303355	310	18-2943	Mercury Marine	27-443282	421
1	18-2893	OMC	303750	309	18-2943	Mercury Marine	27-443283	421
1	18-2894	OMC	304314	312	18-2943	Mercury Marine	27-443284	421
1	18-2896-1	Mercury Marine	27-32816	782, 810	1 18-2944	Mercury Marine	26-45577	812
1	18-2896-1	Mercury Marine	27-52546	782, 810	1 18-2944	Mercury Marine	26-455771	812
1	18-2896-1	OMC	311068	900, 908	1 18-2945	Mercury Marine	12-19183	425, 812
1	18-2898	OMC	309956	312	1 18-2945	Mercury Marine	12-191832	425, 812
1	18-2900	OMC	312679	310	1 18-2945	Mercury Marine	12-191833	425, 812
1	18-2900	OMC	332694	310	1 18-2945	Mercury Marine	12-20260	425, 812
1	18-2900	OMC	338879	310	1 18-2945	Mercury Marine	F50556	425, 812
1	18-2901	OMC	306205	313	1 18-2945	Mercury Marine	F8077	425, 812
1	18-2901	OMC	313065	313	1 18-2945	Mercury Marine	F8186	425, 812
1	18-2902-1	OMC	909314	900	1 18-2945	OMC	307552	328, 911
1	18-2902-1	Volvo	3852468	972	1 18-2945			248, 987
1	18-2902-1-9	OMC	909314	900	18-2945-1-9			248, 328, 812, 987
1	18-2902-1-9	Volvo	3852468	972	18-2946	Chris-Craft	16.50-00204	571
1	18-2903	OMC	332696	309	18-2946	Mercury Marine	27-52364	807
1	18-2903	OMC	338880	309	18-2946	Mercury Marine	27-81084	807
1	18-2904	OMC	319348	313	18-2946	Mercury Marine	F15000204	807
1	18-2905	OMC	329920	303, 313	18-2946	OMC	908611	907
1	18-2906	OMC	333418	309	18-2946	OMC	3853336	907
1	18-2906	OMC	338884	309	18-2946	Volvo	908611	982
1	18-2907	OMC	325721	303, 313	18-2946	Volvo	3853336	982
1	18-2908	OMC	331499	309	1 18-2947	OMC	310913	908
1	18-2908	OMC	338878	309	1 18-2948	Mercury Marine	12-23245	425, 812
1	18-2909	Crusader	97498	611	1 18-2948	Mercury Marine	12-49221	425, 812
1	18-2909	Mercury Marine	27-99757	810	1 18-2948	Mercury Marine	12-492211	425, 812
1	18-2909	OMC	915025	909	1 18-2949	Barr	CHV-47-000	571, 611, 631, 643, 782, 900, 972
1	18-2909	Volvo	856116	970				
1	18-2909	Volvo	3853412	970	1 18-2949	Crusader	96306	611
1	18-2909	Yamaha	YSC-12190-00-AC	995	1 18-2949	Mercury Marine	27-33395	782, 810
1	18-2909			618, 782	1 18-2949	Volvo	835966	984
1	18-2911	OMC	910236	910	1 18-2949	Volvo	856034	984
1	18-2912-1	Mercury Marine	27-53354	782	18-2950	OMC	309612	306
1	18-2912-1	OMC	908079	908	18-2950	OMC	766870	306
1	18-2913	OMC	319097	312	18-2951	OMC	304720	306
1	18-2913	OMC	331916	312	18-2952	OMC	203034	306
1	18-2914	Mercury Marine	27-30603	425, 812	18-2954	OMC	319633	306
1	18-2914	Mercury Marine	27-32433	425, 812	18-2956	OMC	318358	306
1	18-2914	Mercury Marine	27-85608	425, 812	18-2957	OMC	307069	306
1	18-2914	Mercury Marine	27-856081	425, 812	18-2958	OMC	315539	306
1	18-2914	Mercury Marine	27-8M0090319	425, 812	18-2959	OMC	306048	306
1	18-2915	Mercury Marine	27-30604	425, 812	18-2960	OMC	313413	306
1	18-2915	Mercury Marine	27-32434	425, 812	18-2961	OMC	329103	306
1	18-2915	Mercury Marine	27-85609	425, 812	18-2962	OMC	322332	306
1	18-2915	Mercury Marine	27-856091	425, 812	18-2963	OMC	318914	306
1	18-2915	Mercury Marine	27-858524	425, 812	18-2963	OMC	320533	306
1	18-2915	Mercury Marine	27-858524	425, 812	18-2963	OMC	330818	306
1	18-2916	OMC	911702	910	18-2964	OMC	320745	307
1	18-2917	GM	3701777	907	18-2964	OMC	335360	307
1	18-2917	Mercury Marine	27-33179	808	18-2964	OMC	766779	307
1	18-2917	Mercury Marine	27-53045	808	18-2965	Volvo	419310	982
1	18-2917	Mercury Marine	27-530451	808	18-2965	Volvo	419763-8	982
1	18-2917	Mercury Marine	F10077105	808	18-2966	Volvo	462623	982
1	18-2917	Mercury Marine	F11101276	808	18-2968	Volvo	1378645	982
1	18-2917	Mercury Marine	F11101291	808	18-2970	Volvo	1378646	982
1	18-2917	Mercury Marine	F15000096	808	18-2971-1	Volvo	835908-5	972
1	18-2917	OMC	312797	907	18-2971-1	Volvo	856039-3	972
1	18-2918	OMC	911836	911	18-29716	Mallory	29716	644
1	18-2918	OMC	915840	911	18-29717	Mallory	29217	644
1	18-2919	Mercury Marine	27-42631	425, 812	18-2972	Volvo	1378870	985
1	18-2919	Mercury Marine	27-426311	425, 812	18-29720	Mallory	29440M	644
1	18-2922	Volvo	418870	984	18-29723			644
1	18-2922	Volvo	1378911	984	18-2974	Volvo	418265	984
1	18-2923	Volvo	419678	985	18-2980	Volvo	875401	982
1	18-2924	Volvo	430039	985	18-2980	Volvo	876356	982
1	18-2925	Volvo	461092	984	18-2982	Volvo	875569	982
1	18-2925	Volvo	1378913	984	18-2982	Volvo	876358	982
1	18-2926	Volvo	463587	985	18-2983	Volvo	875400	982

1 This product is priced per piece. To order, priced per package, please add -9 to the part number
 2 Items ending in "D" are display packaged - regular number is non-display
 3 For discount shop pack of 10, please add -10 to the part number

SIERRA #	O.E.M.	O.E. #	PAGE #	SIERRA #	O.E.M.	O.E. #	PAGE #		
SIERRA									
1	18-2983	Volvo	876342	982	2	18-3046	Jabsco	18838-0001	555
1	18-2989	Volvo	824677	984	2	18-3046	Sherwood Pump	9959K	557
1	18-2990	Volvo	832669	987	2	18-3046	Volvo	3854286	964
	18-2991-1	Volvo	855383	984		18-3047	Jabsco	18948-0001	555
	18-2991-1	Volvo	855967	972, 984		18-3047	Sherwood Pump	10615K	557
	18-2991-1-9	Volvo	855383	972, 984		18-3047	Volvo	835874	964
	18-2991-1-9	Volvo	855967	972, 984		18-3047			579, 601
1	18-2994	Volvo	430020	987		18-3049	Suzuki	17461-87E11	464
1	18-2995	Volvo	856037	984		18-3049	Suzuki	17461-87E12	464
1	18-2996	OMC	911823	911	3	18-3050	OMC	386084	276
1	18-2996	OMC	3852560	911		18-3051	OMC	395289	276
1	18-2996	Volvo	3852560	987		18-3052	Mercury Marine	47-56780	392
	18-2998	Volvo	876300	982		18-3052	Mercury Marine	47-65958	392
	18-3000	Suzuki	17461-92D02	464		18-3052	Mercury Marine	47-89982	392
	18-3001	OMC	277181	276		18-3053-1	OMC	396725	277
	18-3001	OMC	434424	276		18-3054	Mercury Marine	47-68988	392
	18-3002	OMC	375638	276		18-3054	Mercury Marine	47-89980	392
	18-3002	OMC	775518	276		18-3055	OMC	389589	277
	18-3003	OMC	377178	276	3	18-3056	Chrysler Force	47-430262	229
	18-3003	OMC	775519	276	3	18-3056	Honda	19210-ZW1-003	244
	18-3006	OMC	378891	276	3	18-3056	Mercury Marine	47-430261	392
	18-3006	OMC	775521	276	3	18-3056	Mercury Marine	47-430262	392
3	18-3007	Mercury Marine	47-89983	391, 734	3	18-3056	Mercury Marine	47-430264	392
3	18-3007	Mercury Marine	47-89983T	391	3	18-3056	Mercury Marine	47-43026T2	392
	18-3008	Mercury Marine	47-20813	392		18-3057	Chrysler Force	47-85089-3	229
	18-3008	Mercury Marine	47-25287	392		18-3057	Mercury Marine	47-85089-3	392
	18-3012	Mercury Marine	47-22748	392		18-3058	OMC	983895	888
	18-3013	Mercury Marine	26-821309	393		18-3058	OMC	3854072	888
	18-3014	Mercury Marine	26-821310	393	3	18-3059	OMC	381538	277
	18-3015	OMC	396852	276	3	18-3059	OMC	389289	277
	18-3015	OMC	433935	276	3	18-3059	OMC	394534	277
	18-3015	OMC	797407	276	3	18-3059	OMC	395864	277
	18-3016-1	Mercury Marine	47-862232A2	734	3	18-3059	OMC	397131	277
	18-3016-1	Mercury Marine	8M0104229	734	3	18-3059	OMC	435748	277
3	18-3017	Chrysler Force	47-803631T	229	3	18-3059	OMC	435821	277
3	18-3017	Chrysler Force	47-89984T4	229	3	18-3059	OMC	439948	277
3	18-3017	Chrysler Force	47-F694065	229	3	18-3059	OMC	5001593	277
3	18-3017	Mercury Marine	47-30221	392, 734		18-3060	Crusader	22212	600
3	18-3017	Mercury Marine	47-65960	392, 734		18-3060	Crusader	1003026	600
3	18-3017	Mercury Marine	47-85460	392, 734		18-3060	Jabsco	18838-0001	964, 994
3	18-3017	Mercury Marine	47-89984	392, 734		18-3060	Oberdorfer	132-0317	964, 978
3	18-3017	Mercury Marine	47-899842	392, 734		18-3060	OMC	3854286	964, 978
3	18-3017	Mercury Marine	47-899844	392, 734		18-3060	Pleasurecraft	RP061015	628
3	18-3017	Mercury Marine	47-89984T3	392, 734		18-3060	Sherwood Pump	9959	558, 579, 628, 964, 994
3	18-3017	Mercury Marine	47-89984T4	392, 734		18-3060	Volvo	835512	964
	18-3020	Jabsco	1210-0003	556		18-3060	Volvo	3854286	964
	18-3020	Johnson Pump	09-1027B-9	557		18-3061	Crusader	20300	600
	18-3021	Jabsco	4598-0001	556		18-3061	Jabsco	18948-0001	964
	18-3021	Oberdorfer	6603	558		18-3061	Oberdorfer	8922	557
	18-3022	Honda	90752-ZW9-A30	245		18-3061	Pleasurecraft	RP061017	628
	18-3023	Suzuki	17461-90J00	464		18-3061	Sherwood Pump	10615	557, 579, 628
	18-3023	Suzuki	17461-90J01	464		18-3061	Volvo	835874	964
	18-3023	Suzuki	17461-94500	464		18-3062	Chrysler Force	47-42038-2	230
	18-3023	Suzuki	17461-94501	464		18-3062	Mercury Marine	47-420381	392
	18-3023	Suzuki	17461-94502	464		18-3062	Mercury Marine	47-420382	392
	18-3023	Suzuki	17461-94503	464		18-3062	Mercury Marine	47-42038Q02	392
	18-3023	Suzuki	17461-94504	464		18-3063	Mercury Marine	47-81242M	392
	18-3023	Suzuki	17461-94505	464		18-3063	Mercury Marine	47-95611M	392
	18-3023	Suzuki	17461-94506	464		18-3063	Yamaha	662-44352-01-00	495
	18-3023	Suzuki	17461-94510	464		18-3065	Yamaha	6L2-44352-00-00	495
	18-3023	Suzuki	17461-94511	464		18-3066	Mercury Marine	47-11590M	392
	18-3023	Suzuki	17461-94520	464		18-3066	Yamaha	6G1-44352-00-00	495
	18-3025	Honda	90752-ZW9-A30	245		18-3067	Mercury Marine	47-81604M	392
	18-3026	Johnson/Evinrude	331130	285		18-3067	Mercury Marine	47-84797M	392
	18-3028	Yamaha	6AW-44336-00	504		18-3067	Yamaha	689-44352-02-00	495
	18-3030	Chrysler Force	47-803630T	229		18-3068	Yamaha	6H4-44352-02-00	495
	18-3030	Chrysler Force	F523065	229		18-3069	Mercury Marine	47-81423M	392
	18-3030	Chrysler Force	F523065-1	229		18-3069	Mercury Marine	47-82824M	392
	18-3031	Honda	19210-ZY3-003	244		18-3069	Mercury Marine	47-97108M	392
	18-3035	Suzuki	17461-93J00	464		18-3069	Yamaha	697-44352-00-00	500-503
	18-3036	Jabsco	673-0003	555		18-3069	Yamaha	6H3-44352-00-00	500-503
	18-3036	Johnson Pump	09-1026B-9	556		18-3070	Yamaha	688-44352-03-00	495
	18-3036	Volvo	875808-8	965		18-3071	Yamaha	6E5-44352-01-00	495
	18-3037	Jabsco	836-0003	555		18-3072	Mercury Marine	47-80395M	392
	18-3037	Johnson Pump	09-1029B-9	556		18-3072	Yamaha	646-44352-01-00	495
	18-3037	Volvo	875660	964		18-3073	Mercury Marine	47-96305M	392
	18-3037	Volvo	875736	964		18-3073	Yamaha	6E0-44352-00-00	495
	18-3037	Volvo	2430184	964		18-3074	Mercury Marine	47-84027M	392
	18-3038	Jabsco	17937-0003	555		18-3074	Mercury Marine	47-84027T	392
	18-3038	Jabsco	920-0003	555		18-3074	Mercury Marine	47-96619M	392
	18-3038	Johnson Pump	09-1028B-9	557		18-3074	Yamaha	682-44352-01-00	495
	18-3038	Volvo	3841697	964	2	18-3075	Jabsco	124310-46090	555
	18-3038	Volvo	877061-2	964	2	18-3075	Jabsco	14510-46090	555
	18-3039	Mercury Marine	47-39074	392	2	18-3075	Jabsco	2877-0001	555
	18-3039	Mercury Marine	47-65957	392	2	18-3075	Jabsco	4568-0001	555
	18-3039	Mercury Marine	47-89981	392	2	18-3075	Johnson Pump	09-801B	556
	18-3040	Yamaha	63V-44352-01-00	495	2	18-3075	Oberdorfer	B6620	557
	18-3042	Yamaha	67F-44352-00-00	495	2	18-3075	Volvo	875575	964
	18-3043	OMC	389642	276		18-3076	Jabsco	22405-0001	555
	18-3044	OMC	385072	276		18-3076	Johnson Pump	09-45589	557
2	18-3046	Crusader	1003062	600		18-3076	Johnson Pump	09-808B	557

1 This product is priced per piece. To order, priced per package, please add -9 to the part number

2 Items ending in "D" are display packaged - regular number is non-display

3 For discount shop pack of 10, please add -10 to the part number

SIERRA #	O.E.M.	O.E. #	PAGE #	SIERRA #	O.E.M.	O.E. #	PAGE #
SIERRA							
18-3076	Volvo	833995	964	18-3110	Mercury Marine	26-36557A1	393, 734
18-3076	Volvo	875583	964	18-3110	Mercury Marine	26-38970	393, 734
18-3077	Cummins	650607	556	18-31104	Indmar	S525009	618
18-3077	Jabsco	920-0001	555	18-3111	OMC	907774	890
18-3077	Johnson Pump	09-1028B	556	18-3113	Mercury Marine	70977	393
18-3077	Oberdorfer	C7441	557	18-3114	Mercury Marine	48752	393, 734
18-3077	Sherwood Pump	18200	557	18-3114	Mercury Marine	48752T	393, 734
18-3077	Volvo	3841697	964	18-3115	Mercury Marine	48753	393
18-3077	Volvo	877061-2	964	18-3116	Mercury Marine	46-48743A1	393, 735
18-3077	Yanmar	127610-42200	556	18-3116	Mercury Marine	46-64141A1	393, 735
18-30777	Volvo	3841697	S/S to 18-3077	18-3116	Mercury Marine	46-96148	393, 735
18-30778	Volvo	21213664	964	18-3116	Mercury Marine	46-96148A1	393, 735
18-3078	Cummins	160596	555	18-3116	Mercury Marine	46-96148T1	393, 735
18-3078	Cummins	166758	555	18-3117	Mercury Marine	30605	393, 735
18-3078	Cummins	556540	555	18-3117	Mercury Marine	32435	393, 735
18-3078	Cummins	556850	555	18-3117	Mercury Marine	324351	393, 735
18-3078	Cummins	21601R	555	18-3118	Mercury Marine	46-48746A1	393
18-3078	Jabsco	836-0001	555	18-3118	Mercury Marine	46-48746A3	393
18-3078	Johnson Pump	09-1029B	556	18-3118	Mercury Marine	46-77822A1	393
18-3078	Oberdorfer	7054	557	18-3119	OMC	983298	890
18-3078	Volvo	875660	964	18-3121	OMC	911703	890
18-3078	Volvo	875736	964	18-3122	Honda	19231-ZW1-003	244
18-3078	Volvo	2430184	964	18-3122	Mercury Marine	817276	393, 735
18-3079	Jabsco	4528-0001	555	18-3122	Mercury Marine	8172761	393, 735
18-3079	Johnson Pump	09-806B	556	18-3122	Mercury Marine	8172763	393, 735
18-3079	Sherwood Pump	9979K	965	18-3125	Jabsco	3101-0000	556
18-3079	Volvo	3586498	965	18-3125	Johnson Pump	3298-0000	557
18-3079	Volvo	875807-0	965	18-3126	OMC	321940	278
18-3079	Yanmar	104211-42070	556	18-3127	OMC	319275	278
18-3080	Jabsco	673-0001	555	18-3129	OMC	432955	279
18-3080	Johnson Pump	09-1026B	556	18-3129	OMC	435673	279
18-3080	Johnson Pump	09-1026B-1	965	18-3129	OMC	436954	279
18-3080	Johnson Pump	09-1026B-9	556	18-3129	OMC	438591	279
18-3080	Volvo	875808	965	18-3133	OMC	331979	309
2 18-3081	Jabsco	1210-0001	555	1 18-3135	OMC	306643	309
2 18-3081	Johnson Pump	09-1027B	556	1 18-3136	OMC	323626	309
2 18-3081	Volvo	3858256	965	1 18-3138	OMC	334897	278
2 18-3081	Volvo	3862281	965	18-3139	Mercury Marine	46895	393
2 18-3081	Volvo	875811-2	965	1 18-3140	Crusader	20502	600
2 18-3081			628	1 18-3140	Sherwood Pump	10931	558
18-3082	OMC	382547	277	18-3141	OMC	313176	890
18-3083	OMC	377230	277	18-3142	Yamaha	68T-44323-00-00	501
18-3083	OMC	777213	277	18-3143	Yamaha	67F-44323-00-00	502
18-3084	Chrysler Force	47-F40065-2	230	18-3145	OMC	911844	890
18-3085	Chrysler Force	47-F84065	230	18-3147	Mercury Marine	817275K05	736
18-3086	OMC	379475	888	18-3147	Mercury Marine	817275T4	736
18-3086	OMC	777130	888	18-3148	Mercury Marine	46-84277M	397
18-3087	Mercury Marine	47-59362	734	18-3148	Mercury Marine	46-84277T	397
18-3087	Mercury Marine	47-59362T	734	18-3148	Yamaha	682-W0078-A1-00	498
18-3088	Yamaha	6F5-44352-00-00	495	18-3149-1	Mercury Marine	46-42040A1	S/S to 18-3149-2
18-3089	Johnson Pump	09-45825	557, 965	18-3149-1	Mercury Marine	46-42040A3	S/S to 18-3149-2
18-3090	OMC	387361	277	18-3149-1	Mercury Marine	46-42040A5	S/S to 18-3149-2
18-3090	OMC	763735	277	18-3149-2	Mercury Marine	46-42040A1	394
18-3091	OMC	389576	277	18-3149-2	Mercury Marine	46-42040A3	394
18-3092	Suzuki	17461-93001	464	18-3149-2	Mercury Marine	46-42040A5	394
18-3092	Suzuki	17461-93003	464	18-3150	Mercury Marine	46-807151A14	736
18-3092	Suzuki	17461-93004	464	18-3150	Mercury Marine	46-807151A7	736
18-3094	Suzuki	17461-94700	465	18-3151	Mercury Marine	816597	393, 735
18-3094	Suzuki	17461-94701	465	18-3153	OMC	908158	285, 309
18-3095	Suzuki	17461-95300	465	18-3154	Mercury Marine	826763A	393
18-3095	Suzuki	17461-95301	465	18-3155	Mercury Marine	47-72774A89	736
18-3095	Suzuki	17461-95302	465	18-3160-1	Mercury Marine	46-862914A13	736
18-3096	Suzuki	17461-96301	465	18-3162	Yamaha	67F-44322-00-00	502
18-3096	Suzuki	17461-96311	465	18-3163	Yamaha	6L5-44323-00-00	507
18-3096	Suzuki	17461-96312	465	18-3164	Yamaha	6L5-44322-00-00	505
18-3097	Suzuki	17461-98501	465	18-3166	Yamaha	6E0-44366-00-00	498
18-3097	Suzuki	17461-98502	465	18-3168	Chrysler Inboard	10927	579
18-3097	Suzuki	17461-98503	465	18-3168	Crusader	20309	601
18-3097	Suzuki	17461-985M0	465	18-3168	Sherwood Pump	10927	558
18-3098	Mercury Marine	47-16154	392	18-3169	Crusader	40057	601
18-3098	Mercury Marine	47-161543	392	18-3169	Sherwood Pump	12322	558
18-3099	OMC	5033112	277	18-3169	Sherwood Pump	12859	558
18-3099	Suzuki	17461-93901	465	18-3170	Yamaha	6E5-44311-00-00	496
18-3099	Suzuki	17461-93902	465	18-3171	Yamaha	688-44311-01-00	496
18-3099	Suzuki	17461-93903	465	18-3173-1	Yamaha	61A-44311-00-00	496
18-3100	Honda	19210-ZW9-003	244	18-3173-1	Yamaha	61A-44311-01-00	496
18-3100	Honda	19210-ZW9-013	244	18-3175	Volvo	858467	963
18-3102	OMC	305303	277	18-3176	Yamaha	68T-44366-00-00	498
18-3103	OMC	303069	277	18-3178	OMC	318995	278
18-3104-1	OMC	432941	277	18-3179	OMC	324097	278
18-3104-1	OMC	437059	277	18-3180	OMC	435390	279
18-3104-1	OMC	765350	277	18-3182	OMC	317841	278
18-3106	Volvo	806256	963	18-3185	Yamaha	61N-44311-00-00	496
18-3106	Volvo	831009	963	18-3185	Yamaha	61N-44311-01-00	496
18-3107	Mercury Marine	32768	393	18-3186	Yamaha	63D-44323-00-00	501
18-3107	Mercury Marine	54705	393	18-3187	Honda	06192-ZW1-305	244
18-3108	OMC	308928	890	18-3188	Suzuki	17471-98503	465
18-3109	Mercury Marine	23-29804	393, 734	18-3189	Suzuki	17471-87D01	465
18-3109	Mercury Marine	23-29804T	393, 734	18-3190	Suzuki	17471-93902	465
18-3109	Mercury Marine	23-52928	393, 734	18-3191	Suzuki	17471-94501	465
18-3110	Mercury Marine	26-29677	393, 734	18-3192	Suzuki	17471-87E01	465

1 This product is priced per piece. To order, priced per package, please add -9 to the part number

2 Items ending in "D" are display packaged - regular number is non-display

3 For discount shop pack of 10, please add -10 to the part number

SIERRA #	O.E.M.	O.E. #	PAGE #	SIERRA #	O.E.M.	O.E. #	PAGE #	
SIERRA								
18-3192	Suzuki	17471-92J00	465	18-3252	Mercury Marine	47-89982T1	395	
18-3193	Suzuki	17471-92D10	465	18-3253	Suzuki	17400-87D11	466	
18-3194	Yamaha	61N-44323-00	504	18-3254	Suzuki	17400-87E03	466	
18-3195	Yamaha	63V-44323-00-00	500	18-3254	Suzuki	17400-87E04	466	
18-3196	Yamaha	66T-44323-00-00	501	18-3255	Suzuki	17400-92D01	466	
18-3197	Mercury Marine	10-67373	735, 813	18-3256	Suzuki	17400-93951	466	
18-3197	Mercury Marine	10-76156	735, 813	18-3257	Suzuki	17400-94611	466	
18-3198	Mercury Marine	93424	843	18-3258	Suzuki	17400-90J11	466	
18-3198	Mercury Marine	934241	843	18-3258	Suzuki	17400-90J20	466	
18-3198	Mercury Marine	934243	843	18-3259	Suzuki	17400-98551	466	
18-3199	Mercury Marine	93423	843	18-3260	Suzuki	17400-98652	466	
18-3199	Mercury Marine	934231	843	18-3261	Volvo	875769	965	
18-3199	Mercury Marine	934233	843	18-3262	Volvo	875759	965	
1	18-3200	Chrysler Force	F697140	439	18-3263	Volvo	875698	965
1	18-3200	Honda	90508-ZW1-003	250	18-3264	Suzuki	17400-93J00	466
1	18-3200	Mercury Marine	14-31210	439, 847	18-3264	Suzuki	17400-93J02	466
1	18-3200	Mercury Marine	14-816629	439, 847	18-3265	Mercury Marine	47-43026Q06	395
1	18-3200	Mercury Marine	14-816629Q	439, 847	18-3265	Mercury Marine	47-43026T11	395
1	18-3200	Mercury Marine	14-F697140	439, 847	18-3265	Mercury Marine	47-8M0100526	395
1	18-3200	Pleasurecraft	R096117	632	18-3266	Suzuki	17400-98661	467
	18-3201	OMC	379763	279	18-3267	Suzuki	17400-98J00	467
	18-3202			279	18-3267	Suzuki	17400-98J01	467
	18-3203	OMC	379766	279	18-3268	Honda	90752-ZV4-650	244
1	18-3204	Mercury Marine	14-76281	439	18-3269	Honda	90752-ZV7-000	244
	18-3205	Volvo	875574	965	18-3270	Honda	90752-ZV5-003	244
	18-3206	OMC	984744	890	18-3271	Honda	90752-ZW1-B02	244
2	18-3207	Mercury Marine	47-89983Q1	394	18-3273	Honda	90752-ZY3-003	244
2	18-3207	Mercury Marine	47-89983T2	394	18-3274	Volvo	808007	964
	18-3208	Volvo	875584	965	18-3275	Jabsco	17935-0001	555
	18-3209	Volvo	875383	965	18-3275	Johnson Pump	09-819B	556
	18-3210			279	18-3275	Volvo	877066	964
2	18-3211			280	18-3276-1	Volvo	3862567	964
2	18-3212-1	OMC	984461	891	18-3276-1	Volvo	21213660	964
2	18-3214	Chrysler Force	46-43024A7	230	18-3277	Johnson Pump	09-102BB	964
2	18-3214	Honda	19021-ZW1-003	244	18-3277	Volvo	3862281	964
2	18-3214	Mercury Marine	47-43026T11	394	18-3277	Yanmar	192470-42530	964
2	18-3214	Mercury Marine	47-43026T6	394, 736	18-3277	Yanmar	192470-42532	964
2	18-3214	Mercury Marine	47-43026T8	394, 736	18-3278	Honda	06192-ZV1-C00	245
2	18-3215	Mercury Marine	47-85089T7	394	18-3279	Honda	06192-881-C00	245
2	18-3215			230	18-3280	Honda	06192-ZV4-000	245
	18-32150			615, 627	18-3281	Honda	06192-ZV7-000	245
	18-32151			615, 627	18-3282	Honda	06192-ZV5-003	245
	18-32152	Ilmor	S556162	615	18-3283	Honda	06192-ZW1-000	245
	18-32152	Indmar	S556162	615	18-3284	Honda	06192-ZV6-000	245
	18-32152	Malibu	S556162	615	18-3285	Honda	06192-ZY3-000	245
	18-32153	Honda	35655-ZY3-C01	243	18-3286			891
	18-32153	Honda	35655-ZZ5-004	243	18-3287	Volvo	876120	964
	18-32154	Suzuki	18213-98J00	463	18-3288	Honda	91252-ZV1-003	248
	18-3216	Mercury Marine	47-59362A4	736	18-32882	Volvo	3852315	993
2	18-3217			395, 736	18-3289	Mercury Marine	26-864319	812
	18-3219	Mercury Marine	32489	832	18-3290	OMC	321886	275
	18-3219	Mercury Marine	32489A2	832	18-3291	Suzuki	09420-05006	465
	18-3219	Mercury Marine	42724A3	832	18-3291	Suzuki	09420-05009	465
	18-3220	Mercury Marine	32-54236	735	18-3292	Suzuki	09420-03005	465
	18-3221	Mercury Marine	32-814384	735	18-3292	Suzuki	17462-93990	465
	18-3221	Mercury Marine	32-860220	735	18-3293	Mercury Marine	28-43037	393, 735
	18-3222	Mercury Marine	23-816583	735	18-3294	Mercury Marine	28-81603M	393
	18-3223-9			570, 588, 610, 631, 783, 898, 972	1	18-3295	OMC	330619
					1	18-3295	OMC	344470
1	18-3226	Mercury Marine	10-30720	735	18-3296	Suzuki	09420-05005	465
1	18-3227	Mercury Marine	17-35973	393, 735	18-3297	Yamaha	90280-03M03-00	497
1	18-3229	Mercury Marine	10-28668	735	1	18-3299	OMC	331107
	18-3230	Mercury Marine	10-816601	813	18-3300	Mercury Marine	28-83444M	393
	18-3231	Mercury Marine	10-98794	813	18-3300	Yamaha	90280-04M00-00	497
12	18-3232	Mercury Marine	19-47579	853	18-3301	Yamaha	90280-04M04-00	497
12	18-3232	Mercury Marine	19-475791	853	18-3302	Yamaha	90280-04M05-00	497
	18-3236	Mercury Marine	23-32632	813	18-3303	Johnson Pump	01-42401	557
	18-3237			736	18-3304	Jabsco	6760-0001	555
	18-3238	OMC	388891	280	18-3304	Johnson Pump	09-802-B	616
2	18-3239			395	18-3305	Mercury Marine	28-81912M	393
	18-3240			230	18-3305	Mercury Marine	28-83701M	393
	18-3242	Suzuki	17400-96350	466	18-3305	Yamaha	90280-03003-00	497
	18-3242	Suzuki	17400-96351	466	18-3305	Yamaha	90280-03024-00	497
	18-3242	Suzuki	17400-96353	466	18-3306	Jabsco	13554-0001	555
	18-3243	Suzuki	17400-94700	466	2	18-3306	Johnson Pump	09-812B
	18-3243	Suzuki	17400-94701	466	2	18-3306	Yanmar	119773-42600-00
	18-3244	Suzuki	17400-95350	466	2	18-3309		736
	18-3244	Suzuki	17400-95351	466		18-3310	Yamaha	6G5-W0078-01-00
	18-3244	Suzuki	17400-95550	466		18-33104	Mercury	802632
	18-3245	Honda	19210-881-A01	244		18-33104	Mercury	802632T
	18-3245	Honda	19210-881-A02	244		18-3311	Yamaha	6G5-W0078-A1-00
	18-3245	Honda	19210-ZW9-A02	244		18-3312	Yamaha	6N6-W0078-00-00
	18-32455	Honda	19210-ZW9-A31	244		18-3313-1	Yamaha	6N6-W0078-01-00
	18-32455	Honda	19210-ZW9-A32	244		18-3314		396
	18-3246	Honda	19210-ZV4-013	244		18-3315-2	OMC	435929
	18-3246	Honda	19210-ZV4-651	244		18-3315-2	OMC	5001595
	18-3247	Honda	19210-ZV4-651	244-246		18-3316	Mercury Marine	46-32437A3
	18-3248	Honda	19210-ZV5-003	244-246		18-3316	Mercury Marine	46-78400A2
	18-3249	Honda	19210-ZV7-003	244-246		18-3316	Mercury Marine	46-96148A8
	18-3250	Honda	19210-ZW1-B04	244-247		18-3317	Mercury Marine	
2	18-3251			230		18-3318	Mercury Marine	47-59362Q08

1 This product is priced per piece. To order, priced per package, please add -9 to the part number

2 Items ending in "D" are display packaged - regular number is non-display

3 For discount shop pack of 10, please add -10 to the part number

SIERRA #	O.E.M.	O.E. #	PAGE #	SIERRA #	O.E.M.	O.E. #	PAGE #
SIERRA							
18-3319	Mercury Marine	46-42579A4	396	18-3398	Yamaha	6F5-W0078-00-00	500
18-3320			737	18-3398	Yamaha	6F5-W0078-A0-00	500
18-33207	Mercury	860349A1	709	18-3399	OMC	396933	283
18-3321			737	18-3399	OMC	439077	283
18-33211	Mercury	892681	709	18-3400	OMC	391698	283
18-3322	Mercury Marine	46-77516A3	396	18-3400	OMC	394711	283
18-3323	Mercury Marine	46-73640A2	397	18-3401	OMC	394394	283
18-3324	Mercury Marine	46-77177A3	397	18-3401	OMC	395271	283
18-3325	OMC	387326	280	18-3401	OMC	395270	283
18-3326	OMC	300611	278	18-3402	OMC	382296	283
18-3327	OMC	386697	280	18-3403	OMC	388644	284
18-3327	OMC	387610	280	18-3404	Suzuki	09420-04009	465
18-3327	OMC	389112	280	18-3405	OMC	435959	279
18-3327	OMC	391698	280	18-3406	Mercury Marine	817275A08	395
18-3327	OMC	394711	280	18-3407	Mercury Marine	817275A09	395
18-3328	Yamaha	646-44322-00-00	503	18-3408	Yamaha	663-44311-02	500
18-3329	OMC	302497	315	18-3408	Yamaha	6H4-W0078-00	500
18-3332	OMC	304026	315	18-3408	Yamaha	6H4-W0078-A0	500
18-3333	Yamaha	61A-44322-00-00	498, 499	18-34080	Universal		652
18-3336	OMC	384087	279	18-34081	Universal		652
18-3337	OMC	315837	315	18-34082	GM		652
18-3343	OMC	320981	278	18-34083	GM		652
18-3344	Yamaha	6E5-44323-00-00	499	18-34084	GM		652
18-3345	Yamaha	6G5-44323-00-00	498	18-3409	Yamaha	67F-44311-01	502
18-3346	OMC	435027	278	18-3409	Yamaha	67F-W0078-00	502
18-3348	OMC	984461	891	18-3410	Yamaha	68T-W0078-00-00	501
18-3349			891	18-3411	Yamaha	68T-W0078-A1-00	498
18-3350	Mercury Marine	72778	735	18-34110	Mallory	4110M	647
18-3350	Mercury Marine	94576	735	18-3412	Yamaha	63V-44301-00	500
18-3351	Mercury Marine	72777	735	18-3412	Yamaha	63V-W0078-01	500
18-3351	Mercury Marine	94916	735	18-34120	Mallory	5110MFI	647
18-3352	OMC	325398	281	18-3413	Yamaha	66T-44311-00	501
18-3356	Yamaha	63V-44301-00-00	496	18-3413	Yamaha	66T-W0078-00	501
18-3357	Yamaha	646-44323-00-00	503	18-3414	Mercury Marine	46-73804A1	394
18-3358	OMC	328751	278	18-3414	Mercury Marine	46-96146A5	394
18-3359	OMC	328755	278	18-34140	Mallory	4140M	647
18-3360	OMC	329390	313	18-3415	Yamaha	63D-W0078-01-00	501
18-3363	OMC	330560	279	18-3416	Mercury Marine	46-73802A2	394
18-3365	OMC	909533	285, 309	18-3416	Mercury Marine	46-78400A1	394
18-3366	OMC	390286	277	18-3416	Mercury Marine	46-96146A2	394
18-3367	OMC	393632	279	18-3416	Mercury Marine	46-96146A6	394
18-3368	OMC	396809	277	18-3417	Mercury Marine	46-57234A1	735
18-3369	OMC	302325	309	18-3419	Mercury Marine	46-42579A3	394
18-3369	OMC	319126	285	18-3420	Mercury Marine	46-44292A3	735
18-3370	Yamaha	692-W0078-00-00	499	18-3420	Mercury Marine	46-44292Q03	735
18-3370	Yamaha	692-W0078-01-00	499	18-3420	Mercury Marine	46-44292T1	735
18-3370	Yamaha	692-W0078-A0-00	499	18-3421	Mercury Marine	46-48748A1	735
18-3371	Yamaha	692-W0078-A0-00	499	18-3422	Mercury Marine	46-48745A1	394
18-3372	Yamaha	6E5-W0078-01-00	499	18-3422	Mercury Marine	46-65498A1	394
18-3373	Yamaha	6E5-W0078-A1-00	499	18-3422	Mercury Marine	46-68390A1	394
18-3374	Yamaha	6F5-W0078-00-00	S/S to 18-3397	18-3422	Mercury Marine	46-73842A2	394
18-3374	Yamaha	6F5-W0078-A0-00	S/S to 18-3397	18-3422	Mercury Marine	46-77516A1	394
18-3374	Yamaha	6F5-W0078-00-00	S/S to 18-3397	18-3423	Mercury Marine	46-73640A1	394
18-3374	Yamaha	6F5-W0078-A0-00	S/S to 18-3397	18-3424	Mercury Marine	46-77177A1	394
18-3376	OMC	384956	280	18-3425	Mercury Marine	84188M	398
18-3377	OMC	382468	280	18-3425	Mercury Marine	84188T	398
18-3378	OMC	391635	281	18-3425	Yamaha	663-W0078-00-00	503
18-3378	OMC	439077	281	18-3425	Yamaha	663-W0078-A0-00	503
18-3379	OMC	390381	281	18-3426	Mercury Marine	42431M	398
18-3380	OMC	390770	281	18-3426	Mercury Marine	84829M	398
18-33800	Mercury	21-806118	709	18-3426	Mercury Marine	97793M	398
18-33800	Volvo	3856884	962	18-3426	Mercury Marine	97793T	398
18-3381	OMC	393509	281	18-3426	Yamaha	689-W0078-04-00	503
18-3382	OMC	393630	281	18-3426	Yamaha	689-W0078-A4-00	503
18-3383	OMC	395270	281	18-3427	Mercury Marine	81242M	398
18-3384	OMC	386124	282	18-3427	Mercury Marine	95661M	398
18-3385	OMC	396932	282	18-3427	Yamaha	689-W0078-A6-00	504
18-3386	OMC	983218	891	18-3428-1	Yamaha	6H3-W0078-00-00	500
18-3387	OMC	432956	282	18-3428-1	Yamaha	6H3-W0078-A0-00	500
18-3388	OMC	386533	282	18-3429	Yamaha	6H4-W0078-00-00	500
18-3388	OMC	389143	282	18-3429	Yamaha	6H4-W0078-A0-00	500
18-3389	OMC	436957	282	18-3430	Yamaha	6J8-W0078-A1-00	503
18-3389	OMC	438591	282	18-3431	Yamaha	6L2-W0078-00-00	503
18-3389	OMC	432955	282	18-3432	Yamaha	61N-W0078-11-00	504
18-3390	OMC	395060	282	18-3433	Yamaha	63V-W0078-01-00	500
18-3390	OMC	435447	282	18-3434	Yamaha	63D-W0078-01-00	501
18-3390	OMC	434421	282	18-3435	Yamaha	663-44322-00-00	500, 502, 503
18-3390	OMC	5001594	282	18-3435			393
18-3391	OMC	395072	283	18-3436	Yamaha	663-44323-00-00	500, 503
18-3392	OMC	434421	283	18-3436			393
18-3392	OMC	5001594	283	18-3440	Yamaha	66T-W0078-00-00	501
18-3393	OMC	388644	283	18-3442	Yamaha	68V-W0078-00-00	501
18-3393	OMC	395073	283	18-3443	Yamaha	61N-44322-01-00	504
18-3394	OMC	433548	283	18-3444	Yamaha	63V-44322-00-00	500, 501
18-3394	OMC	433549	283	18-3445	Mercury Marine	46-812966A7	394
18-3394	OMC	438592	283	18-3445	Mercury Marine	46-812996A3	394
18-3395	Yamaha	61A-W0078-01-00	499	18-3445	Mercury Marine	46-812996A9	394
18-3396-1	Yamaha	61A-W0078-A2-00	499	18-3446	Mercury Marine	46-70941A3	397
18-3396-1	Yamaha	61A-W0078-A3-00	499	18-3448	Mercury Marine	46-48744A3	398
18-3397	Yamaha	679-W0078-00-00	500	18-3449	Yamaha	63D-44322-00-00	501
18-3397	Yamaha	679-W0078-A0-00	500	18-3450	Yamaha	68T-W0078-00-00	501

1 This product is priced per piece. To order, priced per package, please add -9 to the part number
 2 Items ending in "D" are display packaged - regular number is non-display
 3 For discount shop pack of 10, please add -10 to the part number

SIERRA #	O.E.M.	O.E. #	PAGE #	SIERRA #	O.E.M.	O.E. #	PAGE #
SIERRA							
18-3451	Yamaha	67F-W0078-00-00	502	18-3521	Yamaha	68V-44323-00-00	501
18-3453	OMC	5006511	280	18-3522-1	Yamaha	60X-W0078-00	502
18-3454	OMC	438592	280	18-3522-1	Yamaha	61A-44311-01	502
18-3455	OMC	340619	278	18-3523-1	Yamaha	61A-44311-01	501
18-3456	Yamaha	6G1-44322-00-00	503	18-3523-1	Yamaha	68V-W0078-00	501
18-3457	Yamaha	6AW-44322-00-00	502	18-3524	Yamaha	6CE-12411-00-00	510
18-3458	Yamaha	6CE-44315-00-00	502	18-3525	Yamaha	60V-12411-00	510
18-3459	Yamaha	6CE-44323-01-00	502	18-3530-1	Mercury Marine	860256A2	741
18-3460	Yamaha	6G1-W0078-01-00	503	18-3530-1	Mercury Marine	860256A4	741
18-3460	Yamaha	6G1-W0078-A1-00	503	18-35302	Yamaha	66M-24410-10-00	487
18-3460	Yamaha	6N0-W0078-A0-00	503	18-35304	Yamaha	67D-24410-03-00	487
18-34600	Yamaha	66M-14301-00-00	484	18-3531	Mercury Marine	807074A1	741
18-34600	Yamaha	66M-14301-12-00	484	18-3531	Mercury Marine	808064A1	741
18-34601	Yamaha	67D-14301-13-00	484	18-3531	Mercury Marine	861188A1	741
18-34602	Yamaha	65W-14901-12-00	Obsolete	18-3535	Mercury Marine	88559004	390
18-34603	Yamaha	63V-14301-00-00	484	18-3536	Mercury Marine	833072003	390
18-34604	Yamaha	69M-14301-11-00	484	18-3537	Mercury Marine	833072002	390
18-34605	Yamaha	66T-14301-00-00	484	18-3537	Mercury Marine	833072004	390
18-3461	Yamaha	6H3-W0078-00-00	500, 506, 508	18-3538	Volvo	3831424	974
18-3461	Yamaha	6H3-W0078-A0-00	500, 506, 508	18-3539	Volvo	3831426	973
18-3462	Yamaha	6A1-W0078-02-00	503, 507	18-3540	Yamaha	6E5-12411-30-00	510
18-3463	Yamaha	6A1-W0078-01-00	503, 507	18-3541	Yamaha	66M-12411-01-00	510
18-3464	Yamaha	6H3-W0078-01-00	S/S to 18-3465	18-3543	OMC	378065	289
18-3465	Yamaha	6H3-W0078-02-00	502	18-3543	OMC	393659	289
18-3466	Yamaha	6H3-44311-00	502	18-3543	OMC	434841	289
18-3466	Yamaha	6H3-W0078-01	502	18-3543	OMC	508626	289
18-3466	Yamaha	6H3-W0078-02-00	502	18-3543	OMC	5005440	289
18-3469	OMC	3854661	891	18-35433	Mercury Marine	861156A1	725
18-3470	Yamaha	6CE-W0078-01	502	18-35435			648
18-3471	Yamaha	6CE-W0078-01 + 6CE-44311-01	502	18-35436			648
18-3472	OMC	5007972	284	18-35437	Mercury	42725A3	725
18-3473	Yamaha	6EE-W0078-00-00	504	18-35437	Mercury	861676A1	725
18-3474	Yamaha	6CB-W0078-00-00	504	18-35437	Mercury	861676T09	725
18-3475	Yamaha	69G-W0078-00	504	18-35437	Mercury	8M0073435	725
18-3476	OMC	5007556	285	18-3544	OMC	435491	289
18-3477	Yamaha	6AW-W0078-00-00	504	18-35442	Volvo	859428	958
18-3478	Honda	06192-ZW9-A30	245	18-35443	Volvo	3582310	670
18-3479	Yamaha	6AH-W0078-00	504	18-35444	Volvo	858459	670
18-3480	Suzuki	17411-93901	467	18-3545	OMC	437090	289
18-3481	Suzuki	17411-94421	467	18-3546	OMC	5001036	289
18-3482	Yamaha	6CE-44311-01-00	496	18-3549	Mercury Marine	14586	391
18-3483	Yamaha	6AW-44311-01-00	496	18-3550	Chrysler Force	F84068-2	229
18-3484	Yamaha	6AH-44311-00-00	496	18-3550	Chrysler Force	F85068	229
18-3485	Yamaha	6CJ-44311-00-00	496	18-3550	Chrysler Force	F85068-1	229
18-3486	Yamaha	6L2-44311-01-00	496	18-3550	Chrysler Force	F85068-2	229
18-3489	Honda	06192-ZX2-C00	245	18-3550	Mercury Marine	59078	740
18-3490	Yamaha	6BG-W0078-00-00	505	18-3550	Mercury Marine	59078A1	740
18-3491	OMC	437907	285	18-3551	Chrysler Inboard	4142885	578
18-3492	Honda	06192-ZW1-B01	245	18-3551	Crusader	96319	601
18-3493	Honda	06192-ZW9-000	245	18-3551	Mercury Marine	32728	740
18-3494	Yamaha	6CJ-W0078-00-00	505	18-3551	Mercury Marine	35884	740
18-3495	Suzuki	15170-93911	462	18-3551	Mercury Marine	59137	740
18-3496	Suzuki	15170-94320	462	18-3551	Mercury Marine	8072521	740
18-3497	OMC	5033372	271	18-3551	Mercury Marine	8072531	740
18-3497	Suzuki	15170-91J00	462	18-3551	Mercury Marine	59137A1	740
18-3498	OMC	5036216	271	18-3551	Mercury Marine	807252T1	740
18-3498	Suzuki	15170-94J00	462	18-3551	Mercury Marine	8M0089715	740
18-3498	Suzuki	15170-94JOV	462	18-3551	Pleasurecraft	R026002E	628
18-3499	OMC	5030699	271	18-3552	Crusader	96358	601
18-3499	Suzuki	15170-99E00	462	18-3552	Mercury Marine	76270	740
18-3500	OMC	394409	289	18-3552	Mercury Marine	76270T	740
18-3500	OMC	434137	289	18-3553	Mercury Marine	62981	391
18-3501	OMC	435957	278	18-3553	Mercury Marine	66850	391
18-3502	OMC	912614	890	18-3553	Mercury Marine	75692	391
18-3504	Volvo	3588475	964	18-3554	OMC	383307	891
18-3505	Yamaha	63V-44365-10-00	498	18-3555	Mercury Marine	99155A1	740
18-3506	Mercury Marine	46-879194401	734	18-3555	Mercury Marine	99155T2	740
18-3506	Volvo	21124846	963	18-3556	Chrysler Force	F97068-2	229
18-3507	Mercury Marine	46-60366A1	396	18-3556	Mercury Marine	895338	391
18-3510	Johnson Pump	09-45589	557	18-3557	Chrysler Force	F335068	229
18-35101	Mallory	5421	647	18-3557	Mercury Marine	47594	740
18-35102	Mallory	54212	647	18-3557	OMC	382385	289
18-3515	Yamaha	6P2-W0078-00-00	503	18-3557	OMC	396987	289
18-3516	Yamaha	60X-W0078-00-00	502	18-3557	Volvo	21148403	973
18-3517	Mercury Marine	46-32437A1	396	18-3558	OMC	982554	891
18-3517	Mercury Marine	46-42579A4	396	18-3558	OMC	3853799	891
18-3517	Mercury Marine	46-44292A4	396	18-3558	Volvo	3853799	973
18-3517	Mercury Marine	46-48747A3	396	18-3559	Chrysler Force	F528068	229
18-3517	Mercury Marine	46-57234A3	396	18-3560	OMC	384719	289
18-3517	Mercury Marine	46-58618A4	396	18-3561	OMC	436195	289
18-3517	Mercury Marine	46-60367A4	396	18-3562	OMC	321222	288
18-3517	Mercury Marine	46-64141A11	396	18-3563	OMC	321027	288
18-3517	Mercury Marine	46-69222A3	396	18-3564	OMC	318395	288
18-3517	Mercury Marine	46-73802A3	396	18-3565	OMC	321220	289
18-3517	Mercury Marine	46-73804A3	396	18-3566	Johnson/Evinrude	331894	289
18-3517	Mercury Marine	46-78400A2	396	18-3567	OMC	321221	289
18-3517	Mercury Marine	46-96148A5	396, 737	18-3568	Mercury Marine	99155T1	740
18-3517	Mercury Marine	46-96148A8	396, 737	18-3569	Mercury Marine	803061T1	390
18-3518	Yamaha	6P2-44323-00-00	503	18-3570			398
18-3519	Yamaha	61A-44322-02-00	501-503	18-3571	Mercury Marine	817275A1	397
18-3520	Yamaha	60X-44323-00-00	502	18-3572	Mercury Marine	46-43024A3	397

1 This product is priced per piece. To order, priced per package, please add -9 to the part number

2 Items ending in "D" are display packaged - regular number is non-display

3 For discount shop pack of 10, please add -10 to the part number

SIERRA #	O.E.M.	O.E. #	PAGE #	SIERRA #	O.E.M.	O.E. #	PAGE #
SIERRA							
18-3572	Mercury Marine	817275A2	397	18-3593	Mercury Marine	52353	734
18-3573	Mercury Marine	883514	734	18-3593	Mercury Marine	65142	734
18-3573	Mercury Marine	883925	734	18-3593	Mercury Marine	65142A1	734
18-3575	Mercury Marine	33957	S/S to 18-3593	18-3593	Mercury Marine	814755	734
18-3575	Mercury Marine	37369	S/S to 18-3593	18-3593	Mercury Marine	880817	734
18-3575	Mercury Marine	52353	S/S to 18-3593	18-3593	Mercury Marine	884727	734
18-3575	Mercury Marine	65142	S/S to 18-3593	18-3593	Mercury Marine	F2774666	734
18-3575	Mercury Marine	814755	S/S to 18-3593	18-3593	Mercury Marine	F11001079	734
18-3575	Mercury Marine	880817	S/S to 18-3593	18-3593	Mercury Marine	F11100785	734
18-3575	Mercury Marine	884727	S/S to 18-3593	18-3593	OMC	984360	887
18-3575	Mercury Marine	65142A1	S/S to 18-3593	18-3593	OMC	986779	887
18-3575	Mercury Marine	F2774666	S/S to 18-3593	18-3593	OMC	380640	887
18-3575	Mercury Marine	F11100785	S/S to 18-3593	18-3593	OMC	3854017	887
18-3575	Mercury Marine	F11101079	S/S to 18-3593	18-3593	OMC	3858340	887
18-3575	OMC	380640	S/S to 18-3593	18-3593	Volvo	3854017	963
18-3575	OMC	984360	S/S to 18-3593	18-3593	Volvo	3858340	963
18-3575	OMC	986779	S/S to 18-3593	18-3599-1	Crusader	20318	S/S to 18-3599-2
18-3575	OMC	3854017	S/S to 18-3593	18-3599-1	Crusader	7142520	S/S to 18-3599-2
18-3575	Volvo	3854017	S/S to 18-3593	18-3599-1	Mercury Marine	17437	S/S to 18-3599-2
18-3577-1	Crusader	30103	S/S to 18-3577-2	18-3599-1	Mercury Marine	35341	S/S to 18-3599-2
18-3577-1	GM	6269358	S/S to 18-3577-2	18-3599-1	Mercury Marine	37951	S/S to 18-3599-2
18-3577-1	Mercury Marine	17670	S/S to 18-3577-2	18-3599-1	Mercury Marine	52226	S/S to 18-3599-2
18-3577-1	Mercury Marine	49139	S/S to 18-3577-2	18-3599-1	Mercury Marine	54793	S/S to 18-3599-2
18-3577-1	Mercury Marine	54534	S/S to 18-3577-2	18-3599-1	Mercury Marine	60658	S/S to 18-3599-2
18-3577-1	Mercury Marine	59972	S/S to 18-3577-2	18-3599-1	Mercury Marine	811841	S/S to 18-3599-2
18-3577-1	Mercury Marine	67859	S/S to 18-3577-2	18-3599-1	Mercury Marine	850399	S/S to 18-3599-2
18-3577-1	Mercury Marine	811573	S/S to 18-3577-2	18-3599-1	Mercury Marine	878341	S/S to 18-3599-2
18-3577-1	Mercury Marine	850454	S/S to 18-3577-2	18-3599-1	Mercury Marine	8503991	S/S to 18-3599-2
18-3577-1	Mercury Marine	878342	S/S to 18-3577-2	18-3599-1	Mercury Marine	850399002	S/S to 18-3599-2
18-3577-1	Mercury Marine	8504541	S/S to 18-3577-2	18-3599-1	Mercury Marine	F11100742	S/S to 18-3599-2
18-3577-1	Mercury Marine	8504541	S/S to 18-3577-2	18-3599-1	Mercury Marine	F11101208	S/S to 18-3599-2
18-3577-1	Mercury Marine	850454002	S/S to 18-3577-2	18-3599-1	Mercury Marine	F11101292	S/S to 18-3599-2
18-3577-1	Mercury Marine	F6269358	S/S to 18-3577-2	18-3599-1	OMC	382218	S/S to 18-3599-2
18-3577-1	Mercury Marine	F11100997	S/S to 18-3577-2	18-3599-1	OMC	980477	S/S to 18-3599-2
18-3577-1	Mercury Marine	F11101053	S/S to 18-3577-2	18-3599-1	OMC	985429	S/S to 18-3599-2
18-3577-1	OMC	983296	S/S to 18-3577-2	18-3599-1	OMC	3853850	S/S to 18-3599-2
18-3577-1	OMC	986074	S/S to 18-3577-2	18-3599-1	Pleasurecraft	RA057018	S/S to 18-3599-2
18-3577-1	OMC	987447	S/S to 18-3577-2	18-3599-1	Volvo	835390	S/S to 18-3599-2
18-3577-1	OMC	3854118	S/S to 18-3577-2	18-3599-1	Volvo	856364	S/S to 18-3599-2
18-3577-1	Pleasurecraft	RA057019	S/S to 18-3577-2	18-3599-1	Volvo	3853850	S/S to 18-3599-2
18-3577-1	Volvo	856609	S/S to 18-3577-2	18-3599-2	Crusader	20318	601
18-3577-1	Volvo	3855991	S/S to 18-3577-2	18-3599-2	Crusader	7142520	601
18-3577-2	Crusader	30103	601	18-3599-2	Mercury Marine	17437	734
18-3577-2	GM	6269358	887	18-3599-2	Mercury Marine	35341	734
18-3577-2	Mercury Marine	17670	734	18-3599-2	Mercury Marine	37951	734
18-3577-2	Mercury Marine	49139	734	18-3599-2	Mercury Marine	52226	734
18-3577-2	Mercury Marine	54534	734	18-3599-2	Mercury Marine	54793	734
18-3577-2	Mercury Marine	59972	734	18-3599-2	Mercury Marine	60658	734
18-3577-2	Mercury Marine	67859	734	18-3599-2	Mercury Marine	811841	734
18-3577-2	Mercury Marine	811573	734	18-3599-2	Mercury Marine	850399	734
18-3577-2	Mercury Marine	850454	734	18-3599-2	Mercury Marine	878341	734
18-3577-2	Mercury Marine	878342	734	18-3599-2	Mercury Marine	8503991	734
18-3577-2	Mercury Marine	8504541	734	18-3599-2	Mercury Marine	850399002	734
18-3577-2	Mercury Marine	8504541	734	18-3599-2	Mercury Marine	F11100742	734
18-3577-2	Mercury Marine	850454002	734	18-3599-2	Mercury Marine	F11101208	734
18-3577-2	Mercury Marine	F6269358	734	18-3599-2	Mercury Marine	F11101292	734
18-3577-2	Mercury Marine	F11100997	734	18-3599-2	OMC	382218	887
18-3577-2	Mercury Marine	F11101053	734	18-3599-2	OMC	980477	887
18-3577-2	OMC	983296	887	18-3599-2	OMC	985429	887
18-3577-2	OMC	986074	887	18-3599-2	OMC	3853850	887
18-3577-2	OMC	987447	887	18-3599-2	Pleasurecraft	RA057018	628
18-3577-2	OMC	3854118	887	18-3599-2	Volvo	835390	963
18-3577-2	Pleasurecraft	RA057019	628	18-3599-2	Volvo	856364	963
18-3577-2	Volvo	856609	963	18-3599-2	Volvo	3853850	963
18-3577-2	Volvo	3855991	963	18-3600	Mercury Marine	46-59112A2	736
18-3578	OMC	984876	887	18-3600	Mercury Marine	46-63450A2	736
18-3581	Chrysler Inboard	3004886	579	18-3600	Mercury Marine	46-72774A11	736
18-3581	Chrysler Inboard	3619542	579	18-3600	Mercury Marine	46-72774A32	736
18-3581	Chrysler Inboard	3745985	579	18-3600	Mercury Marine	46-73823A7	736
18-3581	Chrysler Inboard	4417905	579	18-36001	Mercuriser	46-807151A12	736
18-3582	Chrysler Inboard	3619859	579	18-3601	Mercury Marine	32-32461	753
18-3584	Mercury Marine	56879	734	18-3601	Mercury Marine	32-32461A1	753
18-3584	Mercury Marine	58086	734	18-3602	Mercury Marine	32-4172533	754
18-3584	Mercury Marine	71683	734	18-3602	Mercury Marine	32-8M0062309	754
18-3584	Mercury Marine	883885	734	18-3603	Mercury Marine	32-43437	754
18-3584	Mercury Marine	71683A1	734	18-3603	Mercury Marine	32-8M0090859	754
18-3584	OMC	982515	887	18-3605			390
18-3584	OMC	982517	887	18-3606			390
18-3584	OMC	3853796	887	18-3607	Mercury Marine	893409	440
18-3584	Pleasurecraft	RA057004	628	18-3608			511
18-3584	Volvo	3853796	963	18-3609			511
18-3584			601	18-3610	OMC	911752	924
18-3586-1	Indmar	685011	616	18-3611			511
18-3586-1	Johnson Pump	10-24228-1	557	18-3615	Volvo	3587597	974
18-3586-1	Pleasurecraft	RA057023	628	18-3617			974
18-3586-1	Volvo	841640	963	18-3618			974
18-3587-1	Indmar	685001	616	18-3619			974
18-3587-1	Johnson Pump	10-24232-1	557	18-3620			974
18-3587-1	Pleasurecraft	RA057024	628	18-3621			974
18-3593	Mercury Marine	35957	734	18-3622	Yamaha	6H3-12411-11-00	510
18-3593	Mercury Marine	37369	734	18-3623	Yamaha	6E5-12411-02-00	510

1 This product is priced per piece. To order, priced per package, please add -9 to the part number

2 Items ending in "D" are display packaged - regular number is non-display

3 For discount shop pack of 10, please add -10 to the part number

SIERRA #	O.E.M.	O.E. #	PAGE #	SIERRA #	O.E.M.	O.E. #	PAGE #
SIERRA							
18-3624	Yamaha	69M-12411-01-00	510	18-3712	Mercury Marine	12-45810	832
18-3625	Yamaha	6F5-12411-03-00	510	18-3713	Mercury Marine	11-22339	832
18-3626			974	18-3713	Mercury Marine	11-36084	832
18-3627	Honda	19300-881-761	243	18-3713	Mercury Marine	11-97522	832
18-3628-1	Honda	19300-ZW9-003	243	18-3713	Mercury Marine	F1348	832
18-3629	Honda	19300-881-741	243	18-3713	Mercury Marine	F1881	832
18-3630	Honda	19300-ZV5-043	244	18-3714	Mercury Marine	12-31211	439, 847
18-3631	Mercury	892864T04	391	18-3714	Mercury Marine	12-31211A2	439, 847
18-3632	Yamaha	67F-12411-01-00	510	18-3714	Mercury Marine	12-31211A3	439, 847
18-3633	Mercury	8M0090819	391	18-3714	Mercury Marine	12-31211Q03	439, 847
18-3634	Yamaha	6AW-12411-00-00	510	2 18-3715	OMC	175266	329, 925
18-3635	Mercury	892864T06	391	2 18-3716	OMC	175267	329, 925
18-3636	Yamaha	6DA-12411-01-00	510	2 18-3717	OMC	175268	329
18-3637	Yamaha	6CB-12411-10-00	510	18-3719	Chrysler Force	11-35921	238
18-3638	Mercury	804540	391	18-3719	Chrysler Force	11-47411	238
18-3639	Yamaha	6EK-12411-00-00	510	18-3719	Chrysler Force	11-826375	238
18-3640	Mercury	8M0117413	391	18-3719	Chrysler Force	11-F694188	238
18-3641	Yamaha	6FP-12411-00-00	510	18-3719	Mercury Marine	11-35921	436, 842
18-3642	Mercury	855676A1	391	18-3719	Mercury Marine	11-47411	436, 842
18-3643	OMC	433379	289	18-3719	Mercury Marine	11-826375	436, 842
18-3644			740	18-3719	Mercury Marine	11-F694188	436, 842
18-3645	Chrysler Inboard	2463441	578	18-3719	OMC	314730	920
2 18-3646	Mercury Marine	807252Q3	740	1 18-3720	Mercury Marine	11-34932	438, 849
2 18-3646	Mercury Marine	807252T6	740	1 18-3721	Mercury Marine	11-13439-1	813
2 18-3647	Mercury Marine	807252Q5	740	1 18-3721	Mercury Marine	11-21298	438, 849
2 18-3647	Mercury Marine	807252T8	740	1 18-3721	Mercury Marine	11-22178	438, 849
2 18-3648			740	1 18-3721	Mercury Marine	11-24648	438, 849
18-3649	Crusader	97895	601	1 18-3721	Mercury Marine	11-29241	438, 849
18-3649	Mercury Marine	8052732	740	1 18-3721	Mercury Marine	11-33962	438, 849
18-3649	Mercury Marine	8072522	740	1 18-3721	Mercury Marine	11-34933	438, 849
18-3649	Mercury Marine	807252T2	740	1 18-3721	Mercury Marine	11-46355	438, 849
18-3649	Mercury Marine	8M0091470	740	1 18-3721	Mercury Marine	11-82671015	438, 849
2 18-3650	Mercury Marine	59078T3	740	1 18-3721	Mercury Marine	11-859116	813
2 18-3651			740	1 18-3721	Mercury Marine	11-95702	438, 849
18-3652			740	1 18-3722	Mercury Marine	11-20361	438, 849
2 18-3653			891	1 18-3722	Mercury Marine	11-35888	438, 849
18-3654	Volvo	875779	973	1 18-3722	Mercury Marine	11-8267089	438, 849
18-3656	Volvo	875781	974	1 18-3722	OMC	121731	927
18-3656	Volvo	876097	974	1 18-3722	Volvo	3852005	990
18-3658	Volvo	875784	974	1 18-3723	Mercury Marine	11-45592	438, 849
18-3658	Volvo	877349	974	1 18-3725	OMC	908064	920
18-3659	Volvo	875785	974	18-3726	Suzuki	09141-18005	470
18-3660	Volvo	875787	974	18-3728	Mercury Marine	11-863332	813
18-3660	Volvo	3831425	974	18-3728	Mercury Marine	11-99298	813
18-3662	Volvo	875794	974	18-3729	Mercury Marine	10-36289	813
18-3662	Volvo	876305	974	18-3729	Mercury Marine	10-97934	813
18-3663	Volvo	875791	974	18-3730	OMC	3852648	925
18-3664	Volvo	875795	974	18-3730	Volvo	3852648-9	989
18-3665	Volvo	875796	974	1 18-3731	OMC	907866	920
2 18-3666	Volvo	875580	974	18-3732	Yamaha	90171-16011-00	534
18-3667			741	18-3732	Yamaha	95307-16900-00	534
2 18-3668	Mer cruiser	807252Q4	741	2 18-3733			925, 990
2 18-3668	Mer cruiser	807252T4	741	1 18-3735	OMC	5030087	329
2 18-3669			289	1 18-3735	Suzuki	09204-03003	470
2 18-3670			892, 974	1 18-3735	Suzuki	09204-03004	470
2 18-3671	Crusader	97361	601	1 18-3735	Yamaha	91490-40030-00	533
2 18-3671	Pleasurecraft	RP026002E	628	1 18-3737	Suzuki	09204-02004	470
2 18-3672			289	1 18-3740	OMC	302804	329
2 18-3673			289	1 18-3741	OMC	309955	329
2 18-3674			289	1 18-3742	OMC	314502	329
18-3675	Mercury Marine	27-850318	421	1 18-3743	OMC	320785	329
18-3675	Mercury Marine	27-8503181	421	1 18-3744	OMC	552906	329
2 18-3676	Volvo	3853983	974	1 18-3744	Volvo	3852255	990
2 18-3676			892	1 18-3745	Volvo	17253-6	990
2 18-3677	Volvo	3856961	974	1 18-3746			58
2 18-3677			892	1 18-3747			58
18-36850			378	1 18-3748	Yamaha	91490-30045-00	533
18-36905	Volvo	3854018	957	1 18-3748			58
18-36906	Mercury	811536	721	18-3749	Mercury Marine	816685	832
18-36906	Mercury	811536T	721	18-3751	Mercury Marine	79448	438, 843
18-36956	Mercury	1395-9267	378	18-3752	Mercury Marine	35992	832
18-3700	Mercury Marine	11-52707	439	18-3752	Mercury Marine	66071	832
18-3700	Mercury Marine	11-827614	439	18-3752	Mercury Marine	8168111	832
18-3700	Mercury Marine	F7040	439	18-3752	Mercury Marine	8168112	832
18-3700	Pleasurecraft	RP017066	632	18-3753	Johnson/Evinrude	5005034	329
2 18-3701	Mercury Marine	11-52707A1	439, 847	18-3754	Mercury Marine	43436	836
2 18-3701	Mercury Marine	11-52707A2	439, 847	18-3755			847
2 18-3701	Mercury Marine	11-52707Q1	439, 847	18-3756			847
2 18-3701			238, 250, 632	18-3759	Mercury Marine	35915	842
2 18-3702	Mercury Marine	11-69578A1	439	18-3760	Mercury Marine	23-806036A1	832
2 18-3702	Mercury Marine	11-69578Q1	439	18-3763	OMC	322941	325, 327, 914
2 18-3702	Mercury Marine	11-69578T1	439	18-3765	OMC	331880	337
18-3703	Mercury Marine	11-88228	439	18-3766	OMC	334163	337, 924
18-3704	Mercury Marine	11-69578	439	18-3768	OMC	911751	329, 924
1 18-3705	OMC	314503	329, 925	18-3769	OMC	911753	920
1 18-3706	OMC	318971	329	18-3770	OMC	911937	915
1 18-3707	OMC	319891	329	18-3771			534
18-3708-1	OMC	398042	329	18-3773	Yamaha	90171-10M01	534
18-3708-1	Volvo	3850984	990	18-3774	Suzuki	57630-94500	470
18-3709	Yamaha	647-45616-02	534	18-3775	Suzuki	57630-92E00	470
18-3710	Suzuki	09141-14008	470	18-3777	Suzuki	57630-94300	470

1 This product is priced per piece. To order, priced per package, please add -9 to the part number
 2 Items ending in "D" are display packaged - regular number is non-display
 3 For discount shop pack of 10, please add -10 to the part number

SIERRA #	O.E.M.	O.E. #	PAGE #	SIERRA #	O.E.M.	O.E. #	PAGE #
SIERRA							
18-3778	Suzuki	57630-96300	470	18-3841-2	OMC	203130	307
2 18-3781	Yamaha	6H1-W4599-00-00	534	18-3842	Volvo	833274	983
2 18-3782	Yamaha	6G5-W4599-00-00	534	18-3843	Volvo	859155	983
18-37824	Indmar	S556003	618	18-3844	Mercury Marine	27-803508	417
18-37824	Pleasurecraft	9-37824	628	18-3845	Mercury Marine	27-825032	417
18-3783	Mercury Marine	11-805092	847	18-3847	Yamaha	6L2-11181-A1-00	521
18-3783	Mercury Marine	11-805092T	847	18-3847	Yamaha	6L2-11181-A2-00	521
18-3783	Mercury Marine	11-859131	847	18-3848	Yamaha	697-11181-A0-00	521
18-3784	Mercury Marine	805100	846	18-3848	Yamaha	697-11181-A1-00	521
18-3785	Mercury Marine	11-39823	847	18-3849	Yamaha	695-11181-A0-00	521
18-3785	Mercury Marine	11-39907	847	18-3849	Yamaha	695-11181-A1-00	521
18-3785	Mercury Marine	11-54034	847	18-3850	Nissan/Tohatsu	3C8010055M	459
18-3785	Mercury Marine	11-82671127	847	18-3851	Chrysler Force	27-F286529-3	234
18-3786	Mercury Marine	11-805093	847	18-3852	Chrysler Force	27-F513529	234
18-3786	Mercury Marine	11-862907	847	18-3853	Chrysler Force	27-F691529-1	234
18-3787	Mercury Marine	805101T	847	18-3854	Chrysler Force	27-F658529	234
18-3788-9	Mercury Marine	14-34817	847	18-3855	Chrysler Force	27-820438	234
18-3791			534	18-3856	Chrysler Force	27-F201529-1	234
18-3792	Yamaha	90171-14056-00	534	18-3857	Chrysler Force	27-824615	235
18-3792			534	18-3857	Chrysler Force	27-824615-2	235
18-3800	OMC	325273	307	18-3857	Chrysler Force	27-F476529-4	235
18-38008	Honda	17660-ZV5-902	242	18-3857	Chrysler Force	F476529	235
18-3801	OMC	325647	307	18-3857	Chrysler Force	F476529-1	235
18-3801	OMC	335361	307	18-3857	Chrysler Force	F476529-2	235
18-3802	OMC	320658	307	18-3859	Chrysler Force	27-819138-2	235
18-3802	OMC	327795	307	18-3860	Chrysler Inboard	4142880	579
18-3802	OMC	335359	307	18-3861	Mercury Marine	27-187851	417
18-3803	OMC	324324	307	18-3861	Mercury Marine	27-187853	417
18-3803	OMC	329419	307	18-3861	Mercury Marine	27-18785T	417
18-3803	OMC	765012	307	18-3862	Mercury Marine	27-41246-1	417
18-3804	Mercury Marine	27-19138	417	18-3863	Mercury Marine	27-96542-1	417
18-3804	Mercury Marine	27-19138M	417	18-3864	Mercury Marine	27-822844-1	417
18-3804	Mercury Marine	27-84733M	417	18-3866	OMC	340115	307
18-3804	Yamaha	689-11181-02-00	521	18-3867	Volvo	859647	983
18-3804	Yamaha	689-W0001-A1-00	521	18-3868	Volvo	3583786	983
18-3805	Yamaha	688-11181-02-00	521	18-3869	Volvo	3854202	983
18-3805	Yamaha	688-11181-A1-00	521	18-3870	Volvo	876303	981
18-3806	Suzuki	11141-98401	468	18-3871	Mercury Marine	27-18786-1	417
18-3806	Suzuki	11141-98411	468	18-3872	Mercury Marine	27-41245-1	417
18-3807	Suzuki	11141-98101	468	18-3873	Volvo	3853587	983
18-3807	Suzuki	11141-98130	468	18-3874	Crusader	31137	612
18-3808	Suzuki	11141-93901	468	18-3874	Mercury Marine	27-811546	807
18-3808	Suzuki	11141-93960	468	18-3874	Mercury Marine	27-879150139	807
18-3809	Suzuki	11141-96303	468	18-3874	OMC	3853511	907
18-3809	Suzuki	11141-96344	468	18-3876	Chris-Craft	16.50-00250	571
18-3810	Suzuki	11141-94401	468	18-3876	Crusader	7057500	612
18-3810	Suzuki	11141-94450	468	18-3876	GM	6269577	632
18-3813	Suzuki	11141-95305	468	18-3876	Mercury Marine	27-34278	807
18-3813	Suzuki	11141-95320	468	18-3876	Mercury Marine	27-48330	807
18-3814	Suzuki	11141-95505	469	18-3876	Mercury Marine	27-75611	807
18-3814	Suzuki	11141-95512	469	18-3876	Mercury Marine	27-75611001	807
18-3816	Suzuki	11141-98504	469	18-3876	OMC	914971	907
18-3816	Suzuki	11141-98510	469	18-3876	OMC	3853380	907
18-3816	Suzuki	11141-98522	469	18-3876	Volvo	841207	983
18-3819	Suzuki	11141-95D10	469	18-3876	Volvo	856474	983
18-3819	Suzuki	11141-95D90	469	18-3877	Chris-Craft	16.50-00259	571
18-3820	Suzuki	11141-94701	469	18-3877	Crusader	30266	612
18-3820	Suzuki	11141-94702	469	18-3877	Mercury Marine	27-13218	807
18-3820	Suzuki	11141-94720	469	18-3877	Mercury Marine	27-13687	807
18-3822	Suzuki	11141-87E10	469	18-3877	Mercury Marine	27-19315	807
18-3822	Suzuki	11141-87E90	469	18-3877	Mercury Marine	27-49104	807
18-3823	Suzuki	11141-94506	469	18-3877	Mercury Marine	27-61224	807
18-3823	Suzuki	11141-94620	469	18-3877	Mercury Marine	27-8M0049045	807
18-3824	Suzuki	11141-94600	469	18-3877	Mercury Marine	27-97529	807
18-3824	Suzuki	11141-94620	469	18-3877	OMC	914849	907
18-3825	Suzuki	11141-87D60	469	18-3878	Chrysler Inboard	4417375	579
18-3825	Suzuki	11141-87D90	469	18-3878	Mercury Marine	27-13709	807
18-3827	Mercury Marine	27-825482	417	18-3878	Mercury Marine	27-13709T	807
18-3827	Mercury Marine	27-8254821	417	18-3878	Mercury Marine	27-74264	807
18-3827	Yamaha	6G8-11181-00-00	521	18-3878	Mercury Marine	27-79986	807
18-3827	Yamaha	6G8-11181-A1-00	521	18-3878	Mercury Marine	27-92166	807
18-3828	Mercury Marine	27-18937	417	18-3878	Mercury Marine	27-921661	807
18-3828	Mercury Marine	27-18937M	417	18-3878	OMC	912766	907
18-3828	Mercury Marine	27-83899M	417	18-3879	Crusader	33408	612
18-3828	Mercury Marine	27-98990M	417	18-3879	Mercury Marine	27-11986	807
18-3828	Yamaha	6E7-11181-00-00	521	18-3879	Mercury Marine	27-42744	807
18-3828	Yamaha	6E7-11181-A1-00	521	18-3879	Mercury Marine	27-816460	807
18-3829	Yamaha	6J8-11181-00-00	521	18-3879	Mercury Marine	27-879150140	807
18-3829	Yamaha	6J8-11181-A1-00	521	18-3879	OMC	912227	907
18-3830	Yamaha	6H4-11181-00-00	521	18-3879	OMC	914930	907
18-3830	Yamaha	6H4-11181-A1-00	521	18-3879	OMC	3854299	907
18-3831	Yamaha	6H3-11181-01-00	521	18-3879	Volvo	912227	983
18-3831	Yamaha	6H3-11181-A1-00	521	18-3879	Volvo	914930	983
18-3832	Yamaha	6E5-11181-02-00	521	18-3879	Volvo	3854299	983
18-3832	Yamaha	6E5-11181-A1-00	521	18-3880	Mercury Marine	27-34273	807
18-3834	Volvo	833453	983	18-3880	Mercury Marine	27-342731	807
18-3836	OMC	329836	307	18-3880	OMC	311210	907
18-3837	OMC	328623	307	18-3881	Mercury Marine	27-34274	807
18-3838	OMC	331211	307	18-3881	Mercury Marine	27-39164	807
18-3839	OMC	333670	307	18-3881	Mercury Marine	27-47453	807
18-3839	OMC	334726	307	18-3881	Mercury Marine	27-72622	807

1 This product is priced per piece. To order, priced per package, please add -9 to the part number

2 Items ending in "D" are display packaged - regular number is non-display

3 For discount shop pack of 10, please add -10 to the part number

SIERRA #	O.E.M.	O.E. #	PAGE #	SIERRA #	O.E.M.	O.E. #	PAGE #
SIERRA							
18-3881	OMC	908237	907	18-3938	Mercury Marine	FI1101322	791
18-3883	Mercury Marine	27-56110	807	18-3938	OMC	328516	903
18-3883	Mercury Marine	27-64763	807	18-3938	OMC	914557	903
18-3883	Mercury Marine	27-75646	807	18-3938	Volvo	328516	979
18-3883	Mercury Marine	27-75647	807	18-3938	Volvo	914557	979
18-3883	OMC	3853732	907	18-3939	Mercury Marine	39-48344	791
18-3883	Pleasurecraft	RM0032	632	18-3939	Mercury Marine	39-66217	791
18-3883	Volvo	3853732	983	18-3939	Mercury Marine	39-97125	791
18-3886	Nissan/Tohatsu	3T9010050M	459	18-3939	Mercury Marine	FI1100387	791
18-3887	Crusader	31136	612	18-3939	Mercury Marine	FI1100783	791
18-3887	Mercury Marine	27-811547	807	18-3939	Mercury Marine	FI1101134	791
18-3887	Mercury Marine	27-850470	807	18-3939	OMC	914556	903
18-3887	Mercury Marine	27-879150141	807	18-3939	OMC	3854252	903
18-3887	OMC	915325	907	18-3939	Volvo	914556	979
18-3887	Volvo	3853511	983	18-3939	Volvo	3854252	979
18-3888			993	18-3940	Mercury Marine	39-67127	791
18-3889			973	18-3940	OMC	328536	903
18-3890			973	18-3942	Mercury Marine	39-34479	791
18-3891	Yamaha	61A-11181-A0-00	521	18-3942	Mercury Marine	39-58096	791
18-3891	Yamaha	61A-11181-A1-00	521	18-3942	Mercury Marine	39-67119	791
18-3892	Yamaha	676-11181-A0-00	521	18-3942	Mercury Marine	39-67132	791
18-3892	Yamaha	676-11181-A1-00	521	18-3944	Mercury Marine	39-75609	791
18-3893			992	18-3944	Mercury Marine	FI1101057	791
18-3894	Yamaha	6G5-11181-00-00	521	18-3944	OMC	370409	903
18-3894	Yamaha	6G5-11181-A0-00	521	18-3944	Volvo	370409	979
18-3895	OMC	332816	307	18-3947	OMC	439538	292
18-3896	OMC	332817	307	18-39480	Suzuki	12140-93121	468
18-3898	OMC	332819	307	18-39530	Suzuki	12410-96351-050	468
18-3899	OMC	327674	313	18-39540	Suzuki	12140-94400	468
18-3901	OMC	436254	292	18-3957	Yamaha	61N-11603-00-00	515
18-39010	Chrysler Force	39-817869A1	233	18-3960	Yamaha	6H4-11610-00-00	515
18-39010	Chrysler Force	FA663260	233	18-3961	Yamaha	6H4-11610-10-00	515
18-3902	Mercury Marine	39-45155A12	403	18-3962	Yamaha	6H4-11610-20-00	515
18-3902	Mercury Marine	39-78816A12	403	18-3963	Yamaha	6K5-11601-02-00	515
18-3904	OMC	394930	292	18-3966	Mercury Marine	39-18653A12	403
18-3905	OMC	396504	292	18-3967	Mercury Marine	39-18653A1	403
18-3906	OMC	385662	292	18-3968	Mercury Marine	39-18653A2	403
18-3906	OMC	396503	292	18-3969	Yamaha	688-11603-A0-00	515
18-3907	OMC	390509	292	18-3972	OMC	390082	293
18-3908	OMC	390510	292	18-3974	OMC	431844	292
18-3910	OMC	396377	292	18-3975	OMC	431870	292
18-3911	OMC	396378	292	18-3976	Mercury Marine	39-15320M	403
18-3912	OMC	396379	292	18-3976	Mercury Marine	39-15320T	403
18-3913	OMC	391170	292	18-3976	Yamaha	682-11610-01-00	515
18-3913	OMC	434107	292	18-3977	Mercury Marine	39-18939M	403
18-3914			292	18-3977	Yamaha	682-11610-11-00	515
18-3915	OMC	391416	292	18-3978	Mercury Marine	39-15322M	403
18-3915	OMC	434109	292	18-3979	Mercury Marine	39-96170A12	403
18-3916	Mercury Marine	39-45204A12	403	18-3981	Mercury Marine	39-96170A4	403
18-3916	Mercury Marine	39-78811A12	403	18-3982	Mercury Marine	39-822321A12	403
18-3917	Mercury Marine	39-88392	403	18-3982	Mercury Marine	39-824905A12	403
18-3917	Mercury Marine	39-88392A12	403	18-3984	Mercury Marine	39-822321A2	403
18-3918	Mercury Marine	39-817096A6	403	18-3986	Mercury Marine	39-81096M	403
18-3919	Mercury Marine	39-817096A16	403	18-3992	Mercury Marine	39-83196M	403
18-3920	Mercury Marine	39-817096A26	403	18-3998	Chrysler Force	39-820457A2	233
18-3921	Mercury Marine	39-93481A12	405	18-3999	Chrysler Force	39-820641A1	233
18-3922	Mercury Marine	39-78918A4	405	18-4005	Volvo	833950	977
18-3923	Mercury Marine	39-85636A4	405	18-4008	Barr	MC-20-60207	780
18-3924	Mercury Marine	39-18487A12	405	18-4008	Mercury Marine	60207	780
18-3925	Mercury Marine	39-815267A4	405	18-4009	Barr	160252	780
18-3927	Mercury Marine	39-813011A12	405	18-4009	Mercury Marine	52999	780
18-3928	Mercury Marine	39-74381A1	791	18-4009	Mercury Marine	60252	780
18-3928	Mercury Marine	39-75422	791	18-4009	Mercury Marine	60252A2	780
18-39320	Yamaha	6R5-11603-00	515	18-4009	OMC	910384	898
18-3933	OMC	386280	292	18-40110	Suzuki	12110-94400	468
18-3934	Yamaha	6E5-11610-03-00	515	18-4013	Mercury Marine	765-7443A11	405
18-3936	Yamaha	6E5-11610-23-00	516	18-4014	Mercury Marine	765-7446A11	405
18-3937	GM	14089025	903, 979	18-40140	Suzuki	12110-93120	468
18-3937	Mercury Marine	39-17464	791	18-4017	Mercury Marine	783-9613A2	403
18-3937	Mercury Marine	39-34988	791	18-4017	Mercury Marine	783-9613T2	403
18-3937	Mercury Marine	39-65153	791	18-4018	Mercury Marine	783-9613A3	403
18-3937	Mercury Marine	39-67123	791	18-4018	Mercury Marine	783-9613T3	403
18-3937	Mercury Marine	F328506	791	18-4019	Mercury Marine	39-19721A6	403
18-3937	Mercury Marine	F3892364	791	18-4020	Mercury Marine	39-19721A1	403
18-3937	Mercury Marine	FI1100386	791	18-4021	Mercury Marine	39-19721A2	403
18-3937	Mercury Marine	FI1100692	791	18-4022	Mercury Marine	26-49131	800
18-3937	Mercury Marine	FI1101321	791	18-4022	Mercury Marine	26-67863	800
18-3937	OMC	328506	903	18-4022	Mercury Marine	26-75982	800
18-3937	OMC	914555	903	18-4022	Mercury Marine	26-75988	800
18-3937	OMC	985083	903	18-4022	Mercury Marine	26-75988	800
18-3937	OMC	986336	903	18-4022	Mercury Marine	F3866612	800
18-3937	OMC	3853268	903	18-4022	Mercury Marine	FI1100968	800
18-3937	OMC	3853960	903	18-4022	Mercury Marine	FI1101117	800
18-3937	Volvo	3853268	979	18-4023	Mercury Marine	26-58094	800
18-3937	Volvo	3853960	979	18-4023	Mercury Marine	26-72564	800
18-3938	GM	14089026	903, 979	18-4023	Mercury Marine	26-75413	800
18-3938	Mercury Marine	39-17465	791	18-4023	Mercury Marine	26-75624	800
18-3938	Mercury Marine	39-48345	791	18-4024	Mercury Marine	26-8M0050563	800
18-3938	Mercury Marine	39-67126	791	18-4024	Mercury Marine	26-97664	800
18-3938	Mercury Marine	F328516	791	18-4024	Mercury Marine	26-976641	800
18-3938	Mercury Marine	FI1100694	791	18-4024	Mercury Marine	FI1101200	800
18-3938	Mercury Marine		791	18-4024	OMC	914445	911

1 This product is priced per piece. To order, priced per package, please add -9 to the part number

2 Items ending in "D" are display packaged - regular number is non-display

3 For discount shop pack of 10, please add -10 to the part number

SIERRA #	O.E.M.	O.E. #	PAGE #	SIERRA #	O.E.M.	O.E. #	PAGE #
SIERRA							
1	18-4024	OMC	3853226	911	18-4134	Mercury Marine	759-80661A8 791
1	18-4024	Volvo	914445	980	18-4134	Mercury Marine	759-806661A5 791
1	18-4024	Volvo	3853226	980	18-4134	Mercury Marine	759-831212 791
	18-4029	Volvo	463377	976	18-4134	Mercury Marine	759-8312A6 791
	18-4031	Volvo	1306630	980	18-4134	Mercury Marine	759-9015A4 791
1	18-4036	Mercury Marine	29-47270	406	18-4134	Mercury Marine	778-9441A5 791
1	18-4037	Mercury Marine	29-71422	406	18-4135	Mercury Marine	761-7131M 403
	18-4038	Mercury Marine	31-47245A1	406	18-4135	Mercury Marine	761-7133M 403
	18-4038	Mercury Marine	31-55332A1	406	18-4135	Mercury Marine	761-7134M 403
	18-4038	Mercury Marine	31-58859A1	406	18-4135	Mercury Marine	761-7982M 403
	18-4038	Mercury Marine	31-61424A2	406	18-4135	Mercury Marine	761-7982T 403
	18-4038	Mercury Marine	31-62596A1	406	18-4135	Yamaha	6E7-11631-00-97 515
	18-4038	Mercury Marine	31-63075A1	406	18-4138	Mercury Marine	761-7196M 403
	18-4039	Mercury Marine	31-17514A2	406	18-4138	Mercury Marine	761-7197M 403
	18-4039	Mercury Marine	31-8M0045430	406	18-4138	Mercury Marine	761-7198M 403
	18-4040	OMC	387139	296	18-4138	Mercury Marine	761-8484M 403
	18-4040	OMC	387142	296	18-4138	Yamaha	689-11631-00-95 515
	18-4044	Volvo	834548	976	18-4141	Yamaha	6H4-11631-00-96 515
	18-4044	Volvo	966694-2	976	18-4142	Yamaha	6H4-11635-01-00 515
	18-4046	Volvo	958498	976	18-4143	Yamaha	6H4-11636-00-00 515
	18-4046	Volvo	966857	976	18-4145	Yamaha	61N-11635-00-00 515
	18-4050	Mercury Marine	39-827179A12	405	18-4146	Yamaha	61N-11636-00-00 515
	18-4051	Mercury Marine	39-826293A12	405	18-4148-1	OMC	394488 295
	18-4052	Mercury Marine	39-826297A12	405	18-4148-1	OMC	5004705 295
	18-4055	OMC	436242	294	18-4150	Volvo	812994 973
	18-4058			294	18-4156	Mercury Marine	776-9096A1 403
	18-4062	OMC	387661	292	18-4157	Yamaha	6R5-11650-10-00 516
	18-4063	OMC	394461	292	18-4160	Mercury Marine	733-3818 791
	18-4063	OMC	437409	292	18-4160	Mercury Marine	733-38181 791
	18-4064	OMC	398483	292	18-4160	Mercury Marine	FI1100781 791
	18-4065	OMC	432072	292	18-4160	OMC	915236 903
	18-4065	OMC	432969	292	18-4160	OMC	3853477 903
	18-4066	OMC	432073	292	18-4160	Volvo	915236 979
	18-4066	OMC	432970	292	18-4160	Volvo	3853477 979
	18-4067	OMC	432077	292	18-4161	Mercury Marine	24-38191 791
	18-4067	OMC	433003	292	18-4161	Mercury Marine	733-3819 791
	18-4068	OMC	432078	292	18-4161	Mercury Marine	733-4028 791
	18-4068	OMC	433004	292	18-4161	Mercury Marine	733-803850T 791
	18-4069	OMC	432803	293	18-4161	Mercury Marine	FI1100779 791
1	18-4075	OMC	308186	295	18-4161	Mercury Marine	FI1100780 791
	18-4076	OMC	330081	295	18-4161	OMC	914816 903
	18-4077	Yamaha	93310-730V8-00	516	18-4161	OMC	3853340 903
	18-4078	Yamaha	93310-836V2-00	516	18-4161	Volvo	914816 979
	18-4079	OMC	436859	292	18-4161	Volvo	3853340 979
	18-4080	Yamaha	6R5-11642-11-93	515	18-4164	GM	14077949 903
	18-4081	Yamaha	6R5-11631-11-93	515	18-4164	Mercury Marine	735-6371 791
	18-4082	Yamaha	6R5-11645-11-00	515	18-4164	Mercury Marine	735-850098 791
	18-4083	Yamaha	6R5-11635-11-00	515	18-4164	Mercury Marine	735-9431 791
	18-4084	Yamaha	6R5-11646-11-00	515	18-4164	Mercury Marine	735-9687 791
	18-4085	Yamaha	6R5-11636-11-00	515	18-4164	Mercury Marine	735-9704 791
	18-4086	OMC	439516	292	18-4164	Mercury Marine	FI1101185 791
	18-4087	OMC	439517	292	18-4164	Mercury Marine	FI1101320 791
	18-4088	OMC	436353	294	18-4164	Mercury Marine	FI1101336 791
	18-4089			294	18-4164	OMC	3911023 903
	18-4090	OMC	436354	294	18-4164	Volvo	3911023 979
	18-4091	Yamaha	6H3-11631-01-96	515	18-4165	OMC	439515 292
	18-4093	Yamaha	6H3-11636-01-00	515	18-4173	GM	14077948 903, 979
	18-4096	Yamaha	6K5-11636-03-00	515	18-4173	Mercury Marine	735-6370 791
	18-4097	Yamaha	6H1-11631-03-95	515	18-4173	Mercury Marine	735-6370 791
	18-4099	Yamaha	6H1-11636-03-00	515	18-4173	Mercury Marine	735-808661 791
	18-4100	OMC	396585	292	18-4173	Mercury Marine	735-808674 791
	18-4100	OMC	396588	292	18-4173	Mercury Marine	735-808674A1 791
	18-4101	OMC	391653	292	18-4173	Mercury Marine	735-850097 791
	18-4102	OMC	393612	292	18-4173	Mercury Marine	735-9686 791
	18-4103	OMC	396587	292	18-4173	Mercury Marine	735-9703 791
	18-4104	OMC	396583	292	18-4173	Mercury Marine	833232E 791
	18-4107	OMC	392621	292	18-4173	Mercury Marine	FI1101184 791
	18-4109	Mercury Marine	759-592010	791	18-4173	Mercury Marine	FI1101318 791
	18-4109	Mercury Marine	759-661010	791	18-4173	Mercury Marine	FI1101334 791
	18-4109	Mercury Marine	759-80661A3	791	18-4173	OMC	3911020 903
	18-4109	Mercury Marine	759-80661A7	791	18-4173	Volvo	3911020 979
	18-4109	Mercury Marine	759-831210	791	18-4178	Mercury Marine	735-9715 791
	18-4109	Mercury Marine	759-8312A2	791	18-4178	Mercury Marine	735-97151 791
	18-4109	Mercury Marine	778-9015A2	791	18-4178	Mercury Marine	735-9715T1 791
	18-4109	Mercury Marine	778-9441A3	791	18-4178	Mercury Marine	FI1101317 791
	18-4110			292	18-4180	Mercury Marine	733-2278 791
	18-4111			292	18-4180	Mercury Marine	733-66217 791
	18-4113			292	18-4180	Mercury Marine	736-2343 791
	18-4114	OMC	387285	292	18-4181	Mercury Marine	735-6538 791
	18-4118			792, 794	18-4183		903, 979
	18-4120	OMC	393271	292	18-4188		903, 979
	18-4120	OMC	393924	292	18-4189	Mercury Marine	737-6523 791
	18-4122	OMC	393566	292	18-4189	Mercury Marine	737-879194035 791
	18-4123	OMC	392455	292	18-4189	Mercury Marine	FI1101101 791
	18-4124	OMC	387284	292	18-4189		903, 979
	18-4128	Yamaha	6G5-11642-00-93	515	18-4190	OMC	436860 292, 294
	18-4129	Yamaha	6G5-11631-00-93	515	18-4191	Mercury Marine	733-3819 791
	18-4130			515	18-4191	Mercury Marine	733-38191 791
	18-4133	Yamaha	6G5-11636-00-00	515	18-4191	Mercury Marine	733-4028 791
	18-4134	Mercury Marine	759-592012	791	18-4191	Mercury Marine	733-803850T 791
	18-4134	Mercury Marine	759-661012	791	18-4191	Mercury Marine	FI1100779 791

1 This product is priced per piece. To order, priced per package, please add -9 to the part number
 2 Items ending in "D" are display packaged - regular number is non-display
 3 For discount shop pack of 10, please add -10 to the part number

SIERRA #	O.E.M.	O.E. #	PAGE #	SIERRA #	O.E.M.	O.E. #	PAGE #
SIERRA							
18-4191	Mercury Marine	Fl1100780	791	18-4261	Mercury Marine	19643	425
18-4191			903, 979	18-4263	Mercury Marine	22-30139	780
18-4194	OMC	3852350	925	18-4263	Mercury Marine	22-32802	780
18-4194	Volvo	3852350	990	18-4263	Mercury Marine	22-328021	780
18-4195	OMC	439015	292	18-4263	Mercury Marine	22-328022	780
18-4197	OMC	334665	295	18-4263	Mercury Marine	22-841908	780
1 18-4200	Volvo	477024	977	18-4263	Mercury Marine	F700633	780
1 18-4201	Volvo	192212	977	18-4263	Mercury Marine	FI5810151	780
18-4204	Volvo	826341	989	18-4263			570, 588, 610, 631, 779, 780, 898, 972
18-4204	Volvo	876278	989				
18-4205	Volvo	832820	989	18-4264	Mercury Marine	22-32803	780
18-4206	Volvo	832570	989	18-4264	Mercury Marine	22-87543	780
18-4208	Volvo	839423	989	18-4264	Mercury Marine	FI5880010	780
18-4209	Volvo	839534	989	18-4264			89, 145, 570, 588, 610, 631, 898, 972
18-4210	Volvo	850785	989				
18-4210	Volvo	854045	989	18-4265	Mercury Marine	22-42861	780
18-4211	Volvo	850888	989	18-4265	Mercury Marine	22-428611	780
18-4212	Volvo	850889	990	18-4265	Mercury Marine	22-861187	780
18-4213	Volvo	851261	990	1 18-4267	Mercury Marine	12-29395	813
18-4213	Volvo	854047	990	1 18-4267	Mercury Marine	12-8M0042641	813
18-4214	Pleasurecraft	FO96081	632	1 18-4270	Mercury Marine	12-36001	813
18-4214	Volvo	897367	990	18-4272	Mercury Marine	19-32652	913
18-4215	Volvo	941816	990	18-4273	Mercury Marine	19-42682	813
18-4216	Volvo	807036	972	18-4274	Yamaha	688-45997-01-00	532
18-4217	Volvo	82744	Obsolete	18-4275	Mercury Marine	12-22388	425
2 18-4218	Mercury Marine	22-16951A1	783	18-4275	Mercury Marine	12-25945	425
2 18-4218	Mercury Marine	22-16951Q1	783	18-4275	Mercury Marine	12-29245	425
2 18-4218	Mercury Marine	22-16951T1	783	18-4275	Mercury Marine	12-32733	425
2 18-4218	Mercury Marine	22-64426	783	18-4275	Mercury Marine	12-38753	425
2 18-4218	Mercury Marine	22-87238	783	18-4275	Mercury Marine	12-824793	425
2 18-4218	OMC	379957	898	1 18-4276	OMC	324334	285, 309
2 18-4218	Volvo	82745	972	18-4277	OMC	324430	285, 309
2 18-4218			570, 588, 610, 631, 783, 982	18-4280	OMC	327861	292
18-4219	Volvo	829592	972	18-42850	Suzuki	12151-94400	468
2 18-4220	Mercury Marine	12-13171	440	18-42860	Suzuki	12151-93100	468
2 18-4220	Mercury Marine	12-77987	440	18-4287			405, 406
2 18-4220	Mercury Marine	12-77987A1	440	18-42870	Suzuki	12151-92502	468
2 18-4220	Mercury Marine	12-835467	440	1 18-4288	Mercury Marine	23-44165	853
2 18-4220	Mercury Marine	12-8354671	440	1 18-4288	Mercury Marine	23-807073	853
2 18-4220	Mercury Marine	12-835467Q01	440	1 18-4289	Mercury Marine	53-805272	853
2 18-4220	Pleasurecraft	RO96116	431, 440, 632, 821, 823, 825, 846	1 18-4290	OMC	317831	292
				1 18-4292	OMC	326765	292
18-4221	Mercury Marine	13191A1	440	1 18-4294	Mercury Marine	40-52035	403
18-4221	Mercury Marine	75282A1	440	18-42940-9	Suzuki	09381-14001	468
18-4222	OMC	127084	329	1 18-4295	Mercury Marine	53-29641	843
18-4222	OMC	318841	925	18-42950-9	Suzuki	09381-18002	468
18-4223	OMC	333592	329, 925	18-4296	Mercury Marine	35983	832
2 18-4224	Mercury Marine	22-806926A1	783	18-42960-9	Suzuki	09381-20003	468
2 18-4224	Mercury Marine	22-862210A01	783	18-4299	Nissan/Tohatsu	3F3010051M	459
18-4226	Mercury Marine	22-806608A02	783	18-4300	OMC	385416	301
18-4226	Mercury Marine	22-806608A1	783	18-4301	OMC	388602	301
18-4227	Mercury Marine	22-806926	783	18-43015	Mercury	864493	740
18-4227	Mercury Marine	22-862210	783	18-43017	Indmar	S985009	616
18-4228	OMC	315810	329, 925	18-43017	Mercury	863358T	740
18-4229	OMC	319890	329	18-43017	Mercury	8M0074922	740
18-4230	OMC	320305	329	18-43017	Mercury	8M0076464	740
18-4231	OMC	320570	329, 925	18-4302	OMC	390078	302
18-4232	OMC	323943	329	18-4303-1	OMC	389556	302
18-4233	Mercury Marine	73345	440	18-4303-1	OMC	391300	302
18-4233	Mercury Marine	12-92647M	440	18-4304-1	OMC	391988	302
18-4233	Mercury Marine	73345A1	440	18-4305	OMC	393433	302
18-4234	Volvo	832965	989	18-43051			391
1 18-4236	Volvo	941907	973	18-43052	Mercury	14586A3	390
1 18-4238	Volvo	943218	990	18-43052	Mercury	75962A10	390
18-4239	Volvo	897873	990	18-43052	Mercury	75962A11	390
1 18-4241	Volvo	951924	990	18-43052	Mercury	75962A9	390
1 18-4245	Volvo	463902	977	18-4306	OMC	394546	303
1 18-4246	Volvo	463903-5	977	18-4307	OMC	389206	303
1 18-4248	OMC	311598	328, 911	18-4307	OMC	392567	303
18-42481-9	OMC	311598	328, 911	18-4307	OMC	392615	303
18-4249	OMC	318544	329	18-4307	OMC	433941	303
1 18-4250	OMC	911820	911	18-4309	OMC	394885	303
1 18-4251	OMC	908062	920	18-4309	OMC	434381	303
1 18-4252	Mercury Marine	24-46312	852	18-4310	OMC	396750	303
18-42531-9	OMC	336982	328, 911	18-4312			233
18-4253-9	OMC	336982	328, 911	18-4313			234
18-4255	OMC	307551	328	18-4317	Mercury Marine	27-90484A32	413
18-4256			89, 145, 570, 588, 610, 631, 898, 972	18-4317	Mercury Marine	27-90484A86	413
				18-4317	Mercury Marine	27-90484A88	413
18-4257			570, 588, 610, 631, 780, 898, 972	18-43175	Mercury	855676002	390
				18-43175	Nissan/Tohatsu	3R3010300M	458
18-4258	Mercury Marine	22-33198	643, 780	18-4318	OMC	390076	304
18-4258	Mercury Marine	22-33198A1	643, 780	18-4319	Mercury Marine	27-11338A85	414
18-4258	Mercury Marine	22-41622	643, 780	18-4319	Mercury Marine	27-11338A88	414
18-4258	Mercury Marine	22-41622	643, 780	18-4319	Mercury Marine	27-89221A32	414
18-4258	Mercury Marine	22-46754	643, 780	18-4319	Mercury Marine	27-89221A84	414
18-4258			270, 588, 610, 631, 898, 972	18-4319	Mercury Marine	27-89221A85	414
				18-4319	Mercury Marine	27-89221A88	414
18-4259	Volvo	804261	986	18-4321	OMC	398047	304
18-42608	Indmar	S556050	616	18-43212	Mercury	46-8037502	394
18-42608	Pleasurecraft	FA057036	628	18-43212	Mercury	46-803750A02	394

1 This product is priced per piece. To order, priced per package, please add -9 to the part number

2 Items ending in "D" are display packaged - regular number is non-display

3 For discount shop pack of 10, please add -10 to the part number

SIERRA #	O.E.M.	O.E. #	PAGE #	SIERRA #	O.E.M.	O.E. #	PAGE #
SIERRA							
18-43212	Nissan/Tohatsu	3B2650160M	458	18-4380	Mercury Marine	27-72098	806
18-4322	OMC	432570	304	18-4381	Mercury Marine	27-41636A1	805
18-4323	OMC	436891	305	18-4381	Mercury Marine	27-43186A1	805
18-4325	Mercury Marine	25-85491A87	414	18-4381	Mercury Marine	27-89656A1	805
18-4325	Mercury Marine	27-85491A90	414	18-4382	Mercury Marine	27-74264A1	805
18-4326	Mercury Marine	27-43779A87	412	18-4382	Mercury Marine	27-74830A1	805
18-43263	Yamaha	68D-G4311-01-00	496	18-4382	Mercury Marine	27-74830A3	805
18-4329			300	18-4383			803
18-4330			300	18-4384			803
18-4331			300	18-4385			804
18-4332			300	18-4386			803
18-4334	Mercury Marine	27-41499A87	412	18-4387	Mercury Marine	27-801853	804
18-4336	Mercury Marine	27-43004A86	412	18-4388	Mercury Marine	27-11977A88	804
18-4336	Mercury Marine	27-43004A90	412	18-4388	Mercury Marine	27-11977A92	804
18-4336	Mercury Marine	27-43004A99	412	18-4389	Mercury Marine	27-47453A1	804
18-4337	Mercury Marine	27-812867A91	412	18-4391	Mercury Marine	27-64763A2	804
18-4337	Mercury Marine	27-812867A96	412	18-4392	Mercury Marine	27-75611A1	804
18-4337	Mercury Marine	27-812867A97	412	18-4392	Mercury Marine	27-75611A2	804
18-4338	Mercury Marine	27-814754A00	412	18-4394	Mercury Marine	27-33395A1	802
18-4339	Mercury Marine	27-14697A87	413	18-4394	Mercury Marine	27-33395A2	802
18-4340	Mercury Marine	27-13461A88	413	18-4395	Mercury Marine	27-35898A2	803
18-4340	Mercury Marine	27-13461A89	413	18-4395	Mercury Marine	27-35898A3	803
18-4340	Mercury Marine	27-13461A90	413	18-4395	Mercury Marine	27-35898A4	803
18-4340	Mercury Marine	27-13461A99	413	18-4396	Mercury Marine	27-46401A1	803
18-4341	Volvo	876380	981	18-4397	Mercury Marine	27-46820A1	803
18-4342	Volvo	876376	981	18-4398	Mercury Marine	27-53354A1	803
18-4346	Chrysler Inboard	3745220	587	18-4399	Mercury Marine	27-54566A1	803
18-4347-1			802	18-4400	Yamaha	61A-W0001-01-00	519
18-4348			802	18-4400	Yamaha	61A-W0001-A1-00	519
18-4349			802	18-4402	OMC/Bombardier	437779	305
18-4351	Mercury Marine	27-64203A73	414	18-4403	Yamaha	6F3-W0001-04-00	519
18-4351	Mercury Marine	27-64203A74	414	18-4403	Yamaha	6F3-W0001-A4-00	519
18-4351	Mercury Marine	27-64203A75	414	18-4404	Yamaha	6G5-W0001-03-00	519
18-4353	Mercury Marine	27-46110A1	415	18-4404	Yamaha	6G5-W0001-A3-00	519
18-4353	Mercury Marine	27-46110A2	415	18-4405	Yamaha	6H1-W0001-00-00	519
18-4353	Mercury Marine	27-46110A72	415	18-4405	Yamaha	6H1-W0001-01-00	519
18-4353	Mercury Marine	27-72486A32	415	18-4405	Yamaha	6H1-W0001-A0-00	519
18-4353	Mercury Marine	27-72486A76	415	18-4406	OMC/Bombardier	437155	305
18-4353	Mercury Marine	27-72486A78	415	18-4407	Yamaha	6H4-W0001-01-00	519
18-4353	Mercury Marine	27-72486A79	415	18-4407	Yamaha	6H4-W0001-A1-00	519
18-4354	Mercury Marine	27-73645A32	415	18-4408	Crusader	33393	611
18-4354	Mercury Marine	27-73645A76	415	18-4408	Mercury Marine	27-11977	802
18-4354	Mercury Marine	27-73645A87	415	18-4408	Mercury Marine	27-11987	802
18-4355	Mercury Marine	27-55306A72	415	18-4408	OMC	912978	906
18-4355	Mercury Marine	27-55306A73	415	18-4408	Volvo	3850379	971
18-4355	Mercury Marine	27-55306A74	415	18-4409	Yamaha	6H4-W0001-03-00	522
18-4355	Mercury Marine	27-55306A75	415	18-4409	Yamaha	6H4-W0001-04-00	522
18-4355	Mercury Marine	27-78028A78	415	18-44092	Mercury	32-861635	753
18-4356	Mercury Marine	27-60476A72	416	18-4411	Yamaha	6N6-W0001-03-00	519
18-4356	Mercury Marine	27-60476A73	416	18-4411	Yamaha	6N6-W0001-A3-00	519
18-4356	Mercury Marine	27-60476A74	416	18-4412	Yamaha	6R3-W0001-03-00	519
18-4356	Mercury Marine	27-60476A75	416	18-4412	Yamaha	6R3-W0001-A3-00	519
18-4356	Mercury Marine	27-85653A32	416	18-4413	Yamaha	6R6-W0001-01-00	520
18-4356	Mercury Marine	27-85653A79	416	18-4415	Yamaha	688-W0001-00-00	520
18-4356	Mercury Marine	27-85653A87	416	18-4415	Yamaha	688-W0001-A0-00	520
18-4357	Mercury Marine	27-73440A76	416	18-4417	Yamaha	695-W0001-01-00	520
18-4357	Mercury Marine	27-76589A77	416	18-4417	Yamaha	695-W0001-02-00	520
18-4357	Mercury Marine	27-76589A78	416	18-4417	Yamaha	695-W0001-A2-00	520
18-4357	Mercury Marine	27-76589A79	416	18-4419	Yamaha	6H4-W0001-02-00	520
18-4357	Mercury Marine	27-88449A32	416	18-4419	Yamaha	6H4-W0001-A2-00	520
18-4357	Mercury Marine	27-88449A80	416	18-4420	OMC/Bombardier	439202	305
18-4359	Mercury Marine	27-815791A92	416	18-4421	OMC/Bombardier	5000400	305
18-4359	Mercury Marine	27-815792A90	416	18-4422	Yamaha	6L2-W0001-01-00	520
18-4359	Mercury Marine	27-815809A90	416	18-4422	Yamaha	6L2-W0001-02-00	520
18-4359	Mercury Marine	27-815810A90	416	18-4422	Yamaha	6L2-W0001-A2-00	520
18-4360	Barr	CM206672JP	587	18-4427	Yamaha	6H3-W0001-A0-00	520
18-4361	Barr	CM-20-6674P	587	18-4428	OMC/Bombardier	437725	305
18-4362	Barr	MC20-60426P	778	18-4429	OMC/Bombardier		305
18-4363	Barr	FM-1-83-P	570, 609, 630, 642, 780, 899	18-4434	Nissan/Tohatsu	3C8-87121-4	458
18-4364	Barr	20-0082-P	570, 588, 609, 618, 630, 642, 781, 899, 970	18-4435	Nissan/Tohatsu	3F3871210M	458
18-4365	Mercury Marine	27-801855	804	18-4436	Nissan/Tohatsu	3B7871218M	458
18-4366	Mercury Marine	27-72479	806	18-4442	Mercury Marine	91-37384	212, 840
18-4366	Mercury Marine	27-72479A5	806	18-4442	Mercury Marine	91-48347	212, 840
18-4366	Mercury Marine	27-72479T	806	18-4442	Mercury Marine	91-57797A1	212, 840
18-4367	Mercury Marine	27-99777A1	802	18-4442	Mercury Marine	91-57797A2	212, 840
18-4369			906	18-4442	Mercury Marine	91-57797A3	212, 840
18-4370			906	18-4442	Mercury Marine	91-8M0067546	212, 840
18-4371			906	18-4444	Mercury Marine	91-38277A1	439, 847
18-43716	Yamaha	93604-18080-00	497	18-4444	Mercury Marine	91-95830	439, 847
18-43717	Yamaha	93604-10M03-00	504, 505	18-4444	Mercury Marine	91-95830A1	439, 847
18-4373			906	18-4454			632, 925
18-4374			906	18-4455			212
18-4375	Mercury Marine	27-34213A1	806	2 18-4456	Mercury Marine	34765A1	106, 856
18-4375	Mercury Marine	27-34213A2	806	2 18-4456	Mercury Marine	34765A2	856
18-4377	Mercury Marine	27-42457A1	806	2 18-4456			568, 579, 601, 632
18-4378	Mercury Marine	27-54529A1	806	2 18-4457	Mercury Marine	12644A1	106, 856
18-4380	Mercury Marine	27-68714	806	2 18-4457	Mercury Marine	12644Q01	856
18-4380	Mercury Marine	27-68714A6	806	2 18-4457			568, 579, 601, 632
18-4380	Mercury Marine	27-68714A7	806	2 18-4458			106, 568, 579.

1 This product is priced per piece. To order, priced per package, please add -9 to the part number

2 Items ending in "D" are display packaged - regular number is non-display

3 For discount shop pack of 10, please add -10 to the part number

SIERRA #	O.E.M.	O.E. #	PAGE #	SIERRA #	O.E.M.	O.E. #	PAGE #	
SIERRA								
2	18-4458		601, 632, 856	18-45713	Jabsco	18653-0001	555	
	18-4459	Mercury Marine	91-821887A1	439, 847	18-45713	Johnson Pump	09-810B	557
	18-4459	Mercury Marine	91-859046Q4	439, 847	18-45714	Yanmar	119574-42550	671
	18-4459	Mercury Marine	91-859046T4	439, 847	18-45714	Yanmar	119574-42552	671
	18-4461	Mercury Marine	22-807155	643, 783	18-4572	Yamaha	6CV-44323-00	504
	18-4461		570, 588, 610, 632, 898, 972	18-4573	Yamaha	6EE-G4323-00	504	
	18-4463	Volvo	833188	976	18-4574	Yamaha	6EG-G4323-00	505
	18-4464	Volvo	829620	976	18-4575		406	
	18-4465	Volvo	3582609	976	18-4576	Yamaha	6FM-44323-01	505
	18-4466	Volvo	838637	976	18-4577	Mercury	8213542	393
	18-4467	Volvo	1542472	976	18-4578	Johnson/Evinrude	324640	285
	18-4468	Volvo	419734	976	18-4579	Johnson/Evinrude	338485	284, 285
	18-4469	Volvo	1542389	976	18-4580		406	
	18-4470	Volvo	419735	976	18-4620	Mercury Marine	743-3193A2	403
	18-4471	Volvo	838638	976	18-4620	Mercury Marine	743-3193A4	403
	18-4472	Volvo	1218630	976	18-4620	Mercury Marine	743-5172A6	403
	18-4473	Volvo	419653	976	18-4620	Mercury Marine	780-9229A7	403
	18-4473	Volvo	3582561	976	18-4621	Mercury Marine	743-3366A1	403
	18-4474	Volvo	419652	976	18-4621	Mercury Marine	743-3366A2	403
	18-4474	Volvo	3582606	976	18-4621	Mercury Marine	780-9229A10	403
	18-4484HP	GM		649	18-4622	Mercury Marine	743-7716A2	403
	18-4485	Mercury Marine	938-883490	649, 790	18-4622	Mercury Marine	780-9229A11	403
	18-4485	Mercury Marine	938-883490R1	649, 790	18-4623	Mercury Marine	777-815965A4	403
	18-4485	Mercury Marine	938-883490R50	649, 790	18-4623	Mercury Marine	777-815965T4	403
	18-4485	Mercury Marine	938-884741R	649, 790	18-4624	Mercury Marine	777-815965A5	403
	18-4485	Mercury Marine	938-884741R50	649, 790	18-4625	Mercury Marine	777-815965A6	403
	18-4485		902, 978	649	18-4626	Mercury Marine	2704-812896A2	403
	18-4485HP	GM		649	18-4626	Mercury Marine	2704-821896A6	403
	18-4486	Mercury Marine	938-803860T	649, 790	18-4626	Mercury Marine	2704-826191A4	403
	18-4486	Mercury Marine	938-883297 1	649, 790	18-4626	Mercury Marine	2704-826191A6	403
	18-4486		902, 978	649, 790	18-4626	Mercury Marine	2704-826191T4	403
	18-4486HP	GM		649, 790	18-4627	Mercury Marine	2704-821896A3	403
	18-4489	Mercury Marine	936-810840	649, 790	18-4628	Mercury Marine	2704-821896A4	403
	18-4489	Mercury Marine	936-986767	649, 790	18-4629	Chrysler Force	700-834794T3	233
	18-4489		902, 978	649, 790	18-4630	Chrysler Force	700-834794A4	233
	18-4491	Mercury Marine	938-827178	649, 790	18-4631	Chrysler Force	700-834794A5	233
	18-4491		902, 978	648, 791	18-4632	Chrysler Force	700-834800A4	233
	18-4492	Mercury Marine	35329	648, 791	18-4633	Chrysler Force	700-834800A5	233
	18-4492	Mercury Marine	F3746241	648, 791	18-4634	Chrysler Force	700-834800A6	233
	18-4492	Mercury Marine	FI1100014	648, 791	18-4635	Mercury Marine	785-9737T9	406
	18-4492	Mercury Marine	FI1100495	648, 791	18-4636	Mercury Marine	785-9738T9	406
	18-4493HP	GM		649	18-4637	Mercury Marine	785-9737A10	406
	18-4497	GM		650	18-4638	Mercury Marine	785-9738T10	406
	18-45003	Chrysler Force	47-F433065	230	18-4639	Mercury Marine	700-858294T1	406
	18-4501		650, 790, 902, 978	230	18-4640	Mercury Marine	700-858295T1	406
	18-4501HP	GM	650, 790, 902, 978	650	18-4641	Mercury Marine	700-878571A2	406
	18-4503		650	648	18-4642	Mercury Marine	700-878572A2	406
	18-4506		648	648	18-4643	Mercury Marine	700-878573A2	406
	18-4507		648	648	18-4644	Mercury Marine	700-878574A2	406
	18-4508		648	648	18-4697		972	
	18-4515	Mercury Marine	774-9137A10	403	18-4698	Mercury Marine	27-81987	425
	18-4516		650	650	18-4698	Mercury Marine	27-81987M	425
	18-4517		650	650	18-4698	Yamaha	90430-08020-00	532, 995
	18-4518		650	650	18-46981-9	Mercury Marine	27-81987M	425
	18-4519		650	650	18-46981-9	Yamaha	90430-08020-00	532, 995
	18-4521		650	650	18-4712		295	
	18-4522		650	650	18-4726		651	
	18-4529	OMC	396644	285	18-4727		651	
	18-45221	OMC	382221	277	18-4728		651	
	18-4523		650	650	18-4729		651	
	18-4527	Yamaha	6FM-W0078-00-00	505	18-4730		651	
	18-4531	Mercury	821354A2	398	18-4731		651	
	18-45312	Mercury	47-95289	393	18-4732		651	
	18-45312	Mercury	47-952892	393	18-4733		651	
	18-45312	OMC	114812	277	18-4734		651	
	18-4532	Yamaha	6EG-W0078-00-00	505	18-4735		651	
	18-4533	Yamaha	65N-W0078-A0-00	505	18-4736		651	
	18-4534	Yamaha	69M-WG078-00-00	505	18-4737		651	
	18-4535	Mercury Marine	774-9137A14	403	18-4749-9	OMC	3852568	914
	18-4535	Mercury Marine	776-8898A2	403	18-4750	OMC	983967	924
	18-4536	Honda	06192-ZV4-A00	245	18-4801	OMC	5000356	914
	18-4537	OMC	5008972	284	18-4804	OMC	986381	914
	18-4539	Johnson/Evinrude	5008967	277	18-4804	OMC	984770	914
	18-45404	Nissan/Tohatsu	353650210M	458	18-4805	OMC	984771	914
	18-4546	Yamaha	6EE-G4322-00	504	18-4805	OMC	986382	914
	18-4547	Yamaha	6EG-G4322-00	505	18-4806	OMC	984765	914
	18-4548	Yamaha	6L2-44322-00	497	18-4806	OMC	986380	914
	18-4549	Johnson/Evinrude	338486	284, 285	18-4807	OMC	439476	337
	18-4551	Johnson/Evinrude	324641	285	18-4826	OMC	331999	328
	18-4560	Mercury Marine	765-7443A12	405	18-4828	OMC	911750	924
	18-4560	Mercury Marine	765-7443A2	405	18-4830	Mercury Marine	1667-9011G59	437
	18-4565	Mercury Marine	766-8667A36	405	18-48317	Mercury	46-803750A03	398
	18-4565	Mercury Marine	766-8667A43	405	18-48317	Nissan/Tohatsu	3B2873222M	458
	18-4567	Yamaha	6EE-G4311-00	504	18-4832	Mercury Marine	1647-9148T93	437
	18-4568	Johnson/Evinrude	5007554	279	18-4833	OMC	915720	890
	18-45617-1	Yamaha	6CE-44352-00-00	496	18-4835	OMC	912029	920
	18-4569	Johnson/Evinrude	339720	279	18-4837	OMC	911734	890
	18-4571	Johnson/Evinrude	360347	279	18-4840	OMC	435277	328
	18-45712	Jabsco	17636-0001	556	18-4841	OMC	435276	328
	18-45712	Jabsco	21676-0001	556	18-4843	OMC	435279	328
	18-45712	Johnson Pump	09814B	557	18-4850	Mercury Marine	1667-9011R6	437

1 This product is priced per piece. To order, priced per package, please add -9 to the part number

2 Items ending in "D" are display packaged - regular number is non-display

3 For discount shop pack of 10, please add -10 to the part number

SIERRA #	O.E.M.	O.E. #	PAGE #	SIERRA #	O.E.M.	O.E. #	PAGE #
SIERRA							
18-4851	Mercury Marine	1647-9148R84	437	18-5133	Tohatsu	3A0060401M	455
18-4858-9	Mercury Marine	12-45176	425	18-5133	Tohatsu	3A0060481M	455
18-48619	Yamaha	68D-WG078-00-00	504	18-5134	Tohatsu	3G2060602M	455
18-4901			212, 316	18-5135	Yamaha	6E5-85540-10-00	474
18-4904			212, 316	18-5135	Yamaha	6E5-85540-11-00	474
18-4911	OMC	322236	212, 316	18-5135	Yamaha	6E5-85540-12-00	474
18-4911	OMC	772577	316	18-5136	Yamaha	6F5-85540-21-00	474
18-4913	OMC	316705	212, 316	18-5136	Yamaha	6F5-85540-22-00	474
18-4913	OMC	772578	316	18-5138	Yamaha	680-85570-00-00	474
18-4914	OMC	316706	212, 316	18-5138	Yamaha	680-85570-02-00	474
18-4914	OMC	772579	36	18-5139	Mercury Marine	336-3948A2	356
18-4915	Mercury Marine	50-12066A1	376	18-5139	Mercury Marine	336-3948A3	356
18-4915	Mercury Marine	50-12066A9	376	18-5139	Mercury Marine	336-4318A2	356
18-4915	Mercury Marine	50-12066Q9	376	18-5139	Mercury Marine	336-4318A3	356
18-4915	Mercury Marine	50-22791A1	376	18-5139	Mercury Marine	336-4318A4	356
18-4915	Mercury Marine	50-28985A2	376	18-5140	Mercury Marine	398-2202	357
18-4915	Mercury Marine	50-45093	376	18-5141	OMC	581207	252
18-50000	Yamaha	689-15755-01-00	481	18-5143	Tohatsu	369060210M	455
18-50000	Yamaha	6G1-15779-00-00	481	18-5144	Suzuki	32900-93911	460
18-50001	Yamaha	6G1-15755-00-00	481	18-5146	Yamaha	62T-85533-00-00	552
18-50001	Yamaha	6G1-15779-00-00	481	18-5147	Yamaha	62T-85520-00-00	552
2 18-5001	OMC	172525	252, 862	18-5147	Yamaha	62T-85520-01-00	552
18-500-1212			88	18-5148	Mercury Marine	394-1100A2	357
18-500-1238			88	18-5148	Mercury Marine	394-1100A3	357
18-500-1414			88	18-5148	Mercury Marine	394-352A1	357
18-500-1418			88	18-5149	Chrysler Force	F12044	221
2 18-5002	OMC	172523	252	18-5149	Chrysler Force	FP2437A	221
2 18-5003	OMC	172806	252	18-5150	Chrysler Force	817764A2	221
18-500-3814			88	18-5150	Chrysler Force	FA305310-2	221
18-500-3818			88	18-5151	Suzuki	33410-92L10	460
18-500-3838			88	18-5151	Suzuki	33410-94400	460
18-500-5614			88	18-5152	Suzuki	32140-93900	460
18-500-5618			88	18-5153	McCulloch	1340135	354
18-500-5838			88	18-5153	McCulloch	36550135	354
2 18-5006	OMC	172522	252	18-5153	McCulloch	75101A	354
18-5007			356	18-5153	Mercury Marine	398-174	357
18-5011	OMC	172521	252	18-5154	Mercury Marine	339-880615T01	358
18-5012			356	18-5156	OMC	580148	252
18-5013			221	18-5157	OMC	580290	252
18-5021	Mercury Marine	805629	780	18-5158	Mercury/Mercruiser	879984A1	358
18-502-1234			88	18-5158	Mercury/Mercruiser	879984T00	358
18-502-1278			88	18-5158	Mercury/Mercruiser	879984T01	358
18-502-1412			88	18-5158	Mercury/Mercruiser	8M0077471	358
18-502-1476			88	18-5159	Mercury/Mercruiser	339-883778A01	358
18-502-3834			88	18-5159	Mercury/Mercruiser	339-883778A02	358
18-502-3858			88	18-5159	Mercury/Mercruiser	339-8M0077473	358
18-502-5612			88	18-5163	OMC	581130	253
18-502-5658			88	18-5165	NISSAN	3G3060211M	455
18-51000	Nissan/Tohatsu	3AA050040M	459	18-5166	Nissan/Tohatsu	3G2-06040-2	455
18-51001	Yamaha	63V-15713-00-00	532	18-5166	Nissan/Tohatsu	3M3060482M	455
18-51002	Yamaha	67D-15713-00-00	532	18-5169	Chrysler Force	F12042-1	221
18-51003	Yamaha	66T-15713-00-00	532	18-5169	Mercury Marine	394-1130	357
18-5102	Chrysler Inboard	3656017	574	18-5169	Mercury Marine	394-1130A1	357
18-5103	Chrysler Inboard	3780600	575	18-5169	Mercury Marine	397-359	357
18-5105	Chrysler Inboard	3874020	575	18-5169	Mercury Marine	397-741	357
18-5107-1	Crusader	7243110	596	18-5170	OMC	583298	253
18-5107-1	Mercury Marine	802464	680	18-5170	OMC	583740	253
18-5107-1	Mercury Marine	804412	680	18-5172	OMC	502881	253
18-5107-1	Mercury Marine	811637	680	18-5172	OMC	581786	253
18-5107-1	Mercury Marine	850487	680	2 18-5176	OMC	582366	253
18-5107-1	Mercury Marine	811637001	680	2 18-5176	OMC	583737	253
18-5107-1	Mercury Marine	811637002	680	2 18-5176	OMC	584561	253
18-5107-1	Mercury Marine	811637T	680	2 18-5179	OMC	582508	253
18-5107-1	OMC	3854003	864	2 18-5181	Mercury Marine	802371A1	358
18-5107-1	Volvo	3854003	941	2 18-5181	OMC	582995	253
18-5108	Mercury Marine	811639	680	2 18-5181	OMC	584477	253
18-5108	Mercury Marine	811639T	680	18-5182	Mercury Marine	823033	358
18-5108	OMC	986642	864	18-5182	Nissan/Tohatsu	3F0-06153-0	455
18-5108	OMC	3854001	864	18-5182	Nissan/Tohatsu	3F0060491M	455
18-5108	Volvo	3854001	941	18-5182	Nissan/Tohatsu	3F0061530M	455
18-5108			596	18-5183	Yamaha	63V-85520-00	473
18-5110	Yamaha	6E5-85570-11-00	473	18-5183	Yamaha	63V-85520-01	473
18-5111	Yamaha	697-85570-11-00	473	2 18-5186	Chrysler Force	339-7370A13	221
18-5112	Yamaha	680-85570-09-00	473	2 18-5186	Chrysler Force	339-7370B13	221
18-5112	Yamaha	695-85570-10-00	473	2 18-5186	Chrysler Force	339-832757B4	221
18-5112	Yamaha	6E7-85570-10-00	473	2 18-5186	Mercury Marine	339-7370A13	221
18-5112	Yamaha	6E7-85570-19-00	473	2 18-5186	Mercury Marine	339-832757A4	221
18-5113	Yamaha	61N-85570-00-00	474	18-5187	Mercury Marine	339-850227	358
18-5113	Yamaha	61N-85570-10-00	474	18-5187	Mercury Marine	339-856991A1	358
18-5116-1	Mercury Marine	87-861780A2	680	18-5192	OMC	502888	253
18-5116-1	Mercury Marine	87-861780Q4	680	18-5192	OMC	581610	253
18-5116-1	Mercury Marine	87-892150A02	680	18-5192	OMC	582091	253
18-5117	GM	10482803	680	18-5193	OMC	580740	253
18-5119	Yamaha	65E-85570-00-00	474	18-5193	OMC	582382	253
18-5128	Yamaha	6R3-85570-01-00	473	18-5194	OMC	502890	253
18-5129	Yamaha	62L-85570-00-00	552	18-5194	OMC	581032	253
18-5130	Yamaha	688-85540-16-00	473	18-5194	OMC	582160	253
18-5131	Yamaha	695-85540-12-00	473	18-5194	OMC	584632	253
18-5132	Yamaha	63V-85540-00-00	473	18-5195	Yamaha	689-81311-40-00	473
18-5132	Yamaha	63V-85540-01-00	473	18-5196	OMC	502880	253
18-5132	Yamaha	63V-85540-02-00	473	18-5196	OMC	581407	253

1 This product is priced per piece. To order, priced per package, please add -9 to the part number

2 Items ending in "D" are display packaged - regular number is non-display

3 For discount shop pack of 10, please add -10 to the part number

SIERRA #	O.E.M.	O.E. #	PAGE #	SIERRA #	O.E.M.	O.E. #	PAGE #
SIERRA							
18-5199	OMC	580321	252	18-5277		560, 591, 620, 677, 863	
18-5200	OMC	580256	252, 863	18-5278	Mercury Marine	850484T3	677
18-5205	OMC	581419	252	18-5278		591, 613, 620, 863, 994	
18-5206	Chrysler/Force	398-176	223	18-5279		591, 613, 863	
18-5206	Mercury Marine	398-693	357	18-5280	Mercury Marine	811635Q2	677
18-5207	Mercury Marine	398-713	357	18-5280		591, 613, 863, 994	
18-52104			200	18-5281	Mercury Marine	808483Q2	677
18-5217-1	Yamaha	67F-82341-00-00	474	18-5281		591, 613, 620, 863	
18-5218-1	Yamaha	67F-82342-00-00	474	18-5282		677	
18-5219-1	Yamaha	67F-82343-00-00	474	18-5283		613, 677, 863	
18-5220-1	Yamaha	67F-82344-00-00	474	18-5284	2	939	
18-52204			200	18-5285		645, 681, 866	
18-52205	Universal		200	18-5286		562, 573, 593, 621, 645,	
18-52206	Universal		200			681, 866, 943	
18-52207	Universal		199	18-5287-1		866	
18-5222			223, 871	18-5288		563, 593, 621, 645,	
1 18-5224	Mercury Marine	20121	363, 696			681, 866, 943	
1 18-5224	Mercury Marine	8M0084600	363, 696	18-5289		563, 593, 621, 645,	
1 18-5224	OMC	510364	259, 871			681, 866, 943	
1 18-5224			223, 240, 455, 460	18-5290		563, 593, 621, 645,	
18-5225	Mercury Marine	84-813706A26	363, 696			681, 866, 943	
18-5225	Mercury Marine	84-90816A26	363, 696	18-5291	Mercury Marine	808483K2	676
18-5225	Mercury Marine	84-93212A1	363, 696	18-5292		943	
18-5225	Mercury Marine	84-93475A26	363, 696	18-5293-1		866	
18-5225	Mercury Marine	84-99215A26	363, 696	18-5294		563, 574, 594, 621,	
18-5225			240, 259, 354, 455,			681, 866, 943	
			460, 475, 871	18-5295		563, 574, 594, 621,	
18-5226	OMC	510883	259			681, 866, 943	
18-5226	OMC	772584	259	2 18-5296-2		563, 594, 621, 681, 867	
18-5226			223, 240, 354, 363, 455,	2 18-5297		681, 867	
			460, 475, 562, 575, 595,	18-5298		563, 594, 622, 681, 867	
			624, 696, 871, 946	2 18-5299		563, 594, 622, 681,	
2 18-5227-1	Mercury Marine	84-813715A1	362			867, 943	
2 18-5228-1	Mercury Marine	84-813715A1	362	18-5300	Mercury Marine	33707	678
2 18-5228-1			171, 223, 362	18-5300		561, 572, 592, 620	
18-5229-9-1			171, 223, 258, 362	18-5301		561, 573, 591, 592, 620,	
2 18-5230-9-1			171, 223, 258, 362			677, 864, 940, 994	
2 18-5231-1	OMC	582365	258	18-5302		561, 573, 591, 592, 620,	
18-5239			167, 170, 943			677, 864, 940, 994	
18-5240			167, 170, 943	18-5303	Chrysler Inboard	2421173	572
18-5241	Chrysler Force	F12181-1	221	18-5303	Chrysler Inboard	2808870	572
18-5241	McCulloch	38850115	254	18-5303	Crusader	41058	591
18-5243	Mercury Marine	888731	678	18-5303	Indmar	751007	613
18-5243	Mercury Marine	898253T23	678	18-5303	Mercury Marine	392-6325	677
18-5244	Mercury Marine	884792	678	18-5303	Mercury Marine	392-898253005	677
18-5244	Mercury Marine	898253T22	678	18-5303	Mercury Marine	8M6001219	677
18-5244	Pleasurecraft	RA108009	621	18-5303	Mercury Marine	FI6900031	677
18-5245	Mercury Marine	884790	678	18-5303	OMC	980893	863
18-5245	Mercury Marine	898253013	678	18-5303	OMC	987136	863
18-5245	Pleasurecraft	R103011	620	18-5303	OMC	987894	863
18-5246	Mercury Marine	898253T28	676	18-5303	Pleasurecraft	R114002	620
18-5247	Mercury Marine	898253T29	676	18-5303	Volvo	835705	939
18-5247	Mercury Marine	8M0060495	676	18-5303	Volvo	855846-2	939
18-5247	Mercury Marine	8M0061335	676	18-5303		560	
18-5248	OMC	3854217	864	18-5305	Volvo	243460	939
18-5248	Volvo	3854217	940	18-5305	Volvo	243799	939
2 18-5250	Mercury Marine	34235Q1	676	18-5305	Volvo	1306169	939
2 18-5250	Mercury Marine	34235T1	676	18-5306	Volvo	240149	939
2 18-5250	OMC	172527	862	18-5307	Chrysler Inboard	1274092	572
2 18-5250			560, 589	18-5307	Chrysler Inboard	2084074	572
2 18-5251	OMC	173619	862	18-5307	Chrysler Inboard	2421178	572
2 18-5251			560, 572, 589, 619, 676	18-5307	Crusader	705788	591
18-5252			560, 589, 676, 862	18-5307		560, 633	
18-5253			676	18-5309-1	Mallory	YL512CV	165, 595, 622
2 18-5254			676	18-5309-1	OMC	980902	869
18-5255			560, 572, 589, 619	18-5309-1	Pleasurecraft	RA107001	622
18-5256	OMC	172531	862	18-5310	Crusader	12525	591
18-5256			560, 589, 939	18-5310	Mercury Marine	33700	677
2 18-5258	OMC	173690	862	18-5310	OMC	380543	863
2 18-5258	OMC	987925	862	18-5310	Volvo	818701-5	939
2 18-5258			560, 572, 590, 676	18-5310		561, 633	
18-5259			560, 572, 590	18-5311	Chris-Craft	16.69-00049	561
2 18-5260	OMC	173829	862	18-5311	Mercury Marine	34235	676
2 18-5260	OMC	987926	862	18-5311	Mercury Marine	34235T	676
2 18-5260			560, 572, 590, 619, 676, 939	18-5311	OMC	380538	863
18-5264			939	18-5311		591, 633	
18-5265			939	18-5312-1	Mallory	YL554CV	165, 622, 684, 869
18-5266			560, 590, 619, 676, 862, 939	18-5312-1	OMC	981080	869
18-5267			676	18-5313-1	Crusader	37061	595
18-5268			560, 613, 633, 676, 862	18-5313-1	Mallory	YL624AV	165, 684
18-5269			560, 590, 676, 862	18-5313-1	Mallory	YL624MW	564, 595, 622, 869
18-5270			590, 676, 862	18-5313-1	Mercury Marine	13447A1	684
18-5271			560, 590, 613, 619, 677, 862	18-5313-1	Mercury Marine	17177A1	684
18-5272			560, 590, 862	18-5313-1	Mercury Marine	68521A3	684
18-5273	Mercury Marine	805759Q3	677	18-5313-1	Mercury Marine	68521A4	684
18-5273	Mercury Marine	805759T3	677	18-5313-1	Mercury Marine	74905A3	684
18-5274			677	18-5313-1	Mercury Marine	816148A1	684
18-5275			560, 590, 613, 619,	18-5313-1	Mercury Marine	91823A3	684
			677, 862	18-5313-1	OMC	985560	869
18-5276			590, 613, 620, 677, 863	18-5314	Chris-Craft	16.69-00039	561
18-5277	Indmar	755021	613	18-5314	Chrysler Inboard	2421820	572

1 This product is priced per piece. To order, priced per package, please add -9 to the part number

2 Items ending in "D" are display packaged - regular number is non-display

3 For discount shop pack of 10, please add -10 to the part number

SIERRA #	O.E.M.	O.E. #	PAGE #	SIERRA #	O.E.M.	O.E. #	PAGE #
SIERRA							
18-5314	Crusader	20117	591	18-5352	Volvo	841070	940
18-5314	Mercury Marine	391-5090	677	18-5352	Volvo	3853815	940
18-5314	Mercury Marine	391-898253004	677	18-5352			561
18-5314	Mercury Marine	8M6001250	677	18-5353	Crusader	41069	592
18-5314	OMC	382135	863	18-5353	Mercury Marine	392-9086	678
18-5314	Pleasurecraft	R114001	620	18-5353	Mercury Marine	392-9086T	678
18-5314	Pleasurecraft	R114004	620	18-5353	OMC	984398	864
18-5314	Volvo	835304	939	18-5353	Volvo	841926	940
18-5315-1	Mallory	YL673AV	165, 684, 869	18-5354	Crusader	38070	592
18-5315-1	Mercury Marine	33266	684	18-5354	Mercury Marine	804418	678
18-5315-1	Mercury Marine	52352	684	18-5354	Mercury Marine	808483	678
18-5315-1	Mercury Marine	58231	684	18-5354	Mercury Marine	804483T	678
18-5315-1	Mercury Marine	62424	684	18-5354	Mercury Marine	808483T3	678
18-5315-1	Mercury Marine	87581	684	18-5354	OMC	3854548	864
18-5315-1	Mercury Marine	195141	684	18-5354	Volvo	3854548	940
18-5315-1	Mercury Marine	87581T	684	18-5354			633
18-5316-1	Mallory	YL624BV	165, 685, 869	18-5356	Volvo	243797	940
18-5317	Mercury Marine	64850	677	18-5357	Volvo	243632	940
18-5317	Mercury Marine	87-71831	677	18-5357	Volvo	870690	940
18-5317			620	18-5357	Volvo	1243632	940
18-5318	Crusader	3000124	591	18-5358	Volvo	841263	940
18-5318	Mercury Marine	58033	677	18-5359			561, 621, 633
18-5318	Mercury Marine	898253007	677	18-5361	Mercury Marine	811635	678
18-5319	Volvo	243801	939	18-5361	Mercury Marine	811635T3	678
18-5338	Chris-Craft	16.69-00040	561	18-5361	OMC	986643	864
18-5338	Crusader	12530	591	18-5361			592
18-5338	Mercury Marine	391-5092	678	18-5362	Mercury Marine	850484	677
18-5338	Mercury Marine	391-5092	678	18-5362	Mercury Marine	850484T	677
18-5338	Mercury Marine	391-5093	678	18-5362	Mercury Marine	850484T2	677
18-5338	Mercury Marine	391-898253001	678	18-5362	OMC	3854331	864
18-5338	Mercury Marine	8M6001217	678	18-5362	Volvo	3854331	940
18-5338	Mercury Marine	F16900040	678	18-5362			592
18-5338	OMC	382136	863	18-5369	Chrysler Inboard	4142408	572
18-5338	Pleasurecraft	R115001	620	18-5369	Crusader	41052	592
18-5338	Volvo	835308	939	18-5369	Mercury Marine	392-6318	679
18-5338			572	18-5369	Mercury Marine	392-6318T	679
18-5339-1	Mallory	9-26103	685, 869	18-5369	Mercury Marine	F16900184	679
18-5339-1	Mallory	YL566AV	165, 685, 869	18-5369	OMC	982336	864
18-5342	Volvo	243653	939	18-5369	Pleasurecraft	RA108002	621
18-5344	Crusader	12526	591	18-5369	Volvo	835702	940
18-5344	Mercury Marine	33706	678	18-5369			561
18-5344	OMC	382125	863	18-5375	Chris-Craft	16.69-00100	561
18-5344			561	18-5375	Chris-Craft	F16900165	561
18-5345	Chris-Craft	16.69-00050	561	18-5375	Crusader	12532	593
18-5345	Chrysler Inboard	2098058	572	18-5375	Crusader	1003317	593
18-5345	Chrysler Inboard	2279949	572	18-5375	OMC	382133	864
18-5345	Crusader	41057	591	18-5375	Volvo	841244	940
18-5345	Crusader	705787	591	18-5376	Chris-Craft	16.69-00148	561
18-5345	Indmar	755017	613	18-5376	Crusader	20222	593
18-5345	Mercury Marine	6325	678	18-5376	Mercury Marine	391-5075	679
18-5345	Mercury Marine	33662	678	18-5376	Mercury Marine	391-5075Q1	679
18-5345	Mercury Marine	898253003	678	18-5376	Mercury Marine	F16900148	679
18-5345	Mercury Marine	898253005	678	18-5376	OMC	982209	864
18-5345	Mercury Marine	33662Q	678	18-5376	Pleasurecraft	R108001	621
18-5345	Mercury Marine	8M6001218	678	18-5376			572
18-5345	Mercury Marine	F16900031	678	18-5384	Crusader	12528	593
18-5345	OMC	380537	863	18-5384	Mercury Marine	33708	679
18-5345	Pleasurecraft	R115002	620	18-5384	OMC	383587	864
18-5345	Volvo	835704	939	18-5385	Chris-Craft	16.69-00052	561
18-5345			633	18-5385	Mercury Marine	33667	679
18-5346	Chris-Craft	1869704	561	18-5385	Mercury Marine	393-9459	679
18-5346	Mercury Marine	58034	678	18-5385	Mercury Marine	393-9459Q1	679
18-5346	Mercury Marine	81-64851	678	18-5385	Mercury Marine	393-9459T	679
18-5346			620	18-5385	Mercury Marine	F16900052	679
18-5347	Chrysler Inboard	1818757	572	18-5385	OMC	380541	864
18-5347	Chrysler Inboard	3420600	572	18-5385			633
18-5347	Mercury Marine	392-6324	678	18-5386	Mercury Marine	33765	679
18-5347	Mercury Marine	392-898253002	678	18-5386	Mercury Marine	33765T	679
18-5347	Mercury Marine	8M6001249	678	18-5386	OMC	980152	864
18-5347	Mercury Marine	F16900023	678	18-5386			561, 593
18-5347	Mercury Marine	F16900032	678	18-5389	Crusader	3000121	593
18-5347	Mercury Marine	F16900083	678	18-5389	Mercury Marine	393-3230	679
18-5347	Mercury Marine	F16900189	678	18-5389	Mercury Marine	393-4988	679
18-5347	OMC	980894	863	18-5389	Mercury Marine	393-4988T	679
18-5347	OMC	987895	863	18-5389	Mercury Marine	393-4988T2	679
18-5347			561, 591, 620, 633	18-5389			621
18-5348	Volvo	834560	939	18-5393	Volvo	241669	940
18-5349	Volvo	841262	939	18-5394	Volvo	243658	940
18-5350	Mercury Marine	888751A02	683	18-5395	Mercury Marine	43557	679
18-5350	Mercury Marine	888751A03	683	18-5395	Mercury Marine	16457A4	679
18-5350	Mercury Marine	888751A1	683	18-5395	Mercury Marine	43557A1	679
18-5351	Mercury Marine	884794A02	683	18-5395	Mercury Marine	805759A1	679
18-5351	Mercury Marine	884794A1	683	18-5395	Mercury Marine	805759A2	679
18-5352	Chrysler Inboard	4142817	572	18-5395	Mercury Marine	805759A5	679
18-5352	Crusader	41076	592	18-5395	Mercury Marine	805759T	679
18-5352	Mercury Marine	392-9766	678	18-5395	Mercury Marine	805759T1	679
18-5352	Mercury Marine	392-9766Q1	678	18-5395	Mercury Marine	90746A1	679
18-5352	Mercury Marine	392-9766T	678	18-5396	Mercury Marine	13753A2	679
18-5352	Mercury Marine	F16900185	678	18-5396	Mercury Marine	815407A2	679
18-5352	OMC	984401	864	18-5397	Mallory	9-29418	679, 864
18-5352	Pleasurecraft	RA108003	621	18-5397	OMC	985218	864

1 This product is priced per piece. To order, priced per package, please add -9 to the part number

2 Items ending in "D" are display packaged - regular number is non-display

3 For discount shop pack of 10, please add -10 to the part number

SIERRA #	O.E.M.	O.E. #	PAGE #	SIERRA #	O.E.M.	O.E. #	PAGE #		
SIERRA									
1	18-5399	Crusader	41061	574	2	18-5432	Mercury Marine	19405A4	678
1	18-5399	Mercury Marine	392-6329	679	2	18-5432	Mercury Marine	90576A4	678
1	18-5399	OMC	910169	907		18-5433	Chrysler Inboard	201522	574
	18-5402	Mercury Marine	898253009	678		18-5433	Chrysler Inboard	2495531	574
	18-5403	Crusader	41074	591		18-5433	Crusader	37068	596
	18-5403	Crusader	41089	591		18-5433	Crusader	51080	596
	18-5403	Mercury Marine	392-9089	678		18-5433	Delco	1115202	680
	18-5403	Mercury Marine	392-9089Q	678		18-5433	Mercury Marine	38547	358, 680
	18-5403	Mercury Marine	392-9089T	678		18-5433	Mercury Marine	32193A2	358, 680
	18-5403	Mercury Marine	392-9767	678		18-5433	Mercury Marine	392-806529A1	358, 680
	18-5403	Mercury Marine	FI6900186	678		18-5433	Mercury Marine	898253T24	358, 680
	18-5403	Mercury Marine	FI6900190	678		18-5433	OMC	915735	865
	18-5403	OMC	982880	863		18-5433	Pleasurecraft	R117001	625
	18-5403	Pleasurecraft	R103004	620		18-5433	Volvo	835998	941
	18-5403	Volvo	841907	939		18-5433			564, 615, 634
	18-5403	Volvo	855845	939		18-5435	Chrysler Inboard	200691	574
	18-5403	Volvo	3853801	939		18-5435	Crusader	41080	596
	18-5404-1	Chris-Craft	16.69-00149	561		18-5435			564, 625
	18-5404-1	Chrysler Inboard	868096	572		18-5436	Volvo	35254	941
	18-5404-1	Crusader	20223	592		18-5436			596, 625
	18-5404-1	Mercury Marine	391-5088	678		18-5437	OMC	378231	865
	18-5404-1	Mercury Marine	391-7057	678		18-5437	OMC	383444	865
	18-5404-1	Mercury Marine	391-7057T	678		18-5438	Crusader	37068	596
	18-5404-1	Mercury Marine	391-898253029	678		18-5438	Mercury Marine	392-7803A4	680
	18-5404-1	Mercury Marine	8M6001224	678		18-5438	Mercury Marine	392-805570A2	680
	18-5404-1	Mercury Marine	FI6901224	678		18-5442	Mercury Marine	806673T	680
	18-5404-1	OMC	982211	863		18-5442	Mercury Marine	806673T1	680
	18-5404-1	Pleasurecraft	R103001	620		18-5443	Crusader	7243200	596
	18-5404-1			939		18-5443	Mercury Marine	817378	680
	18-5405	Crusader	38071	592		18-5443	Mercury Marine	817378T	680
	18-5405	Mercury Marine	808484	678		18-5443	Mercury Marine	898253T27	680
	18-5405	Mercury Marine	898253010	678		18-5443	OMC	3854002	865
	18-5405	Mercury Marine	808484 1	678		18-5443	Volvo	3854002	941
	18-5405	OMC	3854549	863		18-5450	Chrysler Inboard	4106140	574
	18-5405	Volvo	3854549	940		18-5450	Pleasurecraft	R119001	625
	18-5405	Volvo	3862014	940		18-5450			564, 596, 615
	18-5406	Mercury Marine	811636	678		18-5451	Chrysler Inboard	3874767	574
	18-5406	Mercury Marine	898253011	678		18-5464			564, 596, 625
	18-5406	Mercury Marine	811636 1	678		18-5465	Mercuriser	392-863704T	625
	18-5406	OMC	986651	863		18-5465	Mercuriser	8M0054588	625
	18-5406	Volvo	3854261	940		18-5466			564, 596, 624, 644, 679, 865, 941
	18-5406			592					
	18-5407	Chrysler Inboard	1658535	572		18-5467	Volvo	21436799	941
	18-5407	Crusader	41059	592		18-5469			564, 574, 596, 624, 644, 679, 865, 941
	18-5407	Mercury Marine	392-6326	678					
	18-5407	Mercury Marine	392-6326T	678		18-5470	Mercury Marine	805185A37	683
	18-5407	Mercury Marine	FI6900044	678		18-5471	Mercury Marine	805185A36	683
	18-5407	OMC	980892	863		18-5472			564, 574, 596, 624, 644, 679, 865, 941
	18-5407	Pleasurecraft	R103003	620					572, 592, 621, 646, 679, 864, 940
	18-5407			561, 613		18-5473			572, 593, 620, 646, 679, 864, 941
	18-5408	Mercury Marine	804424	678					
	18-5408	Mercury Marine	850485	678		18-5474			
	18-5408	Mercury Marine	8504851	678					
	18-5408	Mercury Marine	898253012	678		18-5475	Mercury Marine	817377	683
	18-5408	Mercury Marine	8M0062084	678		18-5475	Mercury Marine	817377T	683
	18-5408	OMC	3854311	863		18-5475			163, 869, 942
	18-5408	Volvo	3854311	940		18-5476	Mercury Marine	807964A1	683
	18-5408			592		18-5476	Mercury Marine	907964A1	683
	18-5411	Chris-Craft	16.69-00042	561		18-5476			163, 868, 942
	18-5411	Crusader	12531	592		18-5477			162, 622, 645, 682, 867, 942
	18-5411	Crusader	1003318	592					
	18-5411	OMC	982342	864		18-5478			162, 622, 645, 682, 868, 943
	18-5411	Volvo	841243	940					
	18-5413	OMC	987986	864		18-5479			162, 622, 645, 682, 868, 943
	18-5413	Volvo	3854218	940					
	18-5418	Chris-Craft	16.69-00051	561		18-5480			564, 596, 614, 623, 645, 682, 867, 942
	18-5418	Mercury Marine	58217	678					162, 622, 645, 682, 867
	18-5418	Mercury Marine	898253008	678		18-5481			162, 622, 645, 682, 867
	18-5418	Mercury Marine	58217Q	678		18-5482			162, 622, 645, 682, 867
	18-5418	OMC	384735	864		18-5483			162, 563, 595, 622, 646, 682, 867, 942
	18-5418			592, 633					
	18-5419	OMC	380542	864		18-5484-1	Mercury Marine	805222A1	683
	18-5419	Volvo	818525	940		18-5484-1			163, 596, 623, 869, 942
	18-5419			561, 633		18-5486-2	Mallory	YLM673AV	164, 868
	18-5420	Crusader	3000122	592		18-5486-2	Mallory	YLM673AV	164, 868
	18-5420	Mercury Marine	65864	678		18-5487-2	Mallory	YLM676AV	164, 684, 868
	18-5420	Mercury Marine	78016	678		18-5488			680
	18-5425	Volvo	834975	940		18-5489-2	Mallory	YLM554CV	164, 868
	18-5427	Chris-Craft	16.69-0022	561		18-5489-2			623, 684
	18-5427	Crusader	705786	592		18-5493			564, 575, 596, 615, 625, 680, 864, 946
	18-5427			633					
	18-5428	Volvo	243903	940		18-5494-2			564, 595, 623, 684
	18-5429	Chrysler Inboard	2098611	572		18-5495-2	Mallory	YLM512CV	164, 868, 942
	18-5429			561, 592		18-5495-2			595, 684
	18-5430	Chrysler Inboard	868095	572		18-5496-2	Mallory	YLM567CV	164, 684, 868
	18-5430			634		18-5496-2			623
2	18-5431	Mercury Marine	13524A5	678		18-5497-2	Mercury Marine	YLM579AV	164, 684
2	18-5431	Mercury Marine	13524T1	678		18-5497-2			573
2	18-5432	Mercury Marine	13524A4	678		18-5498-2	Mallory	YLM624BV	164, 685, 869, 942
2	18-5432	Mercury Marine	13524A6	678		18-5512			163, 685
2	18-5432	Mercury Marine	13524Q06	678		18-5513			163, 685

1 This product is priced per piece. To order, priced per package, please add -9 to the part number

2 Items ending in "D" are display packaged - regular number is non-display

3 For discount shop pack of 10, please add -10 to the part number

SIERRA #	O.E.M.	O.E. #	PAGE #	SIERRA #	O.E.M.	O.E. #	PAGE #
SIERRA							
18-5514			163, 685	18-5621	Mercury Marine	50-822462T1	374
18-5515			165	18-5621	Mercury Marine	50-893890T	374
18-5516			165	18-5622	Chrysler Force	50-820193	224
18-5517			165	18-5622	Chrysler Force	50-820193T1	224
18-5518			164, 685	18-5624	OMC	583482	265
18-5519			164, 685	18-5624	OMC	585056	265
18-5520			164, 685	18-5624	OMC	586279	265
18-55500	Yanmar	728170-92600	671	18-5627	OMC	583473	265
18-55501	Yanmar	18-55501	671	18-5627	OMC	585059	265
18-55502	Yanmar	728271-92605	671	18-5627	OMC	585459	265
18-55503	Yanmar	728374-92605	671	18-5628	OMC	393570	265
18-55600	Yanmar	128170-01331	671	18-5628	OMC	585060	265
18-55601	Yanmar	128171-01911	671	18-5628	OMC	586285	265
18-55602	Yanmar	128271-01911	671	18-5628	OMC	778994	265
18-55603	Yanmar	128374-01911	672	18-5629	OMC	386591	265
18-56000	Yanmar	128170-11310	671	18-5629	OMC	392133	265
18-56001			456	18-5629	OMC	585061	265
18-56002	Nissan/Tohatsu	3C8750140M	456	18-5630	OMC	384163	265
18-56002	Yamaha	689-81840-11-00	456	18-5630	OMC	384163	265
18-56004	Yamaha	663-81840-11-00	481	18-5630	OMC	387684	265
18-56005	Yamaha	6E5-81840-10-00	481	18-5630	OMC	387684	265
18-56006	Yamaha	6N7-81840-00-00	481	18-5630	OMC	389275	265
18-56007	Yamaha	61A-81840-00-00	481	18-5630	OMC	389275	265
18-56008	Suzuki	31173-95310	461	18-5630	OMC	585063	265
18-56009	Suzuki	31173-99E00	461	18-5631	OMC	584818	265
18-5601	Mercury Marine	50-38890A1	373	18-5631	OMC	586277	265
18-5601	Mercury Marine	50-55601	373	18-5631	OMC	778996	265
18-5601	Mercury Marine	50-55601A2	373	18-5632	OMC	584980	265
18-5602	Mercury Marine	50-44369A1	373	18-5632	OMC	586284	265
18-5602	Mercury Marine	50-58788A3	373	18-5634	OMC	385529	265
18-5602	Mercury Marine	50-67341	373	18-5634	OMC	389954	265
18-5602	Mercury Marine	50-893891T	373	18-5634	OMC	585051	265
18-5603	Indmar	573001	615	18-5634	OMC	585057	265
18-5603	Marine Power	0170-000	618	18-5636	Mercury Marine	50-57465A1	374
18-5603	Mercury Marine	50-808011A4	696	18-5636	Mercury Marine	50-57867	374
18-5603	Pleasurecraft	RA122009	625	18-5636	Mercury Marine	50-58788A3	374
18-5605	Mercury Marine	50-73521	373	18-5636	Mercury Marine	50-64975	374
18-5605	Mercury Marine	50-73521T	373	18-5636	Mercury Marine	50-72467	374
18-5605	Mercury Marine	50-898265005	373	18-5640	OMC	387094	264
18-5606	Mercury Marine	50-44369	373	18-5640	OMC	395207	264
18-5606	Mercury Marine	50-44369A1	373	18-5640	OMC	585062	264
18-5606	Mercury Marine	50-60315	373	18-5640	OMC	586288	264
18-5608	Mercury Marine	50-44414	373	18-5640	OMC	778992	264
18-5608	Mercury Marine	50-44414	373	18-5642	Mercury Marine	50-44369A1	373
18-5608	Mercury Marine	50-44415	373	18-5642	Mercury Marine	50-66015	373
18-5608	Mercury Marine	50-44415	373	18-5642	Mercury Marine	50-66015T1	373
18-5608	Mercury Marine	50-77141	373	18-5642	Mercury Marine	50-893891T	373
18-5608	Mercury Marine	50-77141	373	18-5648	OMC	384777	265
18-5608	Mercury Marine	50-79472	373	18-5648	OMC	386657	265
18-5608	Mercury Marine	50-79472	373	18-5648	OMC	391735	265
18-5608	Mercury Marine	50-79472 1	373	18-5648	OMC	585050	265
18-5608	Mercury Marine	50-79472 1	373	18-5648	OMC	585058	265
18-5610	Mercury Marine	50-660151	374	18-5648	OMC	586281	265
18-5610	Mercury Marine	50-660153	374	18-56481			651
18-5610	Mercury Marine	50-66015T	374	18-5650	Mercury Marine	57380	375
18-5610	Mercury Marine	50-893892T	374	18-5655	Chrysler Force	F15150	225
18-5611	Mercury Marine	50-8M0033984	374	18-5655	OMC	321648	266
18-5611	Mercury Marine	50-90983A1	374	18-5656	Mercury Marine	68575	375
18-5611	Mercury Marine	50-90983T1	374	18-5657	Volvo	855798	946
18-5612	OMC	432925	265	18-5658	Mercury Marine	86177	375
18-5612	OMC	586286	265	18-5658	Mercury Marine	86177 1	375
18-5612	OMC	586287	265	18-56601	Yanmar	104211-49160	671
18-5613	Chrysler Force	F438955-1	224	18-56602	Yanmar	128170-42090	671
18-5613	Chrysler Force	F480955	224	18-5671	OMC	384781	266
18-5613	Chrysler Force	F490955	224	18-5673	Chrysler Force	819222	224
18-5613	Chrysler Force	F616955	224	18-5673	Chrysler Force	F15100	224
18-5613	Chrysler Force	F85955-1	224	18-5673	Chrysler Force	F15110	224
18-5613	Chrysler Force	FA85955	224	18-5674	Mercury Marine	75661	375
18-5613	Chrysler Force	FK616955	224	18-5674	Mercury Marine	13310T1	375
18-5613	Chrysler Force	FS438955	224	18-5674	OMC	387683	266
18-5613	Chrysler Force	FS438955	224	18-5677	Chrysler Force	811902	225
18-5613	Chrysler Force	FS480955	224	18-5678	OMC	585269	266
18-5613	Chrysler Force	FS489955	224	18-5679	OMC	585267	266
18-5613	Chrysler Force	FS490955	224	18-56870	Mercury	59341A1	650
18-5617	OMC	586274	265	18-5697	Chrysler Force	75384	224
18-5617	OMC	778995	265	18-5697	Chrysler Force	F15164	224
18-5618	Chrysler Force	50-819968	224	18-5697	Mercury Marine	75384	375
18-5618	Chrysler Force	50-8199681	224	18-5697	OMC	385952	266
18-5618	Chrysler Force	50-819968-2	224	18-5700	Volvo	3858081	955
18-5618	Chrysler Force	50-8199683	224	18-5700	Volvo	3858809	955
18-5618	Chrysler Force	50-8199684	224	18-5701	Johnson/Evinrude	355169	284
18-5618	Chrysler Force	50-898265003	224	18-5703	Johnson/Evinrude	355209	284
18-5619	OMC	391511	265	18-5704	Volvo	876037	955
18-5619	OMC	396235	265	2 18-5705	OMC	582472	261, 878
18-5619	OMC	397023	265	2 18-5705	OMC	584416	261, 878
18-5619	OMC	584799	265	2 18-5705	OMC	586224	261, 878
18-5619	OMC	586731	265	2 18-5705	Volvo	876039	955
18-5620	Mercury Marine	50-818445-2	374	18-5707	Mercury Marine	816770	368
18-5620	Mercury Marine	50-818445-3	374	18-5707	Mercury Marine	62351A1	368
18-5620	Mercury Marine	50-8184455	374	18-5707	Mercury Marine	62351A2	368
18-5621	Mercury Marine	50-822462	374	18-5707	Mercury Marine	816770T	368

1 This product is priced per piece. To order, priced per package, please add -9 to the part number

2 Items ending in "D" are display packaged - regular number is non-display

3 For discount shop pack of 10, please add -10 to the part number

SIERRA #	O.E.M.	O.E. #	PAGE #	SIERRA #	O.E.M.	O.E. #	PAGE #
SIERRA							
18-5708	OMC	582399	263	18-5774-1	OMC	585145	256
18-5708	OMC	583408	263	18-5774-1	OMC	763803	256
18-5709	OMC	581778	263	18-5775	Chrysler Force	332-7778A12	221
18-5710	Chrysler Inboard	2098300	576	18-5775	Mercury Marine	332-552A1	358
18-5710	Chrysler Inboard	2847527	576	18-5775	Mercury Marine	332-7778A1	358
18-5710	Prestolite	VSH-6201JY	565, 576, 598	18-5775	Mercury Marine	332-7778A12	358
18-5711	OMC	383440	877	18-5775	Mercury Marine	332-7778A3	358
18-5711	Prestolite	VSH-6201 AFY	877	18-5775	Mercury Marine	332-7778A6	358
18-5717	Crusader	42001	597	18-5775	Mercury Marine	332-7778A7	358
18-5717	Crusader	707125	597	18-5775	Mercury Marine	332-7778A9	358
18-5717	Mercury Marine	33270	700	18-5775	Mercury Marine	F749301	358
18-5717	OMC	1984462	875	18-5775	Mercury Marine	F7778A9	358
18-5717			565	18-5776	Mercury Marine	339-7452A1	358
18-5723	Chrysler Inboard	2095946	577	18-5776	Mercury Marine	339-7452A2	358
18-5724	Mer cruiser	78385	704	18-5776	Mercury Marine	339-7452A3	358
18-5727	Pleasurecraft	R098002	Obsolete	18-5777	Mercury Marine	339-7452A15	358
18-5727	Prestolite	VSH-6201ADY	Obsolete	18-5777	Mercury Marine	339-7452A19	358
18-5729	Mercury Marine	87-18211	369	18-5777	Mercury Marine	339-7452A7	358
18-5731	Suzuki	38860-76F01	462	18-5777	Mercury Marine	339-7452A9	358
18-5732	Mercury	893640T01	368	18-5778	Mercury Marine	339-7452A11	358
18-5737	Mercury Marine	87-19761	369	18-5778	Mercury Marine	339-7452A14	358
18-5740	Mercury Marine	42785	704	18-5778	Mercury Marine	339-7452A21	358
18-5741	Mercury Marine	815279-1	368	18-5778	Mercury Marine	339-7452A8	358
18-5741	Mercury Marine	815279A2	368	18-5780	OMC	585189	256
18-5742	Chrysler Force	817411	224	18-5781	OMC	584636	S/S to 18-5781-1
18-5742	Chrysler Force	8152792	224	18-5781	OMC	585114	S/S to 18-5781-1
18-5742	Chrysler Force	815279T2	224	18-5781	OMC	586212	S/S to 18-5781-1
18-5742	Chrysler Force	815279T3	224	18-5781	OMC	586661	S/S to 18-5781-1
18-5742	Chrysler Force	830179A2	224	18-5781-1	OMC	584636	256
18-5742	Chrysler Force	F718470	224	18-5781-1	OMC	585114	256
18-5742	Chrysler Force	F746470	224	18-5781-1	OMC	586212	256
18-5743	Mercury Marine	815279-3	368	18-5781-1	OMC	586661	256
18-5743	Mercury Marine	815279-5	368	18-5782	OMC	582705	256
18-5743	Mercury Marine	883072T	368	18-5782	OMC	763793	256
18-5744	Chrysler Force	8152794	224	18-57824	Ilmor	MV8V1021	183
18-5744	Chrysler Force	8174111	224	18-5783	OMC	582811	256
18-5744	Chrysler Force	815279T4	224	18-5783	OMC	763794	256
18-5744	Chrysler Force	815279T5	224	18-5784	OMC	583110	S/S to 18-5784-1
18-5744	Chrysler Force	830179A1	224	18-5784-1	OMC	583110	256
18-5744	Chrysler Force	854514A1	224	18-5785	OMC	585261	256
18-5744	Chrysler Force	856747T1	224	18-5787	Mercury Marine	332-4911A5	358
18-5744	Chrysler Force	883071A1	224	18-5787	Mercury Marine	332-4911A8	358
18-5745	Volvo	3287677	941	18-5788	Mercury Marine	339-6222A8	359
18-5746	Yamaha	6H3-85510-A1	477	18-5790	Chrysler Force	18495A26	221
1 18-5750	OMC	580339	259, 475, 562, 576, 595, 624, 871	18-5790	Mercury Marine	18495A12	359
1 18-5750	OMC	581027	259, 475, 562, 576, 595, 624, 871	18-5790	Mercury Marine	18495A19	359
1 18-5750			223, 240, 363, 455, 460, 475, 696	18-5791	Mercury Marine	19052A3	359
18-5752			223, 240, 259, 363, 455, 460, 475, 562, 576, 595, 624, 696, 871, 946	18-5791	Mercury Marine	19052A5	359
18-5753	OMC	385391	255	18-5791	Mercury Marine	19052A8	359
18-5753	OMC	581311	255	18-5792	Mercury Marine	16061T	359
18-5753	OMC	581731	255	18-5793	Mercury Marine	823034	359
18-5754	OMC	581726	255	18-5793	Mercury Marine	823034T	359
18-5755	OMC	581397	255	18-5794	OMC	583896	256
18-5755	OMC	764708	255	18-5794	OMC	584329	256
18-5756	OMC	582056	255	18-5794	OMC	584331	256
18-5757	OMC	581713	255	18-5794	OMC	584489	256
18-5757	OMC	582057	255	18-5796	Mercury Marine	96455A15	366
18-5758	OMC	582452	255	18-5797	Mercury Marine	68162A3	366
18-5758	OMC	582453	255	18-5797	Mercury Marine	68162A6	366
18-5758	OMC	583380	255	18-5797	Mercury Marine	96455A1	366
18-5759	OMC	581805	255	18-5797	Mercury Marine	96455A8	366
18-5759	OMC	582125	255	18-5798	Mercury Marine	68162A1	366
18-5760	OMC	582138	255	18-5798	Mercury Marine	68162A5	366
18-5760	OMC	582400	255	18-5798	Mercury Marine	68162A8	366
18-5760	OMC	582556	255	18-5798	Mercury Marine	96455A6	366
18-5760	OMC	582642	255	18-5798	Mercury Marine	96455A9	366
18-5761	OMC	583114	255	2 18-5801	Mercury Marine	89-76416A1	700
18-5763	OMC	582285	255	2 18-5801	OMC	586730	261, 875
18-5763	OMC	583170	255	2 18-5801	OMC	586842	261, 875
18-5764	OMC	582261	255	2 18-5801	OMC	985064	261, 875
18-5764	OMC	586696	255	2 18-5801	Pleasurecraft	R130001	626
18-5766	OMC	583748	255	2 18-5802	Mercury Marine	54981	368, 700
18-5767	OMC	584783	256	2 18-5802	Mercury Marine	65057	368, 700
18-5768	OMC	584908	256	2 18-5802	Mercury Marine	65057A1	368, 700
18-5768	OMC	5001344	256	2 18-5802	Mercury Marine	65057T1	368, 700
18-5770	OMC	584028	S/S to 18-5770-1	18-5803	Chrysler Force	F177917	221
18-5770-1	OMC	584028	256	18-5803	OMC	979774	875
18-57703	Volvo	876069	183, 977	18-5804	Mercury Marine	13037	700
18-57704	Yanmar	128270-12540	670	18-5804			634
18-57704	Yanmar	128171-12540	671	18-5806	Bosch	0331-302-050	954
18-5771	OMC	584032	256	18-5806	Bosch	0331-302-081	954
18-5772	OMC	584041	S/S to 18-5772-1	18-5806	Bosch	0331-302-085	954
18-5772-1	OMC	584041	256	18-5806	Bosch	0331-302-581	954
18-5773	OMC	584642	256	18-5806	Bosch	0331-302-585	954
18-5774	OMC	585145	S/S to 18-5774-1	18-5806	Volvo	834520	954
18-5774	OMC	763803	S/S to 18-5774-1	18-5807	OMC	378444	261, 875
				18-5807	Prestolite	SAW4206	261, 875
				2 18-5808	Mercury Marine	47886	368
				2 18-5808	Mercury Marine	47886T	368
				2 18-5808	OMC	395419	261, 875

1 This product is priced per piece. To order, priced per package, please add -9 to the part number

2 Items ending in "D" are display packaged - regular number is non-display

3 For discount shop pack of 10, please add -10 to the part number

SIERRA #	O.E.M.	O.E. #	PAGE #	SIERRA #	O.E.M.	O.E. #	PAGE #
SIERRA							
2	18-5808	OMC	582708	261, 875	18-5851	Mercury	865202T 369
2	18-5810			368, 701	18-5852	Mercury Marine	821509 369
	18-5811	Mercury Marine	809462	368, 701	18-5852	Mercury Marine	853292 369
	18-5811	Mercury Marine	809463	368, 701	18-5852	Mercury Marine	821509T1 369
	18-5811	Mercury Marine	8094621	368, 701	18-5853	Yamaha	61A-81941-00-00 477
	18-5811	Mercury Marine	8094631	368, 701	18-5853	Yamaha	6E5-81941-10-00 477
	18-5811	Mercury Marine	809463A1	368, 701	18-5853	Yamaha	6E5-81941-11-00 477
	18-5811	OMC	3850216	875	18-5854	Mercury Marine	398-5454A17 366
	18-5811	Volvo	3850216	954	18-5855	Mercury Marine	336-3996A7 366
	18-5811	Volvo	3859054	954	18-5856	Mercury Marine	398-5255 366
2	18-5812	OMC	985063	875	18-5857	Mercury Marine	398-5454A7 366
	18-5813	OMC	584128	261	18-5859	Mercury Marine	398-5454A22 366
2	18-5814	OMC	172869	261, 875	18-5859	Mercury Marine	398-5919A3 366
2	18-5814	OMC	581528	261, 875	18-5859	Mercury Marine	398-5919A7 366
2	18-5815	Mercury Marine	89-15857	368, 701	18-5860	Mercury Marine	398-5454A35 366
2	18-5815	Mercury Marine	89-61053	368, 701	18-5864	Mercury Marine	86617A20 366
2	18-5815	Mercury Marine	89-65258	368, 701	18-5865	Mercury Marine	398-5704A7 366
2	18-5815	Mercury Marine	89-68258A4	368, 701	18-5866	Mercury Marine	398-5919A4 366
2	18-5815	Mercury Marine	89-76545	368, 701	18-5866	Mercury Marine	76314A3 366
2	18-5815	Mercury Marine	89-76545T	368, 701	18-5867	Mercury Marine	398-9873A4 365
2	18-5815	Mercury Marine	89-853654A1	368, 701	18-5870	Chrysler Force	398-832075A4 221
2	18-5816	Mercury Marine	89-91975	368, 701	18-5870	Mercury Marine	398-832075-A21 365
2	18-5816	Mercury Marine	89-96054	368, 701	18-5870	Mercury Marine	398-832075A4 365
2	18-5816	Mercury Marine	89-96054T	368, 701	18-5871	Mercury Marine	398-5454A32 365
2	18-5817	Mercury Marine	94318	368, 701	18-5872	Mercury Marine	398-6231A10
2	18-5817	Mercury Marine	846070	368, 701	18-5872	Mercury Marine	6231A4
2	18-5817	Mercury Marine	89-96158	368, 701	18-5872	Mercury Marine	6231A5
2	18-5817	Mercury Marine	89-96158T	368, 701	18-5872	Mercury Marine	6231A6
	18-5818	Mercury Marine	89-818864	368	18-5873	Chrysler Force	398-832075A6 221
	18-5818	Mercury Marine	89-818864T	368	18-5873	Mercury Marine	398-832075A6 365
	18-5819	Mercury Marine	89-818997A1	368	18-5874	Mercury Marine	398-5454A21 365
	18-5819	Mercury Marine	89-818997A2	368	18-5874	Mercury Marine	398-5454A25 365
	18-5819	Mercury Marine	89-818997T1	368	18-5874	Mercury Marine	398-5454A63 365
	18-5819	Yamaha	65W-81941-00-00	477	18-5874	Mercury Marine	398-5919A2 365
	18-5820	Mercury Marine	89-818999A2	368, 701	18-5874	Mercury Marine	398-5919A6 365
	18-5820	Mercury Marine	89-825842A1	368, 701	18-5874	Mercury Marine	398-5919A8 365
	18-5820	Mercury Marine	89-850188T1	368, 701	18-5874	Mercury Marine	398-818535A15 365
	18-5821	Mercury Marine	825096T01	368	18-5874	Mercury Marine	398-832075A14 365
	18-5821	Mercury Marine	89-825096T	368	18-5874	Mercury Marine	398-832075A20 365
	18-5821	Yamaha	6G1-81941-10-00	477	18-5876	Mercury Marine	398-9610A19 365
2	18-5822	Mercury Marine	54293A10	368	18-5877	OMC	584643 260
2	18-5822	Mercury Marine	54293A13	368	18-5878	OMC	584981 260
2	18-5822	Mercury Marine	54293A4	368	18-5879	Yamaha	688-81941-00-00 477
2	18-5823	OMC	584580	261	18-5879	Yamaha	688-81950-10-00 477
	18-5825	OMC	395204	263	18-5881	Chrysler Force	332-5772A5 221
	18-5826	OMC	584890	263	18-5881	Chrysler Force	332-5772A7 221
	18-5827	OMC	584476	263	18-5881	Mercury Marine	332-5772A1 359
	18-5827	OMC	585001	263	18-5881	Mercury Marine	332-5772A2 359
	18-5828	OMC	439561	263	18-5881	Mercury Marine	332-5772A3 359
	18-5828	OMC	585219	263	18-5881	Mercury Marine	332-5772A5 359
	18-5829	OMC	586048	263	18-5881	Mercury Marine	F720301 359
	18-5830	OMC	586075	263	18-5882	Volvo	3884950 952
	18-5831	OMC	584641	263	18-5883	OMC	584488 256
	18-5831	OMC	585995	263	18-5884	OMC	586343 257
	18-5831	OMC	586271	263	18-5885	OMC	583865 257
	18-5832	OMC	583266	263	18-5886	OMC	436367 257
	18-5832	OMC	583689	263	18-5886	OMC	584122 257
	18-5832	OMC	584424	263	18-5887	OMC	584985 257
	18-5832	OMC	586000	263	18-5888	OMC	987738 865
2	18-5833	OMC	586774	261	18-5889	OMC	987739 865
	18-5834	Chrysler Force	89-817109A2	221	18-5890	OMC	987740 865
	18-5834	Mercury Marine	89-817109A2	369	18-5890	OMC	985902 865
	18-5835	Chrysler Force	89-803822T	221	18-5891	OMC	583605 257
	18-5835	Chrysler Force	89-817109A3	221	18-5893	OMC	583476 257
	18-5835	Chrysler Force	89-F460917-1	221	18-5893	OMC	584037 257
	18-5835	Chrysler Force	F460917-1	221	18-5893	OMC	586217 257
2	18-5836	Mercury Marine	25661	369, 701	18-5893	OMC	586667 257
2	18-5836	Mercury Marine	256611	369, 701	18-5894	OMC	3852215 19, 887, 962
2	18-5836	Mercury Marine	25661T1	369, 701	18-5894	Volvo Penta	3852215 19, 887, 962
	18-5837	Mercury Marine	89-18080	700	18-5896	Mercury Marine	12415 391
	18-5838	Delco	1114356	875	18-5896		
	18-5838	Delco	1114458	875	18-5897	Mercury Marine	36525 751
	18-5838	Mercury Marine	33261	700	18-5897	Mercury Marine	97257 751
	18-5838	Mercury Marine	33316	700	18-5897	Mercury Marine	806490 751
	18-5838	Mercury Marine	60687	700	18-5897	Mercury Marine	811091 751
	18-5838	Mercury Marine	89902	700	18-5897	Mercury Marine	806490T 751
	18-5838	Mercury Marine	89-99253	700	18-5897	Mercury Marine	97257A1 751
	18-5838			565, 597	18-5897	OMC	980613 891
	18-5840	Prestolite	15-79	565, 576, 597, 700	18-5897	Volvo	3853787 962
	18-5840	Prestolite	SAW4201	565, 576, 597, 700	18-5897		
	18-5840	Prestolite	SAW4207	565, 576, 597, 700	18-5898	Crusader	700427 601
	18-5840	Prestolite	SAW4210	565, 576, 597, 700	18-5898	Mercury Marine	34625 751
	18-5840			57, 634	18-5898	Mercury Marine	97258 751
	18-5841	Chrysler Inboard	1692658	576	18-5898	Mercury Marine	97258A1 751
	18-5849	Mercury Marine	828151	369	18-5898	Mercury Marine	F16900152 751
	18-5849	Mercury Marine	828151A1	369	18-5898	Mercury Marine	F16900198 751
	18-5849	Mercury Marine	882751A1	369	18-5898	OMC	171960 891
	18-5849	Mercury Marine	882751A2	369	18-5898		
	18-5850	Mercury Marine	882751A04	369	18-5899	Crusader	700425 601
	18-5851	Mercury	807057	369	18-5899	Mercury Marine	34623 751
	18-5851	Mercury	807057T	369	18-5899	Mercury Marine	90806 751

1 This product is priced per piece. To order, priced per package, please add -9 to the part number

2 Items ending in "D" are display packaged - regular number is non-display

3 For discount shop pack of 10, please add -10 to the part number

SIERRA #	O.E.M.	O.E. #	PAGE #	SIERRA #	O.E.M.	O.E. #	PAGE #
SIERRA							
18-5899	Mercury Marine	815425	751	18-5943	Valeo	A13N259	953
18-5899	Mercury Marine	815425T	751	18-5943	Volvo	872926	953
18-5899	Mercury Marine	8M0068784	751	18-5943	Volvo	3803227	953
18-5899	Mercury Marine	90806A1	751	18-5945			702
18-5899	OMC	982650	891	18-5946			702
18-5899	Pleasurecraft	RO20001	628	18-5949			704
18-5899	Volvo	3857532	962	18-5953-1			704
18-5899			19	18-5954	Chrysler Inboard	3527501	577
18-5903	Mercury Marine	50-12872	699	18-5954	Chrysler Inboard	3527502	577
18-5903	Mercury Marine	50-56886	699	18-5954	Chrysler Inboard	3744870	577
18-5903	Mercury Marine	50-69865A1	699	18-5956	Mercury Marine	56045	703
18-5903	OMC	980803	874	18-5956	Mercury Marine	59755	703
18-5903	OMC	981821	874	18-5956	Mercury Marine	69729	703
18-5903	Pleasurecraft	RA122001	626	18-5956	Mercury Marine	78477	703
18-5903	Volvo	841066-4	951	18-5956	Mercury Marine	90794	703
18-5906	Volvo	840808	951	18-5956	Mercury Marine	78403A1	703
18-5906	Volvo	872241	951	18-5956	Mercury Marine	78403A2	703
18-5907	Crusader	42090	597	18-5957	Mercury Marine	12449	703
18-5907	Mercury Marine	50-72550A2	697	18-5957	Mercury Marine	56045	703
18-5907	Mercury Marine	50-79604A3	697	18-5957	Mercury Marine	59755	703
18-5907	Mercury Marine	50-97499A2	697	18-5957	Mercury Marine	69729	703
18-5907	Mercury Marine	50-97499R4	697	18-5957	Mercury Marine	78477	703
18-5907	OMC	981289	873	18-5957	Mercury Marine	90794	703
18-5907	OMC	982202	873	18-5957	Mercury Marine	92497	703
18-5907	Pleasurecraft	RA122008	625	18-5957	Mercury Marine	12449A1	703
18-5908	Crusader	42091	597	18-5957	Mercury Marine	78403A1	703
18-5908	Mercury Marine	50-17251A2	698	18-5957	Mercury Marine	78403A2	703
18-5908	Mercury Marine	50-17251A3	698	18-5957	Mercury Marine	817119A1	703
18-5908	Mercury Marine	50-47455	698	18-5957	Mercury Marine	817119A4	703
18-5908	Mercury Marine	50-65784A1	698	18-5957	Mercury Marine	92497A3	703
18-5908	Mercury Marine	50-76965A3	698	18-5957	Mercury Marine	98555A1	703
18-5908	Mercury Marine	50-76967A1	698	18-5957	OMC	982364	877
18-5908	Mercury Marine	50-76967A4	698	18-5957	Pleasurecraft	RA097002	626
18-5908	Mercury Marine	50-808011A05	698	18-5957	Pleasurecraft	RA097003	626
18-5908	Mercury Marine	50-808011A1	698	18-5957	Pleasurecraft	RA097006	626
18-5908	Mercury Marine	50-808011A3	698	18-5957	Volvo	3860769	952
18-5908	Mercury Marine	50-808011A4	698	18-5959	Valeo	A13N147M	952
18-5908	Mercury Marine	50-99419A3	698	18-5959	Valeo	A13N148M	952
18-5908	OMC	981288	874	18-5959	Valeo	A13N1M	952
18-5908	OMC	982195	874	18-5959	Valeo	A13N2M	952
18-5908	OMC	984982	874	18-5959	Volvo	826495	952
18-5908	OMC	986007	874	18-5959	Volvo	834609	952
18-5908	Pleasurecraft	RA122009	625	18-5959	Volvo	834963	952
18-5910	Mercury Marine	50-12177A2	698	18-5959	Volvo	841762	952
18-5910	Mercury Marine	50-99418A2	698	18-5959	Volvo	841765	952
18-5910	OMC	984456	874	18-5959	Volvo	841766	952
18-5910	OMC	986505	874	18-5960	Mercury Marine	807653T	703
18-5911	Chris-Craft	16.61-00042	565	18-5961			568, 588, 598, 628
18-5911	Mercury Marine	50-17251A3	697	18-5962			568, 588, 598, 628
18-5911	Mercury Marine	50-76965A4	697	18-59640	Prestolite		994
18-5911	Mercury Marine	50-77328A3	697	18-5965	Mercury Marine	12449	703
18-5911	Mercury Marine	50-99417A2	697	18-5965	Mercury Marine	92497	703
18-5911	Mercury Marine	50-99419A3	697	18-5965	Mercury Marine	12449A1	703
18-5911	OMC	981078	873	18-5965	Mercury Marine	805884T	703
18-5911	OMC	982121	873	18-5965	Mercury Marine	817119A1	703
18-5911	OMC	983444	873	18-5965	Mercury Marine	817119A4	703
18-5911	OMC	983790	873	18-5965	Mercury Marine	92497A3	703
18-5911	OMC	985966	873	18-5965	Mercury Marine	98555A1	703
18-5911	Volvo	834893	951	18-5966	Mercury Marine	12449	703
18-5911	Volvo	855326	951	18-5966	Mercury Marine	92497	703
18-5913	Mercury Marine	50-812428A3	697	18-5966	Mercury Marine	12449A1	703
18-5913	Mercury Marine	50-812604A2	697	18-5966	Mercury Marine	12449A1	703
18-5913	Mercury Marine	50-822330A2	697	18-5966	Mercury Marine	817119A1	703
18-5913	Mercury Marine	50-864340A2	697	18-5966	Mercury Marine	817119A4	703
18-5913	OMC	3854751	874	18-5966	Mercury Marine	98555A1	703
18-5913	Volvo	3587625	951	18-5967	Mercury Marine	807652T	703
18-5913	Volvo	3853982	951	18-5968			704
18-5913	Volvo	3854751	951	18-59700	Volvo	841380	952
18-5913	Volvo	3856004	951	18-59700	Volvo	841762	952
18-5913	Volvo	3860764	951	18-59700	Volvo	841763	952
18-5913	Volvo	3885317	951	18-59700	Volvo	841765	952
18-5917	OMC	984628	874	18-59700	Volvo	841766	952
18-5919	Mercury Marine	50-806963A4	698	18-59700	Volvo	3803227	952
18-5919	Mercury Marine	50-806965A2	698	18-59700	Volvo	3803227-2	952
18-5919	Mercury Marine	50-806965A4	698	18-59700	Volvo	834625-6	952
18-5919	OMC	988217	873	18-59700	Volvo	841378-3	952
18-5919	Volvo	3856003	951	18-59710	Volvo	820652	952
18-5920	OMC	987811	873	18-59710	Volvo	822454	952
18-5920	OMC	3854190	873	18-59710	Volvo	827303	952
18-5920	Pleasurecraft	RA122001	626	18-59710	Volvo	847651	952
18-5920	Pleasurecraft	RK122014	626	18-59710	Volvo	849561	952
18-5920	Volvo	3854190	951	18-59710	Volvo	849602	952
18-5923			697, 873, 951	18-5975	Motorola	510-845	661
18-5927			873, 951	18-5975	Motorola	510-860	661
18-5929	Mercury Marine	892940T	372	18-5975	Motorola	510-864	661
18-5939	Valeo	2541451	953	18-5975	Motorola	9AR3855G	661
18-5939	Valeo	A13N234	953	18-5975	Motorola	9AR6000G	661
18-5939	Volvo	872235	953	18-5975	Motorola	9AR3959G	661
18-5939	Volvo	873770	953	18-5975	Perkins Marine Engine	2871A651	661
18-5939	Volvo	3803260	953	18-5975	Valeo	2939590	661
18-5943	Valeo	541663	953	18-5976	Motorola	9AR3743G	953

1 This product is priced per piece. To order, priced per package, please add -9 to the part number

2 Items ending in "D" are display packaged - regular number is non-display

3 For discount shop pack of 10, please add -10 to the part number

SIERRA #	O.E.M.	O.E. #	PAGE #	SIERRA #	O.E.M.	O.E. #	PAGE #
SIERRA							
18-5976	Motorola	510-821	953	18-6016	Mercury Marine	76214A5	440, 853
18-5976	Motorola	510-802	953	18-6016	Mercury Marine	786214A2	440, 853
18-5976	Motorola	510-835	953	18-6016	Mercury Marine	97-762145	440, 853
18-5976	Motorola	510-836	953	18-6016	Mercury Marine	97-76214Q5	440, 853
18-5976	Motorola	510-856	953	1 18-60161	Mercury Marine	76214	440, 853
18-5976	Motorola	510-861	953	1 18-60161	Mercury Marine	76214Q5	440, 853
18-5976	Motorola	510-862	953	1 18-60161	Mercury Marine	76214T3	440, 853
18-5976	Valeo	2937430	953	18-6016A	Mercury Marine	76214	440, 853
18-5978	Mercury Marine	47487T	704	18-6016A	Mercury Marine	76214Q5	440, 853
18-5979	Volvo	3860082	952	18-6016A	Mercury Marine	76214T3	440, 853
18-5982	Cummins	216040	661	18-6017	OMC	123009	343
18-5982	Cummins	3604234RX	661	18-6017	OMC	173029	343
18-5983	Mercury Marine	862030T	703	18-6017A	OMC	123009	343
18-5984	Indmar	575011	615	18-6017A	OMC	173029	343
18-5984	Pleasurecraft	RA097007B	626	18-6018	OMC	327606	343
18-6000	Volvo	832598	991	18-6019	OMC	982277	926
18-6000	Volvo	873179	991	18-6019	OMC	982438	926
18-6000A	Volvo	832598	991	18-6020	OMC	976669	343, 926
18-6000A	Volvo	873179	991	18-6021	Volvo	838928	992
18-6001	Volvo	838929	991	18-6024	OMC	393023	343, 926
18-600-1212			88	18-6024	OMC	436745	343, 926
18-600-1414			88	18-6024A	OMC	393023	343, 926
18-600-1418			88	18-6024A	OMC	436745	343, 926
18-600-3814			88	18-6025	OMC	398331	343, 927
18-600-3818			88	18-6025	OMC	433458	343, 927
18-600-3838			88	18-6026	OMC	392462	343
18-6004	Volvo	852835	991	18-6027	OMC	392123	343, 927
18-6004	Volvo	873178	991	18-6028	OMC	984513	927
18-6004A	Volvo	852835	991	18-6028	OMC	3853818	927
18-6004A	Volvo	873178	991	18-6028	OMC	3855412	927
18-6005	Volvo	875805	991	18-6028	Volvo	984513	991
18-600-5614			Obsolete	18-6028	Volvo	3855411	991
18-600-5618			88	18-6028A	OMC	984513	927
18-6009	Volvo	875815	991	18-6028A	OMC	3853818	927
18-6009A	Volvo	875815	991	18-6028A	OMC	3855412	927
18-6010	Volvo	875821	991	18-6028A	Volvo	3863193	991
18-60103	Nissan/Tohatsu	332600060M	459	18-6029	OMC	397768	927
18-60103-50			459	18-6032	Suzuki	55320-95310	470
18-6010A	Volvo	875821	991	18-6033	Suzuki	55125-87D00	470
18-6011	Honda	41107-ZW1-003ZA	250	18-6034	Yamaha	6K1-45371-00-00	533
18-6011	Mercury Marine	31640	440	18-6035	Yamaha	6J9-45371-01-00	533
18-6011	Mercury Marine	316403	440	18-6040			559
18-6011	Mercury Marine	316404	440	18-6041-1			559
18-6011	Mercury Marine	31640A1	440	18-6043-1			559
18-6011	Mercury Marine	31640A2	440	18-6045			559
18-6011	Mercury Marine	31640A4	440	18-6046			559
18-6011	Mercury Marine	31640T6	440	18-6047			559
18-6011	Mercury Marine	72436A1	440	18-6050			559
18-6011	Mercury Marine	97-31640B4	440	18-60508	Yamaha	60V-12414-A0-00	527
18-6011	Mercury Marine	97-31640Q4	440	18-60512	Yamaha	68D-E1169-A0-00	531
18-6011A	Honda	41107-ZW1-003ZA	250	18-60513	Yamaha	66M-11357-00-00	532
18-6011A	Mercury Marine	31640	440	18-60518	Yamaha	68D-11351-A0-00	531
18-6011A	Mercury Marine	31640A1	440	18-60519	Yamaha	68D-E1193-A0-00	531
18-6011A	Mercury Marine	31640Q4	440	18-6052			559
18-6011A	Mercury Marine	31640T6	440	18-60520	Yamaha	66T-11193-A0-00	531
18-6012	Mercury Marine	34127	853	18-60521	Yamaha	69M-11196-A0-00	531
18-6012	Mercury Marine	34127A1	853	18-60522	Yamaha	66T-11181-A0-00	531
18-6012	Mercury Marine	34127A2	853	18-60523	Yamaha	69M-11181-00-00	531
18-6012	Mercury Marine	34127T1	853	18-60527	Yamaha	67D-45113-A0-00	531
18-6012	Mercury Marine	34127T2	853	18-60528	Yamaha	66T-45113-A0-00	531
18-6013	Mercury Marine	32170	853	18-60529	Yamaha	66T-41133-A0-00	531
18-6013	Mercury Marine	32170A1	853	18-6053			559
18-6013	Mercury Marine	34762A1	853	18-60530	Yamaha	66M-41114-01-00	531
18-6013	Mercury Marine	97-34672C	853	18-60531	Yamaha	65W-41114-01-00	531
18-601-3814			88	18-60532	Yamaha	66T-41114-A0-00	531
18-6014	Mercury Marine	822777	440, 853	18-60534	Yamaha	66M-13645-00-00	531
18-6014	Mercury Marine	8227772	440, 853	18-60535	Yamaha	65W-13645-00-00	531
18-6014	Mercury Marine	46399A2	440, 853	18-60540	Yamaha	676-12414-A0-00	531
18-6014	Mercury Marine	46399A1	440, 853	18-60541	Yamaha	6BX-G4315-01-00	531
18-6014	Mercury Marine	822777A1	440, 853	18-6059			559
18-6014	Mercury Marine	822777A3	440, 853	18-6060			559
18-6014	Mercury Marine	822777A4	440, 853	18-6062			559
18-6014	Mercury Marine	822777Q1	440, 853	18-6063			559
18-6014A	Mercury Marine	46399A1	440, 853	18-6066	Mercury Marine	43994A2	853
18-6014A	Mercury Marine	822777A1	440, 853	18-6066	Mercury Marine	821631A1	853
18-6014A	Mercury Marine	822777Q1	440, 853	18-6066	Mercury Marine	821631B1	853
18-60151-9	Mercury Marine	55989	853	18-6066	Mercury Marine	821631C	853
18-60151-9	Mercury Marine	55989A3	853	18-6066	Mercury Marine	821631Q1	853
18-60151-9	Mercury Marine	55989A4	853	18-6066A	Mercury Marine	43994A2	853
18-60151-9	Mercury Marine	55989A9	853	18-6066A	Mercury Marine	821631Q1	853
18-60151-9	Mercury Marine	55989Q9	853	18-6067	Mercury Marine	806189A1	854
18-60151-9	Mercury Marine	55989T9	853	18-6067	Mercury Marine	97-806189	854
1 18-6015-9	Mercury Marine	55989A3	853	18-6067	Mercury Marine	97-806189Q1	854
1 18-6015-9	Mercury Marine	55989Q9	853	18-6067A	Mercury Marine	806189A1	854
1 18-6015-9	Mercury Marine	55989T9	853	18-6067A	Mercury Marine	97-806189	854
18-6015A-9	Mercury Marine	55989A3	853	18-6067A	Mercury Marine	97-806189Q1	854
18-6015A-9	Mercury Marine	55989Q9	853	18-6068	Honda	41109-ZW1-003	249
18-6015A-9	Mercury Marine	55989T9	853	18-6068	Mercury Marine	826134	440, 854
18-6016	Mercury Marine	76214	440, 853	18-6068	Mercury Marine	826134A1	440, 854
18-6016	Mercury Marine	762142	440, 853	18-6068	Mercury Marine	97-826134Q	440, 854
18-6016	Mercury Marine	762142A1	440, 853	18-6070	Yamaha	688-45371-02-00	533

1 This product is priced per piece. To order, priced per package, please add -9 to the part number

2 Items ending in "D" are display packaged - regular number is non-display

3 For discount shop pack of 10, please add -10 to the part number

SIERRA #	O.E.M.	O.E. #	PAGE #	SIERRA #	O.E.M.	O.E. #	PAGE #
SIERRA							
18-6079	Mercury Marine	806105	854	18-6117Z	Mercury Marine	97-806188Q01	853
18-6079	Mercury Marine	806105A1	854	18-6118A	Yamaha	68V-11325-01-00	533
18-6079	Mercury Marine	806105Q1	854	18-6119A	Yamaha	61A-45371-00-00	533
18-6079	Mercury Marine	806105T1	854	18-6119Z	Yamaha	61A-45371-00-00	533
18-6080	Mercury Marine	815933A1	854	18-6120A	Yamaha	61N-45251-01-00	533
18-6080	Mercury Marine	821629A1	854	18-6120Z	Yamaha	61N-45251-01-00	533
18-6080	Mercury Marine	97-821629Q1	854	18-6121A	Yamaha	6K1-45371-02-00	533
18-6080A	Mercury Marine	821629	854	18-6121Z	Yamaha	6K1-45371-02-00	533
18-6080A	Mercury Marine	821629A1	854	18-6122A	Yamaha	69L-45371-00-00	533
18-6080A	Mercury Marine	821629Q1	854	18-6122Z	Yamaha	69L-45371-00-00	533
18-6089	Mercury Marine	806190A1	854	18-6123Z	Volvo	873395	991
18-6089	Mercury Marine	806190T1	854	18-6124Z	Volvo	872793	991
18-6089	Mercury Marine	97-806190	854	18-6125A	Volvo	3586461	991
18-6089	Mercury Marine	97-806190B4	854	18-6125M	Volvo	3855610	991
18-6089	Mercury Marine	97-806190Q1	854	18-6125Z	Volvo	3854130	991
18-6090	Yamaha	6G5-45251-01-00	533	18-6126A	Volvo	3888816	991
18-6091	Yamaha	6H1-45251-02-00	533	18-6126M	Volvo	3888818	991
18-60915	Mercury	27-835383001	Obsolete	18-6126Z	Volvo	3888817	991
18-60915	Nissan/Tohatsu	3V1020110M	Obsolete	18-6127A	Volvo	3888813	991
18-60916	Mercury	27-850836001	417	18-6127M	Volvo	3888815	991
18-60916	Nissan/Tohatsu	3V1010050M	459	18-6127Z	Volvo	3888814	991
18-60917	Mercury	27-803508017	422	18-6128A	Volvo		992
18-60917	Nissan/Tohatsu	3V1010240M	459	18-6128M	Volvo		992
18-60918	Mercury	27-835427003	423	18-6128Z	Volvo		992
18-60918	Nissan/Tohatsu	3V1013030M	459	18-6129A	Volvo		992
18-60919	Mercury	27-834952001	423	18-6129M	Volvo		992
18-60919	Nissan/Tohatsu	3V1023050M	459	18-6129Z	Volvo		992
18-6092	Mercury Marine	806190	854	18-6130	Volvo		992
18-6092	Mercury Marine	806190A1	854	18-6131	Volvo		992
18-6092	Mercury Marine	806190Q1	854	18-61319	Mercury	27-827154	810
18-6092	Mercury Marine	806190T1	854	18-6132A	Yamaha		533
18-60920	Mercury	27-853702005	423	18-6132M	Yamaha		533
18-60920	Nissan/Tohatsu	346-01032-0	459	18-6133A	Yamaha		533
18-6092A	Mercury Marine	806190	854	18-6133M	Yamaha		533
18-6092A	Mercury Marine	806190A1	854	18-6134			559
18-6092A	Mercury Marine	806190Q1	854	18-6135			559
18-6092A	Mercury Marine	806190T1	854	18-6136			559
18-6093	Mercury Marine	806105	854	18-6137			559
18-6093	Mercury Marine	806105A1	854	18-6140	Universal	301068	559
18-6093	Mercury Marine	806105Q1	854	18-6141	Universal	301069	559
18-6093	Mercury Marine	806105T1	854	18-6150A	Mercury Marine	888756A2	854
18-6093A	Mercury Marine	806105	854	18-6150A	Mercury Marine	888756Q02	854
18-6093A	Mercury Marine	806105A1	854	18-6150A	Mercury Marine	888756Q4	854
18-6093A	Mercury Marine	806105Q1	854	18-6150M	Mercury Marine	888756A2	854
18-6093A	Mercury Marine	806105T1	854	18-6150M	Mercury Marine	888756Q02	854
18-6094	Mercury Marine	817373A1	854	18-6150M	Mercury Marine	888756Q4	854
18-6094	Mercury Marine	821630A1	854	18-6150Z	Mercury Marine	888756A2	854
18-6094	Mercury Marine	821630C2	854	18-6150Z	Mercury Marine	888756Q02	854
18-6094	Mercury Marine	97-821630Q1	854	18-6150Z	Mercury Marine	888756Q4	854
18-6094A	Mercury Marine	821630	854	18-61513	Mercury	27-142471	806
18-6094A	Mercury Marine	821630A1	854	18-61513	Mercury	27-142471T1	806
18-6094A	Mercury Marine	821630Q1	854	18-6154A			853
18-6094A	Mercury Marine	821630T1	854	18-6154M			853
18-6095	OMC	431708	343, 927	18-6154Z			853
18-6095A	OMC	431708	343, 927	18-6155Z			927
18-6096	Yamaha	664-45371-01-00	533	18-6156A			440
18-6097	Yamaha	6E5-45371-01-00	533	18-6156M			440
18-6098	Suzuki	55125-96310	470	18-6157A	Mercury Marine	8M0058677	440
18-6099	Mercury Marine	815933A1	854	18-6157M			440
18-6099	Mercury Marine	821629A1	854	18-6158A	Mercury Marine	888756Q01	853
18-6099	Mercury Marine	97-821629Q1	854	18-6158A	Mercury Marine	97-888756Q03	853
18-6100	OMC	123009	343	18-6158M	Mercury Marine	888755A1	853
18-6100	OMC	173029	343	18-6158M	Mercury Marine	888755Q01	853
18-6101	OMC	983494	927	18-6158M	Mercury Marine	97-888755Q03	853
18-6102	OMC	984513	927	18-6158Z			853
18-6102	OMC	3853818	927	18-6159A	Mercury Marine	888758A1	853
18-6102	OMC	3855412	927	18-6159A	Mercury Marine	888758Q01	853
18-6102	Volvo	3855412	991	18-6159A	Mercury Marine	97-888758Q03	853
18-6103	OMC	984547	927	18-6159M	Mercury Marine	888757Q01	853
18-6103A	OMC	984547	927	18-6159M	Mercury Marine	888759A1	853
18-6104	Volvo	832598	991	18-6159M	Mercury Marine	97-888759Q03	853
18-6104	Volvo	873179	991	18-6159Z			853
18-6105	Volvo	852835	991	18-6160A	Mercury Marine	888761A1	853
18-6105	Volvo	873178	991	18-6160A	Mercury Marine	888761Q01	853
18-61051			166, 680	18-6160A	Mercury Marine	97-888761Q03	853
18-6106	Volvo	875821	991	18-6160M	Mercury Marine	888760A1	853
18-6107			559	18-6160M	Mercury Marine	888760Q01	853
18-6108			559	18-6160M	Mercury Marine	97-888760Q03	853
18-6109			559	18-6160Z			853
18-6111	Yamaha	688-45371-02-00	533	18-6161A	Suzuki		470
18-6112	Yamaha	6J9-45371-01-00	533	18-6161M	Suzuki		470
18-6114	Mercury Marine	806189	854	18-6162A	Yamaha		533
18-6114	Mercury Marine	806189A1	854	18-6162M	Yamaha		533
18-6114	Mercury Marine	806189Q1	854	18-6163A	Honda		250
18-6114	Mercury Marine	806189T1	854	18-6163M	Honda		250
18-6115	OMC	433580	343	18-6165A	Honda	41107-ZV5-00-00	250
18-6117A	Mercury Marine	97-806188A1	853	18-6200	Yanmar	27210-200200	672
18-6117A	Mercury Marine	97-806188Q01	853	18-6201	Yanmar	27210-200300	672
18-6117M	Mercury Marine	97-806188A1	853	18-6240	Mercury Marine	821630	854
18-6117M	Mercury Marine	97-806188Q01	853	18-6240	Mercury Marine	821630A1	854
18-6117Z	Mercury Marine	97-806188A1	853	18-6240	Mercury Marine	821630Q1	854

1 This product is priced per piece. To order, priced per package, please add -9 to the part number

2 Items ending in "D" are display packaged - regular number is non-display

3 For discount shop pack of 10, please add -10 to the part number

SIERRA #	O.E.M.	O.E. #	PAGE #	SIERRA #	O.E.M.	O.E. #	PAGE #
SIERRA							
18-6240	Mercury Marine	821630T1	854	18-6283	Mercury Marine	50-8331535	373
18-6241	Honda	41107-ZW1-003ZA	250	18-6284			634
18-6241	Mercury Marine	31640	440, 853	18-6285	OMC	433226	260
18-6241	Mercury Marine	31640A1	440, 853	18-6286	Chrysler Force	827675A1	224
18-6241	Mercury Marine	31640Q4	440, 853	18-6287			Obsolete
18-6241	Mercury Marine	31640T6	440, 853	18-6288	Indmar	575010	615
18-6242-9	Mercury Marine	55989A3	853	18-6288	Pleasurecraft	RA097007B	626
18-6242-9	Mercury Marine	55989Q9	853	18-6291	OMC	3854194	875
18-6242-9	Mercury Marine	55989T9	853	18-6291	Volvo	3854194-2	875
18-6243	Mercury Marine	43994A2	853	18-6293	Mercury Marine	862031T	703
18-6243	Mercury Marine	821631Q1	853	18-6293	Mercury Marine	862031T1	703
18-6244	Mercury Marine	76214	440, 853	18-6298	Mercury Marine	863077T	703
18-6244	Mercury Marine	76214Q5	440, 853	18-6299	Marine Power	402001	618
18-6244	Mercury Marine	76214T3	440, 853	18-6350	Mercury Marine	43-821823A1	829
2 18-6245	Mercury Marine	10-32470	441	18-6350	Mercury Marine	43-853640A2	829
18-6246	Yamaha	90105-10M00-00	533	18-6350K	Mercury Marine	43-803104T1	828
18-6249	Mercury Marine	43396A2	441	18-6351	Mercury Marine	43-853641A2	829
18-6249	Mercury Marine	818298A1	441	18-6351K	Mercury Marine	43-803103T1	828
18-6249	Mercury Marine	818298Q1	441	18-6352	Mercury Marine	43-853642A2	829
18-6249A	Mercury Marine	43396A2	441	18-6352K	Mercury Marine	43-803106T1	828
18-6249A	Mercury Marine	818298A1	441	18-6353	Mercury Marine	43-853643A2	829
18-6249A	Mercury Marine	818298Q1	441	18-6353K	Mercury Marine	43-803105T1	828
18-6250			266, 375	18-63966	Yamaha	66M-11181-10-00	531
18-6251			266, 375	18-63968	Yamaha	65W-11181-30-00	531
18-6252			260	18-6399	OMC	984264	915
18-6253			702	18-6400	Mercury Marine	12784	830
18-6254	Mercury Marine	392-2940	702	18-6400	Mercury Marine	12784T	830
18-6255	Mercury Marine	392-8989	702	18-6401	Mercury Marine	12784A10	830
18-6256	Mercury Marine	392-2529	702	18-6401	Mercury Marine	12784A4	830
18-6257	OMC	982957	878	18-6404	Mercury Marine	865503T	830
18-6257	OMC	983195	878	18-6406	Mercury Marine	865493A01	831
18-6258	Honda	36120-ZV5-821	241	18-6406	Mercury Marine	865496A01	831
18-6259	Yamaha	6H1-43880-00-00	481	18-6406	Mercury Marine	865496A01	831
18-6260			877	18-6406	Mercury Marine	865510T	831
18-6261	OMC	987774	877	18-6406	Mercury Marine	865511T	831
18-6261	OMC	3854182	877	18-6410	Yamaha	689-81800-11	477
18-6261	OMC	3854809	877	18-6410	Yamaha	689-81800-12	477
18-6261	OMC	3856600	877	18-6410	Yamaha	689-81800-13-00	477
18-6261	OMC	3857561	877	18-6411	Yamaha	6H3-81800-10	477
18-6261	OMC	3860171	877	18-6411	Yamaha	6H3-81800-11-00	477
18-6261	Volvo	3857561	952	18-6412	Yamaha	697-81800-12	477
18-6261	Volvo	3856600-6	952	18-6412	Yamaha	99999-03249-00	477
18-6263	Universal	288182	634	18-6413	Yamaha	6E5-81800-11-00	478
18-6263	Universal	288759	634	18-6413	Yamaha	6E5-81800-12-00	478
18-6264	Un		634	18-6414	Suzuki	31100-95600	461
18-6265	Volvo	3857813	952	18-6415	Yamaha	6N7-81800-10-00	478
18-6266	Volvo	872300	955	18-6416	Suzuki	31100-94610	461
18-6266	Volvo	876040	955	18-6417	Suzuki	31100-92E00	461
18-6268	Volvo	841177	955	18-6418	Nissan/Tohatsu	353760104M	456
18-6268	Volvo	872272	955	18-6419	Suzuki	31100-89J00	461
18-6270	OMC	984536	873	18-6420	Yamaha	6L2-81800-20-00	478
18-6270	OMC	988013	873	18-6421	Yamaha	6F5-81800-11	478
18-6270			577	18-6421	Yamaha	6J4-81800-01-00	478
18-6271	Volvo	241812	955	18-64217	Mercury	27-815791A00	417
18-6271	Volvo	870670	955	18-6422	Yamaha	6H4-81800-12-00	478
18-6271	Volvo	876038	955	18-64221	Mercury	27-835427A04	417
18-6271	Volvo	6643474	955	18-64221	Nissan/Tohatsu	3V1871210M	458
18-6273-1	Mercury Marine	99186	364	18-6423	Yamaha	688-81800-12-00	478
18-6273-1	Mercury Marine	99186-1	364	18-6425	Mercury Marine	50-804312T1	737
18-6273-1	Mercury Marine	99186T	364	18-6425	Yamaha	67F-81800-02-00	478
18-6274	Mercury Marine	14336A20	365	18-6426	Yamaha	68F-81800-01-00	478
18-6274	Prestolite	HYK4001	956	18-6427	Yamaha	68V-81800-01-00	478
18-6274	Volvo	852928	956	18-6428	Suzuki	31100-95313	461
18-6274	Volvo	3857265	956	18-6429	Suzuki	31100-94702	461
18-6275	Mercury Marine	814472	697	18-6430	Nissan/Tohatsu	B29A-90500A	456
18-6275	Mercury Marine	50-12121A2	697	18-6431	Nissan/Tohatsu	346760100M	456
18-6275	Mercury Marine	50-12177A2	697	18-6432	Nissan/Tohatsu	3C8760101M	456
18-6275	Mercury Marine	50-77328A1	697	18-6433	Honda	31200-ZV5-013	240
18-6275	Mercury Marine	50-77328A3	697	18-6434	OMC	386430	264
18-6275	Mercury Marine	50-806964A2	697	18-6435	Mercury Marine	50-859377T	372
18-6275	Mercury Marine	50-806964A3	697	18-6435	Mercury Marine	50-884044T	372
18-6275	Mercury Marine	50-806964A4	697	18-6435	Mercury Marine	50-888161T	372
18-6275	Mercury Marine	50-807904A1	697	18-6436	Mercury Marine	50-834749	372
18-6275	Mercury Marine	50-812428A3	697	18-6436	Mercury Marine	50-859171T	372
18-6275	Mercury Marine	50-812604A2	697	18-6437	Mercury Marine	50-830308T	373
18-6275	Mercury Marine	50-822330A2	697	18-6437	Mercury Marine	50-859169T	373
18-6275	Mercury Marine	50-863007A1	697	18-6437	Mercury Marine	50-888151T	373
18-6275	Mercury Marine	50-864340A2	697	18-6438	Mercury Marine	50-854636T	373
18-6275	Mercury Marine	50-99418A2	697	18-6438	Mercury Marine	50-859170T	373
18-6275	Volvo	3857747	951	18-6438	Mercury Marine	50-884045T	373
18-6275	Volvo	3860566	951	18-6438	Mercury Marine	50-888160T	373
18-6276	OMC	984536	873	18-6439	Chrysler Force	50-803903T	224
18-6276	OMC	988013	873	18-6439	Chrysler Force	50-F575955	224
18-6277	OMC	435548	260	18-6440	Mercury Marine	50-853329T	373
18-6279	Chrysler Force	820545	224	18-6440	Mercury Marine	50-892339T	373
18-6279	Chrysler Force	F694541-1	224	18-6441	Chrysler Force	50-803900T	224
18-6280	OMC	437801	260	18-6441	Chrysler Force	50-F514955	224
18-6281	OMC	438786	260	18-64415	Yamaha	68F-W1135-00-00	529
18-6281	OMC	439937	260	18-6443	Pleasurecraft	RA122019	625
18-6281	OMC	5005254	260	18-6445	Honda	31200-ZW9-802	241
18-6282	Mercury Marine	50-8329972	373	18-6448			365, 456

1 This product is priced per piece. To order, priced per package, please add -9 to the part number
 2 Items ending in "D" are display packaged - regular number is non-display
 3 For discount shop pack of 10, please add -10 to the part number

SIERRA #	O.E.M.	O.E. #	PAGE #	SIERRA #	O.E.M.	O.E. #	PAGE #
SIERRA							
18-6451	Indmar	575014	615	18-6753	Mercury Marine	88183A12	701
18-6452	Pleasurecraft	RA097009	626	18-6754	OMC	382138	878
18-6453	Pleasurecraft	RA097007C	626	18-6754	Prestolite	ETK 4001	878
18-6454	Mercury Marine	834832	372	18-6754	Prestolite	ETK 4101	878
18-6454	Mercury Marine	857006T	372	18-6754	Prestolite	ETK 4102	878
18-6454	Mercury Marine	875285T1	372	18-6755	OMC	982058	878
18-6454	Mercury Marine	881248T	372	18-6755	OMC	982706	878
18-6454	Mercury Marine	889955A03	372	18-6755	Prestolite	EVD 4001	878
18-6454	Mercury Marine	8M0064021	372	18-6755	Prestolite	EVD 4002	878
18-6455	Mercury Marine	875286A1	372	18-6756			260
18-6455	Mercury Marine	875286T	372	18-6757			364
18-6455	Mercury Marine	881247A1	372	18-6758	Electrolux	5024/120	956
18-6456	Volvo	855507	988	18-6758	Volvo	850834	956
18-6457	Mercury Marine	807757T	734	18-6759	OMC	391264	260
18-6475	Honda	31630-ZW5-003	240	18-6759	OMC	393988	260
18-6476	Honda	31630-ZY6-003	240	18-6759	OMC	394176	260
18-6500	Mercury Marine	84-881262A2	372	18-6759	OMC	985237	260
18-6501	OMC	307573	316	18-6760	Yamaha	6G5-43880-02-00	481
18-6501	OMC	395460	316	18-6761	OMC	387277	260
18-6503	OMC	318944	316	18-6761	OMC	582048	260
18-6506	Mercury Marine	24-29340A1	376	18-6761	OMC	582155	260
18-6506	Mercury Marine	24-29340T1	376	18-6761	OMC	584107	260
18-6509	OMC	326877	316	18-6762	Chrysler Force	455541	224
18-6511	OMC	312932	316	18-6762	Chrysler Force	449541-3	224
18-6512	OMC	330525	316	18-6762	OMC	172543	260
18-6513	OMC	203698	316	18-6763	Mercury Marine	67914A2	702
18-6522	OMC	323653	316	18-6763	Mercury Marine	79271A4	702
18-6522	OMC	338534	316	18-6763	Mercury Marine	92975A28	364
18-6523			989	18-6763	Mercury Marine	92975A32	364
18-6525	OMC	397003	341	18-6763	Mercury Marine	92975A6	702
18-6526	OMC	397004	341	18-6764	OMC	982069	878
18-6527	OMC	395911	341	18-6764	OMC	982073	878
18-6528	OMC	396161	341	18-6764	OMC	983318	878
18-6528	OMC	5000581	341	18-6765	Mercury Marine	823653A5	364
18-65450	Yamaha	6E9-82575-02-00	30, 475	18-6765	Mercury Marine	823653A9	364
18-6650	Yamaha	6M6-81960-A0-00	552	18-6765	Mercury Marine	92459A4	364
18-6651	Yamaha	66V-81960-00-00	552	18-6767-1	OMC	172850	260
18-6652	Yamaha	6K8-81960-A0-00	552	18-6767-1	OMC	173564	260
18-6742	Honda	36120-ZY3-023	241	18-6767-1	OMC	173596	260
18-6743	Honda	36120-ZY9-003	241	18-6768	Mercury Marine	392-8261A1	702
18-6745	Honda	36120-ZY6-013	241	18-6768	Mercury Marine	392-8263	702
18-6744	OMC	5006319	260	18-6768	Mercury Marine	74436A9	702
18-6746	Mercury Marine	14336A20	702	18-6768	Mercury Marine	79271A4	702
18-6746	Mercury Marine	14336A20	702	18-6768	Mercury Marine	88475A4	702
18-6746	Mercury Marine	14336A25	702	18-6768	Mercury Marine	93247A7	702
18-6746	Mercury Marine	14336A31	702	18-6768	Mercury Marine	993247A4	702
18-6746	Mercury Marine	14336A8	702	18-6769-1	Mercury Marine	14336A8	702
18-6746	Mercury Marine	865380A03	702	18-6769-1	Mercury Marine	88183A5	702
18-6746	Mercury Marine	865380A13	702	18-6770	Volvo	854346	955
18-6746	Mercury Marine	88183A5	702	18-6771	Mercury Marine	17646	702
18-6747	Mer cruiser	14336A15	701	18-6771	Mercury Marine	18525	702
18-6747	Mer cruiser	14336A17	701	18-6771	Mercury Marine	18525A1	363, 702
18-6747	Mer cruiser	14336A22	701	18-6772	Mercury Marine	17649	702
18-6747	Mer cruiser	14336A28	701	18-6772	Mercury Marine	17649T	702
18-6747	Mer cruiser	14336A6	701	18-6772	Mercury Marine	891736T	702
18-6747	Mer cruiser	14336A9	701	18-6773	Mercury Marine	828708	364
18-6747	Mer cruiser	865380A02	701	18-6773	Mercury Marine	878265A4	364
18-6747	Mer cruiser	865380A05	701	18-6774	Mercury Marine	811628	364
18-6747	Mer cruiser	865380A15	701	18-6774	Mercury Marine	828708A1	364
18-6747	Mer cruiser	865380A25	701	18-6774	Mercury Marine	878265A6	364
18-6747	Mer cruiser	88183A12	701	18-6775	Chrysler Force	824051	224
18-6747	Mer cruiser	88183A3	701	18-6775	Mercury Marine	811673 1	364
18-6748	Yamaha	67C-43880-00-00	481	18-6777	Chrysler Force	19217A1	224
18-6748	Yamaha	67C-43880-01-00	481	18-6777	Chrysler Force	19217A5	224
18-6749	Mercury Marine	42419A1	701	18-6777	Chrysler Force	818903A1	224
18-6749	Mercury Marine	42419A1	701	18-6777	Chrysler Force	819479A1	224
18-6749	Mercury Marine	58397A2	701	18-6777	Chrysler Force	819480A1	224
18-6749	Mercury Marine	58397A3	701	18-6777	Chrysler Force	819762A4	224
18-6749	Mercury Marine	862548A1	701	18-6777	Chrysler Force	819762A7	224
18-6749	Mercury Marine	88553A1	701	18-6777	Chrysler Force	81977A8	224
18-6749	Mercury Marine	88893A4	701	18-6777	Chrysler Force	81977A9	224
18-6750	Mercury Marine	42419A1	701	18-6777	Chrysler Force	822870A1	224
18-6750	Mercury Marine	862548A1	701	18-6777	Chrysler Force	830250A3	224
18-6751	Mercury Marine	811618	363	18-6777	Chrysler Force	830250T3	224
18-6751	Mercury Marine	811618A1	363	18-6777	Chrysler Force	832021A1	224
18-6751	Mercury Marine	812843A1	363	18-6777	Chrysler Force	832021A2	224
18-6751	Mercury Marine	813442A1	363	18-6777	Chrysler Force	832021T2	224
18-6751	Mercury Marine	813442A2	363	18-6777	Chrysler Force	832021T4	224
18-6751	Mercury Marine	893929A01	363	18-6777	Chrysler Force	855654A1	224
18-6751	Mercury Marine	99660A1	363	18-6777	Chrysler Force	855654T2	224
18-6752	Mercury Marine	14336A15	701	18-6777	Mercury Marine	19217A1	364
18-6752	Mercury Marine	14336A17	701	18-6777	Mercury Marine	19217A5	364
18-6752	Mercury Marine	14336A22	701	18-6777	Mercury Marine	818903A1	364
18-6752	Mercury Marine	14336A28	701	18-6777	Mercury Marine	819479A1	364
18-6752	Mercury Marine	14336A6	701	18-6777	Mercury Marine	819480A1	364
18-6752	Mercury Marine	14336A9	701	18-6777	Mercury Marine	819762A4-A7	364
18-6752	Mercury Marine	88183A11	701	18-6777	Mercury Marine	81977A8-A9	364
18-6752	Mercury Marine	88183A12	701	18-6777	Mercury Marine	822870A1	364
18-6752	Mercury Marine	88183A6	701	18-6777	Mercury Marine	830250A3	364
18-6752	Mercury Marine	96477A3	701	18-6777	Mercury Marine	830250T3	364
18-6753	Mercury Marine	14336A9	701	18-6777	Mercury Marine	832021A1	364

1 This product is priced per piece. To order, priced per package, please add -9 to the part number

2 Items ending in "D" are display packaged - regular number is non-display

3 For discount shop pack of 10, please add -10 to the part number

SIERRA #	O.E.M.	O.E. #	PAGE #	SIERRA #	O.E.M.	O.E. #	PAGE #
SIERRA							
18-6777	Mercury Marine	832021A2	364	18-6823			482, 702, 878, 955
18-6777	Mercury Marine	832021T2	364	18-6824	Merccruiser	50-60594A	374
18-6777	Mercury Marine	832021T4	364	18-6824	Merccruiser	50-60594A1	374
18-6777	Mercury Marine	854472A2	364	18-6824	Merccruiser	50-60594T01	374
18-6777	Mercury Marine	854472A3	364	18-6825	Mercury	50-86976	374
18-6777	Mercury Marine	854472A4	364	18-6826	Johnson/Evinrude	586768	266
18-6777	Mercury Marine	855654A1	364	18-6827	Suzuki	31100-94600	461
18-6777	Mercury Marine	855654T2	364	18-6827	Suzuki	31100-94601	461
18-6778	Mercury Marine	883166A1	702	18-6827	Suzuki	31100-94610	461
18-6778	Mercury Marine	883166A2	702	18-6828	Mercury	50-41583	374
18-6779	OMC	986280	878	18-6829	Mercury	859168	374
18-6779	OMC	3853945	878	18-6829	Mercury	50-859168T	374
18-6779	Volvo	986280	956	18-6829	Mercury	50-852570	374
18-6779	Volvo	3853945	956	18-6829	Mercury	50-852570T	374
18-6780	OMC	434496	260	18-6829	Mercury	50-857065	374
18-6780	OMC	438529	260	18-6829	Mercury	50-859168	374
18-6780	OMC	438531	260	18-6829	Mercury	859168T	374
18-6781	Yamaha	6H1-43880-02-00	482	18-6829	Mercury	50-859168T	374
18-6782	Yamaha	61A-43880-01-00	482	18-6831	Hitachi	S114-837	461
18-6782	Yamaha	61A-43880-02-00	482	18-6831	Hitachi	S114-837A	461
18-6783	Yamaha	64E-43880-00-00	482	18-6831	Suzuki	31100-90J00	461
18-6783	Yamaha	64E-43880-01-00	482	18-6832	Yamaha	60V-81800-00-00	478
18-6785	Suzuki	38100-87000-01T	462	18-6832	Yamaha	60X-81800-00-00	478
18-6785	Suzuki	38100-87E10-0ED	462	18-6833	Yamaha	69J-81800-00-00	478, 480
18-6785	Suzuki	38100-87E20-0ED	462	18-6834	GM Engines		597, 646, 951, 994
18-6786-1	Suzuki	38100-87D10-0ED	462	18-6835	GM Engines		565, 577, 597, 615, 646, 951, 994
18-6786-1	Suzuki	38100-87D10-0IT	462	18-6836	Yamaha	6C5-43880-00-00	482
18-6786-1	Suzuki	38100-87D10-35J	462	18-6836	Yamaha	6C5-43880-01-00	482
18-6786-1	Suzuki	38100-92E00-0ED	462	18-6838	Volvo	852928	955
18-6787	Yamaha	67F-43880-00-00	481	18-6838	Volvo	872449	955
18-6788	Yamaha	6H5-43880-02-00	481	18-6838	Volvo	873051	955
18-6789	Yamaha	62X-43880-09-00	481	18-6838	Volvo	3586765	955
18-6790	Electrolux	KS3448/290	956	18-6839	Volvo	1357199	952
18-6790	Volvo	839430	956	18-6839	Volvo	3523301	952
18-6791	Volvo	850046	956	18-6839	Volvo	5003564	952
18-6791	Volvo	852520	956	18-6839	Volvo	1357199-7	952
18-6792	Volvo	854329	956	18-6839	Volvo	3523301-4	952
18-6792	Volvo	897720	956	18-6839	Volvo	5003564-1	952
18-6793	Honda	36120-ZV5-822	241	18-6840	Mercury	50-897755T	372
18-6793	Suzuki	38100-87J11	462	18-6840	Mercury	897755T	372
18-6793	Suzuki	38100-87J20	462	18-6841	Merccruiser	56045	703
18-6798	Yamaha	60V-43880-00-00	481	18-6841	Merccruiser	59755	703
18-6798	Yamaha	69J-43880-00-00	481	18-6841	Merccruiser	69729	703
18-6799	Mercury Marine	392-8261A1	702	18-6841	Merccruiser	78477	703
18-6799	Mercury Marine	392-8263	702	18-6841	Merccruiser	90794	703
18-6799	Mercury Marine	74436A9	702	18-6841	Merccruiser	78403A1	703
18-6799	Mercury Marine	79271A4	702	18-6841	Merccruiser	78403A2	703
18-6799	Mercury Marine	88475A4	702	18-6841	OMC	983424	877
18-6799	Mercury Marine	93247A4	702	18-6841	OMC	983836	877
18-6799	Mercury Marine	93247A7	702	18-6841	OMC	988247	877
18-6801	OMC	5005114	261	18-6842	Merccruiser	56045	703
18-6802	OMC	5005113	261	18-6842	Merccruiser	59755	703
18-6803	OMC	5005115	261	18-6842	Merccruiser	69729	703
18-6803	OMC	5007662	261	18-6842	Merccruiser	78477	703
18-6804	Volvo	3861575	955	18-6842	Merccruiser	90794	703
18-6806	Volvo	3587079	955	18-6842	Merccruiser	78403A1	703
18-6806	Volvo	3857489	955	18-6842	Merccruiser	78403A2	703
18-6806	Volvo	3860879	955	18-6842	OMC	983247	646
18-6811	Yamaha	62X-43880-00-00	482	18-6842	OMC	983424	646
18-6811	Yamaha	62X-43880-01-00	482	18-6842	OMC	983836	646
18-6811	Yamaha	62Y-43880-11-00	482	18-6843	Mando	A000B0341	994
18-6811	Yamaha	62Y-43880-00-00	482	18-6843	Mando	TA000B0341	994
18-6811	Yamaha	69W-43880-00-00	482	18-6843	Yamaha	19-1400-10	994
18-6812	Yamaha	62X-43880-00-00	482	18-6844	Denso	101211-3460	703
18-6812	Yamaha	62X-43880-01-00	482	18-6844	Merccruiser	834832	703
18-6812	Yamaha	62X-43880-09-00	482	18-6844	Merccruiser	834832T2	703
18-6813	Merccruiser	14336A15	702	18-6844	Merccruiser	857006A3	703
18-6813	Merccruiser	14336A20	702	18-6845	Volvo	3862613	953
18-6813	Merccruiser	14336A6	702	18-6845	Volvo	3862665	953
18-6813	Merccruiser	14336A8	702	18-6845	Volvo	3884950	953
18-6813	Merccruiser	14336A9	702	18-6846	Volvo Penta	72021	661, 953
18-6813	Merccruiser	865380A13	702	18-6846	Volvo Penta	845940	661, 953
18-6813	Merccruiser	88183A12	702	18-6846	Volvo Penta	872022	661, 953
18-6813	Merccruiser	88183A5	702	18-6846	Volvo Penta	872757	661, 953
18-6813	Merccruiser	88183A8	702	18-6846	Volvo Penta	873635	661, 953
18-6814	OMC	984356	878	18-6846	Volvo Penta	873757	661, 953
18-6815	Johnson/Evinrude	5005831	260	18-6846	Volvo Penta	1502272	661, 953
18-6816	OMC	172588	260	18-6846	Volvo Penta	5001677	661, 953
18-6816	OMC	173944	260	18-6846	Volvo Penta	3803270-2	661, 953
18-6817	Volvo	3858071	955	18-6846	Volvo Penta	873757-9	661, 953
18-6817	Volvo Penta	854525-3	955	18-6846	Volvo Penta	873771,	661, 953
18-6818	Power Pole	PUMP SPN-F	62	18-6847	Volvo	2655301	953
18-6819	Power Pole	PUMP PRO-F	62	18-6847	Volvo	3862613	953
18-6821	Yamaha	688-43880-11-00	482	18-6848	Valeo	A0002655299	953
18-6821	Yamaha	6E5-43880-01-00	482	18-6848	Volvo	2656299	953
18-6821	Yamaha	6E5-43880-02-00	482	18-6848	Volvo	3862612	953
18-6822	OMC	172543	955	18-6849	Denso	101211-9940	661
18-6822	OMC	382715	955	18-6849	Yanmar	119773-77200	661
18-6822	Volvo Penta	820545	955	18-6851	Universal		58
18-6822	Volvo Penta	852928	955	18-6852	Universal		58
18-6823	Universal		241, 260, 364, 456, 462,	18-6853	Universal		58

1 This product is priced per piece. To order, priced per package, please add -9 to the part number
 2 Items ending in "D" are display packaged - regular number is non-display
 3 For discount shop pack of 10, please add -10 to the part number

SIERRA #	O.E.M.	O.E. #	PAGE #	SIERRA #	O.E.M.	O.E. #	PAGE #
SIERRA							
18-6854	Universal	Universal	58	18-6926	Yanmar	129612-77230	661
18-6855	Universal	Universal	58	18-6927	Yanmar	119573-77200	661
18-6856	Universal	Universal	58	18-6927	Yanmar	119573-77201	661
18-6857	Yamaha PWC	63M-81960-00-00	552	18-6927	Yanmar	129470-77200	661
18-6858	Yamaha PWC	6H2-81960-00-00	552	18-6928	Hitachi	LR135-74	661
18-6859	Sea-Doo	278-001-376	551	18-6928	Hitachi	LR135-74B	661
18-6859	Sea-Doo	278-001-802	551	18-6928	Yanmar	128170-77200	661
18-6860	Sea-Doo		551	18-6928	Yanmar	128170-77201	661
18-6861	Hitachi	S114-559B	478	18-6928	Yanmar	128170-77202	661
18-6861	Yamaha	61A-81800-01-00	478	18-6929	Hitachi	129470-77200	661
18-6861	Yamaha	69L-81800-00-00	478	18-6929	Hitachi	LR180-03A	661
18-6861	Yamaha	69W-81800-00	478	18-6929	Hitachi	LR180-03B	661
18-6862	Yamaha	64X-81800-00-00	551	18-6929	Hitachi	LR180-03C	661
18-6862	Yamaha	6M6-81800-10-00	551	18-6929	Yanmar	119573-77200	661
18-6863	OMC	584605, 586275	266	18-6929	Yanmar	119573-77201	661
18-6864	Mercury	50-819271	374	18-6930	Yanmar	104211-77010	662
18-6864	Mercury	50-820193A1	374	18-6930	Yanmar	104211-77011	662
18-6865	Honda			18-6931	Yanmar	119209-77010	662
18-6865	Nissan-Tohatsu			18-6931	Yanmar	121120-77010	662
18-6865	OMC			18-6931	Yanmar	121120-77011	662
18-6865	Suzuki	48600-94511-0ED		18-6931	Yanmar	121120-77012	662
18-6865	Yamaha			18-6931	Yanmar	124520-77010	662
18-6866	Sea-Doo	278-000-576	551	18-6931	Yanmar	124520-77011	662
18-6866	Sea-Doo	278-000-577	551	18-6932	Yanmar	121370-77010	662
18-6866	Sea-Doo	278-001-038	551	18-6932	Yanmar	129242-77010	662
18-6866	Sea-Doo	278-001-301	551	18-6932	Yanmar	129698-77010	662
18-6867	Denso	228000-4550	551	18-6934	Hitachi	S13-68	662
18-6867	Sea-Doo	278-000-484	551	18-6934	Hitachi	S13-68A	662
18-6867	Sea-Doo	278-000-485	551	18-6934	Hitachi	S13-68C	662
18-6867	Sea-Doo	278-001-300	551	18-6934	Hitachi	S13-86	662
18-6867	Sea-Doo	278-001-935	551	18-6934	Yanmar	123500-77010	662
18-6868	Denso	995435	551	18-6934	Yanmar	124610-77010	662
18-6868	Denso	128000-4860	551	18-6934	Yanmar	124610-77019	662
18-6868	Denso	128000-4861	551	18-6934	Yanmar	424610-77010	662
18-6868	Denso	128000-4862	551	18-6935	Yanmar	119225-77010	662
18-6868	Denso	128000-4863	551	18-6935	Yanmar	119225-77011	662
18-6868	Denso	128000-4864	551	18-6935	Yanmar	119226-77010	662
18-6868	Sea-Doo	278-000-186	551	18-6936	Yanmar	114361-77011	662
18-6868	Sea-Doo	278-000-311	551	18-6936	Yanmar	114362-77010	662
18-6868	Sea-Doo	278-000-316	551	18-6936	Yanmar	114362-77011	662
18-6869	Sea-Doo	278-001-497	551	18-6936	Yanmar	114399-77010	662
18-6869	Sea-Doo	278-001-936	551	18-6937	Hitachi	S114-303	662
18-6870	Mercury	50-805833	662	18-6937	Hitachi	S114-303A	662
18-6870	Mercury	50-805833T	662	18-6937	Yanmar	128170-77010	662
18-6871	Sea-Doo	278-001-292	552	18-6937	Yanmar	128170-77010D	662
18-6872	Volvo	233991	662, 952	18-6938	Yanmar	119773-77010	662
18-6872	Volvo	240501	662, 952	18-6939	Yanmar	121254-77010	662
18-6872	Volvo	837924	662, 952	18-6939	Yanmar	121254-77011	662
18-6872	Volvo	842775	662, 952	18-6939	Yanmar	121254-77012	662
18-6872	Volvo	843511	662, 952	18-6939	Yanmar	121254-77019	662
18-6872	Volvo	881681	662, 952	18-6939	Yanmar	129429-77010	662
18-6872	Volvo	847306-8	662, 952	18-6939	Yanmar	129429-77011	662
18-6873	Denso	428000-0081	551	18-6940	Mercury	50-825991A2	374
18-6873	Kawasaki	21163-3715	551	18-6941	Suzuki	31100-93J00	461
18-6873	Kawasaki	21163-3719	551	18-6941	Suzuki	31100-96J00	461
18-6874	Sea-Doo	278-001-581	552	18-6941	Suzuki	31100-96J01	461
18-6875	Kawasaki PWC	21174-3703	552	18-6942	Hitachi	S114-682	478
18-6876	Sea-Doo	278-001-554	552	18-6942	Yamaha	69W-81800-00-00	478
18-6877	Honda PWC	31200-HW1-671	551	18-6943	Mercury	50-893894	374
18-6878	Sea-Doo	278-000-123	552	18-6943	Yamaha	66M-81800-01-00	478
18-6879	Sea-Doo	278-001-239	552	18-6943	Yamaha	66M-81800-02-00	478
18-6880	Hitachi	S114-257	662	18-6944	Bosch	0-001-109-035	662
18-6880	Hitachi	S114-257G	662	18-6944	Caterpillar	163-3361	662
18-6880	Hitachi	S114-483	662	18-6944	Perkins	185086600	662
18-6880	Hitachi	S114-483A	662	18-6944	Volvo	3583555	662
18-6880	Yanmar	129573-77010	662	18-6944	Volvo	21323043	662
18-6880	Yanmar	171008-77010	662	18-6945	Johnson	5036972	266
18-6881	Prestolite	873051	955	18-6945	Suzuki	31100-95J00	461
18-6881	Volvo	852928	955	18-6945	Suzuki	31100-95J01	461
18-6881	Volvo	872449	955	18-6946	Mercuriser	50-8M8021116	699
18-6904	Kawasaki	21163-3720	551	18-6947	Mercuriser	50-805991	662, 699
18-6904	Kawasaki	21163-3720	551	18-6948	Mercury	882571	661, 703
18-6905	Sea-Doo	290-888-993	551	18-6948	Mercury	8M0084523	661, 703
18-6905	Sea-Doo	290-888-999	551	18-6949	Mercuriser	50-831001562	662, 699
18-6905	Sea-Doo	420-888-9933	551	18-6949	Mercuriser	50-831001961	662, 699
18-6905	Sea-Doo	420-888-994	551	18-6950	OMC	982019	878
18-6905	Sea-Doo	420-888-996	551	18-6951	Volvo	851120	955
18-6906	Yamaha PWC	64X-81800-00-00	551	18-6952	Cummins	214169	661
18-6907	Yamaha PWC	6D3-81800-00-00	551	18-6952	Cummins	3920618	661
18-6908	Yamaha PWC	63M-81800-00-00	552	18-6952	Cummins	3603853RX	661
18-6909	Yamaha PWC	6S5-81800-00-00	552	18-6952	Delco	1100077	661
18-6919	Arctic Cat PWC	3008-093	552	18-6952	Delco	1100093	661
18-6919	Arctic Cat PWC	3008-327	552	18-6952	Delco	1100211	661
18-6919	Arctic Cat PWC	3008-462	552	18-6952	Delco	1100274	661
18-6919	Arctic Cat PWC	3008-536	552	18-6952	Delco	1105474	661
18-6921	Yamaha PWC	60E-81800-00-00	552	18-6952	Delco	1105475	661
18-6925	Hitachi	LR135-105	661	18-6952	Delco	1105476	661
18-6925	Yanmar	128270-77200	661	18-6952	Delco	10459244	661
18-6926	Yanmar	119836-77200	661	18-6953	Volvo	3803645	661
18-6926	Yanmar	119836-77200-2	661	18-6953	Volvo	8602629	661
18-6926	Yanmar	119836-77200-3	661	18-6953	Volvo	8602710	661

1 This product is priced per piece. To order, priced per package, please add -9 to the part number

2 Items ending in "D" are display packaged - regular number is non-display

3 For discount shop pack of 10, please add -10 to the part number

SIERRA #	O.E.M.	O.E. #	PAGE #	SIERRA #	O.E.M.	O.E. #	PAGE #
SIERRA							
18-6953	Volvo	8602714	661	18-7037	Chrysler Force	FK10027	225
18-6953	Volvo	8676496	661	18-7037	Chrysler Force	FK10057	225
18-6953	Volvo	8676498	661	18-7037	Chrysler Force	FK10108	225
18-6953	Volvo	8676499	661	18-7037	Chrysler Force	FRK739	225
18-6954	Mercury	50-831001671	662	18-7038	OMC	379312	268
18-6954	Mercury	50-831001672	662	18-7038	OMC	387262	268
18-6954	Mercury	50-831002050	662	18-7038	OMC	396520	268
18-6954	Mercury	50-831002051	662	18-7039			157
18-6954	Mercury	50-831002052	662	18-7040			956
18-6955	Caterpillar	3001117	661, 953	18-7041	Chrysler Force	FO10790	225
18-6955	Caterpillar	10-258	661, 953	18-7041	Chrysler Force	FO16311	225
18-6955	Prestolite	110-258	661, 953	18-7042	OMC	392061	267
18-6955	Prestolite	110-258A	661, 953	18-7042	OMC	396701	267
18-6955	Volvo	849748-9	661, 953	18-7042	OMC	398729	267
18-69550	Volvo	3854164	954	18-7043	OMC	382045	267
18-6956	Volvo	6209190	952	18-7043	OMC	382046	267
18-6957	Mercuriser	50-801333980	662, 699	18-7043	OMC	382047	267
18-6957	Mercuriser	50-854178	662, 699	18-7043	OMC	382049	267
18-6957	Mercuriser	50-855507	662, 699	18-7043	OMC	383052	267
18-6958	Volvo	870998	662, 952	18-7043	OMC	383067	267
18-6958	Volvo	881682	662, 952	18-7043	OMC	398532	267
18-6958	Volvo	847308-4	662, 952	18-7043	OMC	439071	267
18-6959	Honda	31200-ZY6-003	241	18-7044		175158+437228	268
18-6959	Honda	31200-ZY9-003	241	18-7046	OMC	390055	267
18-6959	Honda	31200-ZY9A-0031	241	18-7046	OMC	392550	267
18-6960	Denso	101211-3020	703	18-7046	OMC	398526	267
18-6960	Denso	101211-3021	703	18-7046	OMC	434888	267
18-6960	Mercuriser	821663	703	18-7046	OMC	435443	267
18-6960	Mercuriser	8216631	703	18-7046	OMC	439076	267
18-6960	Mercuriser	821663A1	703	18-7047	Honda	16011-ZV4-005	243
18-6961	Yamaha	6CB-81800-00-00	478	18-7048	Honda	16011-881-741	243
18-6970	Yanmar	129470-77200	661	18-7049	Yamaha	61N-14392-00-00	484
18-6971	Yanmar		661	18-7049	Yamaha	62Y-14392-00-00	484
18-6975	Universal		646, 703, 953	18-7049	Yamaha	6L2-14392-00-00	484
18-7000	Volvo	841292	958	18-7050	Honda		243
18-7000	Volvo	856471	958	18-7051	Honda		243
18-7000	Volvo	856472	958	18-7052	Honda		243
18-7000	Volvo	841836-0	958	18-7053	Honda		243
18-7001	Volvo	841293-4	958	18-7054	Yamaha	6G1-14546-00-00	484
18-7002	Yamaha	6E5-W0093-06-00	483	18-7054	Yamaha	6G1-14546-01-00	484
18-70021			755, 892, 966	18-7055	Yamaha	6E5-14546-00-00	484
18-7004	Mercury Marine	1395-6200	377	18-7055	Yamaha	6J8-14546-00-00	484
18-7005	Mercury Marine	1395-6452	377	18-7056	Yamaha	67F1439A-00-00	484
18-700-5500			88	18-7056	Yamaha	6H2-14591-00-00	484
18-7006-1	Mercury Marine	879194024	377	18-7056	Yamaha	6H3-14590-00-00	484
18-7006-1	Mercury Marine	1395-4808	377	18-7056	Yamaha	6H3-14590-01-00	484
18-7006-1	Mercury Marine	1395-879194024	377	18-7057	Chrysler Force	F010790	225
18-7006-1	Mercury Marine	1399-1717	377	18-7057	Mercury Marine	1395-9258	378
18-7006-1	Mercury Marine	1399-2015	377	18-7057	Mercury Marine	1395-9258 1	378
18-7006-1	Mercury Marine	1399-3523	377	18-7057	Mercury Marine	1399-1138	378
18-700-6250			88	18-7057	Mercury Marine	1399-1473	378
18-700-6500			88	18-7058	Yamaha	63V-W0093-00-00	482
18-700-6750			88	18-7059	Yamaha	677-W0093-00-00	482
18-7007	Mercury Marine	1399-5135	377	18-7059	Yamaha	677-W0093-04-00	482
18-7007	Mercury Marine	1399-5198	377	18-7060	Yamaha	692-14590-00-00	485
18-700-7000			88	18-7060	Yamaha	692-14590-01-00	485
18-700-7250			88	18-7061	Mercury Marine	1395-8318	378
18-700-7500			88	18-7061	Mercury Marine	1395-83181	378
18-700-7750			88	18-7062	Mercury Marine	1395-95951	378
18-7008			956	18-7063	Yamaha	6L2-14385-00-00	485
18-700-8000			88	18-7064	Yamaha	63V-14985-00	485
18-700-8250			88	18-7065	Yamaha	647-14385-00-00	485
18-700-8500			88	18-7066	Yamaha	648-14385-00-00	485
18-700-9000A			88	18-7067	Yamaha	6G1-14985-00-00	485
18-700-9250			88	18-7068	Yamaha	6E5-14385-00-00	485
18-700-9500			88	18-7068	Yamaha	6E5-14385-01-00	485
18-7010	OMC	382050	267	18-7069	Yamaha	6E5-14385-02-00	485
18-7010	OMC	382051	267	18-7070	Mercury Marine	1397-2072	719
18-7010	OMC	382054	267	18-7070	Mercury Marine	1397-2637	719
18-7013			377	18-7070	Mercury Marine	1397-3464	719
18-7017	OMC	985052	880	18-7070	Mercury Marine	1397-7542	719
18-7017	Pleasurecraft	RN0118-1	627	18-7070	Mercury Marine	1397-7543	719
18-7017	Pleasurecraft	RN0120-1	627	18-7070	Mercury Marine	1397-8872	719
18-7018	OMC	982352	880	18-7070	OMC	383615	880
18-7019			566, 598	18-7070	OMC	982384	880
18-7021			377	18-7070			566, 598, 635
18-7022			566, 598	18-70704	Mercury Marine	32-89653	755
18-7023			566	18-70704	Volvo	838513	966
18-7024	OMC	382052	267	18-70704	Volvo	856306	966
18-7024	OMC	382053	267	18-70704			892
18-7024	OMC	385356	267	18-7071	Mercury Marine	1397-3458	719
18-7025			566	18-7071	OMC	380186	880
18-7026	OMC	382057	267	18-7071			635
18-7033	Chrysler Force	FK10003	225	18-7072	Mercury Marine	1397-3306	720
18-7033	Chrysler Force	FK10026	225	18-7072	Mercury Marine	1397-4329	720
18-7033	Chrysler Force	FK10053	225	18-7072	Mercury Marine	1397-5635	720
18-7033	Chrysler Force	FK10102-1	225	18-7072	Mercury Marine	1397-6638	720
18-7037	Chrysler Force	FK10004	225	18-7072	Mercury Marine	823426A1	720
18-7037	Chrysler Force	FK10005	225	18-7072	OMC	384743	880
18-7037	Chrysler Force	FK10007	225	18-7072	OMC	979659	880
18-7037	Chrysler Force	FK10008	225	18-7072	Volvo	855889	956

1 This product is priced per piece. To order, priced per package, please add -9 to the part number
 2 Items ending in "D" are display packaged - regular number is non-display
 3 For discount shop pack of 10, please add -10 to the part number

SIERRA #	O.E.M.	O.E. #	PAGE #	SIERRA #	O.E.M.	O.E. #	PAGE #
SIERRA							
18-7072			566, 598	18-70957	Mercury Marine	32-41642A3	Obsolete
18-7073	Yamaha	6E7-14390-12-00	485	18-70958	Mercury Marine	32-96246	753
18-7073	Yamaha	6E8-14380-12-00	485	18-70958	Mercury Marine	32-96246A1	753
18-7075	Mercury Marine	1397-5830	719	18-70958	Mercury Marine	32-96246A4	753
18-7075	Mercury Marine	1397-5831	719	18-7096	Mercury Marine	1356-4066	720
18-7075	Mercury Marine	1397-7099	719	18-7096	Mercury Marine	1356-4092	720
18-7075	Mercury Marine	1397-8760	719	18-7096	Mercury Marine	1356-5155	720
18-7076	Mercury Marine	1397-6367	720	18-7096	Mercury Marine	1356-5169	720
18-7076	Mercury Marine	1397-6367A1	720	18-7096	Mercury Marine	1396-5222	720
18-7077	Mercury Marine	1397-8952	720	18-7096	Mercury Marine	1396-5238	720
18-7077	Mercury Marine	823426A1	720	18-7096	OMC	982539	881
18-7078	Mercury Marine	1337-2103	720	18-7096	OMC	85R-4541	881
18-7078	Mercury Marine	1337-2604	720	18-7096	Pleasurecraft	RN0118	627
18-7078	Mercury Marine	1397-2133	720	18-7096	Pleasurecraft	RN0120	627
18-7078	Mercury Marine	1397-2605	720	18-7097	Mercury Marine	3302-804845	720
18-7078	Mercury Marine	1397-3462	720	18-7097	Mercury Marine	3302-9437	720
18-7078			598	18-7098-1	Mercury Marine	3302-804844	720
18-7079	Yamaha	626-14390-90	485	18-7098-1	Mercury Marine	3302-804844001	720
18-7080	Mercury Marine	1346-2770	720	18-7098-1	Mercury Marine	3302-804844002	720
18-7080	Mercury Marine	1398-3089	720	18-7099	Volvo	824803	957
18-7080	OMC	979719	880	18-7099	Volvo	856470	957
18-7081	Mercury Marine	1396-4656	720	1 18-7100	Chrysler Force	25-85594	239
18-7081	OMC	982537	880	1 18-7100	Mercury Marine	25-85594	449
18-7081	OMC	983538	880	1 18-7100	OMC	301877	350, 933
18-7081	Pleasurecraft	RN0116	627		18-710-06-2		106, 837, 914
18-7081	Pleasurecraft	RN0116-2	627		18-710-08-2		106
18-7083	Mercury	684311	386	1 18-7101	OMC	305739	350, 933
18-7083	Mercury	816877	386		18-710-10-2		106, 837
18-7083	Mercury	858763	386		18-710-104-2		106, 837
18-7083	Mercury	8168771	386		18-710-12-2		106, 837, 914
18-7083	Mercury	8168772	386		18-710-16-2		106, 837, 914
18-7083	Mercury	8168773	386	1 18-7102	Mercury Marine	25-62706	449
18-7085	Volvo	875407	956	1 18-7102	OMC	307450	350, 933
18-7086	OMC	984487	880	1 18-7102	Volvo	3852073	993
18-7086	Volvo	841994	957		18-710-20-2		106, 837, 914
18-7086			598		18-710-24-2		106, 837, 914
18-7089			577		18-710-28-2		106
18-7091			577	1 18-7103	Mercury Marine	25-29845	449, 858
18-70924			755, 892, 966	1 18-7103	OMC	308624	350, 933
18-70925	Mercury Marine	32-16021	754		18-710-32-2		106, 837, 914
18-70925	Mercury Marine	32-160211	754		18-710-36-2		106
18-70925	Mercury Marine	32-87116	754	1 18-7104	OMC	308627	350, 933
18-70926	Mercury Marine	32-73796	754		18-710-40-2		106
18-70927	Mercury Marine	32-73795	754		18-710-44-2		106
18-70928	Mercury Marine	32-71613	754		18-710-48-2	Mercury Marine	54-32533
18-70929	Mercury Marine	32-73794	754		18-710-48-2	Mercury Marine	54-815504348
18-7093	OMC	378895	268		18-710-48-2	Volvo	3852604
18-7093	OMC	396521	268		18-710-48-2		106, 988
18-7093	OMC	678882	268	1 18-7105	Mercury Marine	25-62705	449, 858
18-70930	Mercury Marine	32-52481	754	1 18-7105	Mercury Marine	25-F7848342	449, 858
18-70931	Mercury Marine	32-47640	754	1 18-7105	OMC	311338	350, 933
18-70931	Mercury Marine	32-8M0071007	754		18-710-52-2		106
18-70931	Mercury Marine	32-96879	754		18-710-56-2		106
18-70932	Mercury Marine	32-87117	754	1 18-7106	OMC	307583	268
18-70932	Mercury Marine	32-871171	754		18-710-60-2		106
18-70934	Mercury Marine	32-897181	753		18-710-64-2	Volvo	853012
18-70935	Mercury Marine	32-806856	753		18-710-64-2		106, 837, 914
18-70936	OMC	321724	301	1 18-7107	Mercury Marine	25-67202	449, 858
18-70936	OMC	340975	301	1 18-7107	OMC	313175	350, 933
18-70937	OMC	340976	301		18-710-72-2	Mercury Marine	54-31765
18-70938	Mercury Marine	32-8066351	753		18-710-72-2		106, 837, 914
18-70939	Mercury Marine	32-8066361	753	1 18-7108	OMC	313893	350, 933
18-7094	OMC	379313	268	1 18-7108	OMC	338518	350, 933
18-7094	OMC	396522	268		18-710-80-2		106
18-70940	Mercury Marine	32-860144	753		18-710-88-2		106
18-70943	Mercury Marine	32-897491	753	1 18-7109	OMC	317178	350, 933
18-70945	Mercury Marine	32-862139	752		18-710-96-2		106
18-70946	Mercury Marine	32-8066362	753	1 18-7110	OMC	335523	307
18-70947	Mercury Marine	32-862124	752		18-71102	OMC	337
18-70948	Mercury Marine	32-808033	752		18-7111	OMC	301824
18-70949	Mercury Marine	32-807407	752		18-7112	OMC	302493
18-7095	Crusader	45334	598		18-7113-9	Mercury Marine	25-897536
18-7095	Mercury Marine	1397-7539	720		18-7113-9	Mercury Marine	25-98277
18-7095	Mercury Marine	1397-7540	720	1 18-7114	Mercury Marine	25-23145	449, 858
18-7095	Mercury Marine	1397-7544	720	1 18-7114	Mercury Marine	25-843315	449, 858
18-7095	Mercury Marine	1397-8535	720	1 18-7114	Mercury Marine	25-F702736	449, 858
18-7095	Mercury Marine	1397-9723	720	1 18-7114	OMC	302540	350, 933
18-7095	OMC	383918	880		18-7115	Mercury Marine	25-26722
18-7095	OMC	983864	880		18-7115	OMC	302588
18-7095	Volvo	834985-4	957		18-7116	Mercury Marine	802206
18-7095			157, 566, 577		18-7116	Mercury Marine	25-20633
18-70951	Mercury Marine	32-8078961	752		18-7116	Mercury Marine	25-22174
18-70951	Mercury Marine	32-8078962	752		18-7116	Mercury Marine	25-62704
18-70951	Mercury Marine	32-860205	752		18-7116	Mercury Marine	25-85148
18-70952	Mercury Marine	32-887952	752		18-7116	Mercury Marine	25-F24342
18-70953	Mercury Marine	32-8080441	752		18-7116	OMC	303067
18-70954	Mercury Marine	32-860089	752		18-7116	Volvo	3852045
18-70954	Mercury Marine	32-8600891	752		18-7117	Mercury Marine	25-35027
18-70955	Mercury Marine	32-16011	752		18-7117	OMC	303360
18-70956	Mercury Marine	32-16012	752	1 18-7118	OMC	305242	350, 933
18-70957	Mercury Marine	32-41642A1	Obsolete	1 18-7118	Suzuki	09280-08008	472

1 This product is priced per piece. To order, priced per package, please add -9 to the part number

2 Items ending in "D" are display packaged - regular number is non-display

3 For discount shop pack of 10, please add -10 to the part number

SIERRA #	O.E.M.	O.E. #	PAGE #	SIERRA #	O.E.M.	O.E. #	PAGE #
SIERRA							
18-7119	Yamaha	93210-33M85-00	550	1 18-7157	Mercury Marine	25-29976	449, 858
18-7120	Chrysler Force	25-F498618	239	1 18-7158	Mercury Marine	25-30613	449, 858
18-7120	Mercury Marine	25-38933	449, 858	1 18-7158	Mercury Marine	25-846357	449, 858
18-7120	OMC	307853	350, 933	1 18-7158	OMC	310585	350, 933
18-7120	OMC	332598	933	1 18-7158	OMC	310967	350, 933
18-7121	Mercury Marine	802231	449, 858	1 18-7159	Mercury Marine	25-31534	449, 858
18-7121	Mercury Marine	25-35029	449, 858	1 18-7159	Mercury Marine	25-48451	449, 858
18-7121	Mercury Marine	25-882613	449, 858	1 18-7160	Mercury Marine	25-31986	449, 858
18-7121	OMC	308621	350, 933	1 18-7161	Mercury Marine	25-32546	449, 858
18-71218	Mercury Marine	32-48131	755	1 18-7162	Mercury Marine	25-32424	449, 858
18-71218	Mercury Marine	32-48132	755	1 18-7162	Mercury Marine	25-33145	449, 858
18-71218			892, 966	1 18-7162	OMC	302337	350, 933
18-7122	Volvo	925095	993	1 18-7162	Volvo	3852044	993
18-7123	OMC	308876	350, 933	1 18-7163	Mercury Marine	25-33465	449, 858
18-7124			449	1 18-7163	Mercury Marine	25-807149	449, 858
18-7125			449	1 18-7163	Mercury Marine	25-853220	449, 858
18-7126	OMC	313340	350, 933	1 18-7164	Mercury Marine	25-33466	449, 858
18-7127	Chrysler Force	25-32507	239	1 18-7164	Mercury Marine	25-33466	449, 858
18-7127	Chrysler Force	25-F84305	239	1 18-7164	Mercury Marine	25-67675	449, 858
18-7127	Chrysler Force	F83404	239	1 18-7164	Mercury Marine	25-846356	449, 858
18-7127	Mercury Marine	25-32507	858	1 18-7164	OMC	302537	350, 933
18-7127	Mercury Marine	25-F84305	858	1 18-7165	Mercury Marine	25-32509	449, 858
18-7127	OMC	313446	350, 933	1 18-7165	Mercury Marine	25-806609	449, 858
18-7128	OMC	313754	350, 933	1 18-7165	Mercury Marine	25-F461342	449, 858
1 18-7129	OMC	314491	350, 933	1 18-7165	OMC	304174	350, 933
1 18-7130	OMC	314728	350, 933	1 18-7166	Mercury Marine	25-45254	449, 858
1 18-7133	OMC	305123	350, 933	1 18-7167	Mercury Marine	25-861844	449, 858
1 18-7133	OMC	322119	350, 933	1 18-7167	OMC	310414	350, 933
18-71330	Yamaha	93210-05001	505	1 18-7168	Mercury Marine	25-20587	449, 858
18-71331	Yamaha	93210-44704	504	1 18-7168	Mercury Marine	25-21720	449, 858
18-71332	Yamaha	93210-45161	505	1 18-7168	Mercury Marine	25-26834	449, 858
18-71333	Yamaha	93210-49046	504	1 18-7168	Mercury Marine	25-48171	449, 858
18-71334	Yamaha	93210-59MG7	505	1 18-7168	Mercury Marine	25-801334436	449, 858
18-71335	Honda	91301-ZG3-000	245	1 18-7168	OMC	202893	350, 933
18-71336	Johnson/Evinrude	302035	284, 285	1 18-7168	Volvo	3852033	993
18-71337	Mercury Marine	32-806825	755	1 18-7169	Chrysler Force	25-F24278	239
18-71337	Mercury Marine	32-861590A05	755	1 18-7169	Mercury Marine	25-35984	449, 858
18-71337	Mercury Marine	32-861590A1	755	1 18-7169	Mercury Marine	25-70937	449, 858
18-71337	Mercury Marine	32-861590A2	755	1 18-7169	OMC	911686	350, 933
18-71337	OMC	312781	893	1 18-7170	Mercury Marine	25-33504	449, 858
18-71337			966	1 18-7170	OMC	307239	350, 933
18-71338	Johnson/Evinrude	346865	284	1 18-7171	Mercury Marine	25-30529	449, 858
1 18-7134	Johnson/Evinrude	342370	285	1 18-7172	Mercury Marine	25-31305	449, 858
1 18-7134	Chrysler Force	25-20195	239	1 18-7172	OMC	553126	350, 933
1 18-7134	Chrysler Force	25-201951	239	1 18-7173	Mercury Marine	25-27018	449, 858
1 18-7134	Mercury Marine	25-20195	858	1 18-7173	Mercury Marine	25-30224	449, 858
1 18-7134	Mercury Marine	25-201951	858	1 18-7173	OMC	310327	350, 933
1 18-7134	OMC	303059	350, 933	1 18-7174	Mercury Marine	25-45711	449, 858
1 18-7135	Mercury Marine	25-20365	449, 858	1 18-7174	Mercury Marine	25-F455342	449, 858
1 18-7135	Mercury Marine	25-35276	449, 858	1 18-7174	OMC	326649	350, 933
1 18-7135	OMC	310584	350, 933	1 18-7174	OMC	910582	350, 933
1 18-7135	Volvo	3852089	993	1 18-7175	Mercury Marine	25-62817	449, 858
1 18-7137	OMC	318372	350, 933	1 18-7176	Chrysler Force	25-F74305	239
1 18-7138	OMC	318717	350, 933	1 18-7176	Mercury Marine	25-896523	449, 858
1 18-7139	OMC	319085	350, 933	1 18-7176	Mercury Marine	25-F74305	449, 858
1 18-7140	OMC	320303	350, 933	1 18-7176	Mercury Marine	F694555	449, 858
1 18-7140	Suzuki	09280-75002	472	1 18-7176	Mercury Marine	F74305	449, 858
1 18-7141	OMC	321117	350, 933	1 18-7176	Mercury Marine	F74305-1	449, 858
1 18-7141	Volvo	3852165	993	1 18-7177	Mercury Marine	25-53421	449, 859
1 18-7142	OMC	322119	350, 933	1 18-7177	Mercury Marine	25-59712	449, 859
1 18-7143	Mercury Marine	25-65936	449, 858	1 18-7178	OMC	320140	350, 933
1 18-7143	Mercury Marine	27-58025	449, 858	1 18-7178	Volvo	125017	993
1 18-7143	Mercury Marine	391-5081	449, 858	1 18-7179	Volvo	925054	993
1 18-7143	OMC	322501	350, 933	1 18-7180	Mercury Marine	12-31060	449, 858
1 18-7143	OMC	331188	350, 933	1 18-7180	Mercury Marine	25-26802	449, 858
1 18-7143	Volvo	3852169	350, 933	1 18-7180	Mercury Marine	25-8M2000926	449, 858
1 18-7144	OMC	326849	350, 933	1 18-7180	OMC	303347	350, 933
1 18-7145	Mercury Marine	25-64068	449, 858	1 18-7180	Volvo	925055	993
1 18-7145	OMC	333572	350, 933	1 18-7181	Volvo	925091	975, 993
1 18-7146	Mercury Marine	25-47632	449, 858	1 18-7181	Volvo	975672	975, 993
1 18-7146	OMC	554545	350, 933	1 18-7182	Volvo	925092	471, 993
1 18-7147-9	Volvo	949658-9	993	1 18-7183	Volvo	925093	471, 993
1 18-7149	Volvo	955989	237, 993	1 18-7184	Volvo	925256	993
1 18-7150	OMC	303598	350, 933	1 18-7186	Volvo	925259	993
1 18-7150	OMC	331380	350, 933	1 18-7187	Volvo	925261	993
1 18-7150	OMC	334913	350, 933	1 18-7188	Mercury Marine	25-805726	449, 859
1 18-7151	Mercury Marine	25-20081	449, 858	1 18-7188	Volvo	955983	993
1 18-7151	Mercury Marine	25-39572	449, 858	1 18-7190	Volvo	925065	993
1 18-7152	Mercury Marine	25-20863	449, 858	1 18-7192	Volvo	955995	993
1 18-7152	OMC	307082	350, 933	1 18-7193	Volvo	955974	993
1 18-7153	Mercury Marine	25-20679	449, 858	1 18-7194	Volvo	956000	993
1 18-7153	Mercury Marine	25-25439	449, 858	1 18-7195	Mercury Marine	25-8M0027717	449, 859
1 18-7153	Mercury Marine	25-F53795-1	449, 858	1 18-7198	Honda	91353-ZW1-003	250
1 18-7153	Mercury Marine	F53795	449, 858	1 18-7198	Mercury Marine	25-45710	449, 858
1 18-7153	OMC	911851	350, 933	1 18-7198	OMC	308626	350, 933
1 18-7153	OMC	3852565	350, 933	1 18-7200	Crusader	45303	599
1 18-7154	Volvo	949656	993	1 18-7200	Mercury Marine	1397-2060	721
1 18-7155	Mercury Marine	25-26855	449, 858	1 18-7200	OMC	381389	882
1 18-7155	OMC	305270	350, 933	1 18-7200	Volvo	841634-9	957
1 18-7156	Mercury Marine	25-29439	449, 858	1 18-7200			566
1 18-7156	OMC	309731	350, 933	1 18-72000	Mercury Marine	1395-9594	378

1 This product is priced per piece. To order, priced per package, please add -9 to the part number
 2 Items ending in "D" are display packaged - regular number is non-display
 3 For discount shop pack of 10, please add -10 to the part number

SIERRA #	O.E.M.	O.E. #	PAGE #	SIERRA #	O.E.M.	O.E. #	PAGE #
SIERRA							
18-72005			846	18-725-2000			106
18-7201	Mercury Marine	1397-3327	721	18-7254	Chrysler Force	3745414	149, 578
18-7201	Mercury Marine	1397-8546	721	18-7254	Chrysler Inboard	3745414	149, 578
18-7201	Mercury Marine	1397-8959	721	18-725-4000			106
18-7201	OMC	383087	882	18-7255	Chrysler Force	3745415	149, 578
18-7201	OMC	983871	882	18-7255	Chrysler Inboard	3745415	149, 578
18-7201			566, 577, 599	18-7256	Crusader	32722	149, 599
18-7202	Mercury Marine	1397-5837	721	18-7256	Mercury Marine	32722	149, 725
18-7202	Mercury Marine	3302-9031	721	18-7256			883
18-7202			599, 957	18-7258	GM	6414989	150
18-7208	Mercury Marine	1395-8673	378	18-7258	OMC	380986	150
18-7208	Mercury Marine	1395-8983	378	18-7260			149, 567, 599
18-7209	Mercury Marine	1395-9293	378	18-7264	Chrysler Force	1736073	149, 578
18-7210	OMC	382363	268	18-7264	Chrysler Force	2279913	149, 578
18-7211-1	Mercury Marine	1395-8112231	377	18-7264	Chrysler Inboard	1736073	149, 578
18-7212	Mercury Marine	1395-811357	377	18-7264	Chrysler Inboard	2279913	149, 578
18-7212	Mercury Marine	1395-9179	377	18-7265	Chris-Craft	16.83-08758	149, 567
18-7212	Mercury Marine	1395-9377	377	18-7265	Chris-Craft	F18308762	149, 567
18-7212	Mercury Marine	1395-9645	377	18-7265			567, 883
18-7212	Mercury Marine	1395-9725	377	18-72656	Nissan/Tohatsu	332600052M	459
18-7212	Mercury Marine	1395-9761	377	18-72656	Nissan/Tohatsu	332600060M	459
18-7212	Mercury Marine	1395-97611	377	18-7266			149, 725
18-7212	Mercury Marine	1395-9803	377	18-7267	Mercury Marine	54552	149, 725
18-7213	Mercury Marine	8107492	377	18-7267	Mercury Marine	62092	149, 725
18-7214	Mercury Marine	8107493	377	18-7267	Mercury Marine	62092	149, 725
18-7215	Mercury Marine	1395-9024	377	18-7267	Mercury Marine	62092T	149, 725
18-7216	Mercury Marine	809449A1	Obsolete	18-7267	OMC	982063	149, 883
18-7219	OMC	431897	267	18-7267			599, 628
18-7219	OMC	439073	267	18-7268	OMC	981650	149, 883
18-7221	OMC	435442	267	18-7268	Volvo	3855276	149, 958
18-7221	OMC	438996	267	18-7268			599
18-7222	OMC	392061	267	18-7270	Crusader	21140	149, 600
18-7222	OMC	396701	267	18-7271	Crusader	21141	151
18-7222	OMC	398729	267	18-7272	Crusader	97039	149, 600
18-7223	OMC	391305	268	18-7272			567
18-7223	OMC	391937	268	18-7274	Mercury Marine	71646	149, 725
18-7223	OMC	398452	268	18-7274	Mercury Marine	78485	149, 725
18-7223	OMC	398453	268	18-7274	Mercury Marine	86246	149, 725
18-7223	OMC	439072	268	18-7274	Mercury Marine	86246A1	149, 725
18-7226	Mercury Marine	1395-9650	377	18-7274	Mercury Marine	86246T	149
18-7227	Mercury Marine	1396-4148	721	18-7274	OMC	509409	149
18-7227	Pleasurecraft	RN0067	626	18-7275	Mercury Marine	46860	149, 725
18-7228	Mercury Marine	85784A1	724	18-7275	Mercury Marine	63196	149, 725
18-7229	Mercury Marine	85785-2	724	18-7275	Mercury Marine	78820	149, 725
18-7229	Mercury Marine	85785T	724	18-7275	Mercury Marine	86247	149, 725
18-7229	OMC	981566	884	18-7275	Mercury Marine	86247A2	149, 725
18-7229	OMC	986865	884	18-7275	Mercury Marine	86247T	149, 725
18-7229	Volvo	3854026	958	18-7275	OMC	509410	149
18-7230	Chrysler Inboard	4142886	578	18-7278	Mercury Marine	47585	149, 725
18-7230	Mercury Marine	41639	724	18-7278	Mercury Marine	71327	149, 725
18-7230	Mercury Marine	41639A1	724	18-7278	Mercury Marine	77594	149, 725
18-7231	Crusader	97214	599	18-7278	Mercury Marine	86234	149, 725
18-7231	Crusader	97595	599	18-7278	Mercury Marine	86234A05	149, 725
18-7231	Mercury Marine	85785A2	724	18-7278	Mercury Marine	86234A3	149, 725
18-7232	Crusader	33628	599	18-7278	Mercury Marine	86234A4	149, 725
18-7232	Mercury Marine	57882	646, 724	18-7278	OMC	509395	149
18-7232	Mercury Marine	57882T	646, 724	18-7278	OMC	982240	149, 883
18-7233	Mercury Marine	1395-7824	378	18-7278	OMC	985602	149, 883
18-7234	Mercury Marine	805016A1	724	18-7278	OMC	985603	149, 883
18-7235	OMC	986783	881	18-7278			567
18-7236	OMC	986782	881	18-7281	Volvo	826493	149, 958
18-7237	OMC	986784	881	18-7282	Mercury Marine	42725A3	149, 725
18-7237	OMC	986799	881	18-7282	Mercury Marine	861676T09	149, 725
18-7237			957	18-7282	OMC	509407	149
18-7238	OMC	986796	881	18-7283	Mercury Marine	97401	149, 725
18-7238	Volvo	3854020	957	18-7283	Mercury Marine	861678A1	149, 725
18-7239	OMC	986800	881	18-7283	Mercury Marine	861678A1	149, 725
18-7241	OMC	986804	881	18-7283	Mercury Marine	8M0058164	149, 725
18-7241	Volvo	3855017	957	18-7283	Mercury Marine	97401A2	149, 725
18-7242	OMC	987313	881	18-7283	Mercury Marine	97401A8	149, 725
18-7242	Volvo	3854105	957	18-7283	OMC	509404	149
18-7243	OMC	987315	881	18-7284	Mercury Marine	41141A2	149, 725
18-7244	OMC	987317	881	18-7284	Mercury Marine	862077A1	149, 725
18-7244	Volvo	3854106	957	18-7284	OMC	509408	149
18-7245	OMC	987319	881	18-7286	Volvo	841161	150, 958
18-7245	Volvo	3854107	957	18-7288-1	Mercury Marine	97399	150, 725
18-7246	OMC	987438	881	18-7288-1	Mercury Marine	812454A1	150, 725
18-7246	OMC	987440	881	18-7288-1	Mercury Marine	812454A3	150, 725
18-7246	OMC	987485	881	18-7288-1	Mercury Marine	862048A1	150, 725
18-7246	Volvo	3854116	957	18-7288-1	Mercury Marine	97399A2	150, 725
18-7247	OMC	435442	267	18-7289	OMC	982997	150, 883
18-7247	OMC	438996	267	18-7290	Mercury Marine	84419M	377
18-7248	OMC	435676	268	18-7290	Nissan/Tohatsu	345871224M	457
18-7248	OMC	435677	268	18-7290	Yamaha	696-W0093-02-00	483
18-7248	OMC	435678	268	18-7291	Mercury Marine	84475M	377
18-7248	OMC	435752	268	18-7291	Nissan/Tohatsu	346871220M	457
18-7248	OMC	437327	268	18-7291	Yamaha	6H1-W0093-01-00	483
18-7248	OMC	439078	268	18-7293	Mercury Marine	92520M	377
18-7248	OMC	439079	268	18-7293	Yamaha	6A1-W0093-01-00	483
18-7249	Mercury Marine	19273	378	18-7295	Mercury Marine	1395-9022	378
18-72510			847	18-7296	OMC	315232	268

1 This product is priced per piece. To order, priced per package, please add -9 to the part number
 2 Items ending in "D" are display packaged - regular number is non-display
 3 For discount shop pack of 10, please add -10 to the part number

SIERRA #	O.E.M.	O.E. #	PAGE #	SIERRA #	O.E.M.	O.E. #	PAGE #
SIERRA							
1	18-7300		988	18-7375N	Mer cruiser	3310-864942A01	152, 714
1	18-7306	Volvo	988	18-7376N	Mer cruiser	3310-861245A1	152, 714
	18-73131	Mercury	831	18-7376N	Mer cruiser	3310-864943A01	152, 714
1	18-7321	Mercury Marine	835	18-7380	Mercury	809569	378
1	18-7321	Mercury Marine	835	18-7381	Mercury	16253	378
1	18-7321	Mercury Marine	835	18-7382	Mercury	804184	378
	18-7326	Mercury Marine	150, 725	18-7388	Yamaha	6G1-24411-00-00	487
	18-7326	Mercury Marine	150, 725	18-7389	Yamaha	6E0-24411-00-00	487
	18-7326	Mercury Marine	150, 725	18-73891	Yamaha	68D-G5987-00-00	533
	18-7326	Mercury Marine	150, 725	18-73892	Yamaha	6L5-45616-00-00	534
	18-7326	Mercury Marine	150, 725	18-73893	Yamaha	91490-25030-00	533
	18-7326	Mercury Marine	150, 725	18-7390	Yamaha	63V-24411-00-00	487
	18-7326	OMC	150, 884	18-73907	Yamaha	90171-14056-00	534
	18-7326	OMC	150, 884	18-7391	Yamaha	692-24411-00-00	487
	18-7326	OMC	150, 884	18-73914	Yamaha	670-45997-02-00	533
	18-7326	OMC	150, 884	18-73918	Yamaha	63P-45987-00-00	533
	18-7326	Volvo	150, 958	18-7392	Yamaha	67E-14985-01-00	485
	18-7326	Volvo	150, 958	18-7393	Yamaha	6E7-14385-00-00	485
	18-7326	Volvo	150, 958	18-7394	Racor	RK10012	137
	18-7326	Volvo	150, 958	18-73964	Nissan/Tohatsu		459
	18-7330	OMC	150, 884	18-73978	Yamaha	90201-08M54-00	533
	18-7330	OMC	150, 884	18-73979	Yamaha	6L2-45987-01-00	533
	18-7330	OMC	150, 884	18-73990	Yamaha	6H4-W4599-00-00	533
	18-7330	OMC	150, 884	18-73993	Yamaha		533
	18-7330	Volvo	150, 958	18-73994	Yamaha		534
	18-7330	Volvo	150, 958	1	18-7400	Mercury Marine	25-818573
	18-7330	Volvo	150, 958	1	18-7400	OMC	908194
	18-7330	Volvo	150, 958	1	18-7401	OMC	908383
	18-7331	OMC	150, 884	1	18-7403	OMC	909316
	18-7331	OMC	150, 884	1	18-7404	OMC	909747
	18-7331	OMC	150, 884	1	18-7406	OMC	911311
	18-7331	Volvo	150, 958	1	18-7406	Volvo	3852523
	18-7331	Volvo	150, 958	1	18-7407	OMC	911700
	18-7331	Volvo	150, 958	1	18-7407	OMC	3852531
	18-7332		150, 647	1	18-7407	Volvo	3852531
	18-7333		150	1	18-7408	OMC	911718
	18-7334	Yamaha	487	1	18-7409	OMC	911871
	18-7334	Yamaha	487	1	18-7410	Mercury Marine	25-36390
	18-7334	Yamaha	487	1	18-74108	OMC	5030973
	18-7334	Yamaha	487	1	18-7411	Mercury Marine	25-35480
	18-7334	Yamaha	487	1	18-7411	Mercury Marine	25-47386
	18-7334	Yamaha	487	1	18-7411	Mercury Marine	25-8M2000816
	18-7334	Yamaha	487	1	18-7411	OMC	321921
	18-7334	Yamaha	487	1	18-7413	Mercury Marine	22-22175
	18-7340	Yamaha	487	1	18-7413	Mercury Marine	25-62702
	18-7340	Yamaha	487	1	18-7413	Mercury Marine	25-F50342-1
	18-7340	Yamaha	487	1	18-7413	Mercury Marine	F17510
	18-7340	Yamaha	487	1	18-7413	Mercury Marine	F50342
	18-7341	Yamaha	487	1	18-7413	OMC	303191
	18-7342	Yamaha	487	1	18-7414	Mercury Marine	25-62384
	18-7342	Yamaha	487	1	18-7414	Mercury Marine	25-823683
	18-7343	Yamaha	487	1	18-7415	Mercury Marine	25-64966
	18-7349	Yamaha	487	1	18-7416	OMC	329380
	18-7349	Yamaha	487	1	18-7417	OMC	329381
	18-7349	Yamaha	487	1	18-7418	OMC	326741
	18-7349	Yamaha	487	1	18-7419	Mercury Marine	25-69202
	18-7349	Yamaha	487	1	18-7420	Mercury Marine	25-21836
	18-7349	Yamaha	487	1	18-7421	Mercury Marine	25-16524
	18-7350	OMC	270	1	18-7426	Mercury Marine	25-30271
	18-7350	OMC	270	1	18-7428	OMC	307103
	18-7350	OMC	270	1	18-7432	Yamaha	93210-32738-00
	18-7350	OMC	270	1	18-7436	Yamaha	93210-46044-00
	18-7351	OMC	270	1	18-7439-9	Yamaha	93210-54M54-00
	18-7352	OMC	270	1	18-7440-1	Mercury Marine	25-36318
	18-7352	OMC	270	1	18-7440-1	OMC	301967
	18-7352	OMC	270	1	18-7442	Yamaha	93210-74M35-00
	18-7352	OMC	270	1	18-7444	Yamaha	93211-04384-00
	18-7352	OMC	270	1	18-7445	Mercury Marine	25-55801
	18-7352	OMC	270	1	18-7449	Mercury Marine	25-97387
	18-7352	OMC	270	1	18-74501	Mariner	27-99049M
	18-7352	OMC	270	1	18-74501	Yamaha	683-W0001-C1-00
	18-7352	OMC	270	1	18-74504	Yamaha	6H3-W0001-22-00
	18-7352	OMC	270	1	18-74507	Yamaha	63V-W0001-21-00
	18-7353	OMC	270	1	18-74510	Yamaha	65L-W0001-C0-00
	18-7353	OMC	270	1	18-74512	Yamaha	66K-W0001-20-00
	18-7354	Mercury Marine	377	1	18-74515	Yamaha	68V-W0001-20-00
	18-7355	Mercury Marine	377	1	18-74527	Yamaha	6G9-W0001-C6-00
	18-7356	Mercury Marine	377	1	18-74535	Yamaha	67F-W0001-20-00
	18-7367	Yamaha	488	1	18-74540	Yamaha	62Y-W0001-20-00
	18-7368	Yamaha	488	1	18-74544	Yamaha	68T-W0001-20-00
	18-7369	Yamaha	488	1	18-74546	Yamaha	
	18-7370N	Mer cruiser	152, 714	18-7457	Chrysler Force	25-F45530	239
	18-7370N	Mer cruiser	152, 714	18-7457	OMC	319662	350, 933
	18-7370N	Mer cruiser	152, 714	18-7459	Mercury Marine	20311	449, 859
	18-7370N	Mer cruiser	152, 714	18-7459	Mercury Marine	25-20826	449, 859
	18-7370N	Mer cruiser	152, 714	18-7461	OMC	308458	350, 933
	18-7370N	Mer cruiser	152, 714	18-74610	Nissan/Tohatsu	398873213M	458
	18-7370N	Mer cruiser	152, 714	18-74611	Nissan/Tohatsu	346873217M	458
	18-7373N	Mer cruiser	152, 714	18-7463	Yamaha	93210-19123-00	550
	18-7375N	Mer cruiser	152, 714	18-7464	Mercury Marine	25-39695	449, 859
	18-7375N	Mer cruiser	152, 714	18-7464	Mercury Marine	25-846361	449, 859

1 This product is priced per piece. To order, priced per package, please add -9 to the part number
 2 Items ending in "D" are display packaged - regular number is non-display
 3 For discount shop pack of 10, please add -10 to the part number

SIERRA #	O.E.M.	O.E. #	PAGE #	SIERRA #	O.E.M.	O.E. #	PAGE #
SIERRA							
1	18-7467	Mercury Marine	25-54030	449, 859	18-7608-1	Rochester	7043184 153
1	18-7467	Mercury Marine	25-F523555	449, 859	18-7608-1	Rochester	17059052 153
1	18-7467	Mercury Marine	F532555	449, 859	18-7608-1	Rochester	17059057 153
	18-7468	Yamaha	6G5-43864-00-00	550	18-7609-1	Mercury Marine	1347-818619 153, 714
	18-7469	Yamaha	64E-43869-00-00	550	18-7609-1	Mercury Marine	1347-818619 1 153, 714
	18-7470	Yamaha	65W-43865-00-00	550	18-7609-1	Mercury Marine	1347-818619 1R02 153, 714
	18-7471	Yamaha	93210-94003-00	550	18-7609-1	OMC	381494 156, 879
	18-7474	Mercury Marine	25-94288	449, 859	18-7609-1	OMC	382733 156, 879
1	18-7475	OMC	332584	350, 933	18-7609-1	OMC	772831 156, 879
1	18-7477	OMC	909048	350, 933	18-7609-1	OMC	980530 156, 879
1	18-7480	Pleasurecraft	R047111	628	18-7609-1	OMC	982217 156, 879
	18-74805	Mercury	27-804908A00	Obsolete	18-7609-1	OMC	984180 156, 879
	18-74805	Nissan/Tohatsu	3B2873214M	Obsolete	18-7609-1	Rochester	7036543 153
1	18-7481	OMC	324981	314	18-7609-1	Rochester	7040082 153
	18-7483	Yamaha	93210-37M67-00	550	18-7609-1	Rochester	7041369 153
	18-7484	Yamaha	65W-43871-00-00	482	18-7609-1	Rochester	7043182 153
	18-7485	Yamaha	93210-86M38-00	550	18-7609-1	Rochester	7044182 153
	18-7486	Yamaha	61A-24564-00-00	491	18-7609-1	Rochester	17059054 153
	18-7487	Yamaha	65L-24564-00-00	491	18-7610-1	Mercury Marine	1347-818621 153, 714
	18-7488	Yamaha	6P3-24564-00-00	491	18-7610-1	Mercury Marine	1347-818621 1 153, 714
	18-7489	Mallory	9-34081	648	18-7610-1	Mercury Marine	1347-818621 1R02 153, 714
	18-7492	Volvo	3854161	941	18-7610-1	Rochester	17081060 153
	18-7493	Mercury Marine	392889925	680	18-7611-2	Mercury Marine	3310-807312R02 153, 714
	18-7493	Volvo	3859078	941	18-7611-2	Mercury Marine	3310-807312A1 153, 714
	18-7494	Honda	30520-PNA-007	240	18-7613-1	Mercury Marine	3310-806969 R01 153, 714
	18-7508	Mercury Marine	16792A33	791	18-7613-1	Mercury Marine	3310-806969A1 153, 714
	18-7508	Mercury Marine	16792A39	791	18-7615-1	Mercury Marine	1347-804624 R02 153, 714
1	18-7510	OMC	321163	350, 933	18-7615-1	Mercury Marine	1347-804624R1 153, 714
	18-75100	Mercury Marine	32-8M0062614	755	18-7615-1	Mercury Marine	1347-816373A4 153, 714
	18-75100	OMC	910305	893	18-7615-1	OMC	981359 153, 879
	18-75100	OMC	912424	893	18-7615-1	OMC	981428 153, 879
	18-75100	OMC	913488	893	18-7615-1	OMC	981564 153, 879
	18-75100			966	18-7615-1	OMC	981705 153, 879
	18-7511-9	Yamaha	93210-16716-00	550	18-7615-1	OMC	981803 153, 879
	18-7512	Chrysler Inboard	7087-OR	588	18-7615-1	OMC	982223 153, 879
	18-75125	Mercury Marine	32-5346170	755	18-7615-1	OMC	983855 153, 879
	18-75125	Mercury Marine	32-865672070	755	18-7615-1	OMC	985822 153, 879
	18-75125	Mercury Marine	32-8M0062665	755	18-7615-1	Rochester	17057298 153
	18-75125	OMC	912793	893	18-7615-1	Rochester	17059280 153
	18-75125	Volvo	826423	966	18-7615-1	Rochester	17059288 153
	18-75125	Volvo	845792	966	18-7615-1	Rochester	17080561 153
	18-7513	Volvo	3862500	19, 962	18-7615-1	Rochester	17085013 153
	18-7550	Mercury	861249	709	18-7615N	Mercuriser	152, 156, 714, 879
	18-7550	Mercury	861249A1	709	18-7616-1	Mercury Marine	1347-804626 R02 153, 715
	18-7551	Mercury	861425	710	18-7616-1	Mercury Marine	1347-8288A1 153, 715
	18-7552	Honda	37830-PGK-A01	243	18-7616-1	Rochester	1708563 153
	18-7553	Mercury	808015T	710	18-7616-1	Rochester	17057287 153
	18-7554	Mercury	878187	710	18-7616-1	Rochester	17059287 153
	18-7556	Mercury	864297001	680	18-7616-1	Rochester	17059290 153
	18-7558	Honda	30530-PPL-A01	243	18-7616-1	Rochester	17080560 153
	18-7559	Honda	30530-P8F-A01	243	18-7617-1	Mercury Marine	1347-804625R02 153, 715
	18-7598			145	18-7617-1	Mercury Marine	1347-804625R1 153, 715
	18-7599			145, 242, 385	18-7617-1	Mercury Marine	1347-9863A3 153, 715
	18-7600	Crusader	47002	598	18-7617-1	Rochester	17059280 153
	18-7600	Mercury Marine	805218T	709	18-7618-1	Mercury Marine	1347-804624 R1 153, 715
	18-7601	OMC	3854158	878	18-7618-1	Mercury Marine	1347-804624R02 153, 715
	18-7601	Volvo	3854158	962	18-7618-1	Mercury Marine	1347-8289A1 153, 715
	18-7603-1	Mercury Marine	1347-818622	153, 714	18-7618-1	Rochester	7044291 153
	18-7603-1	Mercury Marine	1347-818622 1	153, 714	18-7618-1	Rochester	17059289 153
	18-7603-1	Mercury Marine	1347-818622R02	153, 714	18-7618-1	Rochester	17080561 153
	18-7603-1	Mercury Marine	1376-5659A1	153, 714	18-7618-1	Rochester	17080562 153
	18-7603-1	Rochester	7044185	153	18-7619-1	Mercury Marine	1347-8460A3 153, 715
	18-7604-1	Mercury Marine	1347-804623R02	153, 714	18-7619-1	Mercury Marine	1347-9142A2 153, 715
	18-7604-1	Mercury Marine	1347-804623R1	153, 714	18-7619-1	Rochester	17059283 153
	18-7604-1	Mercury Marine	3304-9354A2	153, 714	18-7619-1	Rochester	17059298 153
	18-7605-1	Mercury Marine	1347-804623A1	153, 714	18-7619-1	Rochester	17081299 153
	18-7605-1	Mercury Marine	1347-804623R02	153, 714	18-7619-1	Rochester	17083522 153
	18-7605-1	Mercury Marine	1347-9661A3	153, 714	18-7627		Obsolete
	18-7605-1	OMC	382821	156, 879	18-7628		152, 648
	18-7605-1	OMC	383766	156, 879	18-7630	Crusader	47032 598
	18-7605-1	OMC	384194	156, 879	18-7630	Mercury Marine	805226A1 709
	18-7605-1	Rochester	17057283	153	18-7632	Crusader	47033 S/S to 18-7632-1
	18-7605-1	Rochester	17057285	153	18-7632	Mercury Marine	805224A1 S/S to 18-7632-1
	18-7605-1	Rochester	17059291	153	18-7632-1	Crusader	47033 598
	18-7605-1	Rochester	17059292	153	18-7632-1	Mercury Marine	805224A1 709
	18-7605-1	Rochester	17080564	153	18-7633	Mercury Marine	17693A2 850
	18-7605-1	Rochester	17080565	153	18-7633	Mercury Marine	63115A12 850
	18-7606	Yamaha	MAR-10171-30-00	494	18-7633	Mercury Marine	805320A03 850
	18-7607-1	Rochester	17082403	153	18-7633	Mercury Marine	805320A1 850
	18-7608-1	Mercury Marine	1347-818620	153, 714	18-7633	Mercury Marine	88678A4 850
	18-7608-1	Mercury Marine	1347-818620 1	153, 714	18-7633	Mercury Marine	88678A5 850
	18-7608-1	Mercury Marine	1347-818620R02	153, 714	18-7633	Mercury Marine	96863A15 850
	18-7608-1	OMC	381668	156, 879	18-7634	OMC	984748 927
	18-7608-1	OMC	980528	156, 879	18-7635		152, 879
	18-7608-1	OMC	982217	156, 879	18-7636		152, 879
	18-7608-1	OMC	982219	156, 879	18-7637		152, 646, 879
	18-7608-1	Rochester	7040080	153	18-7638		152, 646, 879
	18-7608-1	Rochester	7040083	153	18-7639	Mercury Marine	3310-864943A01 153, 714
	18-7608-1	Rochester	7040089	153	18-7639	Mercury Marine	861245A1 153, 714
	18-7608-1	Rochester	7042183	153	18-7640		152, 714, 879
	18-7608-1	Rochester	7043183	153	18-7641	Volvo	3856393 956

1 This product is priced per piece. To order, priced per package, please add -9 to the part number

2 Items ending in "D" are display packaged - regular number is non-display

3 For discount shop pack of 10, please add -10 to the part number

SIERRA #	O.E.M.	O.E. #	PAGE #	SIERRA #	O.E.M.	O.E. #	PAGE #
SIERRA							
18-7641	Volvo	841047-4	956	18-7714	Mercury Marine	35-877565T	389
18-7641	Volvo	841313-0	956	18-7714	Mercury Marine	35-877565T1	389
18-7642	Volvo	3863130	941	18-7715	Mercury Marine	35-892665	733
18-7643	Volvo	3859082	941	18-7716	OMC	5032323	274
18-7646	Mercury Marine	892615	710	18-7716	Suzuki	15410-87J10	463
18-7646	Mercury Marine	892615001	710	18-7717	Mercury Marine	35-93568	733
18-7646	Mercury Marine	892615002	710	18-7717			600, 733, 887, 962
18-7646	Pleasurecraft	R020035A	627	18-7718	Mercury Marine	35-879885T	389
18-7647	Volvo	872066	962	18-7719	OMC	5032328	274
18-7648	Mercury Marine	392-881732	680	18-7719	Suzuki	15410-98500	463
18-7648	Pleasurecraft	R117012	625	18-7720	Honda	16900-SR3-004	241
18-7648	Volvo	3861267	941	18-7721	Mercury Marine	35-864572	733
18-7655	Yamaha	67H-8592A-00-00	494	18-7722	OMC	5005266	274
18-7655	Yamaha	67H-8592A-01-00	494	18-7723			140
18-7656	Yamaha	68F-8592A-00-00	494	18-7724			140
18-7657	Honda	35655-ZY3-013	243	18-7725			577, 598
18-7658	Honda	35655-ZY9-003	243	18-7726			577
18-7659	Honda	35655-ZY6-013	243	18-7727			881
18-7660	Mercury Marine	881731	709	18-7728			720
18-7660	Mercury Marine	8M0054726	709	18-7729			881
18-7663	Mercury Marine	802630	709	18-7730			881
18-7663	Mercury Marine	802630001	709	18-7732	Zenith	K-2035	566
18-7663	Mercury Marine	802630T	709	18-7732	Zenith	K-2036	566
18-7663	Mercury Marine	802630T01	709	18-7735	Suzuki	15410-94400	463
18-7663	Mercury Marine	8M0069803	709	18-7736	Yamaha	67D-W0093-00-00	483
18-7664	Mercury Marine	809066	721	18-7737	Yamaha	61N-W0093-00-00	483
18-7665	Mercury Marine	70125	721	18-7738	Mercury Marine	802706A1	377
18-7665	Mercury Marine	70125A02	721	18-7738	Yamaha	66M-W0093-00-00	483
18-7665	Mercury Marine	70125A1	721	18-7738	Yamaha	66M-W0093-01-00	483
18-7666	Mercury Marine	1397-8582	721	18-7739	Yamaha	6L2-W0093-00-00	483
18-7667	Mercury Marine	71464	721	18-7740	Yamaha	6E9-W0093-02-00	483
18-7667	Mercury Marine	72625	721	18-7741	Yamaha	6E9-W0093-03-00	483
18-7667	Mercury Marine	71464A01	721	18-7742	Yamaha	6H0-W0093-00-00	483
18-7668	Mercury Marine	854445	710	18-7743	Mercury Marine	804346T1	377
18-76689	Yamaha	65W-14198-00-00	550	18-7743	Yamaha	67F-W0093-00-00	483
18-76690	Yamaha	93210-46M16-00	550	18-7744	Yamaha	6N6-W0093-02-00	483
18-76691	Yamaha	93210-27ME3-00	550	18-7746	Mercury Marine	1397-2067	720
18-76692	Yamaha	93210-75M51-00	550	18-7746	Mercury Marine	1397-2631	720
18-76693	Yamaha	93210-31MJ5-00	550	18-7746	Mercury Marine	1397-2634	720
18-76694	Yamaha	93210-24M79	550	18-7746	Mercury Marine	1397-2637	720
18-76695	Mercury	25-803513007	449	18-7746	Mercury Marine	1397-3459	720
18-76695	Nissan/Tohatsu	3R0074220M	459	18-7746	Mercury Marine	1397-3464	720
18-7677	Mercury Marine	806612T	710	18-7746	Mercury Marine	1397-7542	720
18-7677	OMC	3850357	878	18-7746	Mercury Marine	1397-7543	720
18-7677	Pleasurecraft	R020027	627	18-7746	Mercury Marine	1397-7547	720
18-7677	Volvo	3850357	878	18-7746	Mercury Marine	1397-8872	720
18-7679	OMC	3854905	878	18-7746	Mercury Marine	1397-8873	720
18-7679	Volvo	3854905	962	18-7746	Mercury Marine	823427A1	720
18-7682	Mercury Marine	849934	709	18-7747	Yamaha	6G5-W0093-08-00	483
18-7682	Mercury Marine	879150150	709	18-7748	Mercury Marine	809064	720
18-7683	Mercury Marine	849899	709	18-7749	Mercury Marine	809065	720
18-7684	Mercury Marine	805217A1	709	18-7749	Mercury Marine	823728	720
18-7684	Mercury Marine	864856A1	709	18-7749	Mercury Marine	835076	720
18-7684	OMC	3850396	878	18-7750-1	Mercury Marine	1395-811222	378
18-7684	Volvo	3850396	962	18-7750-1	Mercury Marine	1395-823635	378
18-7685	Mercury Marine	852956A1	710	18-7750-1	Mercury Marine	1395-8236351	378
18-7685	Volvo	3858941	962	18-7750-1	Mercury Marine	1395-8236352	378
18-7688	Mercury Marine	885176	710	18-7750-1	Mercury Marine	1395-8236353	378
18-7689	OMC	3855182	878	18-7750-1	Mercury Marine	1395-8236354	378
18-7689	Volvo	3855182	962	18-7750-1	Mercury Marine	1395-9599	378
18-7690	Mercury Marine	27-852957	711	18-7751	Mercuriser	13220	646, 719
18-7691	Mercury Marine	806807A1	711	18-7752	Suzuki	13910-87D00	463
18-7692	Mercury Marine	861260	711	18-7753	Suzuki	13910-94400	463
18-7692	Mercury Marine	861260T	711	18-7754	Suzuki	13910-94701	463
18-7693			711	18-7755	Suzuki	13910-95D00	463
18-7694			711	18-7756	Yamaha	64D-W0093-00-00	483
18-7695			711	18-7757	Mercury Marine	803148	710
18-7696			711	18-7757	Volvo	3855296	941
18-7697	Mercury Marine	803149	709	18-7758	Mercury Marine	35-877761K01	183, 411
18-7697	Pleasurecraft	R084003	627	18-7758	Mercury Marine	35-877761Q01	183, 411
18-7698	Mercury Marine	881693002	710	18-7759	Yamaha	6K7-W0093-09-00	483
18-7700	Mercury Marine	853678T	709	18-7761			267, 462
18-7700	Volvo	3857487	962	18-7765	Mercury Marine	11502M	378
18-7701	Mercury Marine	862998	709	18-7765	Nissan/Tohatsu	369871221M	457
18-7702	Mercury Marine	805223T	751	18-7765	Yamaha	6G1-W0093-00-00	483
18-7702	Volvo	3854527	962	18-7766	Yamaha	6H3-W0093-02-00	484
18-7703	Mercury Marine	805544T	710	18-7767	Yamaha	6H4-W0093-01-00	484
18-7703	OMC	3854512	878	18-7768	Yamaha	6H4-W0093-03-00	484
18-7703	Volvo	3854512	962	18-7769	Mercury Marine	814481M	378
18-7704	Volvo	3855194	962	18-7769	Yamaha	6E7-W0093-04-00	484
18-7705	Volvo	3843751	962	18-7770	Mercury Marine	84456M	378
18-7706	Volvo	3858979	941	18-7770	Yamaha	689-W0093-02-00	484
18-7708	Volvo	3808516	941	18-7772	Yamaha	61A-W0093-00-00	484
18-7709	Volvo	3840335	961	18-7772	Yamaha	61A-W0093-01-00	484
18-7710-1	Yamaha	68T-24251-00-00	491	18-7773	OMC	5032424	267
18-7711	Suzuki	15410-96J00	463	18-7773	Suzuki	13910-89J01	462
18-7712	Honda	16910-GB2-005	242	18-7774			89, 138, 273, 388, 490, 732, 886, 960
18-7712	Mercury Marine	35-16248	389				
18-7712	Nissan/Tohatsu	369022300M	457	18-7775			89, 136, 273, 387, 489,
18-7713	Mercury Marine	35-80365M	389				646, 730, 884, 959
18-7713	Yamaha	646-24251-02-00	491	18-7775-1			136, 272, 387, 489,

1 This product is priced per piece. To order, priced per package, please add -9 to the part number

2 Items ending in "D" are display packaged - regular number is non-display

3 For discount shop pack of 10, please add -10 to the part number

SIERRA #	O.E.M.	O.E. #	PAGE #	SIERRA #	O.E.M.	O.E. #	PAGE #
SIERRA							
18-7775-1			731, 885, 959	18-7824-2	OMC	173232, 502902	183, 902
18-7776			89, 136, 273, 387, 489,	18-7824-2	OMC	173232, 502902	183, 902
			646, 730, 884, 959	18-7824-2	Pleasurecraft	R077002	183, 902
18-7776-1			136, 272, 387, 489,	18-7824-2	Volvo	835440	183, 977
			731, 885, 959	18-7824-2	Yamaha	YSC-10231-20-OC	183
18-7777	Yamaha	MAR-FLTHD-SS-12	136, 489	18-7824-2	Yamaha	YSC-13231-20-OC	995
18-7777			89, 136, 273, 387,	18-7824C-1			S/S to 18-7824C-2
			489, 884, 959	18-7824C-2			647
18-7777-1	Yamaha	ABB-SPRTR-HD-SS	136, 489	18-7826	OMC	305185	274
18-7777-1			272, 387, 731,	18-7828-1			140, 274, 354,
			885, 959				390, 457, 491
18-7778	Volvo	3850861	138, 960	18-7829	Mercury Marine	35-16494	140, 390
18-7780	Yamaha	6F5-24563-00-00	491	18-7829	Mercury Marine	35-816296	140, 390
18-7781	Yamaha	61N-24563-00-00	491	18-7829	Mercury Marine	35-816296K03	140, 390
18-7782	Yamaha	61A-24563-00-00	491	18-7829	Mercury Marine	35-816296Q	140, 390
18-7783	Volvo	273663	670	18-7829	Mercury Marine	35-816296T	140, 390
18-7784	Mercury Marine	35-11004A1	733	18-7829			274, 354, 457, 491
18-7784	Mercury Marine	35-803897Q1	733	18-7830	Mercury Marine	35-134301	140, 390
18-7785	Honda	16010-ST5-993	241	18-7830	Mercury Marine	35-164941	140, 390
18-7786	Honda	16900-SA5-004	241	18-7830	Mercury Marine	35-8162961	140, 390
18-7787			487	18-7830	Mercury Marine	35-816296-1	140, 390
18-7788			487	18-7830	Mercury Marine	35-816296B1	140, 390
18-7789	OMC	502906	138, 274, 886	18-7830	Mercury Marine	35-816296B2	140, 390
18-7789	Volvo	3852413	138, 960	18-7830	Mercury Marine	35-816296Q2	140, 390
18-7789	Volvo	3851218-2	138, 960	18-7830	Mercury Marine	35-816296T1	140, 390
18-7790			140, 647	18-7830	Mercury Marine	35-816396Q1	140, 390
18-7791			140, 647	18-7830	OMC	398327	274
18-7792	OMC	910641	886	18-7830	Yamaha	65W-24251-10-00	491
18-7792	OMC	3855104	886	18-7830			140, 354, 457
18-7792	Volvo	3855104	961	18-7831	Mercury Marine	802128A1	140, 390
18-7796	OMC	335334	271	18-7831	OMC	398319	140, 274
18-7797			488	18-7831			354, 457
18-7798			488	18-7832	Mercury Marine	1399-1136	389
18-7799			488	18-7832	Mercury Marine	1399-1754	389
18-7800	OMC	433519	270	18-7832	Mercury Marine	1399-3938	389
18-7800	OMC	438616	270	18-7833	Mercury Marine	11497M	382
18-7801	OMC	379777	270	18-7833	Yamaha	6G1-24471-00-00	488
18-7802	Mercury Marine	35-87946A3	389	18-7834	Mercury Marine	91748M	382
18-7802	Mercury Marine	35-87946Q3	389	18-7834	Yamaha	6E0-24471-00-00	488
18-7802	Mercury Marine	35-87946Q4	389	18-7837	Mercury Marine	84262M	382
18-7804	Mercury Marine	23014A1	382	18-7837	Yamaha	677-24411-02-00	488
18-7805	Chrysler Force	F24747-1	225	18-7838	Mercury Marine	84265M	382
18-7806-1			225, 382	18-7838	Yamaha	677-24471-01-00	488
18-7807	Mercury Marine	55278A1	382	18-7839	Mercury Marine	80606M	382
18-7808	Mercury Marine	55278A5	382	18-7839	Yamaha	648-24411-00-00	488
18-7809	Mercury Marine	55278A3	382	18-7840	Mercury Marine	84141M	382
18-7809	Mercury Marine	55278A4	382	18-7840	Yamaha	663-24411-00-00	488
18-7810	Mercury Marine	90363A1	382	18-7841	Yamaha	6J8-24471-00-00	488
18-7811	Mercury Marine	66599A1	382	18-7842	Yamaha	6E5-24471-00-00	487, 488
18-7811	Mercury Marine	89031A1	382	18-7843	Yamaha	6E5-24411-00-00	487, 488
18-7812	Mercury Marine	66599A2	382	18-7844	Mercury Marine	35-802893Q	136, 389, 732
18-7812	Mercury Marine	89031A2	382	18-7844	Mercury Marine	35-807172	136, 389, 732
18-7813	Mercury Marine	66599A3	382	18-7844			89, 274, 490, 886, 960
18-7813	Mercury Marine	89031A3	382	18-7845	Mercury Marine	35-55501	136, 389, 732
18-7814	Mercury Marine	89031A4	382	18-7845	Mercury Marine	35-57250	136, 389, 732
18-7815	Mercury Marine	1399-5137	378	18-7845	Mercury Marine	35-604941	136, 389, 732
18-7817	Chrysler Force	21-42990A10	225	18-7845	Mercury Marine	35-60494A4	136, 389, 732
18-7817	Chrysler Force	21-42990A7	225	18-7845	Mercury Marine	35-8053691	136, 389, 732
18-7817	Chrysler Force	21-42990A8	225	18-7845	Mercury Marine	35-806771	136, 389, 732
18-7817	Chrysler Force	21-42990A9	225	18-7845	Mercury Marine	35-807172	136, 389, 732
18-7817	Chrysler Force	21-857005A1	225	18-7845	Yamaha	ABB-FUELF-IL-TR	136, 490
18-7817	Mercury Marine	21-42990A10	382	18-7845			89, 274, 886, 960
18-7817	Mercury Marine	21-42990A7	382	18-7846	Crusader	98041	600
18-7817	Mercury Marine	21-42990A8	382	18-7846	OMC	502905	138, 274, 886
18-7817	Mercury Marine	21-42990A9	382	18-7846			960
18-7817	Mercury Marine	21-857005A1	382	18-7847			382
18-7818-1	Mercury Marine	42909A1	382	18-7848-1	Mercury Marine	52444	136, 387, 731
18-7818-1	Mercury Marine	42909A2	382	18-7848-1	Mercury Marine	35-52456A1	136, 387, 731
18-7818-1	Mercury Marine	42909A3	382	18-7848-1	Mercury Marine	35-55501A1	136, 387, 731
18-7818-1	Mercury Marine	42909A4	382	18-7848-1	Mercury Marine	35-57250A1	136, 387, 731
18-7820	OMC	393103	270	18-7848-1	Mercury Marine	35-60494A1	136, 387, 731
18-7821	OMC	395867	270	18-7848-1	Mercury Marine	35-60494A4	136, 387, 731
18-7821	OMC	398514	270	18-7848-1	Mercury Marine	35-802893Q4	136, 387, 731
18-7822	OMC	432962	270	18-7848-1	Mercury Marine	35-805369A4	136, 387, 731
18-7823	OMC	393088	271	18-7848-1	Mercury Marine	35-807172A4	136, 387, 731
18-7824-2	Chris-Craft	16.81-08746	571	18-7848-1			272, 489, 885, 959
18-7824-2	Crusader	201104	183, 612	18-7848-2			137, 272, 387, 489,
18-7824-2	Indmar	50-1001	183				731, 885, 959
18-7824-2	Mercury Marine	14957	183, 790	18-7852-1	Crusader	22687	600
18-7824-2	Mercury Marine	32716	183, 774	18-7852-1	Yamaha	MAR-SEPAR-AT-OR	136, 489
18-7824-2	Mercury Marine	32717	183, 774	18-7852-1			272, 354, 387,
18-7824-2	Mercury Marine	52022	183, 774				731, 885, 959
18-7824-2	Mercury Marine	52731	183, 774	18-7852-2			137, 387, 489, 731,
18-7824-2	Mercury Marine	54111	183, 774				885, 959
18-7824-2	Mercury Marine	35-802885Q	183, 774	18-7853-1	Mercury Marine	55481	136, 387, 730
18-7824-2	Mercury Marine	35-866340K01	183, 774	18-7853-1	Mercury Marine	89876	136, 387, 730
18-7824-2	Mercury Marine	35-866340Q	183, 774	18-7853-1	Mercury Marine	89876A3	136, 387, 730
18-7824-2	Mercury Marine	35-866340Q02	183, 774	18-7853-1	Yamaha	MAR-FLTHD-AL-12	136, 489
18-7824-2	Mercury Marine	35-866340Q02	183, 774	18-7853-1			89, 273, 884, 959
18-7824-2	Mercury Marine	35-866340Q03	183, 774	18-7854	OMC	311684	886
18-7824-2	Mercury Marine	52731A1	183, 774	18-7854	OMC	984491	886

1 This product is priced per piece. To order, priced per package, please add -9 to the part number

2 Items ending in "D" are display packaged - regular number is non-display

3 For discount shop pack of 10, please add -10 to the part number

SIERRA #	O.E.M.	O.E. #	PAGE #	SIERRA #	O.E.M.	O.E. #	PAGE #
SIERRA							
18-7854	Rochester	17078904	886	18-7890	Volvo	876185	977
18-7855	Mercury Marine	1397-2150	733	18-7891			197
18-7855	OMC	910139	889	18-7894			197
18-7855	OMC	983870	886	18-7895	OMC	778888	183, 301
18-7855	Rochester	17068453	886	18-7895	OMC	5035703	183, 301
18-7856-1	A.C. Delco	GF-61	140	18-7895	Suzuki	16510-93J00	183, 469
18-7857-1	A.C. Delco	GF-61P	140	18-7896	OMC	778886	183, 301
18-7858	Volvo	858201	139, 670, 961	18-7896	OMC	5033539	183, 301
18-7859	Mercury Marine	3302-9033	717	18-7896	Suzuki	16510-61A20-MHL	183, 469
18-7859	Mercury Marine	35-53336	717	18-7897	OMC	778887	183, 301
18-7859	Mercury Marine	35-53336Q	717	18-7897	OMC	5033919	183, 301
18-7859	OMC	908034	887	18-7897	Suzuki	16510-82703	183, 469
18-7859	Volvo	835576	961	18-79007	Volvo	3825038	962
18-7860	Chris-Craft	16.83-90006	568	18-7901	Mercury Marine	825467A	183, 411
18-7860	Mercury Marine	35-49088	733	18-7901	Mercury Marine	825467T1	183, 411
18-7860	Mercury Marine	35-49088A2	733	18-7901	Yamaha	6G8-13440-00-00	183, 517
18-7860	Mercury Marine	35-49088Q2	733	18-7902	Yamaha	3FV-13440-00-00	183, 517
18-7860	Mercury Marine	F18390006	733	18-7902	Yamaha	3FV-13440-20-00	183, 517
18-7860	OMC	312456	887	18-7903	OMC	763364	184, 301
18-7860	OMC	381690	887	18-7903	OMC	5033102	184, 301
18-7861	OMC	981911	887	18-7903	Suzuki	16510-05240	184, 469
18-7862	Crusader	91606	600	18-7905-1	Suzuki	16510-96J00	184, 469
18-7862	OMC	982230	887	18-7906-1	Mercury Marine	35-8226267	184, 411
18-7862	Volvo	841162	961	18-7906-1	Mercury Marine	35-822626Q15	184, 411
18-7865	Yamaha	MAR-MINIF-IL-TR	138, 490	18-7906-1	Mercury Marine	35-822626T7	184, 411
18-7865			89, 274, 389,	18-7906-1	Yamaha	69J-13440-00-00	184, 517
			732, 886, 960	18-7906-1	Yamaha	69J-13440-01-00	184, 517
18-7866	Yamaha	MAR-FUELF-IL-TR	136, 490, 647	18-7907	Volvo	858488	977
18-7866			89, 274, 389,	18-7908	Volvo	3582358	977
			732, 886, 960	18-7909	Honda	15400-PLM-A01PE	184, 249
18-7869	Mercury Marine	1397-8545	733	18-7909	Honda	15400-POH-305	184, 249
18-7869	Mercury Marine	1397-8767	733	18-7909	Honda	15400-POH-305PE	184, 249
18-7871	Mercury Marine	35-805809	182, 672, 790	18-7909	Honda	15400-ZJI-004	184, 249
18-7871	Mercury Marine	35-805809T	182, 672, 790	18-7910-1	Westerbeke	30220	182, 673
18-7873	Mercury Marine	35-808275	139, 670, 733	18-7910-1	Yanmar	119350-35150	182, 673
18-7874	Cummins	299670	Obsolete	18-7910-1	Yanmar	119350-35151	182, 673
18-7875	Chris-Craft	16.81-06536	183, 571	18-7910-1	Yanmar	124450-35100	182, 673
18-7875	Chrysler Inboard	56874	183, 579	18-7911-1	Honda	15400-PFB-007	184, 249
18-7875	Chrysler Inboard	1851658	183, 579	18-7911-1	Nissan/Tohatsu	3R0-07615-0	184, 458
18-7875	Chrysler Inboard	F724002	183, 579	18-7911-1	Yamaha	5GH-13440-00-00	184, 516
18-7875	Crusader	9002514	183, 612	18-7913	Honda	15400-PFB-014	184, 249
18-7875	Mercury Marine	60565	183, 790	18-7913	Mercury Marine	35-822626Q03	184, 411
18-7875	Mercury Marine	35-802886Q	183, 790	18-7913	Mercury Marine	35-822626Q1	184, 411
18-7875	OMC	173231	183, 902	18-7914	Mercury Marine	35-822626K04	184, 411
18-7875	OMC	502900	183, 902	18-7914	Mercury Marine	35-822626Q04	184, 411
18-7875	Pleasurecraft	R077001	183, 632	18-7914	Mercury Marine	35-822626Q2	184, 411
18-7875	Yamaha	YSC-16231-20-0C	183, 995	18-7914	Mercury Marine	35-822626T2	184, 411
18-7876-1	Crusader	201104	183, 647	18-7914	Mercury Marine	35-877768K01	184, 411
18-7876-1	Mercury Marine	14957	183, 790	18-7914	Mercury Marine	35-8M0008397	184, 411
18-7876-1	Mercury Marine	32716	183, 790	18-7914	Mercury Marine	35-8M0064104	184, 411
18-7876-1	Mercury Marine	32717	183, 790	18-7915-1	OMC	778885	184, 301
18-7876-1	Mercury Marine	52022	183, 790	18-7915-1	OMC	5031411	184, 301
18-7876-1	Mercury Marine	52731	183, 790	18-7915-1	Suzuki	16510-87J00	184, 469
18-7876-1	Mercury Marine	54111	183, 790	18-7916	OMC	434839	184, 301
18-7876-1	Mercury Marine	32-802885Q	183, 790	18-7917	Yanmar	124085-35113	182, 673
18-7876-1	Mercury Marine	35-866340Q02	183, 790	18-7917	Yanmar	124450-35110	182, 673
18-7876-1	Mercury Marine	35-866340Q03	183, 790	18-7917	Yanmar	124550-35110	182, 673
18-7876-1	Mercury Marine	52731A1	183, 790	18-7917	Yanmar	171056-35110	182, 673
18-7876-1	OMC	173233	183	18-7917	Yanmar	171056-35111	182, 673
18-7876-1	OMC	502901	183	18-7918	Mercury Marine	35-877769K01	184, 411
18-7876-1	Volvo	3850559	183	18-7918	Mercury Marine	35-883701K01	184, 411
18-7876-1	Yamaha	YSC-14231-20-0C	183	18-7919	Mercury Marine	35-809097	137, 389, 732, 733
18-7876-1			571, 612	18-7919	Mercury Marine	35-8M0103095	137, 389, 732, 733
18-7878-1	Chrysler Inboard	3549957	183, 579	18-7919	Racor	S3213	137, 274, 389, 490, 732, 733, 886, 961
18-7878-1	Chrysler Inboard	L-1008	183, 579	18-7919	Yamaha	MAR-24563-00-00	137, 490
18-7878-1	Chrysler Inboard	L-19	183, 579	18-7920	Mercury Marine	35-809099	138, 389, 732
18-7878-1	Mercury Marine	38463	183, 790	18-7920	OMC	771839	138, 886
18-7878-1	Mercury Marine	46692	183, 790	18-7920	Racor	S3214	138, 274, 389, 490, 732, 886, 961
18-7878-1	Mercury Marine	803470	183, 790	18-7921	Mercury Marine	35-877767K01	184, 411
18-7878-1	Mercury Marine	803470Q	183, 790	18-7921	Mercury Marine	35-896546T	184, 411
18-7878-1	OMC	502904	183, 902	18-7922-1	Suzuki	99105-20004-BWL	137, 463
18-7878-1	Volvo	430143	183, 977	18-7922-1			274, 389, 490
18-7878-1	Volvo	1266286	183, 977	18-7924	Yamaha	MAR-10171-00-10	137, 490
18-7878-1	Volvo	3517857	183, 977	18-7924			274, 389, 732, 886, 961
18-7878-1			612, 632	18-7925	Westerbeke	21235	182, 673
18-7879-1	Chrysler Force	L-319	183, 579	18-7926	Volvo	423135	182, 673
18-7879-1	Mercury Marine	41815	183, 790	18-7926	Volvo	4785974	182, 673
18-7879-1	Mercury Marine	32-883702K	183, 790	18-7927	Caterpillar	1R-0714	182, 673
18-7879-1	Mercury Marine	32-883702Q	183, 790	18-7928-1	Racor	B32013	137
18-7879-1	Mercury Marine	35-802884Q	183, 790	18-7928-1			89, 274, 389, 490,
18-7879-1	OMC	173834	183, 902	18-7929	Mercury Marine	35-809100	137
18-7879-1	OMC	502903	183, 902	18-7929	Racor	B32020MAM	137
18-7879-1	Volvo	841750	183, 977	18-7929			89, 274, 389, 490, 732, 886, 961
18-7880	Caterpillar	1R-0658	183, 672	18-7930	OMC	173326	138, 886
18-7880	Volvo	466634	182, 977	18-7931	Detroit Diesel	5574508	139, 670
18-7884	Universal	299381	182, 672	18-7932-1			137, 273, 388, 490
18-7884	Volvo	834337	182, 977	18-7934	Cerlist Diesel	1512904	139
18-7886	Perkins	2654403	182, 672				
18-7888	Volvo	826648	963				
18-7888	Volvo	862293	963				
18-7890	Volvo	463505	977				

1 This product is priced per piece. To order, priced per package, please add -9 to the part number
 2 Items ending in "D" are display packaged - regular number is non-display
 3 For discount shop pack of 10, please add -10 to the part number

SIERRA #	O.E.M.	O.E. #	PAGE #	SIERRA #	O.E.M.	O.E. #	PAGE #	
SIERRA								
18-7935	FRAM	CCS 1136	139, 670	18-7976	Crusader	23250	600	
18-7936	Mercury Marine	35-888289T2	389	18-7977	Mercury Marine	35-866171A01	733	
18-7936	Suzuki	15412-93J00	463	18-79781	OMC	433190	274	
18-7937-1			137, 273, 388, 490	18-7979	Mercury Marine	881540	389	
18-7938			137, 273, 388, 490,	18-7979	Yamaha	68V-24563-00-00	491	
			732, 885, 960	18-79799	Yamaha	6D8-WS24A-00-00	491	
18-7941-1			138, 274, 886	18-79809	Yamaha	6P3-WS24A-00-00	491	
18-7942	Volvo	466987	139, 670, 961	18-7981	Mercury Marine	35-884380T	390	
18-7942	Volvo	3825133	139, 670, 961	18-7981	Mercury Marine	35-8M0020349	390	
18-7943			138, 274, 732, 886	18-79813			205	
18-7944	Mercury Marine	35-52456	136, 389, 732	18-79814	Mercury	91-896661	205	
18-7944	Mercury Marine	35-55501	136, 389, 732	18-79815	Yamaha	YB-ACC04	205	
18-7944	Mercury Marine	35-57250	136, 389, 732	18-79816	Mercury	91-879172T28	198	
18-7944	Mercury Marine	35-60494	136, 389, 732	18-79816-24			198	
18-7944	Mercury Marine	35-604941	136, 389, 732	18-79817			205	
18-7944	Mercury Marine	35-802893Q	136, 389, 732	18-79820-1			205	
18-7944	Mercury Marine	35-805369	136, 389, 732	18-7982-1			136, 273, 388, 489,	
18-7944	Mercury Marine	35-8053691	136, 389, 732				731, 885, 959	
18-7944	Mercury Marine	35-806771	136, 389, 732	18-7982-2			136, 273, 388, 489,	
18-7944	Mercury Marine	35-807172	136, 389, 732				731, 885, 959	
18-7944			89, 274, 490, 886, 960	18-79823			205	
18-7945	Mercury Marine	35-52456	136, 389, 732	18-79825			205	
18-7945	Mercury Marine	35-55501	136, 389, 732	18-7983-1	Mercury Marine	35-52456A1	136, 387, 731	
18-7945	Mercury Marine	35-57250	136, 389, 732	18-7983-1	Mercury Marine	35-55501A1	136, 387, 731	
18-7945	Mercury Marine	35-60494	136, 389, 732	18-7983-1	Mercury Marine	35-57250A1	136, 387, 731	
18-7945	Mercury Marine	35-604941	136, 389, 732	18-7983-1	Mercury Marine	35-60494A1	136, 387, 731	
18-7945	Mercury Marine	35-802893Q	136, 389, 732	18-7983-1	Mercury Marine	35-60494A4	136, 387, 731	
18-7945	Mercury Marine	35-805369	136, 389, 732	18-7983-1	Mercury Marine	35-802893A4	136, 387, 731	
18-7945	Mercury Marine	35-8053691	136, 389, 732	18-7983-1	Mercury Marine	35-802893Q4	136, 387, 731	
18-7945	Mercury Marine	35-806771	136, 389, 732	18-7983-1	Mercury Marine	35-807172A4	136, 387, 731	
18-7945	Mercury Marine	35-807172	136, 389, 732	18-7983-1			273, 388, 489, 731,	
18-7945	Yamaha	ABB-FUELF-IL-TR	136, 490				885, 959	
18-7945			89, 274, 886, 960	18-7983-2			137, 273, 388, 489,	
18-7945C			647				731, 885, 959	
18-7946	OMC	502905	138, 274, 886	18-79833-1	Mercury		205	
18-7946			960	18-79834	OMC		205	
18-7947	Honda	17670-ZW1-030GH	139, 241	18-7984-1	Yamaha	MAR-SPRTR-HD-SS	136, 489	
18-7947	Racor	S3240	139, 490, 732,				273, 388, 731,	
			886, 961				885, 959	
18-7947	Suzuki	99105-20006	139, 463	18-7985-1			136, 273, 388, 489,	
18-7948	Honda	17670-ZW1-801AH	139, 241				731, 885, 959	
18-7948	Mercury Marine	35-886638	139, 389, 732	18-7986-1			136, 273, 388, 489,	
18-7948	Racor	S3227	139, 389, 490, 732,				731, 885, 959	
			886, 961	18-7987	Racor	RK10222	139	
18-7948	Suzuki	99105-20005	139, 463	18-7987	Suzuki	99105-20006-BWL	139, 463	
18-7949	Racor	S3232	139, 490, 732,	18-7988			139	
			886, 961	18-7989	OMC	502906	138, 274, 886	
18-7950	Chrysler Force	25-45258	239	18-7989	Volvo	3852413	138, 960	
18-7951			137, 273, 388, 490,	18-7989	Volvo	3862228	138, 960	
			732, 885, 960	18-7989	Volvo	3851218-2	138, 960	
1	18-7952	Chrysler Force	25-88657	239	18-79900	Yamaha	66K-13915-00-00	492
	18-7953	OMC	5035974	274	18-79901	Mercuriser	65L-13915-00-00	733
	18-7953	Suzuki	15410-87J30	463	18-79901	Yamaha	65L-13915-00-00	492
	18-7954	Yamaha	N26-13440-00-00	184, 516, 517	18-79902	Yamaha	63P-13915-00-00	493
	18-7954	Yamaha	N26-13440-02-00	184, 516, 517	18-79903	Yamaha	68V-13915-00-00	493
	18-7955	Yamaha	68F-24563-10-00	491	18-79904	Yamaha	68F-13915-00-00	493
	18-7956	Chrysler Force	25-85549	239	18-79905	Yamaha	69J-24501-10-00	491
1	18-7956	Mercury Marine	25-85549	449	18-79906			138
	18-7958	Crusader	47047	600	18-79907	Yamaha	60V-24251-01-00	492
	18-7961	Mercury Marine	25-47254	449, 859	18-79908	Honda	16911-ZY3-010	242
	18-7961	Mercury Marine	25-861844	449, 859	18-79909	Honda	16901-ZY3-003	242
	18-7961	Mercury Marine	785-97386	859	18-79910	Yamaha	61N-24560-10	493
	18-7963	OMC	331353	315	18-79911	Mercury	35-8M0079962	136, 389, 732
	18-7964	Mercury Marine	879194241	S/S to 18-7964-1	18-79912	Mercury	35-8M0082290	136
	18-7964	Mercury Marine	35-813405	S/S to 18-7964-1	18-79912			388, 731
	18-7964	Mercury Marine	35-813405A1	S/S to 18-7964-1	18-7994-1			139, 389
	18-7964	Mercury Marine	35-815419	S/S to 18-7964-1	18-79950	Yamaha		493
	18-7964	Mercury Marine	FFF001138	S/S to 18-7964-1	18-79951	Yamaha		493
	18-7964	Mercury Marine	FI9608751	S/S to 18-7964-1	18-79952	Yamaha		493
	18-7964			S/S to 18-7964-1	18-79953	Yamaha		493
	18-7964-1	Mercury Marine	879194241	733	18-79954	Yamaha		493
	18-7964-1	Mercury Marine	35-813405	733	18-79955	Yamaha		493
	18-7964-1	Mercury Marine	35-813405A1	733	18-79956	Yamaha		493
	18-7964-1	Mercury Marine	35-815419	733	18-79957	Yamaha		493
	18-7964-1	Mercury Marine	FFF001138	733	18-79960	Yanmar	104500-55710	139, 670
	18-7964-1	Mercury Marine	FI9608751	733	18-79961	Yamaha	6H1-13411-00	516
	18-7964-1			568, 578, 600	18-7997	Mercury Marine	35-853333	390
	18-7965-1	Yamaha	MAR-MINIF-LT-AS	138, 490	18-7997	Mercury Marine	35-853333T	390
	18-7965-1			273, 388, 732	18-79970	Yamaha	6BG-13915-00	491
	18-7966-1	Yamaha	MAR-SEPAR-AT-OR	136, 489	18-79971	Yamaha	68F-13440-00	516
	18-7966-1			273, 388, 731	18-79972	Yamaha	67F-14371-01	491
	18-7967	Mercury Marine	35-14571A1	136, 389	18-79973	Yamaha	6C5-13915-00	491, 493
	18-7967	Mercury Marine	35-17808A1	136, 389	18-79974	Yamaha	6J8-13411-00	516
	18-7967	Mercury Marine	35-18458A2	136, 389	18-79975	Yamaha	6E5-13411-00	516
	18-7967	Mercury Marine	35-18458A3	136, 389	18-79976	Yamaha	61A-13411-00	516
	18-7967	Mercury Marine	35-18458Q3	136, 389	18-79977	Yamaha	6L5-24251-00	492
	18-7968	Mercury Marine	35-184585	136, 389	18-79978	Yamaha	6CB-13915-00	493
	18-7968	Mercury Marine	35-18458Q4	136, 389	18-79979	Yamaha	6CB-24501-00	492
	18-7969			139, 389, 732	18-79980	Yamaha	68F-24563-00	492
	18-7970	Cerlist Diesel	1512903	139	18-79981	Yamaha	69J-24501-00	492
	18-7974	Volvo	3827069	184, 977	18-79982	Yamaha	69J-24502-00	492

1 This product is priced per piece. To order, priced per package, please add -9 to the part number

2 Items ending in "D" are display packaged - regular number is non-display

3 For discount shop pack of 10, please add -10 to the part number

SIERRA #	O.E.M.	O.E. #	PAGE #	SIERRA #	O.E.M.	O.E. #	PAGE #
SIERRA							
18-79983	Yamaha	6C5-24251-00	492	18-80419	Suzuki	65750-87J10	464
18-79984	Yamaha	6AW-24502-00-00	492	18-80419	Suzuki	65750-87J11	464
18-79984	Yamaha	6AW-24502-10	492	18-8042			88, 145
18-79985	Yamaha	68V-24502-20-00	492	18-80420	Honda	17650-921-003ZB	242
18-79985	Yamaha	68V-24502-30	492	18-80425	Suzuki	65720-986B0	464
18-79986	Yamaha	68V-24502-00-00	492	18-8043			88, 145
18-79986	Yamaha	68V-24502-01-00	492	18-8045			145
18-79986	Yamaha	68V-24502-02	492	18-8046			145
18-79987			58, 203	18-8047			145
18-79988			58, 203	18-8048			146, 275
18-79989	Universal		239, 250, 337, 354, 440, 459, 470, 534	18-8050			146, 275
18-7999	Mercury Marine	35-896247	390	18-8051	OMC	322656	146, 275
18-79994N	Mercury	3310-866142A03	715	18-8052	OMC	122838	146, 275
18-79994N	Mercury	3310-866142A04	715	18-8054	Mercury Marine	22-63186	145, 385
18-79995N	Mercury	3310-866143A03	715	18-8055	Mercury Marine	22-63187	145, 385
18-79998	Volvo	R80316	956	18-8055	OMC	173311	145, 275, 887
18-80008	Volvo	R7044289	956	18-8055	Yamaha	ABA-FLINE-BA-RB	494
3 18-8002EP-1			89, 140, 229, 242, 354, 385, 457, 464, 494	18-8055			88, 494
18-8002S				3 18-8056	OMC	174508	275
18-8003	Volvo	8692305	184, 977	3 18-8056	OMC	775640	275
18-8004-10EP-1			140, 275, 464	18-8062	Chrysler Force	197787-3	229
3 18-8004EP-1	Mercury Marine	89396A38	140, 385	18-8062	Suzuki	65750-98505	464
3 18-8004EP-1	Mercury Marine	89396Q38	140, 385	3 18-8063	OMC	502867	275
3 18-8004EP-1	OMC	174511	140, 275	3 18-8063	OMC	772681	275
3 18-8004EP-1			89, 229, 242, 275, 385, 457, 464, 494	3 18-8063	OMC	772681	275
18-8004S	Mercury Marine	89396A38	146, 148	18-8067			145
18-8004S	Mercury Marine	89396Q38	146, 148	18-8068			386
18-8004S	OMC	174511	146, 148	18-8069	Mercury Marine	22831A1	386
18-8005-10EP-1			140, 275	18-8069	Mercury Marine	22831A3	386
3 18-8005EP-1	Mercury Marine	13330A3	140, 385	18-8069	Mercury Marine	22831A4	386
3 18-8005EP-1	OMC	174512	140, 275	18-8069	Mercury Marine	22831B3	386
3 18-8005EP-1			89, 229, 354, 457	18-8069	Mercury Marine	22831Q3	386
18-8005S	Mercury Marine	13330A3	146	18-8069	Mercury Marine	22831Q3	386
18-8005S	Mercury Marine	13330Q	146	18-8070	Mercury Marine	29196	386
18-8005S	OMC	174512	146	18-8070	Mercury Marine	16610M	386
18-8009EP-2	OMC	398549	142, 275	18-8070	Mercury Marine	30185A1	386
18-8009S-1	OMC	398549	147	18-8070	Mercury Marine	30185A3	386
18-8010EP-2			142, 384	18-8070	Mercury Marine	30185B3	386
18-8011EP-2	Chrysler Force	FS409752	141, 229	18-8070	Mercury Marine	30185Q3	386
18-8012EP-2	Mercury Marine	32-858114K08	142, 384	18-8071	Suzuki	99105-00192	464
18-8012EP-2	Mercury Marine	32-858114Q08	142, 384	18-8071			229
18-8013EP-2			144, 354	18-8072	OMC	174177	275, 887
18-8013S-1			148	18-8073			88, 145, 385
18-8014EP-2	OMC	174509	142, 275	18-8074	OMC	173312	145, 275, 887
18-8014S-1	OMC	174509	147	18-8074			88, 385
18-8015EP-2			144, 354	18-8075	Mercury Marine	22-14213M	386
18-8015S-1			148	18-8075	Mercury Marine	22-14213Q	386
18-8016EP-2	Mercury Marine	32-858109K12	143, 385	18-8075	Mercury Marine	22-81042M	386
18-8016EP-2	Mercury Marine	32-858109Q12	143, 385	3 18-8076	Mercury Marine	22-13563A3	386
18-8016S-1	Mercury Marine	32-858109K12	147	3 18-8076	Mercury Marine	22-13563Q3	386
18-8017EP-2	Yamaha	6YL-24306-60-00	144, 494	3 18-8077-1			386, 494
18-8017S-1	Yamaha	6YL-24306-60-00	148, 494	18-8078	Suzuki	65740-95500	464
1 18-8020	Mercury Marine	54-41582-7	145	18-8078	Suzuki	99105-00193	464
1 18-8020	OMC	322652	276, 887	18-8078			457
1 18-8020	Volvo	3852170	963	18-8079	Nissan/Tohatsu	3B2702810M	457
1 18-8020			457	18-8079	Nissan/Tohatsu	65750-95500	457
1 18-8021	OMC	911616	145, 276, 887	18-8079	Suzuki	65750-95500	464
1 18-8021	Volvo	3852529	963	18-8079	Suzuki	65750-95510	464
1 18-8021			457	18-8082			386
18-8024EP-2	Mercury Marine	32-858104K08	143, 384	18-8083			386
18-8024EP-2	Mercury Marine	32-858104Q08	143, 384	18-8084	Mercury Marine	29196	386
18-8025EP-2	Mercury Marine	32-858105K08	143, 385	18-8084	Mercury Marine	22-16610M	386
18-8025EP-2	Mercury Marine	32-858105Q08	143, 385	18-8084	Mercury Marine	30185A1	386
18-8032EP-2			144, 354	18-8084	Mercury Marine	30185A3	386
18-8032S-1			148	18-8084	Mercury Marine	30185B3	386
1 18-8034	OMC	329654	145, 276, 887	18-8084	Mercury Marine	30185Q3	386
1 18-8034	Volvo		963	3 18-8085			386
18-8040	Yamaha	ABA-FBARB-90-DG	494	18-8087	Suzuki	65720-94411	464
18-80400	Honda	16977-ZV5-A00	242	18-8088	Nissan/Tohatsu	3B2702501M	457
18-80401			242	18-8089	Nissan/Tohatsu	3B2-70260-0	457
18-80402			386	18-8090			464
18-80403			242	18-8091	Mercury Marine	22-13563A6	386
18-80404			464	18-8091	Mercury Marine	22-13563A7	386
18-80405			464	18-8091	Mercury Marine	22-13563Q7	386
18-80406	Honda	16977-ZV5-900	242	18-8091	Mercury Marine	22-13563T7	386
18-80407	Honda	17710-ZW9-033	242	18-8092	OMC	176445	275
18-80408	Honda	17650-ZW9-003	242	18-8092	OMC	775641	275
18-80409	Suzuki	65720-94401	464	18-8093			145
18-8041			88, 145	18-8094			145
18-80410-1	Mercury Marine	22-13563T3	386, 457	18-8095			145
18-80410-1	Nissan/Tohatsu	3GR702500M	386, 457	18-81006	OMC		200
18-80412	Mercury Marine	22-816856T2	386	18-81006	OMC		200
18-80413	Yamaha	6Y1-24305-04	495	18-81006	OMC		200
18-80414	Yamaha	6G1-24305-04	495	18-81006	OMC		200
18-80414	Yamaha	6G1-24305-05-00	495	18-81042EP-2	Honda	17700-ZW9-010	141, 242
18-80415	Yamaha	6E5-24305-05	495	18-81042EP-2	Honda	17700-ZW9-020	141, 242
18-80415	Yamaha	6Y2-24305-05	495	18-8108			88, 145
18-80418	Suzuki	65750-94404	464	18-8108			88, 145
				1 18-8109			145
				18-8110			145
				18-81100			200
				18-81101			200
				18-81103			200
				1 18-8111	Mercury Marine	22-36392	780

1 This product is priced per piece. To order, priced per package, please add -9 to the part number
 2 Items ending in "D" are display packaged - regular number is non-display
 3 For discount shop pack of 10, please add -10 to the part number

SIERRA #	O.E.M.	O.E. #	PAGE #	SIERRA #	O.E.M.	O.E. #	PAGE #
SIERRA							
18-8112	Crusader	97854	609	18-8359	Volvo	876268	993
18-8114			154, 567, 578, 599,	18-8360			926
18-8114			615, 647, 719,	18-8361	Volvo	576266-8	993
			883, 957	18-8362-1			250
18-8115			154, 567, 578, 599,	18-8363			250
			615, 635, 647, 719,	18-8365			250
			883, 957	18-8366			250
18-8124	Volvo	829913	139, 961	18-8367	OMC	334950	347
18-8125	Volvo	3583443	139, 961	18-8368	Volvo	813967	989
18-8126	Volvo	861477	139, 961	18-8369	OMC	914488	911
18-8127	Pleasurecraft	RP080026	628	18-8370			855
18-8149	Volvo	3847644	138, 961	18-8372	OMC	323582	315
18-8150			145	18-8373	Suzuki	25700-90J01	471
18-8150-10			145	18-8374	Suzuki	25700-92J00	471
18-8151			145	18-8375			472
18-8151-10			145	18-8377			472
18-8152			145	18-8378			472
18-8152-10			145	18-8380	Suzuki	25700-93J00	470
1 18-8200	OMC	322653	145, 276, 887	18-8381	Suzuki	25700-99E00	470
1 18-8200	Volvo	3852171	963	18-8382	Mercury Marine	26-816575A4	444
1 18-8201	OMC	124249	145, 276, 887	18-8383	OMC	5000309	346
1 18-8202	OMC	322654	145, 276, 887	18-8384	OMC	5006373	346
1 18-8202	Volvo	3852172	963	18-8385	Suzuki	25700-95J00	472
1 18-8203	OMC	329653	145, 276, 887	18-8386	Suzuki	25700-98J00	472
1 18-8203	Volvo	329653	963	18-8387	BRP	5007987	346
1 18-8204	OMC	324825	145, 276, 887	18-8400-9	Yamaha	90119-08M15-00	497
1 18-8204	Volvo	324825	963	18-8402	Mercury Marine	10-8053432	700
18-8205	Mercury Marine	30-803098T1	833	18-8403	Mercury Marine	10-8053433	Obsolote
18-8206-1	Mercury Marine	30-803099T1	833	18-8404-1	Mercury Marine	10-8083434	700
18-8208	Mercury Marine	31-803090T1	855	18-8406	Yamaha	97595-06535	505
18-8212-1	Mercury Marine	30-803100T1	833	18-8407	Yamaha	97595-06540	505
18-8212-1	Mercury Marine	8M0095485	833	18-8410	Mercury Marine	10-43749	780
18-8213	Mercuriser	30-803097T1	834	18-8411	Mercury Marine	10-44387	780
18-8215			588, 616, 632	18-8412			699, 875
18-8216	Mercury Marine	22-36305	783	18-8500			780
18-8216	Mercury Marine	22-36305T	783	18-8501	Barr	CM-20-9234 P	588
18-8216			588, 898	18-8502			899
18-8217	Mercuriser	30-803098T1	834	18-8503			630
18-8218	Mercuriser	30-803099T1	834	18-8504			630
18-8219	Mercuriser	30-803100T1	834	18-8505			780
18-8220	Mercury Marine	88-79023A91	704	18-8506	Barr	CM-20-6674JP	588
18-8226	Honda	16910-ZV4-015	242	18-8507	Barr	CM-20-6674JP	899, 971
18-8227	Mercury Marine	73873	791	18-8508			780
18-8227	Mercury Marine	73873A1	791	18-8510			971
18-8297	Mercury Marine	861578	791	18-8511			971
18-8298	Honda	91252-935-004	248	18-8512			780
18-8299	Honda	91356-ZY3-003	248	18-8514			780
18-8300	OMC	341280	347	18-8515			609
18-8301	OMC	341281	347	18-8516			570
18-8304	OMC	321830	331, 347	18-8518	Barr	CM-20-9232P	588
18-8305	Mercury Marine	42838	425	18-8519			609
18-8305	Mercury Marine	69668	425	18-8520			780
18-8305	Mercury Marine	88726	425	18-8521			609
18-8305	Mercury Marine	428381	425	18-8523			610
18-8305	Mercury Marine	26-814754	425	18-8524			610
18-8307	OMC	331103	347	18-8526			588
18-8308	Mercury Marine	26-30696	446	18-8527	Barr	CM-1-6677SS P	588
18-8309	Mercury Marine	18717	425	18-8529			781
18-8310	Mercury Marine	26-30900	446	18-8530			781
18-8311			831	18-8531			781
18-8312			831	18-8532			781
18-8313			831	18-8533			781
18-8325	OMC	342786	347	18-8534			899
18-8326	OMC	342787	347	18-8535			570, 588, 610, 618,
1 18-8331	Suzuki	09168-10022	470				630, 643, 781, 899, 971
18-8334	Suzuki	25223-94400	470	18-8536	Marine Power	0994-000	618
18-8335	Suzuki	25700-87D00	471	18-8536			570, 588, 610, 631,
18-8337	OMC	5031456	346				643, 781, 899, 971
18-8337	Suzuki	25700-94400	471	18-8538			570, 588, 610, 631,
18-8338	Suzuki	25700-94500	471				643, 781, 899, 971
18-8339	Suzuki	25700-94700	471	18-8539			971
18-8340	Suzuki	25700-95500	471	18-8547			610
18-8341	Suzuki	25700-95D00	471	18-8548			781
18-8345	Suzuki	09289-22007	471	18-8549			781
18-8347	Chrysler Force	26-76384	239	18-8551			781
18-8347	Chrysler Force	26-816464	239	18-8553			899
18-8347	Chrysler Force	26-8164641	239	18-8554			781
18-8347	Mercury Marine	26-76384	446	18-8555			781
18-8347	Mercury Marine	26-816464	446	18-8556			781
18-8347	Mercury Marine	26-8164641	446	18-8600			199
18-8349	OMC	911795	347,	18-8601			199
18-8349	OMC	3852548	374, 931	18-8602			199
18-8350	OMC	328603	347	18-8603			199
18-8351	OMC	308500	347	18-8604			199
18-8351	OMC	321504	347	18-8605			199
18-8352	OMC	332253	309	18-8606	Mercury	92-8M0062765	199
18-8353	OMC	320961	315	18-8607			199
18-8354	Chrysler Force	26-828627	239	18-8608			199
18-8355			300	18-8609			199
18-8357	Volvo	875741	993	18-8610			199
18-8358	Volvo	876267	993	18-8611			209

1 This product is priced per piece. To order, priced per package, please add -9 to the part number

2 Items ending in "D" are display packaged - regular number is non-display

3 For discount shop pack of 10, please add -10 to the part number

SIERRA #	O.E.M.	O.E. #	PAGE #	SIERRA #	O.E.M.	O.E. #	PAGE #
SIERRA							
18-8612			209	18-8827-1			171-181, 573
18-8613	Universal	88-831	209	18-8828-1	Mercury Marine	84-863656A1	171-181, 693
18-8614			209	18-8829-1	Mercury Marine	84-863656A2	171-181, 693
18-8615			209	18-8830-1	Mercury Marine	84-816608Q80	171-181, 693
18-8616			209	18-8832-1	Mercury Marine	84-816608A68	171-181, 693
18-8617			210	18-8832-1	Mercury Marine	84-816608K68	171-181, 693
18-8623	Indmar	501022S	616	18-8832-1	Mercury Marine	84-816608Q68	171-181, 693
18-8700	Yamaha	1WD-E3440-00-00	184, 517	18-8833-1	Mercury Marine	84-816608A14	171-181, 693
18-8700	Yamaha	2MB-E3440-00-00	184, 517	18-8833-1	Mercury Marine	84-816608Q14	171-181, 693
18-8700	Yamaha	5GH-13440-20	184, 517	18-8833-1	Mercury Marine	84-816761K14	171-181, 693
18-8700	Yamaha	5GH-13440-50-00	184, 517	18-8834-1	Mercury Marine	84-816608A83	171-181, 693
18-8700	Yamaha	5JW-13400-00-00	184, 517	18-8834-1	Mercury Marine	84-816608Q83	171-181, 693
18-8779	Indmar	872025	183, 616	18-8835-1	Mercury Marine	84-816608Q82	171-181, 693
18-8800-1	Mercury Marine	84-43376A7	171-181, 963	18-8836-1	Mercury Marine	84-816608A71	171-181, 693
18-8800-1	Mercury Marine	84-813720A5	171-181, 963	18-8836-1	Mercury Marine	84-816608Q71	171-181, 693
18-8800-1	Mercury Marine	84-816761A7	171-181, 963	18-8837-1	Mercury Marine	84-847701A7	171-181, 693
18-8800-1	Mercury Marine	84-816761Q5	171-181, 963	18-8837-1	Mercury Marine	84-847701Q7	171-181, 693
18-8800-1	OMC	503748	171-181, 872	18-8838-1	Mercury Marine	84-881698	171-181, 693
18-8800-1			562, 617				171-181, 594, 614, 623, 944
18-8801-1	Mercury Marine	84-813720A7	171-181, 693	18-8839-1			171-181, 258
18-8801-1	Mercury Marine	84-816761Q7	171-181, 693	18-8840-1			171-181, 258
18-8801-1	OMC	503750	171-181, 872	18-8840-1	OMC	503749	171-181
18-8801-1	Volvo	876532-3	171-181, 944	18-8841-1	OMC	503753	171-181, 872
18-8802-1	Mercury Marine	84-43376A12	171-181, 693	18-8842-1	OMC	503756	171-181, 872
18-8802-1	Mercury Marine	84-813720A12	171-181, 693	18-8843-1	OMC		172
18-8802-1	Mercury Marine	84-816761A12	171-181, 693	18-8844-1	Crusader		
18-8802-1	Mercury Marine	84-816761Q12	171-181, 693	18-8847-1	Yamaha	67F-82341-00-00 + 67F-82342-00-00 + 67F-82343-00-00 + 67F-82344-00-00	474
18-8802-1	OMC	503752	171-181, 872				725
18-8802-1	OMC	503755	171-181, 872	18-8860	Mercury Marine	8616777	724
18-8802-1	Volvo	8757166	171-181, 944	18-8861	Mercury Marine	861156A02	724
18-8803-2	Mercury Marine	84-43376A9	171-181, 693	18-8862	Mercury Marine	861156A03	724
18-8803-2	Mercury Marine	84-813720A10	171-181, 693	18-8864	Mercury Marine	866169A01	724
18-8803-2	Mercury Marine	84-813720A9	171-181, 693	18-8864	Mercury Marine	866169T01	724
18-8803-2	Mercury Marine	84-816761A9	171-181, 693	18-8865	Mercury Marine	866170A01	724
18-8803-2	Mercury Marine	84-816761Q10	171-181, 693	18-8866	Mercury Marine	892874T01	382
18-8803-2	Mercury Marine	84-816761Q9	171-181, 693	18-8866	Mercury Marine	899106T01	382
18-8803-2	OMC	503752	171-181, 872	18-8867	Mercury Marine	805025A2	724
18-8803-2	OMC	503755	171-181, 872	18-8867	Mercury Marine	805656A2	724
18-8803-2			171-181, 693	18-8867	Mercury Marine	805656A5	724
18-8804-1	Mercury Marine	84-813720A2	171-181, 693	18-8867	Mercury Marine	805656A6	724
18-8804-1	Mercury Marine	84-813720A3	171-181, 693	18-8867	Mercury Marine	861155A5	724
18-8804-1	Mercury Marine	84-813720A4	171-181, 693	18-8867	Mercury Marine	861155A6	724
18-8804-1	Mercury Marine	84-816608Q61	171-181, 693	18-8868	Mercury Marine	861155A2	725
18-8804-1	Mercury Marine	84-816761A4	171-181, 693	18-8868	Mercury Marine	861155A3	725
18-8804-1	Mercury Marine	84-816761Q3	171-181, 693	18-8870	Suzuki	16510-45H10	184, 469
18-8804-1	Mercury Marine	84-816761Q4	171-181, 693	18-8880	BRP	420956741	552
18-8805-1			172	18-8898			644
18-8806-1			171-181	18-8899			644
18-8807-1	OMC	503747	171-181, 872	18-8900	Chrysler Force	47-19453	230
18-8808-2	Mercury Marine	84-813720A6	171-181, 693	18-8900	Mercury Marine	47-19453	393
18-8808-2	Mercury Marine	84-816761Q6	171-181, 693	18-8901	Chrysler Force	47-F462065	230
18-8809-1	Mercury Marine	84-43376A8	171-181, 693	18-8903	Chrysler Force	47-F436065-2	230
18-8809-1	Mercury Marine	84-813720A8	171-181, 693	18-8904	OMC	5031417	277
18-8809-1	Mercury Marine	84-816761A8	171-181, 693	18-8905	OMC	5008968	279
18-8809-1	Mercury Marine	84-816761Q8	171-181, 693	18-8906	OMC	436137	277
18-8810-1	Mercury Marine	84-813720A11	171-181, 693	18-8907	OMC	5033542	277
18-8810-1	Mercury Marine	84-816761Q16	171-181, 693	18-8910	Yamaha	68T-44352-00-00	496
18-8810-1	OMC	503751	171-181, 872	18-8911	Yamaha	6L5-44352-00-00	496
18-8811-1	Mercury Marine	84-813720A13	171-181, 693	18-8920	Nissan/Tohatsu	3B2650211M	458
18-8811-1	Mercury Marine	84-816761Q13	171-181, 693	18-8921	Nissan/Tohatsu	334650210M	458
18-8811-1	OMC	503749	171-181, 872	18-8922	Nissan/Tohatsu	3C8650212M	458
18-8811-1			171-181, 693	18-8923	Nissan/Tohatsu	345650210M	458
18-8813-1	Volvo	875571	171-181, 944	18-8924	Nissan/Tohatsu	3B7650212M	458
18-8814-1	OMC	503749	171-181	18-8925	Nissan/Tohatsu	3C7650211M	458
18-8815-1	OMC	582365	171, 258	18-8926	Yamaha	6AW-44352-00-00	496
18-8816-1	OMC	582365	171, 258	18-8950	Crusader	RP061022	600
18-8817-1			171-181, 562	18-8951	Yanmar	124223-42092	671
18-8818-1	OMC	582365	171-181, 872	18-8951	Yanmar	128176-42071	671
18-8819-1			171-181, 223, 362	18-8952	Yanmar	104211-42071	671
18-8820-1	OMC	503754	171-181, 872	18-8953			136, 490
18-8820-1			171-181	18-8954			136, 490
18-8821-1	Mercury Marine	84-813720A3	171-181, 693	18-8955			136, 389, 733
18-8821-1	Mercury Marine	84-813720A4	171-181, 693	18-8956	Mercury	22-8M0001721	382
18-8821-1	Mercury Marine	84-816761A17	171-181, 693	18-8957	Mercury	22-818994	382
18-8821-1	Mercury Marine	84-816761A4	171-181, 693	18-8957	Mercury	22-8189941	382
18-8821-1	Mercury Marine	84-816761Q17	171-181, 693	18-8958	Mercury	22-424254	382
18-8821-1	Mercury Marine	84-816761Q3	171-181, 693	18-8960			212
18-8821-1	Mercury Marine	84-816761Q4	171-181, 693	18-8962	GM		651
18-8822-1	Mercury Marine	84-816608A81	171-181, 693	18-8963	GM		651
18-8822-1	Mercury Marine	84-816608Q81	171-181, 693	18-8964	Volvo	3853804	976
18-8823-1	OMC	503752	171-181, 872	18-8997			202
18-8823-1	OMC	503755	171-181, 872	18-8998-1			202
18-8823-1	Volvo	8757166	171-181, 944	18-8999			202
18-8823-1			172, 173, 179, 562, 944, 947, 948	18-9009			202
18-8824-1	Mercury Marine	84-816608Q78	172-174, 594, 614, 623, 690	18-9010			202, 440, 849
18-8824-1			172-174, 594, 614, 623, 690	18-9013	Mercury Marine	92-78383A12	198
18-8825-1			171-181	18-9013	Mercury Marine	92-817529A12	198
18-8826-1			171-181, 573	18-9013	OMC	174275	198
				18-9013	OMC	175068	198

1 This product is priced per piece. To order, priced per package, please add -9 to the part number
 2 Items ending in "D" are display packaged - regular number is non-display
 3 For discount shop pack of 10, please add -10 to the part number

SIERRA #	O.E.M.	O.E. #	PAGE #	SIERRA #	O.E.M.	O.E. #	PAGE #
SIERRA							
18-9013	OMC	775613	198	18-9145	Yamaha	YB-6AW04-A	202, 495
18-9024	Mercury Marine	92-78383A12	198	18-9146-9	Yamaha	YB-6AW04-3	202, 495
18-9024	Mercury Marine	92-817529A12	198	18-9180			Obsolete
18-9024	OMC	174275	198	18-9181			Obsolete
18-9024	OMC	175068	198	18-9182			199
18-9024	OMC	775613	198	18-9183			199
18-9032			Obsolete	18-9200-0	Mercury Marine	92-8M0071838	197
18-9065	Mercury Marine	92-78383A12	198	18-9200-1	Mercury Marine	92-8M0071841	197
18-9065	Mercury Marine	92-817529A12	198	18-9200-2	Mercury Marine	92-8M0071837	197
18-9065	OMC	174275	198	18-9200-4	Mercury Marine	92-8M0071837	197
18-9065	OMC	175068	198	18-9218	Mercury Marine	59829A1	830
18-9065	OMC	775613	198	18-9218	Mercury Marine	59830A5	830
18-9066			201	18-9218	Mercury Marine	814819A2	830
18-9067			201	18-9219	OMC	335677	334
18-9075	Mercury Marine	23-888690	440	18-9240-0	Mercury	92-802859A1	197, 840
18-9075	Yamaha	61A-45538-00-00	497	18-9240-1	Mercury	92-802863A1	197, 840
18-9076	Mercury Marine	23-888690-1	440	18-9300	Mercury	92-877770K1	Obsolete
18-9076	Yamaha	61A-45527-00-00	497	18-9320			195
18-9077	Mercury Marine	13-888363-2	440	18-9340			Obsolete
18-9077	Yamaha	90206-22M19	497	18-9350			195
18-9078	Mercury Marine	12-855682-2	440	18-9360			195
18-9078	Yamaha	90201-22M01	497	18-9390	Yamaha	LUB-MRNSM-KT-10	197, 517
18-9079	Yamaha	61A-45538-00-00 +		18-9391	Yamaha	LUB-MRNMMD-KT-10	197, 517
		61A-45527-00-00 +		18-9392	Yamaha	LUB-MRNMNR-KT-10	198, 517
		90206-22M19 +		18-9393	Yamaha	LUB-MRNLG-KT-10	198, 517
		90201-22M01	497	18-9400-2	Mercury Marine	92-802837Q1	188
18-9080	Mercury Marine	92-78383A12	198	18-9400-2P	Mercuriser	92-802837Q1	188
18-9080	Mercury Marine	92-817529A12	198	18-9400-30			188
18-9080	OMC	174275	198	18-9400-30P			188
18-9080	OMC	175068	198	18-9400-4	Mercury Marine	92-857389A1	188
18-9080	OMC	775613	198	18-9400-4P	Mercuriser	92-857389A1	188
18-9081	Yamaha	6E5-44312-00-00	497	18-9400-7	Mercury Marine	92-802841A1	188
18-9082	Yamaha	6AW-44312-00-00	497	18-9400-7P	Mercuriser	92-802841A1	188
18-9083	Yamaha	63D-44312-00	505	18-9400CAT-2	Mercury Marine	92-8M0078627	191
18-9084	Johnson/Evinrude	354578	284	18-9400CAT-2P	Mercury Marine	92-8M0078627	191
18-9089	Yamaha	6EG-G4328-00	505	18-9400CAT-4	Mercury Marine		191
18-9090	Yamaha	63V-44328-01	504	18-9400CAT-4P	Mercury Marine		191
18-9091	Yamaha	69M-G4328-00	505	18-9400CAT-7	Mercury Marine	92-8M0078621	191
18-9092	Yamaha	6L2-44328-00	505	18-9400CAT-7P	Mercury Marine	92-8M0078621	191
18-9093			92, 199	18-9410-2	Volvo	3842343	189
18-9095			92, 199	18-9410-4	Volvo	3842344	189
18-9096	Volvo	3847547	988	18-9410-7	Volvo	3858061	189
18-9098	OMC	174448	925	18-9420-2	Mercury Marine	92-802833Q1	188
18-9098	Volvo	174448	988	18-9420-2P	Mercury	92-802833Q1	188
18-9099	Mercury Marine	86459	850	18-9420-3	Mercury Marine	92-802835Q1	188
18-9099	Mercury Marine	879078	850	18-9420-3P	Mercury	92-802835Q1	188
18-9099	Mercury Marine	32657A3	850	18-9420-30	Mercury	92-802835Q1	188
18-9099	Mercury Marine	32657A4	850	18-9420-30P	Mercury	92-802835Q1	188
18-9099	Mercury Marine	41155A1	850	18-9420-7	Mercury Marine	92-802836A1	188
18-9099	Mercury Marine	41155A2	850	18-9420-7P	Mercury	92-802836A1	188
18-9099	Mercury Marine	817019A1	850	18-9420CAT-2	Mercury Marine	92-8M0078625	191
18-9099	Mercury Marine	817019A2	850	18-9420CAT-2P	Mercury Marine	92-8M0078625	191
18-9099	Mercury Marine	817019Q2	850	18-9420CAT-3	Mercury Marine	92-8M0078626	191
18-9099	Mercury Marine	86459A1	850	18-9420CAT-3P	Mercury Marine	92-8M0078626	191
18-9099	Mercury Marine	86459A2	850	18-9420CAT-7	Mercury Marine	92-8M0078618	191
18-9125	Oetiker	787133	202, 276	18-9420CAT-7P	Mercury Marine	92-8M0078618	191
18-9125	OMC	787133	202, 276	18-9440-2	Mercury Marine	92-883724K01	188
18-9125	OMC	787145	202, 276	18-9440-2P	Mercury Marine	92-883724K01	188
18-9126-9	Oetiker	16700004	202, 276	18-9440-3	Mercury Marine	92-883723K01	189
18-9126-9	OMC	346930	202, 276	18-9440-4	Mercury Marine	92-883725K01	188
18-9127-9	Oetiker	16700006	202, 276	18-9440-4P	Mercury Marine	92-883725K01	188
18-9127-9	OMC	348838	202, 276	18-9440-7	Mercury Marine	92-858057K01	188
18-9128-9	Oetiker	16700007	202, 276	18-9440-7P	Mercuriser	92-858057K01	188
18-9128-9	OMC	349516	202, 276	18-9440-8	Mercury Marine	92-883722K01	189
18-9129-9	Oetiker	16700010	202, 276	18-9440CAT-2	Mercury Marine	92-8M0078629	191
18-9129-9	OMC	347107	202, 276	18-9440CAT-2P	Mercury Marine	92-8M0078629	191
18-9130-9	Oetiker	16700011	202, 276	18-9440CAT-4	Mercury Marine		191
18-9130-9	OMC	347108	202, 276	18-9440CAT-4P	Mercury Marine		191
18-9131-9	Oetiker	16700012	202, 276	18-9440CAT-7	Mercury Marine	92-8M0078624	191
18-9131-9	OMC	346931	202, 276	18-9440CAT-7P	Mercury Marine	92-8M0078624	191
18-9132-9	Oetiker	16700013	202, 276	18-9450-2	Yamaha	LUB-20W40-FC-12	186
18-9132-9	OMC	346785	202, 276	18-9490-1			185
18-9133-9	Oetiker	16700016	202, 276, 495	18-9493			198
18-9133-9	OMC	346786	202, 276	18-9494			186
18-9133-9	Yamaha	YB-6AW04-1	202, 495	18-9495			186
18-9134-9	Oetiker	16700017	202, 276	18-9496			Obsolete
18-9134-9	OMC	348839	202, 276	18-9499			Obsolete
18-9135-9	Oetiker	16700024	202, 276	18-9500-1			186
18-9135-9	OMC	346151	202, 276	18-9500-1P			186
18-9136-9	Oetiker	16700031	202, 276	18-9500-2			186
18-9136-9	OMC	346152	202, 276	18-9500-2P			186
18-9137-9	Oetiker	16700037	202, 276	18-9500-3			186
18-9137-9	OMC	346153	202, 276	18-9500-3P			186
18-9138-9	Oetiker	16700040	202, 276	18-9500-4			186
18-9138-9	OMC	349759	202, 276	18-9500-4P			186
18-9139-9	Oetiker	16700053	202, 276	18-9500-6			186
18-9139-9	OMC	349729	202, 276	18-9500-7P			186
18-9140-9	Oetiker	16700020	202, 276	18-9530-3	Mercury Marine	92-858037K01	186
18-9140-9	OMC	346150	202, 276	18-9530-3	OMC	764354	186
18-9141	Oetiker	14100082	202, 276, 495				
18-9141	OMC	787145	202, 276				

1 This product is priced per piece. To order, priced per package, please add -9 to the part number

2 Items ending in "D" are display packaged - regular number is non-display

3 For discount shop pack of 10, please add -10 to the part number

SIERRA #	O.E.M.	O.E. #	PAGE #	SIERRA #	O.E.M.	O.E. #	PAGE #
SIERRA							
18-9530-3	Yamaha	LUB-2STRK-M1-4	186	18-9794	Mercury Marine	91-883704Q03	200
18-9530-3P			186	18-9795			200
18-9530-4			186	18-9798			186, 199
18-9530-4P			186	18-9800			210, 365
18-9530-6			186	18-9801	Mercury Marine	91-99750A1	210, 365
18-9530-7	Mercury Marine	92-858039K01	186	18-9801	Mercury Marine	91-99750A1	210, 365
18-9530-7	OMC	777228	186	18-9802	Mercury Marine	91-99379	212, 365
18-9530-7	Yamaha	LUB-2STRK-M1-55	186	18-9802			223, 257, 462, 482, 563, 576, 597, 625, 701, 878, 954
18-9530-7P			186				206, 840
18-9540-2			186				840
18-9540-3	OMC	764357	186	18-9803	Mercury Marine	91-17256	201
18-9540-3P			186	18-9803	Mercury Marine	91-36235	207
18-9540-7	OMC	777120	186	18-9804			205
18-9550-0			198	18-9805	Mercury Marine	12-34961	836
18-9550-3			198	18-9806E	Mercury Marine	91-12037	206
18-9551-2	Suzuki	990C0-10W40-1QT	187	18-9806E			206
18-9551-3	Suzuki	990C0-10W40-1GL	187	18-9807	Mercury Marine	91-12427	206
18-9551-6			187	18-9807	Mercury Marine	91-12427T	206
18-9551-7			187	18-9808	Mercury Marine	91-15755	206
18-9552-3	Mercury Marine	92-858084K01	187	18-9808	Mercury Marine	91-15755T	206
18-9552-6			187	18-9808	Mercury Marine	91-31109	206
18-9552-8			187	18-9808	Mercury Marine	91-37263	206
18-9553-2	Volvo	40005011	187	18-9809	Mercury Marine	91-17257	206
18-9553-2			187	18-9810	Mercury Marine	91-17262A1	206
18-9553-3	Mercury Marine	92-858042K01	187	18-9812	Mercury Marine	91-17275A1	206
18-9553-3	Mercury Marine	92-858042Q01	187	18-9814	Mercury Marine	91-29310	212
18-9553-3	Volvo	40005012	187	18-9815	Mercury Marine	91-37324	212
18-9553-5	Volvo	40005013	187	18-9816	Mercury Marine	91-30366T1	206
18-9553-6			187	18-9817	Mercury Marine	91-23033	206
18-9553-7	Volvo	40005014	187	18-9817	Mercury Marine	91-23033T	206
18-9554-2	Indmar	872005	190	18-9817	Mercury Marine	91-24150	206
18-9554-4	Indmar	872006	190	18-9817	Mercury Marine	91-31107	206
18-9554-5	Indmar		190	18-9817	Mercury Marine	91-31107T	212
18-9554-7	Indmar		190	18-9819	Mercury Marine	91-31229	207
18-9555-2	Indmar	872003	190	18-9820	Mercury Marine	91-31229A7	206
18-9555-4	Indmar	872004 (7QT)	190	18-9821	Mercury Marine	91-32325	206
18-9555-7	Indmar		190	18-9821	Mercury Marine	91-32325T	207
18-9558-2	Ilmor/MasterCraft	550022689	190	18-9822	Mercury Marine	91-32336	206
18-9558-4	Ilmor/MasterCraft	550046126	190	18-9823	Mercury Marine	91-33489	206
18-9558-7	Ilmor/MasterCraft		190	18-9824	Mercury Marine	91-33491	206
18-95560			205	18-9825	Mercury Marine	91-33492	206
18-95605			Obsolete	18-9825	Mercury Marine	91-33492T	206
18-9570-0			198	18-9826	Mercury Marine	91-33493	206
18-9580-3			198	18-9826	Mercury Marine	91-33493T	206
18-9600-0	Mercury Marine	92-802844Q02	196	18-9827	Mercury Marine	91-34379T	212
18-9600-2	Mercury Marine	92-858058Q01	196	18-9828	Mercury Marine	91-36379	207
18-9600-2P	Mercury Marine	92-858058Q01	196	18-9829	Mercury Marine	91-36569	207
18-9600-5	Mercury Marine	92-858007Q01	196	18-9829	Mercury Marine	91-36569T	207
18-9600-5P	Mercury Marine	92-858007Q01	196	18-9830	Mercury Marine	91-36571	207
18-9600-6	Mercury Marine	92-858061Q01	196	18-9830	Mercury Marine	91-36571T	207
18-9600-7	Mercury Marine	92-858062Q01	196	18-9831	Mercury Marine	91-36577	207
18-9600-7P	Mercury Marine	92-858062Q01	196	18-9831	Mercury Marine	91-36577T	212
18-9600-9			196	18-9832	Mercury Marine	91-37292	212
18-9620-0			196	18-9833	Mercury Marine	91-37311	212
18-9620-2			196	18-9834	Mercury Marine	91-37312	207
18-9620-5			196	18-9835	Mercury Marine	91-37323	207
18-9650-0			196	18-9836	Mercury Marine	91-37350	207
18-9650-2	Mercury Marine	92-858064Q01	196	18-9837	Mercury Marine	91-38628T	207
18-9650-2P	Mercury Marine	92-858064Q01	196	18-9838	Mercury Marine	91-38756	207
18-9650-5	Mercury Marine	92-858008Q01	196	18-9839	Mercury Marine	91-38918T	207
18-9650-5P	Mercury Marine	92-858008Q01	196	18-9840	Mercury Marine	91-38919	207
18-9650-6	Mercury Marine	92-858067Q01	196	18-9841	Mercury Marine	91-42840T	207
18-9650-6P	Mercury Marine	92-858067Q01	196	18-9842	Mercury Marine	91-43506T	207
18-9650-7	Mercury Marine	92-858068Q01	196	18-9843	Mercury Marine	91-43559	207
18-9650-7P	Mercury Marine	92-858068Q01	196	18-9844	Mercury Marine	91-43579	208
18-9680-2	Volvo	1141679	196	18-9845	Mercury Marine	91-43591T	208
18-9680-5	Volvo	1141681	196	18-9846	Mercury Marine	91-44110	208
18-9680-7	Volvo	1141682	196	18-9847	Mercury Marine	91-45497A1	212
18-9690-2			189	18-9848	Mercury Marine	91-52393	212
18-9690-3			189	18-9849	Mercury Marine	91-52394	208
18-9730-1			199	18-9850	Mercury Marine	91-53459	208
18-9750-0			198	18-9851	Mercury Marine	91-55916	208
18-9751-0			198	18-9852	Mercury Marine	91-55918	208
18-9751-2			198	18-9853	Mercury Marine	91-56048001	208
18-9775			198	18-9853	Mercury Marine	91-56048T	208
18-9776			198	18-9854	Mercury Marine	91-56775T	208
18-9777			198	18-9855	Mercury Marine	91-60523	208
18-9778			200	18-9856	Mercury Marine	91-60526T	208
18-9779			200	18-9857	Mercury Marine	91-61067A3	208
18-9780			199	18-9858	Mercury Marine	91-61069T	208
18-9781	Mercury Marine	91-850730Q01	200	18-9859	Mercury Marine	91-63616	208
18-9781	Mercury Marine	91-8M0072133	200	18-9860	Mercury Marine	91-63638T	208
18-9782	Mercury Marine	91-74057Q6	200	18-9861	Mercury Marine	91-78310	212
18-9783	Mercury Marine	91-74057Q6	200	18-9862	Mercury Marine	91-87119	209
18-9784			201	18-9863	Mercury Marine	91-89865	209
18-9785	Mercury Marine	91-30500	201	18-9865	Mercury Marine	91-90774	209
18-9786			196	18-9866	Mercury Marine	91-89897	208
18-9787			200	18-9868	Mercury Marine	91-61077	209
18-9788			200	18-9869	Mercury Marine	91-817570T	209
18-9789			200	18-9870	Mercury Marine	91-818162	209
18-9790			200	18-9871	Mercury Marine	91-818169T	209

1 This product is priced per piece. To order, priced per package, please add -9 to the part number
 2 Items ending in "D" are display packaged - regular number is non-display
 3 For discount shop pack of 10, please add -10 to the part number

SIERRA #	O.E.M.	O.E. #	PAGE #	SIERRA #	O.E.M.	O.E. #	PAGE #
SIERRA							
18-9872	Mercury Marine	91-821571A1	209	18-99066	Yamaha	65L-13645-00	526
18-9873	Mercury Marine	91-813653	212	18-99067	Yamaha	65L-13646-00	526
18-9874	Mercury Marine	91-14311A04	206	18-99068	Yamaha	65W-11169-00	526
18-9874	Mercury Marine	91-14311A1	206	18-99069	Yamaha	65W-11351-00	526
18-9874	Mercury Marine	91-14311A2	206	18-99070	Yamaha	65W-11356-00	211
18-9874	Mercury Marine	91-44307A1	206	18-99070	Yamaha	65W-11356-00	526
18-9875	Mercury Marine	91-90244A1	209	18-99071	Yamaha	65W-14457-10	526
18-9876	OMC	349957	205, 914	18-99072	Yamaha	65W-41114-00	526
18-9879	Mercury		205	18-99073	Yamaha	65W-W0001-20	518
18-9884	Racor	RK22628	137, 139, 140, 199	18-99074	Yamaha	66M-11351-10	526
18-9885	OMC	328360	205	18-99075	Yamaha	66M-11356-00	526
18-9886	OMC	328361	205	18-99076	Yamaha	66M-13329-10	526
18-9887	OMC	328363	205	18-99078	Yamaha	66M-41138-00	526
18-9888	OMC	328364	205	18-99079	Yamaha	66M-45115-00	526
18-9889	OMC	328365	205	18-9908			211
18-9890	OMC	328366	205	18-99080	Yamaha	676-13646-A0	526
18-9891	OMC	328367	205	18-99081	Yamaha	676-41112-A0	526
18-9892	OMC	341440	205	18-99082	Yamaha	676-44315-A1	526
18-9894	OMC	393279	205	18-99083	Yamaha	676-44324-A0	526
18-9895	Merc/Evinrude	881150K1	202	18-99084	Yamaha	676-45127-00	526
18-9896	Mercury	91-47448A1	205	18-99085	Yamaha	676-45128-00	526
18-9896	Mercury	91-75132	205	18-99086	Yamaha	679-44316-A0	526
18-9896	Mercury	91-878232	205	18-99087	Yamaha	679-45315-A0	526
18-9896	Mercury	91-90455	205	18-99088	Yamaha	67C-11356-00	526
18-9896	Mercury	91-90455T	205	18-99089	Yamaha	67C-41114-00	527
18-9896	Mercury	91-90455T1	205	18-9909			211
18-9897	Mercury	91-895343A02	205	18-99091	Yamaha	67C-45113-00	527
18-9897	Mercury	91-895343T01	205	18-99092	Yamaha	67C-W0001-00	518
18-9897	Mercury	91-895343T02	205	18-99093	Yamaha	67C-W0001-20	518
18-9898			200	18-99094	Yamaha	67F-11181-02	521
18-9898			210	18-99095	Yamaha	682-11351-A0	527
18-9900	Universal		210	18-99096	Yamaha	682-41112-A1	527
18-99000	Yamaha	61A-41134-A0	523	18-99097	Yamaha	682-W0001-06	518
18-99001	Yamaha	61A-45114-A0	523	18-99098	Yamaha	688-13621-A1	527
18-99002	Yamaha	62Y-41133-00	523	18-99099	Yamaha	68F-11193-01	527
18-99003	Yamaha	62Y-41134-01	523	18-9910			211
18-99004	Yamaha	63D-45114-A0	523	18-99100	Yamaha	68F-11381-00	527
18-99005	Yamaha	63D-45123-00	523	18-99101	Yamaha	68F-41114-00	527
18-99006	Yamaha	63V-41133-A1	523	18-99102	Yamaha	68F-45113-00	527
18-99008	Yamaha	64J-41133-10	524	18-99103	Yamaha	68F-W0001-01	518
18-99009	Yamaha	663-45123-00	524	18-99104	Yamaha	6A0-W0001-21	518
18-99010	Yamaha	664-41134-A0	524	18-99105	Yamaha	6E5-13621-A1	527
18-99012	Yamaha	66M-41133-00	524	18-99106	Yamaha	6E9-11193-A0	527
18-99013	Yamaha	66M-45113-00	524	18-99107	Yamaha	6E9-41114-A0	527
18-99014	Yamaha	676-41133-A0	524	18-99108	Yamaha	6G1-11193-A1	527
18-99015	Yamaha	676-45114-A0	524	18-99109	Yamaha	6G1-13621-A1	527
18-99016	Yamaha	67C-41133-00	524	18-9911			211
18-99017	Yamaha	67C-45123-00	524	18-99110	Yamaha	6G1-13645-A1	527
18-99018	Yamaha	67F-41133-A1	524	18-99111	Yamaha	6G1-14198-A1	527
18-99019	Yamaha	67F-41134-A0	524	18-99112	Yamaha	6G1-41112-A1	527
18-9902	Universal		210	18-99113	Yamaha	6G1-41114-A0	527
18-99020	Yamaha	67F-45123-00	524	18-99114	Yamaha	6G1-41133-A0	527
18-99021	Yamaha	682-41133-A0	524	18-99115	Yamaha	6G1-45113-A1	527
18-99022	Yamaha	682-45113-A1	524	18-99116	Yamaha	6G1-45315-A0	527
18-99023	Yamaha	688-41133-00	524	18-99117	Yamaha	6G1-W0001-A2	518
18-99024	Yamaha	688-41134-A0	524	18-99118	Yamaha	6G5-14483-A1	527
18-99025	Yamaha	688-45114-A1	524	18-99119	Yamaha	6G8-11351-A0	527
18-99026	Yamaha	688-45123-00	524	18-9912			211
18-99027	Yamaha	68T-13475-00	524	18-99120	Yamaha	6G8-12414-A0	527
18-99028	Yamaha	68V-15312-00	524	18-99121	Yamaha	6G8-13646-A0	528
18-9903			210	18-99122	Yamaha	6G8-14198-A0	528
18-99030	Yamaha	697-45114-A0	525	18-99123	Yamaha	6G8-15374-00	528
18-99032	Yamaha	69J-41134-A0	525	18-99124	Yamaha	6H3-12414-A1	528
18-99033	Yamaha	69J-41135-A0	525	18-99125	Yamaha	6H3-13622-00	528
18-99034	Yamaha	69J-41136-A0	525	18-99126	Yamaha	6H3-14198-01	528
18-99037	Yamaha	6E5-41134-A0	525	18-99127	Yamaha	63P-12414-00-00	530
18-99038	Yamaha	6E5-41135-A0	525	18-99128	Yamaha	6H3-41112-A0	528
18-99039	Yamaha	6G5-41134-A1	525	18-99129	Yamaha	6H3-41114-A0	528
18-9904			210	18-9913			211
18-99040	Yamaha	6G5-45114-A1	525	18-99130	Yamaha	6H3-45113-A0	528
18-99045	Yamaha	6G8-45113-A1	525	18-99132	Yamaha	6H4-13621-A1	528
18-99046	Yamaha	6H3-45114-A1	525	18-99133	Yamaha	6H4-14198-01	528
18-99047	Yamaha	6H3-45123-00	525	18-99134	Yamaha	6H4-15369-A1	528
18-99048	Yamaha	60V-11181-00	521	18-99135	Yamaha	6H4-41112-A0	528
18-99049	Yamaha	60V-13621-A0	525	18-99136	Yamaha	6K7-13686-A1	528
18-9905			211	18-99137	Yamaha	6L2-41133-A2	528
18-99050	Yamaha	60V-13645-00	525	18-99138	Yamaha	6L2-45315-A0	528
18-99051	Yamaha	61A-11193-A1	525	18-99139	Yamaha	60V-13646-00	528
18-99052	Yamaha	61A-11381-A0	525	18-9914			210
18-99053	Yamaha	61A-13621-A0	525	18-99140	Yamaha	63V-11181-A2	528
18-99054	Yamaha	61A-13645-00	525	18-99141	Yamaha	6H3-11193-A1	528
18-99055	Yamaha	61A-13646-00	525	18-99142	Yamaha	6E9-12414-A1	528
18-99056	Yamaha	61A-45113-A0	525	18-99143	Yamaha	6H3-13621-A1	528
18-99057	Yamaha	61T-11193-A1	525	18-99144	Yamaha	6E7-14227-00	528
18-99059	Yamaha	63D-11193-A0	521	18-99145	Yamaha	677-14198-A1	528
18-9906			211	18-99146	Yamaha	677-14384-01	486
18-99060	Yamaha	63D-11181-A1	521	18-99147	Yamaha	6G1-24431-01	528
18-99061	Yamaha	63D-W0001-00	518	18-99148	Yamaha	688-41114-A0	528
18-99062	Yamaha	68F-11181-00	521	18-99149	Yamaha	663-44316-A0	529
18-99063	Yamaha	63V-45315-A0	526	18-99150	Yamaha	63V-45113-A1	529
18-99064	Yamaha	64E-13645-A0	526	18-99151	Yamaha	688-45113-A0	529

1 This product is priced per piece. To order, priced per package, please add -9 to the part number

2 Items ending in "D" are display packaged - regular number is non-display

3 For discount shop pack of 10, please add -10 to the part number

SIERRA #	O.E.M.	O.E. #	PAGE #	SIERRA #	O.E.M.	O.E. #	PAGE #
SIERRA							
18-99152	Yamaha	683-45315-A0	529	35-SS695			213
18-99153	Honda	19232-ZW9-000	245	35-SS700			213
18-99154	Honda	19234-ZX2-C00	245	35-SS715	Mercury		213
18-99155	Mercury	27-822217	398	35-SSKIT1			213
18-99156	Johnson/Evinrude	325040	285	72-5100-2	Arctic Cat	0436-880	193
18-99157	Yamaha	6EG-G4315-00	505	72-5100-2	Honda	HP4	193
18-99175	Yamaha	63V-W0001-01	520	72-5100-2			193
18-99176	Yamaha	6H3-W0001-02	520	72-5100-3	Arctic Cat	0436-879	193
18-ADA500			217	72-5100-7			193
18-ADA501HC			217	72-5101-2	Arctic Cat	1436-434	193
18-ADA502			217	72-5101-2	Can-Am	XPS #779139	193
18-ADA503			217	72-5101-3	Arctic Cat	1436-435	193
18-ADA504			217	72-5101-3	Can-Am	XPS #779140	193
18-ADA505			217	72-5101-7			193
18-ADA506			217	72-5102-2	Arctic Cat	1436-159	194
18-ADA507			217	72-5102-2	Honda	08208-0080	194
18-ADA508			217	72-5102-2			194
18-ADA509			217	72-5102-4	Arctic Cat	0436-901	194
18-ADA510			217	72-5102-4			194
18-ADA511			217	72-5102-5			194
18-ADA512			217	72-5102-7			194
18-ADC152			218	72-5103-2	Arctic Cat	4639-349	193
18-ADC153			218	72-5103-2	Honda	HP2	193
18-ADC199			218	72-5103-2	Yamaha		193
18-ADC300E			218	72-5103-2	Ski-Doo	XPS 779126	193
18-ADC400			218	72-5103-2	Polaris	VES	193
18-ADC401			218	72-5103-2	Kawasaki	K61021-208A	193
18-ADC402			218	72-5103-3	Arctic Cat	5639-469	193
18-ADC403			219	72-5103-3	Honda	HP2	193
18-ADC404			219	72-5103-3			193
18-ADC406			219	72-5103-3	Ski-Doo	XPS 779127	193
18-ADC407			219	72-5103-3	Polaris	VES	193
18-ADC408			219	72-5103-4	Honda	HP2	193
18-ADC409			218	72-5103-4	Yamaha		193
18-ADC410			219	72-5103-4	Polaris	VES	193
18-ADC411			219	72-5103-5	Honda	HP2	193
18-ADC412			218	72-5103-5	Polaris	VES	193
18-ADC414			219	72-5103-7	Honda	HP2	193
18-ADC415			219	72-5103-7	Polaris	VES	193
18-ADC416			219	72-5104-2	Polaris	PS-4	194
18-ADC417			219	72-5104-3	Polaris	PS-4	194
18-ADC418			219	72-5104-7	Polaris	PS-4	194
18-ADC419			220	72-5105-2			194
18-ADC420			220	72-5105-3			194
18-ADC421			220	72-5105-7			194
18-ADC422			220	56966P			20, 119
18-ADC423			220	56966P			20, 119
18-ADC424			220	56966P			20, 119
18-ADC425			220	56967P			20, 119
18-ADC427			220	56967P			20, 119
18-ADC428			220	56967P			20, 119
18-ADC450			218	BC88523			57
18-SD111			220	BC88523			57
18-SD112			220	BC88533			57
18-SD113			220	BC88533			57
18-SD114			220	BC88543			57
18-SD115			220	BC88543			57
18-SD115SUB			216	BC88553			57
18-SD116			220	BC88553			57
18-SD116SUB			216	BC88563			57
18-SD117			220	BC88563			57
18-SD117SUB			216	BC88573			57
18-SD405			220	BC88573			57
18-SD406			220	BC88583			57
18-SD406SUB			216	BC88583			57
18-SD407			220	BC88593			57
18-SD407SUB			216	BC88593			57
18-SD410			216	EC01350			61, 212
18-SD413			220	EC09040			61, 212
18-SD413SUB			216	EC09090			61, 210
18-SD414			220	GS62600			203
18-SD415			220	GS62610			203
18-SD500			216	GS62620			203
18-SD501			216	GS62630			203
35-SS600			213	GS62640			203
35-SS605			213	GS62650			203
35-SS610			213	GS62660			203
35-SS615			213	GS62670			203
35-SS620			213	GS62680			203
35-SS625			213	GS62690			203
35-SS630			213	GS62700			203
35-SS635			213	GS62710			203
35-SS645			213	GS62720			203
35-SS650			213	GS62730			203
35-SS655	Volvo		213	GS62740			203
35-SS660			213	GS62750			203
35-SS665			213	GS62760			203
35-SS670	Johnson/Evinrude		213	GS62770			203
35-SS680	Johnson/Evinrude		213	GS62780			203
35-SS685	Honda		213	GS62790			203
35-SS690	Yamaha		213	GS62800			203

1 This product is priced per piece. To order, priced per package, please add -9 to the part number
 2 Items ending in "D" are display packaged - regular number is non-display
 3 For discount shop pack of 10, please add -10 to the part number

SIERRA #	O.E.M.	O.E. #	PAGE #	SIERRA #	O.E.M.	O.E. #	PAGE #
SIERRA							
GS62810			203	MP28860	Yamaha	682-82556-00-00	30, 475
GS62820			203	MP28860			30, 475
GS62830			203	MP28870	OMC	585134	30, 259
GS62840			204	MP28870			30, 259
GS62850			204	MP28880	OMC	432230	30, 259, 871
GS62860			204	MP28890	OMC	176288	30, 259, 871
GS62870			204	MP28900	OMC	432230	30, 260
GS62880			204	MP28902-1	OMC	432230	30, 260
GS62890			204	MP39100	OMC	386545	29, 30, 259
GS62900			204	MP39160			44, 475
GS62910			204	MP39760	OMC	393301	28, 259
GS62920			204	MP39760	OMC	508180	28, 259
GSS62600			204	MP39830	OMC	386545	29, 259
GSS62610			204	MP41000	Mercury Marine	87-88107	28, 363
GSS62630			204	MP41070-2	Mercury Marine	87-17009A2	28, 363
GSS62640			204	MP51010	Suzuki	37110-99-E00	23, 460
GSS62670			204	MP51012	Suzuki	37110-99-E00	23, 460
GSS62680			204	MP51020	Yamaha	703-82510-12-00	23, 475
GSS62700			204	MP51022	Yamaha	703-82510-12-00	23, 475
GSS62710			204	MP51030	Yamaha	61B-82510-00-00	23, 475
GSS62720			204	MP51030	Yamaha	61B-82510-01-00	23, 475
GSS62740			204	MP51032	Yamaha	61B-82510-01-00	23, 475
GSS62750			204	MP51040	Yamaha	703-82510-43-00	23, 475
GSS62760			204	MP51042	Yamaha	703-82510-43-00	23, 475
GSS62770			204	MP51050	Yamaha	6K1-82510-06-00	23, 475
GSS62780			204	MP51052	Yamaha	6K1-82510-06-00	23, 475
GSS62790			204	MP51090	Mercury Marine	87-17009A5	23, 29, 363
GSS62800			204	MP51092	Mercury Marine	87-17009A5	23, 29, 363
GSS62820			204	MP52000	Mercury Marine	87-88107A5	23, 29, 363
GSS62830			204	MP52002	Mercury Marine	87-88107A5	23, 29, 363



1 This product is priced per piece. To order, priced per package, please add -9 to the part number
 2 Items ending in "D" are display packaged - regular number is non-display
 3 For discount shop pack of 10, please add -10 to the part number

UNMATCHED VARIETY



Sierra sells the widest variety of marine oils and lubricants on the market. Extend the life of your engine with proper care and the right mix of Sierra products all backed by the best warranty in the marine business.

Our extensive line of top performing filtration products provide coverage that is second to none.

The Very Best Parts of Boating
www.sierramarine.com

Sierra
Marine Engine and Drive Parts

Gang's Ti
Caged By
In Miss



...the ...
...the ...
...the ...

ROOSEVELT
TO WASH
AFTER VA

President Pleas
Of Events by
With Enan

...the ...
...the ...
...the ...

...the ...
...the ...
...the ...

OIL FILTER QUICK-REFERENCE GUIDE

All listed oil capacities are approximate amounts only and may or may not include the oil filter capacity.
 ALWAYS follow proper crankcase drain and fill procedures. Check engine dipstick for proper crankcase oil level.

ALBIN

Model	Year	Oil Filter	Replaces	Crankcase Capacity	Recommended Oil
AD-21		18-7878-1	3875827	See Owners Manual	See Owners Manual

B & W LATHROP

Model	Year	Oil Filter	Replaces	Crankcase Capacity	Recommended Oil
130155		18-7875		See Owners Manual	See Owners Manual

CATERPILLAR

Model	Year	Oil Filter	Replaces	Crankcase Capacity	Recommended Oil
3304, 3306, D330		18-7880	1R-0658	See Owners Manual	See Owners Manual
3116, 3116TA, 3208, 3208T, 3208TA		18-7927	1R-0714	See Owners Manual	See Owners Manual

CHRIS-CRAFT

Model	Year	Oil Filter	Replaces	Crankcase Capacity	Recommended Oil
307G, 305K, 307K		18-7824-2	16.81-08746	See Owners Manual	See Owners Manual

CHRYSLER

Model	Year	Oil Filter	Replaces	Crankcase Capacity	Recommended Oil
(Chrysler-Volvo) 100, 110, 120, 130,		18-7878-1		See Owners Manual	See Owners Manual
165, 170		18-7878-1		See Owners Manual	See Owners Manual
125, 150, 155, 175, Fury 190, 195, 200,		18-7875	1851658	See Owners Manual	See Owners Manual
210, 225, 235, 250, 260, 280, 300, 330,		18-7875	1851658	See Owners Manual	See Owners Manual
335, 375, 525, CM6-55, CMC-55NA,		18-7875	1851658	See Owners Manual	See Owners Manual
M-170A, M-225A, M-225D, M-273A,		18-7875	1851658	See Owners Manual	See Owners Manual
M-273B, M-273BO/D, LM-318, LM-318A,		18-7875	1851658	See Owners Manual	See Owners Manual
LM-318B, M-318B, M-318C, M-383B,		18-7875	1851658	See Owners Manual	See Owners Manual
M-413B, M-413D, M-413E, M-440B,		18-7875	1851658	See Owners Manual	See Owners Manual
M-440D, Model 340, M-80, M-81,		18-7875	1851658	See Owners Manual	See Owners Manual
Super Crown 145, 150, Imperial 290,		18-7875	1851658	See Owners Manual	See Owners Manual
325, Jet II, Jet III, Jet IV, Super Bee,		18-7875	1851658	See Owners Manual	See Owners Manual
Super Bee II, Super Bee III,		18-7875	1851658	See Owners Manual	See Owners Manual
V-8 Engines 1962-on		18-7875	1851658	See Owners Manual	See Owners Manual
V-6 GM		18-7879-1	L-319	See Owners Manual	See Owners Manual
3.7L, 5.2L		18-7878-1	3549957, L-19, L1008	See Owners Manual	See Owners Manual

COMMANDER

Model	Year	Oil Filter	Replaces	Crankcase Capacity	Recommended Oil
225, 340 Clevor		18-7875		See Owners Manual	See Owners Manual

CRUSADER

Model	Year	Oil Filter	Replaces	Crankcase Capacity	Recommended Oil
150, 160, 165, CH185, 210, CH220,		18-7824-2	201104	See Owners Manual	See Owners Manual
CH270, 350, CH350		18-7824-2	201104	See Owners Manual	See Owners Manual
SS330		18-7876 (Long), 18-7824-2 (Short)	201104	See Owners Manual	See Owners Manual
220 Conqueror, 255 Conqueror,		18-7875	9002514	See Owners Manual	See Owners Manual
255 Conqueror Jet, 250 ('71),		18-7875	9002514	See Owners Manual	See Owners Manual
300 Scorpion, 460		18-7875	9002514	See Owners Manual	See Owners Manual
220, 300, 320, 325		18-7878-1		See Owners Manual	See Owners Manual
5.0L Carbureted (Classic)	1999 - 2008	18-7875	22679	See Owners Manual	API 15W-40 SM or Higher
5.7L Carbureted (Classic)	1999 - 2010	18-7875	22679	See Owners Manual	API 15W-40 SM or Higher
5.0L MPI (Captain's Choice)	2004 - 2010	18-7875	22679	5.67L / 6.0 Qt.	API 15W-40 SM or Higher
5.7L MPI (Captain's Choice)	2005 - 2010	18-7875	22679	5.67L / 6.0 Qt.	API 15W-40 SM or Higher

CRUSADER CONTINUED ON NEXT PAGE

OIL FILTER QUICK-REFERENCE GUIDE

CRUSADER

Model	Year	Oil Filter	Replaces	Crankcase Capacity	Recommended Oil
6.0L MPI (Captain's Choice)	2006 - 2010	18-7875	22679	4.75L / 5.0 Qt.	API 15W-40 SM or Higher
7.4L MPI (Captain's Choice)	All	18-7875	22679	See Owners Manual	API 15W-40 SM or Higher
8.1L MPI (Captain's Choice)	2001 - 2010	18-7875	22679	6.65 L / 7.0 Qt.	API 15W-40 SM or Higher
8.1L MPI HO (Captain's Choice)	2009 - 2010	18-7875	22679	6.65 L / 7.0 Qt.	API 15W-40 SM or Higher

DETROIT DIESEL

Model	Year	Oil Filter	Replaces	Crankcase Capacity	Recommended Oil
2-71 (142), 3-71 (213), 4-53 (212), 4-71 (284), 6V-53 (318), 6-71 (426), 6-71E		N/A	25010495	See Owners Manual	See Owners Manual
(426), 671N (426), 6-71T (426), 6V-71		N/A	25010495	See Owners Manual	See Owners Manual
(426), 6V-71T (426), 6V-92 (552), 6V-92T		N/A	25010495	See Owners Manual	See Owners Manual
(522), 8V-71 (568), 8V-71T (568), 8V-92		N/A	25010495	See Owners Manual	See Owners Manual
(736), 8V-92T (736), 12V-71 (1788),		N/A	25010495	See Owners Manual	See Owners Manual
12V-71T (1788), 12V-149 (1788), 16V-71		N/A	25010495	See Owners Manual	See Owners Manual
(1136), 16V-71T (1136), 16V-92 (1472),		N/A	25010495	See Owners Manual	See Owners Manual
16V-92T (1472), 16V-149 (2384) Series		N/A	25010495	See Owners Manual	See Owners Manual

EVINRUDE / JOHNSON

Model	Year	Oil Filter	Replaces	Crankcase Capacity	Recommended Oil
9.9 HP	1995-2001	18-7916	434839	1272 ml. / 43 oz.	10W40 Synthetic Blend FC-W
9.9 HP	2002-2007	18-7903	5033102; 763364	1.1 L / 1.2 Qt.	10W40 Synthetic Blend FC-W
15 HP	1995-2001	18-7916	434839	1272 ml. / 43 oz.	10W40 Synthetic Blend FC-W
15 HP	2002-2007	18-7903	5033102; 763364	1.1 L / 1.2 Qt.	10W40 Synthetic Blend FC-W
25 HP	2000-2001	18-7915-1	5031411; 778885	3.2 L / 3.4 Qt.	10W40 Synthetic Blend FC-W
25 HP	2004-2007	18-7915-1	5031411; 778885	3.2 L / 3.4 Qt.	10W40 Synthetic Blend FC-W
30 HP	2000-2001	18-7915-1	5031411; 778885	3.2 L / 3.4 Qt.	10W40 Synthetic Blend FC-W
30 HP	2004-2007	18-7915-1	5031411; 778885	3.2 L / 3.4 Qt.	10W40 Synthetic Blend FC-W
40 HP	1999-2006	18-7915-1	5031411; 778885	2.4 L / 2.5 Qt.	10W40 Synthetic Blend FC-W
50 HP	1999-2006	18-7915-1	5031411; 778885	2.4 L / 2.5 Qt.	10W40 Synthetic Blend FC-W
60 HP	2002-2006	18-7915-1	5031411; 778885	4.5 L / 4.8 Qt.	10W40 Synthetic Blend FC-W
70 HP	1998-2000	18-7916	434839	4.5 L / 4.8 Qt.	10W40 Synthetic Blend FC-W
70 HP	2001-2006	18-7915-1	5031411; 778885	4.5 L / 4.8 Qt.	10W40 Synthetic Blend FC-W
90 HP	2003-2006	18-7896	5033539; 778886	5.7 L / 6.0 Qt.	25W40 Synthetic Blend FC-W
115 HP	2003-2006	18-7896	5033539; 778886	5.7 L / 6.0 Qt.	25W40 Synthetic Blend FC-W
140 HP	2003-2006	18-7897	5033919; 778887	5.7 L / 6.0 Qt.	25W40 Synthetic Blend FC-W
200 HP	2004-2006	18-7895	5035703; 778888	8.2 L / 8.7 Qt.	25W40 Synthetic Blend FC-W
225 HP	2004-2006	18-7895	5035703; 778888	8.2 L / 8.7 Qt.	25W40 Synthetic Blend FC-W

FISCHER PANDA

Model	Year	Oil Filter	Replaces	Crankcase Capacity	Recommended Oil
PMS 8 Mini		23-7804	SE15853-99170	2.5L / 2.64 Qt.	15W-40 API CF or Higher
PMS 8 DP		23-7804	SE15853-99170	2.5L / 2.64 Qt.	15W-40 API CF or Higher
PMS 4200		23-7804	SE15853-99170	1L / 1.05 Qt.	15W-40 API CF or Higher
PMS 6500		23-7804	SE15853-99170	2.5L / 2.64 Qt.	15W-40 API CF or Higher
PMS 12 DP		23-7804	SE15853-99170	3.8L / 4.0 Qt.	15W-40 API CF or Higher
PMS 12 Mini		23-7804	SE15853-99170	3.8L / 4.0 Qt.	15W-40 API CF or Higher
PMS 16 DP		23-7842		See Owners Manual	15W-40 API CF or Higher
PMS 22		23-7842		See Owners Manual	15W-40 API CF or Higher
16V-92T (1472), 16V-149 (2384) Series		N/A	25010495	See Owners Manual	See Owners Manual

OIL FILTER QUICK-REFERENCE GUIDE

FLAGSHIP

Model	Year	Oil Filter	Replaces	Crankcase Capacity	Recommended Oil
150FA, 220FF, 250FA, 400FA,		18-7824-2		See Owners Manual	See Owners Manual
425FAJ, 650FAJ, 950FAJ		18-7824-2		See Owners Manual	See Owners Manual
292, 300, 307, 327, 350, 482		18-7824-2 (Short) 18-7876 (Long)		See Owners Manual	See Owners Manual

FORD

Model	Year	Oil Filter	Replaces	Crankcase Capacity	Recommended Oil
CSG850M, WSG858M, LSG875M,		18-7875		See Owners Manual	See Owners Manual
SSD-655,-655M, -655MT, (5.5 Liter),		18-7875		See Owners Manual	See Owners Manual
140(2.3L) FOUR, 170, 200 Six, 240 Six,		18-7875		See Owners Manual	See Owners Manual
300 Six, 302 (5.0L),351 (5.8L),		18-7875		See Owners Manual	See Owners Manual
460 (7.5L),2711E, 2712E, 2713E,		18-7875		See Owners Manual	See Owners Manual
2714E, 2715E (diesel)		18-7875		See Owners Manual	See Owners Manual
254 (DSD-442 4.2 Liter), 362		18-7875		See Owners Manual	See Owners Manual
(DSD-659 5.9 Liter)		18-7875		See Owners Manual	See Owners Manual
91—V4, 104 V4, 380 (DSD-662 6.2 Liter)		18-7878-1		See Owners Manual	See Owners Manual

GM

Model	Year	Oil Filter	Replaces	Crankcase Capacity	Recommended Oil
IL6-194	1962 - 1967	18-7876		See Owners Manual	See Owners Manual
IL6-230	1963 - 1968	18-7876		See Owners Manual	See Owners Manual
267	1979 - 1981	18-7876		See Owners Manual	See Owners Manual
305	1976 - 1987	18-7876		See Owners Manual	See Owners Manual
307	1970 - 1973	18-7876		See Owners Manual	See Owners Manual
350	1970 - 1987	18-7876		See Owners Manual	See Owners Manual
366	1970 - 1987	18-7876		See Owners Manual	See Owners Manual
400	1971 - 1972	18-7876		See Owners Manual	See Owners Manual
400	1975 - 1983	18-7876		See Owners Manual	See Owners Manual
454	1973 - 1987	18-7876		See Owners Manual	See Owners Manual
400	1974 - 1977	18-7824-2		See Owners Manual	See Owners Manual

GREENWICH

Model	Year	Oil Filter	Replaces	Crankcase Capacity	Recommended Oil
Porpoise (w/IH V8-275B)		18-7875		See Owners Manual	See Owners Manual

HONDA

Model	Year	Oil Filter	Replaces	Crankcase Capacity	Recommended Oil
BF2A	All	----	----	0.40 L / 0.42 Qt.	10W-30 FC-W
BF2D	All	----	----	0.25 L / 0.26 Qt.	10W-30 FC-W
BF5	All	----	----	0.55 L / 0.58 Qt.	10W-30 FC-W
BF75 (7.5hp)	All	----	----	0.76 L / 0.80 Qt.	10W-30 FC-W
BF8 / BFP8	2001 - Current	18-7913	15400-PFB-014 15400-PFB-004	0.76 L / 0.80 Qt.	10W-30 FC-W
BF9.9 / BFP9.9	2001 - Current	18-7913	15400-PFB-014 15400-PFB-004	1.1L / 1.2 Qt.	10W-30 FC-W
BF100 (10 hp.)		----	----	0.76 L / 0.80 Qt.	10W-40 FC-W
BF15 / BFP15	2003 - Current	18-7913	15400-PFB-014 15400-PFB-004	1.1L / 1.2 Qt.	10W-30 FC-W
BF20	2003 - Current	18-7913	15400-PFB-014 15400-PFB-004	1 L / 1.1 Qt.	10W-30 FC-W

All listed oil capacities are approximate amounts only and may or may not include the oil filter capacity.
ALWAYS follow proper crankcase drain and fill procedures. Check engine dipstick for proper crankcase oil level.

HONDA CONTINUED ON NEXT PAGE

OIL FILTER QUICK-REFERENCE GUIDE

HONDA

Model	Year	Oil Filter	Replaces	Crankcase Capacity	Recommended Oil
BF25	1998 & Earlier	18-7913	15400-PFB-014 15400-PFB-004 15400-PM3-004 15400-PJ7-015	1.6L / 1.7 Qt.	10W-30 FC-W
BF25 (Up to serial number 1003206)	1999 - 2005	18-7911-1	15400-PFB-007	1.6L / 1.7 Qt.	10W-30 FC-W
BF25 (Starting serial number 1003207)	2005 - Current	18-7913	15400-PFB-014	1.6L / 1.7 Qt.	5W-30 FC-W
BF30	1998 & Earlier	18-7913	15400-PFB-014 15400-PFB-004 15400-PM3-004 15400-PJ7-015	1.6L / 1.7 Qt.	10W-30 FC-W
BF30 (Up to serial number 1005016)	1999 - 2005	18-7911-1	15400-PFB-007	1.6L / 1.7 Qt.	10W-30 FC-W
BF30 (Starting serial number 1005017)	2005 - Current	18-7913	15400-PFB-014	1.6L / 1.7 Qt.	5W-30 FC-W
BF35	1997	18-7913	15400-PFB-014 15400-PFB-004 15400-PM3-004 15400-PJ7-015	2.4L / 2.5 Qt.	10W-30 FC-W
BF40	1998 & Earlier	18-7913	15400-PFB-014		
			15400-PFB-004	2.4L / 2.5 Qt.	10W-30 FC-W
BF40 (Up to serial number 3007642)	1999 - 2005	18-7911-1	15400-PFB-007	2.4L / 2.5 Qt.	10W-30 FC-W
BF40 (Starting serial number 3007643)	2005 - Current	18-7913	15400-PFB-014	2.0L / 2.1 Qt.	5W-30 FC-W
BF45	1997	18-7913	15400-PFB-014 15400-PFB-004 15400-PM3-004 15400-PJ7-015	2.4L / 2.5 Qt.	10W-30 FC-W
BF50	1998 & Earlier	18-7913	15400-PFB-014 15400-PFB-004 15400-PM3-004 15400-PJ7-015	2.4L / 2.5 Qt.	10W-30 FC-W
BF50 (Up to serial number 3014456)	1999 - 2005	18-7911-1	15400-PFB-007	2.4L / 2.5 Qt.	10W-30 FC-W
BF50 (Starting serial number 301457)	2005 - Current	18-7913	15400-PFB-014	2.0L / 2.1 Qt.	5W-30 FC-W
BF60 / BFP60	All	18-7913	15400-PFB-014 15400-PFB-004	2.6L / 2.7 Qt.	10W-30 FC-W
BF75	1997 - Current	18-7909	15400-PLM-A01PE 15400-POH-305PE 15400-ZJ1-004	4.2L / 4.4 Qt.	10W-30 FC-W
BF90	1997 - Current	18-7909	15400-PLM-A01PE 15400-POH-305PE 15400-ZJ1-004	4.2L / 4.4 Qt.	10W-30 FC-W
BF115	1999 - 2009	18-7909	15400-PLM-A01PE 15400-POH-305PE 15400-ZJ1-004	5.6L / 5.9 Qt.	10W-30 FC-W
BF115	2010 - Current	18-7909	15400-PLM-A01PE 15400-POH-305PE 15400-ZJ1-004	6.5L / 6.9Qt.	10W-30 FC-W
BF130	1999 - 2004	18-7909	15400-PLM-A01PE 15400-POH-305PE 15400-ZJ1-004	5.6L / 5.9 Qt.	10W-30 FC-W
BF135	2004 - Current	18-7909	15400-PLM-A01PE 15400-POH-305PE 15400-ZJ1-004	6.5L / 6.9Qt.	10W-30 FC-W
BF150	2004 - Current	18-7909	15400-PLM-A01PE 15400-POH-305PE 15400-ZJ1-004	6.5L / 6.9Qt.	10W-30 FC-W

HONDA CONTINUED ON NEXT PAGE

OIL FILTER QUICK-REFERENCE GUIDE

HONDA

Model	Year	Oil Filter	Replaces	Crankcase Capacity	Recommended Oil
BF200	2002 - Current	18-7909	15400-PLM-A01PE 15400-P0H-305PE 15400-ZJ1-004	7.6L / 8.0 Qt.	10W-30 FC-W
BF225	2002 - Current	18-7909	15400-PLM-A01PE 15400-P0H-305PE 15400-ZJ1-004	7.6L / 8.0 Qt.	10W-30 FC-W

HYDRO-MARINE

Model	Year	Oil Filter	Replaces	Crankcase Capacity	Recommended Oil
All Models (Knecht F0335/1)		18-7875		See Owners Manual	See Owners Manual

INDMAR

Model	Year	Oil Filter	Replaces	Crankcase Capacity	Recommended Oil
200, 225, 250, 275 (SP), 300 (SP), 350-2, 350-4,	1993 & OLDER	18-7875			
350(SP), 454-2, 454-4, 400 (SP)		18-7824-2 (Short) 18-7876 (Long)		See Owners Manual	See Owners Manual
454 Carb	2003 - 2006	18-7824-2	501001	6.62L / 7.0 Qt.	15W-40 API SL/SJ/C14/
5.7 HO	2007 - 2009	18-7824-2	501001	See Owners Manual	15W-40 API SL/SJ/C14/
5.7 Vortec	2007 - 2012	18-7824-2	501001	5.25L / 5.5 Qt.	15W-40 API SL/SJ/C14/
5.7L MPFI	2007 - 2012	18-7824-2	501001	5.25L / 5.5 Qt.	15W-40 API SL/SJ/C14/
502 Carb	2003 - 2006	18-7824-2	501001	6.62L / 7.0 Qt.	15W-40 API SL/SJ/C14/
6.0 PFI	2003 - 2006	18-7824-2	501001	See Owners Manual	15W-40 API SL/SJ/C14/
8.1L Vortec (Remote Oil Filter)	2007 - 2009	18-7824-2	501001	9.5L / 10 Qt.	15W-40 API SL/SJ/C14/
Assault 310, 325, 340, 385	2003 - 2007	18-7824-2	501001	See Owners Manual	15W-40 API SL/SJ/C14/
Malibu 350 Vortec Carbureted	2003 - 2005	18-7824-2	501001	5.25L / 5.5 Qt.	15W-40 API SL/SJ/C14/
Malibu Anniversary Edition LS6	2007	18-7824-2	501001	5.25L / 5.5 Qt.	15W-40 API SL/SJ/C14/
Malibu Hammerhead	2003 - 2007	18-7824-2	501001	5.25L / 5.5 Qt.	15W-40 API SL/SJ/C14/
Malibu LC2	2003 - 2006	18-7824-2	501001	See Owners Manual	15W-40 API SL/SJ/C14/
Malibu LS1	2003 - 2006	18-7824-2	501001	5.25L / 5.5 Qt.	15W-40 API SL/SJ/C14/
Malibu Monsoon	2003 - 2007	18-7824-2	501001	See Owners Manual	15W-40 API SL/SJ/C14/
MasterCraft 5.7L LCR	2007 - 2009	18-7824-2	501001	See Owners Manual	15W-40 API SL/SJ/C14/
MasterCraft 6.0L (LY5, LY6)	2007 - 2009	18-7824-2	501001	5.25L / 5.5 Qt.	15W-40 API SL/SJ/C14/
MasterCraft LQ9	2003 - 2006	18-7824-2	501001	5.25L / 5.5 Qt.	15W-40 API SL/SJ/C14/
MasterCraft MCX	2003 - 2007	18-7824-2	501001	See Owners Manual	15W-40 API SL/SJ/C14/C14Plus
MasterCraft RTP-1	2003 - 2007	18-7824-2	501001	6.62L / 7.0 Qt.	15W-40 API SL/SJ/C14/

INTERCEPTOR

Model	Year	Oil Filter	Replaces	Crankcase Capacity	Recommended Oil
IV4-80, OV4-80, OV6-100 (Taurus), 80, 85, 100, 110, 120, 140, 190, 200, 210, Interceptor 160, Interceptor 165	1960 & UP	18-7878-1		See Owners Manual	See Owners Manual

All listed oil capacities are approximate amounts only and may or may not include the oil filter capacity.
ALWAYS follow proper crankcase drain and fill procedures. Check engine dipstick for proper crankcase oil level.

OIL FILTER QUICK-REFERENCE GUIDE

KOHLER

Model	Cyl.	Year	Oil Filter	Replaces	Crankcase Capacity	Recommended Oil
4CZ	2	ALL	23-7823	267714	1.4L / 1.48 Qt.	10W-40
4EF	2	ALL	23-7821	359771	1.36L / 1.44 Qt.	
4ESZ	2	ALL	23-7823	267714	Refer to Owners Manual	10W-40
5E	2	ALL	23-7821	359771	1.36L / 1.44 Qt.	
6.5CZ	2	ALL	23-7823	267714	1.4L / 1.48 Qt.	10W-40
6.5ESZ	2	ALL	23-7823	267714	Refer to Owners Manual	10W-40
7.3E	2	ALL	23-7821	359771	1.36L / 1.44 Qt.	10W-40
10EOZ	3	ALL	23-7824	GM47465 252834	5.2L / 5.5 Qt.	15W-40 API CI-4, CI-4 Plus
10EOZD	3	ALL	23-7824 (Variation 1)	GM47465 252834	3.6L / 3.8 Qt.	15W-40 API CI-4, CI-4 Plus
13.5CCOZ	3	ALL	23-7824	GM47465 252834	5.8L / 6.1 Qt.	15W-40 API CI-4, CI-4 Plus
13EOZ	3	ALL	23-7824	GM47465 252834	4.7L / 5.0 Qt.	15W-40 API CI-4, CI-4 Plus
13EOZD	3	ALL	23-7824	GM47465 252834	4.7L / 5.0 Qt.	15W-40 API CI-4, CI-4 Plus
14CCOZ	3	ALL	23-7824	GM47465 252834	Refer to Owners Manual	15W-40 API CI-4, CI-4 Plus
14EOZ	3	ALL	23-7824	GM47465 252834	4.7L / 5.0 Qt.	15W-40 API CI-4, CI-4 Plus
14EOZD	3	ALL	23-7824	GM47465 252834	4.7L / 5.0 Qt.	15W-40 API CI-4, CI-4 Plus
15.5EOZ	3	ALL	23-7824	GM47465 252834	4.7L / 5.0 Qt.	15W-40 API CI-4, CI-4 Plus
15.5EOZD	3	ALL	23-7824	GM47465 252834	4.7L / 5.0 Qt.	15W-40 API CI-4, CI-4 Plus
5CCOZ	3	ALL	23-7822	229678	Refer to Owners Manual	Refer to Owners Manual
5EOZ	3	ALL	23-7822	229678	3.0L / 3.2 Qt.	15W-40 API CI-4, CI-4 Plus
8EOZ	3	ALL	23-7822	229678	2.3L / 2.4 Qt.	15W-40 API CI-4, CI-4 Plus
9CCOZ	3	ALL	23-7824	GM47465 252835	Refer to Owners Manual	Refer to Owners Manual
9EOZ	3	ALL	23-7824	GM47465 252835	Refer to Owners Manual	15W-40 API CI-4, CI-4 Plus
9EOZD	3	ALL	23-7824 (Variation 1)	GM47465 252835	3.6L / 3.8 Qt.	15W-40 API CI-4, CI-4 Plus
10E	4	ALL	23-7803		3.25L / 3.50 Qt.	10W-40
12.5E	4	ALL	23-7803	326817	3.25L / 3.50 Qt.	10W-40
15C	4	ALL	23-7820	279449	4.7L / 5.0 Qt.	10W-40
16CF	4	ALL	23-7820	279449	Refer to Owners Manual	Refer to Owners Manual
18.5CCOZ	4	ALL	23-7824	GM47465 252834	5.8L / 6.1 Qt.	Refer to Owners Manual
20C	4	ALL	23-7820	279449	4.7L / 5.0 Qt.	10W-40
20EOZ	4	ALL	23-7824	GM47465 252834	5.8L / 6.1 Qt.	15W-40 API CI-4, CI-4 Plus
20EOZD	4	ALL	23-7824	GM47465 252834	5.8L / 6.1 Qt.	15W-40 API CI-4, CI-4 Plus

KOHLER CONTINUED ON NEXT PAGE

OIL FILTER QUICK-REFERENCE GUIDE

KOHLER

Model	Cyl.	Year	Oil Filter	Replaces	Crankcase Capacity	Recommended Oil
23EOZ	4	ALL	23-7824	GM47465 252834	5.8L / 6.1 Qt.	15W-40 API CI-4, CI-4 Plus
23EOZD	4	ALL	23-7824	GM47465 252834	5.8L / 6.1 Qt.	15W-40 API CI-4, CI-4 Plus
24CCOZ	4	ALL	23-7824	GM47465 252834	5.8L / 6.1 Qt.	Refer to Owners Manual
24EOZ	4	ALL	23-7824	GM47465 252834	5.8L / 6.1 Qt.	15W-40 API CI-4, CI-4 Plus
24EOZD	4	ALL	23-7824	GM47465 252834	5.8L / 6.1 Qt.	15W-40 API CI-4, CI-4 Plus
28EOZ	4	ALL	23-7824	GM47465 252834	10.2L / 10.78 Qt.	15W-40 API CI-4, CI-4 Plus
28EOZD	4	ALL	23-7824	GM47465 252834	10.2L / 10.78 Qt.	15W-40 API CI-4, CI-4 Plus
32EOZ	4	ALL	23-7824	GM47465 252834	10.2L / 10.78 Qt.	15W-40 API CI-4, CI-4 Plus
32EOZD	4	ALL	23-7824	GM47465 252835	10.2L / 10.78 Qt.	15W-40 API CI-4, CI-4 Plus
8E	4	ALL	23-7803	326817	3.25L / 3.50 Qt.	10W-40

LEHMAN

Model	Oil Filter	Replaces	Crankcase Capacity	Recommended Oil
Models (w/ Ford 242), (w/ Ford 254), (w/ Ford 363), (w/ Ford 380), (Lehman 2N50)	18-7875		See Owners Manual	See Owners Manual

MERCURISER

Model	Cyl.	CID/Litre	Year	Oil Filter	Replaces	Crankcase Capacity	Recommended Oil
ALL CYLINDER BLOCKS MANUFACTURED BY GENERAL MOTORS (GM) UNLESS NOTED IN MODEL COLUMN							
Vazer	4	1.6L	2007 - 2010	18-7824-2	35-866340K01	4.02L / 4.25 Qt.	25W-40 FC-W
Vazer	4	1.6L	2011 - Current	18-7824-2	35-866340K01	4.02L / 4.25 Qt.	20W-40 Synthetic Catalyst (1)
60 (Renault)	4	68 / 1.1L	1965 - 1968	-----	38463	2.6L / 2.75 Qt.	See Owners Manual
80 (Renault)	4	80 / 1.3L	1966 - 1969	-----	-----	4.7L / 5.0 Qt.	See Owners Manual
90 (Renault)	4	96 / 1.6L	1970 - 1972	-----	-----	4.7L / 5.0 Qt.	See Owners Manual
110	4	153 / 2.5L	1963 - 1966	18-7824-2	35-866340K01	3.8L / 4.0 Qt.	See Owners Manual
120	4	153 / 2.5L	1964 - 1986	18-7824-2	35-866340K01	3.8L / 4.0 Qt.	25W-40 FC-W
140	4	181 / 3.0L	1968 - 1986	18-7824-2	35-866340K01	3.8L / 4.0 Qt.	25W-40 FC-W
165	4	224 / 3.7L	1987	18-7824-2	35-866340K01	5.2L / 5.5 Qt.	25W-40 FC-W
170	4	224 / 3.7L	1985 - 1986	18-7824-2	35-866340K01	5.2L / 5.5 Qt.	25W-40 FC-W
180	4	224 / 3.7L	1987	18-7824-2	35-866340K01	6.1L / 6.5 Qt.	25W-40 FC-W
190	4	224 / 3.7L	1985 - 1986	18-7824-2	35-866340K01	6.1L / 6.5 Qt.	25W-40 FC-W
2.5L	4	153 / 2.5L	1987 - 1989	18-7824-2	35-866340K01	3.8L / 4.0 Qt.	25W-40 FC-W
3.0L / LX	4	181 / 3.0L	1987 - 2010	18-7824-2	35-866340K01	3.8L / 4.0 Qt.	25W-40 FC-W
3.0L MPI EC (Catalyzed)	4	182 / 3.0L	2011 - Current	18-7824-2	35-866340K01	3.8L / 4.0 Qt.	20W-40 Synthetic Catalyst (1)
3.7L	4	224 / 3.7L	1988 - 1989	18-7824-2	35-866340K01	5.2L / 5.5 Qt.	25W-40 FC-W
3.7LX	4	224 / 3.7L	1983 - 1989	18-7824-2	35-866340K01	6.1L / 6.5 Qt.	25W-40 FC-W
470	4	224 / 3.7L	1976 - 1984	18-7824-2	35-866340K01	5.2L / 5.5 Qt.	25W-40 FC-W
485	4	224 / 3.7L	1980 - 1982	18-7824-2	35-866340K01	5.4L / 5.75 Qt.	25W-40 FC-W
488	4	224 / 3.7L	1983 - 1984	18-7824-2	35-866340K01	6.1L / 6.5 Qt.	25W-40 FC-W
140	6 IL	194 / 3.2L	1963	18-7876	35-99894	4.7L / 5.0 Qt.	25W-40 FC-W

All listed oil capacities are approximate amounts only and may or may not include the oil filter capacity.
ALWAYS follow proper crankcase drain and fill procedures. Check engine dipstick for proper crankcase oil level.

MERCURISER CONTINUED ON NEXT PAGE

OIL FILTER QUICK-REFERENCE GUIDE

MERCUISER

Model	Cyl.	CID/Litre	Year	Oil Filter	Replaces	Crankcase Capacity	Recommended Oil
150	6 IL	230 / 3.8L	1964 - 1966	18-7876	35-99894	4.7L / 5.0 Qt.	25W-40 FC-W
160	6 IL	250 / 4.1L	1967 - 1969	18-7876	35-99894	4.7L / 5.0 Qt.	25W-40 FC-W
165	6 IL	250 / 4.1L	1970 - 1981	18-7876	35-99894	4.7L / 5.0 Qt.	25W-40 FC-W
175	V6	262 / 4.3L	1987	18-7879-1*	35-883702	4.3L / 4.5 Qt.	25W-40 FC-W
185	V6	262 / 4.3L	1985 - 1987	18-7879-1*	35-883702	4.3L / 4.5 Qt.	25W-40 FC-W
200	6 IL	292 / 4.8L	1969	18-7876	35-99894	5.7L / 6.0 Qt.	25W-40 FC-W
205	V6	262 / 4.3L	1985 - 1987	18-7879-1*	35-883702	4.3L / 4.5 Qt.	25W-40 FC-W
262 Mag EFI	V6	263 / 4.3L	1996 - 1997	18-7879-1*	35-883702	4.3L / 4.5 Qt.	25W-40 FC-W
4.3L / LX / LH / LXH	V6	264 / 4.3L	1988 - 2001	18-7879-1*	35-883702	4.3L / 4.5 Qt.	25W-40 FC-W
4.3L	V6	265 / 4.3L	2002 - 2010	18-7879-1*	35-883702	4.3L / 4.5 Qt.	25W-40 FC-W
4.3L EFI	V6	266 / 4.3L	1998 - 2001	18-7879-1*	35-883702	4.3L / 4.5 Qt.	25W-40 FC-W
4.3L MPI	V6	267 / 4.3L	2002 - 2010	18-7879-1*	35-883702	3.8L / 4.0 Qt.	25W-40 FC-W
4.3L MPI (Catalyzed)	V6	268 / 4.3L	2011 - Current	18-7824-2	35-866340K01	3.8L / 4.0 Qt.	20W-40 Synthetic Catalyst (1)
*NOTE: V6 engines equipped with the oil filter relocation option will use filter 18-7824-2.							
190	V8	283 / 4.6L	1963 - 1964	18-7824-2	35-866340K01	4.7L / 5.0 Qt.	25W-40 FC-W
198	V8	305 / 5.0L	1977 - 1988	18-7876	35-99894	5.7L / 6.0 Qt.	25W-40 FC-W
200	V8	305 / 5.0L	1985 - 1987	18-7824-2	35-866340K01	4.7L / 5.0 Qt.	25W-40 FC-W
215 (Ford)	V8	302 / 5.0L	1970 - 1972	18-7875	35-802886	6.6L / 7.0 Qt.	25W-40 FC-W
225 (Ford)	V8	302 / 5.0L	1973 - 1974	18-7875	35-802886	5.7L / 6.0 Qt.	25W-40 FC-W
225	V8	327 / 5.4L	1963 - 1966	18-7824-2	35-866340K01	4.7L / 5.0 Qt.	25W-40 FC-W
225	V8	327 / 5.4L	1967 - 1969	18-7824-2	35-866340K01	6.6L / 7.0 Qt.	25W-40 FC-W
228	V8	305 / 5.0L	1977 - 1978	18-7824-2	35-866340K01	4.7L / 5.0 Qt.	25W-40 FC-W
230	V8	305 / 5.0L	1985 - 1987	18-7824-2	35-866340K01	5.2L / 5.5 Qt.	25W-40 FC-W
233 (Ford)	V8	351 / 5.8L	1975 - 1977	18-7875	35-802886	4.7L / 5.0 Qt.	25W-40 FC-W
233 (Ford) Inboard	V8	351 / 5.8L	1973 - 1976	18-7875	35-802886	6.6L / 7.0 Qt.	25W-40 FC-W
250	V8	327 / 5.4L	1969	18-7876	35-99894	6.6L / 7.0 Qt.	25W-40 FC-W
250	V8	327 / 5.4L	1968	18-7876	35-99894	5.7L / 6 Qt.	25W-40 FC-W
250	V8	350 / 5.7L	1975 - 1977	18-7876	35-99894	4.7L / 5.0 Qt.	25W-40 FC-W
255	V8	350 / 5.7L	1975 - 1977	18-7876	35-99894	4.7L / 5.0 Qt.	25W-40 FC-W
255 (Ford)	V8	351 / 5.8L	1973 - 1974	18-7875	35-802886	4.7L / 5.0 Qt.	25W-40 FC-W
255 (Ford) Inboard	V8	351 / 5.8L	1973 - 1976	18-7875	35-802886	6.6L / 7.0 Qt.	25W-40 FC-W
260	V8	350 / 5.7L	1975 - 1987	18-7824-2	35-866340K01	5.2L / 5.5 Qt.	25W-40 FC-W
270	V8	350 / 5.7L	1969 - 1972	18-7876	35-99894	6.6L / 7.0 Qt.	25W-40 FC-W
280 TRS	V8	350 / 5.7L	1975 - 1976	18-7876	35-99894	6.0L / 6.5 Qt.	25W-40 FC-W
300 Tempest	V8	350 / 5.7L	1985 - 1986	18-7876	35-99894	6.0L / 6.5 Qt.	25W-40 FC-W
320 EFI	V8	350 / 5.7L	1987 - 1989	18-7824-2	35-866340K01	6.0L / 6.5 Qt.	25W-40 FC-W
325	V8	427 / 7.0L	1969 - 1972	18-7876	35-99894	7.6L / 8.0 Qt.	25W-40 FC-W
325 Inboard	V8	427 / 7.0L	1968 - 1974	18-7824-2	35-866340K01	6.6L / 7.0 Qt.	25W-40 FC-W
330	V8	454 / 7.4L	1977 - 1981	18-7876	35-99894	5.7L / 6.0 Qt.	25W-40 FC-W
330	V8	454 / 7.4L	1982 - 1987	18-7824-2	35-866340K01	6.6L / 7.0 Qt.	25W-40 FC-W
350 Mag.	V8	350 / 5.7L	1986 - 1997	18-7824-2	35-866340K01	5.2L / 5.5 Qt.	25W-40 FC-W
350 Mag. EFI	V8	350 / 5.7L	1996 - 1997	18-7824-2	35-866340K01	5.2L / 5.5 Qt.	25W-40 FC-W
350 Mag. MPI	V8	350 / 5.7L	1996 - 2001	18-7824-2	35-866340K01	5.2L / 5.5 Qt.	25W-40 FC-W
350 Mag. MPI	V8	350 / 5.7L	2002 - 2010	18-7824-2	35-866340K01	4.25L / 4.5 Qt.	25W-40 FC-W
350 Mag. MPI (Catalyzed)	V8	350 / 5.7L	2011 - Current	18-7824-2	35-866340K01	4.25L / 4.5 Qt.	20W-40 Synthetic Catalyst (1)
370 TRS	V8	454 / 7.4L	1978 - 1987	18-7824-2	35-866340K01	5.7L / 6.0 Qt.	25W-40 FC-W
377 Scorpion	V8	377 / 6.2L	1997 - 2010	18-7824-2	35-866340K01	4.7L / 5.0 Qt.	25W-40 FC-W
390	V8	482 / 7.9L	1969 - 1970	18-7876	35-99894	7.6L / 8.0 Qt.	25W-40 FC-W

MERCUISER CONTINUED ON NEXT PAGE

OIL FILTER QUICK-REFERENCE GUIDE

MERCUISER

Model	Cyl.	CID/Litre	Year	Oil Filter	Replaces	Crankcase Capacity	Recommended Oil
390 Inboard	V8	482 / 7.9L	1969 - 1970	18-7876	35-99894	6.6L / 7.0 Qt.	25W-40 FC-W
400 TRS	V8	454 / 7.4L	1978 - 1987	18-7824-2	35-866340K01	6.6L / 7.0 Qt.	25W-40 FC-W
420	V8	454 / 7.4L	1987 - 1989	18-7824-2	35-866340K01	5.7L / 6.0 Qt.	25W-40 FC-W
425	V8	454 / 7.4L	1990 - 1993	18-7824-2	35-866340K01	7.6L / 8.0 Qt.	25W-40 FC-W
440 TRS Cyclone	V8	454 / 7.4L	1983 - 1986	18-7876	35-99894	6.6L / 7.0 Qt.	25W-40 FC-W
450	V8	454 / 7.4L	1995 - 1996	18-7876	35-99894	7.6L / 8.0 Qt.	25W-40 FC-W
454 Mag. Alpha	V8	454 / 7.4L	1986 - 1988	18-7824-2	35-866340K01	6.6L / 7.0 Qt.	25W-40 FC-W
454 Mag.	V8	454 / 7.4L	1989 - 1991	18-7824-2	35-866340K01	7.6L / 8.0 Qt.	25W-40 FC-W
454 Mag.	V8	454 / 7.4L	1992 - 1997	18-7824-2	35-866340K01	6.6L / 7.0 Qt.	25W-40 FC-W
454 Mag. EFI	V8	454 / 7.4L	1994 - 1996	18-7824-2	35-866340K01	6.6L / 7.0 Qt.	25W-40 FC-W
454 Mag. MPI	V8	454 / 7.4L	1996 - 2001	18-7824-2	35-866340K01	6.6L / 7.0 Qt.	25W-40 FC-W
460 TRS	V8	482 / 7.9L	1983 - 1986	18-7876	35-99894	9.4L / 10 Qt.	25W-40 FC-W
465	V8	502 / 8.2L	1990 - 1994	18-7824-2	35-866340K01	7.6L / 8.0 Qt.	25W-40 FC-W
496 Mag.	V8	496 / 8.1L	2001 - 2010	18-7824-2	35-866340K01	8.5L / 9.0 Qt.	25W-40 FC-W
496 Mag. HO	V8	496 / 8.1L	2001 - 2010	18-7824-2	35-866340K01	8.5L / 9.0 Qt.	25W-40 FC-W
496 Mag. (Catalyzed)	V8	496 / 8.1L	2011 - Current	18-7824-2	35-866340K01	8.5L / 9.0 Qt.	20W-40 Synthetic Catalyst (1)
496 Mag. HO (Catalyzed)	V8	496 / 8.1L	2011 - Current	18-7824-2	35-866340K01	8.5L / 9.0 Qt.	20W-40 Synthetic Catalyst (1)
5.0L	V8	305 / 5.0L	1988 - 1995	18-7824-2	35-866340K01	4.7L / 5.0 Qt.	25W-40 FC-W
5.0L	V8	305 / 5.0L	1998 - 2002	18-7824-2	35-866340K01	5.2L / 5.5 Qt.	25W-40 FC-W
5.0L	V8	305 / 5.0L	2003 - 2010	18-7824-2	35-866340K01	4.25L / 4.5 Qt.	25W-40 FC-W
5.0LX	V8	305 / 5.0L	1988 - 1995	18-7824-2	35-866340K01	5.2L / 5.5 Qt.	25W-40 FC-W
5.0 EFI	V8	305 / 5.0L	1998 - 2001	18-7824-2	35-866340K01	5.2L / 5.5 Qt.	25W-40 FC-W
5.0 MPI	V8	305 / 5.0L	2002 - 2010	18-7824-2	35-866340K01	4.25L / 4.5 Qt.	25W-40 FC-W
5.0 MPI (Catalyzed)	V8	305 / 5.0L	2011 - Current	18-7824-2	35-866340K01	4.25L / 4.5 Qt.	20W-40 Synthetic Catalyst (1)
5.7L	V8	350 / 5.7L	1978 - 2002	18-7824-2	35-866340K01	5.2L / 5.5 Qt.	25W-40 FC-W
5.7L	V8	350 / 5.7L	2003 - 2010	18-7824-2	35-866340K01	4.25L / 4.5 Qt.	25W-40 FC-W
5.7LX	V8	350 / 5.7L	1996 - 1997	18-7824-2	35-866340K01	5.2L / 5.5 Qt.	25W-40 FC-W
5.7 EFI	V8	350 / 5.7L	1995 - 2001	18-7824-2	35-866340K01	5.2L / 5.5 Qt.	25W-40 FC-W
500	V8	502 / 8.2L	1994 - 1999	18-7824-2	35-866340K01	7.6L / 8.0 Qt.	25W-40 FC-W
500 EFI	V8	502 / 8.2L	1999 - 2005	18-7824-2	35-866340K01	6.6L / 7.0 Qt.	25W-40 FC-W
502 Mag.	V8	502 / 8.2L	1990 - 1993	18-7824-2	35-866340K01	7.6L / 8.0 Qt.	25W-40 FC-W
502 Mag. EFI	V8	502 / 8.2L	1993 - 1995	18-7824-2	35-866340K01	6.6L / 7.0 Qt.	25W-40 FC-W
502 Mag. MPI	V8	502 / 8.2L	1996 - 2001	18-7824-2	35-866340K01	6.6L / 7.0 Qt.	25W-40 FC-W
6.2 MPI (up to 0M299999)	V8	377 / 6.2L	2000 - 2002	18-7824-2	35-866340K01	5.2L / 5.5 Qt.	25W-40 FC-W
6.2MPI (0M300000 & up)	V8	377 / 6.2L	2002 - 2010	18-7824-2	35-866340K01	4.25L / 4.5 Qt.	25W-40 FC-W
6.2 Black Scorpion (0M391599 & up)	V8	377 / 6.2L	2001 - 2003	18-7824-2	35-866340K01	5.2L / 5.5 Qt.	25W-40 FC-W
6.2 Black Scorpion (0M391599 & up)	V8	377 / 6.2L	2003 - 2010	18-7824-2	35-866340K01	4.25L / 4.5 Qt.	25W-40 FC-W
7.4L	V8	454 / 7.4L	1988 - 1991	18-7824-2	35-866340K01	7.6L / 8.0 Qt.	25W-40 FC-W
7.4L with Borg Warner	V8	454 / 7.4L	1981 - 1992	18-7824-2	35-866340K01	6.6L / 7.0 Qt.	25W-40 FC-W
7.4L with Hurth	V8	454 / 7.4L	1988 - 1992	18-7824-2	35-866340K01	7.6L / 8.0 Qt.	25W-40 FC-W
7.4L	V8	454 / 7.4L	1992 - 1997	18-7824-2	35-866340K01	6.6L / 7.0 Qt.	25W-40 FC-W
7.4LX TBI	V8	454 / 7.4L	1996 - 1997	18-7824-2	35-866340K01	6.6L / 7.0 Qt.	25W-40 FC-W
7.4LX MPI	V8	454 / 7.4L	1996 - 1997	18-7824-2	35-866340K01	6.6L / 7.0 Qt.	25W-40 FC-W
7.4L MPI	V8	454 / 7.4L	1998 - 2001	18-7824-2	35-866340K01	6.6L / 7.0 Qt.	25W-40 FC-W

All listed oil capacities are approximate amounts only and may or may not include the oil filter capacity.
ALWAYS follow proper crankcase drain and fill procedures. Check engine dipstick for proper crankcase oil level.

MERCUISER CONTINUED ON NEXT PAGE

OIL FILTER QUICK-REFERENCE GUIDE

MERCURUISER

Model	Cyl.	CID/Litre	Year	Oil Filter	Replaces	Crankcase Capacity	Recommended Oil
8.1L	V8	496 / 8.1L	2001 - 2010	18-7824-2	35-866340K01	8.5L / 9.0 Qt.	25W-40 FC-W
8.1L (Catalyzed)	V8	496 / 8.1L	2011 - Current	18-7824-2	35-866340K01	8.5L / 9.0 Qt.	20W-40 Synthetic Catalyst (1)
8.1L HO	V8	496 / 8.1L	2001 - 2010	18-7824-2	35-866340K01	8.5L / 9.0 Qt.	25W-40 FC-W
8.1L HO (Catalyzed)	V8	496 / 8.1L	2011 - Current	18-7824-2	35-866340K01	8.5L / 9.0 Qt.	20W-40 Synthetic Catalyst (1)
8.2L	V8	502 / 8.2L	1992 - 1996	18-7824-2	35-866340K01	7.6L / 8.0 Qt.	25W-40 FC-W
8.2L MPI	V8	502 / 8.2L	1996 - 2001	18-7824-2	35-866340K01	6.6L / 7.0 Qt.	25W-40 FC-W
888 (Ford)	V8	302 / 5.0L	1971 - 1977	18-7875	35-802886	5.7L / 6.0 Qt.	25W-40 FC-W
898	V8	305 / 5.0L	1977 - 1984	18-7876	35-99894	4.7L / 5.0 Qt.	25W-40 FC-W

MERCURY OUTBOARD

Model	Year	Oil Filter	Replaces	Crankcase Capacity	Recommended Oil
2.5HP / 3.5HP	2006 - 2011	-----		0.30 L / 0.31 Qt.	10W-30 FC-W
4HP / 5HP / 6 HP	1999 - 2011	-----		0.45L / 0.48 Qt.	10W-30 FC-W
8HP (232cc)	1995-2000	18-7901	825467T1, A1	1.0L / 1.05 Qt.	10W-30 FC-W
8HP (323cc)	2001-2004	18-7913	35-822626Q1, Q3, K03	1.0L / 1.05 Qt.	10W-30 FC-W
8HP (209cc)	2005-2011	-----	35-895152, 35-895152002	0.80L / 0.85 Qt.	10W-30 FC-W
9.9HP (232cc)	1995-1998	18-7901	825467T1, A1	1.0L / 1.05 Qt.	10W-30 FC-W
9.9HP (323cc)	1999-2004	18-7913	35-822626Q1, Q3, K03	1.0L / 1.05 Qt.	10W-30 FC-W
9.9HP (209cc)	2005-2011	-----	35-895152, 35-895152002	0.80L / 0.85 Qt.	10W-30 FC-W
15HP (323cc)	1998-2008	18-7913	35-822626Q1, Q3, K03	1.0L / 1.05 Qt.	10W-30 FC-W
15HP (351cc)	2008-2011	18-7913	35-822626Q1, Q3, K03	1.0L / 1.05 Qt.	10W-30 FC-W
20HP (351cc)	2008-2011	18-7913	35-822626Q1, Q3, K03	1.0L / 1.05 Qt.	10W-30 FC-W
25HP (OT800999 and lower)	1998-2006	18-7914	35-822626Q2, Q04, K04	3.0L / 3.17 Qt.	10W-30 FC-W
25HP (OT801000 and up)	2006-2011	18-7913	35-822626Q1, Q3, K03	1.8L / 1.90 Qt.	10W-30 FC-W
30HP (OT800999 and lower)	1999-2006	18-7914	35-822626Q2, Q04, K04	3.0L / 3.17 Qt.	10W-30 FC-W
30HP (OT801000 and up)	2006-2011	18-7913	35-822626Q1, Q3, K03	1.8L / 1.90 Qt.	10W-30 FC-W
40HP (3 cyl)	1999-2011	18-7914	35-822626Q2, Q04, K04	3.0L / 3.17 Qt.	10W-30 FC-W
40HP (4 cyl)	2001-2011	18-7914	35-822626Q2, Q04, K04	3.0L / 3.17 Qt.	10W-30 FC-W
50HP (996cc)	2001-2011	18-7914	35-822626Q2, Q04, K04	3.0L / 3.17 Qt.	10W-30 FC-W
50HP (935cc)	1995-2000	18-7914	35-822626Q2, Q04, K04	3.0L / 3.17 Qt.	10W-30 FC-W
60HP	2001-2011	18-7914	35-822626Q2, Q04, K04	3.0L / 3.17 Qt.	10W-30 FC-W
75HP Carbureted	2000-2005	18-7914	35-822626Q2, Q04, K04	5.0L / 5.28 Qt.	10W-30 FC-W
75HP EFI (1B366822 & Below)	1999-2006	18-7914	35-822626Q2, Q04, K04	4.5L / 4.80 Qt.	10W-30 FC-W
75HP EFI (1B366822 & Above)	2006-2011	18-7758	35-877761K01	5.0L / 5.28 Qt.	10W-30 FC-W
80HP	2006-UP	18-7914	35-822626Q2, Q04, K04	4.5L / 4.80 Qt.	10W-30 FC-W
90HP Carbureted	2000-2005	18-7914	35-822626Q2, Q04, K04	5.0L / 5.28 Qt.	10W-30 FC-W
90HP EFI (1B366822 & Below)	1999-2006	18-7914	35-822626Q2, Q04, K04	4.5L / 4.80 Qt.	10W-30 FC-W
90HP EFI (1B366822 & Above)	2006-2011	18-7758	35-877761K01	5.0L / 5.28 Qt.	10W-30 FC-W
115HP EFI (1B366822 & Below)	2001-2006	18-7914	35-822626Q2, Q04, K04	5.0L / 5.28 Qt.	10W-30 FC-W
115HP EFI (1B366822 & Above)	2006-2011	18-7758	35-877761K01	5.0L / 5.28 Qt.	10W-30 FC-W
135 Verado L4	2006-2011	18-7921	35-877767K01	6.0L / 6.34 Qt.	25W-40 Synthetic Blend FC-W
150 (4-Stroke)	2011-2015	18-7758	35-877761K01	6.0L/6.34 Qt	10W-30 FC-W
150 Verado L4	2006-2011	18-7921	35-877767K01	6.0L / 6.34 Qt.	25W-40 Synthetic Blend FC-W
175 Verado L4	2006-2011	18-7921	35-877767K01	6.0L / 6.34 Qt.	25W-40 Synthetic Blend FC-W
200 Verado L4	2007-2011	18-7921	35-877767K01	6.0L / 6.34 Qt.	25W-40 Synthetic Blend FC-W
200 Verado L6	2005-2011	18-7918	35-877769K01	7.0L / 7.40 Qt.	25W-50 Synthetic Blend FC-W
225HP EFI	2003-2006	18-7906-1	35-822626T7, Q15	6.0L / 6.34 Qt.	10W-30 FC-W
225 Verado L6	2005-2011	18-7918	35-877769K01	7.0L / 7.40 Qt.	25W-50 Synthetic Blend FC-W
250 Verado L6	2005-2011	18-7918	35-877769K01	7.0L / 7.40 Qt.	25W-50 Synthetic Blend FC-W
275 Verado L6	2005-2011	18-7918	35-877769K01	7.0L / 7.40 Qt.	25W-50 Synthetic Blend FC-W
300 Verado L6	2007-2011	18-7918	35-877769K01	7.0L / 7.40 Qt.	25W-50 Synthetic Blend FC-W

OIL FILTER QUICK-REFERENCE GUIDE

MOHAWK

Model	Year	Oil Filter	Replaces	Crankcase Capacity	Recommended Oil
V8-302, V8-351		18-7875		See Owners Manual	25W-40 FC-W

NISSAN TOHATSU

Model	Year	Oil Filter	Replaces	Crankcase Capacity	Recommended Oil
F2	2006	----	----	300 ml. / 10 oz.	10W-40 FC-W
F2.5	2006 - Current	----	----	300 ml. / 10 oz.	10W-40 FC-W
F3.5	2006 - Current	----	----	300 ml. / 10 oz.	10W-40 FC-W
F4	1999 - Current	----	3H6-07413-0	450 ml. / 16 oz.	10W-40 FC-W
F5	1998 - Current	----	3H6-07413-0	450 ml. / 16 oz.	10W-40 FC-W
F6	2002 - Current	----	3H6-07413-0	450 ml. / 16 oz.	10W-40 FC-W
F8	2003 - Current	----	3V1-07410-1	800 ml. / 27 oz.	10W-40 FC-W
F9.8	2003 - Current	----	3V1-07410-1	800 ml. / 27 oz.	10W-40 FC-W
F9.9	2000 - 2008	18-7911-1	3R007-6150M 3R0-07615-0	1.0L / 1.06 Qt.	10W-40 FC-W
F15	2000 - Current	18-7911-1	3R007-6150M 3R0-07615-0	1.0L / 1.06 Qt.	10W-40 FC-W
F18	2001 - 2006	18-7911-1	3R007-6150M 3R0-07615-0	1.0L / 1.06 Qt.	10W-40 FC-W
F20	2008 - Current	18-7911-1	3R007-6150M 3R0-07615-0	1.0L / 1.06 Qt.	10W-40 FC-W
F25	2002 - Current	18-7911-1	3R007-6150M 3R0-07615-0	1.8L / 1.9 Qt.	10W-40 FC-W
F30	2002 - Current	18-7911-1	3R007-6150M 3R0-07615-0	1.8L / 1.9 Qt.	10W-40 FC-W

NORTHERN LIGHTS

Model	Year	Oil Filter	Replaces	Crankcase Capacity	Recommended Oil
M753		23-7801	140516190	3.5L / 3.7 Qt.	15W-40 API CF or Higher
M753G		23-7801	140516190	3.5L / 3.7 Qt.	15W-40 API CF or Higher
M753K		23-7801	140516190	3.5L / 3.7 Qt.	15W-40 API CF or Higher
M753W		23-7801	140516190	3.5L / 3.7 Qt.	15W-40 API CF or Higher
M753w2		23-7801	140516190	3.5L / 3.7 Qt.	15W-40 API CF or Higher
M773L		23-7801	140516190	4.0L / 4.2 Qt.	15W-40 API CF or Higher
M773LW2		23-7801	140516190	4.9L / 4.75 Qt.	15W-40 API CF or Higher
M773LW3: 9/7Kw		23-7801	140516190	4.9L / 4.75 Qt.	15W-40 API CF or Higher
M843		23-7801	140516190	5.5L / 5.8 Qt.	15W-40 API CF or Higher
M843N		23-7801	140516190	5.5L / 5.8 Qt.	15W-40 API CF or Higher
M843NK		23-7801	140516190	5.5L / 5.8 Qt.	15W-40 API CF or Higher
M843NK2		23-7801	140516190	5.5L / 5.8 Qt.	15W-40 API CF or Higher
M843NW		23-7801	140516190	5.5L / 5.8 Qt.	15W-40 API CF or Higher
M843NW2		23-7801	140516190	5.5L / 5.8 Qt.	15W-40 API CF or Higher
M844		23-7801	140516190	8.2L / 8.66 Qt.	15W-40 API CF or Higher
M844K		23-7801	140516190	8.2L / 8.66 Qt.	15W-40 API CF or Higher
M844L		23-7801	140516190	8.2L / 8.66 Qt.	15W-40 API CF or Higher
M844LK		23-7801	140516190	8.2L / 8.66 Qt.	15W-40 API CF or Higher
M844LW		23-7801	140516190	8.2L / 8.66 Qt.	15W-40 API CF or Higher
M844LW2		23-7801	140516190	8.2L / 8.66 Qt.	15W-40 API CF or Higher
M844W		23-7801	140516190	8.2L / 8.66 Qt.	15W-40 API CF or Higher
M844W2		23-7801	140516190	8.2L / 8.66 Qt.	15W-40 API CF or Higher
M844W3: 16/12KW		23-7801	140516190	8.2L / 8.66 Qt.	15W-40 API CF or Higher

All listed oil capacities are approximate amounts only and may or may not include the oil filter capacity.
ALWAYS follow proper crankcase drain and fill procedures. Check engine dipstick for proper crankcase oil level.

NORTHERN LIGHTS CONTINUED ON NEXT PAGE

OIL FILTER QUICK-REFERENCE GUIDE

NORTHERN LIGHTS

Model	Year	Oil Filter	Replaces	Crankcase Capacity	Recommended Oil
M844LW3: 20/16Kw		23-7801	140516190	8.2L / 8.66 Qt.	15W-40 API CF or Higher
M844NK2		23-7801	140516190	8.2L / 8.66 Qt.	15W-40 API CF or Higher
M844LK2		23-7801	140516190	8.2L / 8.66 Qt.	15W-40 API CF or Higher
M844NW2		23-7801	140516190	8.2L / 8.66 Qt.	15W-40 API CF or Higher
M844NW3		23-7801	140516190	8.2L / 8.66 Qt.	15W-40 API CF or Higher
ML844		23-7801	140516190	8.2L / 8.66 Qt.	15W-40 API CF or Higher
ML844K		23-7801	140516190	8.2L / 8.66 Qt.	15W-40 API CF or Higher
ML844L		23-7801	140516190	8.2L / 8.66 Qt.	15W-40 API CF or Higher
ML844LK		23-7801	140516190	8.2L / 8.66 Qt.	15W-40 API CF or Higher
M864K		23-7801	140516190	7.4L / 7.8 Qt.	15W-40 API CF or Higher
M864W		23-7801	140516190	7.4L / 7.8 Qt.	15W-40 API CF or Higher
M864W3: 25/20Kw		23-7801	140516190	7.4L / 7.8 Qt.	15W-40 API CF or Higher
M16C		23-7801	140516190	Refer to Owner's Manual	15W-40 API CF or Higher
M20CL		23-7801	140516190	8.2L / 8.66 Qt.	15W-40 API CF or Higher
M20CR		23-7801	140516190	8.2L / 8.66 Qt.	15W-40 API CF or Higher

OMC

Model	Cyl.	Year	Oil Filter	Replaces	Crankcase Capacity	Recommended Oil
100	4	1972 - 1973	18-7824	502902	3.3L / 3.5 Qt.	25W-40 FC-W
120	4	1965 - 1981	18-7824	502902	3.3L / 3.5 Qt.	25W-40 FC-W
140	4	1973 - 1981	18-7824	502902	3.3L / 3.5 Qt.	25W-40 FC-W
2.3L (Ford)	4	1987 - 1990	18-7875	502900	3.8L / 4.0 Qt.	25W-40 FC-W
2.5L	4	1982 - 1986	18-7824	502902	3.3L / 3.5 Qt.	25W-40 FC-W
3.0L / GL / GS	4	1982 - 1998	18-7824	502902	3.8L / 4.0 Qt.	25W-40 FC-W
165	6	1972 - 1976	18-7876	502901	3.8L / 4.0 Qt.	25W-40 FC-W
3.8L	6	1981 - 1985	18-7879-1	502903	3.8L / 4.0 Qt.	25W-40 FC-W
4.3L	6	1985 - 1998	18-7879-1	502903	3.8L / 4.0 Qt.	25W-40 FC-W
4.3 HO (Remote Oil Filter)	6	1989 - 1991	18-7876	502901	4.0L / 4.5 Qt.	25W-40 FC-W
175 (Ford)	8	1975 - 1977	18-7875	502900	4.7L / 5.0 Qt.	25W-40 FC-W
185 (Ford)	8	1978 - 1980	18-7875	502900	3.8L / 4.0 Qt.	25W-40 FC-W
190 (Ford)	8	1974 - 1977	18-7875	502900	4.7L / 5.0 Qt.	25W-40 FC-W
200	8	1978 - 1981	18-7876	502901	3.8L / 4.0 Qt.	25W-40 FC-W
225	8	1972 - 1978	18-7876	502901	4.7L / 5.0 Qt.	25W-40 FC-W
230	8	1978 - 1981	18-7876	502901	4.7L / 5.0 Qt.	25W-40 FC-W
235	8	1971 - 1977	18-7876	502901	4.7L / 5.0 Qt.	25W-40 FC-W
245	8	1972 - 1975	18-7876	502901	4.7L / 5.0 Qt.	25W-40 FC-W
250 (Ford)	8	1979	18-7875	502900	4.7L / 5.0 Qt.	25W-40 FC-W
260	8	1978 - 1981	18-7876	502901	4.7L / 5.0 Qt.	25W-40 FC-W
262 King Cobra	8	1989	18-7876	502901	3.8L / 4.0 Qt.	25W-40 FC-W
350 King Cobra	8	1986 - 1989	18-7876	502901	4.7L / 5.0 Qt.	25W-40 FC-W
351 EFI	8	1994 - 1995	18-7875	502900	3.8L / 4.0 Qt.	25W-40 FC-W
351 King	8	1992	18-7875	502900	4.7L / 5.0 Qt.	25W-40 FC-W
351 King	8	1993	18-7875	502900	3.8L / 4.0 Qt.	25W-40 FC-W
454 HO	8	1991 - 1993	18-7876	502901	5.7L / 6.0 Qt.	25W-40 FC-W
454 King Cobra	8	1989 - 1990	18-7876	502901	5.7L / 6.0 Qt.	25W-40 FC-W
460 King Cobra	8	1986 - 1989	18-7878-1	502904	5.7L / 6.0 Qt.	25W-40 FC-W
5.0L	8	1986-1996, 1998	18-7876	502901	4.7L / 5.0 Qt.	25W-40 FC-W
5.0L EFI (Ford)	8	1993 - 1996	18-7875	502900	4.7L / 5.0 Qt.	25W-40 FC-W
502 King Cobra (8.2L)	8	1992 - 1993	18-7876	502901	5.7L / 6.0 Qt.	25W-40 FC-W

OMC CONTINUED ON NEXT PAGE

OIL FILTER QUICK-REFERENCE GUIDE

OMC

Model	Cyl.	Year	Oil Filter	Replaces	Crankcase Capacity	Recommended Oil
5.7L	8	1982 - 1985	18-7876	502901	5.7L / 6.0 Qt.	25W-40 FC-W
5.7L / GL / Gi	8	1986 - 1998	18-7876	502901	4.7L / 5.0 Qt.	25W-40 FC-W
5.8L (Ford)	8	1989 - 1991	18-7875	502900	4.7L / 5.0 Qt.	25W-40 FC-W
5.8L (Ford) / FL / EFI	8	1992 - 1995	18-7875	502900	3.8L / 4.0 Qt.	25W-40 FC-W
5.8L HO EFI	8	1995	18-7875	502900	3.8L / 4.0 Qt.	25W-40 FC-W
7.4L / GL	8	1988, 1991-1998	18-7876	502901	5.7L / 6.0 Qt.	25W-40 FC-W
7.4L Gi	8	1996 - 1998	18-7876	502901	7.6L / 8.0 Qt.	25W-40 FC-W
7.5L (Ford)	8	1987 - 1990	18-7878-1	502904	4.7L / 5.0 Qt.	25W-40 FC-W
8.2L	8	1984 - 1985	18-7876	502901	5.7L / 6.0 Qt.	25W-40 FC-W
8.2L GSi	8	1998	18-7876	502901	7.6L / 8.0 Qt.	25W-40 FC-W

ONAN

Model	Year	Oil Filter	Replaces	Crankcase Capacity	Recommended Oil
MDKAU		23-7804	185-744	2.1L / 2.2 Qt.	15W-40 API CF or Higher
MDKAV		23-7842	185-5835	4.0L / 4.2 Qt.	15W-40 API CF or Higher
MDKBG		23-7842	185-5835	4.0L / 4.2 Qt.	15W-40 API CF or Higher
MDKAW (Spacesaver)		23-7842	185-5835	4.3L / 4.5 Qt.	15W-40 API CF or Higher
MDKAZ		23-7842	185-5835	4.3L / 4.5 Qt.	15W-40 API CF or Higher
MDKBD		23-7840	122-0810	7.6L / 8.0 Qt.	15W-40 API CF or Higher
MDKBE		23-7840	122-0810	7.6L / 8.0 Qt.	15W-40 API CF or Higher
MDKBF		23-7840	122-0810	12L / 12.7 Qt.	15W-40 API CF or Higher
MDKBD (w/ Isolated Ground)		23-7840	122-0810	7.6L / 8.0 Qt.	15W-40 API CF or Higher
MDKBE (w/ Isolated Ground)		23-7840	122-0810	7.6L / 8.0 Qt.	15W-40 API CF or Higher
MDKBF (w/ Isolated Ground)		23-7840	122-0810	12L / 12.7 Qt.	15W-40 API CF or Higher
MDKBH		23-7804	185-744	2.1L / 2.2 Qt.	15W-40 API CF or Higher
MDJB		23-7841	122-0185	3.3L / 3.5 Qt.	15W-40 API CF or Higher
MDJC		23-7841	122-0185	6.2L / 6.5 Qt.	15W-40 API CF or Higher
MDJE		23-7841	122-0185	3.3L / 3.5 Qt.	15W-40 API CF or Higher
MDJF		23-7841	122-0185	6.2L / 6.5 Qt.	15W-40 API CF or Higher
MJA		23-7841	122-0185	Refer to Owners Manual	15W-40 API CF or Higher
MJB		23-7841	122-0185	Refer to Owners Manual	15W-40 API CF or Higher
MJC		23-7841	122-0185	Refer to Owners Manual	15W-40 API CF or Higher
MDKAD/E/F		23-7840	122-0810	7.6L / 8.0 Qt.	15W-40 API CF or Higher
MDKAL/A/B		23-7842	185-5835	4.0L / 4.2 Qt.	15W-40 API CF or Higher

PCM PLEASURECRAFT

Model	Year	Oil Filter	Replaces	Crankcase Capacity	Recommended Oil
200		18-7875	R077001	Refer to Owners Manual	Refer to Owners Manual
220		18-7875	R077001	Refer to Owners Manual	Refer to Owners Manual
8200		18-7875	R077001	Refer to Owners Manual	Refer to Owners Manual
8240		18-7875	R077001	Refer to Owners Manual	Refer to Owners Manual
230		18-7824	R077002	Refer to Owners Manual	Refer to Owners Manual
280		18-7824	R077002	Refer to Owners Manual	Refer to Owners Manual
300		18-7824	R077002	Refer to Owners Manual	Refer to Owners Manual
350		18-7824	R077002	Refer to Owners Manual	Refer to Owners Manual
5.0L MPI (Remote Oil Filter)	2007 & Older	18-7875	R077001	3.8L / 4.0 Qt.	15W-40 API SL or Higher
5.7L MPI (Remote Oil Filter)	2007 & Older	18-7875	R077001	3.8L / 4.0 Qt.	15W-40 API SL or Higher
6.0L MPI (Remote Oil Filter)	2007 & Older	18-7875	R077001	4.75L / 5.0 Qt.	15W-40 API SL or Higher

All listed oil capacities are approximate amounts only and may or may not include the oil filter capacity.
 ALWAYS follow proper crankcase drain and fill procedures. Check engine dipstick for proper crankcase oil level.

PCM / PLEASURECRAFT CONTINUED ON NEXT PAGE

OIL FILTER QUICK-REFERENCE GUIDE

PCM PLEASURECRAFT

Model	Year	Oil Filter	Replaces	Crankcase Capacity	Recommended Oil
5.0L MPI (Serial 473065 & UP) (Remote Oil Filter)	2007 - 2009	18-7875	R077001	3.8L / 4.0 Qt.	15W-40 API SL or Higher
EX 343 (Serial 473065 & UP) (Remote Oil Filter)	2007 - 2012	18-7875	R077001	3.8L / 4.0 Qt.	15W-40 API SL or Higher
ZR6 390 (Serial 470365 & UP) (Remote Oil Filter)	2007	18-7875	R077001	4.75L / 5.0 Qt.	15W-40 API SL or Higher
5.0L Pro Sport Catanium™ CES (Remote Oil Filter)	2008 - 2010	18-7875	R077001	4.5L / 4.75 Qt.	15W-40 API SM or Higher
5.7L EX343 Catanium™ CES (Remote Oil Filter)	2008 - 2012	18-7875	R077001	4.5L / 4.75 Qt.	15W-40 API SM or Higher
6.0L ZR-409 Catanium™ CES (Remote Oil Filter)	2009 - 2012	18-7875	R077001	4.75L / 5.0 Qt.	15W-40 API SM or Higher
6.0L MPI - ZR409 (Remote Oil Filter)	2009 - 2012	18-7875	R077001	4.75L / 5.0 Qt.	15W-40 API SM or Higher
HO303 MPI	2011 - 2012	18-7875	R077001	3.8L / 4.0 Qt. (Starting Amount)	15W-40 API SM or Higher
HO303 Catanium™ CES	2011 - 2012	18-7875	R077001	3.8L / 4.0 Qt. (Starting Amount)	15W-40 API SM or Higher
ZR450 Catanium™ CES	2011 - 2012	18-7875	R077001	3.8L / 4.0 Qt. (Starting Amount)	15W-40 API SM or Higher
ZR550 6.2L MPI	2011 - 2012	18-7875	R077001	3.8L / 4.0 Qt. (Starting Amount)	5W-30 Full Synthetic

SUZUKI

Model	Year	Oil Filter	Replaces	Crankcase Capacity	Recommended Oil
DF9.9-DF15 (9.9 hp. serial 110001 and below)	1996 - 2010	18-7903	16510-05240 16510-45H10	1.0 L / 1.1 Qt.	10W-40 Synthetic Blend FC-W
DF25	2000 - 2006	18-7915-1	16510-87J00	3.0 L / 3.2 Qt.	10W-40 Synthetic Blend FC-W
DF25 V-Twin	2006 - 2010	18-7915-1	16510-87J00	1.5L / 1.6 Qt.	10W-40 Synthetic Blend FC-W
DF30	2000 - 2007	18-7915-1	16510-87J00	3.0 L / 3.2 Qt.	10W-40 Synthetic Blend FC-W
DF40-DF50	1999 - 2010	18-7915-1	16510-87J00	2.2 L / 2.3 Qt.	10W-40 Synthetic Blend FC-W
DF60-DF70	1998 - 2009	18-7915-1	16510-87J00	4.5 L / 4.8 Qt.	10W-40 Synthetic Blend FC-W
DF60A	2010	18-7915-1	16510-87J00	2.7 L / 3.0 Qt.	10W-40 Synthetic Blend FC-W
DF70A	2009 - 2010	18-7896	16510-61A20-MHL	4.2 L / 4.0 Qt.	10W-40 Synthetic Blend FC-W
DF80A	2009 - 2010	18-7896	16510-61A20-MHL	4.2 L / 4.0 Qt.	10W-40 Synthetic Blend FC-W
DF90A	2009 - 2010	18-7896	16510-61A20-MHL	4.2 L / 4.0 Qt.	10W-40 Synthetic Blend FC-W
DF90	2001 - 2008	18-7896	16510-61A20-MHL	5.5 L / 5.8 Qt.	10W-40 Synthetic Blend FC-W
DF115	2001 - 2010	18-7896	16510-61A20-MHL	5.5 L / 5.8 Qt.	10W-40 Synthetic Blend FC-W
DF140	2002 - 2010	18-7897	16510-82703	5.5 L / 5.8 Qt.	10W-40 Synthetic Blend FC-W
DF150-DF175	2006 - 2010	18-7905	16510-96J00	8.0 L / 8.5 Qt.	10W-40 Synthetic Blend FC-W
DF200 / DF225 / DF250	2004 - 2010	18-7905	16510-96J00	8.0 L / 8.5 Qt.	10W-40 Synthetic Blend FC-W
DF300	2007 - 2010	18-7905	16510-96J00	8.0 L / 8.5 Qt.	10W-40 Synthetic Blend FC-W

VOLVO GASOLINE

Model	Cyl.	Year	Oil Filter	Replaces	Crankcase Capacity	Recommended Oil
230 A/B	4	1989 - 1993	18-7878-1	3517857	4.5L / 4.75 Qt.	10W-40 FC-W
250 A/B	4	1989 - 1993	18-7878-1	3517857	4.5L / 4.75 Qt.	10W-40 FC-W
251A	4	1989 - 1992	18-7878-1	3517857	4.5L / 4.75 Qt.	10W-40 FC-W
3.0L	4	1993 - Current	18-7824	835440	3.8L / 4.0 Qt.	Synthetic SAE 30 (1)
AQ100	4	1961 - 1963	18-7878-1	3517857	3.8L / 4.0 Qt.	10W-40 FC-W
AQ110	4	1963 - 1966	18-7878-1	3517857	3.8L / 4.0 Qt.	10W-40 FC-W
AQ115 A/B	4	1969 - 1975	18-7878-1	3517857	3.8L / 4.0 Qt.	10W-40 FC-W
AQ120 A/B	4	1966 - 1980	18-7878-1	3517857	3.8L / 4.0 Qt.	10W-40 FC-W
AQ125 A/B	4	1981 - 1985	18-7878-1	3517857	4.2L / 4.5 Qt.	10W-40 FC-W
AQ130 A/B/C/D	4	1968 - 1977	18-7878-1	3517857	3.8L / 4.0 Qt.	10W-40 FC-W
AQ131 A/B/C/D	4	1985 - 1989	18-7878-1	3517857	3.8L / 4.0 Qt.	10W-40 FC-W
AQ140A	4	1975 - 1979	18-7878-1	3517857	3.8L / 4.0 Qt.	10W-40 FC-W
AQ145 A/B	4	1979 - 1985	18-7878-1	3517857	4.2L / 4.5 Qt.	10W-40 FC-W
AQ151 A/B/C	4	1985 - 1989	18-7878-1	3517857	3.8L / 4.0 Qt.	10W-40 FC-W
AQ170 A/B/C	4	1969 - 1980	18-7878-1	3517857	3.8L / 4.0 Qt.	10W-40 FC-W
AQ171 A/C	4	1986 - 1989	18-7878-1	3517857	3.8L / 4.0 Qt.	10W-40 FC-W

VOLVO GASOLINE CONTINUED ON NEXT PAGE

OIL FILTER QUICK-REFERENCE GUIDE

VOLVO GASOLINE

Model	Cyl.	Year	Oil Filter	Replaces	Crankcase Capacity	Recommended Oil
AQ60F	4	1962 - 1968	18-7878-1	3517857	Check Owners Manual	10W-40 FC-W
AQ90	4	1962 - 1964	18-7878-1	3517857	3.8L / 4.0 Qt.	10W-40 FC-W
AQ95 /A	4	1964 - 1966	18-7878-1	3517857	3.8L / 4.0 Qt.	10W-40 FC-W
BB100	4	1963 - 1969	18-7878-1	3517857	Check Owners Manual	10W-40 FC-W
BB115 A/B/C	4	1969 - 1977	18-7878-1	3517857	Check Owners Manual	10W-40 FC-W
BB140A	4	1975 - 1979	18-7878-1	3517857	Check Owners Manual	10W-40 FC-W
BB145A	4	1979 - 1985	18-7878-1	3517857	Check Owners Manual	10W-40 FC-W
BB165A	4	1965 - 1969	18-7878-1	3517857	Check Owners Manual	10W-40 FC-W
BB170 A/B/C	4	1969 - 1978	18-7878-1	3517857	Check Owners Manual	10W-40 FC-W
BB30	4	1963 - 1969	18-7878-1	3517857	Check Owners Manual	10W-40 FC-W
MB10A	4	1971 - 1977	18-7878-1	3517857	Check Owners Manual	10W-40 FC-W
MB20 A/B/C	4	1969 - 1980	18-7878-1	3517857	Check Owners Manual	10W-40 FC-W
4.3L	V6	1993 - 2006	18-7879-1	841750	4.2L / 4.5 Qt.	Synthetic SAE 30 (1)
4.3L	V6	2007 - Current	18-8003	8692305	4.7L / 5.0 Qt.	Synthetic SAE 30 (1)
430 A/B	V6	1990 - 1992	18-7879-1	841750	4.2L / 4.5 Qt.	10W-40 FC-W
431 A/B	V6	1989 - 1992	18-7879-1	841750	4.2L / 4.5 Qt.	10W-40 FC-W
432A/B	V6	1992 - 1998	18-7879-1	841750	4.2L / 4.5 Qt.	10W-40 FC-W
434A/B	V6	1992 - 1997	18-7879-1	841750	4.2L / 4.5 Qt.	10W-40 FC-W
AQ175A	V6	1981 - 1985	18-7879-1	841750	6.0L / 6.5 Qt.	10W-40 FC-W
AQ205A	V6	1988 - 1989	18-7879-1	841750	6.0L / 6.5 Qt.	10W-40 FC-W
5.0L (Ford)	V8	1993 - 1999	18-7875	835779	5.7L / 6.0 Qt.	Synthetic SAE 30 (1)
5.0L (GM)	V8	1997 - 2006	18-7824	835440	5.7L / 6.0 Qt.	Synthetic SAE 30 (1)
5.0L (GM)	V8	2007 - Current	18-8003	8692305	5.2L / 5.5 Qt.	Synthetic SAE 30 (1)
5.7L	V8	1993 - 2006	18-7824	835440	5.7L / 6.0 Qt.	Synthetic SAE 30 (1)
5.7L	V8	2007 - Current	18-8003	8692305	5.2L / 5.5 Qt.	Synthetic SAE 30 (1)
5.8L	V8	1993 - 1996	18-7875	835779	5.7L / 6.0 Qt.	Synthetic SAE 30 (1)
500 A/B	V8	1989 - 1993	18-7824	835440	5.7L / 6.0 Qt.	10W-40 FC-W
501 A/B	V8	1989 - 1993	18-7824	835440	5.7L / 6.0 Qt.	10W-40 FC-W
570 A/MS4A	V8	1989 - 1993	18-7824	835440	5.7L / 6.0 Qt.	10W-40 FC-W
571A	V8	1989 - 1992	18-7824	835440	5.7L / 6.0 Qt.	10W-40 FC-W
572A	V8	1991 - 1993	18-7824	835440	5.7L / 6.0 Qt.	10W-40 FC-W
7.4L	V8	1993 - 2000	18-7876	3850559	6.6L / 7.0 Qt.	Synthetic SAE 30 (1)
740 A/B	V8	1992 - 1993	18-7876	3850559	6.6L / 7.0 Qt.	10W-40 FC-W
8.1L	V8	1999 - 2006	18-7824	835440	8.0L / 8.5 Qt.	Synthetic SAE 30 (1)
8.1L	V8	2007 - Current	18-8003	8692305	8.0L / 8.5 Qt.	Synthetic SAE 30 (1)
8.2L	V8	1993 - 2000	18-7876	3850559	6.6L / 7.0 Qt.	Synthetic SAE 30 (1)
AQ190A	V8	1976 - 1977	18-7875	835779	4.0L / 4.2 Qt.	10W-40 FC-W
AQ211A	V8	1986 - 1989	18-7824	835440	4.0L / 4.2 Qt.	10W-40 FC-W
AQ225 B/C/D/E/F	V8	1973 - 1976	18-7824	835440	4.4L / 4.7 Qt.	10W-40 FC-W
AQ231A	V8	1986 - 1989	18-7824	835440	4.4L / 4.7 Qt.	10W-40 FC-W
AQ231B	V8	1987 - 1989	18-7824	835440	4.4L / 4.7 Qt.	10W-40 FC-W
AQ240A	V8	1976 - 1977	18-7875	835779	4.4L / 4.7 Qt.	10W-40 FC-W
AQ255 A/B	V8	1977 - 1978	18-7824	835440	5.7L / 6.0 Qt.	10W-40 FC-W
AQ260 A/B	V8	1979 - 1986	18-7824	835440	5.7L / 6.0 Qt.	10W-40 FC-W
AQ271 A/B/C/D	V8	1986 - 1989	18-7824	835440	5.4L / 5.7 Qt.	10W-40 FC-W
AQ280A	V8	1978 - 1979	18-7824	835440	5.4L / 5.7 Qt.	10W-40 FC-W
AQ290A	V8	1979 - 1985	18-7824	835440	5.4L / 5.7 Qt.	10W-40 FC-W

All listed oil capacities are approximate amounts only and may or may not include the oil filter capacity.
 ALWAYS follow proper crankcase drain and fill procedures. Check engine dipstick for proper crankcase oil level.

VOLVO GASOLINE CONTINUED ON NEXT PAGE

OIL FILTER QUICK-REFERENCE GUIDE

VOLVO GASOLINE

Model	Cyl.	Year	Oil Filter	Replaces	Crankcase Capacity	Recommended Oil
AQ311 A/B	V8	1986 - 1987	18-7824	835440	5.4L / 5.7 Qt.	10W-40 FC-W
BB225 A/B/C	V8	1973 - 1977	18-7824	835440	4.4L / 4.7 Qt.	10W-40 FC-W
BB231A	V8	1987	18-7824	835440	4.4L / 4.7 Qt.	10W-40 FC-W
BB260 A/B/C	V8	1978 - 1987	18-7824	835440	5.7L / 6.0 Qt.	10W-40 FC-W
BB261A	V8	1988 - 1989	18-7824	835440	5.7L / 6.0 Qt.	10W-40 FC-W

VOLVO DIESEL

Model	Cyl.	Year	Oil Filter	Replaces	Crankcase Capacity	Recommended Oil
2001 / B	1	1984 - 1993	18-7884	834337	1.4L / 1.5 Qt.	15W-40 VDS-2 or VDS-3 / API CI-4 or higher
MD1B	1	1970 - 1973	18-7884	834337	1.5L / 1.8 Qt.	15W-40 VDS-2 or VDS-3 / API CI-4 or higher
MD5A / B / C	1	1975 - 1982	18-7884	834337	2.0L / 2.10 Qt.	15W-40 VDS-2 or VDS-3 / API CI-4 or higher
2002 / B	2	1983 - 1993	18-7884	834337	2.75L / 2.9 Qt.	15W-40 VDS-2 or VDS-3 / API CI-4 or higher
AQD2B	2	1972 - 1975	18-7884	834337	See Owners Manual	15W-40 VDS-2 or VDS-3 / API CI-4 or higher
MD11C / D	2	1975 - 1983	18-7884	834337	2.6L / 2.7 Qt.	15W-40 VDS-2 or VDS-3 / API CI-4 or higher
MD2	2	1964 - 1967	18-7884	834337	See Owners Manual	15W-40 VDS-2 or VDS-3 / API CI-4 or higher
MD2B	2	1970 - 1975	18-7884	834337	2.6L / 2.7 Qt.	15W-40 VDS-2 or VDS-3 / API CI-4 or higher
MD6A / B	2	1971 - 1976	18-7884	834337	2.8L / 2.9 Qt.	15W-40 VDS-2 or VDS-3 / API CI-4 or higher
MD7A / B	2	1976 - 1983	18-7884	834337	2.8L / 2.9 Qt.	15W-40 VDS-2 or VDS-3 / API CI-4 or higher
2003 / B / TB	3	1983 - 1993	18-7884	834337	4.1L / 4.3 Qt.	15W-40 VDS-2 or VDS-3 / API CI-4 or higher
MD17C / D	3	1975 - 1984	18-7884	834337	4.2L / 4.4 Qt.	15W-40 VDS-2 or VDS-3 / API CI-4 or higher
MD3B	3	1971 - 1975	18-7884	834337	4.8L / 5.8 Qt.	15W-40 VDS-2 or VDS-3 / API CI-4 or higher
AD31A / L-A / P-A / D / X	4	1986 - 2004	18-7878-1	3517857	8.5L / 9.0 Qt.	15W-40 VDS-2 or VDS-3 / API CI-4 or higher
AQAD30A	4	1983 - 1986	18-7878-1	3517857	8.5L / 9.0 Qt.	15W-40 VDS-2 or VDS-3 / API CI-4 or higher
AQAD31A	4	1986 - 1989	18-7878-1	3517857	8.5L / 9.0 Qt.	15W-40 VDS-2 or VDS-3 / API CI-4 or higher
AQD21A / B	4	1969 - 1981	18-7974	3827069	5.5L / 5.8 Qt.	15W-40 VDS-2 or VDS-3 / API CI-4 or higher
D4-180iB / C / D / E	4	2005 - Current	18-0035	3582732 Full Flow	12.5L / 13.2 Qt.	15W-40 VDS-2 or VDS-3 / API CI-4 or higher
D4-180iB / C / D / E	4	2005 - Current	18-0036	3582733 Bypass	12.5L / 13.2 Qt.	15W-40 VDS-2 or VDS-3 / API CI-4 or higher
D4-210A-A / A-B	4	2003 - 2006	18-0035	3582732 Full Flow	12.5L / 13.2 Qt.	15W-40 VDS-2 or VDS-3 / API CI-4 or higher
D4-210A-A / B	4	2003 - 2006	18-0036	3582733 Bypass	12.5L / 13.2 Qt.	15W-40 VDS-2 or VDS-3 / API CI-4 or higher
D4-210i-A / B	4	2003 - 2006	18-0035	3582732 Full Flow	12.5L / 13.2 Qt.	15W-40 VDS-2 or VDS-3 / API CI-4 or higher
D4-210i-A / B	4	2003 - 2006	18-0036	3582733 Bypass	12.5L / 13.2 Qt.	15W-40 VDS-2 or VDS-3 / API CI-4 or higher
D4-225A-B	4	2005 - 2008	18-0035	3582732 Full Flow	12.5L / 13.2 Qt.	15W-40 VDS-2 or VDS-3 / API CI-4 or higher
D4-225A-B	4	2005 - 2008	18-0036	3582733 Bypass	12.5L / 13.2 Qt.	15W-40 VDS-2 or VDS-3 / API CI-4 or higher
D4-225i-B	4	2005 - 2008	18-0035	3582732 Full Flow	12.5L / 13.2 Qt.	15W-40 VDS-2 or VDS-3 / API CI-4 or higher
D4-225i-B	4	2005 - 2008	18-0036	3582733 Bypass	12.5L / 13.2 Qt.	15W-40 VDS-2 or VDS-3 / API CI-4 or higher
D4-260A-A / A-B / D-B	4	2004 - 2008	18-0036	3582733 Bypass	12.5L / 13.2 Qt.	15W-40 VDS-2 or VDS-3 / API CI-4 or higher
D4-260A-A / A-B / D-B(IPS)	4	2004 - 2008	18-0035	3582732 Full Flow	12.5L / 13.2 Qt.	15W-40 VDS-2 or VDS-3 / API CI-4 or higher
D4-260i-A / B	4	2004 - 2008	18-0035	3582732 Full Flow	12.5L / 13.2 Qt.	15W-40 VDS-2 or VDS-3 / API CI-4 or higher
D4-260i-A / B	4	2004 - 2008	18-0036	3582733 Bypass	12.5L / 13.2 Qt.	15W-40 VDS-2 or VDS-3 / API CI-4 or higher
D4-300A-A / A-E / D-A	4	2007 - Current	18-0035	3582732 Full Flow	12.5L / 13.2 Qt.	15W-40 VDS-2 or VDS-3 / API CI-4 or higher
D4-300A-A / A-E / D-A	4	2007 - Current	18-0036	3582733 Bypass	12.5L / 13.2 Qt.	15W-40 VDS-2 or VDS-3 / API CI-4 or higher
D4-300i-A / C / D	4	2007 - 2010	18-0035	3582732 Full Flow	12.5L / 13.2 Qt.	15W-40 VDS-2 or VDS-3 / API CI-4 or higher
D4-300i-A / C / D	4	2007 - 2010	18-0036	3582733 Bypass	12.5L / 13.2 Qt.	15W-40 VDS-2 or VDS-3 / API CI-4 or higher
KAD32P	4	1997 - 2005	18-7926		8.5L / 9.0 Qt.	15W-40 VDS-2 or VDS-3 / API CI-4 or higher
MD21A / B	4	1969 - 1981	18-7974	3827069	5.5L / 5.8 Qt.	15W-40 VDS-2 or VDS-3 / API CI-4 or higher
MD30A	4	1983 - 1986	18-7878-1	3517857	8.5L / 9.0 Qt.	15W-40 VDS-2 or VDS-3 / API CI-4 or higher
MD31A	4	1986 - 1994	18-7878-1	3517857	8.5L / 9.0 Qt.	15W-40 VDS-2 or VDS-3 / API CI-4 or higher
TAMD30A	4	1983 - 1986	18-7878-1	3517857	8.5L / 9.0 Qt.	15W-40 VDS-2 or VDS-3 / API CI-4 or higher
TAMD31B / D / PL	4	1989 - 2003	18-7878-1	3517857	8.5L / 9.0 Qt.	15W-40 VDS-2 or VDS-3 / API CI-4 or higher

VOLVO DIESEL CONTINUED ON NEXT PAGE

OIL FILTER QUICK-REFERENCE GUIDE

VOLVO DIESEL						
Model	Cyl.	Year	Oil Filter	Replaces	Crankcase Capacity	Recommended Oil
TMD30A	4	1983 - 1986	18-7878-1	3517857	8.5L / 9.0 Qt.	15W-40 VDS-2 or VDS-3 / API CI-4 or higher
TMD31A / B / D	4	1986 - 1994	18-7878-1	3517857	8.5L / 9.0 Qt.	15W-40 VDS-2 or VDS-3 / API CI-4 or higher
TMD31L-A	4	1994 - 1997	18-7878-1	3517857	8.5L / 9.0 Qt.	15W-40 VDS-2 or VDS-3 / API CI-4 or higher
D3-110i-A / B / C	5	2004 - 2006	18-8003	8692305	5.65L / 6.0 Qt.	15W-40 VDS-2 or VDS-3 / API CI-4 or higher
D3-130A-A / A-B	5	2005 - 2006	18-8003	8692305	5.65L / 6.0 Qt.	15W-40 VDS-2 or VDS-3 / API CI-4 or higher
D3-130i-A / B / C	5	2004 - 2006	18-8003	8692305	5.65L / 6.0 Qt.	15W-40 VDS-2 or VDS-3 / API CI-4 or higher
D3-160A-A / A-B / A-C	5	2004 - 2006	18-8003	8692305	5.65L / 6.0 Qt.	15W-40 VDS-2 or VDS-3 / API CI-4 or higher
D3-160i-A / B / C	5	2004 - 2006	18-8003	8692305	5.65L / 6.0 Qt.	15W-40 VDS-2 or VDS-3 / API CI-4 or higher
D3-190A-B	5	2005 - 2007	18-8003	8692305	5.65L / 6.0 Qt.	15W-40 VDS-2 or VDS-3 / API CI-4 or higher
D3-190i-B / C	5	2005 - Current	18-8003	8692305	5.65L / 6.0 Qt.	15W-40 VDS-2 or VDS-3 / API CI-4 or higher
AQD70B / C	6	1972 - 1978	18-7926	423135	20L / 5.28 Gal.	15W-40 VDS-2 or VDS-3 / API CI-4 or higher
D11A-A / B / C / D	6	2007 - Current	18-0033	478736	38L / 10 Gal.	15W-40 VDS-2 or VDS-3 / API CI-4 or higher
D11A-A / B / C / D	6	2007 - Current	18-0034	477556	38L / 10 Gal.	15W-40 VDS-2 or VDS-3 / API CI-4 or higher
D11A-C (IPS) / D11A-D (IPS)	6	2009 - Current	18-0033	478736	38L / 10 Gal.	15W-40 VDS-2 or VDS-3 / API CI-4 or higher
D11A-C (IPS) / D11A-D (IPS)	6	2009 - Current	18-0034	477556	38L / 10 Gal.	15W-40 VDS-2 or VDS-3 / API CI-4 or higher
D12D-AMP / B / C / E / F / G / H	6	1999 - 2009	18-0033	478736	44L / 11.62 Gal.	15W-40 VDS-2 or VDS-3 / API CI-4 or higher
D12D-AMG / EMG (Gen Set)	6	2002 - 2008	18-0034	477556	44L / 11.62 Gal.	15W-40 VDS-2 or VDS-3 / API CI-4 or higher
D12D-AMH / B / C / E / G	6	2002 - 2008	18-0033	478736	44L / 11.62 Gal.	15W-40 VDS-2 or VDS-3 / API CI-4 or higher
D13AMP / B / C / G / H	6	2009 - Current	18-0033	478736	45L / 11.89 Gal.	15W-40 VDS-2 or VDS-3 / API CI-4 or higher
D13AMP / B / C / G / H	6	2009 - Current	18-0034	477556	45L / 11.89 Gal.	15W-40 VDS-2 or VDS-3 / API CI-4 or higher
D16C-AMG / B / C (Gen Set)	6	2006 - 2009	18-0034	477556	49L / 13 Gal.	15W-40 VDS-2 or VDS-3 / API CI-4 or higher
D16C-AMH / B / C	6	2006 - 2009	18-0033	478736	49L / 13 Gal.	15W-40 VDS-2 or VDS-3 / API CI-4 or higher
D6-280A-A / A-B / A-C / A-D	6	2004 - 2010	18-0035	3582732 Full Flow	20L / 5.28 Gal.	15W-40 VDS-2 or VDS-3 / API CI-4 or higher
D6-280i-A / B	6	2004 - 2008	18-0035	3582732 Full Flow	20L / 5.28 Gal.	15W-40 VDS-2 or VDS-3 / API CI-4 or higher
D6-280i-A / B	6	2004 - 2008	18-0036	3582733 Bypass	20L / 5.28 Gal.	15W-40 VDS-2 or VDS-3 / API CI-4 or higher
D6-310i-A / B / C / D	6	2003 - 2010	18-0035	3582732 Full Flow	20L / 5.28 Gal.	15W-40 VDS-2 or VDS-3 / API CI-4 or higher
D6-310i-A / B / C / D	6	2003 - 2010	18-0036	3582733 Bypass	20L / 5.28 Gal.	15W-40 VDS-2 or VDS-3 / API CI-4 or higher
D6-330A-B / D-B	6	2004 - 2008	18-0035	3582732 Full Flow	20L / 5.28 Gal.	15W-40 VDS-2 or VDS-3 / API CI-4 or higher
D6-330A-B / D-B	6	2004 - 2008	18-0036	3582733 Bypass	20L / 5.28 Gal.	15W-40 VDS-2 or VDS-3 / API CI-4 or higher
D6--330i-B / C / D	6	2007 - 2010	18-0035	3582732 Full Flow	20L / 5.28 Gal.	15W-40 VDS-2 or VDS-3 / API CI-4 or higher
D6--330i-B / C / D	6	2007 - 2010	18-0036	3582733 Bypass	20L / 5.28 Gal.	15W-40 VDS-2 or VDS-3 / API CI-4 or higher
D6-370A-B / A-C / A-D / D-B / D-C / D-D	6	2007 - 2010	18-0035	3582732 Full Flow	20L / 5.28 Gal.	15W-40 VDS-2 or VDS-3 / API CI-4 or higher
D6-370A-B / A-C / A-D / D-B / D-C / D-D	6	2007 - 2010	18-0036	3582733 Bypass	20L / 5.28 Gal.	15W-40 VDS-2 or VDS-3 / API CI-4 or higher
D6-400A-E	6	2011 - Current	18-0035	3582732 Full Flow	20L / 5.28 Gal.	15W-40 VDS-2 or VDS-3 / API CI-4 or higher
D6-400A-E	6	2011 - Current	18-0036	3582733 Bypass	20L / 5.28 Gal.	15W-40 VDS-2 or VDS-3 / API CI-4 or higher
D6-435D-C / D-D / D-E	6	2006 - Current	18-0035	3582732 Full Flow	20L / 5.28 Gal.	15W-40 VDS-2 or VDS-3 / API CI-4 or higher
D6-435D-C / D-D / D-E	6	2006 - Current	18-0036	3582733 Bypass	20L / 5.28 Gal.	15W-40 VDS-2 or VDS-3 / API CI-4 or higher
D6-435i-A / C / D / E	6	2006 - Current	18-0035	3582732 Full Flow	20L / 5.28 Gal.	15W-40 VDS-2 or VDS-3 / API CI-4 or higher
D6-435i-A / C / D / E	6	2006 - Current	18-0036	3582733 Bypass	20L / 5.28 Gal.	15W-40 VDS-2 or VDS-3 / API CI-4 or higher
D9A2A	6	2004 - 2006	18-0033	478736	31L / 32.75 Qt.	15W-40 VDS-2 or VDS-3 / API CI-4 or higher
D9A2A MG (Gen Set)	6	2004 - Current	18-0033	478736	31L / 32.75 Qt.	15W-40 VDS-2 or VDS-3 / API CI-4 or higher
KAD300-A	6	2001 - 2005	18-7926		11L / 11.6 Qt.	15W-40 VDS-2 or VDS-3 / API CI-4 or higher
KAD42B/P/PA	6	1993 - 1997	18-7926		10.5L / 11.0 Qt.	15W-40 VDS-2 or VDS-3 / API CI-4 or higher
KAD43P-A	6	1997 - 2005	18-7926		10.5L / 11.0 Qt.	15W-40 VDS-2 or VDS-3 / API CI-4 or higher
KAD44P-A/B/C	6	1997 - 2004	18-7926		11L / 11.6 Qt.	15W-40 VDS-2 or VDS-3 / API CI-4 or higher

All listed oil capacities are approximate amounts only and may or may not include the oil filter capacity.
ALWAYS follow proper crankcase drain and fill procedures. Check engine dipstick for proper crankcase oil level.

VOLVO DIESEL CONTINUED ON NEXT PAGE

OIL FILTER QUICK-REFERENCE GUIDE

VOLVO DIESEL

Model	Cyl.	Year	Oil Filter	Replaces	Crankcase Capacity	Recommended Oil
KAMD300-A	6	2001 - 2004	18-7926		11L / 11.6 Qt.	15W-40 VDS-2 or VDS-3 / API CI-4 or higher
KAMD42A/B/P/PA	6	1991 - 1997	18-7926		10.5L / 11.0 Qt.	15W-40 VDS-2 or VDS-3 / API CI-4 or higher
KAMD43P-A	6	1997 - 2005	18-7926		10.5L / 11.0 Qt.	15W-40 VDS-2 or VDS-3 / API CI-4 or higher
KAMD44P-B/C	6	1999 - 2004	18-7926		11L / 11.6 Qt.	15W-40 VDS-2 or VDS-3 / API CI-4 or higher
MD100A/B	6	1965 - 1984	18-7926		50L / 13.21 Gal.	15W-40 VDS-2 or VDS-3 / API CI-4 or higher
MD120A/B	6	1970 - 1980	18-7926		50L / 13.21 Gal.	15W-40 VDS-2 or VDS-3 / API CI-4 or higher
MD32A	6	1970 - 1977	18-7974	3827069	8L / 8.4 Qt.	15W-40 VDS-2 or VDS-3 / API CI-4 or higher
MD70B	6	1970 - 1978	18-7926		15L / 16 Qt.	15W-40 VDS-2 or VDS-3 / API CI-4 or higher
TAMD102A (Long Filter)	6	1991 - 2000	18-0033	478736	50L / 13.21 Gal.	15W-40 VDS-2 or VDS-3 / API CI-4 or higher
TAMD102A / D (Short Filter)	6	1991 - 2000	18-0032	847741	50L / 13.21 Gal.	15W-40 VDS-2 or VDS-3 / API CI-4 or higher
TAMD103A-A (Long Filter)	6	2000 - 2004	18-0033	478736	50L / 13.2 Gal.	15W-40 VDS-2 or VDS-3 / API CI-4 or higher
TAMD103A-A, AUX (Short Filter)	6	2000 - 2004	18-0032	847741	50L / 13.2 Gal.	15W-40 VDS-2 or VDS-3 / API CI-4 or higher
TAMD120A / B	6	1972 - 1983	18-7926		50L / 13.2 Gal.	15W-40 VDS-2 or VDS-3 / API CI-4 or higher
TAMD122D	6	1989 - 1996	18-0032	847741	50L / 13.2 Gal.	15W-40 VDS-2 or VDS-3 / API CI-4 or higher
TAMD122P-A, B, C	6	1995 - 2002	18-0033	478736	50L / 13.2 Gal.	15W-40 VDS-2 or VDS-3 / API CI-4 or higher
TAMD162A / B / C	6	1988 - 1996	18-0033	478736	73L / 19.3 Gal.	15W-40 VDS-2 or VDS-3 / API CI-4 or higher
TAMD162C-C	6	1999 - 2001	18-0033	478736	Refer to Owners Manual	15W-40 VDS-2 or VDS-3 / API CI-4 or higher
TAMD163A-A / PA	6	1994 - 2001	18-0033	478736	73L / 19.3 Gal.	15W-40 VDS-2 or VDS-3 / API CI-4 or higher
TAMD165A-A / C-A / P-A	6	2002 - 2005	18-0033	478736	73L / 19.3 Gal.	15W-40 VDS-2 or VDS-3 / API CI-4 or higher
TAMD40A / B	6	1980 - 1986	18-7926	423135	10.5L / 11.0 Qt.	15W-40 VDS-2 or VDS-3 / API CI-4 or higher
TAMD41A/B/D	6	1986 - 1994	18-7926	423135	10.5L / 11.0 Qt.	15W-40 VDS-2 or VDS-3 / API CI-4 or higher
TAMD42 B/WJ-A	6	1993 - 2003	18-7926	423135	10.5L / 11.0 Qt.	15W-40 VDS-2 or VDS-3 / API CI-4 or higher
TAMD60A/B/C	6	1976 - 1987	18-7926	423135	20L / 5.28 Gal.	15W-40 VDS-2 or VDS-3 / API CI-4 or higher
TAMD61A	6	1986 - 1999	18-0032	847741	20L / 5.28 Gal.	15W-40 VDS-2 or VDS-3 / API CI-4 or higher
TAMD62A	6	1992 - 1994	18-0032	847741	20L / 5.28 Gal.	15W-40 VDS-2 or VDS-3 / API CI-4 or higher
TAMD63LA, 63PA	6	1994 - 2005	18-7974	3827069	20L / 5.28 Gal.	15W-40 VDS-2 or VDS-3 / API CI-4 or higher
TAMD63P-A	6	1994 - 2005	18-0032	847741	20L / 5.28 Gal.	15W-40 VDS-2 or VDS-3 / API CI-4 or higher
TAMD70B/C	6	1970 - 1978	18-7926	423135	20L / 5.28 Gal.	15W-40 VDS-2 or VDS-3 / API CI-4 or higher
TAMD71A	6	1986 - 1994	18-0032	847741	20L / 5.28 Gal.	15W-40 VDS-2 or VDS-3 / API CI-4 or higher
TAMD71B	6	1989 - 2000	18-1974	3827069	20L / 5.28 Gal.	15W-40 VDS-2 or VDS-3 / API CI-4 or higher
TAMD72A	6	1991 - 1994	18-0032	847741	20L / 5.28 Gal.	15W-40 VDS-2 or VDS-3 / API CI-4 or higher
TAMD72P-A	6	1995 - 1997	18-0032	847741	27L / 7.1 Gal.	15W-40 VDS-2 or VDS-3 / API CI-4 or higher
TAMD72WJ-A	6	1993 - 1997	18-0032	847741	20L / 5.28 Gal.	15W-40 VDS-2 or VDS-3 / API CI-4 or higher
TAMD73P-A/WJ-A	6	1997 - 1999	18-7926	423135	28L / 7.4 Gal.	15W-40 VDS-2 or VDS-3 / API CI-4 or higher
TAMD74A	6	2000 - 2001	18-0032	847741	29L / 7.7 Gal.	15W-40 VDS-2 or VDS-3 / API CI-4 or higher
TAMD74A-A / A-B / P-B	6	2000 - 2005	18-7926		24L / 6.3 Gal.	15W-40 VDS-2 or VDS-3 / API CI-4 or higher
TAMD74C-A, B	6	2000 - 2001	18-0032	847741	25L / 6.6 Gal.	15W-40 VDS-2 or VDS-3 / API CI-4 or higher
TAMD74L-A, B	6	2000 - 2005	18-0032	847741	25L / 6.6 Gal.	15W-40 VDS-2 or VDS-3 / API CI-4 or higher
TAMD74P-A, B	6	1998 - 2005	18-0032	847741	25L / 6.6 Gal.	15W-40 VDS-2 or VDS-3 / API CI-4 or higher
TAMD75P-A	6	1998 - 2005	18-7926		24L / 6.3 Gal.	15W-40 VDS-2 or VDS-3 / API CI-4 or higher
THAMD70B/C	6	1972 - 1979	18-7926		24L / 6.3 Gal.	15W-40 VDS-2 or VDS-3 / API CI-4 or higher
TMD100A	6	1965 - 1983	18-7926		50L / 13.2 Gal.	15W-40 VDS-2 or VDS-3 / API CI-4 or higher
TMD102A	6	1988 - 2000	18-0033	478736	50L / 13.2 Gal.	15W-40 VDS-2 or VDS-3 / API CI-4 or higher
TMD120A/B	6	1970 - 1983	18-7878-1	3517857	50L / 13.2 Gal.	15W-40 VDS-2 or VDS-3 / API CI-4 or higher
TMD41B	6	1989 - 1993	18-7926		8.5L / 9 Qt.	15W-40 VDS-2 or VDS-3 / API CI-4 or higher
TMD41L-A	6	1994 - 1997	18-7926		10.5L / 11.0 Qt.	15W-40 VDS-2 or VDS-3 / API CI-4 or higher
TMD70B/C	6	1972 - 1985	18-0032	847741	20L / 5.28 Gal.	15W-40 VDS-2 or VDS-3 / API CI-4 or higher

OIL FILTER QUICK-REFERENCE GUIDE

WESTERBEKE						
Model	Cyl.	Year	Oil Filter	Replaces	Crankcase Capacity	Recommended Oil
PROPULSION ENGINES						
11A One	1	2001 - Current	23-7800	036918	1.6L / 1.7 Qt.	SAE 10W-30
12B Two	2	1983 - 1992	23-7800	036918	2.8L / 3.0 Qt.	SAE 10W-30
12C Two	2	1992 - Current	23-7800	036918	2.8L / 3.0 Qt.	SAE 10W-30
12D Two	2	Current	23-7800	036918	2.8L / 3.0 Qt.	15W-40 API CI-4, CI-4 Plus, CJ-4
20B Two	2	1987 - Current	23-7800	036918	2.8L / 3.0 Qt.	15W-40 API CI-4, CI-4 Plus, CJ-4
W13	2	1980 - 1984	23-7800	036918	2.8L / 3.0 Qt.	SAE 10W-30
W13A	2	1984 - 1988	23-7800	036918	2.8L / 3.0 Qt.	SAE 10W-30
30B Three	3	1987 - Current	23-7800	036918	2.8L / 3.0 Qt.	15W-40 API CI-4, CI-4 Plus, CJ-4
30C Three	3	Current	23-7800	036918	2.8L / 3.0 Qt.	15W-40 API CI-4, CI-4 Plus, CJ-4
35B Three	3	1987 - 2000	23-7800	036918	4.5L / 4.75 Qt.	SAE 10W-30
35C Three	3	2000 - 2002	23-7800	036918	4.5L / 4.75 Qt.	15W-40 API CI-4, CI-4 Plus, CJ-4
35D Three	3	2002 - Current	23-7800	036918	4.5L / 4.75 Qt.	15W-40 API CI-4, CI-4 Plus, CJ-4
35E Three	3	Current	23-7800	036918	4.5L / 4.75 Qt.	15W-40 API CI-4, CI-4 Plus, CJ-4
W18	3	1985 - 1989	23-7800	036918	3.78L / 4.0 Qt.	SAE 10W-30
W21	3	1980 - 1984	23-7800	036918	3.78L / 4.0 Qt.	SAE 10W-30
W21A	3	1984 - 1987	23-7800	036918	3.78L / 4.0 Qt.	SAE 10W-30
38B Four	4	1987 - 2001	23-7825	035828	4.5L / 4.75 Qt.	SAE 10W-30
42B Four	4	1987 - 1999	23-7825	035828	4.5L / 4.75 Qt.	SAE 10W-30
44A Four	4	1999 - 2002	23-7800	036918	4.5L / 4.75 Qt.	15W-40 API CI-4, CI-4 Plus, CJ-4
44B Four	4	2002 - Current	23-7800	036918	4.5L / 4.75 Qt.	15W-40 API CI-4, CI-4 Plus, CJ-4
44C Four	4	Current	23-7800	036918	4.5L / 4.75 Qt.	15W-40 API CI-4, CI-4 Plus, CJ-4
55A Four	4	1995 - 2002	23-7825	035828	5.0L / 5.28 Qt.	SAE 30 CF
55B Four	4	2002 - 2005	23-7800	036918	7.6L / 8.0 Qt.	SAE 30 CF
55C Four	4	2005 - Current	23-7800	036918	7.6L / 8.0 Qt.	SAE 30 CF
55D Four	4	Current	23-7800	036918	7.6L / 8.0 Qt.	SAE 30 CF
63B Four	4	1990 - 1994	23-7825	035828	11.3L / 12 Qt.	15W-40 API CI-4, CI-4 Plus, CJ-4
63C Four	4	1994 - 2000	23-7825	035828	11.3L / 12 Qt.	15W-40 API CI-4, CI-4 Plus, CJ-4
63D Four	4	2001 - 2003	23-7825	035828	5.0L / 5.28 Qt.	15W-40 API CI-4, CI-4 Plus, CJ-4
64A Four	4	2003 - Current	23-7826	040154	6.15L / 6.5 Qt.	15W-40 API CI-4, CI-4 Plus, CJ-4
71B Four	4	1991 - 1994	23-7825	035828	11.3L / 12 Qt.	15W-40 API CI-4, CI-4 Plus, CJ-4
71C Four	4	1994 - Current	23-7826	040154	11.3L / 12 Qt.	15W-40 API CI-4, CI-4 Plus, CJ-4
82B Four	4	1991 - Current	23-7826	040154	11.3L / 12 Qt.	15W-40 API CI-4, CI-4 Plus, CJ-4
90A Four	4	1999 - Current	23-7826	040154	6.0L / 6.3 Qt.	15W-40 API CI-4, CI-4 Plus, CJ-4
W27	4	1980 - 1984	23-7800	036918	3.78L / 4.0 Qt.	SAE 10W-30
W27A	4	1984 - 1988	23-7800	036918	3.78L / 4.0 Qt.	SAE 10W-30
W33	4	1980 - 1984	23-7825	035828	3.78L / 4.0 Qt.	SAE 10W-30
W33A	4	1984 - 1988	23-7825	035828	3.78L / 4.0 Qt.	SAE 10W-30
W41G	4	1986 - 1993	23-7800	036918	-	-
W46	4	1985 - 1990	23-7825	035828	6.15L / 6.5 Qt.	SAE 10W-30
W70	4	1982 - 1991	23-7826	040154	6.15L / 6.5 Qt.	SAE 10W-30
W70G	4	1988 - 2001	23-7800	036918	-	-
W70GA	4	2003 - Current	23-7800	036918	-	-
108B Six	6	1991 - 1994	23-7826	040154	11.3L / 12 Qt.	15W-40 API CI-4, CI-4 Plus, CJ-4
108C Six	6	1994 - Current	23-7826	040154	11.3L / 12 Qt.	15W-40 API CI-4, CI-4 Plus, CJ-4
W100	6	1982 - 1991	23-7826	040154	11.3L / 12 Qt.	-

All listed oil capacities are approximate amounts only and may or may not include the oil filter capacity.
 ALWAYS follow proper crankcase drain and fill procedures. Check engine dipstick for proper crankcase oil level.

WESTERBEKE CONTINUED ON NEXT PAGE

OIL FILTER QUICK-REFERENCE GUIDE

WESTERBEKE

WESTERBEKE						
Model	Cyl.	Year	Oil Filter	Replaces	Crankcase Capacity	Recommended Oil
GEN SET (ALL MODELS ARE 60HZ. USA / NORTH AMERICAN)						
10.0 BTD	3	1984 - 2000	23-7800	036918	3.3 Qt.	15W-40 API CI-4, CI-4 Plus, CJ-4
10.0 BTDA	3	2000 - Current	23-7800	036918	3.8L / 4.0 Qt.	15W-40 API CI-4, CI-4 Plus, CJ-4
10.0 EDT D-NET	3	-	23-7800	036918	3.8L / 4.0 Qt.	15W-40 API CI-4, CI-4 Plus, CJ-4
10.0 SBEG Low-CO	4	2005 - Current	23-7800	036918	3.5 Qt.	SAE 10W-30
11.0 TWG	4	1984 - 1987	23-7800	036918	-	SAE 10W-30
11.0 WMD	4	1980 - 1987	23-7800	036918	6.15 Qt.	15W-40 API CI-4, CI-4 Plus, CJ-4
11.5 BTD	3	-	23-7800	036918	4.7L / 5.0 Qt.	15W-40 API CI-4, CI-4 Plus, CJ-4
11.5 EDT D-NET	3	-	23-7800	036918	4.7L / 5.0 Qt.	15W-40 API CI-4, CI-4 Plus, CJ-4
12.06 EDT D-NET	3	-	23-7800	036918	4.7L / 5.0 Qt.	15W-40 API CI-4, CI-4 Plus, CJ-4
12.5 BEG	4	2002 - Current	23-7800	036918	3.5 Qt.	SAE 10W-30
12.5 BTDB	4	-	23-7800	036918	5.2L / 5.5 Qt.	15W-40 API CI-4, CI-4 Plus, CJ-4
12.5 BTG	4	1987 - 2001	23-7800	036918	3.8L / 4.0 Qt.	SAE 10W-30
12.5 BTGA	4	2001 - 2002	23-7800	036918	-	SAE 10W-30
12.5 EDT D-NET	4	-	23-7800	036918	5.2L / 5.5 Qt.	15W-40 API CI-4, CI-4 Plus, CJ-4
12.5 SBEG Low-CO	4	2005 - Current	23-7800	036918	3.5 Qt.	SAE 10W-30
12.6 BTD	3	2002 - Current	23-7800	036918	3.8L / 4.0 Qt.	15W-40 API CI-4, CI-4 Plus, CJ-4
14.0 SBEG Low-CO	4	2005 - Current	23-7800	036918	3.5 Qt.	SAE 10W-30
15.0 BEG	4	2002 - Current	23-7800	036918	3.5 Qt.	SAE 10W-30
15.0 BTDC	4	2000 - Current	23-7800	036918	5.2L / 5.5 Qt.	15W-40 API CI-4, CI-4 Plus, CJ-4
15.0 BTG	4	1987 - 2001	23-7800	036918	3.8L / 4.0 Qt.	SAE 10W-30
15.0 EDT D-NET	4	-	23-7800	036918	5.2L / 5.5 Qt.	15W-40 API CI-4, CI-4 Plus, CJ-4
20.0 BEG	4	1995 - 2004	23-7800	036918	4.5 Qt.	SAE 10W-30
20.0 BEGA	4	2004 - Current	23-7800	036918	-	SAE 10W-30
20.0 SBEG Low-CO	4	2005 - Current	23-7800	036918	4.5 Qt.	SAE 10W-30
20.0 SBEGA Low-CO	4	-	23-7800	036918	-	SAE 10W-30
22.5 SBEG Low-CO	4	2005 - Current	23-7800	036918	-	SAE 10W-30
22.5 SBEGA Low-CO	4	-	23-7800	036918	4.5 Qt.	SAE 10W-30
25.0 BEG	4	1999 - 2004	23-7800	036918	4.5 Qt.	SAE 10W-30
3.0 WMD	2	1982 - 1988	23-7800	036918	2.0 Qt.	15W-40 API CI-4, CI-4 Plus, CJ-4
4.0 BCD (60 Hz.) ONLY	3	2002 - Current	23-7800	036918	3.05L / 3.2 Qt.	15W-40 API CI-4, CI-4 Plus, CJ-4
4.0 BCDA 60Hz. ONLY	3	2008 - Current	23-7800	036918	3.05L / 3.2 Qt.	15W-40 API CI-4, CI-4 Plus, CJ-4
4.4 BCD	2	1986 - 1989	23-7800	036918	2.4L / 2.5 Qt.	15W-40 API CI-4, CI-4 Plus, CJ-4
4.4 WMD	2	1980 - 1986	23-7800	036918	2.4L / 2.5 Qt.	15W-40 API CI-4, CI-4 Plus, CJ-4
4.5 BCG	3	1988 - 1997	23-7800	036918	2.8L / 3.0 Qt.	SAE 10W-30
4.5 BCGA	3	1997	23-7800	036918	2.4L / 2.5 Qt.	SAE 10W-30
4.5 BCGB	3	1999 - 2002	23-7800	036918	2.4L / 2.5 Qt.	SAE 10W-30
4.5 BCGTC	3	1997 - 2002	23-7800	036918	2.6L / 2.7 Qt.	SAE 10W-30
4.5 BCGTE	3	1997 - 2001	23-7800	036918	2.6L / 2.7 Qt.	SAE 10W-30
5.0 BCD	3	1989 - 1996	23-7800	036918	3.0L / 3.2 Qt.	15W-40 API CI-4, CI-4 Plus, CJ-4
5.0 BCDA	3	1996	23-7800	036918	3.0L / 3.2 Qt.	15W-40 API CI-4, CI-4 Plus, CJ-4
5.0 BCDB(60Hz)	3	1996 - Current	23-7800	036918	3.0L / 3.2 Qt.	15W-40 API CI-4, CI-4 Plus, CJ-4
5.0 BCG low profile	3	2002 - Current	23-7800	036918	2.4L / 2.5 Qt.	SAE 40 SJ
5.0 BCGA	3	2002	23-7800	036918	2.4L / 2.5 Qt.	SAE 40 SJ
5.0 SBCG Low-CO	3	2005 - Current	23-7800	036918	2.8L / 3.0 Qt.	SAE 40 SJ
5.5 BCD	3	-	23-7800	036918	3.0L / 3.2 Qt.	15W-40 API CI-4, CI-4 Plus, CJ-4
5.5 EDC D-NET	3	-	23-7800	036918	3.6L / 3.8 Qt.	15W-40 API CI-4, CI-4 Plus, CJ-4
6.0 BCD	3	1986 - 1989	23-7800	036918	3.0L / 3.2 Qt.	15W-40 API CI-4, CI-4 Plus, CJ-4

WESTERBEKE CONTINUED ON NEXT PAGE

OIL FILTER QUICK-REFERENCE GUIDE

WESTERBEKE

Model	Cyl.	Year	Oil Filter	Replaces	Crankcase Capacity	Recommended Oil
GEN SET (ALL MODELS ARE 60HZ. USA / NORTH AMERICAN)						
6.0 WMD	3	-	23-7800	036918	3.0L / 3.2 Qt.	15W-40 API CI-4, CI-4 Plus, CJ-4
6.5 SBCG Low-CO	3	2005 - Current	23-7800	036918	2.8L / 3.0 Qt.	SAE 40 SJ
6.5 TWG	4	1984 - 1987	23-7800	036918	3.0L / 3.2 Qt.	SAE 10W-30
7.0 BCG / BCGA	3	1989 - 1997	23-7800	036918	2.8L / 3.0 Qt.	SAE 10W-30
7.0 BCGB	3	1999 - 2002	23-7800	036918	2.4L / 2.5 Qt.	SAE 10W-30
7.0 BCGC Low Profile	3	2002 - 2004	23-7800	036918	2.4L / 2.5 Qt.	SAE 40 SJ
7.0 BCGD Low Profile	3	2004 - Current	23-7800	036918	2.4L / 2.5 Qt.	SAE 40 SJ
7.2 BCGTC	3	1997 - 2002	23-7800	036918	2.6L / 2.7 Qt.	SAE 10W-30
7.2 BCGTE	3	1997 - 2001	23-7800	036918	2.6L / 2.7 Qt.	SAE 10W-30
7.6 BTD	3	1993 - Current	23-7800	036918	3.6L / 3.8 Qt.	15W-40 API CI-4, CI-4 Plus, CJ-4
7.6 EDT D-NET	3	-	23-7800	036918	3.6L / 3.8 Qt.	15W-40 API CI-4, CI-4 Plus, CJ-4
7.7 WMD	3	1980 - 1984	23-7800	036918	3.0L / 3.2 Qt.	15W-40 API CI-4, CI-4 Plus, CJ-4
8.0 BCDT	2	2002 - 2004	23-7800	036918	2.9L / 3.1 Qt.	15W-40 API CI-4, CI-4 Plus, CJ-4
8.0 BTD	3	1984 - 2000	23-7800	036918	3.0L / 3.2 Qt.	15W-40 API CI-4, CI-4 Plus, CJ-4
8.0 BTDA	3	2000 - Current	23-7800	036918	3.0L / 3.2 Qt.	15W-40 API CI-4, CI-4 Plus, CJ-4
8.0 EDT D-NET	3	-	23-7800	036918	3.8L / 4.0 Qt.	15W-40 API CI-4, CI-4 Plus, CJ-4
8.0 SGEG Low-CO	4	2005 - Current	23-7800	036918	3.3L / 3.5 Qt.	SAE 10W-30
8.0 TWG	4	1983 - 1987	23-7800	036918	3.0L / 3.2 Qt.	SAE 10W-30
8.0 WMD	3	1980 - 1984	23-7800	036918	3.0L / 3.2 Qt.	15W-40 API CI-4, CI-4 Plus, CJ-4
8.5 BTG	4	1987 - 1993	23-7800	036918	3.7L / 3.9 Qt.	SAE 10W-30
8.5 BTGA	4	1993 - 2002	23-7800	036918	3.8L / 4.0 Qt.	SAE 10W-30
9.6 BCGTC	3	1997 - 2002	23-7800	036918	2.6L / 2.7 Qt.	SAE 10W-30
9.6 BCGTE	3	-	23-7800	036918	2.6L / 2.7 Qt.	SAE 10W-30
11.0 BTD	4	1987 - 2001	23-7825	035828	4.0L / 4.2 Qt.	15W-40 API CI-4, CI-4 Plus, CJ-4
12.5 BTDA	4	1988 - 2000	23-7825	035828	4.5L / 4.7 Qt.	15W-40 API CI-4, CI-4 Plus, CJ-4
12.5 WMD	4	1980 - 1987	23-7825	035828	4.5L / 4.7 Qt.	15W-40 API CI-4, CI-4 Plus, CJ-4
15.0 BTD	4	1987 - 1990	23-7825	035828	6.6L / 7.0 Qt.	15W-40 API CI-4, CI-4 Plus, CJ-4
15.0 BTDA	4	1990 - 1994	23-7825	035828	5.0L / 5.3 Qt.	15W-40 API CI-4, CI-4 Plus, CJ-4
15.0 BTDB	4	1994 - 2000	23-7825	035828	5.0L / 5.3 Qt.	15W-40 API CI-4, CI-4 Plus, CJ-4
20.0 BED	4	1990 - 1995	23-7825	035828	6.15L / 6.5 Qt.	15W-40 API CI-4, CI-4 Plus, CJ-4
25.0 BED PTO	4	1992 - Current	23-7826	040154	6.15L / 6.5 Qt.	15W-40 API CI-4, CI-4 Plus, CJ-4
25.0 WTA	4	1982 - 1985	23-7826	040154	6.0L / 6.3 Qt.	15W-40 API CI-4, CI-4 Plus, CJ-4
32.0 BED	6	1993 - 1994	23-7826	040154	Refer to Owners Manual	15W-40 API CI-4, CI-4 Plus, CJ-4
32.0 BEDA	4	1994 - Current	23-7826	040154	6.0L / 6.3 Qt.	15W-40 API CI-4, CI-4 Plus, CJ-4
32.0 BEDB	6	1994	23-7826	040154	11.3L / 12 Qt.	15W-40 API CI-4, CI-4 Plus, CJ-4
20.0 BEDA	4	1995 - Current	23-7826	040154	6.15L / 6.5 Qt.	15W-40 API CI-4, CI-4 Plus, CJ-4
25.0 BED	4	1992 - Current	23-7826	040154	6.15L / 6.5 Qt.	15W-40 API CI-4, CI-4 Plus, CJ-4

YAMAHA

Model	Year	Oil Filter	Replaces	Crankcase Capacity	Recommended Oil
F2.5	2003 - 2011	----		0.35 L / 0.35 Qt.	10W-30 FC-W
F4	1999 - 2011	----		0.50 L / 0.53 Qt.	10W-30 FC-W
F6, F/T8	2001 - 2011	----		0.80 L / 0.84 Qt.	10W-30 FC-W
T9.9 (Model 6G8)	1991 - 04/2005	18-7901	6G8-13440-00-00	1.0 L / 1.06 Qt.	10W-30 FC-W
F9.9 (Model 6G8)	1990 - 04/2005	18-7901	6G8-13440-00-00	1.0 L / 1.06 Qt.	10W-30 FC-W
T9.9 (Model 66R)	2005 - 04/2006	18-7911-1	5G8-13440-00-00	0.80 L / 0.84 Qt.	10W-30 FC-W

All listed oil capacities are approximate amounts only and may or may not include the oil filter capacity. ALWAYS follow proper crankcase drain and fill procedures. Check engine dipstick for proper crankcase oil level.

YAMAHA CONTINUED ON NEXT PAGE

OIL FILTER QUICK-REFERENCE GUIDE

YAMAHA

Model	Year	Oil Filter	Replaces	Crankcase Capacity	Recommended Oil
F9.9 (Model 66R)	2005 - 04/2006	18-7911-1	5GH-13440-00-00	0.80 L / 0.84 Qt.	10W-30 FC-W
F15	1998 - 1999	18-7902	3FV-13440-10-00	1.0 L / 1.06 Qt.	10W-30 FC-W
F15	2000 - 2006	18-7911-1	5GH-13440-00-00	1.8 L / 1.9 Qt.	10W-30 FC-W
F15C	2007 - 2012	18-8700	5GH-13440-20-00	1.8 L / 1.9 Qt.	10W-30 FC-W
F20	2007 - 2012	18-8700	5GH-13440-20-00	1.8 L / 1.9 Qt.	10W-30 FC-W
F25	1998 - 1999	18-7902	3FV-13440-10-00	1.7 L / 1.8 Qt.	10W-30 FC-W
F25 / T25	2000 - 04/2006	18-7911-1	5GH-13440-00-00	1.7 L / 1.8 Qt.	10W-30 FC-W
F25	2009 - Current	18-8700	5GH-13440-20-00	1.7 L / 1.8 Qt.	10W-30 FC-W
F30	2001 - 2006	18-7911-1	5GH-13440-00-00	2.0 L / 2.1 Qt.	10W-30 FC-W
F40	1999 - 2000	18-7902	3FV-13440-10-00	2.0 L / 2.1 Qt.	10W-30 FC-W
F40 / F40B (International)	2001 - 2008	18-7911-1	5GH-13440-00-00	2.0 L / 2.1 Qt.	10W-30 FC-W
F40A	2001 - Current	18-8700	5GH-13440-20-00	2.0 L / 2.1 Qt.	10W-30 FC-W
T50	1996 - 1999	18-7902	3FV-13440-10-00	2.0 L / 2.1 Qt.	10W-30 FC-W
T50	2000 - 2004	18-7911-1	5GH-13440-00-00	2.0 L / 2.1 Qt.	10W-30 FC-W
T50	2005 - Current	18-8700	5GH-13440-20-00	2.0 L / 2.1 Qt.	10W-30 FC-W
F50	1995 - 1999	18-7902	3FV-13440-10-00	2.0 L / 2.1 Qt.	10W-30 FC-W
F50	1999 - 2004	18-7911-1	5GH-13440-00-00	2.0 L / 2.1 Qt.	10W-30 FC-W
F50	2005 - Current	18-8700	5GH-13440-20-00	2.0 L / 2.1 Qt.	10W-30 FC-W
T60	1999 - 2004	18-7911-1	5GH-13440-00-00	2.0 L / 2.1 Qt.	10W-30 FC-W
T60	2005 - Current	18-8700	5GH-13440-20-00	2.0 L / 2.1 Qt.	10W-30 FC-W
F60	1999 - 2004	18-7911-1	5GH-13440-00-00	2.0 L / 2.1 Qt.	10W-30 FC-W
F60	2005 - Current	18-8700	5GH-13440-20-00	2.0 L / 2.1 Qt.	10W-30 FC-W
F70	All Years	18-8700	5GH-13440-20-00	2.0 L / 2.1 Qt.	10W-30 FC-W
F75	All Years	18-7911-1	5GH-13440-00-00	4.3 L / 4.5 Qt.	10W-30 FC-W
F80	1999	18-7902	3FV-13440-10-00	4.3 L / 4.5 Qt.	10W-30 FC-W
F80	2000 - Current	18-7911-1	5GH-13440-00-00	4.3 L / 4.5 Qt.	10W-30 FC-W
F90	All Years	18-7911-1	5GH-13440-00-00	4.3 L / 4.5 Qt.	10W-30 FC-W
F100	1999	18-7902	3FV-13440-10-00	4.3 L / 4.5 Qt.	10W-30 FC-W
F100	2000 - Current	18-7911-1	5GH-13440-00-00	4.3 L / 4.5 Qt.	10W-30 FC-W
F115	All Years	18-7911-1	5GH-13440-00-00	4.3 L / 4.5 Qt.	10W-30 FC-W
F150	2004 - Current	18-7906-1	69J-13440-01-00	5.4 L / 5.7 Qt.	10W-30 FC-W
F200 (3.3L)	All Years	18-7906-1	69J-13440-01-00	5.8 L / 6.13 Qt.	10W-30 FC-W
F200 (4.2L SHO)	2009 - Current	18-7954	N26-13440-00-00	7.1L / 7.5 Qt.	5W-30 FC-W Full Synthetic
F225 (3.3L)	All Years	18-7906-1	69J-13440-01-00	5.8 L / 6.13 Qt.	10W-30 FC-W
F225 (4.2L)	2009 - Current	18-7954	N26-13440-00-00	7.1L / 7.5 Qt.	10W-30 FC-W
F250 (3.3L)	All Years	18-7906-1	69J-13440-01-00	5.8 L / 6.13 Qt.	10W-30 FC-W
F250 (4.2L)	2009 - Current	18-7954	N26-13440-00-00	7.1L / 7.5 Qt.	10W-30 FC-W
F300 (V8)	2007 - Current	18-7954	N26-13440-00-00	8.0 L / 8.45 Qt.	10W-30 FC-W
F350 (V8)	2007 - Current	18-7954	N26-13440-00-00	8.0 L / 8.45 Qt.	10W-30 FC-W

YANMAR

Model	Cyl.	Year	Oil Filter	Replaces	Crankcase Capacity	Recommended Oil
1GM	1	1980 - 1983	18-7910-1	124450-35100 119660-35150 119660-35150	1.6 Qt.	SAE 15W-40 CI-4 Refer to owners manual
1GM10	1	1983 - 2009	18-7910-1	124450-35100 119660-35150 119305-35151	1.6 Qt.	SAE 15W-40 CI-4 Refer to owners manual
2GM	2	1980 - 1983	18-7910-1	124450-35100 119660-35150 119305-35151	2.1 Qt.	SAE 15W-40 CI-4 Refer to owners manual

YANMAR CONTINUED ON NEXT PAGE

OIL FILTER QUICK-REFERENCE GUIDE

YANMAR

Model	Cyl.	Year	Oil Filter	Replaces	Crankcase Capacity	Recommended Oil
2GM20	2	1983 - 2005	18-7910-1	124450-35100 119660-35150 119305-35151	2.1 Qt.	SAE 15W-40 CI-4 Refer to owners manual
2GM20-YEU (Serial No. Starts w/ E)	2	1997 - Current	18-7910-1	119660-35150 119305-35151	2.1 Qt.	SAE 15W-40 CI-4 Refer to owners manual
2GM20F	2	1983 - 2005	18-7910-1	124450-35100 119660-35150 119305-35151	2.1 Qt.	SAE 15W-40 CI-4 Refer to owners manual
2GMF	2	1980 - 1983	18-7910-1	124450-35100 119660-35150 119305-35151	2.1 Qt.	SAE 15W-40 CI-4 Refer to owners manual
2QM15	2	1977 - 1980	18-7910-1	124450-35100 119660-35150 119305-35151	2.1 Qt.	SAE 15W-40 CI-4 Refer to owners manual
2QM20 (Serial #81181 and Higher)	2	1975 - 1980	18-7917	124550-35110 124085-35113	2.1 Qt.	SAE 15W-40 CI-4 Refer to owners manual
2YM15	2	2004 - Current	18-7910-1	119305-35151	2.1 Qt.	SAE 15W-40 CI-4 Refer to owners manual
3GM30	3	1983 - Current	18-7910-1	124450-35100 119660-35150 119305-35151	2.7 Qt.	SAE 15W-40 CI-4 Refer to owners manual
3GM30-YEU (Serial No. Starts w/ E)	3	1997 - Current	18-7910-1	119660-35150 119305-35151	2.7 Qt.	SAE 15W-40 CI-4 Refer to owners manual
3GM30F	3	1983 - 2005	18-7910-1	124450-35100 119660-35150 119305-35151	2.7 Qt.	SAE 15W-40 CI-4 Refer to owners manual
3GM	3	1980 - 1983	18-7910-1	124450-35100 119660-35150 119305-35151	2.7 Qt.	SAE 15W-40 CI-4 Refer to owners manual
3GMD	3	1980 - 1983	18-7910-1	119660-35150 119305-35151	2.7 Qt.	SAE 15W-40 CI-4 Refer to owners manual
3GMF	3	1980 - 1983	18-7910-1	124450-35100 119660-35150 119305-35151	2.7 Qt.	SAE 15W-40 CI-4 Refer to owners manual
3HM	3	1980 - 1983	18-7917	124550-35110 124085-35113		Refer to owners manual
3HM35	3	1983 - 1992	18-7917	124550-35110 124085-35113		SAE 15W-40 CI-4 Refer to owners manual
3HM35F	3	1983 - 1992	18-7917	124550-35110 124085-35113		SAE 15W-40 CI-4 Refer to owners manual
3HMF	3	1980 - 1983	18-7917	124550-35110 124085-35113		SAE 15W-40 CI-4 Refer to owners manual
3JH2TBE	3	1991-1999	18-7910-1	119305-35151		SAE 15W-40 CI-4 Refer to owners manual
3JH2BE	3	1989-1999	18-7910-1	119305-35151		SAE 15W-40 CI-4 Refer to owners manual
3JH2	3	1992-1999	18-7910-1	119305-35151		SAE 15W-40 CI-4 Refer to owners manual
3JH3	3	1999 - 2004	18-7910-1	119305-35150 119305-35151		SAE 15W-40 CI-4 Refer to owners manual
3JH3E-YEU	3	2004 - Current	18-7910-1	119305-35150 119305-35151	5.2 Qt.	SAE 15W-40 CI-4 Refer to owners manual
3JH4E (40hp.)	3	2004 - Current	18-7910-1	119305-35150 119305-35151		SAE 15W-40 CI-4 Refer to owners manual
3QM30	3	1976 - 1980	18-7917	124550-35110 124085-35113		SAE 15W-40 CI-4 Refer to owners manual

All listed oil capacities are approximate amounts only and may or may not include the oil filter capacity.
ALWAYS follow proper crankcase drain and fill procedures. Check engine dipstick for proper crankcase oil level.

YANMAR CONTINUED ON NEXT PAGE

OIL FILTER QUICK-REFERENCE GUIDE

YANMAR

Model	Cyl.	Year	Oil Filter	Replaces	Crankcase Capacity	Recommended Oil
3QM30F	3	1976 - 1980	18-7917	124550-35110 124085-35113		SAE 15W-40 CI-4 Refer to owners manual
3YM20	3	2004 - Current	18-7910-1	119305-35151	2.6 Qt.	SAE 15W-40 CI-4 Refer to owners manual
3YM30	3	2004 - Current	18-7910-1	119305-35151	2.6 Qt.	SAE 15W-40 CI-4 Refer to owners manual



All listed oil capacities are approximate amounts only and may or may not include the oil filter capacity. ALWAYS follow proper crankcase drain and fill procedures. Check engine dipstick for proper crankcase oil level.

ALPHA CROSS REFERENCE

AC	
PF1250	18-7758
PF1267	18-0034
PF454	18-7824
PF2	18-7875
PF1218	18-7876
PF13	18-7878-1
PF857F	18-7880
PF2210	18-7884
PF939	18-7886
PF881F	-----
SPF53	18-7897
PF911F	N/A
PF1127	18-7910-1
PF1237*	18-7911-1
PF1237*	18-7913
PF2057	18-7914
PF1233	18-7916
PF60	18-7925
PF2207	18-7926
PF2203	18-7927
PF2257	18-8003
PF1127	23-7800
* Refer to Engine Mfg. Section	

BALDWIN	
B131	23-7801
B134	18-7871
B1400*	18-7902
B1400*	18-7911-1
B1400*	18-7913
B1402*	18-7909
B1402*	18-7914
B161-S	23-7842
B163	23-7841
B167	18-7926
B168	18-7917
B178	18-7925
B179*	18-7910-1
B179*	23-7800
B179*	23-7824
B2	18-7875
B202	23-7825
B233*	18-7878-1
B233*	23-7840
B33*	18-7916
B33*	23-7821
B35-S	18-7879-1
B360	18-7824
B37*	18-7895
B37*	18-7896
B43-S	18-7974
B6	18-7876
B7165	18-7884

BALDWIN	
B7333	18-7897
B75*	18-0032
B75*	18-7927
B76	18-7880
B7685	18-0034
B76-SS	18-0033
BT216	18-7886
BT223	18-7915-1
BT237	-----
P7417	18-8003
* Refer to Engine Mfg. Section	

BRP	
See Evinrude / Johnson / OMC	

CATERPILLAR	
1R-0658	18-7880

CHRYSLER INBOARD	
1851658	18-7885
3549957	18-7878-1
L-1108	18-7878-1
L-19	18-7878-1
L-319	18-7879-1

CRUSADER	
22679	18-7875
201101	18-7824
201104	18-7876

DETROIT DIESEL	
25010495	N/A

EVINRUDE / JOHNSON / OMC	
173232	18-7824
173233	18-7876
173834	18-7879-1
434839	18-7916
502901	18-7876
502902	18-7824
502903	18-7879-1
502904	18-7878-1
763364	18-7903
778885	18-7915-1
778886	18-7896
778887	18-7897
5031411	18-7915-1
5033102	18-7903
5033539	18-7896
5033919	18-7897
5035703	18-7895

FRAM	
CH9954	18-8003
P9407	18-0034
PH10809	23-7823

FRAM	
PH13	18-7876
PH16*	18-7878-1
PH16*	23-7841
PH2821A	18-7886
PH2870A	18-7925
PH2921	23-7825
PH2951*	18-7897
PH2951*	23-7801
PH30	18-7824
PH3306A	18-7926
PH3387A	18-7974
PH3545*	18-0032
PH3545*	18-7927
PH3593A*	18-7910-1
PH3593A*	23-7800
PH3612	N/A
PH3614	18-7884
PH3766	18-7871
PH3980	18-7879-1
PH4386*	18-7895
PH4386*	18-7896
PH4967*	18-7897
PH4967*	18-7906-1
PH4967*	18-7916
PH4967*	23-7821
PH49A*	18-0033
PH49A*	18-7880
PH5	18-7876
PH5046	18-7917
PH6017A*	18-7902
PH6017A*	18-7909
PH6017A*	18-7911-1
PH6017A*	18-7913
PH6017A*	18-8700
PH6811	23-7842
PH7317	18-7914
PH7328	23-7841
PH7575*	18-7884
PH7575*	18-7915-1
PH8842	18-0033
PH8A	18-7875
PH9688	23-7842
PH977A	-----
* Refer to Engine Mfg. Section	

HONDA	
15400-PFB-007	18-7911-1
15400-PFB-014	18-7913
15400-PLM-A01PE	18-7909
15400-POH-305PE	18-7909
15400-POH-305PE	18-7909
15400-ZJ1-004	18-7909

All listed oil capacities are approximate amounts only and may or may not include the oil filter capacity. ALWAYS follow proper crankcase drain and fill procedures. Check engine dipstick for proper crankcase oil level.

ALPHA CROSS REFERENCE

INDMAR	
501001	18-7824
50-1101	18-7824
KOHLER	
229678	23-7822
252834	23-7824
267714	23-7823
279449	23-7820
326817	23-7803
359771	23-7821
GM47465	23-7824
LUBER-FINER	
LFP2234	18-7926
LFP2274	18-7824
LFP3191	18-0033
LFP3191	18-7880
LFP5522	18-7917
LFP6007	18-0032
LFP8642	18-0034
LFP911	N/A
P3986	18-8003
PH1218	18-7876
PH208	18-7910-1
PH253	18-7878-1
PH2801	23-7825
PH2808	23-7800
PH2808	23-7822
PH2808	23-7824
PH2835	18-7884
PH2835	18-7915-1
PH2840	18-7895
PH2840	18-7896
PH2840	18-7897
PH2840	18-7916
PH2840	23-7821
PH2867	18-7914
PH2876	18-7913
PH299	-----
PH4403	18-7886
PH47	18-7974
PH51A	18-7879-1
PH561	18-7925
PH7028	18-7911-1
PH820	18-7758
PH8A	18-7875
MALLORY	
9-57800	18-7913
9-57801	18-7824
9-57802	18-7875
9-57803	18-7879-1
9-57804	18-7911-1
9-57806	18-7878-1

MALLORY	
9-57807	18-7903
9-57808	18-7906-1
9-57810	18-7910-1
9-57811	18-7876
9-57813	18-7916
9-57814	18-7896
9-57815	18-7897
9-57816	18-7918
9-57817	18-7915-1
9-57818	18-7895
9-57819	18-7905
9-57820	18-8003
9-57821	18-7921
9-57822	18-7758
9-57902	18-7871
9-57905	18-7926
9-57908	18-7974
9-57910	18-7880
9-57911	18-7884

MERCURY / QUICKSILVER	
14957	18-7876
32717	18-7876
38463	18-7878-1
41815	18-7879-1
46692	18-7878-1
52731	18-7876
54111	18-7824
56874	18-7875
60565	18-7875
803470	18-7878-1
35-16595T1	18-7876
35-802884Q	18-7879-1
35-802885	18-7824
35-802885T	18-7824
35-802886Q	18-7875
35-805809	18-7871
35-822626Q03	18-7913
35-822626Q04	18-7914
35-822626Q1	18-7913
35-822626Q15	18-7906-1
35-822626Q2	18-7914
35-866340K01	18-7824
35-866340Q02	18-7824
35-866340Q03	18-7824
35-877761K01	18-7758
35-877761Q01	18-7758
35-877767K01	18-7921
35-877769K01	18-7918
35-883701K01	18-7918
35-883702Q	18-7879-1
35-896549T	18-7921
803470Q	18-7878-1

NAPA	
1036	18-7879-1
1040	18-7974
1061	18-7876
1064	23-7822
1068	23-7840
1069	18-7824
1084	23-7841
1307	18-7878-1
1334	18-7910-1
1342	18-7925
1344	23-7842
1347	18-7917
1348	18-7915-1
1358	18-8700
1365	18-7911-1
1394	18-7916
1660	18-0034
1773	-----
1791	18-0033
1798	18-0032
1806	18-7886
1820	18-7926
1970	N/A
6644	23-7825
7000	18-7906-1
7145	18-7896
7186	18-8003
21036	18-7879-1
21061	18-7876
21069	18-7824
21334	23-7800
21342	18-7925
21348	18-7884
21358	18-7902
21394	23-7801
21515	18-7875
21521	18-7878-1
27145	18-7896
31358	18-8700
31515	18-7875

NISSAN / TOHATSU	
3R0076150M	18-7911-1

NORTHERN LIGHTS	
140516190	23-7801

ONAN	
122-0185	23-7841
122-0810	23-7840
185-5835	23-7842
185-7444	23-7804

All listed oil capacities are approximate amounts only and may or may not include the oil filter capacity. ALWAYS follow proper crankcase drain and fill procedures. Check engine dipstick for proper crankcase oil level.

GEAR LUBE CAPACITY CHARTS

GEAR LUBE CAPACITY CHART - HONDA ENGINES

Model	Oil Capacity		Model	Oil Capacity	
	Std. (Oz.)	Notes		Std. (Oz.)	Notes
BF2A/BF20	1.7		BF50A	17.6	UP to 3213356
BF5A/BF50	3.4		BF50A	13.9	FROM 3213357
BF8A/BF80	7.8		BF50D	13.9	
BF75/BF100	7.8		BF(P)60A	16	
BF(P)8D	9.6		BF75AT-AW	22.3	
BF9.9A	8.1		BF75AX	33.8	
BF(P)9.9D	9.6		BF75D	32.1	
BF15A	8.1		BF90AT-AW	22.3	
BF(P)15D	9.6		BF90AX	33.8	
BF(P)20D	9.6		BF90D	32.1	
BF25A	9.8		BF115A	33.8	
BF25D	9.1		BF115D	33.1	
BF30A	9.8		BF130A	33.8	
BF30D	9.1		BF135A	33.1	
BF35A	17.6		BF150A	33.1	
BF40A	17.6	UP to 3212165	BF200A	39.6	
BF40A	13.9	FROM 3212166	BF225A	39.6	
BF40D	13.9		BF250A	49.6	
BF45A	17.6				

GEAR LUBE CAPACITY CHART - JOHNSON/EVINRUDE/OMC ENGINES

Evinrude-Johnson Outboards			Evinrude-Johnson Outboards		
Model	Year	Capacity (Oz.)	Model	Year	Capacity (Oz.)
1.5	1968-70	1	14	1951-52	10
2	1971-85	2	14	1988-90	8
Colt®/Junior®	1986-91	2	15	1953-55	10
2.0,2.3,3.3	1991-Thru	3	15	1956	9
2.5	1987-88	3	15	1974-Thru	9
3	1952-72	3	18	1957-73	9
3	1990-Thru	3	20	1966-73	9
4 (8110)	1969-82	4	20	1985-Thru	11
4 (90)	1973-Thru	3	25	1951-1955	14
Ultra 4, Excel 4	1987-91	3	25	1969-84	9
4 Deluxe	1986-Thru	11	25 Comm.	1985-Thru	9
4 4-Stroke	2003	7	25 Comm. Thru Hub	1991-Thru	11
4.5	1980-83	11	25	1985-Thru	11
5	1965-68	3	25, 30 4-Stroke	2000-01	8
5	1998	6.4	28	1962-64	14
5.5	1954-64	9	28	1986-Thru	9
6	1965-79	9	30	1956	14
6	1984-Thru	11	30	1984-Thru	11
6 4-Stroke	1997-Thru	11	33	1965-70	14
7.5	1951-53	4	35	1957-59	14
7.5	1954-58	9	35	1976-82	10
7.5	1980-83	11	35	1983-84	11
8	1984-Thru	11	35 45 Cu. In./737 CC	1987	22
8 4-Stroke	1995-Thru	9	40	1960-76	14
9.5	1964-73	10	40 Elec. Shift	1962-70	15
9.9 2-Stroke	1974-Thru	9	40 Comm.	1981-90	14
9.9, 15 4-Stroke	1995-01	9	40 Comm. (RS)	1991-Thru	16
9.9, 15 4-Stroke	2002-Thru	6	40 Comm. (RP,RW)	1993	22
10	1956-57	9	40	1984-88	22
10	1958-63	10	40	1989-Thru	16

*Sierra Premium Gear Lube (18-9600 series) recommended for under 75 HP • Sierra Hi-Performance Gear Lube (18-9650 series) recommended for 75 HP and above

GEAR LUBE CAPACITY CHARTS

GEAR LUBE CAPACITY CHART - JOHNSON/EVINRUDE/OMC ENGINES (CONT.)					
Evinrude-Johnson Outboards			Evinrude-Johnson Outboards		
Model	Year	Capacity (Oz.)	Model	Year	Capacity (Oz.)
45 Comm.	1986-Thru	22	110	1986-89	26
48	1987-88	22	112	1994-Thru	26
48	1989-Thru	16	115 Elec. Shift	1969-70	27
40, 50 4-Stroke	1999-Thru	21	115	1973-76	28
50	1958-59	35	115 20"	1977	29
50 1971-72 Electric	1971-74	26	115 25"	1977	35
50	1975-88	22	115	1978	38
50	1989-Thru	16	115	1979-85	27
50 Comm.	1977-79	26	115	1990-Thru	26
50 3 cyl. 56 Cu.In.	1995-Thru	22	115 4-Stroke	2003-Thru	36
55 Electric Shift 3 Cyl	1968-69	26	115 60V4 EL, GL, SL	1995-Thru	31
55	1976-79	22	115 60V4 EX, SX V6 G/C	1995-Thru	34
55 Comm.	1980-Thru	22	120 V6 G/C	1985	34
60 Std.	1964-67	20	120	1986-1993	26
60 Heavy-Duty	1964-67	35	120 20"	1994	26
60 Electric Shift	1970-71	26	120 25" V6 G/C	1994	34
60	1980-85	22	125 Elec. Shift	1971-1972	27
60	1986-Thru	22	130 V6 G/C	1995-Thru	34
60 4-Stroke	2002-Thru	19	135	1973-74	28
65 Standard	1968	20	135	1975-76	29
65 Heavy-Duty	1968	35	140	1977	35
65 1972 Electric	1972-73	26	140	1978	38
65 Comm.	1984-Thru	22	140	1979-84	27
70	1974-Thru	22	140 4-Stroke	2003-Thru	36
70 4-Stroke	1998-Thru	19	140 V6 G/C	1985	34
75	1960	22	140 V4 Loop	1986-87	26
75 Man. Shift	1961-65	20	140 20" V4 Loop	1988-94	26
75 Elec. Shift	1962-65	18	140 25" V6 G/C	1988-94	34
75 15" Small G/C	1975-88	22	150	1978	43
75 20"	1975-84	25	150	1979-82	29
80 Man. Shift	1966-67	20	150 V6 Cross	1983-91	34
80 Heavy-Duty	1966-67	35	150 60V6	1991-Thru	34
80 Elec. Shift	1966-67	18	150 DI	1997-Thru	34
85 Man. Shift - Std.	1968	20	150 Comm.	1993-Thru	34
85 Elec. Shift	1968	18	155 Comm.	1984-90	77
85 Elec. Shift	1969-71	27	155 Comm.	1991-92	34
85 1972 Elec. Shift	1972-76	28	175	1977	44
85 20"	1977	29	175	1978	43
85 25"	1977	35	175	1979-82	29
85	1978	38	175	1983	34
85	1979-80	27	175 V6 Cross	1986-91	34
85	1991-Thru	26	175 60V6	1991-Thru	34
88	1987-Thru	26	175 DI	1998-Thru	34
90 Elec. Shift	1964-65	18	185	1984-85	34
90 Cross V4	1981-Thru	26	200	1976-77	44
90 60V4 EL, SL	1995-Thru	31	200	1978	43
90 60V4 EX, SX V6 G/C	1995-Thru	34	200	1979-82	29
90 4-Stroke	2003-Thru	36	200	1983	34
100* Elec. Shift	1966	28	200 V6 Loop	1986-Thru	34
100 Elec. Shift	1967-68	38	200/225 4-Stroke	2004	37
100 Elec. Shift	1971-72	27	225 V6 Loop	1986-Thru	34 V6 Coro 31
100	1979-80	27	235	1978	43
100	1988-Thru	26	235	1979-82	28
100 Comm. V6 G/C	1984-Thru	34	235	1983-85	34

GEAR LUBE CAPACITY CHARTS

GEAR LUBE CAPACITY CHART - JOHNSON/EVINRUDE/OMC ENGINES (cont.)

Evinrude-Johnson Outboards			Evinrude-Johnson Outboards		
Model	Year	Capacity (Oz.)	Model	Year	Capacity (Oz.)
2.6L	1984-85	34	V4/V6 w/ Type O	2002-Thru	34
250 V8 Loop	1991-Thru	77	V4/V6 w/ Type O - Counter Rot.	2002-Thru	31
275 V8 Loop	1985-87	77 V8 Coro 72	V6 Type L Gearcase	2002-Thru	34
300 V8 Loop	1985-Thru	77	V6 Type L2 - CLE	2009-Thru	32.5
3.6L V8 Loop	1985-87	77	V6 Type M	2002-Thru	44
4.0 V8 Loop	1988-92	77	V6 Type M - Counter Rot.	2002-Thru	41
Turbo Jet	1994-Thru	84.6	V6 Type M2	2009-Thru	38.9
Magnum	2002-Thru	44	V6 Type M2 - Counter Rot.	2009-Thru	35.8
Magnum CX	2002-Thru	41	* Gearcase with Fill Plug Above Cavitation Plate 32 Oz.		

GEAR LUBE CAPACITY CHART - JOHNSON/EVINRUDE/OMC ENGINES

OMC Cobra®		OMC Cobra®	
Model	Capacity (Oz.)	Model	Capacity (Oz.)
2.3L, 128 Model	60	262 OMC King Cobra	64
2.5L	60	350 OMC King Cobra	64
3.0L, (1990-93)	64	460 OMC King Cobra	108
3.0L 130 Model	60	460 OMC King Cobra (Cone Clutch)	103
4.3L 175 Model	64	1990-94 King Cobra (Cone Clutch)	103
5.0L	64	1994-Thru Cobra (Cone Clutch)	71
5.7L, 260 Model	64	1996-Thru Dual Prop	81
7.5L	108	OMC Sail Drive	—
1990-93 3.0L, 3.0L HO	64	1977-86	20
185, 200, 235 Models	64		

GEAR LUBE CAPACITY CHART - MERCURY ENGINES

Brand	Model	Cycle	Model Note	Oz.	mL.
Mercury/Mariner	2.2, 2.5, 3.3	2 Cycle		4.5	135
Mercury/Mariner	4.5	2 Cycle		6.8	200
Mercury/Mariner	6, 8, 9.9, 15	2 Cycle		6.8	200
Mercury/Mariner	20, 25	2 Cycle		8.8	260
Mercury/Mariner	30, 40	2 Cycle	2 cylinder	14.9	440
Mercury/Mariner	40, 50	2 Cycle	3 cylinder, std. Gearcase	14.9	440
Mercury/Mariner	55, 60	2 Cycle	Standard Gearcase	11.5	340
Mercury/Mariner	60	2 Cycle	Big Foot	22.5	665
Mercury/Mariner	75, 90	2 Cycle	3 cylinder	22.5	665
Mercury/Mariner	100, 115, 125	2 Cycle	4 cylinder	22.5	665
Mercury/Mariner	115	2 Cycle	3 cylinder Optimax	22.5	665
Mercury/Mariner	135, 150	2 Cycle	2.0L	22.5	665
Mercury/Mariner	150, 175, 200	2 Cycle	2.5L Carb/EFI/Optimax	22.5	665
Mercury/Mariner	200, 225, 250	2 Cycle	3.0L Carb/EFI/Optimax	27	798
Force	5	2 Cycle		4	120
Force	9.9, 15	2 Cycle		6.8	200
Force	25	2 Cycle		8.8	260
Force	40, 50	2 Cycle		14.9	440
Force	75	2 Cycle		12	355
Force	90, 120	2 Cycle		22.5	655
Mercury/Mariner	4.5	FourStroke		6.8	200
Mercury/Mariner	8, 9.9	FourStroke	MY 2004 & prior Standard Gearcase	6.8	200
Mercury/Mariner	8, 9.9	FourStroke	MY 2005 & newer	10.8	320
Mercury/Mariner	9.9	FourStroke	MY 2004 & prior Big Foot	8.8	260
Mercury/Mariner	9.9	FourStroke	MY 2005 & newer Big Foot	12.5	370

GEAR LUBE CAPACITY CHARTS

GEAR LUBE CAPACITY CHART - MERCURY ENGINES (cont.)

Brand	Model	Cycle	Model Note	Oz.	mL.
Mercury/Mariner	15	FourStroke	Standard Gearcase	6.8	200
Mercury/Mariner	15	FourStroke	Big Foot	8.8	260
Mercury/Mariner	25	FourStroke	Big Foot	14.9	440
Mercury/Mariner	30, 40	FourStroke	3 cylinder, standard Gearcase	14.9	440
Mercury/Mariner	30, 40	FourStroke	3 cylinder, Big Foot	22.5	665
Mercury/Mariner	40, 45, 50	FourStroke	4 cylinder, 935 cc, standard Gearcase	14.9	440
Mercury/Mariner	40, 45, 50	FourStroke	4 cylinder, 935 cc, Big Foot	22.5	655
Mercury/Mariner	40	FourStroke	4 cylinder, 996 cc, Big Foot	24	710
Mercury/Mariner	50, 60	FourStroke	4 cylinder, 996 cc, standard Gearcase	11.5	340
Mercury/Mariner	50, 60	FourStroke	4 cylinder, 996 cc, Big Foot	24	710
Mercury/Mariner	75, 90	FourStroke		22.5	665
Mercury/Mariner	115	FourStroke		24	710
Mercury/Mariner	200	FourStroke	Verado (RH Rotation)	32.8	970
Mercury/Mariner	225	FourStroke	Standard Gearcase	39	1.15L
Mercury/Mariner	225/250/275	FourStroke	Verado (RH Rotation)	32.8	970

GEAR LUBE CAPACITY CHART - MERCUISER STERNDRIIVE

Brand	Model	Cycle	Model Note	Oz.	mL.
MerCruiser	Vazer Drive	4 cycle	with Gear Lube Monitor	2.0 US Quarts	1.9L
MerCruiser	Alpha One Gen II	4 cycle	without Gear Lube Monitor	1.22 US Quarts	1.16L
MerCruiser	Alpha One Gen II	4 cycle	with Round Gear Lube Monitor	2.0 US Quarts	1.9L
MerCruiser	Alpha One Gen II	4 cycle	with Rectangular Gear Lube Monitor	1.75 US Quarts	1.66L
MerCruiser	Bravo One	4 cycle	without Gear Lube Monitor	2.0 US Quarts	1.9L
MerCruiser	Bravo One	4 cycle	with Round Gear Lube Monitor	3.25 US Quarts	3.07L
MerCruiser	Bravo One	4 cycle	with Rectangular Gear Lube Monitor	2.75 US Quarts	2.6L
MerCruiser	Bravo Two	4 cycle	without Gear Lube Monitor	2.5 US Quarts	2.4L
MerCruiser	Bravo Two	4 cycle	with Round Gear Lube Monitor	3.75 US Quarts	3.55L
MerCruiser	Bravo Two	4 cycle	with Rectangular Gear Lube Monitor	3.25 US Quarts	3.07L
MerCruiser	Bravo Three	4 cycle	without Gear Lube Monitor	2.0 US Quarts	1.9L
MerCruiser	Bravo Three	4 cycle	with Rectangular Gear Lube Monitor	3.0 US Quarts	2.84L
MerCruiser	Blackhawk	4 cycle	without Gear Lube Monitor	1.75 US Quarts	1.66L
MerCruiser	Blackhawk	4 cycle	with Rectangular Gear Lube Monitor	2.25 US Quarts	2.1L

GEAR LUBE CAPACITY CHART - NISSAN ENGINES

Model	Approximate Fluid Ounces Required	Model	Approximate Fluid Ounces Required
2A & 3.5A (4-Stroke)	6.1	25 (4-Stroke)	9.5
2.5A & 3.5A (2-Stroke)	3	30 (2-Stroke)	14.5
3.5B (2-Stroke)	6	30 (4-Stroke)	9.5
4 (4-Stroke)	6.6	40C (2 cyl)	15.9
5 (2-str/4-str)	6.6	40D (3 cyl)	16.9
6 (4-Stroke)	6.6	NSD40 (TLDI) / NSF40	16.9
8 (2-str/4-str)	10.8	50D (3 cyl)	16.9
9.8 (2-str/4-str)	10.8	NSD50 (TLDI) / NSF50	16.9
9.9 (2-Stroke)	12.5	70B (3 cyl)	23.7
9.9A (4-Stroke)	6.8	70C (3 cyl)	30.4
9.9B (4-Stroke)	12.5	NSD70 / 75 (TLDI)	30.4
15 (2-Stroke)	12.5	90A (2-Stroke)	30.4
15A (4-Stroke)	6.8	NSD90 (TLDI)	30.4
15B (4-Stroke)	12.5	115A (2-Stroke)	30.4
18 (2-str/4-str)	12.5	NSD115 (TLDI)	30.4
20 (4-Stroke)	12.5	140A (2-Stroke)	30.4
25 (2-Stroke)	14.5		

*Sierra Premium Gear Lube (18-9600 series) recommended for under 75 HP • Sierra Hi-Performance Gear Lube (18-9650 series) recommended for 75 HP and above

GEAR LUBE CAPACITY CHARTS

GEAR LUBE CAPACITY CHART - SUZUKI ENGINES

Model	Gear Case Oil Capacity (CC)	Gear Case Oil Capacity (Oz.)	Model	Gear Case Oil Capacity (CC)	Gear Case Oil Capacity (Oz.)
DT2 (Short Shaft)	70	2.4	DT40	610	20.6
DT2 (Long Shaft)	120	4	DF40/50	610	20.6
DT3.5	85	2.9	DT50/55/60/65	650	22
DT4	190	6.4	DF60/70	600	20.3
DF4/6	190	6.4	DT75/85	700	23.7
DT5/6/8	240	11.5	DT90/100	560	18.9
DT8C/9.9C/9.9CN	175	5.9	DT115/140	1100	37.2
DF9.9/15	175	5.9	DF90/115/140	1050	35.5
DT9.9/15/15C	170	5.7	DT150/175/200/225	1050	35.5
DT20/25/30/30C/35C	230	7.8	DF150/175/200/225/250/300	1100	37.2
DF25/30	230	7.8			

GEAR LUBE CAPACITY CHART - YAMAHA ENGINES

Model	CC	Oz.	Model	CC	Oz.
2	45	1.5	C50	430	14.5
F2.5	75	2.5	F50	430	14.5
3	75	2.5	T50 (1996-00)	430	14.5
4	105	3.6	T50 (2001-02)	610	20.6
F4	100	3.5	C55	500	16.9
5	105	3.6	60	610	20.6
6	160	5.4	E60	610	20.6
8	160	5.4	F60	430	14.5
F8	150	5.1	P60	610	20.6
T8	320	10.9	T60	670	23
9.9	185	6	70	610	20.6
F9.9	185	6	C70	610	20.6
T9.9	320	10.8	C75	610	20.6
15 (1984-97)	185	6.03	E75	610	20.6
15 (1998-02)	250	8.5	F75	670	23
F15	250	8.5	P75	610	20.6
20	370	12.7	C80	610	20.6
25 (1984-87)	180	6.1	F80	670	23
25 (1988-02)	370	12.7	C85	610	20.6
25 3cyl.	200	6.8	90/B90/C90	610	20.6
C25	180	6.1	F90	670	23
F25	320	10.8	F100	670	23
T25	430	14.5	115	760	25.7
30	200	6.8	B115/C115	760	25.7
30 (1984-86) 3cyl.	180	6.1	F115	760	25.7
30 (1987-02) 3cyl.	200	6.8	LF115	715	24.2
C30 (1989-92)	180	6.1	P115/S115	760	25.7
C30 (1993-97)	320	10.8	130	760	25.7
F30	430	14.5	L130	715	24.2
40 (1984-94)	415	14	S130	760	25.7
40 (1995-02)	430	14.5	150	980	33.1
C40 (1989-97)	315	10.6	C150	980	33.1
C40 (1997-02) 3cyl.	430	14.5	D150 (1997-99)	900	30.4
F40	430	14.5	DX150 (1999)	980	33.1
E48	500	16.9	L150	870	29.4
50/P50 (1984-94)	415	14	SX150 (1999-02)	980	33.1
50/P50 (1995-02)	430	14.5	V150 (1998-99)	980	33.1

*Sierra Premium Gear Lube (18-9600 series) recommended for under 75 HP • Sierra Hi-Performance Gear Lube (18-9650 series) recommended for 75 HP and above

GEAR LUBE CAPACITY CHARTS

GEAR LUBE CAPACITY CHART - YAMAHA ENGINES (cont.)					
Model	CC	Oz.	Model	CC	Oz.
VX150	980	34.5	Model	CC	OZ
VZ150	980	33.1	LX225	1000	33.8
Z150	980	33.1	S225 3.1L	1150	38.9
175 (1984-99)	980	33.1	SX225	1000	33.8
P175	980	33.1	V225 3.1L	1150	38.9
S175	980	33.1	VX225	1150	38.9
V175	980	33.1	VZ225 3.3L	1000	33.8
VZ175	980	33.1	250	1150	38.9
Z175	980	33.1	L250	1000	33.8
200 (1984-99)	980	33.1	Model	CC	OZ
F200	1150	38.9	LX250	1000	33.8
L200 (1986-95)	900	30.4	S250	1150	38.9
L200 (1996-99)	870	30.4	LZ250 3.3L	1150	38.9
LF200	1000	33.8	SX250	1150	38.9
LX200 (1999-02)	980	33.1	VX250	1150	38.9
LZ200	870	29.4	VZ250 3.3L	1000	33.8
P200	980	33.1	Z250 3.3L	1000	33.8
LF225	1000	33.8			

*Sierra Premium Gear Lube (18-9600 series) recommended for under 75 HP • Sierra Hi-Performance Gear Lube (18-9650 series) recommended for 75 HP and above



Sierra Customer Satisfaction Warranty (Professional Installer)

Limited Warranty (to include Sierra, Shields and Instrumentation Product Groups):

SIERRA INTERNATIONAL INC. ("SIERRA") warrants its products to be free of defects in workmanship and materials for the useful life of the product (the "Warranty"). If a SIERRA product fails to comply with the Warranty, SIERRA will repair or replace the defective product free of charge. The Warranty is subject to the additional terms, conditions and limitations set forth below.

Warranty Claims for Professionally Installed Products:

For any SIERRA product that was originally installed on a vessel by a dealer or other professional installer that fails to comply with the Warranty, in addition to repairing or replacing the product free of charge, SIERRA will also reimburse the customer for reasonable labor charges incurred to replace the product, and reasonable towing and other similar incidental expenses incurred as a result of the failure of the product to comply with the Warranty. Labor will be calculated based on the installer's posted shop rate that is competitive with their local market rates. The original work order along with the original invoice and a copy of the new re-work order must be provided to SIERRA to file a claim for reimbursement of labor expenses. Towing charges will also be paid based on reasonable and customary rates in the local trading area. A copy of the original invoice for the towing service must be provided to SIERRA to file a claim for reimbursement of towing expenses.

ALL PROFESSIONAL INSTALLER WARRANTY CLAIMS MUST BE SUBMITTED IN ACCORDANCE WITH THE FOLLOWING PROCEDURE:

Dealers may file all warranty claims on our SONAR Pro website at sonar.seastarsolutions.com
A free user account is required. Dealers may also continue to use the options below.

WITHOUT LABOR CLAIM - The dealer may return any allegedly defective SIERRA product to the distributor from whom it was purchased for analysis. The product shall be tagged with the SIERRA part number, date of purchase and the alleged cause of failure. The distributor will then forward the product to SIERRA with a request for credit. If SIERRA determines that the part failed to comply with the Warranty and otherwise qualifies for Warranty coverage under the terms hereof, SIERRA will issue credit for the product to the distributor. The distributor will reimburse the dealer. SIERRA will not issue credit for any products that are not returned to SIERRA. Products not manufactured or distributed by SIERRA will be held for disposition for 30 days.

WITH LABOR CLAIM – All warranty claims for which reimbursement of labor and/or towing expenses is sought are subject to prior authorization. In addition to SONAR Pro, dealers may call 217-324-9428 to discuss any such claim with a SIERRA representative. In order to process all claims quickly and efficiently, the following must be shipped directly to SIERRA via a traceable and insurable method (i.e. UPS, Federal Express, Registered U.S. Mail, etc.):

1. The allegedly defective product and any related damaged parts.
2. A written estimate detailing the following information:
 - a. A complete list, including part numbers, of all products required for the warranty repair.
 - b. The shop labor rate and a breakdown of the time required for the repair.
 - c. The year, model and serial number of the warranted engine or drive.
 - d. The name and address of the distributor the products were purchased from.
 - e. The name, address and phone number of the end consumer.
3. The original work order or receipt detailing the initial installation of the allegedly defective product.
4. Any receipts detailing additional expenses.

Failure to provide required documentation and information may void all or part of the Warranty coverage.

Proof of delivery will be required on all lost shipments.

NOTE: Concerning labor claims on older products that cannot be rectified due to the unavailability of OEM replacement parts; SIERRA reserves the right to extend only the market value of the OEM product.

Send claims to:
TECHNICAL SERVICE
SIERRA INTERNATIONAL INC.
1 Sierra Place
Litchfield, IL 62056-3029
(877) 663-8396

Limitations:

THE EXPRESS WARRANTY SET FORTH ABOVE IS IN LIEU OF ALL OTHER WARRANTIES, EXPRESS OR IMPLIED, INCLUDING BUT NOT LIMITED TO THE IMPLIED WARRANTIES OF MERCHANTABILITY AND FITNESS FOR A PARTICULAR PURPOSE. SIERRA does not warrant against, and the Warranty shall be void with respect to, damages or defects arising out of any of the following:

- improper or abnormal use or handling of SIERRA's products;
- installation or use of a SIERRA product in a manner that is inconsistent with SIERRA's application information, guidelines, instructions and/or specifications;
- defects in products or components not manufactured by SIERRA;
- non-SIERRA made products or components;
- SIERRA products transferred from a vessel on which they were originally installed;
- SIERRA products transferred from the engine on which they were originally installed;
- failure to maintain SIERRA products in accordance with SIERRA's application information, guidelines, instructions and/or specifications;
- ordinary wear and tear resulting from the operation and/or use of the SIERRA product.

This warranty also does not apply to products which have been altered or upon which repairs have been affected or attempted by persons other than pursuant to written authorization by SIERRA.

THIS STATEMENT OF LIMITED WARRANTY IS NOT A STATEMENT OF THE USEFUL LIFE OF ANY SIERRA PRODUCT. WHEN SIERRA WARRANTS ITS PRODUCTS FOR THE USEFUL LIFE OF THE PRODUCT, THIS DOES NOT GUARANTEE THAT THE PRODUCT WILL LAST FOREVER OR FOR THE LIFE OF THE VESSEL. THE LENGTH OF THE USEFUL LIFE OF SIERRA'S PRODUCTS WILL VARY DEPENDING ON THE TYPE OF PRODUCT, AS SPECIFIED IN SIERRA'S APPLICATION INFORMATION, GUIDELINES, INSTRUCTIONS AND SPECIFICATIONS FOR EACH PARTICULAR PRODUCT. PLEASE REFER TO THE INFORMATION PROVIDED WITH YOUR SIERRA PRODUCT IN ORDER TO DETERMINE THE USEFUL LIFE OF THAT PRODUCT.

The sole and exclusive obligation of SIERRA shall be to repair or replace the defective products in the manner set forth above. SIERRA shall not have any other obligation with respect to the products or any part thereof, whether based on contract, tort, strict liability or otherwise. Under no circumstances, whether based on this Warranty or otherwise, shall SIERRA be liable for any special, punitive or consequential damages.

SIERRA's employees or representatives' ORAL OR OTHER WRITTEN STATEMENTS DO NOT CONSTITUTE WARRANTIES, shall not be relied upon by customer, and are not a part of the warranty stated herein.

If any part of this Limited Warranty is determined to be void or illegal, the remainder shall remain in full force and effect.

W
A
R
R
A
N
T
Y

WE'VE GOT YOU COVERED!



THE MOST EXTENSIVE WARRANTY IN THE MARINE BUSINESS.

© Copyright July 2018 Sierra International
Sierra International, 1 Sierra Place, Litchfield, IL 62056-3029
Phone: 877-663-8396 | Fax: 217-441-8340
www.sierramarine.com

Printed in the USA 



Part No. CATALOG-8033

